



®

GENERATION FUTURE

HOOVER



USER MANUAL



IMPORTANT SAFETY REMINDERS

This appliance should only be used for domestic cleaning, as described in this user guide. Please ensure that this guide is fully understood before operating the appliance.

Do not leave the appliance plugged in. Always switch off and remove the plug from the socket after use, or before cleaning the appliance or any maintenance task.

This appliance can be used by children aged from 8 years and above and persons with reduced physical, sensory or mental capabilities or lack of experience and knowledge if they have been given supervision or instruction concerning use of the appliance in a safe way and understand the hazards involved. Children shall not play with the appliance. Cleaning and user maintenance shall not be made by children without supervision.

If the power cord is damaged stop using the appliance immediately. To avoid a safety hazard, an authorised Hoover service engineer must replace the power cord.

Keep hands, feet, loose clothing and hair away from rotating brushes.

Use only attachments, consumables or spares recommended or supplied by Hoover.

When using cleaning tools ensure that the appliance is kept in the upright (parked) position. This will avoid possible damage to the carpet or floor covering. When cleaning stairs, do not position the appliance above you.

Static electricity: some carpets can cause a small build up of static electricity. Any static discharge is not hazardous to health.

Do not use your appliance out of doors or on any wet surface or for wet pick up.

Do not pick up hard or sharp objects, matches, hot ashes,

cigarette ends or other similar items.

Do not spray with or pick up flammable liquids, cleaning fluids, aerosols or their vapours.

Do not run over the power cord when using your appliance or remove the plug by pulling on the power cord.

Do not continue to use your appliance if it appears faulty.

Hoover service: To ensure the continued safe and efficient operation of this appliance we recommend that any servicing or repairs are only carried out by an authorised Hoover service engineer.

Do not stand on or wrap the cord around arms or legs when using your appliance.

Do not use the appliance to clean animals or people.

When using the cleaning tools, ensure to always steady the appliance with your other hand. This will ensure that the appliance does not fall while in use.

WARNING: A thermal cut out switches off the appliance to prevent overheating if it is used when full or there is a blockage or dirty filters. If this should happen then switch off, unplug and correct the fault. It will take approximately 45 minutes for the cut out to automatically reset.

The Environment

The symbol on this appliance indicates that this appliance may not be treated as household waste. Instead it must be handed over to the applicable collection point for the recycling of electrical and electronic equipment. Disposal must be carried out in accordance with local environmental regulations for waste disposal. For more detailed information about treatment, recovery and recycling of this appliance, please contact your local city office, your household and waste disposal service or the shop where you purchased the appliance.



CE This appliance complies with the European Directives 2014/35/EU, 2014/30/EU and 2011/65/EU.

HOOVER Limited, Pentrebach, Merthyr Tydfil, Mid Glamorgan, CF48 4TU, UK



GETTING TO KNOW YOUR CLEANER

Effortless cleaning with your new Hoover

This vacuum cleaner is supplied with an Energy Label as required by European Regulation (EU) 665/2013.

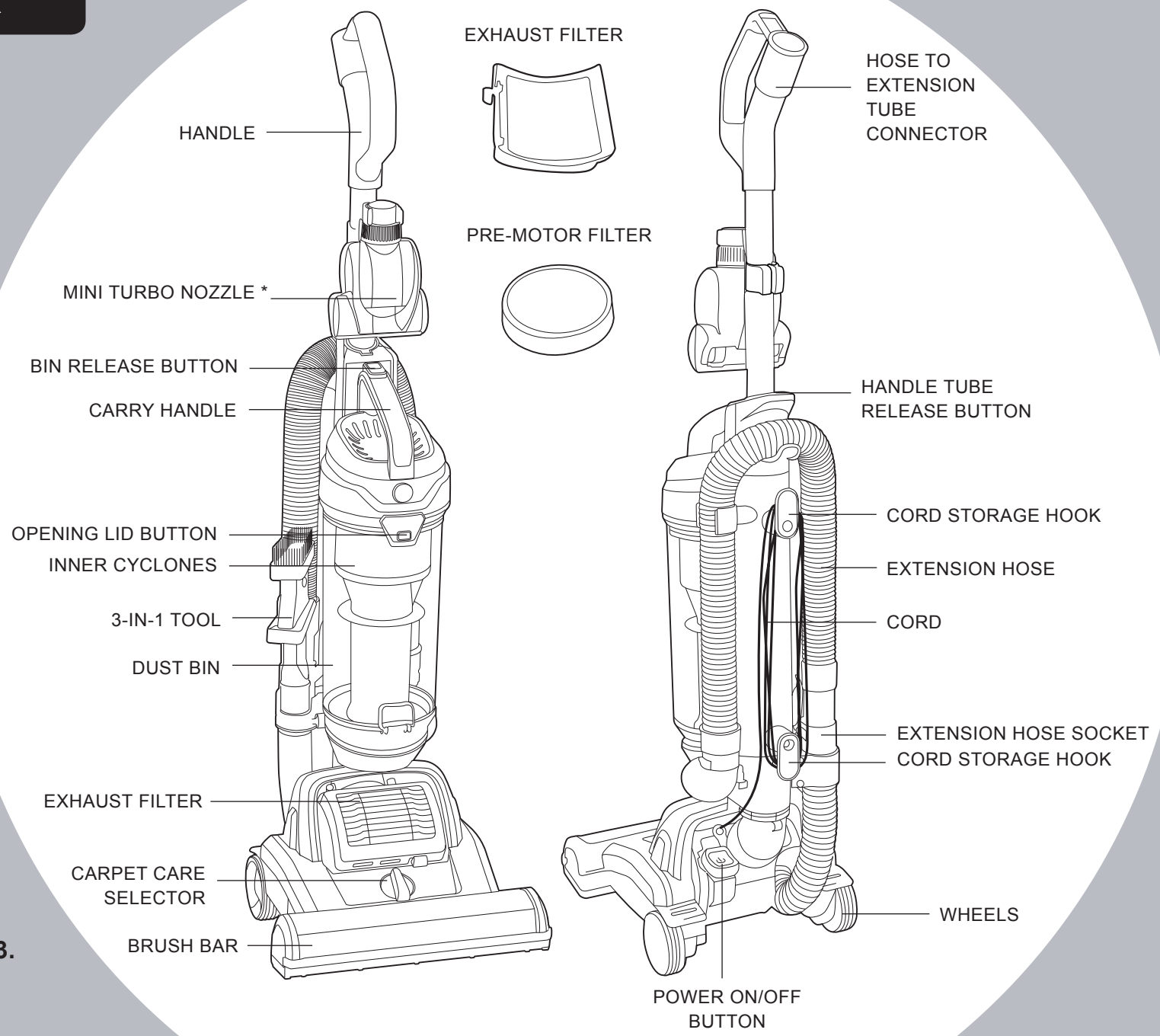

* Certain models only



PREPARING YOUR CLEANER

Insert the main handle in the cleaner body.

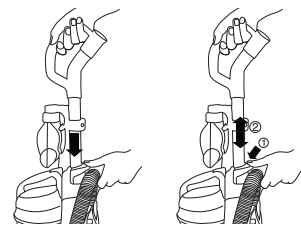

SUPPLY CORD

Do not run over the supply cord.

Clip the supply cord in the cord clip at the back of the handle to avoid accidentally running the cleaner over the cord and causing any damage.



MINI TURBO BRUSH ASSEMBLY*

Put the mini turbo nozzle onto the holder.

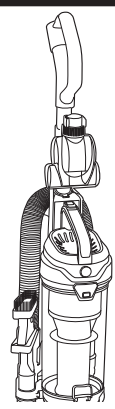

Put 3-in-1 tool onto storage area.

POWER SWITCH

Plug in your machine and turn it on.



CARPET CARE CONTROL SELECTOR

The carpet care control selector raises and lowers the height of the nozzle.

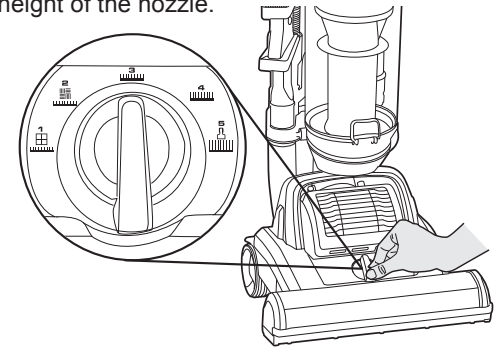

Ensure that the cleaner is in the upright (parked) position and move the selector to the required setting for the carpet type or floor covering.

To obtain the best performance and energy efficiency^{#1} it is recommended that the adjustment setting position 1 is used for the main cleaning operations. The other adjustment settings are for ease of use, use on longer pile carpets, or for specialist cleaning tasks.

Settings

- 1. Best performance and energy efficiency, short to medium pile carpets, hard wooden floors, wooden floor boards with crevices, ceramic tiles.
- 2. Medium pile carpets, delicate floor coverings such as vinyl or linoleum, parquet flooring.
- 3 or 4. For longer pile carpets the motion resistance may increase. Use these intermediate settings to reduce the force required to push the vacuum cleaner.
- 5. Luxury carpet and Tool mode

IMPORTANT: Using this cleaner for loop pile carpets with pile greater than 30mm is not recommended. Please consult the floorcare/carpet manufacturer's recommended cleaning instruction before vacuuming.

IMPORTANT: When cleaning delicate hard floors such as vinyl or linoleum the selector switch must be moved to position 2. Failure to do so may cause damage to the floor surface.

CLEANER RELEASE

Press your foot lightly on the floorhead and pull the cleaner backwards to recline.

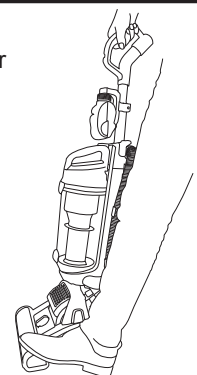

Twist the handle to manoeuvre under or around furniture.

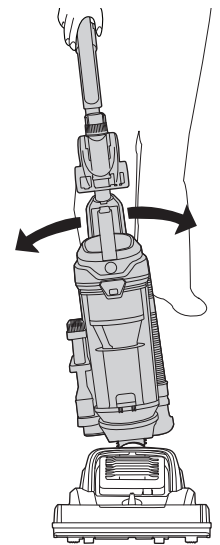

* Certain models only



CLEANING TOOLS

Handle

All accessories can fit onto the end of the hose, and handle tube. Combine accessories depending on use.

Mini Turbo Nozzle*

The Mini turbo nozzle* is ideal for removing pet hairs. DO NOT touch the rotating brush.

3-in-1 tool

- a- dusting brush
- b- crevice tool

press the button to release the brush and reveal the crevice tool

- c- upholstery nozzle

turn brush upside down and attach to the crevice tool to use the upholstery nozzle

Connecting Accessory to Hose

- 1 Pull out the hose connector from the extension hose socket.

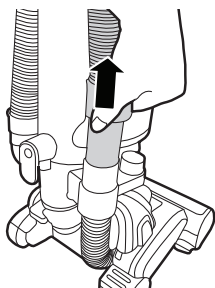

- 2 Choose your accessory.

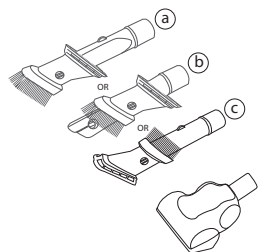

- 3 Connecting accessory to hose.

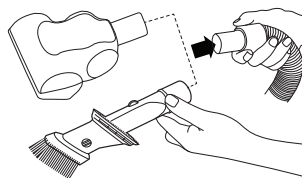

- 1 Remove handle tube.

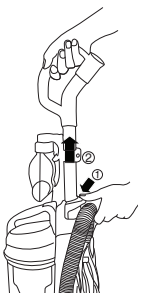

- 2 Insert hose connector to the handle tube, then rotate hose connector to lock.

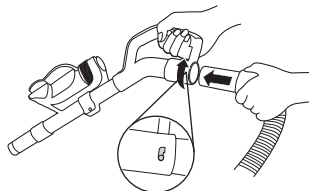

- 3 Connect accessory to the handle tube.

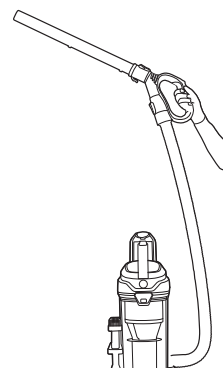
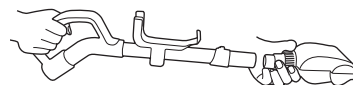

! IMPORTANT! When using the cleaning tools please remember the vacuum cleaner has a constantly rotating agitator brushbar. So please ensure that the cleaner is in the upright position with the height control set to the maximum and you hold the unit when using the cleaning accessories.

CLEANING THE STAIRS

It is dangerous to place the cleaner above you when cleaning stairs.

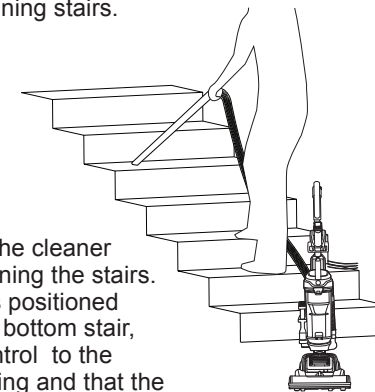

ALWAYS work with the cleaner below you when cleaning the stairs. Ensure the cleaner is positioned tightly up against the bottom stair, setting the height control to the maximum height setting and that the cleaning is being carried out safe manner with no risk to others .

STORING THE CLEANER

Turn the cleaner off and remove the plug. Wind the power cord around the cord storage hooks.

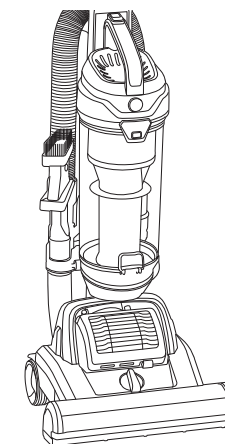

* Certain models only



EMPTYING THE BIN

! IMPORTANT: Before emptying the bin, make sure vacuum cleaner has been switched off.

1 To remove the bin from the cleaner press the bin release button.

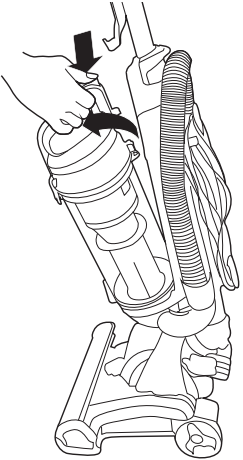

2 Hold the container over the Bin and press the easy open button.

The bin door will open and you can empty into a bin with no dust contact.

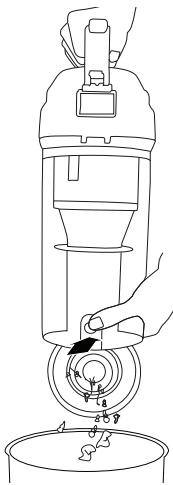

3 Once emptied, gently tap or shake the container to release any excess dust.

Do not overfill the bin above the max level line.

CLEANING THE PRE MOTOR FILTERS

1 Rotate the upper part of the dust bin to open.

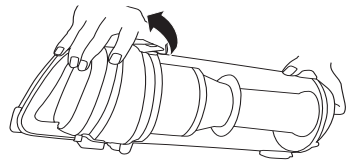

2 Take out the pre-motor filter.



3 Gently tap both filters to release any excess dust.

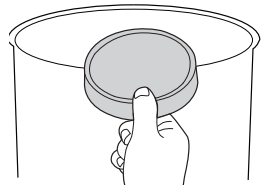

4 Wash the pre-motor filter under warm water until the water runs clean. Remove excess water by shaking and leave to dry for 24 hours. Reassemble and refit filters to cleaner, only when they are completely dry.

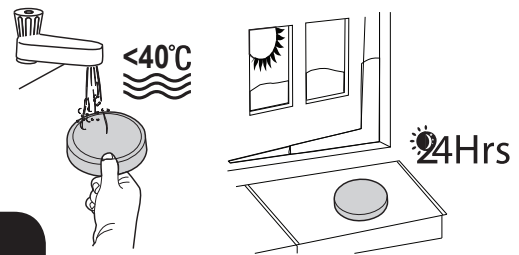

! IMPORTANT! Ensure the pre-motor filter and exhaust filters are reassembled to the cleaner before use.

CLEANING THE EXHAUST FILTER

The exhaust filter should be washed every month. Remove the exhaust filter from your cleaner by sliding the switch and wash with warm water.

Remove excess water by shaking and leave to dry for 24 hours. Refit filters only when completely dry.

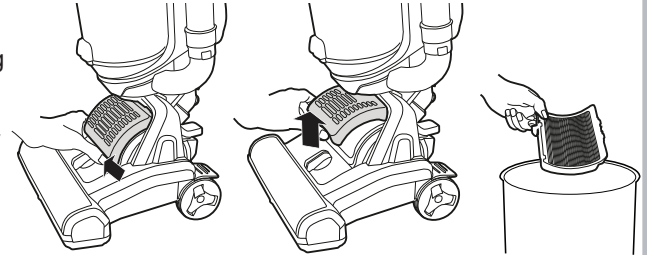



CLEANING THE SEPARATION SYSTEM

- 1 Lift latch to open the bin lid and access the access filter.

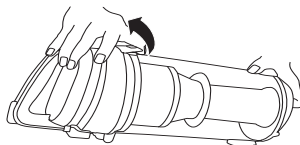

- 2 Take out the pre-motor filter.

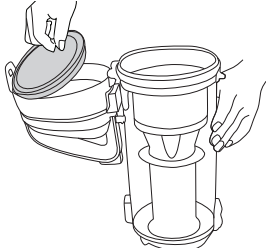

- 3 Pull the separation system out of the bin.

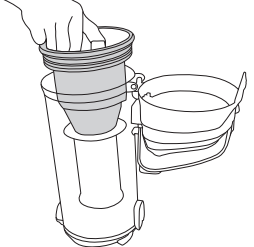

- 4 Clean the separation system with a dry cloth or dusting brush. Once clean reassemble and refit to the cleaner.

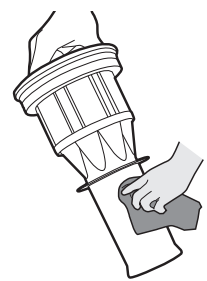

CHANGING THE BELT OR BRUSHES

If your cleaner is not picking up efficiently, the belt or brushes (or both) may need replacing, but first please make sure you have:

- Emptied the bin
- Cleaned the filters
- Checked for blockages

! IMPORTANT: Switch the cleaner off and remove the plug from the electricity supply before attempting any maintenance.

- 1 Turn the cleaner over and remove 7 retaining screws.

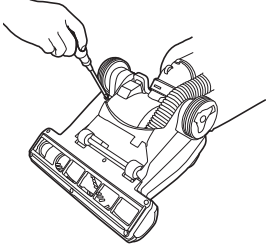

- 2 Remove the brush guard.

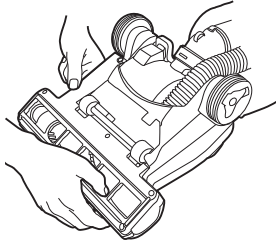

- 3 Remove brush assembly and check for wear on the belt. Loop the new belt around the motor and brush channel.

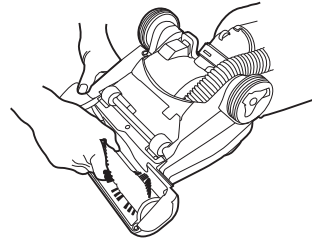

- 4 Hold the brush assembly and stretch the belt until the brush can be slotted back into the cleaner housing.

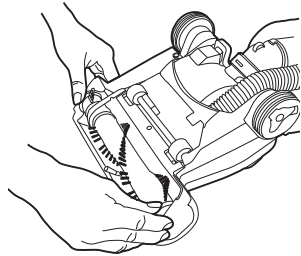

- 5 Rotate the brush to ensure free movement of the belt.

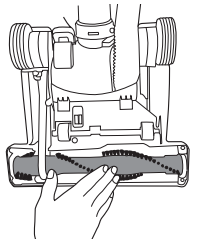

- 6 Refit the brush guard with 7 retaining screws

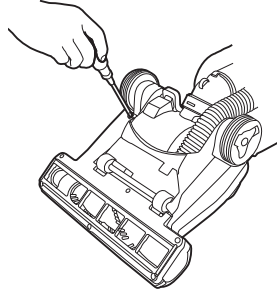

NOTE: If the brush is blocked and has stopped rotating, switch off and remove the plug from the electricity supply, then use a pair of scissors to cut through any threads or hairs caught around the brush. Reassemble the brush and brush guard.



CLEARING A BLOCKAGE

! **IMPORTANT:** Switch the cleaner off and remove the plug from the electricity supply before attempting any maintenance.

Check the cleaning tools and hose for blockages.

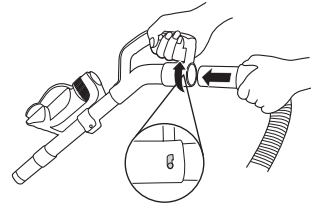

The hose can be removed at both ends.
Use a flexible rod to remove any obstruction.

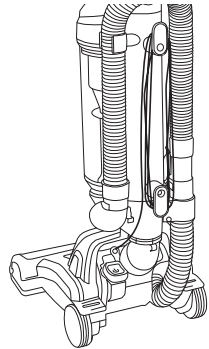

Turn the cleaner over and rotate the brushes to identify any obstructions including hair.

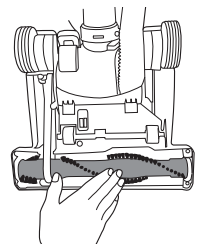

Remove a blockage from the mini turbo nozzle.
Open the nozzle by rotating the lock ring, lift cover and remove the blockage.

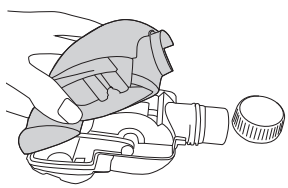

*Certain models only

User checklist

If your cleaner is not working properly run through the following checklist.

1. Is there a working electricity supply to the cleaner?
Check with another electrical product.
2. Is the bin full or choked with fine dust?
To empty the bin, see the User Manual on P6.
3. Is the hose blocked?
To clear a blockage, see the User Manual on P8.
4. Is there a blockage in the cleaner base?
To clear a blockage, see the User Manual on P8.
5. Are the filters blocked?
To clean filters, see the the User Manual on P6.
6. Are the brushes rotating correctly?
To check the brushes, see the User Manual on P8.
7. Has the cleaner overheated?
If so, it will take about 45 minutes to reset.

If there is any doubt call the Hoover Service Office for advice. They may be able to assist you over the telephone. A service charge will be made if the cleaner is examined and found to be in working order, has not been assembled in accordance with these instructions or has been used incorrectly.

WARNING!

A thermal cut out switches off the cleaner to prevent overheating if it is used when full or there is a blockage or dirty filters. If this should happen switch off, unplug and correct the fault.

It will take about 45 minutes for the cut out to automatically reset.

IMPORTANT: Do not run cleaner over the supply cord as this could damage the supply cord insulation.

IMPORTANT INFORMATION

Hoover Service

Should you require service at any time, please contact your local Hoover Service Office.

Hoover spares and Consumables

Always replace parts with genuine Hoover spares. These are available from your local Hoover dealer or direct from Hoover. When ordering parts always quote your model number.

USE ONLY HOOVER SPARES

CONSUMABLES & SPARE PARTS	CODE
FILTER KIT	U80 – 35601719
HOSE	D157 – 35601720
AGITATOR	Y37 – 35601721
BELT	V38 – 35601722
MINI TURBO NOZZLE	J60 – 35601723

Quality

Hoover's factories have been independently assessed for quality. Our products are made using a quality system which meets the requirements of ISO 9001

GUARANTEE STATEMENT

The guarantee conditions for this appliance are as defined by our representative in the country in which it is sold. Details regarding these conditions can be obtained from the dealer from whom the appliance was purchased. The bill of sale or receipt must be produced when making any claim under the terms of this guarantee.

Subject to change without notice.



GENERATION FUTURE

Hoover Limited
Pentrebach
Merthyr Tydfil
Mid Glamorgan
CF48 4TU

HOOVER CUSTOMER HELPLINE
03444 995 599

PRINTED IN P.R.C.
48019456