

The Samsung logo is located in the top right corner of the page. It consists of the word "SAMSUNG" in white, uppercase letters, centered within a dark blue, horizontally-oriented oval shape.

E-MANUAL

Thank you for purchasing this Samsung product.
To receive more complete service, please register
your product at

www.samsung.com/register

Model _____ Serial No. _____

Contents

Quick Guides

Using Smart Hub

- 1 Connecting to the Internet
- 1 Setting up Smart Hub
- 1 Using Smart Hub

Using the Samsung Smart Control

- 2 Operating the TV with the POINTER button
- 3 Setting up the Samsung Smart Control
- 3 Pairing the TV to the Samsung Smart Control

Improving the Viewing Experience of Sports Events

- 4 Activating Sports Mode

Editing Channels

- 5 Running the Edit Channel function
- 5 Rearranging or deleting channels

Connections

Connecting an Antenna (Aerial)

Connecting to the Internet

- 7 Establishing a wired Internet connection
- 8 Establishing a wireless Internet connection

Connecting to a Network via a Mobile Dongle

Troubleshooting Internet Connectivity Issues

- 11 Troubleshooting wired Internet connectivity issues
- 12 Troubleshooting wireless Internet connectivity issues

Connecting Video Devices

- 13 Connecting with an HDMI cable
- 14 Connecting with a component cable
- 14 Connecting with a composite (A/V) cable

Audio Input and Output Connections

- 15 Connecting with an HDMI (ARC) cable
- 16 Connecting with a digital audio (optical) cable
- 16 Connecting with headphones
- 16 Connecting with an audio cable

Connecting a Computer

- 17 Connecting through the HDMI port
- 18 Connecting with an HDMI-to-DVI cable
- 18 Connecting through your home network

Connecting a Mobile Device

- 19 Connecting with an MHL-to-HDMI Cable
- 20 Using Screen Mirroring
- 21 Connecting mobile devices without a wireless router (Wi-Fi Direct)
- 22 Connecting a mobile device via Samsung Smart View 2.0

Pairing a laptop to the TV - Wireless PC Mirroring (or KINO TV)

Changing the input signal with external devices

Connection Notes!

- 24 Connection notes for HDMI
- 25 Connection notes for audio devices
- 25 Connection notes for computers
- 25 Connection notes for mobile devices
- 26 Connection notes for Wireless PC Mirroring (or KINO TV)

Remote Control and Peripherals

About the Samsung Smart Control

Using the Samsung Smart Control

- 29 Operating the TV with the POINTER button
- 29 Operating the TV with the directional buttons and the Enter button
- 30 Displaying and using the On-Screen Remote
- 31 Pairing the TV to the Samsung Smart Control

Controlling External Devices with the TV Remote - Using the Universal Remote

- 32 Setting up the universal remote control

Using the Tools menu on the TV screen

Controlling the TV with a Keyboard

- 34 Connecting a keyboard
- 35 Using the keyboard

Controlling the TV with a Mouse

- 36 Connecting a USB mouse
- 36 Using a mouse

Connecting a Bluetooth Gamepad

Entering Text using the On-Screen QWERTY Keypad

- 37 Using additional functions

Smart Features

Smart Hub

- 39 Removing or pinning an item in the Recent group
- 39 Launching Smart Hub automatically
- 39 Testing Smart Hub connections
- 40 Using the Smart Hub tutorial
- 40 Resetting Smart Hub

Using Smart Hub with a Samsung Account

- 41 Creating a Samsung account
- 42 Signing in to a Samsung account
- 42 Linking your Samsung account to external service accounts
- 43 Changing and adding information to a Samsung account
- 43 Deleting a Samsung account from the TV

Using the GAMES Service

- 44 Managing Games with the pop-up Options menu
- 44 Viewing the Detailed Information screen
- 45 Installing and running a game
- 45 Managing downloaded or purchased games

Using the Apps Service

- 47 Managing Downloaded Apps with the pop-up Options menu
- 48 Installing an app
- 48 Enabling automatic apps updates
- 49 Removing an app from the TV
- 49 Locking and unlocking apps
- 49 Updating apps
- 49 Rearranging apps
- 49 Rating purchased apps
- 49 Using other app features and functions

Using the e-Manual

- 50 Launching the e-Manual
- 50 Using the buttons in the e-Manual

Using the web browser

- 51 Browsing preferences

Using the MY CONTENT Service

- 52 Read before playing media content
- 53 Playing multimedia content in a computer or mobile device
- 53 Playing media content saved on a USB device
- 54 Buttons and functions available while viewing photos
- 55 Buttons and functions available while viewing videos
- 57 Buttons and functions available while playing music
- 58 Listening to music in HD quality
- 58 Functions on the media content list screen

Using the NewsON Service

- 59 News
- 59 Weather

TV Viewing

Viewing Digital Broadcast Information at a Glance

- 60 Using the guide
- 61 Checking current programme info
- 61 Changing the broadcast signal
- 61 Checking digital channel signal info and strength

Recording Programmes

- 62 Recording programmes
- 63 Using the functions available while recording a programme
- 63 Using the buttons on the remote control while recording a programme
- 64 Managing the schedule recording list
- 64 Viewing recorded programmes
- 66 Managing recorded files

Setting Up a Schedule Viewing

- 67 Setting up a schedule viewing for a channel
- 68 Editing a schedule viewing
- 68 Cancelling a schedule viewing

Using Timeshift

- 69 Using the buttons on the remote control while using Timeshift

Using the Channel List

Registering, Removing, and Editing Channels

- 71 Registering and removing channels
- 71 Editing registered channels
- 72 Enabling / Disabling password protection on channels
- 72 Locking / Unlocking channels
- 72 Changing channel numbers

Creating a Personal Favourites List

- 73 Registering channels as favourites
- 73 Viewing and selecting channels on Favourites lists only

Editing a Favourites List

- 74 Using the Edit Favourites screen menu items

Making Sports programmes More Realistic with Sports Mode

- 76 Enabling sports mode
- 77 Extracting highlights automatically
- 77 Using the functions available while watching sports in sports mode
- 79 Viewing a game recorded in sports mode

Watching a Movie with Optimised Picture and Sound - African Cinema Mode

TV-Viewing Support Features

- 80 Reading digital text
- 80 Scanning for available channels
- 80 Selecting aerial connection type
- 81 Selecting the broadcast audio language
- 81 Audio Description
- 81 Genre Selection
- 81 Using adult genre

Using the Channel Settings

- 82 Setting the country (area)
- 82 Tuning broadcast signals manually
- 83 Fine-Tuning the screen
- 83 Transferring channel list
- 83 Deleting CAM operator profile
- 84 Setting satellite system
- 84 Changing teletext language
- 84 Showing common interface menu

Picture and Sound

Adjusting the Picture Quality

- 85 Choosing a picture mode
- 86 Adjusting the picture quality
- 87 Adjusting advanced settings
- 88 Adjusting picture options

Picture Support Functions

- 89 Viewing a picture-in-picture (PIP)
- 90 Changing the picture size and position
- 91 Listening to audio only (Picture Off)
- 91 Resetting the picture mode settings

Adjusting the Sound Quality

- 92 Choosing a sound mode
- 93 Applying sound effects

Using the Sound Support Functions

- 94 Selecting speakers
- 94 Specifying the TV's installation type
- 94 Listening to TV sound through a Samsung Bluetooth audio device
- 95 Listening to the TV through Bluetooth headphones
- 95 Listening to TV sound through a Samsung Multiroom Link compatible speaker
- 97 Enabling digital audio output
- 98 Resetting all sound settings

System and Support

Setting the Time and Using the Timer

- 99 Setting the current time
- 101 Using the timers

Using the Screen Burn Protection and Energy Saving Functions

- 103 Preventing screen burn
- 103 Reducing the energy consumption of the TV

Using Anynet+ (HDMI-CEC)

- 104 Setting up Anynet+ (HDMI-CEC)
- 104 Using Anynet+ (HDMI-CEC)

Updating the TV's Software

- 106 Updating the TV's software to the latest version
- 106 Updating the TV automatically
- 107 Updating the TV manually

Protecting the TV from Hacking and Malicious Code

- 107 Checking the TV and connected storage for malicious code
- 108 Configuring additional functions

Using Other Functions

- 109 Running the accessibility functions quickly
- 109 Adjusting the menu transparency
- 109 White text on black background (high contrast)
- 109 Enlarging font (for the visually impaired)
- 110 Listening to the TV through Bluetooth headphones (for the hearing impaired)
- 110 Changing the menu language
- 110 Setting up a password
- 110 Checking Notifications
- 111 Programme Rating Lock
- 111 Enabling game mode
- 111 Richer colours and superior picture quality (BD Wise)
- 111 Enabling/Disabling sound feedback
- 112 Locking/Unlocking the Control Stick

- 112 Showing/Hiding the Samsung logo while booting
- 112 Enabling the TV to boot faster
- 113 Registering the TV as a DivX-certified device (watching for pay DivX movies)
- 113 Restoring the TV to the factory settings
- 113 Using the TV as a display model (for retail stores)

Running Data Service Automatically

HbbTV

Using a TV Viewing Card ("CI or CI+ Card")

- 115 Connecting the "CI or CI+ Card" via COMMON INTERFACE slot
- 116 Connecting the "CI or CI+ Card" via COMMON INTERFACE slot with the CI CARD Adapter
- 117 Using the "CI or CI+ Card"

Teletext Feature

Troubleshooting

Getting Support

- 120 Support through Remote Management
- 121 Finding the contact information for service

There Is a Problem with the Picture

- 122 Testing the picture

I Can't Hear the Sound Clearly

- 124 Testing the sound

There Is a Problem with the Broadcast

My Computer Won't Connect

I Can't Connect to the Internet

Data Service

The Schedule Recording/Timeshift Function Isn't Working

Anynet+ (HDMI-CEC) Isn't Working

I Have Trouble Launching/Using Apps

My File Won't Play

I Want to Reset the TV

Other Issues

Precautions and Notes

Before Using the Recording and Timeshift Functions

131 Before using the recording and schedule recording functions

132 Before using the timeshift function

Read Before Using Apps

Read Before Using the Web Browser

Read Before Playing Photo, Video, or Music Files

136 Limitations on use of photo, video, and music files

137 Supported external subtitles

137 Supported internal subtitles

138 Supported image formats and resolutions

138 Supported music formats and codecs

139 Supported video codecs

Restrictions

141 Restrictions to PIP (Picture-in-Picture)

141 Flexible CI

Read After Installing the TV

142 Picture sizes and input signals

142 Installing an anti-theft lock

143 Read before setting up a wireless Internet connection

Read Before Connecting a Computer (Supported Resolutions)

144 IBM

144 MAC

145 VESA DMT

Supported Resolutions for Video Signals

146 CEA-861

146 DVI

Read Before Using Bluetooth Devices

147 Restrictions on using Bluetooth

Licence

Glossary

Using Smart Hub

Connecting to the Internet

(MENU/123) > MENU > Network > Network Settings

Connect the TV to the Internet wired or wirelessly.

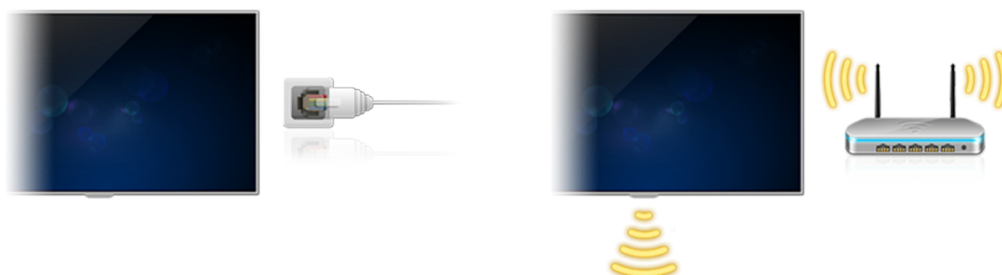

Setting up Smart Hub

Press the  button on your remote control. When you start **Smart Hub** for the first time, the **Set Up Smart Hub** screen appears. Follow the instructions on the screen to configure the required settings and complete the setup.

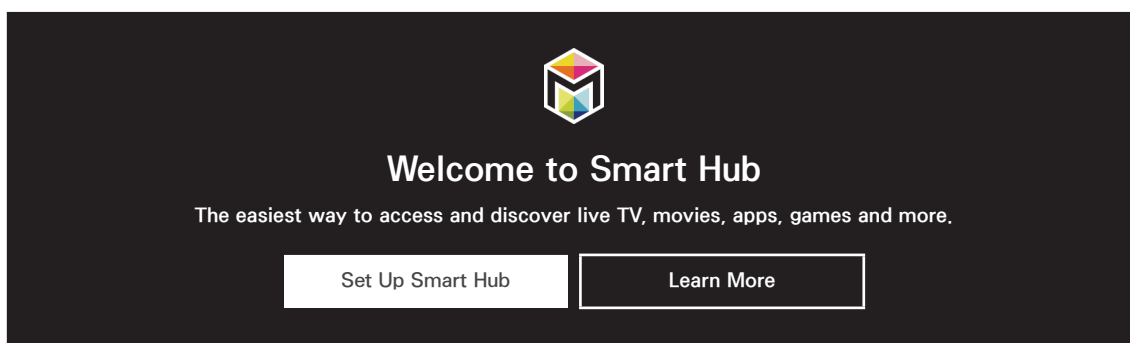

Using Smart Hub

Enjoy the multiple functions provided by Smart Hub on a single screen.

 For more information, refer to "Smart Hub."





Using the Samsung Smart Control

 This function is only supported for J6300, J6330, J6390 models within CIS region.

Operating the TV with the POINTER button



Place a finger on the **POINTER** button and move the Samsung Smart Control. The pointer on the screen moves in the direction you moved the Samsung Smart Control. Move the pointer to one of the following icons on the screen, and then press the **POINTER** button.

- : Displays the On-Screen Remote.
- : Allows you to adjust the volume or select speakers.
- : Displays the channel list.
- : Launches Smart Hub.

Setting up the Samsung Smart Control

(MENU/123) > MENU > System > Smart Control Settings

Configure the basic settings for using the Samsung Smart Control.

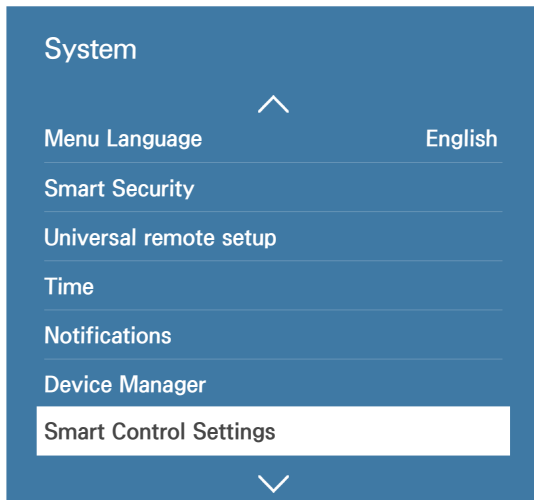

 Your TV's menu may differ from the image above, depending on the model.

Pairing the TV to the Samsung Smart Control

When you turn on the TV for the first time, the Samsung Smart Control pairs to the TV automatically. If the Smart Control does not pair to the TV automatically, point it at the remote control sensor of the TV, then press the ① and ② buttons on the Samsung Smart Control simultaneously for 3 seconds or more.

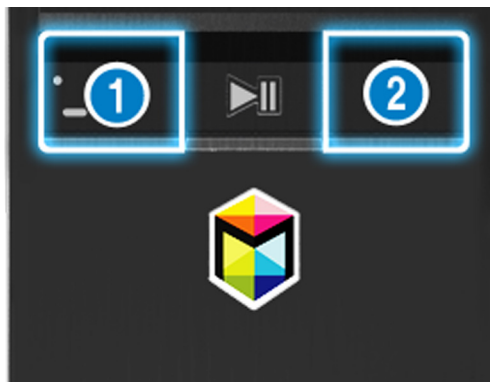

Improving the Viewing Experience of Sports Events

Activating Sports Mode

(MENU/123) > MENU > System > Sports Mode

Set **Sports Mode** to **On**. The TV automatically configures the picture and sound settings so that they are suitable for football events.

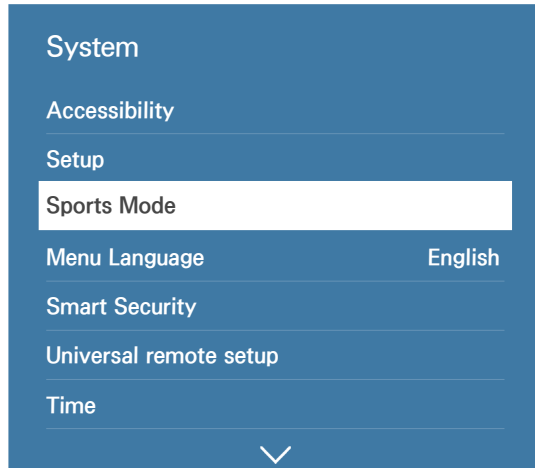

 Your TV's menu may differ from the image above, depending on the model.



You can zoom in the screen while you are using the sports mode. Move the focus to the part of screen to magnify.

 For more information, refer to "Making Sports programmes More Realistic with Sports Mode."

 This function is only available on certain models in specific geographical areas.

Editing Channels

Running the Edit Channel function

(MENU/123) > MENU > Broadcasting > Edit Channel

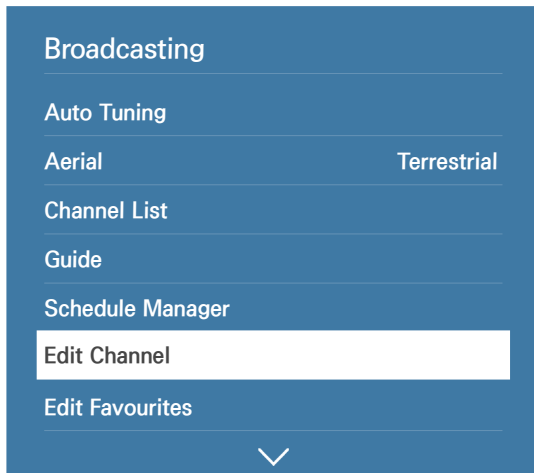

 Your TV's menu may differ from the image above, depending on the model.

Rearranging or deleting channels

(MENU/123) > MENU > Broadcasting > Edit Channel > Change Number or Delete

You can rearrange the order of channels or delete channels. To change the order of a channel, select it and then select **Change Number**. To delete a channel, select it and then select **Delete**.



 Certain channels are not available depending on the channel type.

Connecting an Antenna (Aerial)

Connect the TV to an antenna or a cable outlet to receive broadcast signals.

Connect a cable from an antenna or cable outlet to the ANT IN connector, as shown in the image below.

 An antenna connection is not necessary if you connect a cable box or satellite receiver.

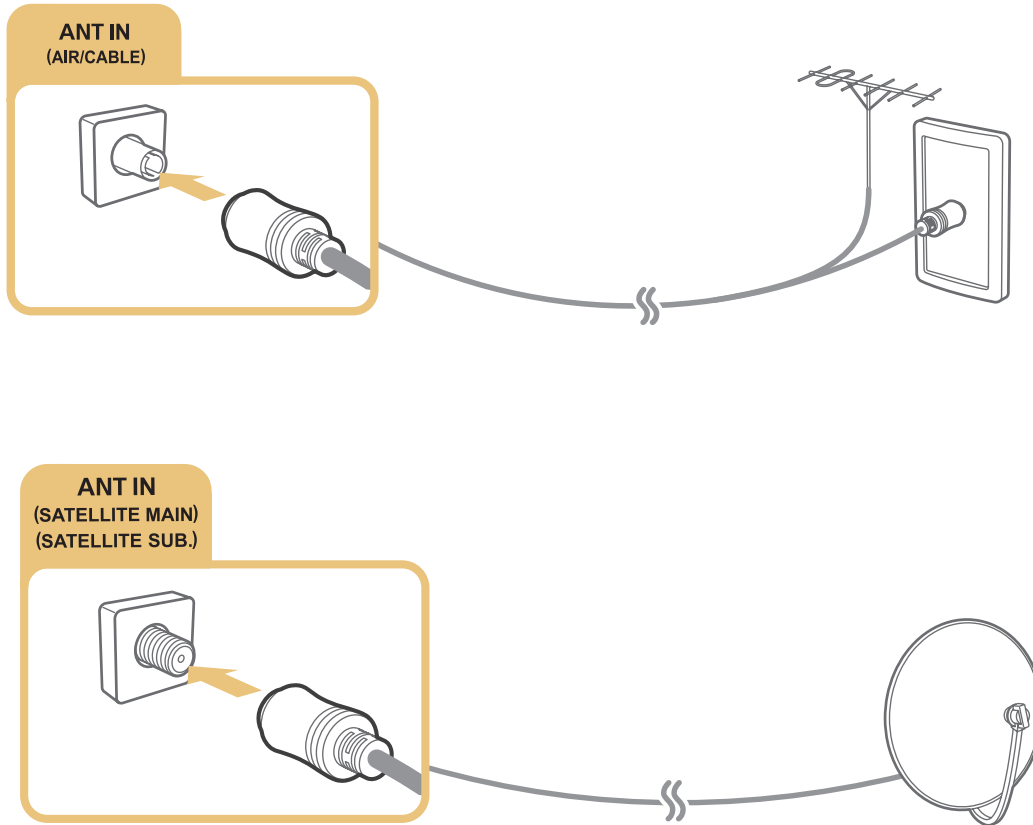

It is best to connect the both connectors using a Multi-Switch or DiSEqC. Switch, etc and to set **Aerial Connection Type** to **Dual Oscillator**.

 A connection method may differ with the models.

 DVB-T2 system may not be available in specific geographical areas.

Connecting to the Internet

Establishing a wired Internet connection

Using LAN cables

There are three ways to connect the TV to your Internet access points, as shown in the following illustrations:

- Wall-mounted LAN Outlet

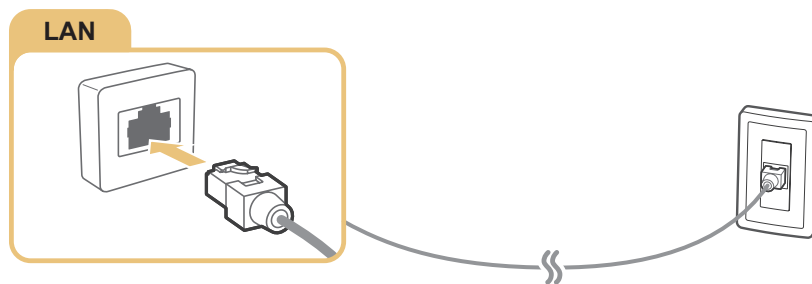

- External Modem

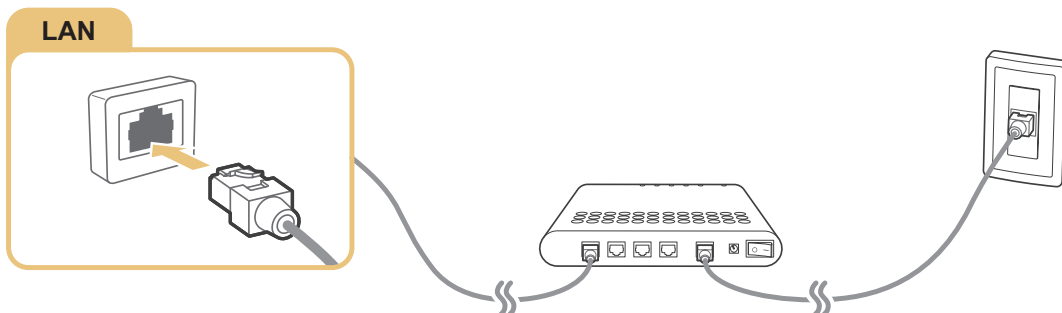

- ① IP Router + ② External Modem

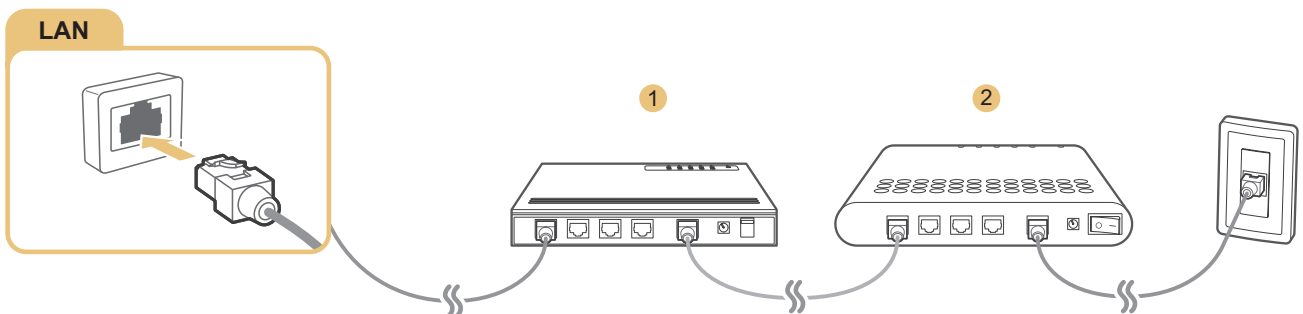

 We recommend using Cat 7 LAN cables to link your TV to the Internet Access Points.

 The TV will not be able to connect to the Internet if the network speed is below 10Mbps.

Connecting to a wired Internet network automatically

(MENU/123) > MENU > Network > Network Settings [Try Now](#)

Automatically connect to an available network.

1. Select **Wired**.
2. Once network connection is successful, you will see a confirmation message. If it fails, try again or connect manually.

Establishing a wireless Internet connection

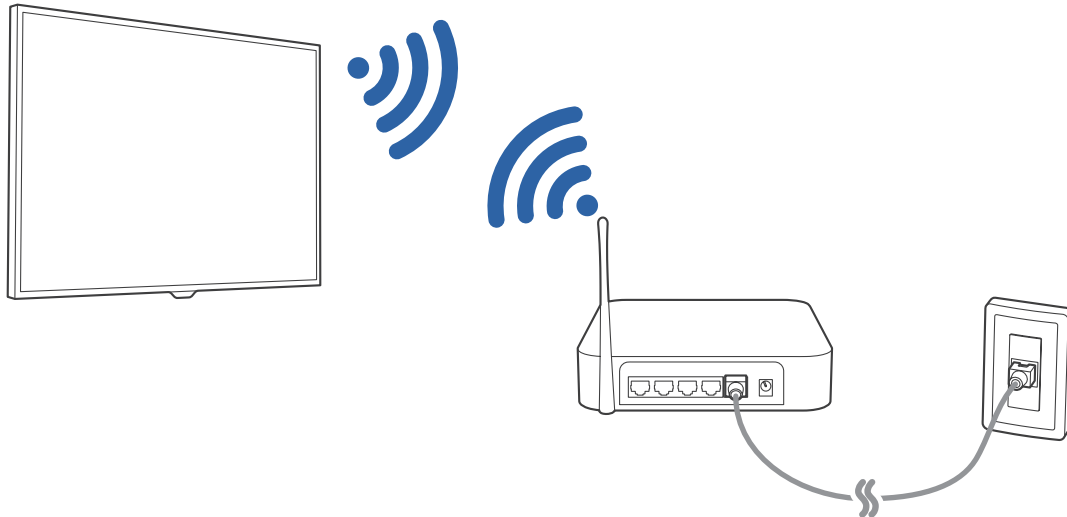

Connecting to a wireless internet network automatically

(MENU/123) > MENU > Network > Network Settings

Make sure that you have the wireless router's SSID (name) and password settings before attempting to connect.

1. Select **Wireless**. The TV automatically displays a list of available wireless networks.
2. Select a network. If the network you want doesn't appear in the list, select **Add Network**, and then enter the network's SSID (name) manually.
3. If your network is security enabled, enter the password. If your network is not security-enabled, the TV will bypass the on-screen keyboard and attempt to connect right away.

Connecting to a wireless internet network with WPS

(MENU/123) > MENU > Network > Network Settings

If the router has a WPS(wi-fi protected setup) push button, you can use it to connect the TV to the router automatically.

1. Select **Wireless**. The TV automatically displays a list of available wireless networks.
2. Select **Stop** and then select **WPS**.
3. Press the WPS or PBC buttons on your wireless router in less than two minutes.
4. The TV is connected to the network automatically.

Checking the internet connection status

(MENU/123) > MENU > Network > Network Status [Try Now](#)

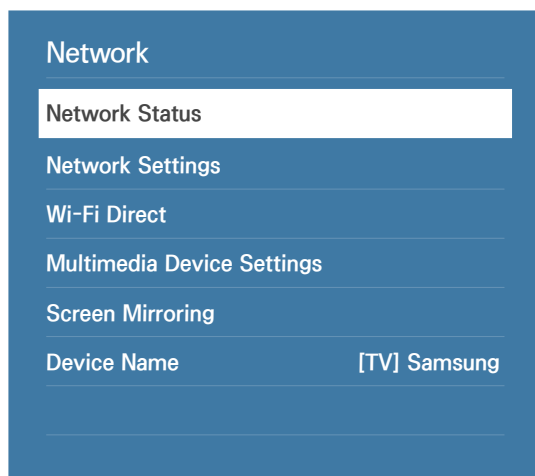

 Your TV's menu may differ from the image above, depending on the model.

View the current network and Internet status.

Changing the name of the TV on a network





(MENU/123) > MENU > Network > Device Name [Try Now](#)

You can change a name for the TV that will appear on mobile devices and laptop computers.

1. Select **Device Name** from the **Network** menu.
2. Select a name from the list that appears. Alternatively, select **User Input** to enter a name manually.

Connecting to a Network via a Mobile Dongle

You can make the TV to connect to a network via a mobile device by connecting a mobile dongle to the TV. Connect the mobile dongle to the USB port in the TV.

-  This function is only available on certain models in specific geographical areas.
-  When you use a large mobile dongle(Data Card), USB devices may not work properly due to interferences among the USB ports, or the wireless network may not work properly due to interferences from the peripherals and surroundings. In this case, use a USB extension cable.
-  **Channel-bound Apps & Ticker** is not available when you set up mobile network.
-  If you have any problems using online services, please contact your Internet service provider.

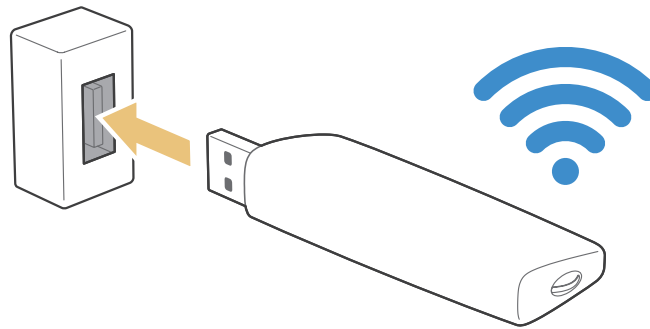

The mobile service providers and their devices that support this function are as follows:

- Vodacom (Model No: K4605)
- MTN (Model No: E3131S, E3251)
- Safaricom (Model No: E303)

Troubleshooting Internet Connectivity Issues

Troubleshooting wired Internet connectivity issues [Try Now](#)

No network cable found

Make sure that the network cable is plugged in. If it is connected, make sure that the router is turned on. If it is on, try turning it off and on again.

IP auto setting failed

Do the following or configure the [IP Settings](#) manually.

1. Make sure that the DHCP server is enabled on the router, and reset the router.
2. If the problem persists, contact your Internet Service Provider.

Unable to connect to the network

1. Check all [IP Settings](#).
2. Make sure that the DHCP server is enabled on the router. Then, unplug the router and plug it back in.
3. If this does not work, contact your Internet Service Provider.

Connected to a local network, but not to the Internet

1. Make sure that the Internet LAN cable is connected to the router's external LAN port.
2. Check the DNS values in [IP Settings](#).
3. If the problem persists, contact your Internet Service Provider.

Network setup is complete, but unable to connect to the Internet

If the problem persists, contact your Internet Service Provider.

Troubleshooting wireless Internet connectivity issues

Wireless network connection failed

If a selected wireless router is not found, go to [Network Settings](#) and select the correct router.

Unable to connect to a wireless router

1. Check if the router is turned on. If it is, turn it off and on again.
2. Enter the correct password if required.

IP auto setting failed

Do the following or configure the [IP Settings](#) manually.

1. Make sure that the DHCP server is enabled on the router. Then, unplug the router and plug it back in.
2. Enter the correct password if required.
3. If the problem persists, contact your Internet Service Provider.

Unable to connect to the network

1. Check all [IP Settings](#).
2. Enter the correct password if required.
3. If the problem persists, contact your Internet Service Provider.

Connected to a local network, but not to the Internet

1. Make sure that the Internet LAN cable is connected to the router's external LAN port.
2. Check the DNS values in [IP Settings](#).
3. If the problem persists, contact your Internet Service Provider.

Network setup is complete, but unable to connect to the Internet

If the problem persists, contact your Internet Service Provider.

Connecting Video Devices

Your TV has a variety of connectors for video input from external devices. Below is a list of featured connectors shown in descending order of picture quality.

- HDMI
- Component
- Composite (A/V)

Connect a video device to the TV with an HDMI connector for the best picture quality. If the device does not have an HDMI connector, try a component connector.

Connecting with an HDMI cable

The following types of HDMI cables are recommended:

- High-Speed HDMI Cable
- High-Speed HDMI Cable with Ethernet

Connect the HDMI cable to the HDMI input connector of the TV and the HDMI output connector of the device as shown in the image below.

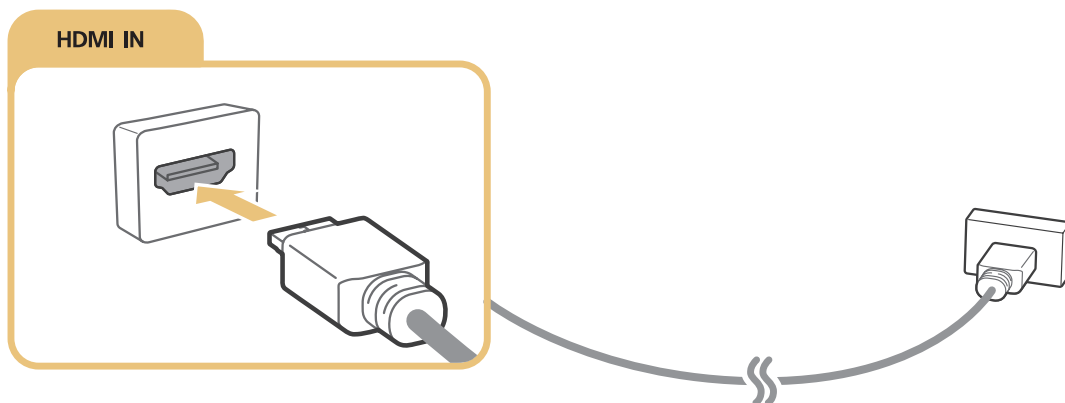

 Set **Edit Device Type** to **DVI PC** for a computer connected with a HDMI-to-DVI cable, and **PC** for a computer connected with HDMI cable. Also, set **Edit Device Type** to **DVI Devices** for an A/V device with a HDMI-to-DVI cable.

Connecting with a component cable

Connect the component cable to the component input connectors of the TV and the component output connectors of the device as shown in the image below.

Make sure the cable colours match the connector colours.

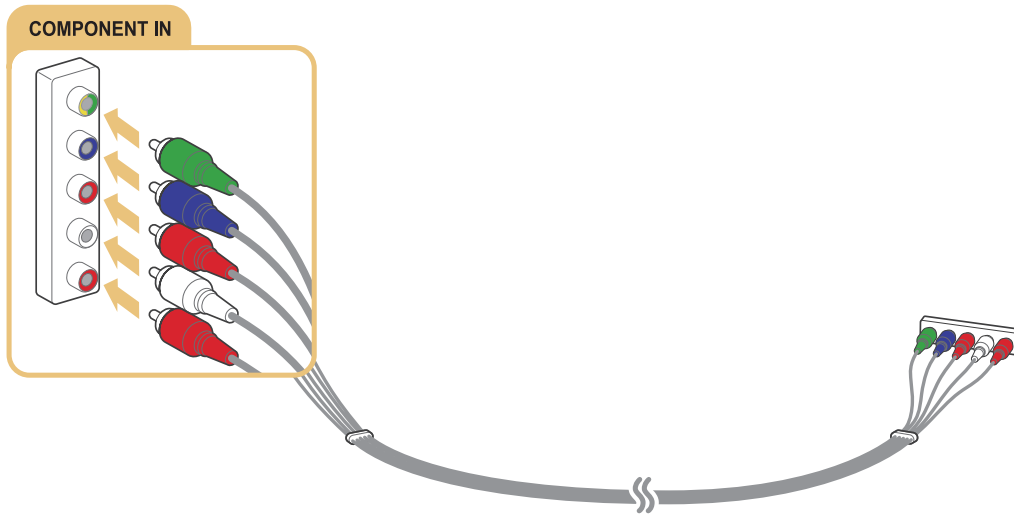

Connecting with a composite (A/V) cable

Connect the AV cable to the AV input connectors of the TV and the AV output connectors of the device as shown in the image below.

Make sure the cable colours match the connector colours.

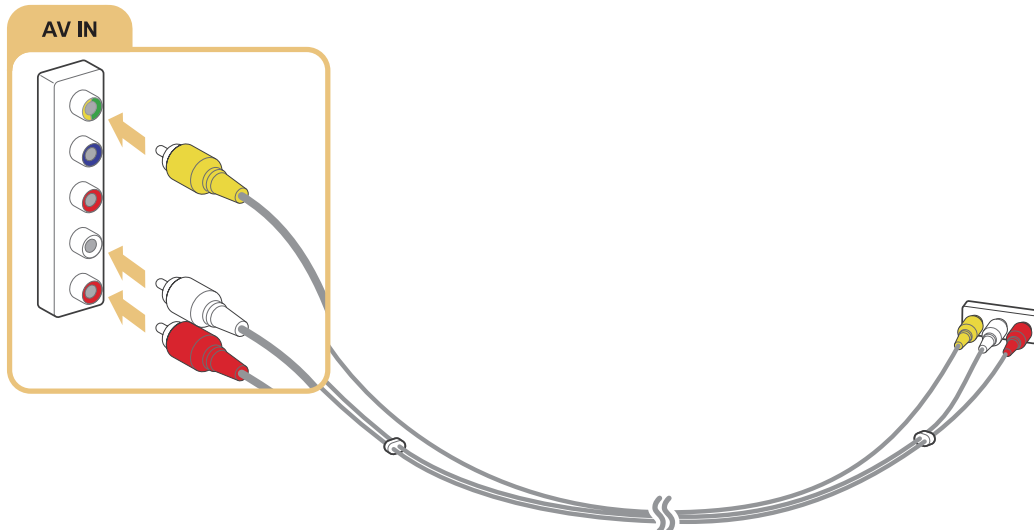

Audio Input and Output Connections

Your TV has a variety of connections for audio input from external devices. The connections are listed below.

- HDMI/ARC (Audio Return Channel)
- Digital Audio (Optical)
- Audio (Analogue)

Connecting with an HDMI (ARC) cable

ARC(Audio Return Channel) lets the TV output digital sound to an audio device and input digital sound from the same audio device through one HDMI cable. ARC is only available through the HDMI (ARC) port and only when the TV is connected to an ARC-enabled AV receiver.

Connect an HDMI cable to the HDMI (ARC) input connector of the TV and the HDMI output connector of the device as shown in the image below.

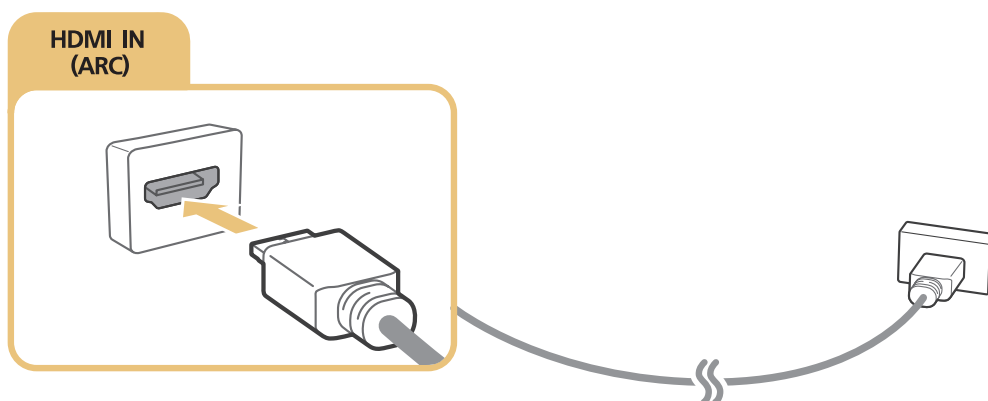

Connecting with a digital audio (optical) cable

You can listen to digital audio by connecting an AV receiver to the TV via a digital audio (optical) connector.

Connect the optical cable to digital audio output connector of the TV and the digital audio input connector of the device as shown in the image below.

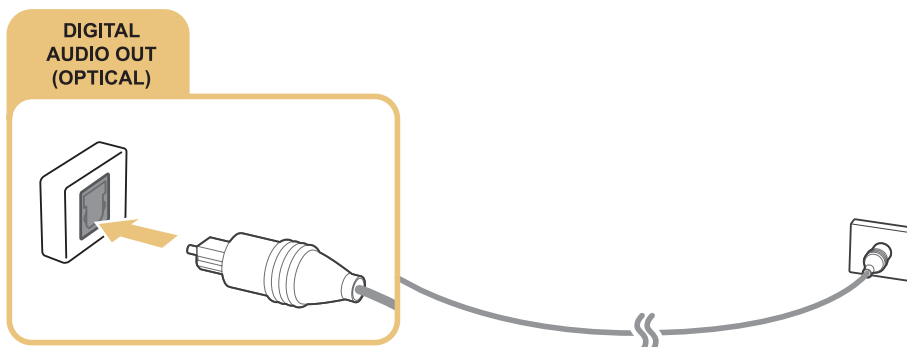

Connecting with headphones

Connect the headphones to the headphone output connector of the TV as shown in the image below.

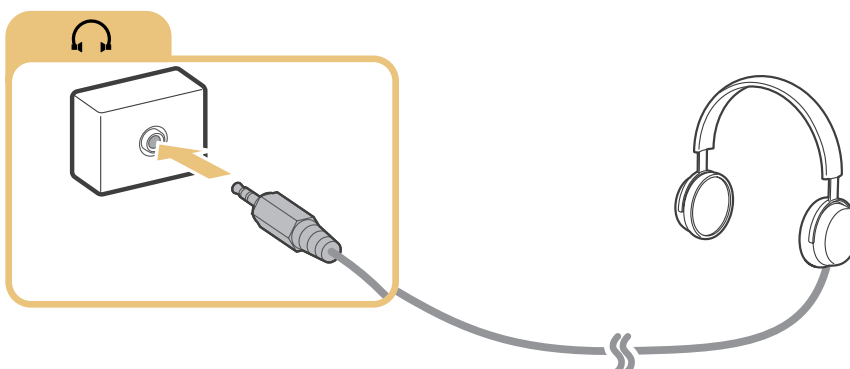

 Availability depends on the specific model and area.

Connecting with an audio cable

Refer to the diagram and connect the audio cable to the TV's audio output connector and the device's audio input connector.

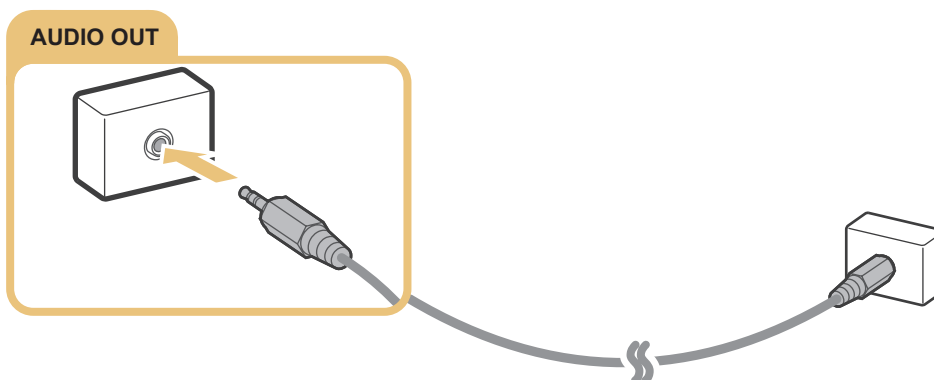

 Availability depends on the specific model and area.

Connecting a Computer

The kinds of connections you can make are listed below.

To use the TV as a computer monitor

- Connect through the HDMI port with an HDMI cable.
- Connect through the HDMI (DVI) port with an HDMI-to-DVI cable.

To view or play the content saved in a computer on the TV

- Connect through using your home network.

Connecting through the HDMI port

For an HDMI connection, we recommend one of the following HDMI cable types:

- High-Speed HDMI Cable
- High-Speed HDMI Cable with Ethernet

Connect the HDMI cable to the HDMI input connector of the TV and the HDMI output connector of the device as shown in the image below.

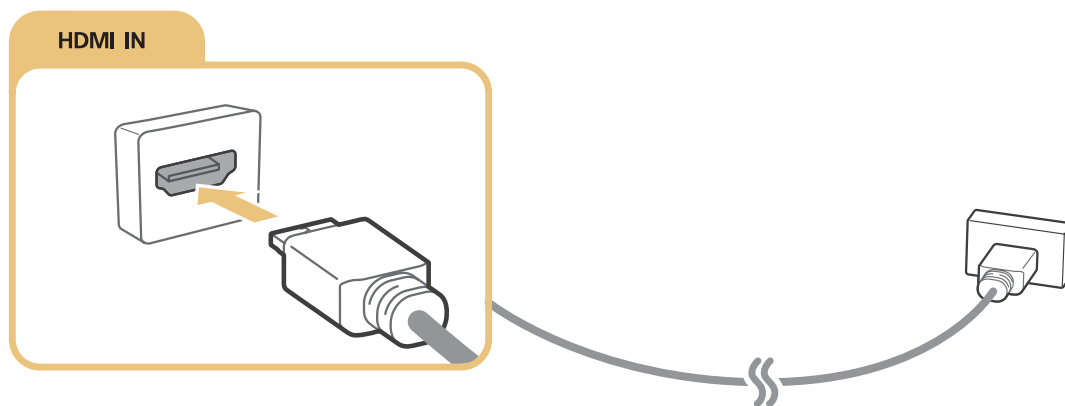



- ✎ Set **Edit Device Type** to **DVI PC** for a computer connected with a HDMI-to-DVI cable, and **PC** for a computer connected with HDMI cable. Also, set **Edit Device Type** to **DVI Devices** for an A/V device with a HDMI-to-DVI cable.

Connecting with an HDMI-to-DVI cable

If the graphics adapter of your TV does not support the HDMI interface, connect the computer to the TV with a DVI (Digital Visual Interactive)-to-HDMI cable. Note that the HDMI-to-DVI connection is only supported by the HDMI (DVI) port and does not transmit audio. To listen to the computer sound, connect external speakers to the audio output connector of the computer.

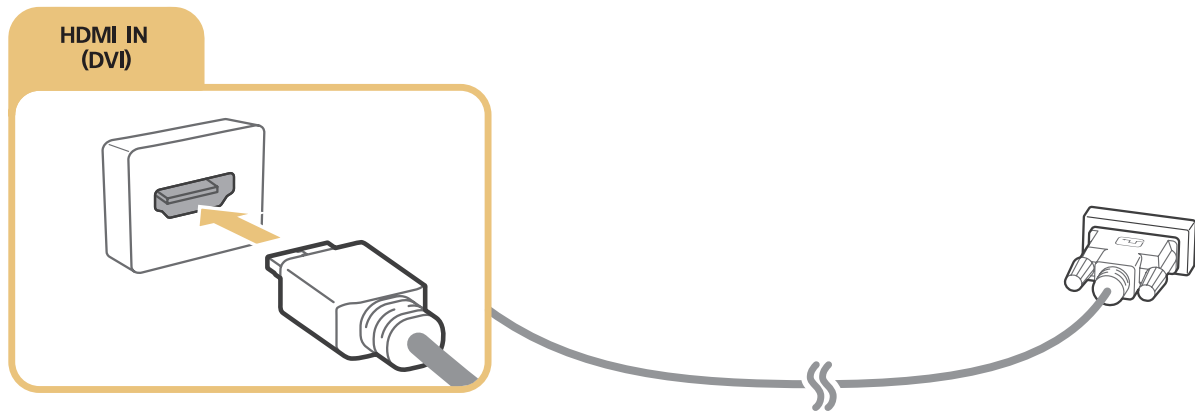
Connect the HDMI-to-DVI cable to the HDMI (DVI) port of the TV and the DVI output port of the computer as shown in the image below.



-  Set **Edit Device Type** to **DVI PC** for a computer connected with a HDMI-to-DVI cable, and **PC** for a computer connected with HDMI cable. Also, set **Edit Device Type** to **DVI Devices** for an A/V device with a HDMI-to-DVI cable.
-  For the resolutions supported by the TV, refer to "Read Before Connecting a Computer (Supported Resolutions)."

Connecting through your home network

You can quickly access and play photo, video, and music files stored on a computer on the TV.

1. Connect the TV and the computer to the same router or AP. Once you connect them to the same router or AP, a home network is configured.
2. On the computer, select [Control Panel] > [Network and Internet] > [Network and Sharing Centre] > [Change advanced sharing settings], and select [Choose media streaming options...] to activate media streaming.
3. From the list, set the TV to [Allowed].
4. Launch Windows Media Player on a computer. Select [Settings] > [Library Management] and add the location where photo, video, and music files are saved to play them on the TV. For more information about playing content, refer to "Playing multimedia content in a computer or mobile device."

-  Alternatively, you can move the files to the default folder specified by Windows Media Player, and then play or view them on the TV.

Connecting a Mobile Device

You can connect a mobile device such as a smartphone or tablet directly to the TV, or connect it to the network and display the mobile device's screen or play its content on the TV. The kinds of connections you can make are listed below.

- View the mobile device's screen on the TV screen by using an MHL-to-HDMI cable.
- Connect by mirroring the mobile device's screen on the TV (Screen Mirroring).
- Connect mobile devices without a wireless router (Wi-Fi Direct).
- Connect a mobile device via Samsung Smart View 2.0.

Connecting with an MHL-to-HDMI Cable

You can use the Mobile High-definition Link (MHL) function to display a mobile device's screen on the TV. However, MHL is only available through the TV's HDMI (MHL) port and only when used in conjunction with an MHL-enabled mobile device. For information on configuring MHL on your mobile device, refer to the device's User Manual.

 If you connect a mobile device to the TV with an MHL-to-HDMI cable, the TV automatically switches the picture size of each content saved on the mobile device to the original picture size of that content.

Connect the MHL-to-HDMI cable to the HDMI (MHL) input connector of the TV and the mobile device's USB port as shown in the image below.

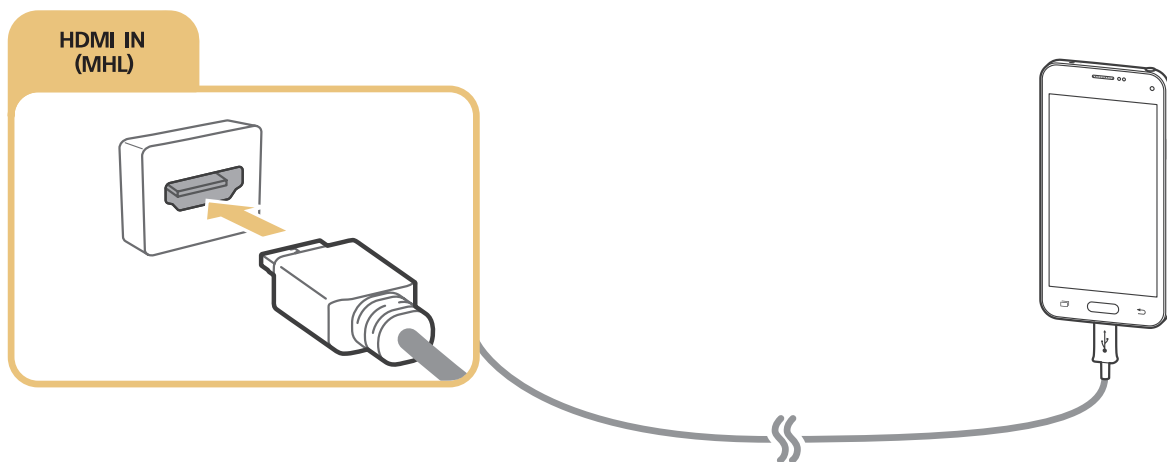

Using Screen Mirroring

(MENU/123) > MENU > Network > Screen Mirroring [Try Now](#)

You can wirelessly connect a mirroring-enabled mobile device to the TV and play the video and audio files stored on the device on the TV. Mirroring refers to the function that plays the video and audio files located on a mobile device on a TV and on the mobile device simultaneously.

Connecting via a mobile device

1. Launch **Screen Mirroring** function on your mobile device. The mobile device searches for available devices to connect to.
2. Select the TV from the list. The TV automatically allows the connection and the device connects.
3. Select **Allow** to connect the mobile device.



All previously allowed mobile devices will automatically connect without needing approval.



If you select **Deny**, the device cannot connect. To change the connection status of a denied device, select (MENU/123) > MENU > Network > **Multimedia Device Manager**, select the device, and select **Allow**. [Try Now](#)

Connecting by automatically allowing the connection

1. Select (MENU/123) > MENU > Network > **Screen Mirroring**, You can also start screen mirroring by pressing the **SOURCE** button on your remote and selecting **Screen Mirroring** from the list at the top of the screen.
2. Launch Screen Mirroring function on your mobile device. The mobile device searches for available devices to connect to.
3. Select the TV from the list. The TV automatically allows the connection and the device connects.



If the mobile device cannot connect, turn off and on the TV and mobile device.

Connecting mobile devices without a wireless router (Wi-Fi Direct)

(MENU/123) > MENU > Network > Wi-Fi Direct > Wi-Fi Direct [Try Now](#)

You can connect a mobile device with the Wi-Fi Direct feature directly to the TV without using a wireless router or AP. By connecting a mobile device to the TV through **Wi-Fi Direct**, you can play photo, video, and music files saved on the mobile device on the TV.

1. Enable Wi-Fi Direct on the mobile device, and then run **Wi-Fi Direct** on the TV. The TV automatically scans for and displays a list of available devices. The TV's name also appears on the mobile device.
2. Select the device from the list to initiate a connection. If a connection request is made by the TV, a permission message appears on the mobile device and vice versa.
3. Allow the connection. The TV and mobile device connect.

 For more information on the multimedia content, refer to "Playing multimedia content in a computer or mobile device."

 To confirm the mobile devices that allows or denies the connection, select (MENU/123) > MENU > Network > **Multimedia Device Manager**.

 When you place the mobile device closer to the TV with Wi-Fi Direct activated, the connection allowance confirmation window appears on the left bottom of the screen so that you can easily connect it.

Managing the connection status of previously connected mobile devices

1. Select (MENU/123) > MENU > Network > Wi-Fi Direct > **Multimedia Device Manager**. The TV displays a list of devices that have previously connected to the TV or have tried to connect to the TV and been denied. The status of the connection (Allow/Deny) is also displayed.
2. Select a device.
3. Select connection type or delete the device from the list.





 This function is only available if the devices have previously connected to the TV or have previously attempted to connect and been denied.

Connecting a mobile device via Samsung Smart View 2.0

You can play the mobile device's multimedia content, such as videos, photos, and music, when you install and launch Samsung Smart View 2.0 on a mobile device connected to the TV. You can send text messages or control the TV using the mobile device.

Pairing a laptop to the TV - Wireless PC Mirroring (or KINO TV)

You can view the enhanced or dual mode screen of a laptop on your TV by pairing the laptop to the TV wirelessly. Connect a Wireless PC Mirroring Adapter (or KINO KIT, VG-SWD1000) to the laptop's HDMI port, and then connect the USB cable that came with the package between a USB port of the Wireless PC Mirroring Adapter (or KINO KIT, VG-SWD1000) and a USB port of the laptop. A pairing message appears on the TV's screen. If you allow the pairing, the laptop's screen is displayed on the TV's screen.

-  This function is only available on certain models in specific geographical areas.
-  Wireless PC Mirroring, KINO TV, and KINO KIT use same technology, and naming may vary by region.
-  This function is not available on third-party TVs or non-laptop devices.
-  If two Samsung TVs are located closely, turn off the TV to which you don't want to pair the laptop, and then try to pair.

Changing the input signal with external devices

Press the **SOURCE** button to switch between external devices connected to the TV.

- **Options**

To view the Options menu, press the **✓** button. The functions that appear in the Options menu can include any of the following:



The connector names may vary depending on the product.

- **Edit Device Type:** Changes the types of the external devices. Select an external device to change. For example, you can use an HDMI cable to designate a computer connected to the TV as **PC**. You can also use a HDMI-to-DVI cable to designate an AV devices as **DVI Devices**.
- **Edit Name:** You can rename devices connected to the TV to facilitate identifying external sources.
- **Information:** Displays information about the connected devices.
- **Anynet+ (HDMI-CEC):** Displays a list of Anynet+ (HDMI-CEC)-compliant devices that are connected to the TV.



This option is only available when **Anynet+ (HDMI-CEC)** is set to **On**.

- **Remove USB Device:** Removes a USB device connected to the TV.
- **Delete Universal Remote:** Deletes the external device connected to the TV via the Universal Remote function.



This function is only supported for J6300, J6330, J6390 models within CIS region.

- **Universal remote setup:** You can use your TV remote control to control external devices.





This function is only supported for J6300, J6330, J6390 models within CIS region.



For more information on using the Universal Remote function, refer to "Controlling External Devices with the TV Remote - Using the Universal Remote."

Connection Notes!

-  The number of connectors and their names and locations may vary depending on the model.
-  Refer to the external device's operating manual when connecting it to the TV. The number of external device connectors and their names and locations may vary depending on the manufacturer.

Connection notes for HDMI

- Use an HDMI cable with a thickness of 14mm or less.
- Using a non-certified HDMI cable may result in a blank screen or a connection error.
- Some HDMI cables and devices may not be compatible with the TV due to different HDMI specifications.
- This TV does not support HDMI Ethernet Channel. Ethernet is a LAN (Local Area Network) built with coaxial cables standardised by the IEEE.
- HDCP 2.2 is supported only by the TV's HDMI (MHL) port. HDCP is short for "High bandwidth Digital Content Protection" and is used for video copyright protection.
- Many computer graphics adaptors do not have HDMI ports, but have DVI ports instead. If your computer graphics adaptor has a DVI port, use an HDMI-to-DVI cable to connect the computer to the TV. For more information, refer to "Connecting with an HDMI-to-DVI cable."
- If you are using an HDMI adapter, the TV recognises the signal as an HDMI signal and may respond differently than it would to an MHL-to-HDMI cable connection.

Connection notes for audio devices

- For better audio quality, it is a good idea to use an AV receiver.
- Connecting a device using an optical cable does not automatically turn off the TV speakers. To turn off the TV's speakers, set **Speaker Select** ((MENU/123) > **MENU** > **Sound** > **Speaker Settings** > **Speaker Select**) to something other than TV Speaker.
- An unusual noise coming from the audio device while you are using it may indicate a problem with the audio device itself. If this occurs, ask for assistance from the audio device's manufacturer.
- Digital audio is only available with 5.1-channel broadcasts.
- Only use headphones with a 3-conductor TRS type jack.
- The headphone volume and the TV volume are adjusted independently of each other.
- While the headphone is connected, the TV speakers are muted and certain **Sound** options are deactivated.

Connection notes for computers

- For the resolutions supported by the TV, refer to "Read Before Connecting a Computer (Supported Resolutions)."
- As long as file sharing is activated, unauthorised access may occur. When you do not need to access data, disable file sharing.
- Your PC and Smart TV must be connected on the same network.

Connection notes for mobile devices





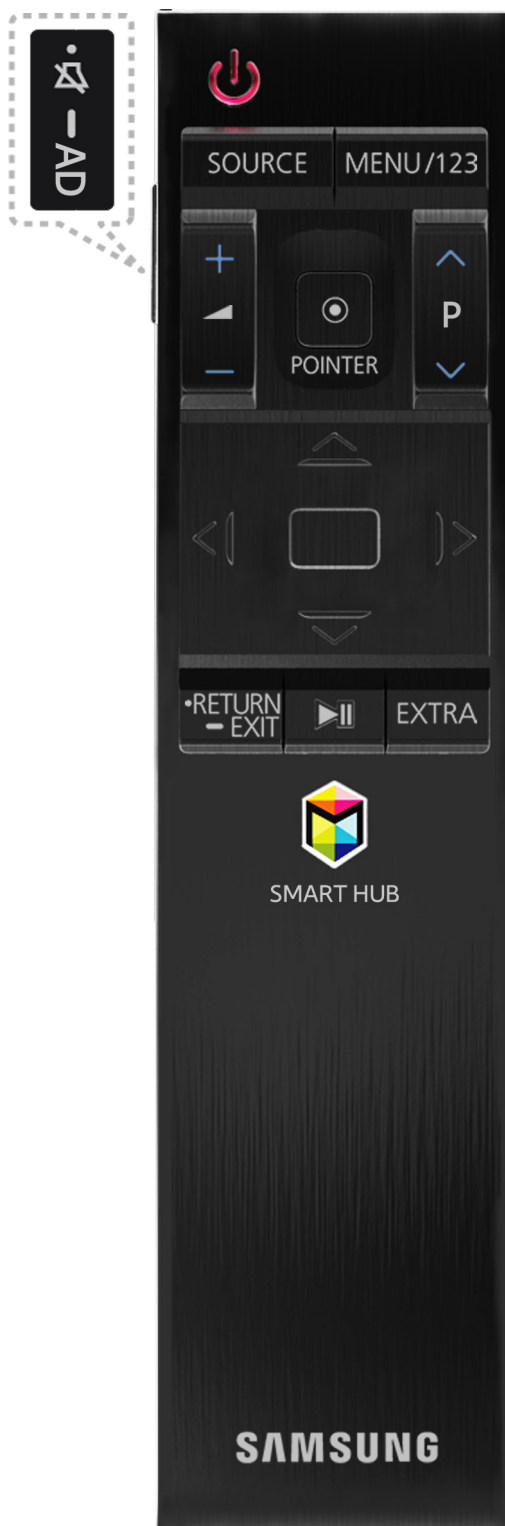

- To use the Screen Mirroring function, the mobile device must support a mirroring function such as AllShare Cast or Screen Mirroring. To check whether your mobile device supports the mirroring function, please visit the mobile device manufacturer's website.
- To use Wi-Fi Direct, the mobile device must support the Wi-Fi Direct function. Please check if your mobile device supports Wi-Fi Direct.
- The mobile device and your Smart TV must be connected with each other in the same network.
- The video or audio may intermittently stop depending on network conditions.

Connection notes for Wireless PC Mirroring (or KINO TV)

- Wireless PC Mirroring, KINO TV, and KINO KIT use same technology, and naming may vary by region.
- The working distance may differ due to obstacles (e.g., human bodies, metal objects, or walls) or electromagnetic environment. To ensure stable functioning, it is recommended to use the Wireless PC Mirroring Adapter (or KINO KIT, VG-SWD1000) in the same location where the TV is placed.
- When a Wireless PC Mirroring Adapter (or KINO KIT, VG-SWD1000) is connected, the TV may not play videos properly depending on whether there is another device that emits radio signals nearby.
- Do not place the Wireless PC Mirroring Adapter (or KINO KIT, VG-SWD1000) near any heat source, in a humid location, or under direct sunlight. This action may cause product malfunction or a fire.
- Do not apply any of the following to the Wireless PC Mirroring Adapter (or KINO KIT, VG-SWD1000): chemicals (e.g., wax, benzene, thinner, mosquito repellent, air freshener, lubricant) and cleaning agent that contains alcohol or solvent or that is surface active. This action may cause the dongle's exterior to discolour or its label to peel off.
- Do not disassemble, repair or modify the Wireless PC Mirroring Adapter (or KINO KIT, VG-SWD1000) by yourself. Stop using the dongle if it is damaged or broken.
- Make sure to use a genuine Wireless PC Mirroring Adapter (or KINO KIT, VG-SWD1000) supplied by Samsung Electronics.

About the Samsung Smart Control



Button	Description
 / AD	Press this button to mute the sound temporarily. Press and hold this button to bring up Accessibility Shortcuts that enables or disables Accessibility ((MENU/123) > MENU > System > Accessibility) menus.
MENU/123	Displays numeric buttons, content control button, and other function buttons on the screen so that you can run a function conveniently.  For more information, refer to "Displaying and using the On-Screen Remote."
POINTER	Place a finger on the POINTER button and move the Samsung Smart Control. The pointer on the screen moves in the direction you moved the Samsung Smart Control. Press the POINTER button to select or run a focused item.  For more information, refer to "Operating the TV with the POINTER button."
	Moves the focus, and changes the values seen on the TV's menu.
Enter	Selects or runs a focused item. Press and hold this button to launch Guide while you are watching the TV.
RETURN / EXIT	Returns to the previous menu or channel. Press and hold to exit the currently running function on the TV's screen.
	Launches Smart Hub applications.
	Controls the content when playing the media content such as movie, picture, or music.
EXTRA	Displays related information about the current programme.
SOURCE	Displays and selects the available video sources.

 The image of the Samsung Smart Control may differ depending on the model.

 This function is only supported for J6300, J6330, J6390 models within CIS region.

 Use the Samsung Smart Control at a distance of less than 6m. The usable distance may differ with the wireless environmental conditions.





Using the Samsung Smart Control

 This function is only supported for J6300, J6330, J6390 models within CIS region.

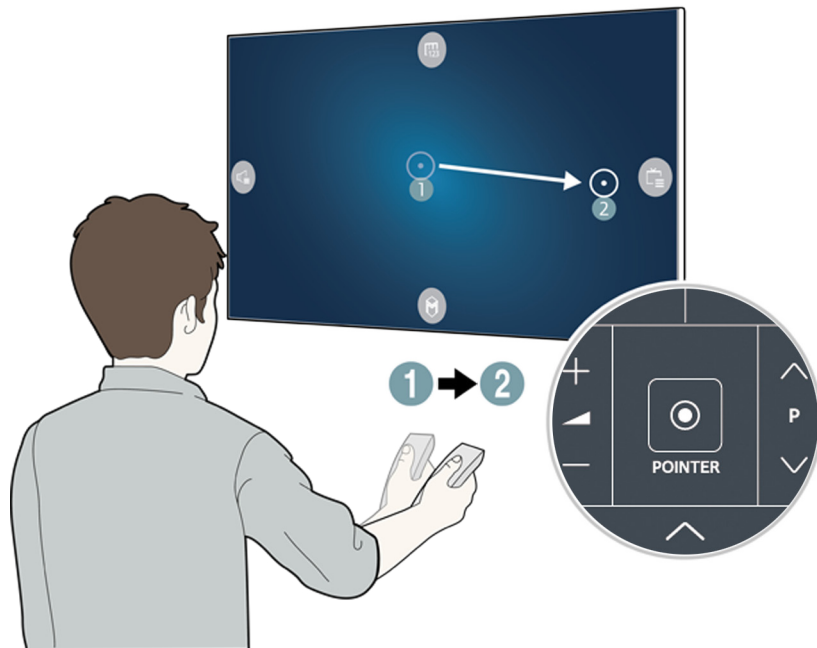



Operating the TV with the POINTER button



Place a finger on the **POINTER** button and move the Samsung Smart Control. The pointer on the screen moves in the direction you moved the Samsung Smart Control. Move the pointer to select an item on the screen.



- : Displays the On-Screen Remote.
- : Allows you to adjust the volume or select speakers.
- : Displays the channel list.
- : Launches Smart Hub.

Operating the TV with the directional buttons and the Enter button

Press the , , , and  buttons to move the pointer, focus, or cursor in the direction you want or change a setting shown on the focused item. Press the Enter button to select an item or run a focused item. Press and hold the Enter button to view the **Guide** while watching the TV.

-  To adjust the pointer speed, select **(MENU/123) > MENU > System > Smart Control Settings > Motion Sensitivity**.
-  To view a tutorial that shows how to use the **POINTER** button, select **(MENU/123) > MENU > Support > Smart Control Tutorial**.

Displaying and using the On-Screen Remote

You can display and use the On-Screen Remote on the TV's screen by pressing the **MENU/123** button on the Samsung Smart Control.

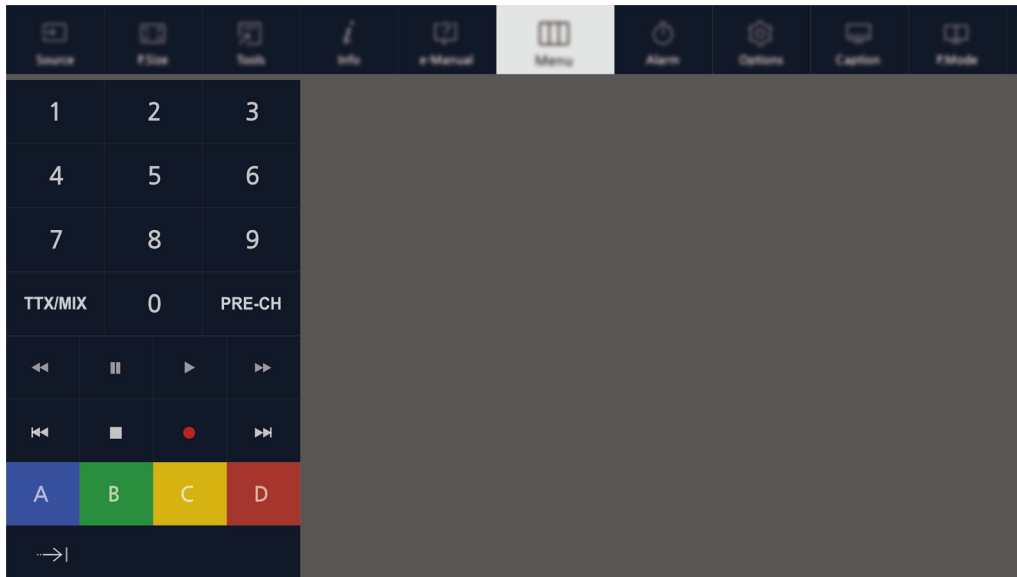

Button	Description
Menu	Displays the menu on the screen.
Guide	Displays the Electronic Programme Guide (EPG).
Info	Displays information about the current programme or content.
Channel List	Launches the Channel List .
Sports Mode	Turns the Sports Mode on or off. ✎ For more information, refer to "Making Sports programmes More Realistic with Sports Mode".
African Cinema Mode	Turns the African Cinema Mode on or off.
e-Manual	Opens the e-Manual.
Picture Size	Changes the picture size.
Picture Mode	Changes the picture mode.
Speaker List	Allows you to select the speakers that will play the TV's audio.
D	Accesses additional features and functions offered by the broadcast you watched. To use this button, the Auto Run Data Service is set to On , and the broadcast should be support the Data Service.
Audio Description/ Subtitles	Displays the Accessibility Shortcuts . Select the options to turn them on or off.

Button	Description
Sleep Timer	Shuts off the TV automatically after a preset period of time.
Tools	Displays the Tool's menu on the screen.
Source	Displays and selects available video sources.
Power	Turns off the TV.
A B C D	Use these coloured buttons to access additional options specific to the feature in use.
Move Number Pad to the Right / Move Number Pad to the Left	Moves the number pad to the left or right.

 The On-Screen Remote buttons may vary, depending on the TV model, region, and the TV functions you are using.

 To change the order of the menu options on the first row, select a menu option to move, press and hold the Enter button, and then select the directional buttons displayed to specify a new position.

Pairing the TV to the Samsung Smart Control

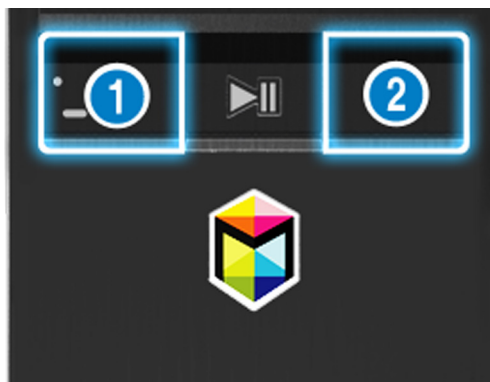

When you turn on the TV for the first time, the Samsung Smart Control pairs to the TV automatically. If the Smart Control does not pair to the TV automatically, point it at the remote control sensor of the TV, then press the ① and ② buttons on the Samsung Smart Control simultaneously for 3 seconds or more.



Controlling External Devices with the TV Remote - Using the Universal Remote



(MENU/123) > MENU > System > Universal remote setup

You can control external devices connected to the TV using the TV's remote control.

-  This function is only supported for J6300, J6330, J6390 models within CIS region.
-  You can also use the Anynet+ (HDMI-CEC) function to operate external Samsung devices with your TV's remote control without any additional setup. Refer to "Using Anynet+ (HDMI-CEC)" for more information.
-  Certain external devices connected to the TV may not support the universal remote feature.

Setting up the universal remote control

1. Connect the external device to control with the universal remote control to the HDMI port on the TV, and then turn on the external device.
2. Press the **SOURCE** button on your remote control to bring up the **Source** screen.
3. Select the **Universal remote setup**.
4. Follow the directions on the screen to complete the set up and register the device. The directions will be different, depending on the device you want to control.

-  If the external device does not respond after being registered, register it again using its model number.
-  The TV memorises both the external device and the connection (HDMI 1, HDMI 2, etc.) the device is connected to.

Using the Tools menu on the TV screen

Press the **TOOLS** button to display the Tools menu on the TV's screen. The following menu options are available.

- **Picture Size:** Changes the picture size.
- **Picture Mode:** Changes the picture mode.
- **Network Settings:** Allows you to connect the TV to the Internet in a wired or wireless connection.
- **Audio Description/Subtitles:** Displays the **Accessibility Shortcuts**. Select the options to turn them on or off.
- **Speaker List:** Allows you to select the speakers that will play the TV's audio.
- **Sleep Timer:** Shuts off the TV automatically after a preset period of time.
- **Dual:** When you press the **Dual** button the first time, the current dual mode is displayed on the screen. Press the **Dual** button again to change the dual mode.
- **e-Manual:** Opens the e-Manual.



The Tools menu options may differ with the model and geographical area.



To change the order of the menu options on the first row, select a menu option to move, press and hold the Enter button, and then select the directional buttons displayed to specify a new position.

Controlling the TV with a Keyboard

(MENU/123) > MENU > System > Device Manager > Keyboard Settings [Try Now](#)

 Certain models are not compatible with USB HID class keyboards.

Connecting a keyboard

Connecting a USB keyboard

Plug the keyboard cable into the TV's USB port.

Connecting a Bluetooth keyboard

 This function is not available on certain models in specific geographical areas.





1. Place the Bluetooth keyboard into standby status.
2. Select (MENU/123) > MENU > System > Device Manager > Keyboard Settings > Add Bluetooth Keyboard. The TV automatically scans for available keyboards. [Try Now](#)

 If your keyboard was not detected, position the keyboard close to the TV, and then select [Refresh](#). The TV scans for available keyboards again.

3. Select the Bluetooth keyboard from the scan list, and then select [Pair and connect](#). A number appears on the screen.
4. Enter the number using the Bluetooth keyboard. This pairs the Bluetooth keyboard to the TV.

Using the keyboard

You can use the following remote features with the USB or Bluetooth keyboard connected to the TV.

Keyboard	Remote control functions
Directional keys	Moves the focus
Windows key	Displays the menu
Menu list key	Displays the On-Screen Remote
Enter key	Selects or runs a focused item
ESC key	Returns to the previous screen
F1 / F2 / F3 / F4 key	 /  /  / 
F5 key	Launches the  button
F6 key	Displays the source screen
F7 key	Launches the Channel List
F8 key	Mutes the sound
F9 / F10 key	Adjusts the volume
F11 / F12 key	Changes the channel

Changing keyboard settings

Select [\(MENU/123\)](#) > [MENU](#) > [System](#) > [Device Manager](#) > [Keyboard Settings](#) > [Keyboard Options](#).
[Try Now](#)

- [Keyboard Language](#)

Displays the languages you can use on your keyboard and lets you select a language.

- [Keyboard type](#)

Displays a list of keyboard types and lets you select a type that matches the Keyboard language you selected.



The list of keyboard type differs depending on the language you selected under [Keyboard Language](#).

- [Switch Input Language](#)

Displays a list of keys you can use to toggle between languages and lets you select a key.

Controlling the TV with a Mouse

(MENU/123) > MENU > System > Device Manager > Mouse Settings [Try Now](#)

 Certain models are not compatible with USB HID class mice.

Connecting a USB mouse

Plug the mouse cable into the TV's USB port.

Connecting a Bluetooth mouse

 This function is not available on certain models in specific geographical areas.

1. Place the Bluetooth mouse in standby status.
2. Select (MENU/123) > MENU > System > Device Manager > Mouse Settings > Add Bluetooth Mouse. [Try Now](#)
3. Select the Bluetooth mouse from the scanned list, and then select **Pair and connect**. This pairs the Bluetooth mouse to the TV.

Using a mouse

You can use a pointer to control the TV in the same way you use a pointer on a computer.

- **Selecting and running an item**

Left-click the mouse.

- **Scrolling the TV menu or screen**

Scroll the mouse wheel up or down.

- **Exiting the TV menu or feature**

Place the pointer in any blank point on the screen, and then left-click the mouse.

Changing mouse buttons and pointer speed

(MENU/123) > MENU > System > Device Manager > Mouse Settings > Mouse Options [Try Now](#)

- **Primary Button**

Select which < or > buttons to use when selecting and running items.

- **Pointer Speed**

Adjust the movement speed of the pointer.

Connecting a Bluetooth Gamepad

(MENU/123) > MENU > System > Device Manager > Bluetooth Gamepad Settings [Try Now](#)

You can play the games downloaded and installed on the **Smart Hub** service using a Bluetooth gamepad. Select **Bluetooth Gamepad Settings**, and then place your Bluetooth gamepad close to your TV. The TV scans for available Bluetooth gamepads automatically. (DualShock®4, a gamepad optimised for PlayStation, is recommended.) After scanning, you can use the Bluetooth gamepad to play games.

 This function is not available on certain models in specific geographical areas.

 If the TV fails to find your Bluetooth gamepad, place it closer to the TV, and then select **Refresh**. For more information on pairing, refer to the Bluetooth gamepad's operating manual.

Entering Text using the On-Screen QWERTY Keypad

Using additional functions

Select  on the QWERTY keyboard screen. The following options are available:

- **Recommend text**

Enables or disables the recommended text feature. The keyboard displays recommended words so that you can enter the text more easily.

- **Reset recommended text data**

Deletes both the recommended words and the memorised words to clear the list.

- **Predict Next Character (when using direction buttons)**

Enables or disables the text prediction feature.

- **Language**

Selects a language from the list.

 This function may not support depending on the country.

Smart Hub

(MENU/123) > MENU > Smart Hub > Open Smart Hub [Try Now](#)

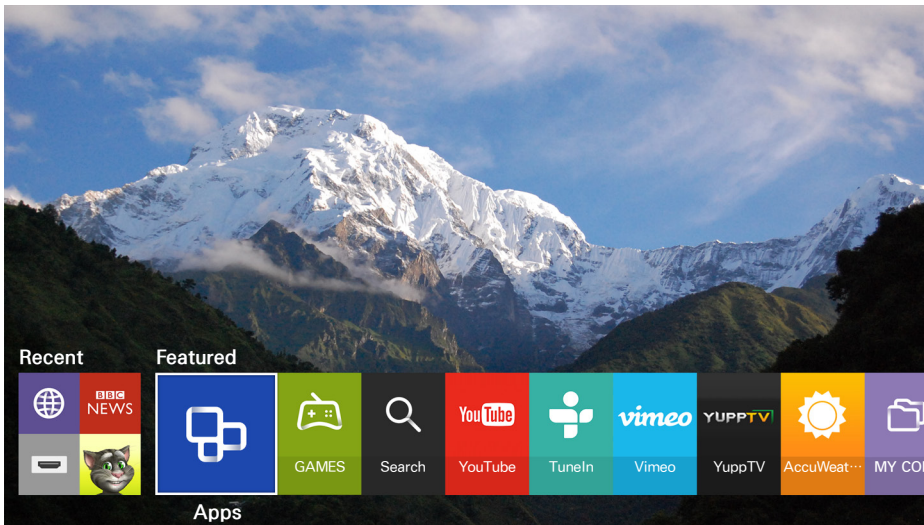

 The image may differ with the specific model and area.



You can surf the web, download apps with Smart Hub. In addition, you can enjoy photo, video, and music files stored on external storage devices. Place a finger on the **POINTER** button to display the pointer on the screen. Select  at the bottom of the screen to launch **Smart Hub**.

On the standard remote control, press the  button on the remote control.

 To run **Smart Hub** while you are using a service provided by Smart Hub, go to the same path as described above.

Removing or pinning an item in the Recent group

To remove or pin an item in the **Recent** group, press the  button on the remote control. The following icons are available.

- : Deletes the item. Although you remove an item from the **Recent** group, it is not removed from your TV.
- : Pin the item to the first position. To unpin the item, select  again.

Launching Smart Hub automatically

(MENU/123) > MENU > Smart Hub > Auto-Start Settings > Smart Hub

You can start Smart Hub automatically when you turn on the TV.

Testing Smart Hub connections

(MENU/123) > MENU > Support > Self Diagnosis > Smart Hub Connection Test [Try Now](#)

When Smart Hub is not working, select **Smart Hub Connection Test**. The connection Test diagnoses the problem by checking the internet connection, your ISP, the Samsung server, and the Apps service.

-  If Smart Hub continues to have problems after completing the test, contact your Internet Service Provider or a Samsung Service Centre.

Using the Smart Hub tutorial







[\(MENU/123\)](#) > [MENU](#) > [Support](#) > [Smart Hub Tutorial](#)

You can learn the basics of using Smart Hub and the Smart Hub service in detail.

Resetting Smart Hub

[\(MENU/123\)](#) > [MENU](#) > [Smart Hub](#) > [Reset Smart Hub](#) [Try Now](#)

You can remove the Samsung accounts saved in the TV and everything linked to them, including apps.

-  Some of the Smart Hub services are for pay services. To use a for pay service, you must have an account with the service provider or a Samsung account. For more information, refer to "Using Smart Hub with a Samsung Account."
-  To use this feature, the TV must be connected to the Internet.
-  Some Smart Hub features may not be available depending on the service provider, language, or region.
-  Smart Hub service outages can be caused by disruptions in your Internet service.
-  To use Smart Hub, you must agree to the end user agreement and privacy policy. Otherwise, you will not be able to access the features and services associated with them. You can view the entire text of the [Terms & Policy](#) by navigating to [\(MENU/123\)](#) > [MENU](#) > [Smart Hub](#) > [Terms & Policy](#). If you want to stop using Smart Hub, you can cancel the agreement. [Try Now](#)
-  To view help information about Smart Hub, select the  button on the Recent screen.



Using Smart Hub with a Samsung Account

Creating a Samsung account

(MENU/123) > MENU > Smart Hub > Samsung Account [Try Now](#)

Some of the Smart Hub services are for paid services. To use a for paid service, you must have an account with the service provider or a Samsung account.



You can create a Samsung account using your email address as your ID.

-  To create a Samsung account, you must agree to the Samsung account end user agreement and privacy policy. Otherwise, you cannot create a Samsung account. You can view the entire content of the agreement by navigating to (MENU/123) > MENU > Smart Hub > Samsung Account > [Terms and Conditions, Privacy Policy](#).
-  You can also create a Samsung account at <http://content.samsung.com>. Once you have an account, you can use the same ID on both the TV and the Samsung website.

Creating a Samsung account

MENU > Smart Hub > Samsung Account > Create Account > Create a Samsung account

You can create the Samsung account by following the on-screen instructions. Once a Samsung account is created, you are automatically signed in to your Samsung account.

-  If you want to review the Terms and Conditions, select [View Details](#).
-  If you want your account to be protected, select [Profile image selection and password entry \(High security\)](#) in the field below the password field.
-  If you want the TV to log you in to your account automatically when you turn the TV on, tick [Sign me in automatically](#).

Creating a Samsung account using a Facebook account

(MENU/123) > MENU > Smart Hub > Samsung Account > Create Account > Create a Samsung account using Facebook

Enter your Facebook ID and password, and then follow the on-screen instructions to complete account setup. Once a Samsung account is created, you are automatically signed in to your Samsung account.

-  Samsung account and Facebook account are automatically linked when you create a Samsung account with your Facebook account.

Signing in to a Samsung account

(MENU/123) > MENU > Smart Hub > Samsung Account > Sign In

You can automatically sign in to your Samsung account and use the Smart Hub feature.

Registering your Samsung account to the TV

If you already have a Samsung account, you can register that account to the TV. Select + > **Sign In** on the Samsung account screen and follow the on-screen instructions.

Signing in to a registered Samsung account saved on the TV

If you register a Samsung account, it is saved on the TV. To sign in to a registered Samsung account, just select it on the TV.

 To change the sign in method, refer to "Changing and adding information to a Samsung account."

Linking your Samsung account to external service accounts

You can automatically log in to the linked apps' accounts when you log into your Samsung account by linking your Samsung account to an external service accounts.

 To use **Link Service Accounts**, you must first log into your Samsung account.

Linking or disconnecting a service account

(MENU/123) > MENU > Smart Hub > Samsung Account > Link Service Accounts

- **Linking a service account**

Select an account from the list and log in to the account by following the on-screen instructions. The service account is linked to the Samsung account.

- **Disconnecting a linked account**

Select an account from the list and unlink the account by following the on-screen instructions.

Changing and adding information to a Samsung account

[\(MENU/123\)](#) > [MENU](#) > [Smart Hub](#) > [Samsung Account](#) > [Edit profile](#)

You can manage your Samsung account. Enter your password with the keyboard displayed on the TV's screen, and then select **Done**. You can perform the following functions on the screen.

 To change the account information, you must be logged in to your Samsung account.

- **Change Your Profile Image**
- **Selecting a Samsung Account sign-in method**
- **Turning auto login on or off**
- **Entering Basic User Information**
- **Subscribing to the Samsung e-Newsletter**

Deleting a Samsung account from the TV

[\(MENU/123\)](#) > [MENU](#) > [Smart Hub](#) > [Samsung Account](#) > [Remove Accounts from TV](#)

You can remove a Samsung account and password information from your TV. The account information for any external accounts linked to the account is also removed from the TV.



 To remove the account information, you must be logged in to your Samsung account.

Using the GAMES Service

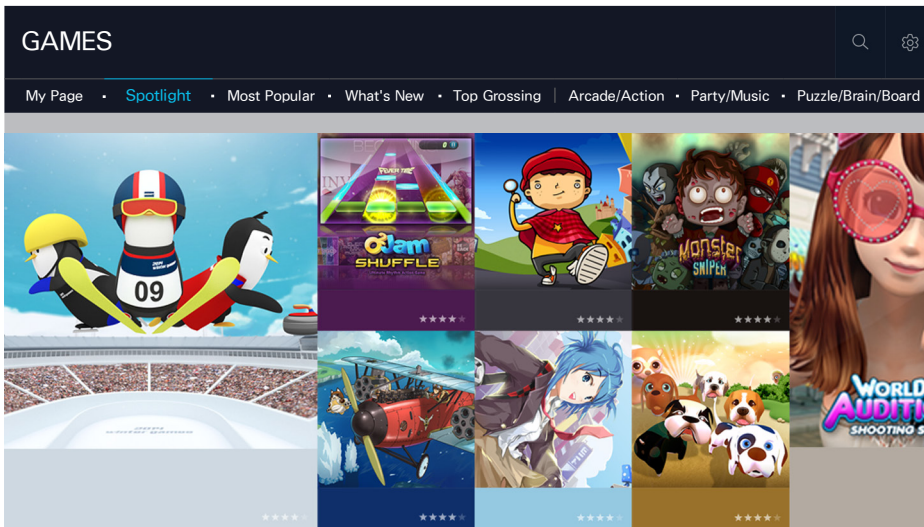
 > [Featured](#) > [GAMES](#)



You can download and play the optimised game apps for your TV. Select a category from the top of the screen. You can install and run the apps arranged by genres. You can also manage the downloaded game apps in [My Page](#).

-  The image may differ with the specific model and area.
-  To use this feature, the TV must be connected to the Internet.
-  This function is only available on certain models in specific geographical areas.

Managing Games with the pop-up Options menu

Move the focus to a game and then press and hold the Enter button. You can use the following functions.

- **Download / Remove**
- **View Details**
- **Update**

-  The pop-up menu may differ with the game you selected.





Viewing the Detailed Information screen

Move the focus to a game, and then press the Enter or **POINTER** button. You can also select the View Details function. See above.

Installing and running a game

Installing games

Select a game to install and press and hold the Enter button. Select **Download** in the context-sensitive window or install the game in the detailed game information screen.

-  To get the information about the game controllers that are compatible with the downloaded game, select **GAMES > Options > Game Controller Guide**.
-  When the TV's internal memory is insufficient, you can install a game on a USB device.
-  You can play a game installed on a USB device only when the USB device is connected to the TV. If the USB device is disconnected during game playing, the game is terminated.
-  You cannot play the game installed on the USB device on a PC or another TV.

Launching an installed game

To run a game, you need to sign in to your Samsung account. First, select a game on **GAMES > My Page** on the **GAMES** screen. The detailed information about the selected game screen appears. Select **Play**. The game starts.

Managing downloaded or purchased games

Select **My Page** on the **GAMES** service.

Updating a game

Select **My Page > Options > Update My Games**. You can update games installed on the TV.

Editing a nickname

1. Select  on the **GAMES** service screen, and then select **Edit Nickname**.
2. Enter your nickname with the on-screen keyboard, and then select **Done**.

 Your nickname is displayed on the **My Page** screen.

Enabling automatic game updates

(MENU/123) > MENU > Smart Hub > App & Game Auto Update or App Auto Update

To update games automatically, set **App & Game Auto Update** or **App Auto Update** to **On**. Games will be updated automatically when an update becomes available.

 The actual name may differ from specific geographical areas.

Removing a game

1. Select  at **My Page** screen, and then select **Delete My Games**.
2. Select a game remove and then press the Enter button. To select all games, select **Select All**.

 You can remove a game by pressing and holding the Enter button with the game selected.

3. When the selection is complete, select **Delete**.

Rating a game

You can rate a game on the detailed information screen.

 This feature is only available when the game only installed on the TV.

Registering a coupon

Enter the coupon number in the **My Page** screen to register it.

Using the Apps Service

 > [Featured](#) > [Apps](#)

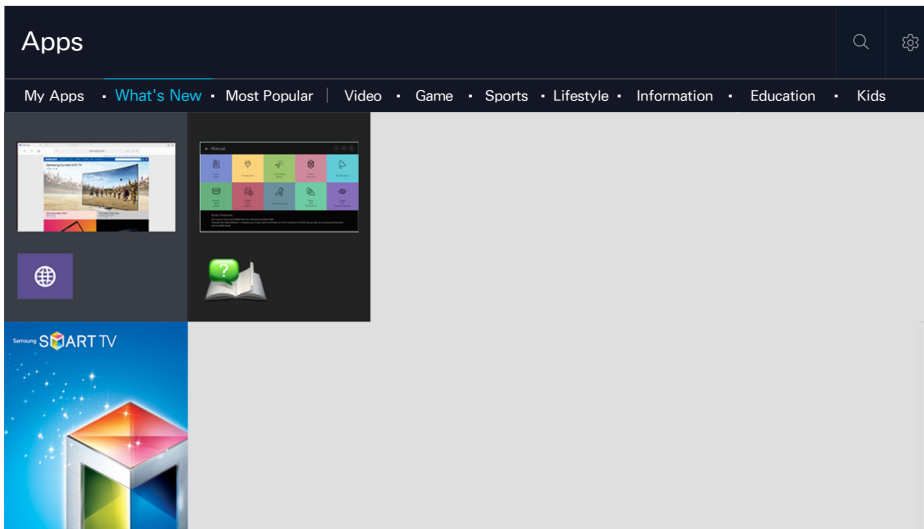

 The image may differ with the specific model and area.

You can enjoy a wide range of content including news, sports, weather, and games by installing corresponding apps on your TV. You can download the apps from Smart Hub. Select a category from the top of the screen. You install and run the apps arranged by genres, such as [What's New](#), [Most Popular](#).

 To use this feature, the TV must be connected to the Internet.

 When Smart Hub is launched for the first time, the default apps are automatically installed. The default apps may differ with the region.

Managing Downloaded Apps with the pop-up Options menu

Move the focus to an app and then press and hold the Enter button. You can use the following functions.





- [Delete](#)
- [More](#)
- [Reinstall](#)

 The pop-up menu may differ with the apps.

Installing an app



Installing an app quickly

1. Select a category on the **Apps** screen.
2. Move the focus to an app, and then press and hold the Enter button. The context-sensitive menu appears.
3. Select **Download**. The selected app is installed on the TV.

-  You can view installed apps on the **Apps** screen.
-  You can also, install the app from detailed information screen.
-  When the TV's internal memory is insufficient, you can install an app on a USB device.
-  You can run an app installed on a USB device only when the USB device is connected to the TV. If the USB device is disconnected during an app is running, the app is terminated.
-  You cannot run the app installed on the USB device on a PC or another TV.

Launching an app

You can launch an app by selecting an app on the **Apps** screen. The icons below appear in the selected apps and indicate the following:

-  : The app is installed on a USB device.
-  : The app has a password.
-  : The app is installed.

Enabling automatic apps updates

(MENU/123) > MENU > Smart Hub > App Auto Update

To update apps automatically, set **App Auto Update** to **On**. Apps will be updated automatically when an update becomes available.

Removing an app from the TV

Select an app to remove on the **Apps** screen and press and hold the Enter button to confirm it. If you want to remove multiple apps, select all the apps to delete and select **Options** from the top of the screen, and then select **Delete My Apps**.

 Ensure that the related app data is also removed when you remove an app.

Locking and unlocking apps

Select **Options** > **Lock/Unlock My Apps** on the **Apps** screen. The password input screen appears. Enter your password, select apps to lock or unlock, and then select **Save**. All selected apps are locked or unlocked.

Updating apps

Select **Options** > **Update Apps** on the **Apps** screen. The TV searches for app updates, and then displays the list. After scanning, you can update some apps or all apps.

Rearranging apps

Select **Options** on the **Apps** screen, and then select **Sort By** to sort the apps by date, time or others.

Rating purchased apps

You can set the star score by using the < or > button on the detailed information screen.

Using other app features and functions

(MENU/123) > MENU > Smart Hub > Auto-Start Settings > Channel-bound Apps & Ticker

You can configure additional app features and functions.

Using channel bound apps

You can receive the information on TV programmes and other relevant services while viewing TV by using an app installed on the TV and linked to a specific channel.

 This function is only available when an app supporting **Channel-bound Apps & Ticker** is installed on the TV.

Using the e-Manual

Launching the e-Manual

(MENU/123) > MENU > Support > e-Manual

You can view the embedded e-Manual containing information about your TV's key features. Press the **MENU/123** button on the Samsung Smart Control, and then select **e-Manual**. On the standard remote, press the **E-MANUAL** button.

1. Select a category from the **e-Manual** screen. The list of the selected category appear on the screen.
2. Select an item from the list. The corresponding e-Manual topic appears.

 Alternatively, you can download a copy of the e-Manual from Samsung's website.

 Words in blue (e.g., **Picture Mode**) indicate a menu item.

The arrows in the menu navigator indicate the menu path. For example, (MENU/123) > MENU > **Picture** > **Picture Mode** means that you press the **MENU/123** button on the Samsung Smart Control, and then select the on-screen display items, **Menu**, **Picture**, and **Picture Mode** sequentially.

Using the buttons in the e-Manual

 (**Search**): Brings up the search screen. Enter a search term, and then select **Done**. Select an item from the search result to load the corresponding page.

 (**Index**): Brings up the index screen. Select a topic from the list to navigate to the relevant page.

 (**Recent pages**): Displays a list of previously read pages. Select a page. The e-Manual jumps to the selected page.

Accessing the associated menu screen from an e-Manual topic page

 (**Try Now**): Allows you to access the corresponding menu item and try out the feature right away.

 (**Link**): Allows you to access the corresponding reference page.

 The e-Manual cannot be accessed from some menu screens.

Updating the e-Manual to the latest version

You can update the e-Manual in the same way you update apps.

Using the web browser

You can surf the Internet on the TV in the same manner as you would using a PC - even while watching a TV programme using PIP. Select [Help](#) to view the information of the Internet web browser.

 For a more convenient web browsing experience, use a keyboard and mouse.

 The browsing page may differ from that on a PC.

Browsing preferences

Select  > [Settings](#). Configure the browsing settings to meet your needs.

- **General**

Hides taps or menu bars automatically after a period of inactivity, or resets all user settings.

 The bookmarks and browsing histories that you made will not be reset.

- **Home Page**

Sets the homepage when you launch the web browser.

- **Search Engine**

Searches for information that you entered and display the result web pages.

- **Privacy & Security**

Prevents you from accessing inappropriate web pages or sets not to save the browsing history.

- **Blocked pages**

Blocks or unblocks pages. You can manage a list of pages to block.

- **Approved pages**

Limits to use only the page that you have approved. To use this option, set a password. You can add or remove the approved pages.

- **Encoding**

Set the encoding to [Auto](#), or selects an encoding method from the list.

- **About**

Displays the current version of Web Browser.

Using the MY CONTENT Service

 > **Featured** > **MY CONTENT** [Try Now](#)

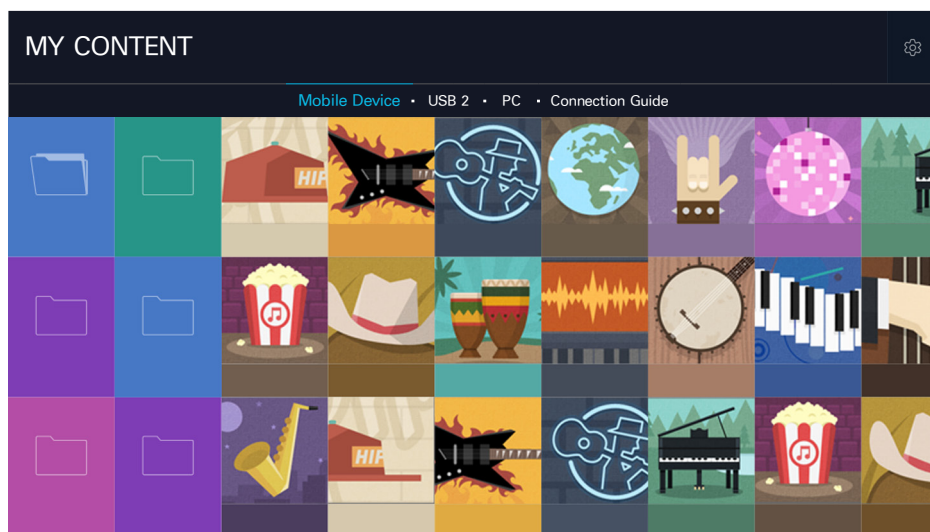

 The image may differ with the specific model and area.

You can play the media content saved on the storage devices, such as a USB device, mobile device, and camera, in the TV. When you connect a storage device to the TV, the TV displays a tab with the name of the connected device. Select the tab to confirm the content saved on the storage device.

 You cannot play media content if the content or the storage device is not supported by the TV. For more information, refer to "Read Before Playing Photo, Video, or Music Files."

 Backup important files before connecting a USB device. Samsung is not responsible for damaged or lost files.

Read before playing media content

 To connect the TV to a computer, refer to "Connecting a Computer."

 To connect the TV to a mobile device, refer to "Connecting a Mobile Device."

 To connect the TV to a USB or external storage device, connect the device to the TV's USB port.

Playing multimedia content in a computer or mobile device



 Before connecting to a computer or mobile device, configure the network settings.

Playing multimedia content saved on a computer or mobile device

 > **Featured** > **MY CONTENT**

To play multimedia content located on a computer or mobile device on the TV, you must allow the connection with the computer or mobile device on the TV.

1. Connect a computer or mobile device. The TV displays the device's name and lists the media contents in the device.
2. Select the media content to play from the list. The selected media content plays.
3. To stop playing media contents, press the  or **RETURN** button.

 Alternatively, move to the media content you want to play, and then press the  button to play the content.

 To connect a computer through your home network, refer to "Connecting a Computer."

 To connect a mobile device through Smart View 2.0, refer to "Connecting a Mobile Device."

 The content shared by a computer or a mobile device may not be played depending on the encoding type and file format of the content.

 The content may not be played smoothly depending on the network status. If this occurs, transfer the content to a USB storage device, and then play the content from the device.

Playing media content saved on a USB device

1. Select a USB device name on the **MY CONTENT** screen. The TV displays a thumbnail list of the media content saved on the USB device.
2. Select the media content to play from the list. The selected media content plays.
3. To stop playing media contents, press the  or **RETURN** button.

 Alternatively, if you select a USB device on the **Source** screen, the TV jumps to the **MY CONTENT** screen automatically.



Safely Removing a USB Device

1. Press the **SOURCE** button. The Source screen appears.
2. Move the focus to the USB device you want to remove, and then press the **✓** button.
3. Select **Remove USB Device** in the list.

Buttons and functions available while viewing photos

Press the Enter button while viewing photos to display available options. You can also view the thumbnails of photos saved on the TV while viewing photos. The options disappear when you press the **RETURN** button.

- **Pause / Play**
Start or stop the slideshow. Using slideshow, you can play all the photos in a folder one by one.
- **Previous / Next**
View the previous or the next photo.
- **Pause BGM / Play BGM**
Pauses or resumes the background music.
- **Settings**

Function	Description
Slideshow Speed	Sets the slideshow speed.
Slideshow Effect	Applies transition effects for the slide show.
Rotate and Zoom	Zooms in by up to a factor of 4. Rotates the photo.
Background Music	Plays background music while the TV displays photos.  The music files must be saved in the same USB device as the photo file.  When background music plays, the music icon appears on the screen. Using the music icon, you can pause the current music file or play another music file.
Sound Mode	Changes the sound mode setting.  This mode is supported only when background music is playing.
Speaker List	Gives you a choice of which speakers to play the background music through. TV Speaker: Plays the background music through the TV speakers. Audio Out: Plays the background music through the external speakers. Speaker Settings: Plays the background music through a speaker that you want. Sound Mode: Changes the sound mode during playback when you play the music through the TV speakers. Equaliser: Allows you to adjust the loudness of specific frequency ranges to control the richness of the sound. To restore the defaults, select Reset .
Picture Mode	Changes the picture mode setting.
Information	Displays detailed information about the current photo.

Buttons and functions available while viewing videos

Press the Enter button while viewing videos to display available options. Preview images of the frames at the same time intervals are displayed so that you can move to a specific frame easily. The options disappear when you press the **RETURN** button.

- **Pause / Play**

Pauses or plays the video. You can use the following functions when the video is paused. With the video paused, the TV does not play audio.

- **Step:** Scans the paused video one frame at a time by pressing the **■** button.
- **Slow Motion:** Plays the video in slow playback speed (1/8, 1/4, 1/2) by pressing the **▶▶** button.

- **Rewind / Fast Forward**

Rewinds or fast forwards the video. To increase the rewind or fast forward speed up to 3 times faster than normal, select the button repeatedly. To restore normal playback speed, press the **▶** button.

- **Previous / Next**

Plays the previous or next video. Press the **◀◀** button twice to play the previous video. Press the **◀◀** button once starts the current video from the beginning.

Press the **▶▶** button to play the next video.

- **Repeat**

Plays the current file repeatedly or all files in the same folder repeatedly.

- **Settings**

Function	Description
Picture Size	Changes the size of the screen. The supported picture sizes differ with the video.
Subtitles	Controls the subtitles of the video. Subtitles: Turns the subtitles on or off. Language: Sets the subtitle language. Sync: Adjusts the synchronisation when the video and the subtitles are not synchronised. Reset Sync: Resets the subtitle synchronisation adjustment to 0. Size: Changes the font size for the subtitles. Encoding: Changes the encoding language when the subtitles are displayed incorrectly.
Rotate	Rotates the video.
Picture Mode	Changes the Picture Mode setting.
Sound Mode	Changes the Sound Mode setting.
Speaker List	TV Speaker: Plays the video sound through the TV speakers. Audio Out: Plays the video sound through the external speakers. Speaker Settings: Plays the TV sound through a speaker that you want. Sound Mode: Changes the video sound mode during playback when you play the video sound through the TV speakers. (Sound > Sound Mode) Equaliser: Allows you to adjust the loudness of specific frequency ranges to control the richness of the sound. To restore the defaults, select Reset .
Audio Language	Selects a audio language. This function is only available when the video supports multi-track sound.
Information	Displays detailed information about the video.

Buttons and functions available while playing music

- **Pause / Play**

Pauses or resumes the music.

- **Previous / Next**

Plays the previous or next music file. Press the **⏮** button twice to play the previous music file. Press the **⏮** button once starts the current music file from the beginning.

Press the **⏭** button to play the next music file.

- **Repeat**

Plays the current music file repeatedly or all music files in the same folder repeatedly.

- **Shuffle**

Plays the music files in random order.

- **Speaker List**







- **TV Speaker:** Plays the music through the TV speakers.
- **Audio Out:** Plays the music through the external speakers.
- **Speaker Settings:** Plays the music through a speaker that you want.
- **Sound Mode:** Changes the sound mode during playback when you play the music through the TV speakers. (**Sound > Sound Mode**)
- **Equaliser:** Allows you to adjust the loudness of specific frequency ranges to control the richness of the sound. To restore the defaults, select **Reset**.

- **Picture Off**

Plays the music files only with the screen off.



Listening to music in HD quality

You can enjoy HD music in HD native quality. Move to **MY CONTENT** service and select a music file to play in HD quality.

-  Set **HD Audio** ((**MENU/123**) > **MENU** > **Sound** > **Additional Settings** > **HD Audio**) to **On** before playing HD Audio format.
-  If a music file supports the HD audio format, the HD icon appears in the list.
-  Select the music file, and then select ▶ to play it.
-  When you set **HD Audio** mode to **Off** during playback, the next music file is played with standard audio signals.
-  Standard audio signals are sampled at 48 kHz while HD audio signals are sampled at 96 kHz.
-  Some S/PDIF receivers may not be compatible. For such incompatible receivers, deactivate **HD Audio** mode and use normal audio mode instead.
-  Some external audio players connected via HDMI, Bluetooth, or Wi-Fi networks are not able to play the HD audio signals.

Functions on the media content list screen

You can use the following functions on the media content list screen of a storage device.

- **Filter By**
Filters the media content to display the type of media you want.
- **Sort By**
Sorts the content list. The sorting methods change depending on the type of content you have selected.
 -  This function is not available when **Filter By** is set to **All**.
- **Delete**
Deletes the selected media content from the media content list.
 -  This function is only available when **Filter** is set to **Recorded**.
- **Play Selected**
Plays the selected media content from the media content list.
 -  This function is not available when **Filter By** is set to **All**.

Using the NewsON Service

 > [Featured](#) > [NewsON](#)

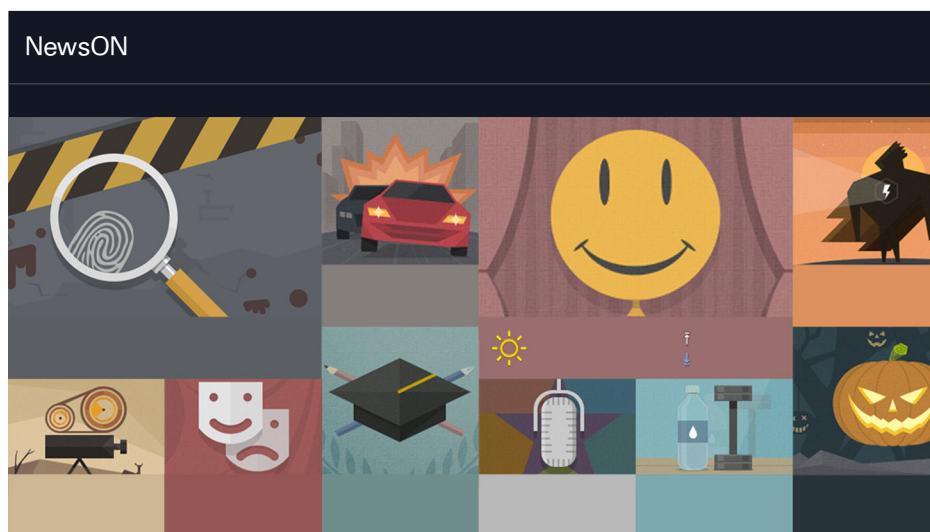

 The image may differ with the specific model and area.

You can find daily information on a wide variety of topics in a smart and convenient way, updated in real time. [NewsON](#) brings you the latest headlines, top stories, popular issues, and weather forecasts.

 To use this feature, the TV must be connected to the Internet.

 The image may differ with the model.

 This function is only available on certain models in specific geographical areas.

News

Select an article on the screen. The selected article will be displayed on the screen in detail. The articles are updated in real time.

Weather

Select a weather-related item on the screen. The selected item will be displayed in detail.

 The weather information is provided for major cities of your country.

Viewing Digital Broadcast Information at a Glance

Using the guide

(MENU/123) > MENU > Broadcasting > Guide Try Now Try Now

You can get an overview of each digital channel's programme lineup from the Guide.

You can move through the Guide in 24 hours jumps in either direction each time you press the ◀◀ or ▶▶ button.

You can select the buttons that appear at the bottom of the screen by using the **POINTER** button of the Samsung Smart Control.

 The information in the **Guide** is for digital channels only. Analogue channels are not supported.

 To view the Guide, you must first set the TV's clock ((MENU/123) > MENU > System > Time > Clock).

To access the Guide functions after launching the Guide, press and hold the Enter button on the remote control. A popup window listing the following functions appears.

- **Channel Filter**

Filters the channels in the **Guide** screen by the selected filter.

- **Schedule Manager**

Displays the schedule manager.

 For information about the schedule manager, refer to "Setting Up a Schedule Viewing."

- **Edit Favourite Channels**

Allows you to set a channel that you select in the **Guide** as a favourite.

- **View Details**

Displays detailed information about a selected programme. The programme information may differ with the broadcast signal and may not be available at all for certain programmes.

- Select a current programme on another channel, and then **View Details** to **Watch** or **Record** the programme.
- Select an upcoming programme, and then select **View Details** to set up a **Schedule Viewing** or **Schedule Recording**.

 On the standard remote control, press the **INFO** button.

 For more information about watching or **Schedule Viewing** refer to "Setting Up a Schedule Viewing."

 For more information on **Schedule Recording**, refer to "Recording Programmes." This function is only available on certain models in specific geographical areas.

 You can only view programmes scheduled after the current time.

- **Record**

Starts instant recording for the selected programme.





 This function is only available on certain models in specific geographical areas.

Checking current programme info

To get information about a show that you are watching, press the Enter or **INFO** button.

To view information about, start instant recording for, or apply the Timeshift function on a current programme, select it in the Programme Info window.

To view information about upcoming programmes, use the **<** and **>** buttons. To set up a **Schedule Viewing** or **Schedule Recording** for a programme, select that programme.

-  To view the programme info, you must first set the TV's clock ((**MENU/123**) > **MENU** > **System** > **Time** > **Clock**).
-  The programme information may differ with the type of incoming signal and may not be available at all for certain programmes.
-  For more information on **Schedule Recording**, refer to "Recording Programmes." This function is only available on certain models in specific geographical areas.
-  For more information on **Schedule Viewing**, refer to "Setting Up a Schedule Viewing."

Changing the broadcast signal

(**MENU/123**) > **MENU** > **Broadcasting** > **Aerial** **Try Now**



You can choose your preferred method of receiving digital broadcasts.

-  This function is not needed if your TV is connected to a cable or satellite box.

Checking digital channel signal info and strength



(**MENU/123**) > **MENU** > **Support** > **Self Diagnosis** > **Signal Information** **Try Now**

You can check the digital channel's signal information and strength.

-  If your TV is attached to a separate, over-the-air antenna, you can use the signal strength information to adjust the antenna for increased signal strength and improved HD channel reception.
-  This function is only available for digital channels.

Recording Programmes

The  appears next to programmes and channels for which a Schedule Recording has been set.

-  This function is only available on certain models in specific geographical areas.
-  Read all precautions before using the recording feature. Refer to "Before Using the Recording and Timeshift Functions" for more information.

Recording programmes

You can record current and upcoming programmes.

Instant recording

To begin recording the current programme right away, press the  button on the standard remote control.





Or, press the **MENU/123** button on the Samsung Smart Control, and then select the  button on the On-Screen Remote.

Using the instant and schedule recording options from the guide

To start instant recording of a current programme, select that programme from the **Guide**, and then select **Record**. To start a schedule recording of a programme that will air in the future, select that programme from the **Guide**, press and hold the Enter button, select **View Details**, and then select **Schedule Recording**.

Using the Instant and Schedule Recording options from programme info window

To start instant recording or a schedule recording of a programme, press the Enter button. The Programme Info window appears.

To start instant recording of a current programme, select . To start a schedule recording of a programme that will air in the future, press the  or  buttons to move to that programme, press the Enter button, and then select .

Using schedule recording to record on a specified date and time

(MENU/123) > MENU > Broadcasting > Schedule Manager > Schedule

1. Select **Schedule Recording**.
2. Specify the **Source**, **Channel**, **Repeat**, **Start Time**, and **End Time** options for the programme you want to record, and then select **OK** to finish.

Using the functions available while recording a programme

Press the Enter button while recording a programme. The following buttons and the recording progress bar appear on the screen.

- **More Info**

Displays detailed information about the programme being recorded.



The programme information may differ with the broadcasting signal and may not be available at all for certain programmes.

- **Recording Time**

Sets the recording time.

- **Stop Recording / Go to Live TV**

Stops recording. / Shifts viewing to live TV.

Using the buttons on the remote control while recording a programme

- **Pause / Play**

Press the ► or || button on the remote control to pause the recording screen or resume the paused recording screen.

When the recording is paused, you can use the following functions. However, no audio is heard while the recording is paused.

- **Step:** Press the MENU/123 button on the Samsung Smart Control, and then select the ||| button to scan through a video one frame at a time.



On the standard remote control, press the ||| button.

- **Slow Motion:** Press the MENU/123 button on the Samsung Smart Control, and then select the >> button to play the video back at 1/2 the normal speed.



On the standard remote control, press the >> button.

- **Rewind / Fast Forward**

Press the MENU/123 button on the Samsung Smart Control, and then select ◀◀ or ▶▶ button to speed up rewind or fast forward to maximum speed in 7 steps.



On the standard remote control, press the ◀◀ or ▶▶ button.



This function is not available while you are watching a programme that is currently being broadcast.

Managing the schedule recording list

(MENU/123) > MENU > Broadcasting > Schedule Manager

You can change the settings of scheduled recording sessions or cancel scheduled sessions altogether.

Viewing recorded programmes

 > **Featured** > **MY CONTENT**

1. Select a USB recording device. The CONTENTS folder appears.
2. Select a recorded programme file from the CONTENTS folder to play the selected file.

 This function is only available on certain models in specific geographical areas.

Using the functions available while playing a recording

Press the Enter button. The following buttons appear. To hide the buttons, press the **RETURN** button.

 Buttons that appear are different depending on the file being played.

- **Pause / Play**

Pauses the file (recorded programme) or resumes playing the file if paused.

When the video is paused, you can use the following functions. However, no audio is heard while the video is paused.

- **Step:** Select the **II** to scan through a video one frame at a time.
- **Slow Motion:** Select the **▶▶** button to play the video back at 1/2 the normal speed.

- **Previous / Next**

To restart the current video from the beginning, select the **◀◀** button.

To play the next file (recorded programme), select the **▶▶** button.

- **Rewind / Fast Forward**

Speeds up rewind/fast forward to its maximum speed in 3 steps. To restore normal playback speed, select ►.

 This function is not available while you are watching a programme that is currently being broadcast.

- **Repeat**



Plays the current file repeatedly or all files in the same folder repeatedly.

- **Highlights Player**

Displays highlights of the current recording.

 This function is only available when highlights of a programme which was recorded in **Sports Mode** have been saved.

- **Options**

Function	Description
Picture Size	Changes the size of the screen. The supported picture sizes differ with the video.
Subtitle Settings	Subtitle: Turns the subtitles on or off. Subtitle Language: Changes the language.
Picture Mode	Changes the picture mode.
Sound Mode	Changes the sound mode.
Speaker List	Allows you to select the speakers to play the audio through.  This function is only available when you have a home theatre or receiver connected to the TV.
Audio Language	Allows you to select a different audio language.  This function is only available with files that support multi-track sound.
Information	Displays detailed information about the current file.

Managing recorded files

 > [Featured](#) > [MY CONTENT](#)

Select a USB device containing recordings. A list of recordings appears.

 This function is only available on certain models in specific geographical areas.

Using the functions for the saved file list

- **Filter**

Displays only files that match the selected filter.

- **Sort By**

Sorts files according to the selected viewing mode.

 This function is unavailable if **Filter** is set to **All**.

- **Delete**

Deletes the selected files, except for locked files.

 This function is unavailable if **Filter** is set to **All**.

- **Play Selected**

Plays the selected files. Select files from the file list and then select **Play**.

If the viewing mode is set to **Folder** view, you can select the files included in the same folder only. Change the viewing mode to add a file contained in other folders to the playlist.

 This function is unavailable if **Filter** is set to **All**.

Setting Up a Schedule Viewing

The  appears next to programmes that have been configured for a Schedule Viewing.

 To set up a Schedule Viewing, you must first set the TV's clock ((**MENU/123**) > **MENU** > **System** > **Time** > **Clock**).

Setting up a schedule viewing for a channel

Setting up a schedule viewing for digital channel

You can set up a schedule viewing for a digital channel on the **Guide** or Information screen.

- **The Guide Screen**

On the **Guide** screen, use your remote control to highlight, and then select a programme you would like to view, and then press and hold the Enter button. Select **Schedule Viewing** on the pop-up menu that appears. The programme is scheduled for viewing. The Guide screen re-appears.

- **The Programme Info Screen**

Press the Enter button while you are watching the TV. The programme Info window appears. Press the **<** or **>** button to move to a programme you would like to view, and then press the Enter button. Select  that appears on the programme Info window. The programme is scheduled for viewing.

Setting up a schedule viewing for analogue channel

(**MENU/123**) > **MENU** > **Broadcasting** > **Schedule Manager** 

You can set up a scheduled viewing for an analogue channel. Select **Schedule** > **Schedule Viewing**. Specify the **Source**, **Channel**, **Repeat**, and **Start Time** options for the programme you want to watch, and then select **OK** to finish.

Editing a schedule viewing

(MENU/123) > MENU > Broadcasting > Schedule Manager

On the **Scheduled** screen, select a schedule viewing. A pop-up menu appears. Select **Edit**. Change the time, days, or channel. Select **OK** when done.

Cancelling a schedule viewing

(MENU/123) > MENU > Broadcasting > Schedule Manager

On the **Scheduled** screen, select a schedule viewing. A pop-up menu appears. Select **Delete**. Select **OK** on the pop-up menu. The schedule viewing is removed.

 You can set up a maximum total of 30 **Schedule Viewing** and **Schedule Recording** entries.

Using Timeshift

You can pause and rewind live TV as you would a DVD by using **Timeshift**.

Activating this function disables the **Broadcasting** function.

 Read all precautions before using the Timeshift function. For more information, refer to "Before Using the Recording and Timeshift Functions."

 This function is only available on certain models in specific geographical areas.

To activate the Timeshift function while watching TV, press the Enter button, and then select  on the programme Info window. The TV displays a progress bar and the following buttons at the top of the screen:

- **More Info**

Displays detailed information about the current programme.

 The programme information may differ with the type of incoming signal and may not be available at all for certain programmes.

 This button is only available when you are watching a live programme.

- **Record**

Starts instant recording for the current programme.



- **Go to Live TV / Stop Timeshift**

Shifts to live TV or exits Timeshift.

Using the buttons on the remote control while using Timeshift



- **Pause / Play**

Pauses the screen.

Press the  or  button to pause or resume the current programme while using the Timeshift function. The following functions are available while the current programme is paused. However, there is no audio output while the current programme is paused.



- **Step:** Press the **MENU/123** button on the Samsung Smart Control, and then select the  button to scan through the current programme one frame at a time.

 On the standard remote control, press the  button.

- **Slow Playback:** Press the **MENU/123** button on the Samsung Smart Control, and then select the  or  button to play current programme back at 1/2 the normal speed.

 On the standard remote control, press the  or  button.

- **Rewind / Fast Forward**

Press the **MENU/123** button on the Samsung Smart Control, and then select  or  button to speed up rewind or fast forward to maximum speed in 7 steps.

 On the standard remote control, press the  or  button.



 The Fast Forward function is not available while you are watching a programme that is currently being broadcast.

Using the Channel List

(**MENU/123**) > **MENU** > **Broadcasting** > **Channel List** [Try Now](#)

By using the **Channel List**, you can change the channel or check programmes on other digital channels while watching TV. To display the **Channel List**, place a finger on the **POINTER** button on the Samsung Smart Control, and then select the  icon that appears at the right side of the screen. On the standard remote control, press the **CH.LIST** button.

The **Channel List** screen contains the following icons:

-  : An analogue channel
-  : A favourite channel
-  : A locked channel

Press the  button. The following functions are available:

- **History**

Displays a list of channels that you viewed recently.

- **Add a New List**



Allows you to create a new channel list by adding channels from a favourites list, genre, or your interest category.

 The actual provided list may differ from specific geographical areas.

- **All**

Displays all channels stored in the TV.



- **Options**

Option	Description
Aerial	Allows you to choose between Terrestrial , Cable , and Satellite .  This option is only available on certain models in specific geographical areas.
Sort	Sorts the list by Channel Number or by Name (Digital channels only).
Genre	Sorts the list so that it includes channels of a selected genre only. However, Genre can only be used channels contain the genre information. Check the network and make sure the TV is connected to the Internet. Your TV needs to be connected to the Internet in order to receive the channel's genre information.
Edit Channel Lists	Allows you to rearrange the order of channels in the channel list or remove channels from the channel list.
Edit Channel	Allows you to remove channels from the channel index, restore removed channels, and rename analogue channels.
Edit Favourites	Sets favourite channels.  For more information, refer to "Creating a Personal Favourites List."

Registering, Removing, and Editing Channels

(MENU/123) > MENU > Broadcasting > Edit Channel [Try Now](#) [Try Now](#)

The **Edit Channel** screen icons indicate the following:

- **A** : An analogue channel
-  : A favourite channel
-  : A locked channel

Registering and removing channels

Removing registered channels

You can remove a registered channel or all channels from the channel index. To remove a channel, select it, and then select **Delete**. To remove all channels, select **Options** > **Select All**, and then select **Delete**.

Editing registered channels

You can access the following options by selecting **Options** on the screen. The available options may differ with the broadcast signal.

- **Select All / Deselect All**

Selects or deselects all channels displayed on the **Edit Channel** screen.

- **Sort**

Sort the list ordered by **Number** or **Name**.

 This option is only available for digital channels.

- **Aerial**

Allows you to choose between **Terrestrial**, **Cable** or **Satellite**.

 This function is only available on certain models in specific geographical areas.

- **Category**

Displays the channels of a selected category in the list.

- **Edit Favourites**

Sets favourite channels.



For more information, refer to "Creating a Personal Favourites List."

- **Rename channel**

Renames analogue channels. The new name can be up to 5 characters long.

- **Information**

Displays detailed information about the current programme.

Enabling / Disabling password protection on channels

[\(MENU/123\)](#) > [MENU](#) > [Broadcasting](#) > [Edit Channel](#)

You can enable password protection on the channels that you don't want your children to view.

 Before enabling password protection, ensure that [Channel Lock](#) ([\(MENU/123\)](#) > [MENU](#) > [Broadcasting](#) > [Channel Lock](#)) is set to **On**.

Locking / Unlocking channels

You can lock or unlock channels. Select channels from the [Edit Channel](#) screen and then select **Lock** or **Unlock** at the bottom of the screen. When the password entry window appears, enter the password.

Changing channel numbers

[\(MENU/123\)](#) > [MENU](#) > [Broadcasting](#) > [Edit Channel Number](#)

You can change the channel numbers. Set [Edit Channel Number](#) to **Enable**.



This function is only available on certain models in specific geographical areas.



When a channel number is changed, its channel information is not updated automatically.

Creating a Personal Favourites List

Favourite channels are highlighted in the [Edit Channel](#) and [Channel List](#) screens with the  symbol. You can create up to 5 favourite channel lists.

Registering channels as favourites

[\(MENU/123\)](#) > [MENU](#) > [Broadcasting](#) > [Edit Favourites](#)

You can register multiple channels as favourites at the same time.

1. Select the channels that you want to add to your favourites list(s) from the list in the screen.
2. Select [Change Fav.](#) on the screen to select a favourites list.
3. Select [Add](#) on the screen. The TV adds the channels you selected to the favourites list you chose.

Viewing and selecting channels on Favourites lists only

[\(MENU/123\)](#) > [MENU](#) > [Broadcasting](#) > [Channel List](#)

You can flip through only the favourite list channels and select a channel using the channel up/down buttons.

1. Press the  button. A favourites list appears.
2. Highlight a channel from the selected favourites list using the channel up/down buttons, and then select it. The channel changes.

 A favourites list can be selected only if it contains at least one favourite channel.

Editing a Favourites List

(MENU/123) > MENU > Broadcasting > Edit Favourites [Try Now](#) [Try Now](#)

Using the Edit Favourites screen menu items

You can access the following options by selecting **Options** on the **Edit Favourites** screen.

- **Select All / Deselect All**

Selects or deselects all channels saved on the TV.

- **Copy to Favourites**

Copies channels from one favourite channels list to another.



For more information, refer to "Copying channels from one favourites list to another."



This option is available only if you have registered one or more channels to at least one favourites list.

- **Rename Favourites**

Rename an existing favourite channels list.



For more information, refer to "Renaming a favourites list."



This option is available only if you have registered one or more channels to at least one favourites list.

- **Sort**

Sort the list ordered by **Number** or **Name**.



This option is only available for digital channels.

- **Aerial**

Allows you to choose between **Terrestrial**, **Cable** or **Satellite**.



This function is only available on certain models in specific geographical areas.

- **Edit Channel**

Allows you to manage the channels saved on the TV.



For more information, refer to "Registering, Removing, and Editing Channels."

Removing registered channels from a favourites list

Select **Edit Favourites** > **Change Fav.** to move to the favourites list that has the channels you want to remove. Select the channels, and then select **Delete**.

Rearranging a favourites list

Select **Edit Favourites** > **Change Fav.** to move to the favourites list that has the channels you want to rearrange. Select the channels, and then select **Change order**. The Change order highlight appears. Press the up/down arrow buttons to indicate the new location for the channels. Press the Enter button to set the channels into their new location.

Renaming a favourites list

Select **Edit Favourites** > **Options** > **Rename Favourites**. Select the favourites list you want to rename. Enter a new name using the on-screen keyboard that appears, and then select **Done**. Select **OK**.

Copying channels from one favourites list to another



Select **Edit Favourites** > **Change Fav.** to move to the source favourites list, and then select the channels to copy. Select **Options** > **Copy to Favourites**. Select the destination favourites list, and then select **OK**. Select **OK** again.

 **Copy to Favourites** is only available if there are channels in at least one favourites list.

Making Sports programmes More Realistic with Sports Mode

(MENU/123) > MENU > System > Sports Mode [Try Now](#)

You can use **Sports Mode** to get optimal picture and sound settings for sports events, making them appear and sound as if you are there. In addition, if a recording device is connected to the TV when you are using **Sports Mode**, you can use both the video recording and timeshift functions at the same time while watching the sports game, as well as watching the highlights extracted from the recorded sports game automatically or manually.

-  This function is only available on certain models in specific geographical areas.
-  For more information about recording a programme and using a recording device, refer to "Recording Programmes."
-  For more information about the Timeshift function, refer to "Using Timeshift."

Enabling sports mode

(MENU/123) > MENU > System > Sports Mode > Sports Mode



You can set **Sports Mode** to **On** to make the picture and sound modes of the TV optimised automatically for sports events.

-  Enabling **Sports Mode** changes **Picture Mode** to **Stadium** and **Sound Mode** to **Stadium**, and disables some **Picture** and **Sound** menus.

Choosing sports type

(MENU/123) > MENU > System > Sports Mode > Sports Type

You can enjoy optimal picture and sound settings for a selected sports type.

-  This function is only available on certain models in specific geographical areas.
-  The number of options available in **Sports Type** differ with the geographical area.

Extracting highlights automatically

(MENU/123) > MENU > System > Sports Mode > Auto Highlights [Try Now](#)

You can set **Auto Highlights** to **On** to configure the TV to extract highlights of a sports match automatically.

However, **Auto Highlights** is not available with these TV operations:

- Switching the input signal using the **SOURCE** button.
- When **Audio Description** is on
- When 2 Tuner models record 2 channels simultaneously
- When you are viewing the content in **MY CONTENT**
- When the **Screen Mirroring** function is running

 The performance of **Auto Highlights** depends on the characteristics of the transmitted signal.





 This function is only available on certain models in specific geographical areas.

 It is advisable to use **Auto Highlights** only while watching a football game. If you use this function for other sporting events, it may display irrelevant picture frames.

Using the functions available while watching sports in sports mode

You can use the following functions when you press the Enter button in sports mode.

- **Zoom**

Pauses the current screen and zooms in any part of the screen by using the , ,  and  buttons.



 To launch this function easily, select or press the **A** button.

 This function is not available when **PIP** or **MY CONTENT** is active.

 This function is not available when **Data Service** is active.

- **Manual Highlight**

Saves a video from 10 seconds before pressing this button to 10 seconds after.

-  To launch this function easily, select or press the **B** button.
-  This function is only available when a recording is in progress.
-  You can set the TV to automatically save highlights without user intervention. Select **(MENU/123) > MENU > System > Sports Mode**, and then set **Auto Highlights** to **On**.

- **Recording Time**

Sets the recording time.

-  This function is only available when a recording is in progress.

- **Stop Recording / Go to Live TV**

- Stops a recording when you are watching a live programme.
- Switches to a live programme when you are watching a recorded programme.

-  This function is only available when a recording is in progress.



- **Record**

Instantly records the game that you are currently watching on the TV.

-  This function is only available when the recording function is supported.

- **Rewind / Fast Forward**

Press the **MENU/123** button on the Samsung Smart Control, and then select **◀◀** or **▶▶** button to speed up rewind or fast forward to maximum speed in 7 steps.

-  On the standard remote control, press the **◀◀** or **▶▶** button.
-  The Fast Forward function is not available while you are watching a programme that is currently being broadcast.

- **Pause / Play**

Pauses or resumes the video.

-  This function is only available when a recording is in progress.

- **Highlights Player**

Displays the **Highlights Player** screen and plays automatically or manually the saved highlights in the recorded file. However, **Highlights Player** is not available with these TV operations:

- Switching the input signal using the **SOURCE** button.
- When **Audio Description** is on
- When 2 Tuner models record 2 channels simultaneously

 This function is only available when a recording is in progress.

- **Watch Live TV at the same time**

Allows you to watch a current programme in a PIP window while watching a recorded programme. To exit PIP mode, press the button again. However, **Watch Live TV at the same time** is not available with these TV operations:

- Switching the input signal using the **SOURCE** button.
- When **Audio Description** is on
- When 2 Tuner models record 2 channels simultaneously

 This function is only available when a recording is in progress.

 This function is only available while you are watching a recorded programme.

- **More Info**

Displays detailed information about the current programme.

 This function is only available while you are watching a live programme.

Viewing a game recorded in sports mode

You can view a recorded game using **Recorded TV** on the **MY CONTENT** screen.

 This function is only available on certain models in specific geographical areas.

 For more information, refer to "Viewing recorded programmes."

Watching a Movie with Optimised Picture and Sound - African Cinema Mode

(**MENU/123**) > **MENU** > **System** > **African Cinema Mode**

When you set **African Cinema Mode** to **On**, the TV provides an optimal picture and sound for popular content. You can also optimise your TV's picture size or position by Custom mode. To change a picture size or position, press the **MENU/123** button on the Samsung Smart Control, and then select the **A** button on the On-Screen Remote. On the standard remote control, press the **A** button.



 This function is only available on certain models in specific geographical areas.

TV-Viewing Support Features

Reading digital text

(MENU/123) > MENU > Broadcasting > Channel Settings > Digital Text



You can use this function when you watch a broadcast that includes both text and multimedia content.

-  This function is only available in UK.
-  Multimedia and Hypermedia Information Coding Experts Group (MHEG) is an International standard for data encoding systems used in multimedia and hypermedia. This is at a higher level than the MPEG system which includes data-linking hypermedia such as still images, character service, animation, graphic and video files as well as multimedia data. MHEG is user runtime interaction technology and is being applied to various fields including Video-On-Demand (VOD), Interactive TV (ITV), Electronic Commerce (EC), tele education, teleconferencing, digital libraries and network games.

Scanning for available channels

(MENU/123) > MENU > Broadcasting > Auto Tuning > Auto Tuning Try Now Try Now



You can make the TV automatically scan and index all channels received through the TV's antenna input connector. Select **Start**.

-  This function is only available on certain models in specific geographical areas.
-  If the TV is connected to a cable box or satellite receiver, you do not need to do this.
-  DVB-T2 system may not be available in specific geographical areas.

Selecting aerial connection type

(MENU/123) > MENU > Broadcasting > Aerial Connection Type

You can watch TV broadcasts in a suitable aerial connection type. Select **Single Oscillator** or **Dual Oscillator**.

-  This function is available when **Aerial** is set to **Satellite**.
-  This function is only available on certain models in specific geographical areas.

Selecting the broadcast audio language

(MENU/123) > MENU > Broadcasting > Audio Options [Try Now](#)

You can select an audio option suitable for the broadcast content.

- **Audio Language**

Changes the default audio languages.

- **Primary Audio:** Sets the primary audio language.
- **Secondary Audio:** Sets the secondary audio language.

 The available language may differ with the broadcast.

- **Audio Format**

Changes the audio format.

 The supported audio format may differ with the broadcast programme.

 This option is only available on digital channels.

Audio Description

(MENU/123) > MENU > System > Accessibility > Audio Description

You can use the Audio Stream for the Audio Description (AD) which is sent along with the Main audio from the broadcaster. Adjust the audio description volume using **Volume**.

 This function is only available on digital channels.

- **Audio Description**

Turns the audio description function on or off.

- **Volume**

Adjusts the audio description volume.

Genre Selection

(MENU/123) > MENU > Broadcasting > Genre Selection

You can turn the channel genre selection feature on or off when you run Guide.

 This function is only available on certain models in specific geographical areas.

Using adult genre

(MENU/123) > MENU > Broadcasting > Adult genre enabling

You can enable or disable all adult services. When disabled, adult services will not be available.

 This function is only available on certain models in specific geographical areas.

Using the Channel Settings Try Now

Setting the country (area)

(MENU/123) > MENU > Broadcasting > Channel Settings > Country (Area)

You can select your country so that the TV can correctly auto-tune the broadcasting channels.

1. Enter your PIN number.
2. Change your area. To change the country for digital channels, select **Digital Channel**. To change the country of analogue channels, select **Analogue Channel**.

 This function is not available in all geographical areas.

 The list of countries (areas) displayed on the TV's screen may differ with the geographical area.

Tuning broadcast signals manually Try Now

(MENU/123) > MENU > Broadcasting > Channel Settings > Manual Tuning

You can scan for all the channels manually and store the scanned channels in the TV. To stop scanning, select **Stop**.

 This function is only available on certain models in specific geographical areas.

 This function is only available when **Aerial** is set to **Terrestrial** or **Cable**.

Tuning digital channels

(MENU/123) > MENU > Broadcasting > Channel Settings > Manual Tuning > Digital Channel Tuning

Select **New** > **Search** to scan for digital channels automatically and store the scanned channel list in the TV.

Tuning analogue channels

(MENU/123) > MENU > Broadcasting > Channel Settings > Manual Tuning > Analogue Channel Tuning

Select **New** and configure **Programme**, **Colour System**, **Sound System**, **Channel**, and **Search** to scan for analogue channels. Then, select **Store** to store the scanned channels in the TV.

 This function is only available for analogue broadcasts.

Fine-Tuning the screen Try Now

(MENU/123) > MENU > Broadcasting > Channel Settings > Fine Tune

When analogue pictures become shaky and full of noise, fine-tune the signal to clear up the picture.

 This function is only available for analogue broadcasts.

Transferring channel list

(MENU/123) > MENU > Broadcasting > Channel Settings > Transfer Channel List

You can import or export the channel list to a USB storage.

- **Import from USB:** Imports channel list from a USB storage.
- **Export to USB:** Exports channel list saved in the TV to a USB storage.

 This function is available when USB is connected.

Deleting CAM operator profile

(MENU/123) > MENU > Broadcasting > Channel Settings > Delete CAM Operator Profile

You can delete the CAM operator.

 This function is only available on certain models in specific geographical areas.

Setting satellite system

(MENU/123) > MENU > Broadcasting > Channel Settings > Satellite System

You can configure a set of satellite dish settings before performing a channel scan.

 This function is only available on certain models in specific geographical areas.

Changing teletext language

(MENU/123) > MENU > Broadcasting > Channel Settings > Teletext Language

You can set or change the teletext language. To watch the teletext broadcast in your preferred language, select a language to use in **Primary teletext**. If this language is not supported, you can watch the teletext broadcast in your secondary preferred language set in **Secondary teletext**.

 This function is only available on certain models in specific geographical areas.

Showing common interface menu

(MENU/123) > MENU > Broadcasting > Common Interface

You can view information about common interfaces.

- **CI Menu**

Enables the user to select from the CAM-provided menu. Select the CI menu based on the menu PC Card.

- **CAM video transcoding**

Configures the setting to transcode the video codec from the CAM automatically. Turn it Off if you do not want to use it.

 You must use a CAM that supports video codec transcoding.

- **Application Info**

Displays information about the CAM inserted into the CI slot and about the “CI or CI+ CARD” inserted into the CAM. You can install the CAM any time, with or without the TV turned on.

- **CICAM PIN Manager**

Manages Common Interface Common Access Module (CICAM) PIN. Save PIN or change stored PIN and then set other PIN options.

Adjusting the Picture Quality

Choosing a picture mode

(MENU/123) > MENU > Picture > Picture Mode [Try Now](#)

You can select the picture mode that provides the best viewing experience.

- **Dynamic**
Makes the picture clearer when the ambient lighting is so bright that it makes the picture difficult to see.
- **Standard**
Is the default mode suitable for most environments.
- **Natural**
Reduces eye strain.
- **Movie**
Darkens the screen, reduces glare, and relieves eye fatigue. Use this mode while viewing the TV in a darkened room or watching a movie.
- **Entertain**
Sharpens images for a more dynamic viewing experience.
- **Stadium**
When you turn **Sports Mode** ((MENU/123) > MENU > System > Sports Mode) to **On**, **Picture Mode** is set to **Stadium** automatically to configure the picture settings suitable to sports events.

 When the Input source is set to PC, **Standard** and **Entertain** modes are only available.

 When a PC is connected to the TV, but the **Entertain** mode is not available, set **Edit Device Type** to **DVI PC** or **PC**.

Adjusting the picture quality

(MENU/123) > MENU > Picture

You can adjust the following picture quality settings manually for each combination of an input source and picture mode.

- **Backlight** [Try Now](#)

Adjusts the brightness of individual pixels. Decrease this brightness to reduce power consumption.

- **Contrast** [Try Now](#)

Adjusts the screen contrast.

- **Brightness** [Try Now](#)

Adjusts the overall brightness.

- **Sharpness** [Try Now](#)

Sharpens or dulls the edges of objects.

- **Colour** [Try Now](#)

Adjusts the overall colour saturation.

- **Tint (G/R)** [Try Now](#)

Adjusts the ratio of green to red. Increase the green value to saturate the greens and the red value to saturate the reds.

 The TV saves the adjusted values for the current input source and picture mode and applies these values each time you select the same input source and picture mode.

 The **Colour** and **Tint (G/R)** settings cannot be adjusted when the TV is connected to a computer via an HDMI-to-DVI cable.

Applying the current picture settings to other input sources

(MENU/123) > MENU > Picture > **Apply Picture Mode** [Try Now](#)

You can apply the picture quality settings to the current source and other input sources.

- **All Sources**

Applies the settings to all external devices connected to the TV.

- **Current Source**

Applies the settings to the current source only.

Adjusting advanced settings

(MENU/123) > MENU > Picture > Advanced Settings [Try Now](#)

You can fine-tune how images are displayed on the TV screen for the Standard and Movie picture modes.

- **Dynamic Contrast** [Try Now](#)

Automatically adjusts the screen contrast for an optimal contrast setting.

- **Black Tone** [Try Now](#)

Adjusts the black colour depth.

- **Flesh Tone** [Try Now](#)

Darkens or lightens skin tones.

- **RGB Only Mode** [Try Now](#)

Adjusts the red, green, and blue levels individually.

- **Colour Space** [Try Now](#)

Adjusts the range of colour that can be displayed on the screen.

- **Auto**: Automatically adjusts the colour space to match the input signal.
- **Native**: Applies a range of colours that is wider than the input signal.
- **Custom**: Allows you to adjust the colour space manually. Select a colour, and then change its **Red**, **Green**, and **Blue** saturations. **Reset** allows you to restore the default values for **Colour Space**.



You can configure the **Colour** function only when **Colour Space** is set to **Custom**.

- **White Balance** [Try Now](#)

Adjusts the colour temperature of the picture to make white objects look white and the overall picture appear natural.

- **2 Point**: Allows you to adjust red, green, and blue luminosity with the offset menu and brightness with the gain menu. Reset allows you to restore the default values.
- **10 Point**: Divides red, green, and blue into 10 sections each, and allows you to modify the white balance by adjusting the brightness of each section. Level allows you to select the section to adjust.



You can use the **10 Point** function only when **Picture Mode** is set to **Movie**. This function may not be supported by some external devices.

- **Gamma** [Try Now](#)

Adjusts the primary colour intensity.



Advanced Settings is only available when **Picture Mode** is set to **Standard** or **Movie**.



White Balance and **Gamma** are only available when the TV is connected to a computer with an HDMI-to-DVI cable.

Adjusting picture options

(MENU/123) > MENU > Picture > Picture Options [Try Now](#)

You can adjust the picture options to optimise your viewing experience. Select a picture mode and then adjust the picture options.

- **Colour Tone** [Try Now](#)

Adjusts the colour tone. The colour tone you select is stored in the TV's memory. When you change the current picture mode, the stored colour tone is applied to the new picture mode automatically.

 **Cool** and **Standard** are only available when **Picture Mode** is set to **Dynamic**.

 **Colour Tone** is only available when the TV is connected to a computer via an HDMI-to-DVI cable.

- **Digital Clean View** [Try Now](#)

Reduces static and ghosting caused by a weak signal. When you select **Auto Visualisation**, it displays the signal strength on the bottom of the screen. Green indicates the best possible signal.

 This function is available for analogue channels only.

- **MPEG Noise Filter** [Try Now](#)

Reduces MPEG noise and improves video quality.

- **HDMI Black Level** [Try Now](#)

Compensates for effects caused by a low black level, such as low contrasts and dull colours.

 This function is only available when the input signal, connected to the TV via an HDMI connector, is set to RGB444.

- **Film Mode** [Try Now](#)

Optimises the picture quality for movies.

 This function is only available when the input signal is TV, AV, Component (480i, 1080i), or HDMI (1080i).

- **LED Clear Motion**

Removes drag from fast scenes with a lot of movement to provide a clear picture.

 When **LED Clear Motion** is **On**, the screen appears darker than when it is **Off**.

 If **LED Clear Motion** is **On** at 60Hz video signal, the screen may flicker.

- **Analogue Clean View**

Reduces noise in the form of a diagonal line that occurs due to interferences between signals.

 This function is only supported for analogue broadcasts.

Picture Support Functions

Viewing a picture-in-picture (PIP)

(MENU/123) > MENU > Picture > PIP [Try Now](#)

While viewing video from an external device such as a Blu-ray player on the main screen, you can view a TV broadcast in a picture-in-picture (PIP) window.

- **PIP**
Activates/deactivates PIP.
- **Aerial**
Selects the input source for the PIP window.
- **Channel**
Selects the PIP channel.
- **Size**
Sets the PIP window size.
- **Position**
Sets the PIP window position.
- **Sound Select**
Selects the audio source.

 PIP cannot be used while **Smart Hub** is active.

 Playing a game or using the karaoke function on the main screen can result in lower PIP picture quality.

 The PIP function is only available under the following conditions: 1) The main screen's source is a Component or HDMI connection, 2) The input resolution is less than FHD (Full HD).

 The PIP window supports digital channels only.

Changing the picture size and position Try Now

Changing the picture size

(MENU/123) > MENU > Picture > Picture Size > Picture Size Try Now

You can change the size of the picture displayed on the TV screen.

- **16:9**
Sets the picture size to the 16:9 wide screen format.
- **Zoom**
Magnifies 16:9 pictures vertically. A magnified picture can be moved up and down.
- **Custom**
Magnifies or shrinks 16:9 pictures vertically and/or horizontally. A magnified or shrunk picture can be moved left, right, up, and down.
- **4:3**
Sets the picture size to the basic 4:3 mode.

⚠ Do not watch TV in 4:3 mode for an extended period of time. This action may cause black bars to appear and rest for a while at the top, bottom, left, and right sides of the screen. Note that this information is not presented on the Warranty.

 Supported picture sizes differ with the input signal. For more information about supported picture sizes, refer to "Picture sizes and input signals."

Changing the picture size automatically

(MENU/123) > MENU > Picture > Picture Size > Auto Wide

When set to On, Your TV will automatically use the picture size recommended by the programme provider.

Changing the picture size in 4:3 or Screen Fit mode

(MENU/123) > MENU > Picture > Picture Size > 4:3 Screen Size

You can select a picture size suitable for your geographical area while you are watching TV in the **4:3** or **Fit to screen** mode. The supported screen sizes differ with the country and this function allows you to adjust the picture size in this case.

 The **4:3** mode is not available when an external device is connected to the TV via a Component connector or an HDMI connector.

Fitting the picture to the screen

(MENU/123) > MENU > Picture > Picture Size > Fit to screen

You can configure the TV so that the full picture fits the screen without any cutoff in the size you have chosen.

 This function is not available when you set the **Picture Size** to the **4:3** mode.

Adjusting the picture position

(MENU/123) > MENU > Picture > Picture Size > Zoom/Position Try Now

Magnifies or shrinks 16:9 pictures vertically and/or horizontally. A magnified or shrunk picture can be moved left, right, up, and down.

 This function is only available when **Picture Size** is set to **Zoom** or **Custom**. However, you cannot change the picture position when the TV is tuned to a digital channel and **Picture Size** is set to **Custom**.

Listening to audio only (Picture Off)

(MENU/123) > MENU > Picture > Picture Off Try Now

You can turn off the screen and play only the audio through the speakers. To turn the screen back on, press any button other than the Power and Volume buttons.

Resetting the picture mode settings

(MENU/123) > MENU > Picture > Reset Picture Try Now

You can reset the current picture mode to its factory defaults. This action does not affect the settings of other picture modes.

Adjusting the Sound Quality

Choosing a sound mode

(MENU/123) > MENU > Sound > Sound Mode [Try Now](#)

You can select a sound mode to optimise your listening experience.

- **Standard**
Is the default mode suitable for most environments.
- **Music**
Emphasises music instead of voices.
- **Movie**
Provides the best sound for movies.
- **Clear Voice**
Emphasises voices.
- **Amplify**
Increases the overall intensity of high-frequency sound to help hearing-impaired listeners.
- **Stadium**
When you turn **Sports Mode** ((MENU/123) > MENU > System > Sports Mode) to **On**, **Sound Mode** is set to **Stadium** automatically so that the sound settings are fixed at settings most suitable for sporting events.

 This mode is set automatically by the TV. You cannot set this mode manually.

 This function is not available when you are listening to audio through external speakers.

Applying sound effects

(MENU/123) > MENU > Sound > Sound Effect [Try Now](#)

You can apply sound effects to alter how the TV emits sound.

- **Virtual Surround** [Try Now](#)

Produces sound that makes you feel like you are sitting in a movie theatre or concert hall.

- **Dialog Clarity** [Try Now](#)

Increases voice intensity to make dialog clearer.

- **Balance** [Try Now](#)

Allows you to adjust the sound settings of the left and right speakers for a better sound balance. To restore the defaults, select **Reset**.

- **Equaliser** [Try Now](#)

Allows you to adjust the loudness of specific frequency ranges to control the richness of the sound. To restore the defaults, select **Reset**.



This function is not available when you are listening to audio through external speakers.



This function is only available when **Sound Mode** is set to **Standard**.

Using the Sound Support Functions

Selecting speakers

(MENU/123) > MENU > Sound > Speaker Settings > Speaker Select [Try Now](#)

You can select which speakers the TV uses for audio output.

-  When **Speaker Select** is set so that sound comes from external speakers only, Volume and Mute buttons and some Sound functions are disabled.

Specifying the TV's installation type

(MENU/123) > MENU > Sound > Speaker Settings > TV Installation Type

You can specify the TV's installation type, either **Wall Mount** or **Stand**, to optimise the TV's sound automatically.

Listening to TV sound through a Samsung Bluetooth audio device

(MENU/123) > MENU > Sound > Speaker Settings > TV SoundConnect

You can connect Samsung Bluetooth audio devices to the TV. They must be paired using the TV's Bluetooth function. For more information on pairing, refer to the Samsung Bluetooth audio device's operating manual.

- **Add New Device**

Adds a new device to the list of paired devices. If **Add New Device** is set to **Off**, the connection signals from new devices are ignored.

- **Samsung Audio Device List**

Displays a list of paired Samsung audio devices. Select a device to display its menu options. You can activate/deactivate the audio device or remove it from the list.

-  This function is not available on certain models in specific geographical areas.

-  This function is only available for Samsung audio devices that support **TV SoundConnect**.

-  **TV SoundConnect**, **Surround**, and Bluetooth headphones can't be used simultaneously.

-  Before using a Bluetooth device, refer to "Read Before Using Bluetooth Devices."

Listening to the TV through Bluetooth headphones

(MENU/123) > MENU > Sound > Speaker Settings > Bluetooth Headphones

You can connect Bluetooth headphones to the TV. They must be paired using the TV's Bluetooth function. For more information on pairing, refer to the Bluetooth headphone's operating manual.

- **Bluetooth headphone List**

Displays a list of Bluetooth headphones that can be paired with the TV. Select a Bluetooth headphone to display its menu options. From this menu, you can activate/deactivate (i.e., pair/unpair) the Bluetooth headphone or remove it from the list.



If the TV fails to find a headphone, place the headphone closer to the TV, and then select **Refresh**.



When you turn on a paired Bluetooth headphone, the TV detects it automatically, and then displays a pop-up window. Use this pop-up window to activate/deactivate the Bluetooth headphone.

- **Multi-output Audio**

Allows you to listen to audio through the TV's speakers and the connected Bluetooth headphones simultaneously.



This function is not available on certain models in specific geographical areas.



Before using a Bluetooth device, refer to "Read Before Using Bluetooth Devices."

Listening to TV sound through a Samsung Multiroom Link compatible speaker

(MENU/123) > MENU > Sound > Speaker Settings > Multiroom Link > Multiroom Link Settings

You can connect a Samsung Multiroom Link compatible speaker to the TV to enjoy a richer sound.

- **Settings**

Sets the Samsung Multiroom Link compatible speaker(s) to one of the following options.

- **Surround**

Select this option when you want to enjoy a surround system using multiple Samsung Multiroom Link compatible speakers in a single space or room.

- **SoundBar+Surround**

Select this option when you want to enjoy a surround sound system by connecting a soundbar and two speakers to the TV in one space or room.

- **Volume Level**







Adjusts the volume of the speakers selected in the list.

- **Speaker Test**

Sends a test sound to each speaker to make sure that your Multiroom Link system works properly.

- **Edit Name**

Allows you to give a name to each speaker.

-  The **Multiroom Link** function is only available when at least one Samsung Multiroom Link compatible speaker is connected to the TV.
-  The **Multiroom Link** function is deactivated when you activate **Screen Mirroring**.
-  The networked speakers may disconnect on their own, depending on your network environment.
-  The sound quality may be affected by the condition of your wireless network.
-  Audio and video may become out of sync depending on your TV model.
-  The audio from the secondary device(s) may lag behind the audio and video of the main device which is playing the source content.
-  For more information, refer to the Multiroom Link manual on the Samsung web site. (www.samsung.com > OWNERS & SUPPORT > Manuals & Downloads)

Enabling digital audio output

(MENU/123) > MENU > Sound > Additional Settings [Try Now](#)

Since this Smart TV is Sony/Philips Digital Interface Format (S/PDIF)-enabled, you can make the TV provide digital audio output to various digital audio devices, such as speakers, A/V receivers, and home theatres, by adjusting the following settings.

- **DTV Audio Level** [Try Now](#)

Allows you to adjust the volume when you are viewing digital broadcasts on the TV through an A/V receiver.

 This function is only available on digital channels.

 The volume can be adjusted between 0 db and 10 db. However, this volume range may differ with the broadcast signal.

 For the MPEG / HE-AAC broadcast signal, the volume can be adjusted between 0 db and 10 db.

- **HDMI Audio Format**

Sets the audio input signal format suitable for the external device connected to the TV's HDMI port.

- **Audio Format** [Try Now](#)

Selects the digital audio output (S/PDIF) format. The available formats are dependent on the input source.

- **Audio Delay** [Try Now](#)

Helps correct timing mismatches between the audio and video tracks when you are watching TV and listening to audio through a digital audio device. You can adjust the delay by up to 250 ms.

- **Dolby Digital Comp** [Try Now](#)

Sets the Dolby Digital compression mode.

- **HD Audio**

Provides the TV sound resampled at HD audio quality.



Standard audio signals are sampled at 48 kHz while HD audio signals are sampled at 96 kHz.



Some S/PDIF receivers may not be compatible. For incompatible receivers, deactivate this mode and use normal audio mode instead.



The HD audio signals available on the TV are not available on external audio players connected via HDMI, Bluetooth, or Wi-Fi networks.

- **Auto Volume** [Try Now](#)

Automatically adjusts the TV's volume level when you change channels, video sources or content so that the volume level remains the same for all sources. **Auto Volume** can modify the volume up to 12 dB to equalise the sound. **Normal** can applies a normal level of volume adjustment, and **Night** can applies a slightly lower volume level. This option is ideal for late-night TV viewing.



If you want to use the volume control of a connected source device to control the sound, deactivate **Auto Volume**. When you use **Auto Volume** with a source device, the device's volume control may not function properly.

Resetting all sound settings

(MENU/123) > MENU > Sound > Reset Sound [Try Now](#)

Resets all sound settings to the factory defaults.

Setting the Time and Using the Timer

Setting the current time

(MENU/123) > MENU > System > Time > Clock [Try Now](#)

You can set the clock manually or automatically.

To view the time after the clock is set:

- Samsung Smart Control: Press the **MENU/123** button, and then select **Info** on the On-Screen Remote.
- Standard remote control: Press the **INFO** button.

 The clock must be reset every time the power is disconnected.

Setting the clock using digital broadcast info

(MENU/123) > MENU > System > Time > Clock > Clock Mode [Try Now](#)

You can make the TV automatically download time information from a digital channel and set the current time. To activate this function, set **Clock Mode** to **Auto**. If the TV is connected to a set-top box or satellite box using HDMI or Component connectors, you must set the current time manually.

 This function works only when the TV's antenna jack is connected to either an antenna or a cable output and is receiving digital broadcasts.

 The accuracy of the time information received may differ with the channel and signal.

Setting the clock manually

(MENU/123) > MENU > System > Time > Clock > Clock Set [Try Now](#)

You can set the clock manually. Set **Clock Mode** to **Manual**, and then input present date and time in date and time field.

Setting the clock automatically

(MENU/123) > MENU > System > Time > Clock > Time Zone

Sets the right time by setting Daylight Savings Time (DST) and your local time zone.

 This function is only available when the **Clock Mode** is set to **Auto**.

- **DST**

Switches the Daylight Saving Time (DST) function on or off.

 This function is only available when the **Clock Mode** is set to **Auto**.

- **GMT**

Selects your time zone.

 When **Country** is set to others, you can use this function.

If the clock is wrong in auto mode...

(MENU/123) > MENU > System > Time > Clock > Time Offset [Try Now](#)

You can offset the clock in 1-hour increments by as much as -/+ 12 hours if the TV fails to display the correct automatically-set time, for whatever reason.

 **Time Offset** adjusts the time through a network connection. This function is only available if **Clock Mode** is set to **Auto** and the TV is connected to the Internet through a local area network.

 **Time Offset** adjusts the time if the TV fails to receive time information through normal digital broadcast signals.

Using the timers

Using the sleep timer

(MENU/123) > MENU > System > Time > Sleep Timer [Try Now](#)

You can use this function to automatically shut off the TV after a pre-configured period of time. You can set the timer for 30 minute increments, for up to 3 hours.

Turning on the TV using the on timer

(MENU/123) > MENU > System > Time > On Timer [Try Now](#)

You can set **On Timer** to make the TV turn on automatically at a specific time. You can use up to three separate configurations: **On Timer 1**, **2**, and **3**. **On Timer** is only available when **Clock** has already been set.

- **Setup**

If you select **Manual**, you can highlight and select each day to select the specific days that you want **On Timer** to turn on the TV.

- **Time**

- **Volume**

- **Source**

From the list, select a signal source for the TV to use when it turns on. If you want to play content saved in a USB device or content from an HDMI or Component source, such as a DVD player, Blu-ray player, or set-top box, connect the device to the TV before you start On Timer setup. Then, do not disconnect the device from the TV.

- **Aerial**







Allows you to select a broadcast signal source, when **Source** is set to **TV**.

- **Channel**

Allows you to select a channel, when **Source** is set to **TV**.

- **Music / Photo**

Allows you to specify a USB device folder containing music files in the music field and/or a folder containing photos in the photo field, when **Source** is set to **USB**. If you select both a folder that contains music files and a folder that contains photo files, the TV plays the music files and displays the photos at the same time.

-  If the folder that you choose has sub-folders, you can select a sub-folder in the same fashion.
-  This function does not work properly if the selected USB device does not contain media contents or a folder has not been specified.
-  No slideshow starts if there is only one image file on the USB device.
-  Folders with long names cannot be selected.
-  Make sure to use different folder names for multiple USB devices.
-  Use a USB memory stick or multi-card reader. **On Timer** may not work with certain battery-powered USB devices, MP3 players, or PMPs because the TV may take too long to recognise the device.

Turning off the TV using the off timer

(MENU/123) > MENU > System > Time > Off Timer [Try Now](#)

You can set **Off Timer** to turn off the TV automatically at a specified time. You can set up three separate configurations: **Off Timer 1**, **2** and **3**. **Off Timer** is only available when **Clock** has already been set.

- **Setup**

Sets days of the week that the TV is turned off automatically. If you select **Manual**, you can highlight and select each specific day.

- **Time**

Sets the time for the TV to turn off automatically.

Using the Screen Burn Protection and Energy Saving Functions

Preventing screen burn

(MENU/123) > MENU > System > Auto Protection Time [Try Now](#)

You can use the Screen Burn Protection function to protect the screen. Still images can leave burn-in after-images if left on the screen for a long period of time. Select a time setting from the list. If a still image is shown on the screen for longer than the time that you selected, the TV automatically activates the Screen Burn Protection function.

Reducing the energy consumption of the TV

(MENU/123) > MENU > System > Eco Solution [Try Now](#)

You can adjust the brightness level of the TV and prevent overheating to reduce overall power consumption.

- **Energy Saving** [Try Now](#)

Allows you to select a brightness setting from the list to reduce the TV's power consumption.

- **Eco Sensor** [Try Now](#)

Automatically adjusts the brightness level of the TV, according to the ambient light level, to reduce power consumption. If the Eco Sensor has adjusted the screen's brightness level, you can select the **Min. Backlight** to manually adjust the minimum screen brightness.

 When the **Eco Sensor** is set to **On**, the screen is darker than usual.

- **No Signal Power Off** [Try Now](#)

Allows you to select a time from the list. If no signal has been received for a specified duration, the TV automatically cuts off the power to reduce power consumption.

- **Auto Power Off** [Try Now](#)

Automatically turns off the TV to prevent overheating when the TV remains on for the specified period of time without any user input.

- **Motion Lighting** [Try Now](#)

Adjusts the brightness in response to on-screen movements to reduce power consumption.

 This function is only available when **Picture Mode** is set to **Standard**.

 This function is deactivated when you adjust a picture quality setting, such as **Contrast** and **Brightness**.

Using Anynet+ (HDMI-CEC)

You can use the TV's remote control to control external devices that are connected to the TV by an HDMI cable and that support Anynet+ (HDMI-CEC). Note that Anynet+ (HDMI-CEC) can only be set by using the remote control.

Setting up Anynet+ (HDMI-CEC)

(MENU/123) > MENU > System > Anynet+ (HDMI-CEC) [Try Now](#)

- [Anynet+ \(HDMI-CEC\)](#) [Try Now](#)

You can enable or disable Anynet+ (HDMI-CEC). Set to **Off** or **On** to disable or enable all Anynet+ related functions.

- [Auto Turn Off](#) [Try Now](#)

When set to **Yes**, turns off Anynet+ compatible external devices when the TV is turned off.



This function is not supported by some Anynet+ compatible devices.

- [Search for Devices](#) [Try Now](#)

Automatically searches for and identifies Anynet+ (HDMI-CEC) compatible external devices that are connected to the TV.

Using Anynet+ (HDMI-CEC)

Selecting an external device

After connecting external devices to the TV, select (MENU/123) > MENU > System > Anynet+ (HDMI-CEC) > Search for Devices. The TV displays a list of Anynet+ (HDMI-CEC)-compliant devices that you can set up as Anynet+ (HDMI-CEC)-enabled devices (i.e., devices that can be controlled with the TV's remote control). To set up an Anynet+ (HDMI-CEC)-compliant device as an Anynet+ (HDMI-CEC)-enabled device, you must select it on the Source screen. Follow the instructions in the next section.











If an external device is set up as both an Anynet+-enabled device (i.e., a device that can be controlled with the TV's remote control) and a Universal Remote-enabled device (i.e., a device that can be controlled with the Universal Remote), it can be only controlled with the Universal Remote.

Setting up as an Anynet+ (HDMI-CEC)-enabled device

1. Press the **SOURCE** button on the remote control. On the **Source** screen, select the device and then press the **✓** button.
2. Select **Anynet+ (HDMI-CEC)** from the **Tools** list. The selected device is set up as an Anynet+ (HDMI-CEC)-enabled device. The following menu options are available.
 -  The menu options available in the pop-up menu may differ with the external device.
 - **Anynet+ (HDMI-CEC)**

Sets up the selected device as an Anynet+ (HDMI-CEC)-enabled device and then displays a list of Anynet+ (HDMI-CEC)-compliant devices connected to the TV. Select **View TV** to exit Anynet+ (HDMI-CEC), and start watching TV.

Read before connecting an Anynet+ (HDMI-CEC)

-  You can configure the TV's universal remote control to control third-party cable boxes, Blu-ray players, and home theatres that do not support HDMI-CEC. For more information, refer to "Controlling External Devices with the TV Remote - Using the Universal Remote."
-  Anynet+ cannot be used to control external devices that do not support HDMI-CEC.
-  Anynet+ devices must be connected to the TV with an HDMI cable. Note that some HDMI cables may not support Anynet+ (HDMI-CEC).
-  The TV remote control may not work under certain circumstances. If this occurs, select the Anynet+ device again.
-  Anynet+ (HDMI-CEC) works only with external devices that support HDMI-CEC and only when those devices are either in standby mode or turned on.
-  Anynet+ (HDMI-CEC) can control up to 12 compatible external devices (up to 3 of the same type). With home theatre systems, however, the only one system can be controlled.
-  To listen to 5.1-channel audio from an external device, connect the device to the TV via an HDMI cable and connect the home theatre system directly to the TV's digital audio output connector.
-  A home theatre system that has been connected to the TV with an HDMI cable and an optical cable only supports 2-channel audio. 5.1-channel audio is, however, available for digital broadcasts with 5.1-channel audio.

Updating the TV's Software



(MENU/123) > MENU > Support > Software Update [Try Now](#)

You can view your TV's software version and update it if necessary.

Updating the TV's software to the latest version

(MENU/123) > MENU > Support > Software Update > Update now [Try Now](#)

You can update your TV's software by downloading the update from the Internet directly to your TV or copying the update from a USB device that contains it to your TV.



-  This function requires an Internet connection.
-  Save the update package in the USB device's top-level folder. Otherwise, the TV will not be able to locate the update package.

⚠ DO NOT turn off the TV's power until the update is complete. The TV turns off and on automatically after completing the software update. All video and audio settings return to the default settings after a software update.

Updating the TV automatically

(MENU/123) > MENU > Support > Software Update > Auto Update [Try Now](#)

If the TV is connected to the Internet, you can have the TV's software update itself automatically while you are watching the TV. When the background update is completed, it is applied the next time the TV is used.

-  This function may take a longer time if a different networking function is running concurrently.
-  This function requires an Internet connection.
-  If you agree to the Smart Hub terms and conditions, **Auto Update** is set to **On** automatically. If you do not want the TV's software to update itself automatically, set **Auto Update** to **Off**.

Updating the TV manually

To update your TV manually by using a USB device, follow these steps:

 Record the current settings prior to updating so they can be re-loaded once updating is complete. All video and audio settings return to their default settings after a software update.

1. On a computer, visit Samsung's website and download the update package to a USB device.

 Save the update package in the USB device's top-level folder. Otherwise, the TV cannot be able to locate the update package.

2. Connect the USB device with the update package to the TV.

3. In the TV's menu, go to **Support > Software Update > Update now**. The TV searches for the software on the USB device. When it finds the software, the Update Request pop-up appears.

4. Select **OK**. The TV updates the software, turns off, and then turns back on automatically.

⚠ DO NOT turn off the TV's power until the upgrade is complete. The TV will turn off and on automatically after completing the software upgrade. All video and audio settings return to the default settings after a software upgrade.

Protecting the TV from Hacking and Malicious Code

(MENU/123) > MENU > System > Smart Security **Try Now**

You can use **Smart Security** to protect the TV from hacking and malicious code when connected to the Internet.

Checking the TV and connected storage for malicious code

(MENU/123) > MENU > System > Smart Security > Scan **Try Now**

You can scan the TV and connected media to detect the presence of malicious code. If there is no malicious code detected, a notification window appears on the screen.

If malicious code is detected...

If malicious code is found, the results of the scan will appear on the screen. This result window displays all malicious code found. You can either quarantine the code or isolate it to continue to run.

1. Select all the malicious code you want to either quarantine or block.
2. Select **Isolate** or **Block**. These options relocate the selected malicious code to the **Isolated List** or **Blocked List**.

 The **Isolated List** displays all quarantined malicious codes.

 The **Blocked List** displays all blocked malicious codes. You can also quarantine or allow codes from this list.

Configuring additional functions

(MENU/123) > MENU > System > Smart Security > Settings [Try Now](#)

- **Antivirus**
Monitors the TV in real-time to prevent viruses from infecting the TV.
- **Network Security**
Protects the TV from hacking to minimise a leaks of private information.
- **Camera**
Permits the cameras connected to the TV to be used.
- **Microphone**
Permits the microphones connected to the TV to be used.
- **Auto Scan**
Makes the TV automatically scan itself and connected storage media when it is turned on.
- **Auto Isolate**
Adds malicious codes found during the scanning process to the Isolated List automatically.

Using Other Functions

Running the accessibility functions quickly

You can use the **Accessibility Shortcuts** menu to quickly run the accessibility functions for the impaired. Press and hold the  button on the Samsung Smart Control. Or, press the **AD/SUBT** button on the standard remote. The **Accessibility Shortcuts** menu provides the **Audio Description**, **Subtitle**, **Menu Transparency**, **High Contrast**, **Enlarge**, and **Multi-output Audio** menu options.

Adjusting the menu transparency

(MENU/123) > MENU > System > Accessibility > Menu Transparency [Try Now](#)

You can adjust the menu's transparency.

 Setting **High Contrast** to **On** automatically switches the menu display mode to opaque. You cannot manually change the **Menu Transparency** settings.

White text on black background (high contrast)

(MENU/123) > MENU > System > Accessibility > High Contrast [Try Now](#)

You can change major service screens to white text on a black background or change the transparent TV menus to opaque so that text can be more easily read. To activate this function, set **High Contrast** to **On**.

Enlarging font (for the visually impaired)



(MENU/123) > MENU > System > Accessibility > Enlarge [Try Now](#)

You can zoom in the font on the screen. To activate this function, set **Enlarge** to **On**.

Listening to the TV through Bluetooth headphones (for the hearing impaired)

(MENU/123) > MENU > System > Accessibility > Multi-output Audio [Try Now](#)

You can turn on both of the TV speaker and Bluetooth headphones at the same time. With this function active, when you adjust the TV's volume, you can set the volume of the Bluetooth headphones to be louder than TV speaker.

-  This function is not available on certain models in specific geographical areas.
-  When you connect the Bluetooth headphones to the TV, **Multi-output Audio** menu is activated. For more information about connecting Bluetooth headphones to the TV, refer to "Listening to the TV through Bluetooth headphones."

Changing the menu language

(MENU/123) > MENU > System > Menu Language [Try Now](#)

You can use this function to change the menu language. Choose a language from the list.

Setting up a password

(MENU/123) > MENU > System > Change PIN [Try Now](#)

You can set a Personal Identification Number (PIN) to lock channels, reset the TV, and change TV settings.

The PIN input window appears. Enter a PIN. Enter it again to confirm it. The default PIN is 0000. (for France, Italy: 1111)

-  If you forget your PIN, you can reset it with your remote control. With the TV turned on, press the following buttons on the remote control to reset the PIN to 0000 (for France, Italy: 1111): **MUTE** → **+**(Volume Up) → **RETURN** → **-**(Volume Down) → **RETURN** → **+** → **RETURN**.

Checking Notifications

(MENU/123) > MENU > System > Notifications [Try Now](#)

You can view the list of event messages generated by the TV. **Notifications** appear on the screen when events such as an update release for an app or Samsung Account login/logout occurs.

-  To delete all notifications, select **Delete All**.
-  To check the SMART TV's service notifications in a web browser, select **Service Notice**.

Programme Rating Lock

(MENU/123) > MENU > Broadcasting > Programme Rating Lock

The **Programme Rating Lock** blocks programmes with ratings higher than those desired. This is useful for controlling what children watch on TV. This will not function for programmes originating from external sources, such as DVD players or USB files.

This PIN is required to watch a blocked programme.

The **Broadcasting** is not available in HDMI or Component mode.

 This function is only available on certain models in specific geographical areas.

Enabling game mode

(MENU/123) > MENU > System > General > Game Mode [Try Now](#)

You can enable the game mode to optimise the TV's settings for playing video games with a gaming console, such as a PlayStation™ or Xbox™.

 The game mode is not available for normal TV viewing.

 The screen may shake somewhat.

 When the **Game Mode** is enabled, **Picture Mode** and **Sound Mode** are switched to **Game** automatically.

 To use a different external device, first disconnect the game console and disable the **Game Mode**.

Richer colours and superior picture quality (BD Wise)

(MENU/123) > MENU > System > General > BD Wise [Try Now](#)

You can enhance colours and picture quality if you connect a Samsung DVD player, Blu-ray player, or home theatre system that supports **BD Wise**. When BD Wise is enabled, it automatically optimises the TV's resolution.

 This function is only available when the external device is connected via an HDMI cable.

Enabling/Disabling sound feedback

(MENU/123) > MENU > System > General > Sound Feedback [Try Now](#)

You can use Sound Feedback to get audio cues as you navigate through menus and select menu options. You can set it to **Low**, **Medium**, **High**, or **Off**.

Locking/Unlocking the Control Stick

(MENU/123) > MENU > System > General > Panel Lock [Try Now](#)

You can lock and unlock the front panel buttons (menu, channel, and volume) of the TV and the control stick on the back of the TV.

Showing/Hiding the Samsung logo while booting

(MENU/123) > MENU > System > General > Boot Logo [Try Now](#)



You can enable or disable the Samsung logo display that appears when the TV starts up.

 This function is not available when **Samsung Instant On** is set to **On**.

Enabling the TV to boot faster

(MENU/123) > MENU > System > General > Samsung Instant On [Try Now](#)



You can set **Samsung Instant On** to **On** so that the TV boots up faster.

-  When **Samsung Instant On** is set to **On**, the use history of the apps that you used on the TV may be stored in the TV.
-  Even if the **Samsung Instant On** function is on, the power consumption while the TV is turned off meets the standby power consumption specification presented on the product label.
-  The **Samsung Instant On** function works when you turn on the TV while its power cable is still connected after you set **Samsung Instant On** to **On**. If you disconnect, reconnect the power cable, and then turn on the TV, this function does not work.

Registering the TV as a DivX-certified device (watching for pay DivX movies)

(MENU/123) > MENU > System > DivX® Video On Demand

You can watch DivX DRM protected movies on the TV, only if it is registered as a DivX-certified device.

-  Digital Rights Management (DRM) functions as a technical security mechanism to protect the content provider's copyright.
-  You can watch recorded movies or free DivX movies without registration.
-  Visit the DivX website (<http://www.divx.com>) and log in to your user account before registering the TV as a DivX-certified device. If you do not have an account, create one.

Restoring the TV to the factory settings

(MENU/123) > MENU > Support > Self Diagnosis > Reset [Try Now](#)

You can restore all TV settings (excluding the Internet and network settings) to the factory defaults.



1. Select **Reset**. The security PIN entry window appears.
2. Enter the security PIN and select **Yes**. All settings are then reset. The TV turns off and on again automatically and displays the **Setup** screen.

 For more information on **Setup**, refer to the user manual that came with the TV.

Using the TV as a display model (for retail stores)

(MENU/123) > MENU > Support > Use Mode [Try Now](#)

You can turn the TV into a display model for retail environments by setting this mode to **Store Demo**.

-  For all other uses, select **Home Use**.
-  With **Store Demo**, some functions are disabled, and the TV automatically resets itself after a preset amount of time.

Running Data Service Automatically

 This function is only available on certain models in specific geographical areas.

(MENU/123) > MENU > Broadcasting > Channel Settings > Auto Run Data Service

You can set whether or not to automatically run data service. If the channel you are currently watching provides data service, you can enjoy a variety of data services by selecting the **A** button.

 This function is not available when any other secondary function is under way.

 Provided data service information may vary depending on the broadcast.

 Changing the channel with the numeric keys while using data service may not be available, depending on the service.

 If **Auto Run Data Service** is **On**, the loading screen is displayed and the function is not available temporarily.

HbbTV

 In some countries, HbbTV is a data service.

 This function is only available on certain models in specific geographical areas.

 Some broadcasting may not support the HbbTV.

To use HbbTV, download, install and run HbbTV Widget from SAMSUNG APPS, then follow the instructions on the screen.

HbbTV is turned off by default. To use HbbTV, go to (MENU/123) > MENU > System > Data Service and set it **Enable**. (Depending on the country)

- HbbTV is not available when Timeshift is running or when a recorded video is being played back.
- An application on HbbTV may malfunction temporarily depending on the circumstances of the broadcast station or application provider.
- An application is only available for use on HbbTV when the TV network is connected to an external network. The application may malfunction depending on the network conditions.
- If the current channel is compatible with both the HbbTV and non-HbbTV text input modes, activate TTX by select TTX key twice.

Using HbbTV:

- When the screen indicates (with the **A**, etc.) that HbbTV is being accessed.
- Select TTX using the remote once to enter the HbbTV text-input mode.
- Select TTX using the remote twice to enter the non-HbbTV text-input mode.

Using a TV Viewing Card (“CI or CI+ Card”)

The connection method of your TV viewing card may differ with models.

 Turn the TV off to connect or disconnect a “CI or CI+ Card”.

⚠ We recommend that you insert the “CI or CI+ Card” (viewing card) before you mount the TV on the wall because it may be difficult and dangerous to do this when it is on the wall.

Connecting the “CI or CI+ Card” via COMMON INTERFACE slot

Connect the “CI or CI+ Card” to the COMMON INTERFACE slot as shown in the image below.

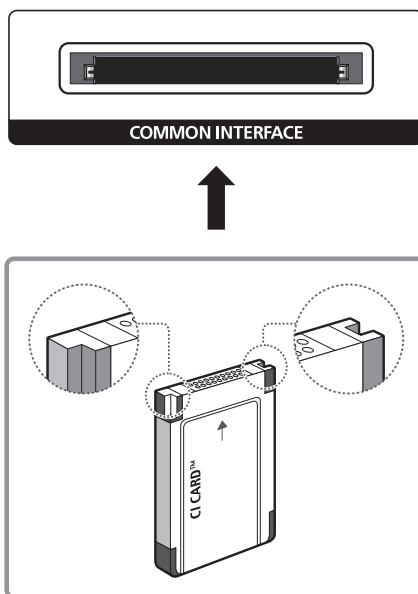

Connecting the “CI or CI+ Card” via COMMON INTERFACE slot with the CI CARD Adapter

Attaching the CI CARD Adapter via COMMON INTERFACE slot

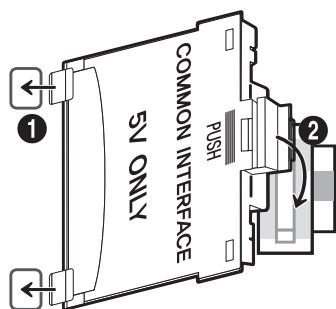

To attach the CI CARD Adapter to the TV, follow these steps:

1. Insert the CI CARD Adapter into the two holes on the product 1.

 Please locate the two holes at the back of the TV next to the COMMON INTERFACE slot.

2. Connect the CI CARD Adapter to the COMMON INTERFACE slot on the product 2.

Connecting the “CI or CI+ Card”

Connect the “CI or CI+ Card” to the COMMON INTERFACE slot as shown in the image below.

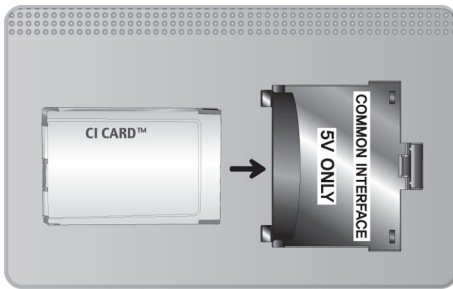

Using the “CI or CI+ Card”

To watch paid channels, the “CI or CI+ CARD” must be inserted.

- Samsung TV follow up CI+ 1.3 standard. When TV product display the "Scrambled Signal", it may happen due to CI+ 1.3 Version inconsistency. If you have a problem, please contact Samsung Call Centre.
- If you don't insert the “CI or CI+ CARD”, some channels will display the “Scrambled Signal” message.
- The pairing information containing a telephone number, the “CI or CI+ CARD” ID, the Host ID, and other information will be displayed in about 2~3 minutes. If an error message is displayed, please contact your service provider.
- When the configuration of channel information has finished, the message “Updating Completed” is displayed, indicating the channel list is updated.

- ✎ You must obtain a “CI or CI+ CARD” from a local cable service provider.
- ✎ When removing the “CI or CI+ CARD”, carefully pull it out with your hands since dropping the “CI or CI+ CARD” may cause damage to it.
- ✎ Insert the “CI or CI+ CARD” in the direction marked on the card.
- ✎ The location of the COMMON INTERFACE slot may be different depending on the model.
- ✎ “CI or CI+ CARD” is not supported in some countries and regions; check with your authorised dealer.
- ✎ If you have any problems, please contact a service provider.
- ✎ Insert the “CI or CI+ CARD” that supports the current aerial settings. The screen will be distorted or will not be seen.

Teletext Feature

 This function is only available on certain models in specific geographical areas.

The index page of the Teletext service gives you information on how to use the Service. For Teletext information to be displayed correctly, channel reception must be stable. Otherwise, information may be missing or some pages may not be displayed.

 You can change Teletext pages by select numeric using your remote control.



 **Teletext on / mix / off:** Activates the Teletext mode for the current channel. Press twice to overlap the Teletext mode with the current broadcasting screen. Press it one more time to exit teletext.

 **Store:** Stores the Teletext pages.

 **Size:** Displays the teletext on the upper half of the screen in double-size. To move the text to the lower half of the screen, press it again. For normal display, press it once again.

 **Hold:** Holds the display at the current page, in the case that there are several secondary pages that follow automatically. To undo, press it again.

Colour buttons (red, green, yellow, blue): If the FASTEXT system is used by the broadcasting company, the different topics on a Teletext page are colour-coded and can be selected by coloured buttons. Press the colour corresponding to the topic of your choice. A new colour coded page appears. Items can be selected in the same way. To display the previous or next page, select corresponding coloured button.

 **Mode:** Selects the Teletext mode (LIST / FLOF). If pressed during LIST mode, switches the mode to List save mode. In List save mode, you can save a Teletext page into a list using the  (store) button.

 **Sub-page:** Displays the available sub-page.

 **Page up:** Displays the next Teletext page.

 **Page down:** Displays the previous Teletext page.

 **Index:** Displays the index (contents) page at any time while you are viewing Teletext.

 **Reveal:** Displays the hidden text (answers to quiz games, for example). To display the normal screen, press it again.

 **Cancel:** Shrinks the Teletext display to overlap with the current broadcast.

Typical Teletext page

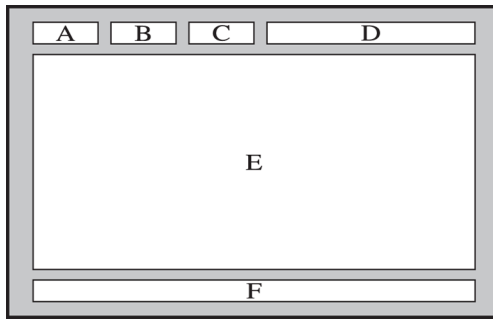

Part	Contents
A	Selected page number.
B	Broadcasting channel identity.
C	Current page number or search indications.
D	Date and time.
E	Text.
F	Status information, FASTEXT information.

Getting Support

Support through Remote Management

(MENU/123) > MENU > Support > Remote Management [Try Now](#)

If you need assistance with your TV, you can use this feature to let Samsung Electronics diagnose your TV remotely. You will need to read and agree to the service agreement before using this feature. A Samsung Electronics technician will then diagnose, repair, and update your TV remotely.

 This option requires an Internet connection.

What Does Remote Service Do?

Samsung Remote Support service offers you one-on-one support with a Samsung Technician who can remotely.

- **Diagnose** your TV
- **Adjust the TV settings** for you
- **Perform a factory reset** your TV
- Install recommended **firmware updates**

How Does it Work?

Having a Samsung Tech remotely service your TV is easy.



Call the Samsung Contact Centre and ask for remote support.



Open the menu on your TV and go to the Support section.



Select Remote Management, and then read and agree to the service agreements. When the PIN screen appears, provide the PIN number to the agent.



The agent accesses your TV.

Finding the contact information for service

[\(MENU/123\)](#) > [MENU](#) > [Support](#) > [Contact Samsung](#)

You can view the address of the Samsung website, the call centre phone number, your TV's model number, your TV's software version, the Smart Hub info, and other information you may need to get service support from a Samsung call agent or the Samsung website.

 To view the Open Source Licence, press the  button.

There Is a Problem with the Picture



Testing the picture

[\(MENU/123\) > MENU > Support > Self Diagnosis > Picture Test](#) [Try Now](#)

Before you review the list of problems and solutions below, use **Picture Test** to determine if the problem is caused by the TV. The **Picture Test** displays a high definition picture you can examine for flaws or faults.

The problem	Try this!
Flickering and Dimming	If your Samsung Television is flickering or dimming sporadically, you may need to disable some of the energy efficiency features. Disable Energy Saving ((MENU/123) > MENU > System > Eco Solution > Energy Saving) or Eco Sensor ((MENU/123) > MENU > System > Eco Solution > Eco Sensor).
Component Connections/Screen Colour	If the colour on your Samsung television screen is not correct or the black and white colours are off, run Picture Test ((MENU/123) > MENU > Support > Self Diagnosis > Picture Test). If the test results indicate that the problem is not caused by the TV, do the following: <ul style="list-style-type: none"> • Confirm that the TV's video input connectors are connected to the correct external device video output connectors. • Check the other connections as well. If the TV is connected to an external device via a component cable, confirm that the Pb, Pr, and Y jacks are plugged into their proper connectors.
Screen Brightness	If the colours on your Samsung TV are correct but just a little too dark or bright, try adjusting the following settings first. <ul style="list-style-type: none"> • Go to the Picture menu and adjust the Backlight, Contrast, Brightness, Sharpness, Colour, and Tint (G/R) settings.
Ghosting, Blurring, or Juddering	If you notice ghosting or blurring on the screen, use the Auto Motion Plus function((MENU/123) > MENU > Picture > Picture Options > Auto Motion Plus) to resolve the issue.
Unwanted Powering Off	If your Samsung TV appears to turn off by itself, try disabling some of the TV's energy efficiency functions. See if Sleep Timer ((MENU/123) > MENU > System > Time > Sleep Timer) has been enabled. The Sleep Timer automatically turns the TV off after a specified period of time. If the Sleep Timer has not been enabled, see if No Signal Power Off ((MENU/123) > MENU > System > Eco Solution > No Signal Power Off) or Auto Power Off ((MENU/123) > MENU > System > Eco Solution > Auto Power Off) has been enabled and disable them.
Problems Powering On	When the TV is turned on, the remote control receiver flashes 5 times before the screen turns on. If you are having problems powering on your Samsung television, there are a number of things to check before calling the service department. Confirm that the TV's power cord is connected correctly at both ends and that the remote control is operating normally. Make sure that the antenna cable or cable TV cable is firmly connected. If you have a cable/satellite box confirm that it is plugged in and turned on.
Unable to find a Channel	If your TV is not connected to a cable box or satellite box, run Setup ((MENU/123) > MENU > System > Setup) or Auto Tuning (Broadcasting > Auto Tuning).

The problem	Try this!
<p>The TV image does not look as good as it did in the store.</p>	<p>Store displays are all tuned to digital, HD (high definition) channels. If you have an analogue cable/set top box, upgrade to a digital set top box. Use HDMI or Component cables to deliver HD (high definition) picture quality. Many HD channels are upscaled from SD (Standard Definition) content. Look for a channel that is broadcasting true HD content.</p> <ul style="list-style-type: none"> • Cable/Satellite Subscribers: Try HD channels from the channel lineup. • Terrestrial/Cable Antenna Connection: Try HD channels after running the Auto Tuning function. <p>Adjust the cable/satellite box's video output resolution to 1080i or 720p.</p>
<p>The picture is distorted.</p>	<p>The compression of video content may cause picture distortions, especially in fast moving pictures from sports programmes and action movies. A weak or bad quality signal can cause picture distortions. This is not an issue with the TV. Mobile phones used close to the TV (within 1m) may cause noise in analogue and digital channels.</p>
<p>The colour is wrong or missing.</p>	<p>If you're using a Component connection, make sure that the Component cables are connected to the correct jacks. Incorrect or loose connections may cause colour problems or a blank screen.</p>
<p>The colour is poor or the picture is not bright enough.</p>	<p>Go to the Picture menu and then adjust the Picture Mode, Brightness, Sharpness, and Colour settings. See if Energy Saving ((MENU/123) > MENU > System > Eco Solution > Energy Saving) has been enabled. Try resetting the picture. ((MENU/123) > MENU > Picture > Reset Picture)</p>
<p>There is a dotted line on the edge of the screen.</p>	<p>Change Picture Size to 16:9. Change the cable/satellite box resolution.</p>
<p>The picture is black and white.</p>	<p>If you are using AV composite input, connect the video cable (yellow) to the TV's green component jack.</p>

-  If the test picture does not appear or there is noise or distortion, the TV may have a problem. Contact Samsung's Call Centre for assistance.
-  If the test picture is displayed properly, there may be a problem with an external device. Please check the connections.
-  If the problem persists, check the signal strength or refer to the external device's user manual.

I Can't Hear the Sound Clearly

Testing the sound

[\(MENU/123\)](#) > [MENU](#) > [Support](#) > [Self Diagnosis](#) > [Sound Test](#) [Try Now](#)

If the TV plays the Sound Test melody without distortion, there may be a problem with an external device or the broadcast signal's strength.

The problem	Try this!
There is no sound or the sound is too low at maximum volume.	Check the volume control of the device (cable/satellite box, DVD, Blu-ray, etc.) connected to your TV.
The picture is good but there is no sound.	Set (MENU/123) > MENU > Sound > Speaker Settings > Speaker Select to TV Speaker . If you are using an external device, check the device's audio output option. (For example, you may need to change your cable box's audio option to HDMI if the box connected to your TV is using an HDMI cable.) To listen to the computer sound, connect the external speaker to the computer's audio output connector. If your TV has a headphone jack, make sure there is nothing plugged into it. Reboot the connected device by disconnecting and then reconnecting the device's power cable.
The speakers are making an odd sound.	Make sure that the audio cable is connected to the correct audio output connector on the external device. For antenna or cable connections, check the signal information. A low signal level may cause sound distortions. Run Sound Test ((MENU/123) > MENU > Support > Self Diagnosis > Sound Test).

There Is a Problem with the Broadcast

The problem	Try this!
The TV is not receiving all channels.	<ul style="list-style-type: none">• Confirm that the coaxial cable is securely connected to the TV.• Run Setup ((MENU/123) > MENU > System > Setup) or Auto Tuning ((MENU/123) > MENU > Broadcasting > Auto Tuning).• If you are using an antenna, verify it is positioned correctly and the all the connections are secure.
There are no subtitles with digital channels.	Go to Subtitle ((MENU/123) > MENU > System > Accessibility > Subtitle) and change the Subtitle Mode . Some channels may not have subtitle data.
The picture is distorted.	The compression of the video content may cause picture distortions. This is especially true with fast moving pictures from sports programmes and action movies. A weak signal can cause picture distortions. This is not a problem with the TV.

My Computer Won't Connect

The problem	Try this!
The "Mode Not Supported" message appears.	Set your PC's output resolution so it matches a resolution supported by the TV.
The video is OK but there is no audio.	If you are using an HDMI connection, check the audio output setting on your PC. If you are using an HDMI-to-DVI cable, a separate audio cable is required.

I Can't Connect to the Internet

The problem	Try this!
The wireless network connection failed.	Confirm your wireless modem/router is on and connected to the Internet.
The software update over the Internet has failed.	Check the network connection status ((MENU/123) > MENU > Network > Network Status). If the TV is not connected to a network, connect to a network. The upgrade stops if you already have the latest software version.

Data Service

The Problem	Try this!
Why am I getting on-screen messages when I haven't selected the Data Service option?	If Auto Run Data Service is set to On , messages will automatically appear on the screen when you watch a broadcast that supports the Data Service. If the broadcast doesn't support the Data Service, no messages will appear on the screen. If you do not wish to receive Data Service messages, disable Auto Run Data Service .
How do I hide Data Service messages?	Press and hold the RETURN button. If you do not wish to receive Data Service messages, disable Auto Run Data Service .
How do I use the Data Service?	Enabling the Auto Run Data Service option automatically displays messages on the screen whenever you watch a broadcast that supports the Data Service. You can press the corresponding buttons shown on the screen to access additional features and functions offered by that broadcast.
What is an interactive service and how does it work?	Interactive services include viewer surveys, quizzes, ticket requests, product purchases, and other interactions between the viewer and the TV station. Generally, you will need to set up an account with the broadcaster and log in to the account in order to enjoy the interactive services they offer. Note that interactive services are only available when your TV is connected to the Internet. In addition, T-Commerce requires that you have a certificate. Copy your certificate from the computer to a USB device and connect that device to the TV. (Interactive services are not being offered yet. The actual service launch date varies depending on the broadcaster.)
A message displays "Receiving" but no change happens.	This indicates an error has occurred while receiving data. An execution error message will also appear on the screen. If this happens, try again.
Nothing appears on the screen after the Data Service is launched.	The Data Service may be initialising or the signal may have been severed by the broadcaster.

The Schedule Recording/Timeshift Function Isn't Working

The problem	Try this!
Schedule Recording cannot be used.	Check if there is a USB device connected to the TV. Recording will automatically stop if the signal becomes too weak. The Timeshift function will not work if there isn't enough storage space on the USB device.

Anynet+ (HDMI-CEC) Isn't Working

The problem	Try this!
Anynet+ does not work.	<p>Confirm that the device is an Anynet+ device. The Anynet+ system supports Anynet+ devices only.</p> <p>Check if the power cord of the Anynet+ device is properly connected.</p> <p>Check the cable connections of the Anynet+ device.</p> <p>Go to Anynet+ (HDMI-CEC) ((MENU/123) > MENU > System > Anynet+ (HDMI-CEC)) and see if Anynet+ (HDMI-CEC) has been set to On.</p> <p>Check whether the TV remote control is in TV mode.</p> <p>Check whether the remote control is Anynet+ compatible.</p> <p>Anynet+ may not function when some other functions are active, including Channel Search, Smart Hub, Plug & Play, etc.</p> <p>If you have disconnected and then reconnected the HDMI cable, scan for devices again or turn your TV off and on.</p>
I want to start Anynet+.	<p>Check if the Anynet+ device is properly connected to the TV, and then select the Anynet+ (HDMI-CEC) ((MENU/123) > MENU > System > Anynet+ (HDMI-CEC)) menu to see if Anynet+ (HDMI-CEC) is set to On.</p>
I want to exit Anynet+.	<p>Select View TV from the Anynet+ menu.</p> <p>Select a non-Anynet+ device from the Source list.</p>
The message "Connecting to Anynet+ device..." or "Disconnecting from Anynet+ device" appears on the screen.	<p>You cannot use the remote control when you are configuring Anynet+ or switching to a viewing mode. Use the remote control after the TV has completed the Anynet+ configuration or has switched to a viewing mode.</p>
The Anynet+ device won't play.	<p>You cannot use the play function when Setup is in progress.</p>
The connected device is not displayed.	<p>Check whether the device supports Anynet+.</p> <p>Check whether the HDMI cable is properly connected.</p> <p>Go to Anynet+ (HDMI-CEC) ((MENU/123) > MENU > System > Anynet+ (HDMI-CEC)) and see if Anynet+ (HDMI-CEC) has been set to On.</p> <p>Scan for Anynet+ devices again.</p> <p>Anynet+ devices must be connected to the TV using an HDMI cable. Make sure the device is connected to your TV with an HDMI cable. Some HDMI cables may not support Anynet+.</p> <p>If the connection is terminated because there has been a power failure or the HDMI cable has been disconnected, please scan for the device again.</p>
The TV audio is not being played through the receiver.	<p>Connect an optical cable to the TV and the receiver.</p> <p>ARC enables the TV to output digital sound via the HDMI (ARC) port.</p> <p>However, ARC is only available when the TV is connected to an audio receiver that supports ARC.</p>

I Have Trouble Launching/Using Apps

The problem	Try this!
I launched an app, but it's in English. How can I change the language?	Languages supported by the app may be different from the user interface language. The ability to change the language depends on the service provider.
My application is not working.	Check with the service provider. Refer to the Help section on the application service provider's website.

My File Won't Play

The problem	Try this!
Some files can't be played.	This problem may occur with high-bitrate files. Most files can be played back, but you might experience problems with high-bitrate files.

I Want to Reset the TV

Reset	Path	Description
Reset Settings	(MENU/123) > MENU > Support > Self Diagnosis > Reset	Reset Picture , Sound , Channel , Smart Hub , and all other settings, except for the network settings, default settings.
Resetting Smart Hub	(MENU/123) > MENU > Smart Hub > Reset Smart Hub	Resets all Smart Hub settings to their factory defaults and deletes all information related to Samsung accounts, linked service accounts, Smart Hub service agreements, and Smart Hub applications.

Other Issues

The problem	Try this!
The TV is hot.	Watching TV for an extended period of time causes the panel to generate heat. The heat from the panel is dissipated through internal vents running along the top of the TV. The bottom, however, may feel hot to the touch after extended use. Children watching TV need constant adult supervision to prevent them from touching the TV. This heat, however, is not a defect and does not affect the TV's functionality.
The picture won't display in full screen.	HD channels will have black bars on either side of the screen when displaying upscaled SD (4:3) content. Black bars will appear at the top and bottom of the screen when you watch movies that have aspect ratios different from your TV. Adjust the picture size options on your external device or set the TV to full screen.
The "Mode Not Supported" message appears.	The output resolution of the attached device is not supported by the TV. Check the TV's supported resolutions and adjust the external device's output resolution accordingly.
The Subtitles item in the TV menu is greyed out.	You cannot select the Subtitles menu if you have selected a source connected to the TV via HDMI or Component. To view subtitles, turn on the external device's subtitle function.
The TV smells of plastic.	This smell is normal and will dissipate over time.
The Signal Information option under Self Diagnosis isn't activated.	Verify that the current channel is a digital channel. The Signal Information is only available for digital channels.
The TV is tilted to the side.	Remove the base stand from the TV and reassemble it.

The problem	Try this!
The Broadcasting option has been deactivated.	<p>Broadcasting is only available when the Source is set to TV.</p> <p>The Broadcasting menu cannot be accessed while you watch TV using a cable box or satellite receiver.</p> <p>The Broadcasting menu cannot be accessed while a recording is in progress or the timeshift function is running.</p>
The settings are lost after 5 minutes or every time the TV is turned off.	<p>If the Use Mode is set to Store Demo, the TV's audio and video settings are automatically reset every 5 minutes.</p> <p>Change the Use Mode ((MENU/123) > MENU > Support > Use Mode) to Home Use.</p>
There is an intermittent loss of audio or video.	<p>Check the cable connections and reconnect them.</p> <p>Loss of audio or video can be caused by using overly rigid or thick cables. Make sure the cables are flexible enough for long term use. If you are mounting the TV to a wall, we recommend using cables with 90-degree connectors.</p>
There are small particles on the TV's bezel.	<p>This is part of the product's design and is not a defect.</p>
The PIP menu is not available.	<p>PIP functionality is only available when you are viewing video from an HDMI or Component source on the main screen.</p>
A POP (TV's internal banner ad) appears on the screen.	<p>Change the Use Mode ((MENU/123) > MENU > Support > Use Mode) to Home Use.</p>
The TV is making a popping noise.	<p>The expansion and contraction of the TV's outer casing may cause a popping noise. This does not indicate a product malfunction. The TV is safe to use.</p>
The TV is making a humming noise.	<p>Your TV utilises high-speed switching circuits and high levels of electrical current. Depending on the TV's brightness level, the TV may seem slightly noisier than a conventional TV.</p> <p>Your TV has undergone strict quality control procedures that meet our demanding performance and reliability requirements.</p> <p>Some noise coming from the TV is considered normal and is not an acceptable cause for an exchange or refund.</p>

Before Using the Recording and Timeshift Functions

 This function is only available on certain models in specific geographical areas.

Before using the recording and schedule recording functions

- To set up a Schedule Recording, you must first set the TV's clock. Set the **Clock** ((MENU/123) > MENU > System > Time > Clock).
- You can set up a maximum total of 30 **Schedule Viewing** and **Schedule Recording** entries.
- Recordings are DRM-protected and therefore cannot be played back on a computer or on a different TV. In addition, these files cannot be played back on your TV if its video circuit has been replaced.
- A USB hard drive with a speed of 5,400 rpm or above is recommended. However, RAID-type USB hard drives are not supported.
- USB memory sticks are not supported.
- The total recording capacity may differ with the amount of available hard drive space and the recording quality level.
- **Schedule Recording** requires at least 100MB of free space on the USB storage device. Recording will stop if the available storage space falls below 50MB while recording is in progress.
- If the available storage space falls below 500MB while both the Schedule Recording and Timeshift functions are in progress, only the recording will stop.
- The maximum recording time is 720 minutes.
- A video is played according to the TV settings.
- If the input signal is changed while recording is in progress, the screen will go blank until the change is made. In this case, recording will resume, but  will not be available.
- When using the Record or Schedule Recording function, the actual recording may start a second or two later than the specified time.

- If the Schedule Recording function is operating while a recording is being made on an HDMI-CEC external device, the priority is given to the Schedule Recording.
- Connecting a recording device to the TV automatically deletes abnormally saved recording files.
- If the **Off Timer** or **Auto Power Off** has been set, the TV will override these settings, continue to record, and turn off after the recording has ended.

Before using the timeshift function

- A USB hard drive with a speed of 5,400 rpm or above is recommended. However, RAID-type USB hard drives are not supported.
- USB memory sticks or flash drives are not supported.
- The total recording capacity may differ with the amount of available hard drive space and the recording quality level.
- If the available storage space falls below 500MB while both the Schedule Recording and Timeshift functions are in progress, only the recording will stop.
- The maximum amount of time available for the Timeshift function is 90 minutes.
- The Timeshift function is not available for locked channels.
- A time-shifted video is played according to the TV settings.
- The Timeshift function may be terminated automatically once it reaches its maximum capacity.
- The Timeshift function requires at least 1.5GB of free space available on the USB storage device.

Read Before Using Apps

- Due to the product characteristics featured on the Samsung Smart Hub, as well as limitations in available content, certain features, applications, and services may not be available on all devices or in all territories. Some Smart Hub features may also require additional peripheral devices or membership fees. Visit <http://www.samsung.com> for more information on specific device information and content availability. Services and content availability are subject to change without prior notice.
- Samsung Electronics takes no legal responsibility whatsoever for any interruption of app services caused by the service provider for any reason.
- Application services may be provided in English only and available content may differ with the area.
- For more information about applications, visit the applicable service provider's website.
- An unstable Internet connection may cause delays or interruptions. In addition, applications may terminate automatically depending on the network environment. If this occurs, check your Internet connection and try again.
- Application services and updates may become unavailable.
- Application content is subject to change by the service provider without prior notice.
- Specific services may differ with the version of the application installed on the TV.
- An application's functionality may change in future versions of the application. If this occurs, run the application's tutorial or visit the service provider's website.
- Depending on the service provider's policies, certain applications may not support multitasking.

Read Before Using the Web Browser

- The browsing screen may differ from the one on your computer.
- The web browser is not compatible with Java applications.
- You cannot download files. If you attempt to download a file, you will receive an error message instead.
- The web browser may not be able to access certain websites.
- Playing Flash videos may be restricted.
- E-commerce for online purchases is not supported.
- With websites that have scrollable windows, scrolling a window can result in corrupted characters.
- ActiveX is not supported.
- Certain options are not accessible in Link Browsing mode. (Switch to Pointer Browsing to activate those options.)
- Only a limited number of fonts are supported. Certain symbols and characters may not be displayed properly.
- The response to remote commands and the resulting on-screen display may be delayed while a webpage is loading.
- Loading a webpage may be delayed or suspended completely with certain operating systems.
- The copy and paste operations are not supported.

- When composing an email or a simple message, certain functions such as the font size and colour selection may not be available.
- There is a limit to the number of bookmarks and the size of the log file that can be saved.
- The number of windows that can be opened concurrently differs with the search conditions and the TV model.
- The web browsing speed will differ with the network environment.
- Playing embedded video automatically disables PIP. Video playback may not commence after PIP is disabled. In this case, you will have to reload the page.
- The web browser supports .mp3 audio files only.
- If the **Clock** ((**MENU/123**) > **MENU** > **System** > **Time** > **Clock**) has not been set, the browsing history will not be saved.
- The browsing history is saved from latest to oldest, with the oldest entries being overwritten first.
- Depending on the types of video/audio codecs supported, it might not be possible to play certain video and audio files while playing Flash content.
- Video sources from PC-optimised streaming service providers may not play properly on our proprietary web browser.
- Using the on-screen QWERTY keyboard automatically disables PIP. (Except when entering a URL.)

Read Before Playing Photo, Video, or Music Files

Limitations on use of photo, video, and music files

- The TV supports MSC (Mass Storage Class) USB devices only. MSC is a class designation for mass storage devices. Types of MSC devices include external hard drives, flash card readers, and digital cameras. (USB hubs are not supported.) These kinds of devices must be connected directly to the TV's USB port. The TV may not be able to recognise the USB device or read the files on the device if it is connected to the TV via a USB extension cable. Do not disconnect the USB device while transferring files.
- When connecting an external hard drive, use the USB (HDD) port. We recommend that you use an external hard drive with its own power adapter.
- Certain digital cameras and audio devices may not be compatible with the TV.
- If there are multiple USB devices connected to the TV, the TV might not be able to recognise some or all the devices. USB devices that use high-power input should be connect the USB [5V, 1A] port.
- The TV supports the FAT, exFAT, and NTFS file systems.
- After sorting files in the Folder view mode, the TV can display up to 1000 files per folder. If the USB device contains more than 8,000 files and folders, however, some files and folders might not be accessible.
- The PTP (Picture Transfer Protocol) connection mode is available only for digital cameras. If you connect a smartphone or tablet to the TV using PTP mode, the TV will not recognise it.
- Be sure to connect a USB or external Hard Drive, supporting USB 3.0, to the USB 3.0 port.
- Certain files, depending on how they were encoded, may not play on the TV.
- Certain files are not available depending on the model.

Supported external subtitles

Name	Format
MPEG-4 Timed text	.ttxt
SAMI	.smi
SubRip	.srt
SubViewer	.sub
Micro DVD	.sub or .txt
SubStation Alpha	.ssa
Advanced SubStation Alpha	.ass
Powerdivx	.psb
SMPTE-TT Text	.xml

Supported internal subtitles

Name	Container
Xsub	AVI
SubStation Alpha	MKV
Advanced SubStation Alpha	MKV
SubRip	MKV
VobSub	MKV
MPEG-4 Timed text	MP4
TTML in smooth streaming	MP4
SMPTE-TT Text	MP4
SMPTE-TT PNG	MP4

Supported image formats and resolutions

File extension	Format	Resolution
*.jpg *.jpeg	JPEG	15360x8640
*.png	PNG	4096x4096
*.bmp	BMP	4096x4096
*.mpo	MPO	15360x8640

Supported music formats and codecs

File extension	Format	Codec	Note
*.mp3	MPEG	MPEG1 Audio Layer 3	
*.m4a *.mpa *.aac	MPEG4	AAC	
*.flac	FLAC	FLAC	Supports up to 2 channels
*.ogg	OGG	Vorbis	Supports up to 2 channels
*.wma	WMA	WMA	Supports up to 10 Pro 5.1 channels. WMA lossless audio is not supported. Supports up to the M2 profile.
*.wav	wav	wav	
*.mid *.midi	midi	midi	Supports type 0 and type 1. Seek is not supported. Supports USB device only.
*.ape	ape	ape	
*.aif *.aiff	AIFF	AIFF	
*.m4a	ALAC	ALAC	

Supported video codecs

File format	Container	Video codecs	Resolution	Frame rate (fps)	Bitrate (Mbps)	Audio codecs
*.avi *.mkv *.asf *.wmv *.mp4 *.mov *.3gp *.vro *.mpg *.mpeg *.ts *.tp *.trp *.mov *.flv *.vob *.svi *.m2ts *.mts *.divx	AVI MKV ASF MP4 3GP MOV FLV VRO VOB PS TS SVAF	H.264 BP/MP/HP	1920x1080	60	40	Dolby Digital LPCM ADPCM(IMA, MS) AAC HE-AAC WMA Dolby Digital Plus MPEG(MP3) DTS(Core, LBR) G.711(A-Law, μ -Law)
		HEVC(H.265 - Main Profile only)				
		Motion JPEG		30		
		MVC		60		
		DivX 3.11 / 4 / 5 / 6				
		MPEG4 SP/ASP		20		
		Window Media Video v9(VC1)				
		MPEG2		30		
		MPEG1				
		Microsoft MPEG-4 v1, v2, v3		90		
		Window Media Video v7(WMV1), v8(WMV2)				
		H.263 Sorrenson				
		VP6				
		VP8		WebM	Vorbis	

Other restrictions

- Codecs may not function properly if there is a problem with the content.
- Video content does not play or does not play correctly if there is an error in the content or container.
- Sound or video may not work if they have standard bit rates/frame rates above the TV's compatibility ratings.
- If the Index Table is has an error, the Seek (Jump) function will not work.
- When playing video over a network connection, the video may not play smoothly because of data transmission speeds.
- Some USB/digital camera devices may not be compatible with the TV.
- HEVC codec is only available in MKV/MP4/TS containers.

Video decoders

- H.264 FHD is supported up to Level 4.1. (does not support FMO/ASO/RS)
- VC1 AP L4 is not supported.
- All video codecs excluding WMV v7, v8, MSMPEG4 v3, MVC, and VP6:
Below 1280x720: 60 frame max
Above 1280x720: 30 frame max
- GMC 2 or above is not supported.
- Supports SVAF Top/Bottom, Side by Side, and Left/Right view sequence type (2ES) only.
- Supports BD MVC specs only.

Audio decoders

- WMA 10 Pro supports up to 5.1 channels. Supports up to the M2 profile. WMA lossless audio is not supported.
- QCELP and AMR NB/WB are not supported.
- Vorbis is supported for up to 5.1 channels.
- Dolby Digital Plus is supported for up to 5.1 channels.
- The DTS LBR codec is only available for MKV/MP4/TS containers.
- The supported sample rates are 8, 11.025, 12, 16, 22.05, 24, 32, 44.1, and 48 KHz, and differ by the codec.

Restrictions

Restrictions to PIP (Picture-in-Picture)

- PIP cannot be used while **Smart Hub** is active.
- Turning off the TV automatically disables PIP.
- Playing a game or using the karaoke feature on the main screen can result in lower PIP picture quality.

1 Tuner model	MAIN TV					
PIP	DTV	ATV	HDMI	AV	SCART IN	Component
DTV	X	X	○	X	X	○
ATV	X	X	○	X	X	○

 This function is dependent on the specific model and area.

2 Tuner model	MAIN TV					
PIP	DTV	ATV	HDMI	AV	SCART IN	Component
DTV	○	○	○	○	○	○
ATV	X	X	○	X	X	○

 This function is dependent on the specific model and area.

Flexible CI

Not supported 2 Scrambled Channel

Tuner 1	Tuner 2	Compatibility
Watch (Pay)	Watch (Pay)	X
Watch (Pay)	Watch (Free)	○
Watch (Free)	Watch (Pay)	○
Watch (Free)	Watch (Free)	○

Read After Installing the TV

Picture sizes and input signals

The **Picture Size** setting is applied to the current source. The applied **Picture Size** will remain in effect whenever you select that source unless you change it.

Input signal	Picture size
Component	16:9, Zoom, Custom, 4:3
Component (1080i, 1080p)	16:9, Zoom, Custom, 4:3
Digital channel (720p, 1080i, 1080p)	16:9, Zoom, Custom, 4:3
HDMI (720p)	16:9, Zoom, Custom, 4:3
HDMI (1080i, 1080p)	16:9, Zoom, Custom, 4:3

Installing an anti-theft lock

- An anti-theft lock is a physical device that can be used to protect the TV against theft. Look for the lock slot on the back of the TV. The slot has a  icon next to it. To use the lock, wrap the lock cable around an object that is too heavy to carry and then thread it through the TV's lock slot. The lock is sold separately.
- The method of using an anti-theft lock may differ for each TV model. Refer to the lock's user manual for more information.



This function is only available on certain models in specific geographical areas.

Read before setting up a wireless Internet connection

Precautions for wireless Internet

- This TV supports the IEEE 802.11a/b/g/n communication protocols. Samsung recommends using IEEE 802.11n. Video files stored on a device connected to the TV via Home Network may not play back smoothly.
- To use wireless Internet, the TV must be connected to a wireless router or modem. If the wireless router supports DHCP, the TV can use a DHCP or static IP address to connect to the wireless network.
- Select a channel that is not currently in use for the wireless router. If the channel set for the wireless router is currently being used by another device, the result is usually interference and/or a communications failure.
- Most wireless networks have an optional security system. To enable a wireless network's security system, you need to create a password using characters and numbers. This password is then needed to connect to a security-enabled AP.

Wireless security protocols

- The TV only supports the following wireless network security protocols.
 - Authentication Modes: WEP, WPAPSK, WPA2PSK
 - Encryption Types: WEP, TKIP, AES
- In compliance with the newest Wi-Fi certification specifications, Samsung TVs do not support WEP or TKIP security encryption in networks running in the 802.11n mode.
- If the wireless router supports WPS (Wi-Fi Protected Setup), you can connect the TV to your network using PBC (Push Button Configuration) or a PIN (Personal Identification Number). WPS automatically configures the SSID and WPA key settings.
- The TV cannot connect to non-certified wireless routers.

Read Before Connecting a Computer (Supported Resolutions)

- When you connect your TV to a computer, set the computer's video card to one of the standard resolutions listed in the tables below or on the next page. The TV will automatically adjust to the resolution you choose. Note that the optimal and recommended resolution is 1920 x 1080 at 60 Hz.
- Choosing a resolution not included in the tables can result in a blank screen or just the power indicator turning on.
- Refer to the user manual of your graphics card for compatible resolutions.

IBM

Resolution (Dots x lines)	Display format	Horizontal frequency (KHz)	Vertical frequency (Hz)	Clock frequency (MHz)	Polarity (horizontal / vertical)
720 x 400	70 Hz	31,469	70,087	28,322	- / +

MAC

Resolution (Dots x lines)	Display format	Horizontal frequency (KHz)	Vertical frequency (Hz)	Clock frequency (MHz)	Polarity (horizontal / vertical)
640 x 480	67 Hz	35,000	66,667	30,240	- / -
832 x 624	75 Hz	49,726	74,551	57,284	- / -
1152 x 870	75 Hz	68,681	75,062	100,000	- / -

VESA DMT

Resolution (Dots x lines)	Display format	Horizontal frequency (KHz)	Vertical frequency (Hz)	Clock frequency (MHz)	Polarity (horizontal / vertical)
640 x 480	60 Hz	31,469	59,940	25,175	- / -
640 x 480	72 Hz	37,861	72,809	31,500	- / -
640 x 480	75 Hz	37,500	75,000	31,500	- / -
800 x 600	60 Hz	37,879	60,317	40,000	+ / +
800 x 600	72 Hz	48,077	72,188	50,000	+ / +
800 x 600	75 Hz	46,875	75,000	49,500	+ / +
1024 x 768	60 Hz	48,363	60,004	65,000	- / -
1024 x 768	70 Hz	56,476	70,069	75,000	- / -
1024 x 768	75 Hz	60,023	75,029	78,750	+ / +
1152 x 864	75 Hz	67,500	75,000	108,000	+ / +
1280 x 720	60 Hz	45,000	60,000	74,250	+ / +
1280 x 800	60 Hz	49,702	59,810	83,500	- / +
1280 x 1024	60 Hz	63,981	60,020	108,000	+ / +
1280 x 1024	75 Hz	79,976	75,025	135,000	+ / +
1366 x 768	60 Hz	47,712	59,790	85,500	+ / +
1440 x 900	60 Hz	55,935	59,887	106,500	- / +
1600 x 900RB	60 Hz	60,000	60,000	108,000	+ / +
1680 x 1050	60 Hz	65,290	59,954	146,250	- / +
1920 x 1080	60 Hz	67,500	60,000	148,500	+ / +

Supported Resolutions for Video Signals

CEA-861

Resolution (Dots x lines)	Display format	Horizontal frequency (KHz)	Vertical frequency (Hz)	Clock frequency (MHz)	Polarity (horizontal / vertical)
720(1440) x 480i	60 Hz	15.734	59.940	27.000	- / -
720(1440) x 576i	50 Hz	15.625	50.000	27.000	- / -
720 x 480	60 Hz	31.469	59.940	27.000	- / -
720 x 576	50 Hz	31.250	50.000	27.000	- / -
1280 x 720	60 Hz	45.000	60.000	74.250	+ / +
1280 x 720	50 Hz	37.500	50.000	74.250	+ / +
1920 x 1080i	60 Hz	33.750	60.000	74.250	+ / +
1920 x 1080i	50 Hz	28.125	50.000	74.250	+ / +
1920 x 1080	60 Hz	67.500	60.000	148.500	+ / +
1920 x 1080	50 Hz	56.250	50.000	148.500	+ / +
1920 x 1080	30 Hz	33.750	30.000	74.250	+ / +
1920 x 1080	25 Hz	28.125	25.000	74.250	+ / +
1920 x 1080	24 Hz	27.000	24.000	74.250	+ / +

DVI

Resolution (Dots x lines)	Display format	Horizontal frequency (KHz)	Vertical frequency (Hz)	Clock frequency (MHz)	Polarity (horizontal / vertical)
720 x 480	60 Hz	31.469	59.940	27.000	- / -
720 x 576	50 Hz	31.250	50.000	27.000	- / -
1280 x 720	60 Hz	45.000	60.000	74.250	+ / +
1280 x 720	50 Hz	37.500	50.000	74.250	+ / +
1920 x 1080	60 Hz	67.500	60.000	148.500	+ / +
1920 x 1080	50 Hz	56.250	50.000	148.500	+ / +

Read Before Using Bluetooth Devices

Restrictions on using Bluetooth

- The Samsung Bluetooth Speaker is only available when a device is supporting [TV SoundConnect](#).
- You can't use Bluetooth Devices, [Speaker Select \(\(MENU/123\) > MENU > Sound > Speaker Settings > Speaker Select\)](#) and Surround features simultaneously.
- Compatibility issues may occur, depending on the Bluetooth Devices. (A Mobile exclusive headphone may not be available, depending on the environment.)
- Lip-sync errors may occur.
- The TV and Bluetooth Devices may disconnect, depending on the distance between them.
- A Bluetooth device may hum or malfunction
 - When a part of your body is in contact with the receiving/transmitting system of the Bluetooth device or the TV.
 - When the device is subject to electrical variation from obstructions caused by a wall, corner, or office partitioning.
 - When the device is exposed to electrical interference from same frequency-band devices including medical equipment, microwave ovens, and wireless LANs.
- If the problem persists, be sure to use a Digital Sound Output (Optical) port or HDMI (ARC) port.

Licence

DIVX[®] **HD**

This DivX Certified[®] device has passed rigorous testing to ensure it plays DivX[®] video.

To play purchased DivX movies, first register your device at vod.divx.com. Find your registration code in the DivX VOD section of your device setup menu.

DivX Certified[®] to play DivX[®] video up to HD 1080p, including premium content.

DivX[®], DivX Certified[®] and associated logos are trademarks of DivX, LLC and are used under license.

Covered by one or more of the following U.S. patents: 7,295,673; 7,460,668; 7,515,710; 7,519,274.

This device supports DivX Plus Streaming[®] for enjoying HD movies and TV shows with advanced features (multi-language subtitles, multiple audio tracks, chapters, smooth FF/RW, etc.) streamed to your device.



For DTS patents, see <http://patents.dts.com>. Manufactured under license from DTS, Inc. DTS, the Symbol, DTS in combination with the Symbol, DTS Premium Sound|5.1, DTS Digital Surround, DTS Express, and DTS Neo2:5 are registered trademarks or trademarks of DTS, Inc. in the United States and/or other countries.

© DTS, Inc. All Rights Reserved.



For DTS patents, see <http://patents.dts.com>. Manufactured under license from DTS Licensing Limited. DTS, the Symbol, & DTS and the Symbol together are registered trademarks, and HEADPHONE:X and the DTS HEADPHONE:X logo are trademarks of DTS, Inc. © DTS, Inc. All Rights Reserved.



Manufactured under license from Dolby Laboratories.

Dolby and the double-D symbol are trademarks of Dolby Laboratories.

HDMI

The terms HDMI and HDMI High-Definition Multimedia Interface, and the HDMI Logo are trademarks or registered trademarks of HDMI Licensing LLC in the United States and other countries.



Trademark: Rovi and Rovi Guide are trademarks of Rovi Corporation and/or its subsidiaries.

Licence: The Rovi Guide system is manufactured under licence from Rovi Corporation and/or its subsidiaries.

Patent: The Rovi Guide system is protected by patents and patent applications filed in the US, Europe, and other countries including one or more of the United States patents 6,396,546; 5,940,073; 6,239,794 issued to Rovi Corporation and/or its subsidiaries.

Disclaimer: Rovi Corporation and/or its subsidiaries and related affiliates are not in any way liable for the accuracy or availability of the programme schedule information or other data in the Rovi Guide system and cannot guarantee service availability in your area. In no event shall Rovi Corporation and/or its related affiliates be liable for any damages in connection with the accuracy or availability of the programme schedule information or other data in the Rovi Guide system.

Open Source License Notice

Open Source used in this product can be found on the following webpage.

(<http://opensource.samsung.com>) Open Source License Notice is written only English.



Glossary

- **480i / 480p / 720p / 1080i / 1080p**

Generally refers to the number of effective scanning lines that determines the screen's resolution. There are two scanning methods: interlaced and progressive.

- Scanning

Sequential projection of pixels to form images. The higher the number of pixels, the clearer and more vivid the images.

- Progressive

A sequential scanning method that scans every line, one after another.

- Interlaced

A staggered scanning method that scans every other line until the end of the screen and then fills in the remaining lines.

Example) If the number of horizontal scan lines is 480i

Scans 240 lines from start to finish and then scans the remaining 240 lines for a total of 480 lines.

* General differences between 480i and 480p are as follows:

	480i	480p
Horizontal Frequency	15.75Khz	31.5Khz
FPS	30	60
Lines on Screen	480	480

- **ARC (Audio Return Channel)**

ARC lets the TV output digital sound to an audio device and input digital sound from the same audio device through one HDMI cable. However, ARC is only available through the HDMI (ARC) port and only when the TV is connected to an ARC-enabled AV receiver.

- **DVI (Digital Visual Interface)**

Connecting the TV's DVI connector to a computer's DVI connector via an HDMI-to-DVI cable lets you use the TV as a computer monitor. However, HDMI-to-DVI cables deliver video signals only. You must connect a set of speakers to the computer using a separate cable to hear the computer's audio.

- **HDMI (High Definition Multimedia Interface)**

HDMI is a method of transmitting both video and audio signals via a single cable.

- **Dynamic versus Static IP Addresses**

If the network requires a dynamic IP address, use an ADSL modem or router that supports the Dynamic Host Configuration Protocol (DHCP). Modems and routers that support DHCP automatically provide the IP address, subnet mask, gateway and DNS values the TV needs to access the Internet, so they do not have to be entered manually. Most home networks use a dynamic IP address.

If the network requires a static IP address, enter the IP address, subnet mask, gateway, and DNS values manually when setting up the network connection. To get the IP address, subnet mask, gateway and DNS values, contact your Internet Service Provider (ISP).

If the network requires a static IP address, use an ADSL modem that supports DHCP. ADSL modems that support DHCP also allow static IP addresses.

- **Bluetooth**

Bluetooth is a short-distance wireless communication protocol allowing information exchange between connected mobile phones, laptops, earphones and headphones with Bluetooth-compatible devices. It is mostly used for low-power consuming wireless connections within a very short-distance of 10m.

- **Ethernet**

Ethernet is a LAN (Local Area Network) that uses coaxial cables standardised by the IEEE.

- **Component Connection**

Component connections are mostly used for game consoles and transmit the video signal by splitting it into a luminance signal (Y) and two colour signals (Pb and Pr). The connector is marked as [Component IN]_(Pr, Pb, Y) on the back of the TV. On some devices, it is sometimes marked as Cr, Cb, Y. Cb and Cr are the digital conversions of the Pb and Pr signals.

The connectors are normally colour-coded red (R), blue (B), and green (G) and offer the best picture quality possible for an analogue connection.