

User Manual

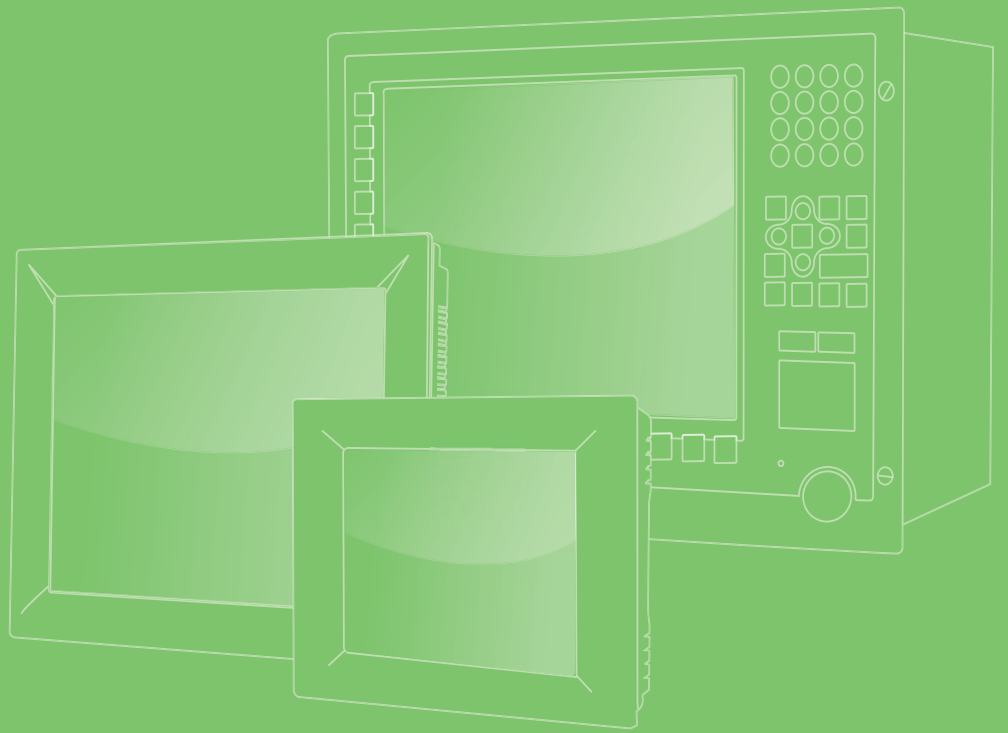

# PPC-3151

Intel® Core i Processor Based  
Micro-Computer with a 15" Color  
TFT LCD Display

**ADVANTECH**

*Enabling an Intelligent Planet*

---

## Copyright

The documentation and the software included with this product are copyrighted 2016 by Advantech Co., Ltd. All rights are reserved. Advantech Co., Ltd. reserves the right to make improvements in the products described in this manual at any time without notice. No part of this manual may be reproduced, copied, translated or transmitted in any form or by any means without the prior written permission of Advantech Co., Ltd. Information provided in this manual is intended to be accurate and reliable. However, Advantech Co., Ltd. assumes no responsibility for its use, nor for any infringements of the rights of third parties, which may result from its use.

## Acknowledgements

Intel and Pentium are trademarks of Intel Corporation.

Microsoft Windows and is registered trademarks of Microsoft Corp.

All other product names or trademarks are properties of their respective owners.

## Product Warranty (2 years)

Advantech warrants to you, the original purchaser, that each of its products will be free from defects in materials and workmanship for two years from the date of purchase.

This warranty does not apply to any products which have been repaired or altered by persons other than repair personnel authorized by Advantech, or which have been subject to misuse, abuse, accident or improper installation. Advantech assumes no liability under the terms of this warranty as a consequence of such events.

Because of Advantech's high quality-control standards and rigorous testing, most of our customers never need to use our repair service. If an Advantech product is defective, it will be repaired or replaced at no charge during the warranty period. For out-of-warranty repairs, you will be billed according to the cost of replacement materials, service time and freight. Please consult your dealer for more details.

If you think you have a defective product, follow these steps:

1. Collect all the information about the problem encountered. (For example, CPU speed, Advantech products used, other hardware and software used, etc.) Note anything abnormal and list any onscreen messages you get when the problem occurs.
2. Call your dealer and describe the problem. Please have your manual, product, and any helpful information readily available.
3. If your product is diagnosed as defective, obtain an RMA (return merchandise authorization) number from your dealer. This allows us to process your return more quickly.
4. Carefully pack the defective product, a fully-completed Repair and Replacement Order Card and a photocopy proof of purchase date (such as your sales receipt) in a shippable container. A product returned without proof of the purchase date is not eligible for warranty service.
5. Write the RMA number visibly on the outside of the package and ship it prepaid to your dealer.

# Declaration of Conformity

## CE

This product has passed the CE test for environmental specifications when shielded cables are used for external wiring. We recommend the use of shielded cables. This kind of cable is available from Advantech. Please contact your local supplier for ordering information.

## CE

This product has passed the CE test for environmental specifications. Test conditions for passing included the equipment being operated within an industrial enclosure. In order to protect the product from being damaged by ESD (Electrostatic Discharge) and EMI leakage, we strongly recommend the use of CE-compliant industrial enclosure products.

## FCC Class B

Note: This equipment has been tested and found to comply with the limits for a Class B digital device, pursuant to part 15 of the FCC Rules. These limits are designed to provide reasonable protection against harmful interference in a residential installation. This equipment generates, uses and can radiate radio frequency energy and, if not installed and used in accordance with the instructions, may cause harmful interference to radio communications. However, there is no guarantee that interference will not occur in a particular installation. If this equipment does cause harmful interference to radio or television reception, which can be determined by turning the equipment off and on, the user is encouraged to try to correct the interference by one or more of the following measures:

- Reorient or relocate the receiving antenna.
- Increase the separation between the equipment and receiver.
- Connect the equipment into an outlet on a circuit different from that to which the receiver is connected.
- Consult the dealer or an experienced radio/TV technician for help.

## Technical Support and Assistance

1. Visit the Advantech web site at [www.advantech.com/support](http://www.advantech.com/support) where you can find the latest information about the product.
2. Contact your distributor, sales representative, or Advantech's customer service center for technical support if you need additional assistance. Please have the following information ready before you call:
  - Product name and serial number
  - Description of your peripheral attachments
  - Description of your software (operating system, version, application software, etc.)
  - A complete description of the problem
  - The exact wording of any error messages

---

## Safety Instructions

1. Read these safety instructions carefully.
2. Keep this User Manual for later reference.
3. Disconnect this equipment from any AC outlet before cleaning. Use a damp cloth. Do not use liquid or spray detergents for cleaning.
4. For plug-in equipment, the power outlet socket must be located near the equipment and must be easily accessible.
5. Keep this equipment away from humidity.
6. Put this equipment on a reliable surface during installation. Dropping it or letting it fall may cause damage.
7. The openings on the enclosure are for air convection. Protect the equipment from overheating. **DO NOT COVER THE OPENINGS.**
8. Make sure the voltage of the power source is correct before connecting the equipment to the power outlet.
9. Position the power cord so that people cannot step on it. Do not place anything over the power cord.
10. All cautions and warnings on the equipment should be noted.
11. If the equipment is not used for a long time, disconnect it from the power source to avoid damage by transient overvoltage.
12. Never pour any liquid into an opening. This may cause fire or electrical shock.
13. Never open the equipment. For safety reasons, the equipment should be opened only by qualified service personnel.
14. If one of the following situations arises, get the equipment checked by service personnel:
  - The power cord or plug is damaged.
  - Liquid has penetrated into the equipment.
  - The equipment has been exposed to moisture.
  - The equipment does not work well, or you cannot get it to work according to the user's manual.
  - The equipment has been dropped and damaged.
  - The equipment has obvious signs of breakage.
15. **DO NOT LEAVE THIS EQUIPMENT IN AN ENVIRONMENT WHERE THE STORAGE TEMPERATURE MAY GO BELOW -40° C (-40° F) OR ABOVE 60° C (140° F). THIS COULD DAMAGE THE EQUIPMENT. THE EQUIPMENT SHOULD BE IN A CONTROLLED ENVIRONMENT.**
16. **CAUTION: DANGER OF EXPLOSION IF BATTERY IS INCORRECTLY REPLACED. REPLACE ONLY WITH THE SAME OR EQUIVALENT TYPE RECOMMENDED BY THE MANUFACTURER, DISCARD USED BATTERIES ACCORDING TO THE MANUFACTURER'S INSTRUCTIONS.**
17. This product is intended to be supplied by an UL certified DC source rated 9-32Vdc, 10-3A. Tma 50 degree C minimum, if need further assistance, please contact Advantech for further information.

The sound pressure level at the operator's position according to IEC 704-1:1982 is no more than 70 dB (A).

**DISCLAIMER:** This set of instructions is given according to IEC 704-1. Advantech disclaims all responsibility for the accuracy of any statements contained herein.

## Safety Precaution - Static Electricity

Follow these simple precautions to protect yourself from harm and the products from damage.

- To avoid electrical shock, always disconnect the power from your PC chassis before you work on it. Don't touch any components on the CPU card or other cards while the PC is on.
- Disconnect power before making any configuration changes. The sudden rush of power as you connect a jumper or install a card may damage sensitive electronic components.

## Battery Information

Batteries, battery packs and accumulators should not be disposed of as unsorted household waste. Please use the public collection system to return, recycle, or treat them in compliance with the local regulations.





# Contents

<b>Chapter 1</b>	<b>Overview .....</b>	<b>1</b>
1.1	Introduction .....	2
1.2	Specifications .....	2
1.2.1	General Specifications .....	2
1.2.2	Power Specifications .....	3
1.2.3	Touchscreen Specifications .....	3
1.2.4	Environment Specifications .....	3
1.2.5	Certifications .....	3
1.2.6	IP Grade .....	3
1.3	Dimensions .....	4
<b>Chapter 2</b>	<b>System Installation and Setup .....</b>	<b>5</b>
2.1	A Quick Tour .....	6
	Figure 2.1: Front View .....	6
	Figure 2.2: Side View .....	6
	Figure 2.3: I/O Connectors .....	7
2.2	Installation Procedures .....	8
2.2.1	Connecting Power Cord .....	8
	Figure 2.4: Connecting Power Cord .....	8
2.2.2	Connecting Keyboard and Mouse .....	8
2.2.3	Switching on the Panel PC .....	8
2.3	Installing Memory .....	9
2.4	Installing HDD .....	10
2.5	Installing M.2 .....	11
2.6	Installing Wireless LAN Card .....	12
2.7	Installing Expansion Card .....	15
2.8	Adjusting AT/ATX Functions .....	15
2.9	Grounding .....	15
2.10	Installing Hook .....	16
2.11	Solo Quick Installation .....	17
<b>Chapter 3</b>	<b>Jumper and Switch Settings .....</b>	<b>19</b>
3.1	Jumpers and Connectors .....	20
3.2	External COM Port Pin Assignments .....	22
<b>Chapter 4</b>	<b>Software Setup .....</b>	<b>23</b>
4.1	Installing Drivers .....	24
4.2	BIOS Setup Utility .....	24
4.2.1	Entering BIOS Setup .....	24
4.2.2	LCD Brightness Adjustment .....	25
4.2.3	COM5 Mode (RS422/485) Selection .....	27
4.2.4	Wake up by LAN .....	28
<b>Appendix A</b>	<b>RoHS List .....</b>	<b>31</b>
A.1	RoHS List .....	32





# Chapter 1

## Overview

This chapter gives background information on the PPC-3151 panel PC.

Sections include:

- Introduction
- Specifications
- Dimensions

## 1.1 Introduction

PPC-3151 is a new generation XGA (1024 x 768) panel PC. It is based on the 6th. Gen Intel Core processor and adopts the effective fanless thermal solution, featuring excellent performance and reliability of this product series. PPC-3151 offers rich IOs, including 3 COMs, 4 USBs and dual Giga Ethernet ports, which makes it easier to connect with any peripheral devices and integrating with machine manufacturing. Besides, it also provides PCIe/ PCI expansion for more applications. Lastly, its multi-control touchscreen is consistent with current operating experience and user habits.

## 1.2 Specifications

### 1.2.1 General Specifications

<b>Product Name</b>	PPC-3151			
<b>LCD Specification</b>	15" LCD			
<b>Display Type</b>	15" TFT LCD (LED backlight)			
<b>Max. Resolution</b>	1024 x 768			
<b>Color</b>	16.7M			
<b>Dot Pitch</b>	0.297 x 0.297 mm			
<b>Viewing Angle</b>	80° (Left), 80° (Right), 70° (Up), 70° (Down) (Typ.)			
<b>Luminance</b>	400 cd/m2(Typ.)			
<b>Contrast</b>	700 (Typ.)			
<b>Backlight Life</b>	50,000 hrs			
<b>Weight</b>	5.4 Kg (11.90 lb)			
<b>Dimension</b>	391.4 x 312.5 x 55.35 mm (15.41" x 12.3" x 2.18")			
<b>CPU</b>	Model	Base Frequency	Turbo	Cache
	i5-6300U	2.4GHz	3.0GHz	3M
<b>Memory</b>	1 x 260-pin slot, supports up to 16G DDR4			
<b>Storage</b>	1 x 2.5" SATA HDD/SSD			
<b>Network (LAN1, LAN2)</b>	2 x Giga Ethernet ports			
<b>I/O Connectors</b>	2 x RS-232 ports, 1 x RS-422/485 port, 4 x USB 3.0 connectors			
	2 x Giga Ethernet ports			
	1 x VGA port, 1 x DP connector			
	1 x Line-out, 1 x Mic-in, 2 x 1 W speaker (internal)			
	1 x Phoenix power connector, 1 x power switch			
<b>Expansion Slots</b>	1 x PCIe x1 (standard configuration)			
	1 x PCI (in accessory box)			
<b>Additional Expansion Slots</b>	1 x Mini PCIe card slot			
	1 x M.2 card slot (supported model: 22 x 42 mm, SATA interface)			
<b>OS</b>	Win 7(32Bit/64Bit)/Win 8.1(64Bit)/Win 10(64Bit)/Linux			

## 1.2.2 Power Specifications

<b>Power Consumption</b>	i5: 60 W (Test system: Windows7 64bit)
<b>Input Voltage</b>	9 - 32 Vdc, 10 ~ 3 A

**Note!** For its test conditions, please see Note 1.



## 1.2.3 Touchscreen Specifications

<b>Type</b>	5-point projective capacitive
<b>Light Transmission</b>	88%+/-5%
<b>Controller</b>	USB interface

## 1.2.4 Environment Specifications

<b>Operating temperature</b>	0 ~ 50°C (32 ~ 122°F) (SSD) 0 ~ 45°C (32 ~ 113°F) (HDD)
<b>Storage Temperature</b>	-40 ~ 60°C (-40 ~ 140°F)
<b>Relative Humidity</b>	10 ~ 95% @ 40°C (Non-condensing)
<b>Shock</b>	10 G peak acceleration (11 ms duration)
<b>Vibration</b>	5 ~ 500 Hz 1 G RMS

## 1.2.5 Certifications

<b>EMC</b>	BSMI, CE, FCC Class B
<b>Safety</b>	CB, CCC, UL, BSMI

## 1.2.6 IP Grade

<b>Front Panel Dustproof and waterproof</b>	IP65
---	------

### Note 1:

Power consumption of PPC-3151 is shown as below:

Test Software	Test Configuration	Test System
Burn-in 7.0	Memory: 8G DDR4 2133 HDD: 2.5" 500G SATA III IO: COM Port RS232 loopback x 2, USB 3.0 x 4	Win 7 (64bit)

# 1.3 Dimensions

Unit: mm

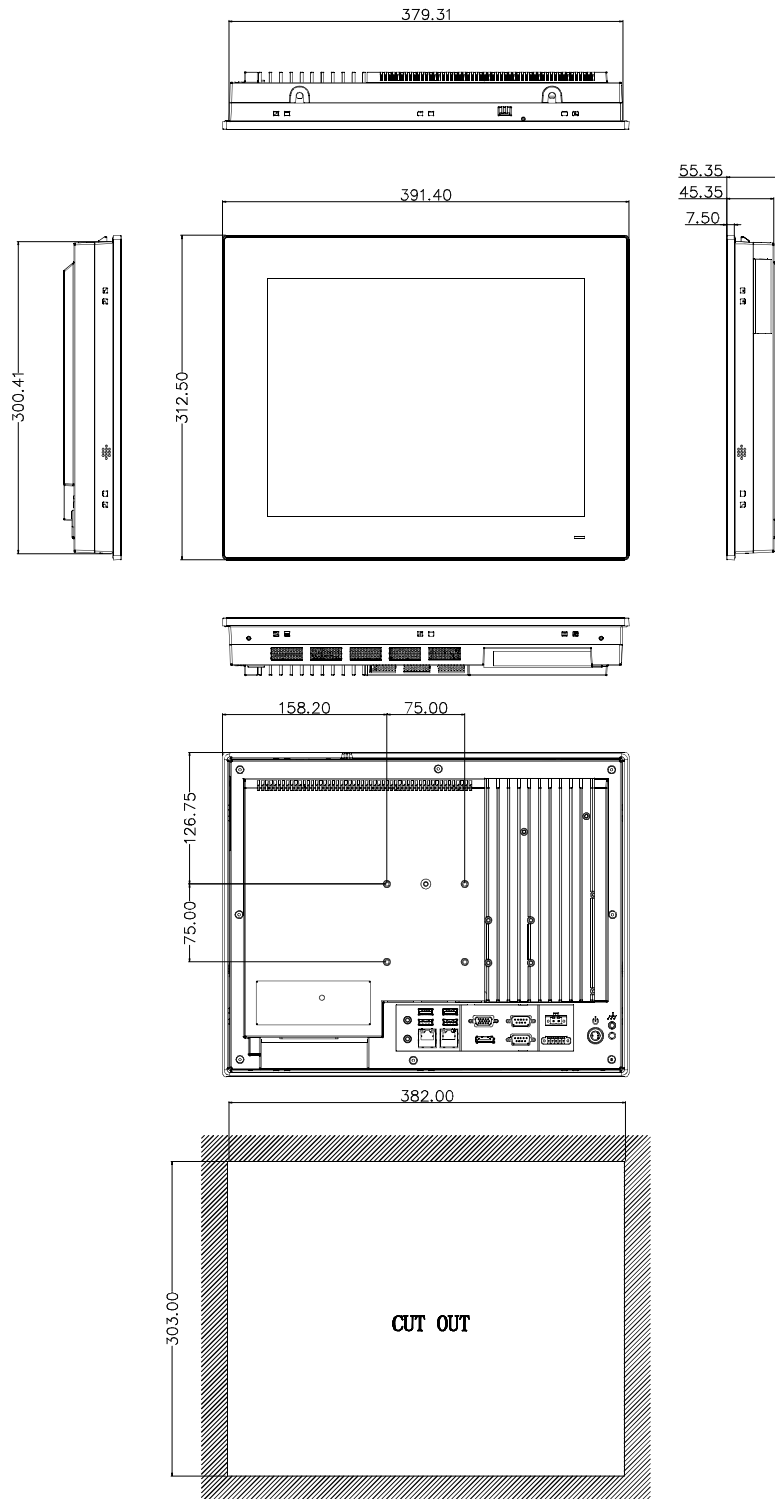

Cut-Out dimension: 382 x 303 mm

**Note!** Screw specification: M4; hole depth is 8 mm for maximum. Use suitable mounting apparatus to avoid risk of injury.



# Chapter 2

## System Installation and Setup

Sections include:

- A Quick Tour
- Installation Procedures
- Replacing Memory
- Installing HDD
- Installing M.2
- Installing Wireless LAN
- Installing Expansion Card
- Adjusting AT/ATX Functions
- Grounding
- Installing Hook
- Single Person Quick Installation Guide

## 2.1 A Quick Tour

Before you install the panel PC, please be familiar with the location and function of each control key, driver, connector and port (please refer to the following content and figures).

When the panel PC is placed on the desk, its front panel is shown as Figure 2.1.



Figure 2.1: Front View

Power status LED: Off (S5) Orange; Sleep (S3) Orange; On (S0) Blue.

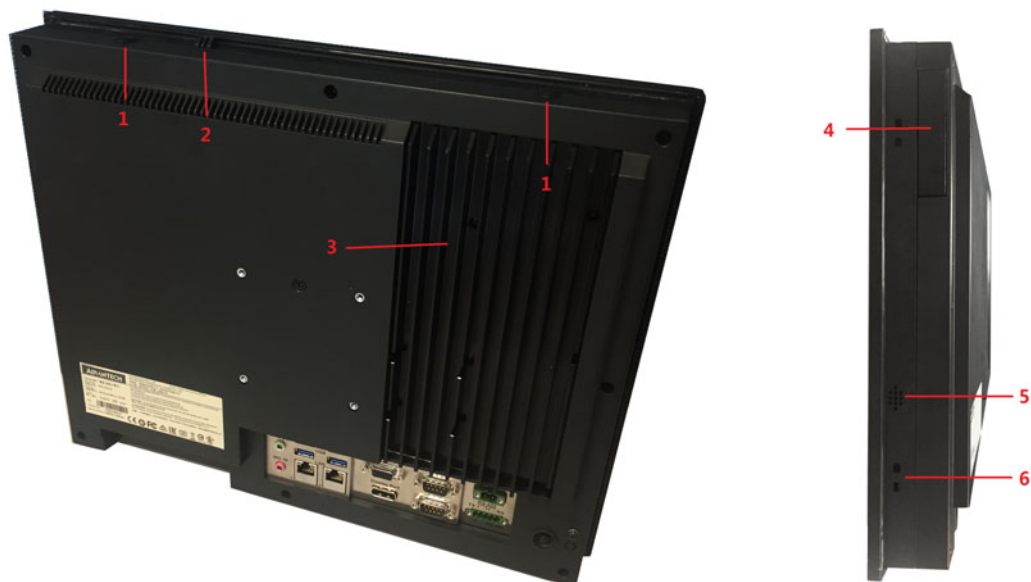
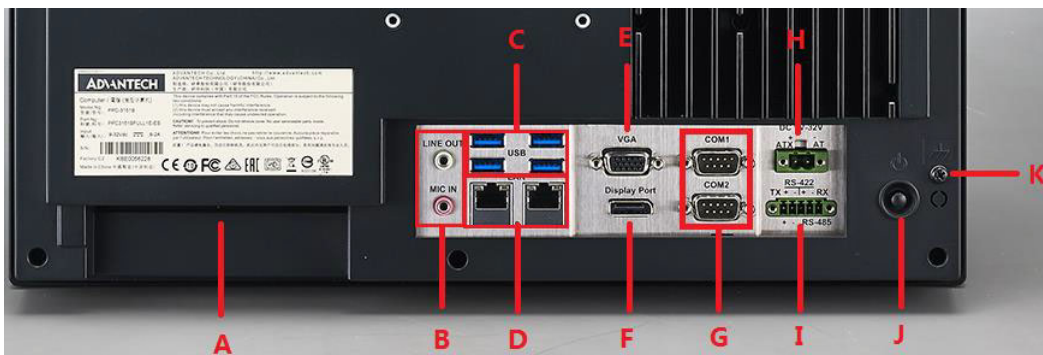

Figure 2.2: Side View

1. Antenna hole
2. Quick installation clip
3. CPU heatsink
4. Expansion slot for optional module
5. Speaker (left, right)
6. Hooking holes for panel installation (ten holes)

I/O connectors:



**Figure 2.3: I/O Connectors**

- A: PCI/PCIE expansion slots x 4
- B: Line-out / Mic-in
- C: 4 x USB 3.0
- D: 2 x Giga Ethernet ports
- E: VGA
- F: DP
- G: 2 x RS-232
- H: DC power connector (9-32V)
- I: 1 x RS-422/485
- J: Power switch
- K: Grounding screw

## 2.2 Installation Procedures

### 2.2.1 Connecting Power Cord

The panel PC supports 9 - 32 V DC power supply. Please always hold the plug end when connecting the power cord. Please follow the below procedures to connect the power cord:

1. Plug the 2-pin connector into the DC inlet of the panel PC.
2. Connect power cord with power adapter with the 3-pin female connector.



Figure 2.4: Connecting Power Cord

### 2.2.2 Connecting Keyboard and Mouse

Connect mouse and keyboard to the I/O connector of the panel PC. Refer to Figure 2.3, C, USB.

### 2.2.3 Switching on the Panel PC

Power switch is located at the lower right corner of the rear cover. Refer to Figure 2.3, J, Power switch.

**Note!** Power cord and adapter are optional.





## 2.3 Installing Memory

1. Unfasten the screws marked with red circles (see below left figure).
2. Pop-up the hook marked with a red oval (see below right figure) to remove the rear cover.



3. Unfasten the screws indicated in the below left figure and take out the heatsink, then replace the memory.

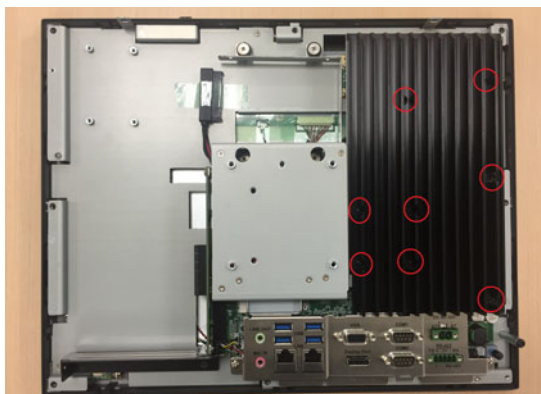

## 2.4 Installing HDD

1. Follow the procedures in Chapter 2.3 to remove the rear cover. Unfasten the screws marked with red circles and remove VESA holder below left, then take out the HDD bracket below right.

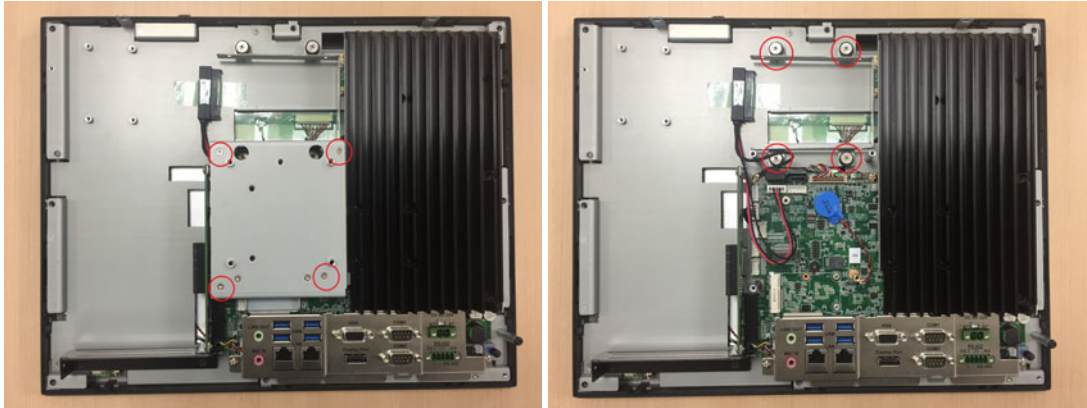

2. Take out 4 screws (see below) from the accessory box to secure the HDD onto the bracket, then replace and fix the HDD bracket.

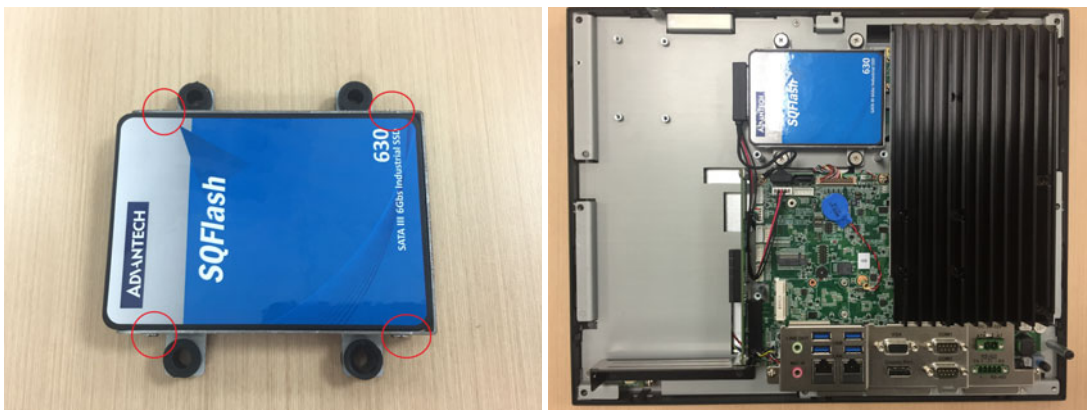

## 2.5 Installing M.2

1. Follow the procedures in Chapter 2.3 and 2.4 to remove rear cover and VESA holder.
2. Unfasten the screws marked with red circles, and then fix M.2 to the location marked with a red rectangle.

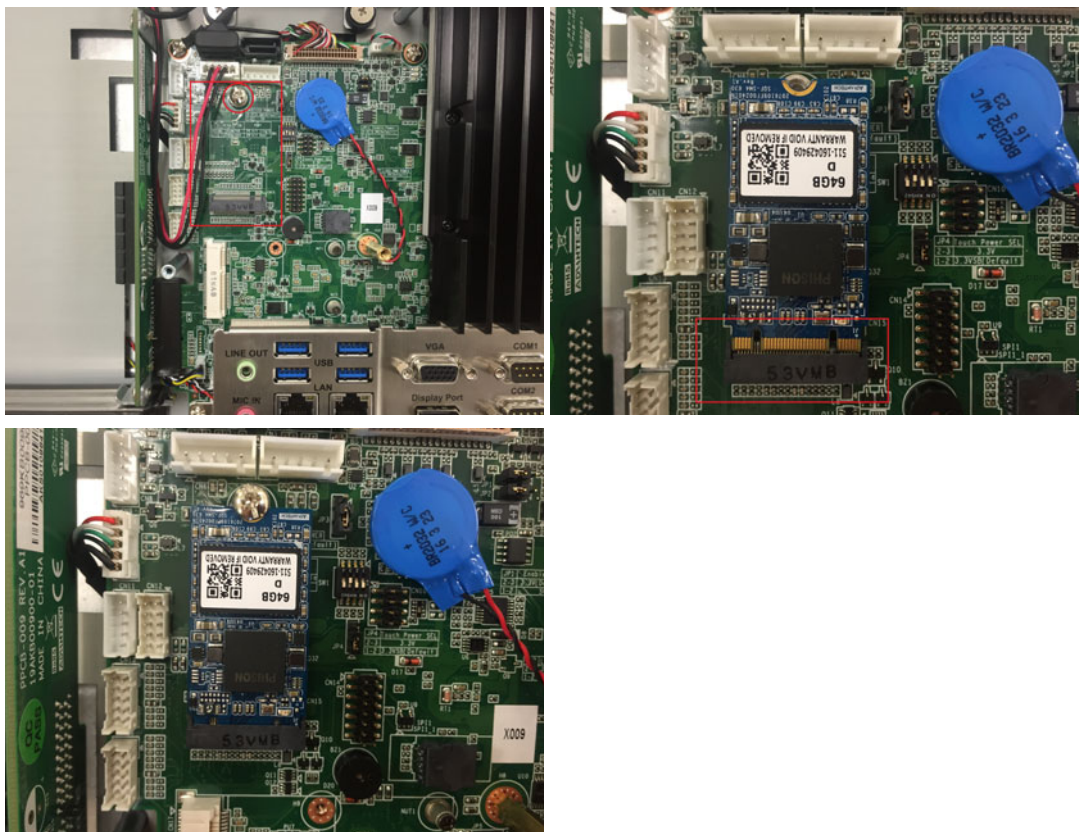

**Note!** Please note the pin direction when installing a M.2 device. Only 22 x 42mm M.2 device with a SATA interface is supported.



## 2.6 Installing Wireless LAN Card

1. Follow the procedures in Chapter 2.3 and 2.4 to remove rear cover and VESA holder.
2. The installation of a full-size card is shown as below. Unfasten the screws marked with red circles and then secure the card to the location with a red rectangle.

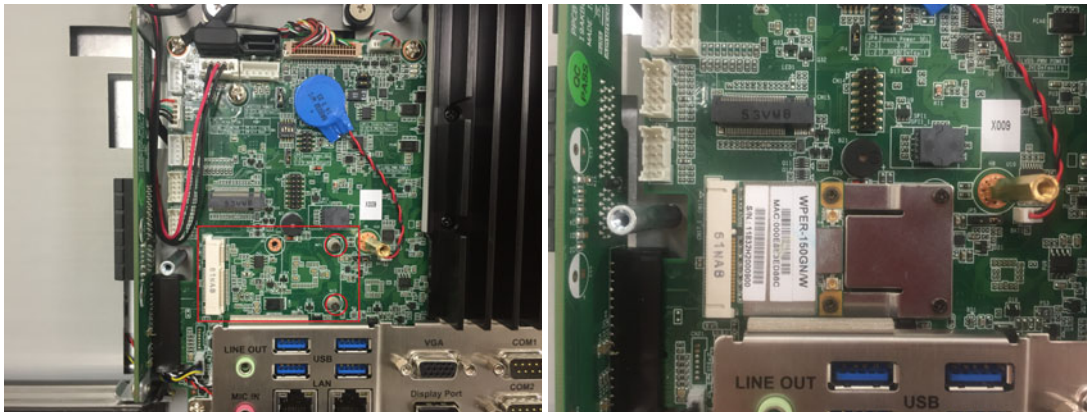

3. The installation of a half-size card is shown as below. Take out copper cylinders and screws from the accessory box.

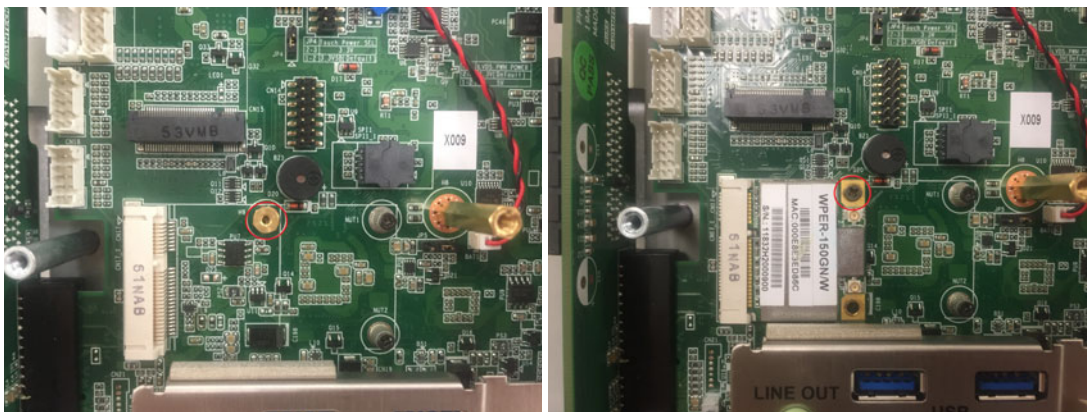

4. Please refer to the below to connect the cables of wireless LAN card module to antenna bracket. Note the installation direction of cable end, screw caps and washers. To make the antenna installation easier, please firstly remove two brackets marked with the red rectangles, and then replace them when the installation is completed.

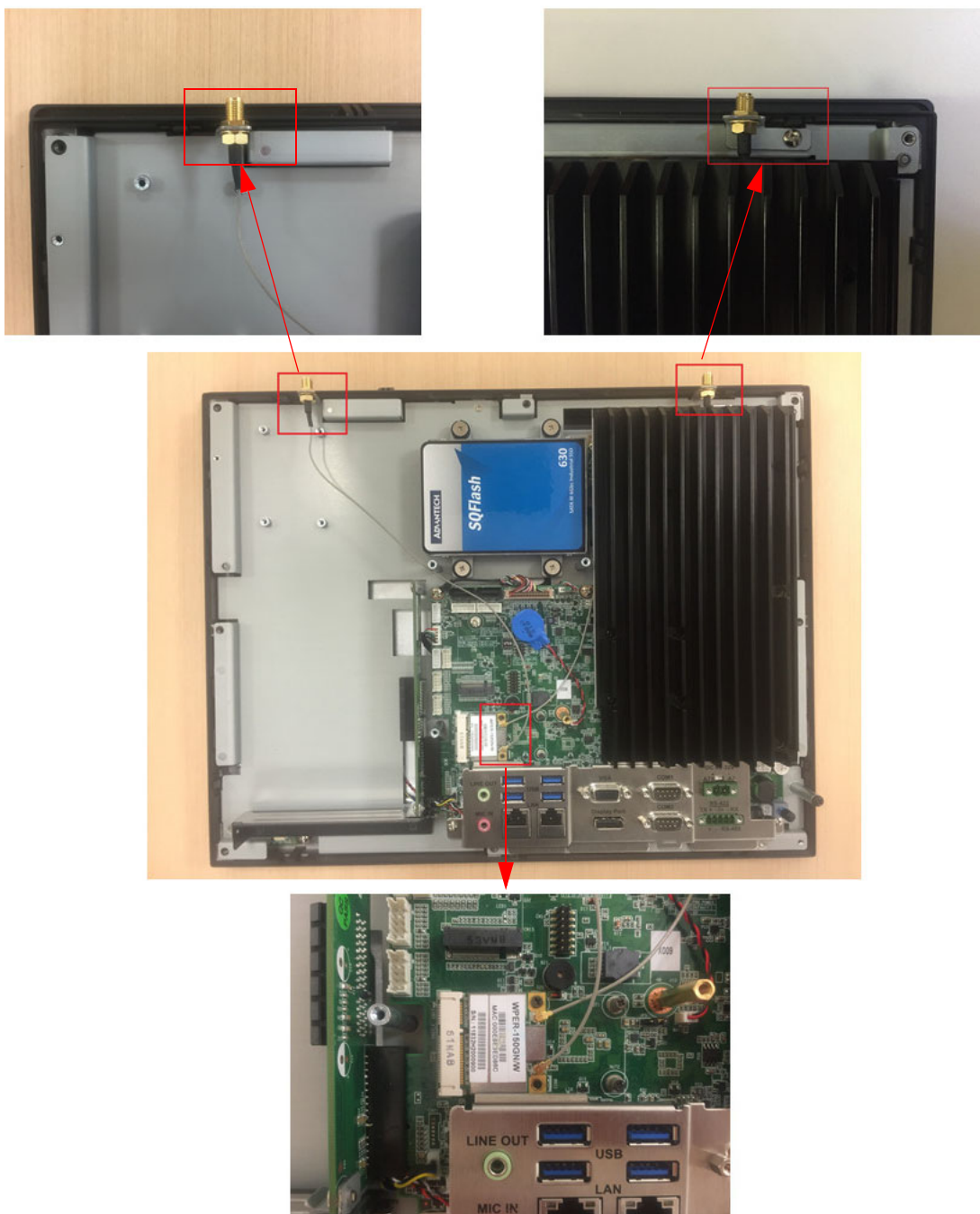

5. Remove two plugs on the rear cover as shown in the below.

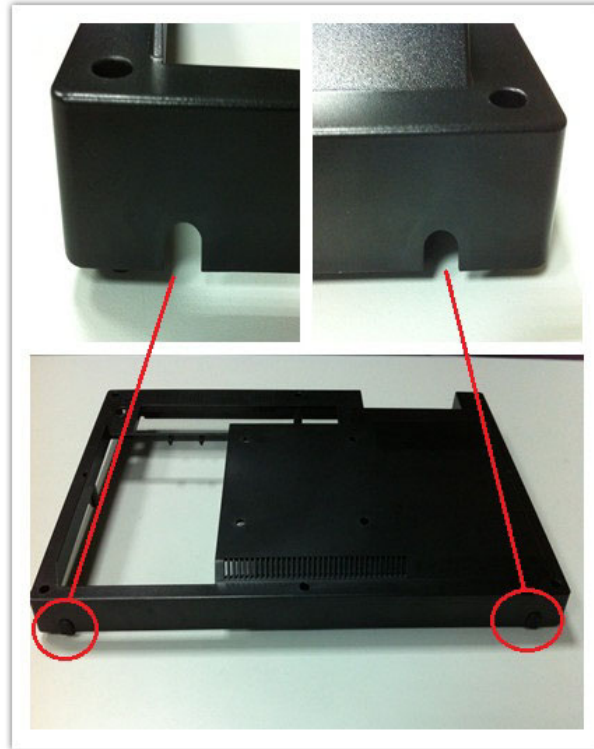

6. Then replace the rear cover and install the antenna of wireless LAN card module.



**Note!** *Advantech wireless LAN card module (PN: PPC-WLAN-A1E) is optional for you.*



## 2.7 Installing Expansion Card

1. Follow the procedures in Chapter 2.3 to remove rear cover
2. Remove the screws and the blank plate marked with a red rectangle to install the expansion card. The product comes with a PCIe riser card, and a PCI riser card is also provided in the accessory box for additional use.

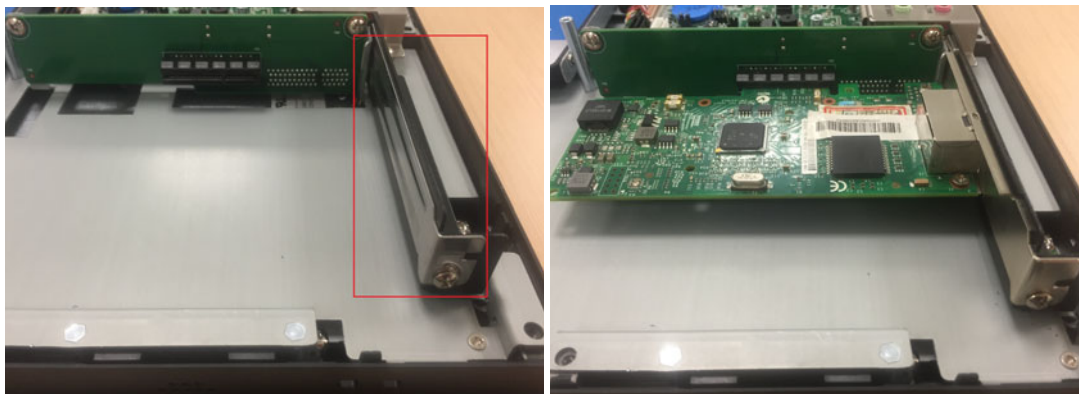

**Note!** The maximum supported size of the expansion card is 176mm x 107mm.



## 2.8 Adjusting AT/ATX Functions

You can adjust AT or ATX function by the internal switch indicated by the red rectangle without removing the rear cover.



## 2.9 Grounding

Grounding screw is marked with a red circle in below. It is recommended that the product with a capacitive screen should be properly grounded.



### 警告!

1. 为防止电容屏在使用中出现误动作现象，建议使用电容屏时将整机接地，方式请参考用户手册2.9章节；
2. 第一次或重新安装系统后，请依照附件盒内的用户指南，运行电容屏校正程式。

### CAUTION:

1. To avoid malfunction of P-CAP T/S, suggest connecting the machine to the ground while using. Please kindly refer to the user manual, Chapter 2.9.
2. Follow the installation guide for instructions on how to calibrate the Projected Capacitive Touch after installing the operating system.

## 2.10 Installing Hook

Please refer to the below figure:

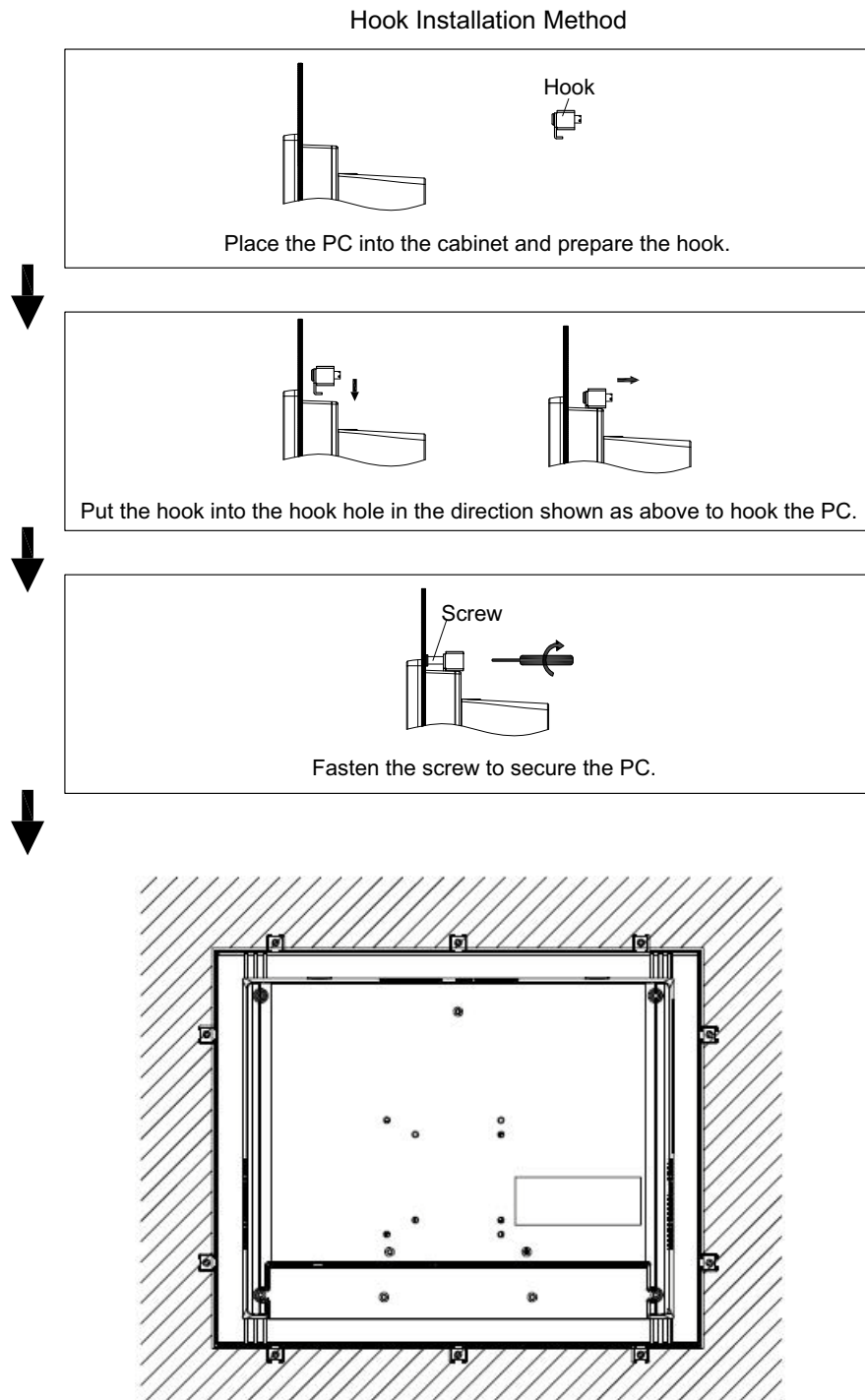



## 2.11 Solo Quick Installation

Please follow the below procedures to complete the wall mount by yourself.

1. Unfasten the two screws at the bottom as shown in below.

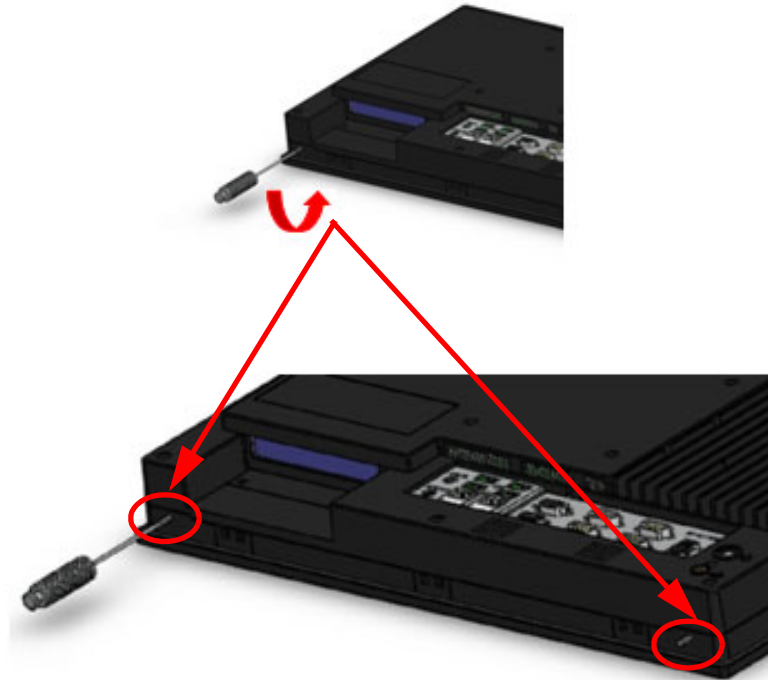

2. Please refer to the below figure to place and push the panel PC into the opening on the wall, then the hook will secure the PC onto the wall.

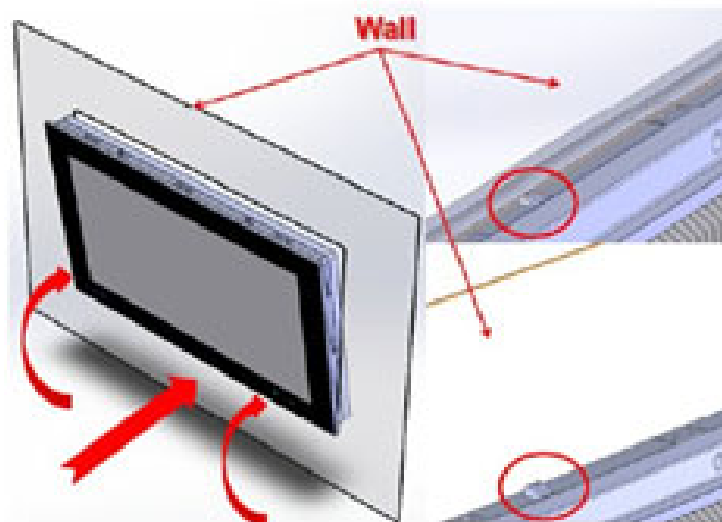

3. Here the wall mount is completed. Then please refer to Chapter 2.10 "Installing Hook" to fasten the hook screw to firmly secure the panel PC.

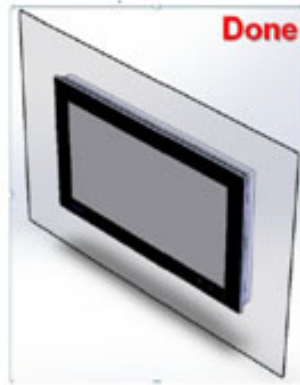

**Note!** *It is recommended that the panel inlaid depth should be less than 2mm (0.079") according to "Quick Installation Guide". In other circumstances, it is recommended that the panel inlaid depth should be less than 3mm (0.118").*



# Chapter 3

## Jumper and Switch Settings

Sections include:

- Jumpers and Connectors
- External COM Port & DIO Switch and Pin Assignments

## 3.1 Jumpers and Connectors

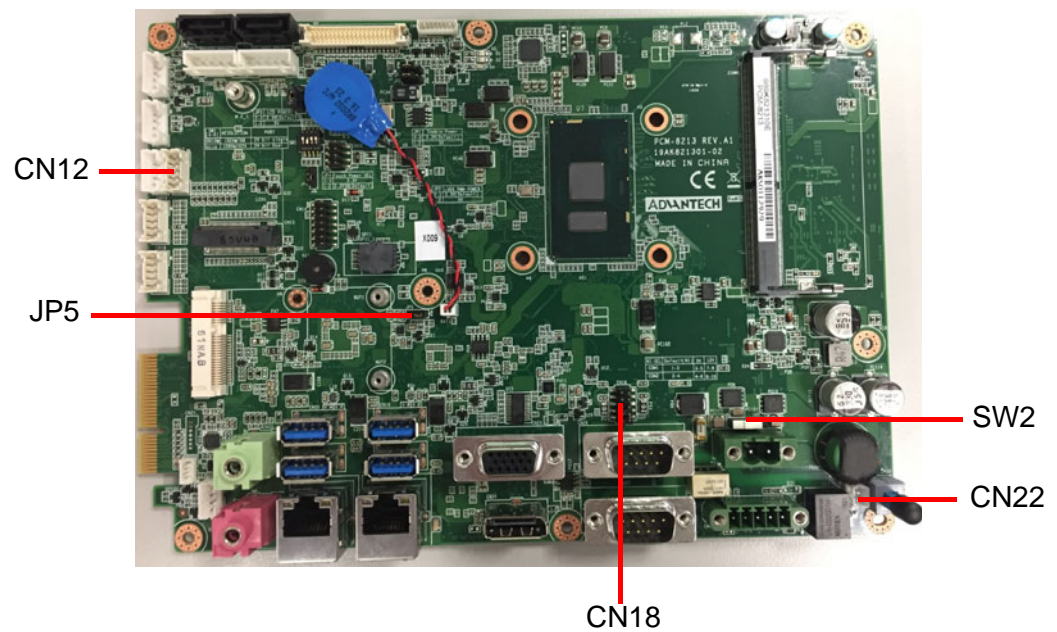

Connector	Function
CN12	GPIO
CN18	COM Pin9 power selection
CN22	Power button
SW2	AT/ATX selection
JP5	Clear CMOS

JP5	Icon	Clear CMOS	
(1-2)	P9	Normal *	Default *
(2-3)	P10	Clear CMOS	

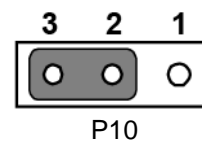
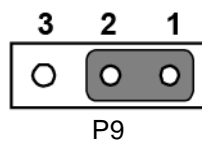

CN18	COM1/2 RI type selection		
(1-3)/(2-4)	P9/P10	COM1/COM2 RI	Default *
(3-5)/(4-6)	P11/P12	COM1/COM2 5V	
(7-9)/(8-10)	P13/P14	COM1/COM2 12V	

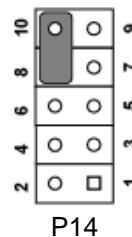
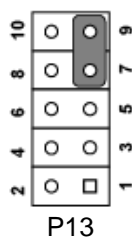
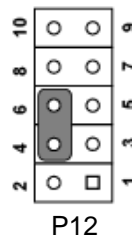
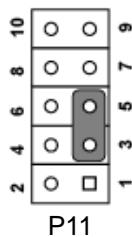
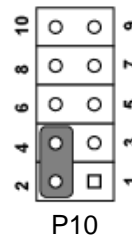
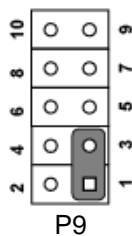

CN12	Pin	Signal
	1	GND
	2	GPIO4
	3	GPIO0
	4	GPIO5
	5	GPIO1
	6	GPIO6
	7	GPIO2
	8	GPIO7
	9	GPIO3
	10	5V

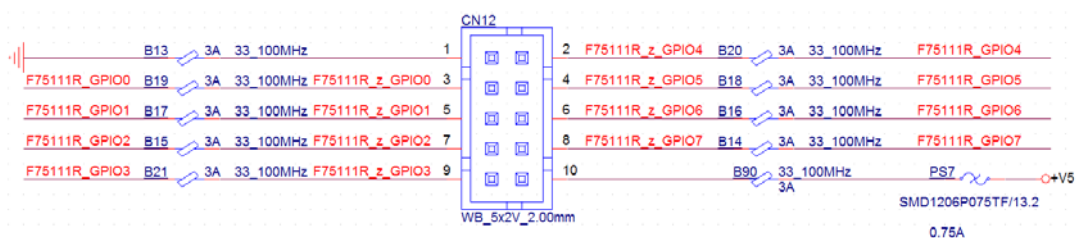

## 3.2 External COM Port Pin Assignments



COM 1, COM 2 (RS232, Pin9 supports 5 V/12 V output)  
COM 3 RS-422/485

COM1-2:

Pin	COM1/COM2
1	DCD
2	RXD
3	TXD
4	DTR
5	GND
6	DSR
7	RTS
8	CTS
9	RING or 5V/12V output

Pin9 is set as RI signal in COM port by default, and could be set as 5V/12V output by Jumper. 12V: Max. 200 mA; 5V: Max. 500 mA.

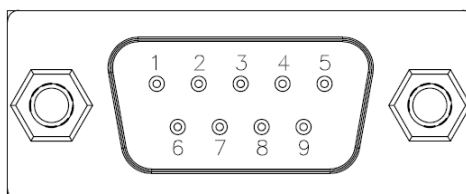

**COM3:** RS422/485 supports isolation voltage of 1000 VDC, which can be selected by BIOS.

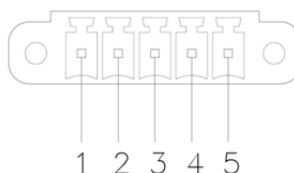

Pin	1	2	3	4	5
RS422	TX+	TX-	RX+	RX-	GND
RS485	D+	D-			GND

UART RS485 auto flow control

COM5 supports RS485 auto flow control function.

When enabling the RS485 auto control function, it will automatically drive RTS# pin to logic high or low for flow control.

# Chapter 4

## Software Setup

Sections include:

- Installing Drivers
- BIOS Setup Utility

## 4.1 Installing Drivers

When you install the system for the first time, please install the corresponding drivers in advance to make sure all the functions could run normally. Please select the drivers to be installed based on the OS you use. Please go to Advantech official website to get the latest versions of drivers: <http://www.advantech.com.cn/>

## 4.2 BIOS Setup Utility

### 4.2.1 Entering BIOS Setup

You can enter BIOS setup utility by pressing "Delete".

You should always press "F4" to save the settings you have made and exit the setup utility, otherwise those settings will not be saved in BIOS.

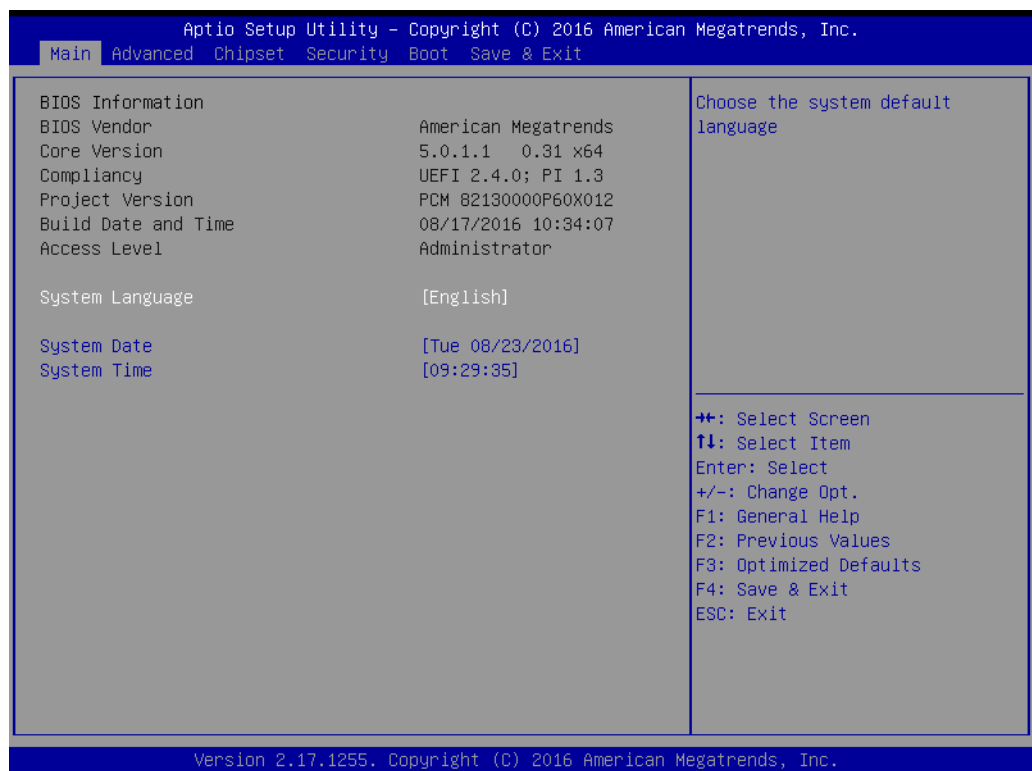



## 4.2.2 LCD Brightness Adjustment

1. Select "System Agent(SA) Configuration" under "Chipset" tab.

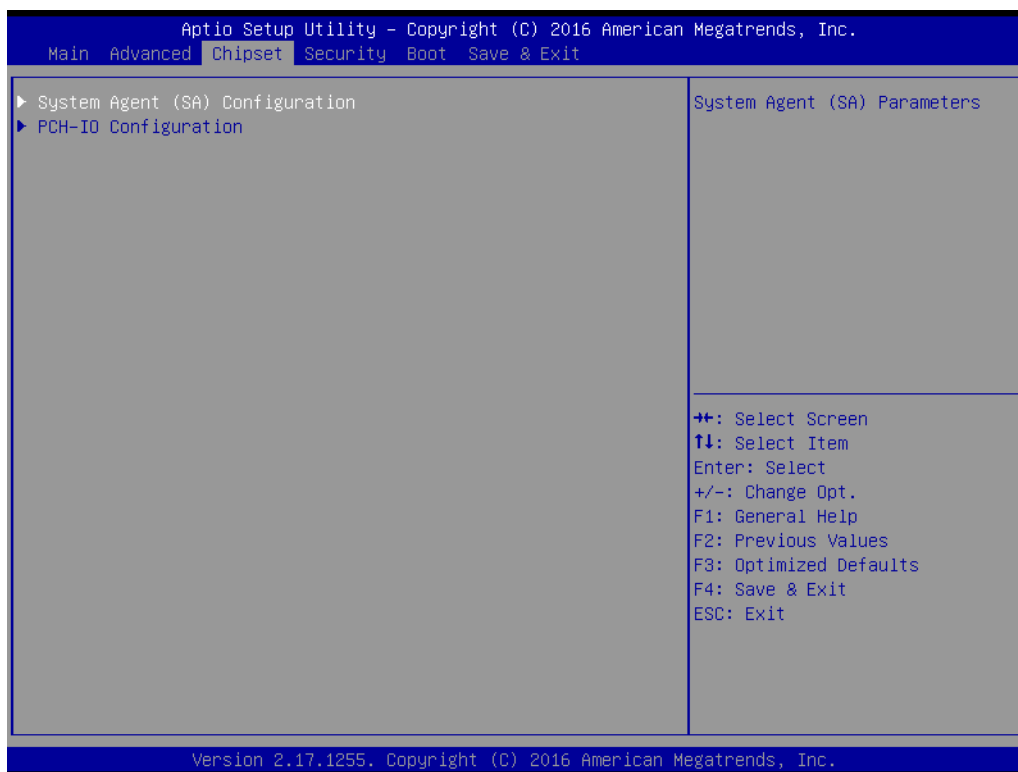

2. Then choose "Graphics Configuration" under "System Agent (SA) Configuration" item.



3. Select "LCD Control" under "Graphics Configuration".

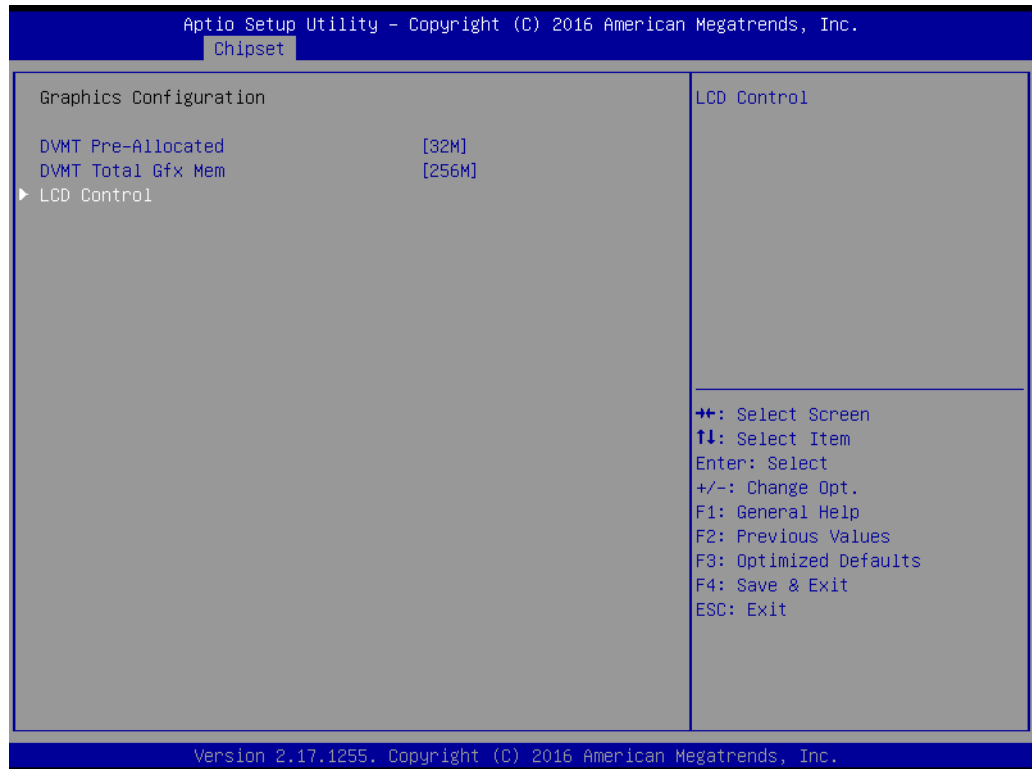

4. Select "Brightness Manual Control" under "Brightness Control", and there will be 6 brightness options to choose.

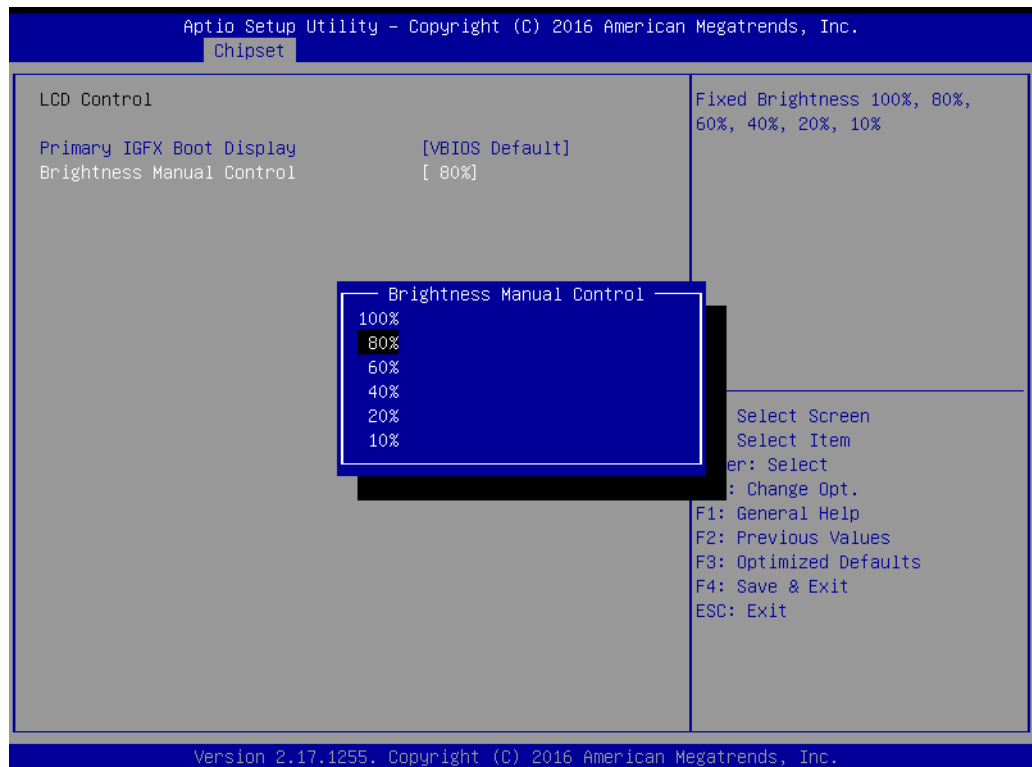

### 4.2.3 COM5 Mode (RS422/485) Selection

1. Select "NCT6106D Super IO Configuration" under "Advanced" tab.

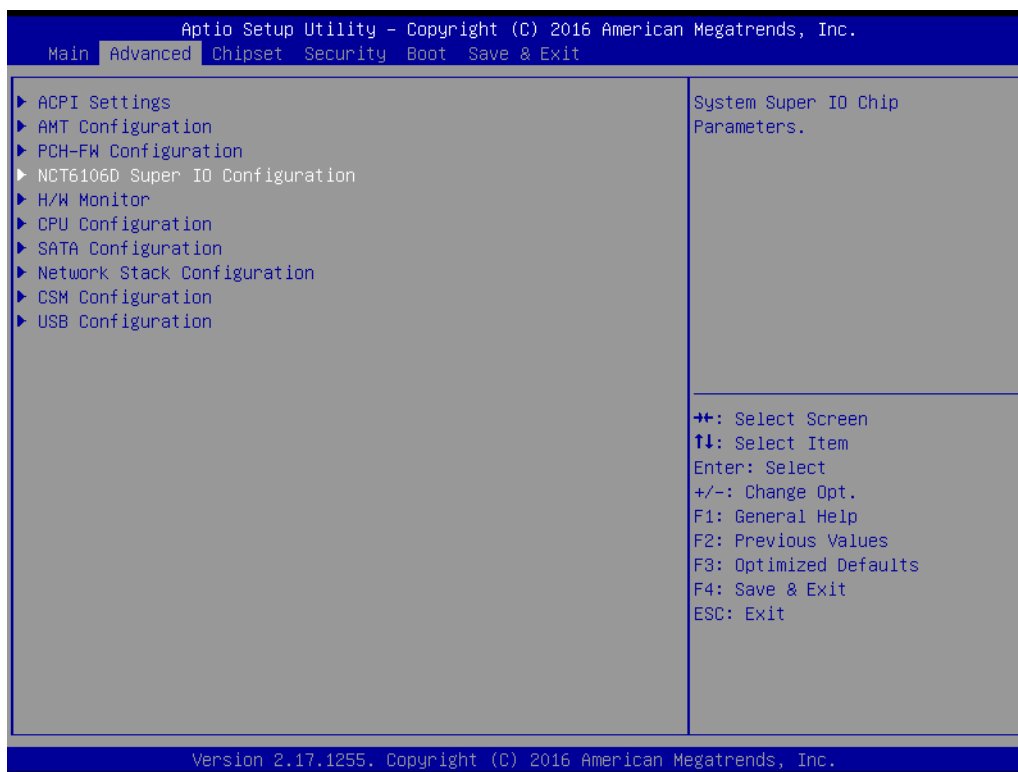

2. Then choose "Serial Port5 Configuration" under "NCT6106D Super IO Configuration" item.

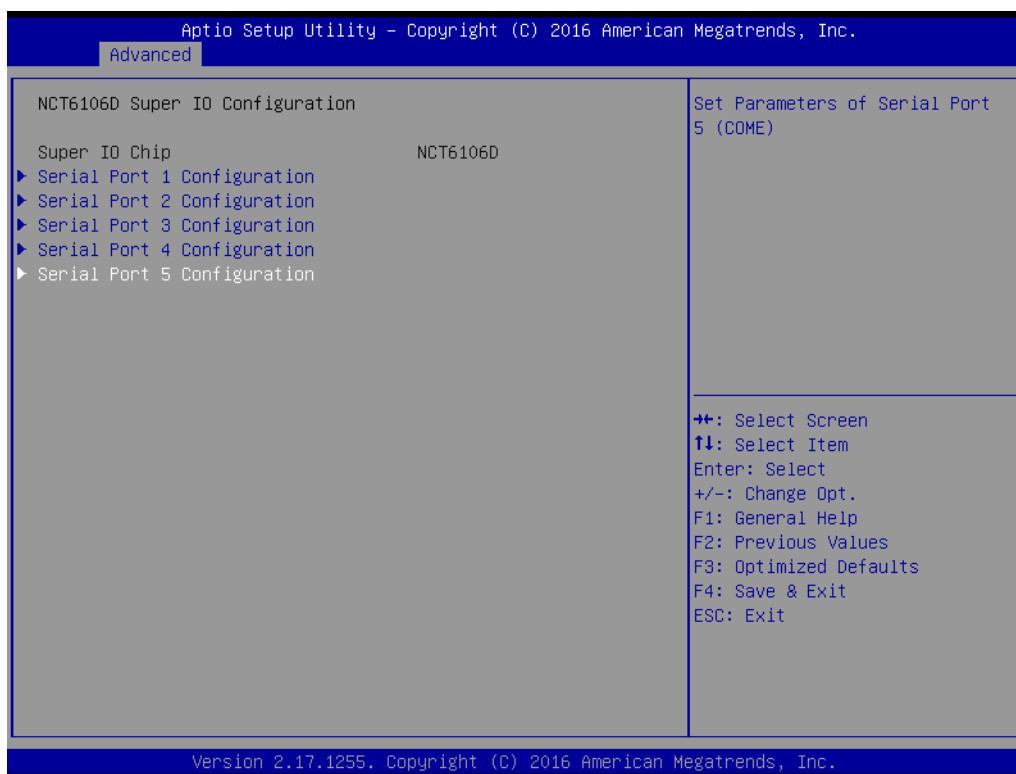

3. Click "Serial Port 5 Configuration" item to choose the operating mode of COM5.

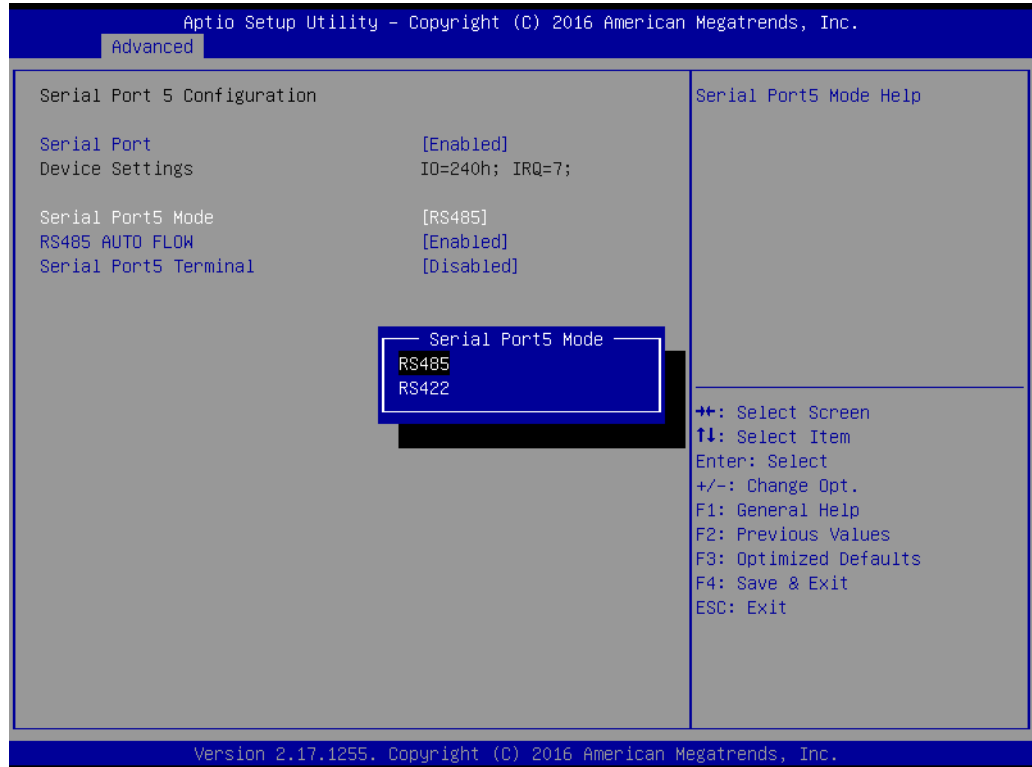

#### 4.2.4 Wake up by LAN

1. Select "PCH-IO Configuration" under "Chipset" tab.



- Set “Deep Sleep” as “Disabled”. Then set “Wake On By PCIE Wake” and “Wake On By LAN1 (219LM)” as “Enabled”.

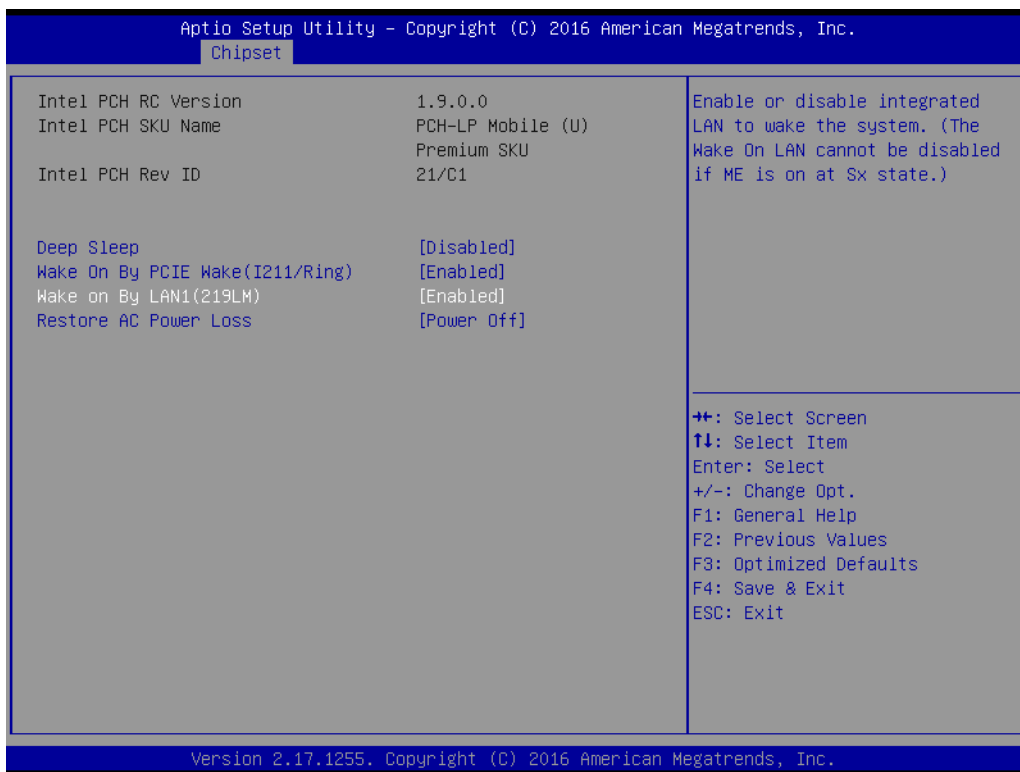

- Save all the settings and exit. Then enter the OS.
- Right-click on “Computer” and select “Manage” to pop up “Computer Management” window.

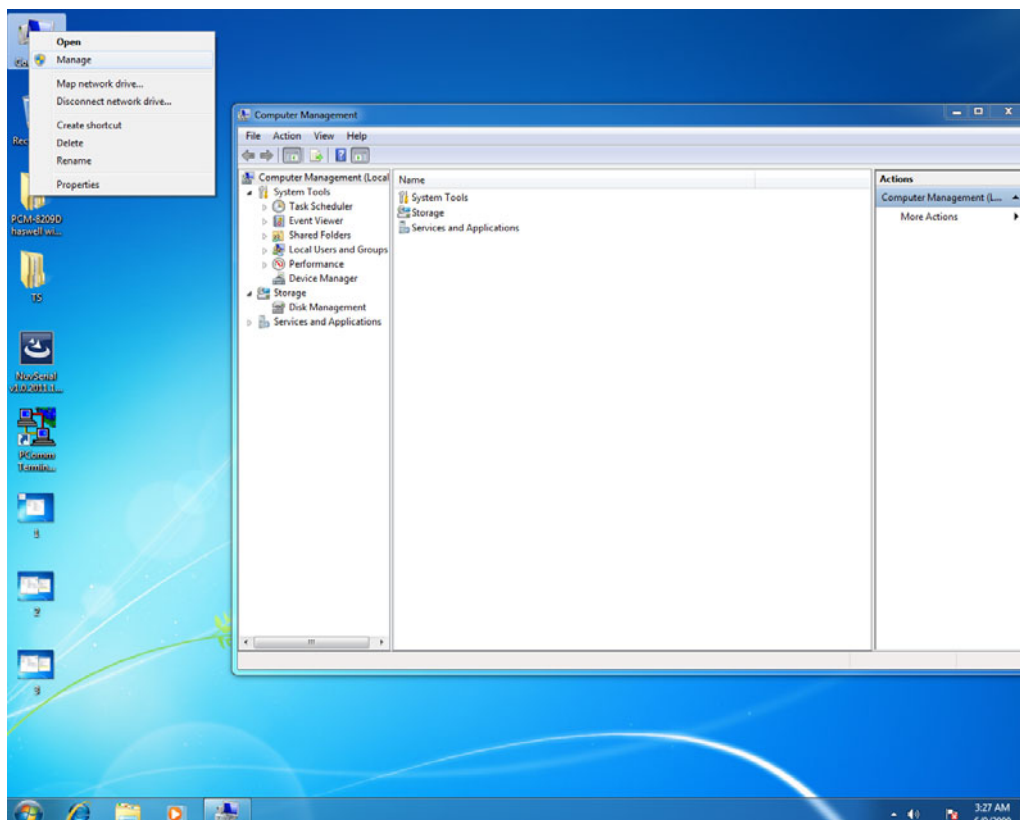

- Click "Device Manager" to select "Network adapters". Then right-click on the LAN port you want to use and select "Properties" to pop up "Intel(R) Ethernet" window.

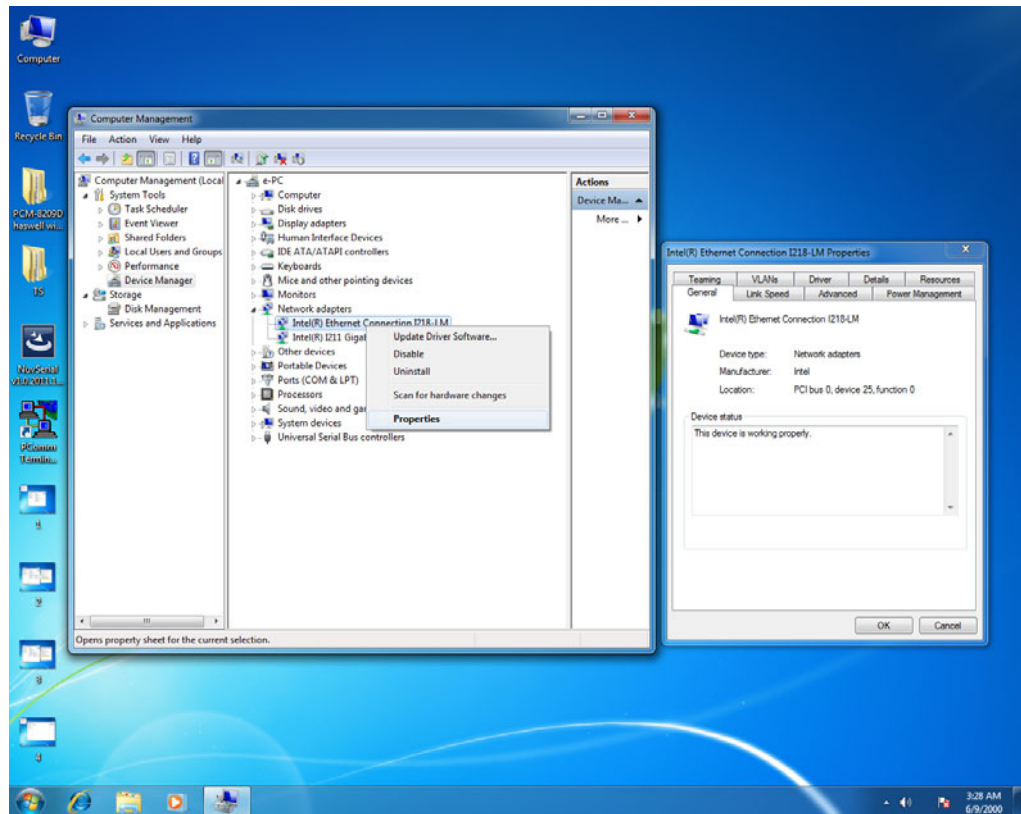

- In "Intel(R) Ethernet" window, go to "Power Management" tab and check the boxes of "Work On Magic Packet", "Work On Pattern Match" and "Work On Magic Packet From Power Off State".

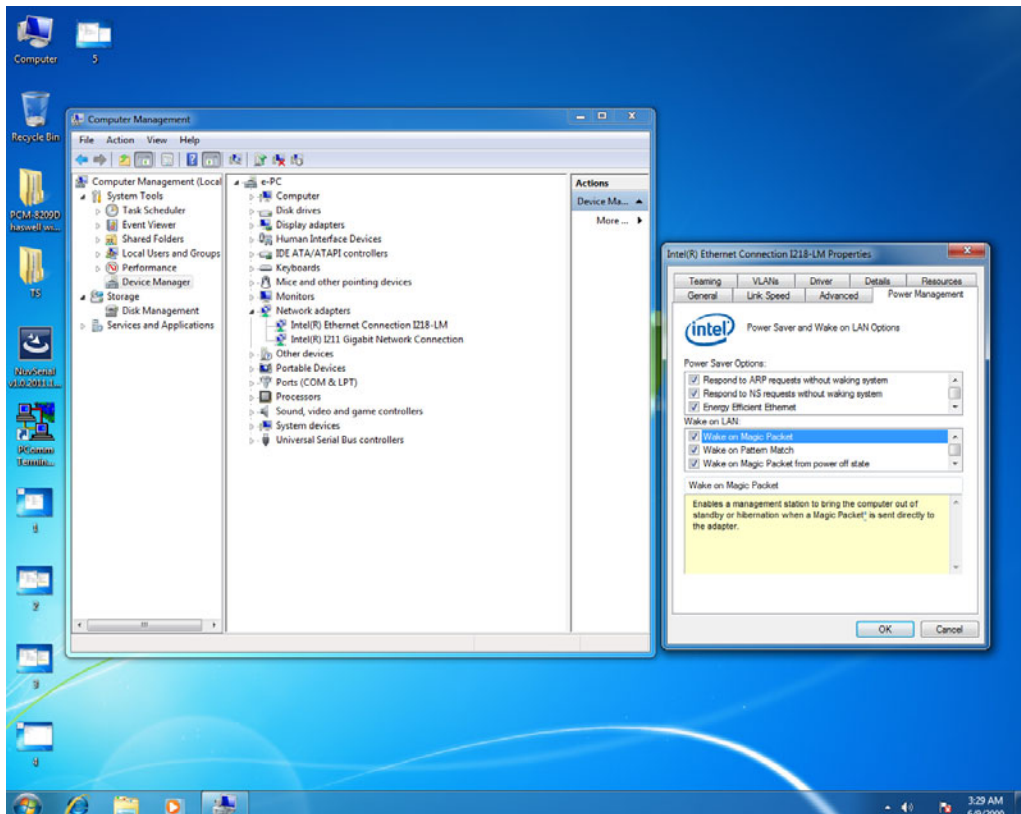

# Appendix **A**

RoHS List

## A.1 RoHS List

Dear Customer,

Thanks for choosing Advantech Product, to comply with China Electronic Industry Standard SJ/T11364 which require Marking for the Restriction of the Use of Hazardous Substances in Electrical and Electronic Products, herein report to you product's environmental protection as follows.

Please disregard this notice if the product is not to be sold / installed in China.

Model name	PPC-31X1S Series					
Substance	Name and concentration of hazardous substances contained in product					
	(Pb)	(Hg)	(Cd)	(Cr(VI))	(PBB)	(PBDE)
PCB	X	O	O	O	O	O
Panel	X	O	O	O	O	O
DDR	X	O	O	O	O	O
Front Bezel Rear Cover	X	O	O	O	O	O
Others	X	O	O	O	O	O

O: Represent the concentration for this hazardous substance in all homogeneous materials of the part Comply with the limit of the standard of GB/T 26572.  
X: Represent the concentration for this hazardous substance at least in one homogeneous material of this part exceeds the limit of the standard of GB/T 26572.

Enterprise statements: (for those exceeding the standard)  
Content:  
The mark of EPUP(Environmental Protection Use Period) in product label means in this period, by the normal operation mode, the hazardous substances won't leak out and deviate, so the product use won't result in serious environmental pollution, human injury or property loss, meanwhile, please don't take this period as the warranty date.  
The products which attach with pollution control mark can be recycled, and should not be discarded at will.





## [www.advantech.com](http://www.advantech.com)

Please verify specifications before quoting. This guide is intended for reference purposes only.

All product specifications are subject to change without notice.

No part of this publication may be reproduced in any form or by any means, electronic, photocopying, recording or otherwise, without prior written permission of the publisher.

All brand and product names are trademarks or registered trademarks of their respective companies.

© Advantech Co., Ltd. 2017