

SAMSUNG

USER MANUAL

The Sero

LS05T

Thank you for purchasing this Samsung product.

To receive more complete service, please register your product at www.samsung.com



Model _____ Serial No. _____

If you have any questions, please call us at 1-800-SAMSUNG (1-800-726-7864) for assistance.

Before Reading This User Manual

This TV comes with this user manual and an embedded e-Manual.

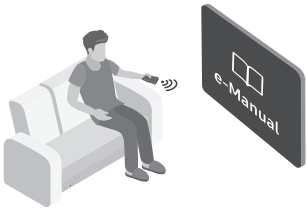



Before reading this user manual, review the following:

	<p>User Manual</p>	<p>Read this provided user manual to see information about product safety, installation, accessories, initial configuration, and product specifications.</p>
	<p>e-Manual</p>	<p>For more information about this TV, read the e-Manual embedded in the product.</p> <ul style="list-style-type: none"> To open the e-Manual, <ul style="list-style-type: none">   Settings > Support > Open e-Manual





Scan this QR code with your smart device to visit Samsung's online Customer Service Center. You can also use your PC to visit "www.samsung.com" and click Support. On the website, you can download the manuals and see its contents on your PC or mobile device.

Learning the e-Manual's assistance functions

	<p>Search</p>	<p>Select an item from the search results to load the corresponding page.</p>
	<p>Index</p>	<p>Select a keyword to navigate to the relevant page.</p>
	<p>Sitemap</p>	<p>It displays the lists for each item in e-Manual.</p>
	<p>Recently Viewed Topics</p>	<p>Select a topic from the list of recently viewed topics.</p>

- Some menu screens cannot be accessed from the e-Manual.

Learning the functions of the buttons that appear on e-Manual topic pages

	<p>Try Now</p>	<p>Allows you to access the corresponding menu item and try out the feature right away.</p>
	<p>Link</p>	<p>Access an underlined topic referred to on an e-Manual page immediately.</p>

Warning! Important Safety Instructions

Please read the Safety Instructions before using your TV.

Refer to the table below for an explanation of symbols which may be on your Samsung product.

CAUTION			Class II product: This symbol indicates that a safety connection to electrical earth (ground) is not required. If this symbol is not present on a product with a power cord, the product MUST have a reliable connection to protective earth (ground).
RISK OF ELECTRIC SHOCK. DO NOT OPEN.			
CAUTION: TO REDUCE THE RISK OF ELECTRIC SHOCK, DO NOT REMOVE COVER (OR BACK). THERE ARE NO USER SERVICEABLE PARTS INSIDE. REFER ALL SERVICING TO QUALIFIED PERSONNEL.			AC voltage: Rated voltage marked with this symbol is AC voltage.
	This symbol indicates that high voltage is present inside. It is dangerous to make any kind of contact with any internal part of this product.		DC voltage: Rated voltage marked with this symbol is DC voltage.
	This symbol indicates that this product has included important literature concerning operation and maintenance.		Caution. Consult instructions for use: This symbol instructs the user to consult the user manual for further safety related information.

- The slots and openings in the cabinet and in the back or bottom are provided for necessary ventilation. To ensure reliable operation of this apparatus and to protect it from overheating, these slots and openings must never be blocked or covered.
 - Do not place this apparatus in a confined space, such as a bookcase or built-in cabinet, unless proper ventilation is provided.
 - Do not place this apparatus near or over a radiator or heat register, or where it is exposed to direct sunlight.
 - Do not place vessels (vases etc.) containing water on this apparatus, as this can result in a fire or electric shock.
- Do not expose this apparatus to rain or place it near water (near a bathtub, washbowl, kitchen sink, or laundry tub, in a wet basement, or near a swimming pool, etc.). If this apparatus accidentally gets wet, unplug it and contact an authorized dealer immediately.
- This apparatus uses batteries. In your community, there might be environmental regulations that require you to dispose of these batteries properly. Please contact your local authorities for disposal or recycling information.
- Do not overload wall outlets, extension cords, or adaptors beyond their capacity, since this can result in fire or electric shock.
- Power-supply cords should be placed so that they are not likely to be walked on or pinched by items placed upon or against them. Pay particular attention to cords at the plug end, at wall outlets, and at the point where they exit from the appliance.

- To protect this apparatus from a lightning storm, or when left unattended and unused for long periods of time, unplug it from the wall outlet and disconnect the antenna or cable system. This will prevent damage to the set due to lightning and power line surges.
- Before plugging in the AC power cord of the TV, make sure that the operational voltage of the TV matches the voltage of your local electrical power supply. Refer to the power specifications section of the manual and/or the power supply label on the product for voltage and amperage information.
- Never insert anything metallic into the open parts of this apparatus. This may cause electric shock.
- To avoid electric shock, never touch the inside of this apparatus. Only a qualified technician should open this apparatus.
- Be sure to plug in the power cord until it is firmly seated. When unplugging the power cord from a wall outlet, always pull on the power cord's plug. Never unplug it by pulling on the power cord. Do not touch the power cord with wet hands.
- If this apparatus does not operate normally - in particular, if there are any unusual sounds or smells coming from it - unplug it immediately and contact an authorized dealer or Samsung service center.
- Be sure to pull the power plug out of the outlet if the TV is to remain unused or if you are going to leave the house for an extended period of time (especially when children, elderly, or disabled people will be left alone in the house).
 - Accumulated dust can cause an electric shock, an electric leakage, or a fire by causing the power cord to generate sparks and heat or by causing the insulation to deteriorate.
- Be sure to contact an authorized Samsung service center for information if you intend to install your TV in a location with heavy dust, high or low temperatures, high humidity, chemical substances, or where it will operate 24 hours a day such as in an airport, a train station, etc. Failure to do so may lead to serious damage to your TV.
- Use only a properly grounded plug and wall outlet.
 - An improper ground may cause electric shock or equipment damage. (Class I Equipment only.)
- To turn off this apparatus completely, disconnect it from the wall outlet. To ensure you can unplug this apparatus quickly if necessary, make sure that the wall outlet and power plug are readily accessible.
- Store the accessories (batteries, etc.) in a location safely out of the reach of children.
- Do not drop or strike the product. If the product is damaged, disconnect the power cord and contact a Samsung service center.
- To clean this apparatus, unplug the power cord from the wall outlet and wipe the product with a soft, dry cloth. Do not use any chemicals such as wax, benzene, alcohol, thinners, insecticide, air fresheners, lubricants, or detergents. These chemicals can damage the appearance of the TV or erase the printing on the product.
- Do not expose this apparatus to dripping or splashing.
- Do not dispose of batteries in a fire.
- Do not short-circuit, disassemble, or overheat the batteries.
- **CAUTION:** There is danger of an explosion if you replace the batteries used in the remote with the wrong type of battery. Replace only with the same or equivalent type.
- **WARNING - TO PREVENT THE SPREAD OF FIRE, KEEP CANDLES AND OTHER ITEMS WITH OPEN FLAMES AWAY FROM THIS PRODUCT AT ALL TIMES.**
- Use care when touching the TV after it has been on for some time. Some parts can be warm to the touch.
- **State of California Proposition 65 Warning**
 **WARNING:** Cancer and Reproductive Harm - www.P65Warnings.ca.gov



Internet security

Samsung takes a number of steps to protect its Internet-compatible Smart TVs against unauthorized incursions and hacking. For example, certain sensitive communications between the TV and the Internet servers are encrypted. In addition, the TV's operating system has adopted controls to prevent the installation of unauthorized applications. Although we take steps to protect your Smart TV and personal information, no Internet-connected device or transmission is completely secure. We therefore encourage you to take additional steps to safeguard your TV, secure your Internet connection, and minimize the risk of unauthorized access. These steps are listed below:

- When Samsung releases software updates to improve the security of your TV, you should promptly install these updates. To automatically receive these updates, turn on **Auto Update** in the TV's menu (Home > Settings > Support > Software Update > Auto Update). When an update is available, a popup message appears on the TV screen. Accept the software download and update by selecting **Yes** when prompted. Take steps to secure your wireless access point and network. Your access point's manual should provide additional details about how to implement the following measures:
 - Secure your wireless access point's management settings with a unique password to prevent unauthorized changes to security related settings.
 - Implement standard encryption (e.g., WPA2 encryption) on your wireless access point to secure your wireless network signal.
 - Secure access to your wireless network with a hard-to-guess password.
 - Confirm your access point's firewall setting is enabled (if so equipped).
 - Make sure that all your Internet-connected devices are behind your network's firewall.
 - If your access point or modem has a standby mode button, use it to disconnect your home network from the Internet when it is not in use.
- Use strong passwords for all your Internet accounts (Netflix, Facebook, etc.).
- If any unexpected messages appear on your TV screen requesting permission to link a device or enable a remote session, do NOT accept.
- Do not visit suspicious web sites and do not install any suspicious programs. We recommend that users install only those authorized apps provided by Samsung through Samsung Smart Hub.

Figures and illustrations in this User Manual are provided for reference only and may differ from the actual product appearance. Product design and specifications may change without notice.

Contents

	Before Reading This User Manual	2
	Warning! Important Safety Instructions	3
01	TV Installation	
	Providing proper ventilation for your TV	7
	Precautions for TV Installation	7
	Precautions for moving The Sero	8
	Initial Setup	8
02	Connection of SmartThings App	
	Connecting between The Sero and SmartThings app	9
03	Operations in Portrait Mode	
	Switching the mode	10
	Setting the content for Portrait Mode	11
	Playing music in Portrait Mode	12
	Setting for the Portrait Mode	13
04	The Samsung Smart Remote	
	About the Buttons on the Samsung Smart Remote	14
	Pairing the Samsung Smart Remote to the TV	15
	Installing batteries into the Samsung Smart Remote	15
05	Configuration of The Sero	
	Using the TV Controller	16
06	Troubleshooting and Maintenance	
	Troubleshooting	18
	What is Remote Support?	20
	Eco Sensor and screen brightness	20
	Caring for the TV	21
07	Specifications and Other Information	
	Specifications	22
	Environmental Considerations	22
	Decreasing power consumption	23
	Licenses	23

01 TV Installation

Providing proper ventilation for your TV

Leave a space around the product for ventilation. Failing to maintain proper ventilation may result in a fire or a problem with the product caused by an increase in its internal temperature.

For installation, be sure to secure the spaces as shown in the figure.

- When you install your TV with a stand, we strongly recommend you use parts provided by Samsung Electronics only. Using parts provided by another manufacturer may cause difficulties with the product or result in injury caused by the product falling.

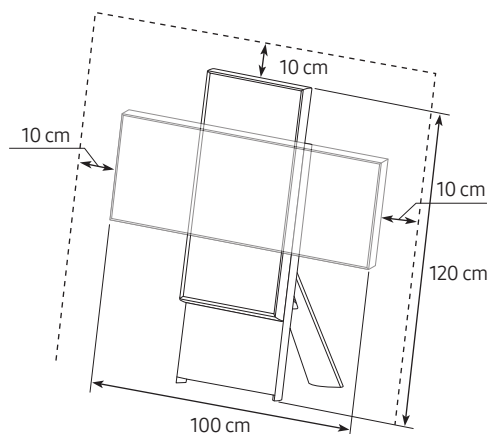

Precautions for TV Installation

Using the stand provided with the product, install The Sero on a flat surface.



Caution: Pulling, pushing, or climbing on the TV may cause the TV to fall. In particular, ensure your children do not hang on or destabilize the TV. This action may cause the TV to tip over, causing serious injuries or death. Follow all safety precautions provided in the Safety Flyer included with your TV.



WARNING: Never place a television set in an unstable location. The television set may fall, causing serious personal injury or death. Many injuries, particularly to children, can be avoided by taking simple precautions such as:

- Always use cabinets or stands or mounting methods recommended by Samsung.
- Always use furniture that can safely support the television set.
- Always ensure the television set is not overhanging the edge of the supporting furniture.
- Always educate children about the dangers of climbing on furniture to reach the television set or its controls.
- Always route cords and cables connected to your television so they cannot be tripped over, pulled or grabbed.
- Never place a television set in an unstable location.
- Never place the television set on tall furniture (for example, cupboards or bookcases) without anchoring both the furniture and the television set to a suitable support.
- Never place the television set on cloth or other materials that may be located between the television set and supporting furniture.
- Never place items that might tempt children to climb, such as toys and remote controls, on the top of the television or furniture on which the television is placed.

If the existing television set is going to be retained and relocated, the same considerations as above should be applied.

Precautions for moving The Sero

Lift the product for moving noting the figures below.

- Lift the product by two persons upright only in portrait mode.
 - ⚠ Never move the product in landscape mode.
 - ⚠ If the product falls, it may cause injury or product damage. Be careful not to hurt hands or feet.
 - ⚠ Be careful not to hold the screen display while lifting the product.

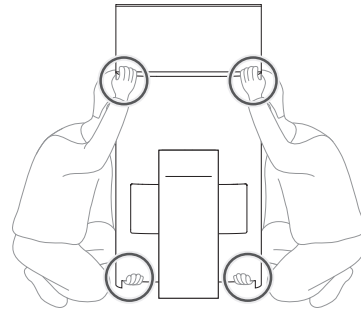

Do not move the product in landscape mode.

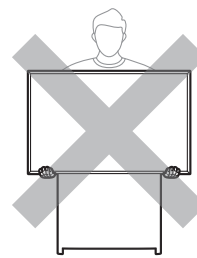
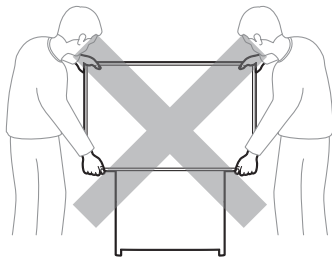

Do not lift the product by yourself.

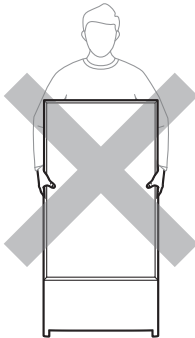

Never move the product by dragging it.

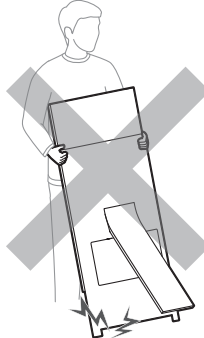

Never hold the display for moving.

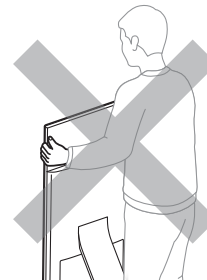

Initial Setup

You can proceed with initial setup after connecting your mobile device.



When you turn on your TV for the first time, it immediately starts the Initial Setup. Follow the instructions displayed on the screen and configure the TV's basic settings to suit your viewing environment.

- To perform the Initial Setup using the SmartThings app, you must connect your mobile device via Wi-Fi.
- If the pop-up for setup does not appear automatically in the SmartThings app on your mobile device, manually add the TV using **Add Device** on the dashboard of the SmartThings app, and then continue with the set up process.
- The SmartThings app is available for mobile devices running Android 6.0 or higher or iOS 10 or higher.
- Noise may occur temporarily when the TV communicates with mobile devices.

02 Connection of SmartThings App

You can connect The Sero via the SmartThings app on your mobile device to control the **Portrait Mode** and the related functions on the TV.

The SmartThings app can be installed from App Store or Google Play Store.

- Update the SmartThings app on your mobile device to the latest version. Available screens or functions may differ depending on the version of the app.
- To connect between The Sero and SmartThings app, they must be on the same network.
 - For the device name of The Sero, find in  >  Settings > General > System Manager > Device Name.

Connecting between The Sero and SmartThings app

When The Sero connection pop-up appears after launching the SmartThings app on your mobile device, press Add now to connect the product following the screen instructions.

If the pop-up does not appear, you can register the product as follows:

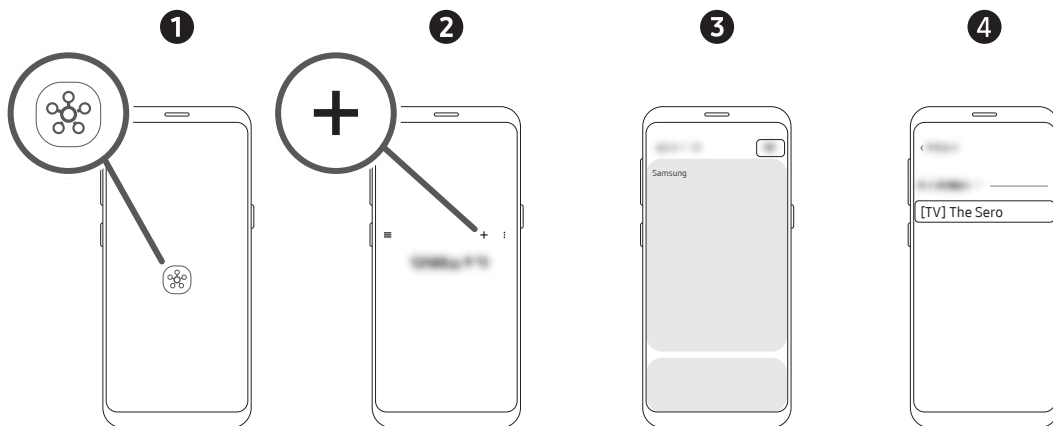

- The screen image of your mobile device may differ from the actual one.







1. Launch the SmartThings app on your mobile device.
2. Tap the  button in the middle on the right and then tap **Device**.
3. Tap **Scan** at the upper right corner.
4. Tap **The Sero** when it appears in the device list to connect.
 - If **The Sero** does not appear in the list, add it manually.
5. Register it following the screen instructions.

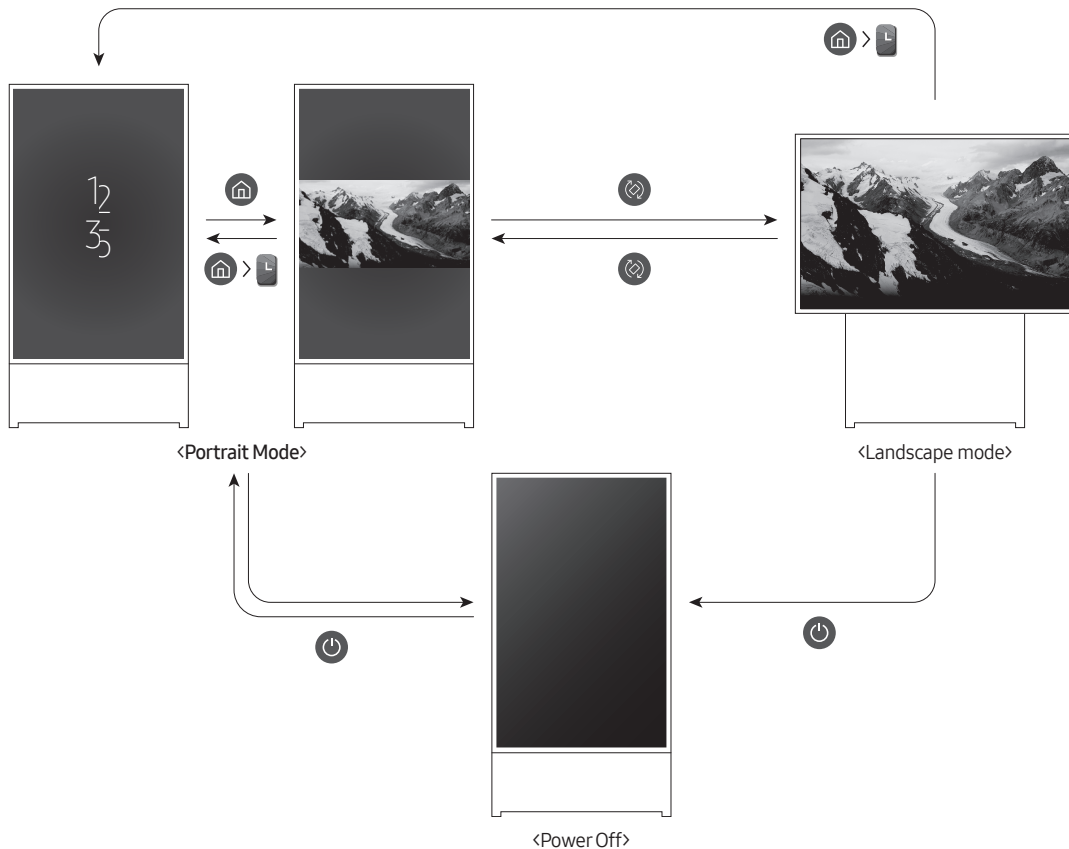



03 Operations in Portrait Mode

You can rotate the screen vertically and then locate the desired content such as photos, images, and watch while not using the product.

Switching the mode



- To enter the content screen only for **Portrait Mode**, see the following:
 - In the SmartThings app on your mobile device, select **The Sero > TV Control** and then press the  button.
 - Press the  button on the Samsung Smart Remote and then select  **Portrait Mode**.
 - Press and hold the  button in **Portrait Mode**.
- To exit from the content screen only for **Portrait Mode**, on the Samsung Smart Remote, press the  button.
- By pressing the  button on the Samsung Smart Remote, the screen can switch between Portrait and Landscape modes.
 - When some apps are launched in **Portrait Mode**, their mode can be switched to Landscape depending on the app's policy.

- To switch from Landscape to Portrait, see the following:
 - In the SmartThings app on your mobile device, select **The Sero** > **TV Control** and then press the  button.
 - Press the  button on the Samsung Smart Remote.
 - Press the Bixby button on the Samsung Smart Remote and then say "Portrait Mode" or "Rotate vertically."
- When The Sero screen is switched from Landscape to Portrait, the playing content appears at the center of the screen according to the aspect ratio.
- When the power is turned off in Landscape mode, the screen switches to **Portrait Mode** and then the TV turns off. To turn off the TV in Landscape mode, change its setting. ( >  **Settings** > **General** > **System Manager** > **Turn Off in Portrait**)

Setting the content for Portrait Mode

- The provided content may be changed by a future update.

Setting through the SmartThings app on your mobile device

You can configure the major settings for **Portrait Mode** through the SmartThings app.

- Available screens and functions may differ depending on the app version.

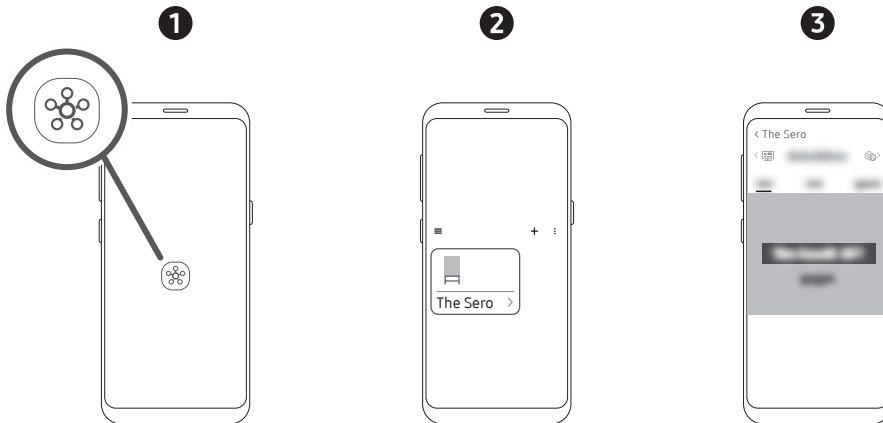

1. Launch the SmartThings app on your mobile device.
2. Tap **The Sero** on the dashboard and then tap **Portrait Mode**.
3. Select the content category, select the desired content by dragging up or down, and then tap the **View on The Sero** button on the screen.

The selected content is set as the content screen only for **Portrait Mode**.

The content categories to select are as follows. To see the detailed information of content, tap the View details button.

- **Clock**
Select from various watch faces.
- **Poster**
Select from various sensual and beautiful designs.
- **My Photo**
Select photos from your mobile device.
- **Cinemagraph**
Experience mesmerizing hybrids of photo and video, capturing a subtle motion played in a continuous loop.
- **Sound Wall**
When connected to your mobile device via Bluetooth, you can select a background moving image that appears while playing music.

Setting the TV with the remote control

When you press the Select button on the remote control in the content screen only for **Portrait Mode**, the content categories appear at the top of the screen.

1. Press the left or right directional button on the remote control to change the content category. The categories that can be changed are as follows:
 - **Clock / Poster / My Photo / Cinemagraph / Sound Wall**
2. Move to the desired content category and then press the up or down directional button on the Samsung Smart Remote to select the desired content.
 - When a specific time elapses without selecting content, the content screen only for **Portrait Mode** is set with the content displayed on the screen.
3. The selected content is set as the content screen only for **Portrait Mode**.

Playing music in Portrait Mode

Playing music on your mobile device via The Sero

1. Connect The Sero after searching from the  (Bluetooth) device list on your mobile device.
2. Select media content to play on your mobile device.

The selected content is played through the speaker of The Sero.

- While playing music on your mobile device, if The Sero is connected, the music is automatically played on The Sero.

Setting for the Portrait Mode

Select The Sero in the SmartThings app on your mobile device. Tap **Portrait Mode**, tap  at the upper right corner, and then select **Portrait Mode settings**. Using the following functions, you can change the settings for the **Portrait Mode** screen.

- **Brightness**
Can adjust the screen brightness for the **Portrait Mode**.
- **Daily info**
Can set to display the time and weather information on the content screen only for **Portrait Mode** by default.
 - It may differ depending on the category.
- **Reset My Photo**
Can delete all personal photos added to your mobile device and reset to default ones.

Select The Sero in the SmartThings app on your mobile device and then tap the  button at the upper right corner. You can additionally set the following functions:

- **The Sero Auto On/Off**
Depending on the distance between your mobile device and The Sero, the power can be controlled automatically to minimize the power consumption.
 - While this function is active, as your mobile device gets closer to The Sero, its screen turns on automatically.
 - When a certain time elapses after the mobile device is moved far away, the screen turns off automatically.
 - This function is available only in **Portrait Mode**.
- **Bluetooth auto connection**
When a mobile device registered in The Sero approaches closer with its power off, music on your mobile device is automatically played through the speaker of The Sero.
 - This function is available only in Samsung mobile devices.
 - This function is available only with The Sero Auto On/Off is set to on.
 - This function is available only in **Portrait Mode**.
- **Auto Brightness**
Adjusts the screen brightness according to the surrounding illumination in **Portrait Mode**.
- **Off Timer**
Can set the time when to turn off the screen in **Portrait Mode**.
 - This function does not work in **Portrait Mode** while in smart view of the mobile device or playing music of the mobile device via Bluetooth.

04 The Samsung Smart Remote

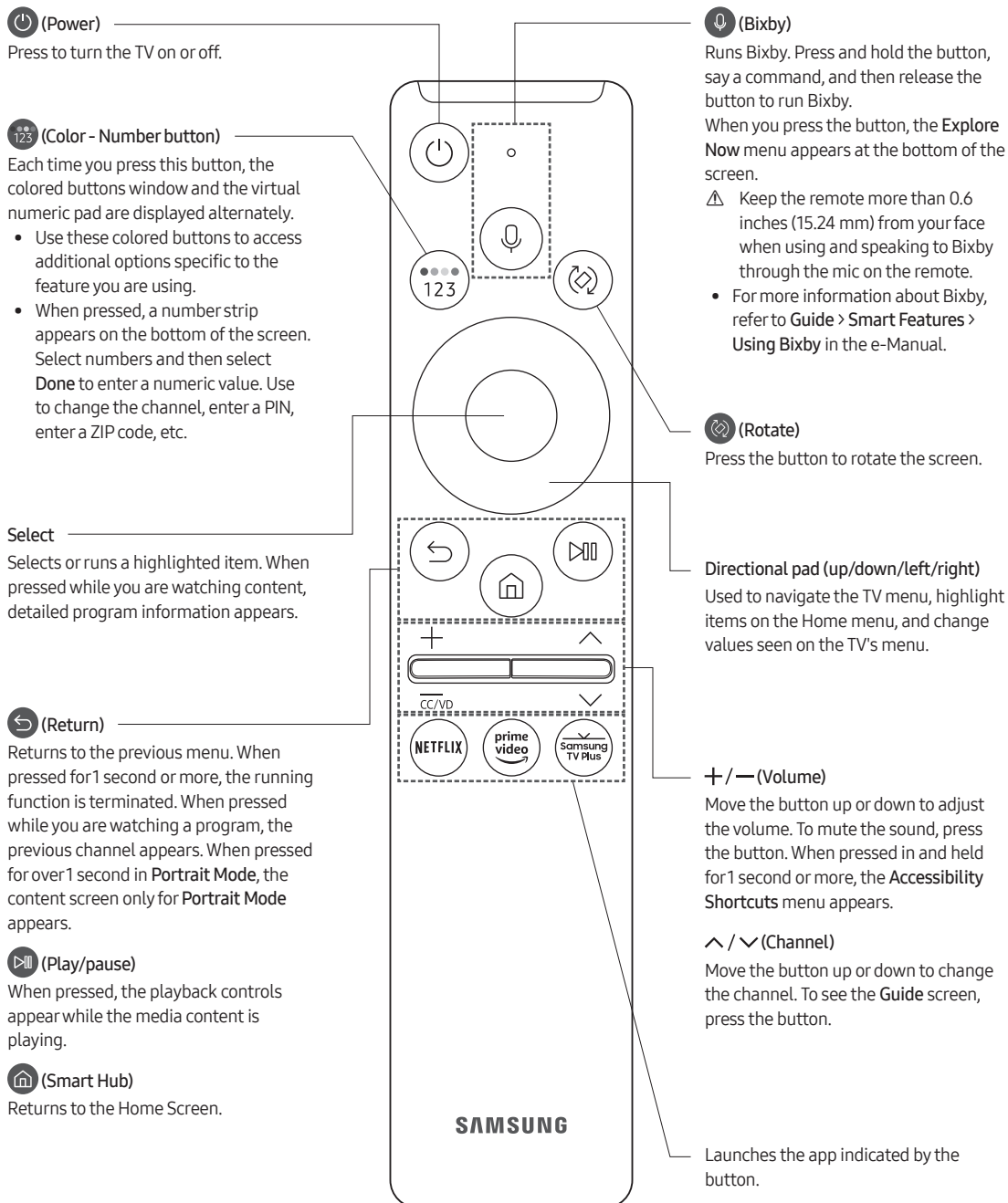

About the Buttons on the Samsung Smart Remote

- The images, buttons, and functions of the Samsung Smart Remote may differ depending on the model.
- The Universal Remote function operates normally only when you use the Samsung Smart Remote that comes with the TV.
- When some apps are launched in **Portrait Mode**, their mode can be switched to Landscape depending on the app's policy.

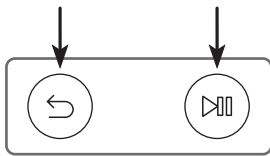

Pairing the Samsung Smart Remote to the TV



When you turn on the TV for the first time, the Samsung Smart Remote pairs to the TV automatically. If the Samsung Smart Remote does not pair to the TV automatically, point it at the remote control sensor of the TV, and then press and hold the buttons labeled  and  as shown in the figure on the left simultaneously for 3 seconds or more.

Installing batteries into the Samsung Smart Remote

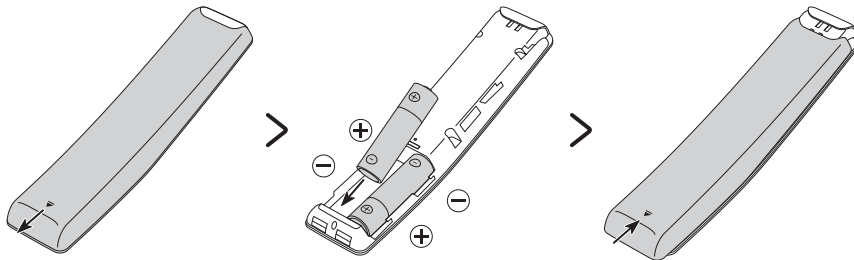

To install the batteries, push the rear cover open in the direction of the arrow at the bottom of the illustration, and then insert the batteries as shown in the figure. Make sure that the positive and negative ends are facing in the correct direction. Close the rear cover as shown.

- Alkaline batteries are recommended for longer battery life.

Setting the sound sensor



You can turn the sound sensor on or off by using its button at the bottom of the TV.
With the TV on, push the button back to turn the sound sensor on or forward to turn it off.
See the pop-up window on the TV to check whether the sound sensor is turned on or off.

- The position and shape of the sound sensor may differ depending on the model.
- During analysis using data from the sound sensor, the data is not saved.

06 Troubleshooting and Maintenance

Troubleshooting

If the TV seems to have a problem, first review this list of possible problems and solutions. Alternatively, review the Troubleshooting or FAQ Section in the e-Manual. If none of the troubleshooting tips apply, please visit "www.samsung.com" and click Support or contact the Samsung service center listed on the back cover of this manual.

- For detailed information on troubleshooting, watch the troubleshooting videos at www.samsung.com/spsn.
- This TFT LED panel is made up of sub pixels which require sophisticated technology to produce. There may be, however, a few bright or dark pixels on the screen. These pixels will have no impact on the performance of the product.
- To keep your TV in optimum condition, upgrade to the latest software. Use the **Update Now** or **Auto Update** functions on the TV's menu (🏠 > ⚙️ **Settings** > **Support** > **Software Update** > **Update Now** or **Auto Update**).
- In **Portrait Mode**, some apps or external inputs may not support the full screen.

The TV won't turn on.

- Make sure that the AC power cord is securely plugged in to the TV and the wall outlet.
- Make sure that the wall outlet is working and the power indicator at the bottom of the TV is lit and glowing a solid red.
- Try pressing the **TV Controller** button behind the screen to make sure that the problem is not with the remote control. If the TV turns on, refer to "The remote control does not work."

There is no picture/video/sound, or a distorted picture/video/sound from an external device, or "Weak or No Signal" is displayed on the TV, or you cannot find a channel.

- Perform a TV self diagnosis to determine if the problem is caused by the TV or the device (🏠 > ⚙️ **Settings** > **Support** > **Device Care** > **Self Diagnosis** > **Picture Test** or **Sound Test**).
- If the test results are normal, make sure the connection to the device is correct and that all cables are fully inserted.
- Remove and reconnect all cables connected to the TV and the external devices. Try new cables if possible and confirm that the correct input source has been selected (🏠 > 📺 **Source**).
- Reboot the connected devices by unplugging each device's power cord and then plugging it in again. If the issue persists, refer to the connection guide in the user manual of the connected device.
- If you are not using a cable box or satellite box, and your TV is receiving TV signals from an antenna or a cable wall connector, run **Auto Program** to search for channels (🏠 > ⚙️ **Settings** > **Broadcasting** > **Auto Program**).

The remote control does not work.

- Check if the power indicator at the bottom of the TV blinks when you press the remote's Power button. If it does not, replace the remote control's batteries.
- Make sure that the batteries are installed with their poles (+/-) in the correct direction.
- Try pointing the remote directly at the TV from 5 ft. to 6 ft. (1.5-1.8 m) away.
- Try pairing the Samsung Smart Remote to your TV again.

Mobile mirroring works suddenly.

If any vibration occurs when the product is very close to your mobile device whose mobile tap mirroring is active, mirroring to the set mobile device is enabled.

When Mobile Tap Mirroring is active on multiple devices and all devices are within range, any contact with the TV can start mirroring.

The cable box or satellite box remote control doesn't turn the TV on or off or adjust the volume.

- Program the cable box or satellite box remote control to operate the TV. Refer to the cable box or satellite box user manual for the SAMSUNG TV code.

The TV settings are lost after 5 minutes.

- The TV is in **Retail Mode**. Change the **Usage Mode** in the **System Manager** Menu to **Home Mode** (🏠 > ⚙️ Settings > General > System Manager > Usage Mode > Home Mode).



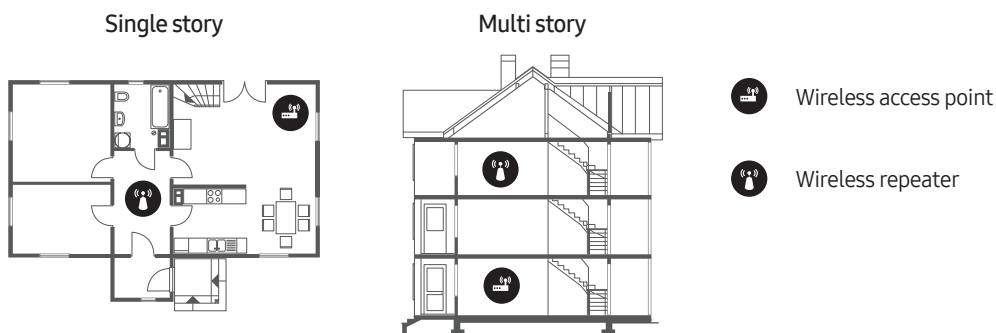

Intermittent Wi-Fi

- Make sure the TV has a network connection (🏠 > ⚙️ Settings > General > Network > Network Status).
- Make sure the Wi-Fi password is entered correctly.
- Check the distance between the TV and the modem or access point. The distance should not exceed 50 ft (15.2 m).
- Reduce interference by not using or turning off wireless devices. Also, verify that there are no obstacles between the TV and the modem or access point. (The Wi-Fi strength can be decreased by appliances, cordless phones, stone walls/fireplaces, etc.)



- Contact your Internet Service Provider (ISP) and ask them to reset your network circuit to re-register the MAC addresses of your new modem or access point and the TV.

Video Apps problems (Youtube etc)

- Change the DNS to 8.8.8.8. Select  >  Settings > General > Network > Network Status > IP Settings > DNS Setting > Enter manually > DNS Server > enter 8.8.8.8 > OK.
- Reset by selecting  >  Settings > Support > Device Care > Self Diagnosis > Reset Smart Hub.



What is Remote Support?

Samsung Remote Support service offers you one-on-one support with a Samsung Technician who can remotely:

- Diagnose your TV
- Adjust the TV settings for you
- Perform a factory reset on your TV
- Install recommended firmware updates



How does Remote Support work?

You can easily get Samsung Remote Support service for your TV.

1. Call the Samsung service center and ask for remote support.
2. Open the menu on your TV, and then go to the **Support** menu. ( >  Settings > Support)
3. Select **Remote Management**, then read and agree to the service agreements. When the PIN screen appears, provide the PIN number to the technician.
4. The technician will then access your TV.

Eco Sensor and screen brightness



Eco Sensor adjusts the brightness of the TV automatically. This feature measures the light in your room and optimizes the brightness of the TV automatically to reduce power consumption. If you want to turn this off, go to  >  Settings > General > Eco Solution > Ambient Light Detection.

- If the screen is too dark while you are watching TV in a dark environment, it may be due to the **Ambient Light Detection** function.
- The eco sensor is located at the bottom of the TV. Do not block the sensor with any object. This can decrease picture brightness.

Caring for the TV

- If a sticker was attached to the TV screen, some debris can remain after you remove the sticker. Please clean the debris off before watching TV.
- The exterior and screen of the TV can get scratched during cleaning. Be sure to wipe the exterior and screen carefully using a soft cloth to prevent scratches.
- Do not spray water or any liquid directly onto the TV. Any liquid that goes into the product may cause a failure, fire, or electric shock.
- To clean the screen, turn off the TV, then gently wipe away smudges and fingerprints on the panel with a micro-fiber cloth. Clean the body or panel of the TV with a micro-fiber cloth dampened with a small amount of water. After that, remove the moisture with a dry cloth. While cleaning, do not apply strong force to the surface of the panel because it can damage the panel. Never use flammable liquids (benzene, thinner, etc.) or a cleaning agent. For stubborn smudges, spray a small amount of screen cleaner on a micro-fiber cloth, and then use the cloth to wipe away the smudges.

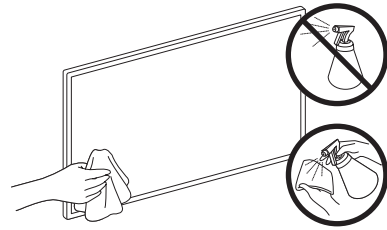

07 Specifications and Other Information

Specifications

Model Name		QN43LS05T
Display Resolution		3840 x 2160
Screen Size Diagonal Measured Diagonally		43" Class 42.5 inches
Sound (Output)		60 W
Portrait mode Dimensions (W x H x D)	Body	22.2 x 48.4 x 3.3 inches (564.7 x 1228.1 x 83.4 mm)
	With Stand	22.2 x 47.2 x 12.9 inches (564.7 x 1200.0 x 327.0 mm)
Landscape mode Dimensions (W x H x D)	Body	38.3 x 40.3 x 3.3 inches (972.9 x 1024.1 x 83.4 mm)
	With Stand	38.3 x 39.4 x 12.9 inches (972.9 x 1002.0 x 327.0 mm)
Weight Without Stand		57.3 lbs (26.0 kg)
With Stand		73.4 lbs (33.3 kg)

Environmental Considerations

Operating Temperature	50°F to 104°F (10°C to 40°C)
Operating Humidity	10% to 80%, non-condensing
Storage Temperature	-4°F to 113°F (-20°C to 45°C)
Storage Humidity	5% to 95%, non-condensing

Notes

- Design and specifications are subject to change without prior notice.
- This device is a Class B digital apparatus.
- For information about the power supply, and more information about power consumption, refer to the information on the label attached to the product.
 - On most models, the label is attached to the back of the TV. (On some models, the label is inside the cover terminal.)
- Your TV and its accessories may look different than the product images presented in this manual, depending on the model.
- All drawings are not necessarily to scale. Some dimensions are subject to change without prior notice. Refer to the dimensions before installing your TV. Not responsible for typographical or printed errors.

Decreasing power consumption

When you shut the TV off, it enters Standby mode. In Standby mode, it continues to draw a small amount of power. To decrease power consumption, unplug the power cord when you don't intend to use the TV for a long time.

Licenses



The terms HDMI and HDMI High-Definition Multimedia Interface, and the HDMI Logo are trademarks or registered trademarks of HDMI Licensing LLC in the United States and other countries.

SAMSUNG

Contact SAMSUNG WORLD WIDE

If you have any questions or comments relating to Samsung products, please contact the Samsung service center.

Country	Samsung Service Center ☎	Web Site	Address
CANADA	1-800-SAMSUNG (726-7864)	www.samsung.com/ca/support (English) www.samsung.com/ca_fr/support (French)	Samsung Electronics Canada Inc. 2050 Derry Road West Mississauga, Ontario L5N 0B9 Canada
U.S.A	1-800-SAMSUNG (726-7864)	www.samsung.com/us/support	Samsung Electronics America, Inc. 85 Challenger Road Ridgefield Park, NJ 07660

accessibility contact information in U.S.A. : accessibility@sea.samsung.com

Scan the QR code to view our helpful how-to videos



Scan this QR code with your smart phone to see helpful videos.

If you experience issues, please do not take the TV back to the store.

In the United States of America, call us at 1-800-SAMSUNG (1-800-726-7864) or visit us at www.samsung.com or www.samsung.com/spsn for support and warranty service.



For more information, see "Troubleshooting" in this manual or "FAQ" in the e-Manual.

