

SZ20-ZN/EN-A02

Creator 3 / 金刚狼3

# Quick Start Guide

## ≡ 快速启动指南 ≡

中文P17

**⚠ WARNING**

- 
1. Hot! Avoid touching the heating nozzle and heating build plate in operation.
  2. Moving parts in printer may cause injury. Do not wear gloves or other sources of entanglement in operation.
- 

**Download**

---

Please refer to FlashForge official website [www.flashforge.com](http://www.flashforge.com) to download the newest User's Guide, Software and Instruction Videos.  
(Support-Support Center-Select a Product)

---

**⚠ 注意事项**

- 
1. 高温危险！打印机喷嘴和打印平台在工作时会被加热，请避免接触！
  2. 可动部件可能造成卷入挤压和切割伤害。操作机器时请不要佩戴手套或缠绕物。
- 

**资料下载**

---

前往闪铸科技官方网站 [www.sz3dp.com](http://www.sz3dp.com)，可以在[技术支持]页面下载用户使用手册、切片软件等资料，或查看相关操作视频。

---





## Unpacking



1. Cut off packaging ties, and tear off stretch wrap.

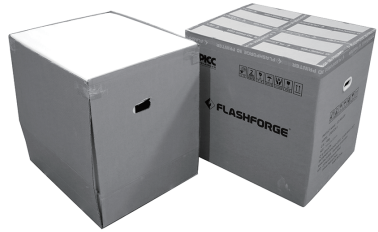

2. Lift outer packing box.



3. Remove top foam.



4. Remove foam around the printer.

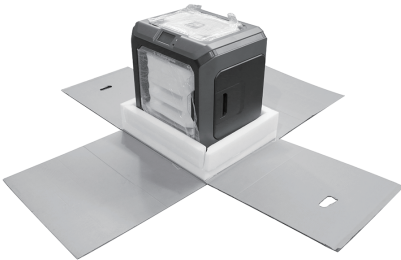

5. Unrip tapes on four corners of the printer, take bubble pack down.

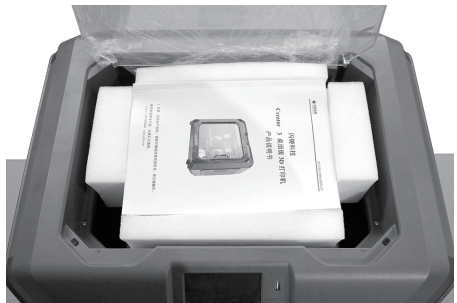

6. Remove tapes on the top, open head cover.



7. Take top parts and foam out.

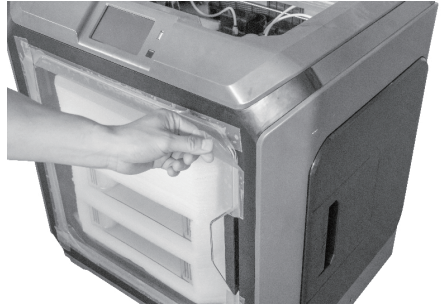

8. Remove the blue fastening tape.

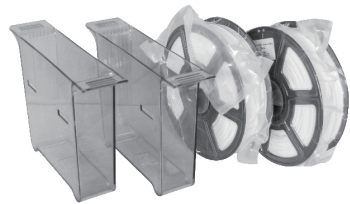

9. Open the front door and take out the front foam which should contain two filament spools and two waste boxes.

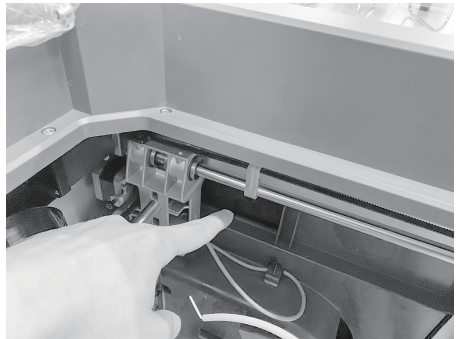
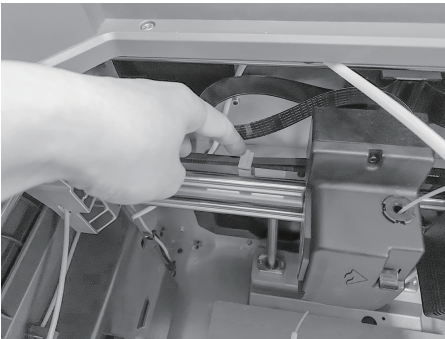

10. Remove clips on timing belt of X-axis and Y-axis.

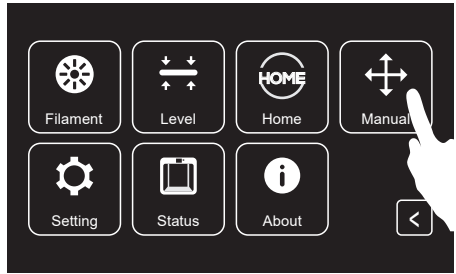
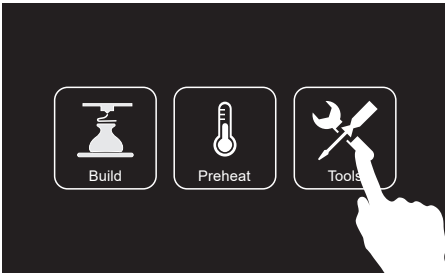

11. Plug power cable into the input on the back and turn on the power switch. Tap [Tools], [Manual].

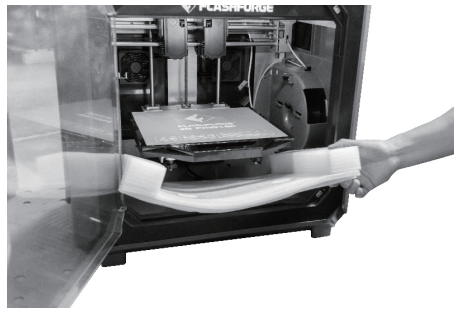
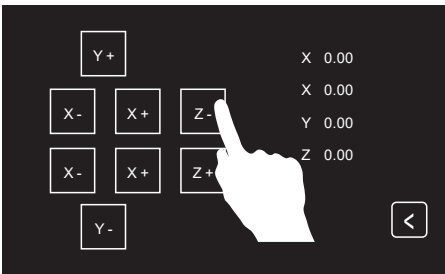

12. Tap [Z-] to partially elevate the build plate.

13. Remove bottom foam pieces.



14. Now you've unpacked your Creator 3.

## Getting to Know Your Creator 3

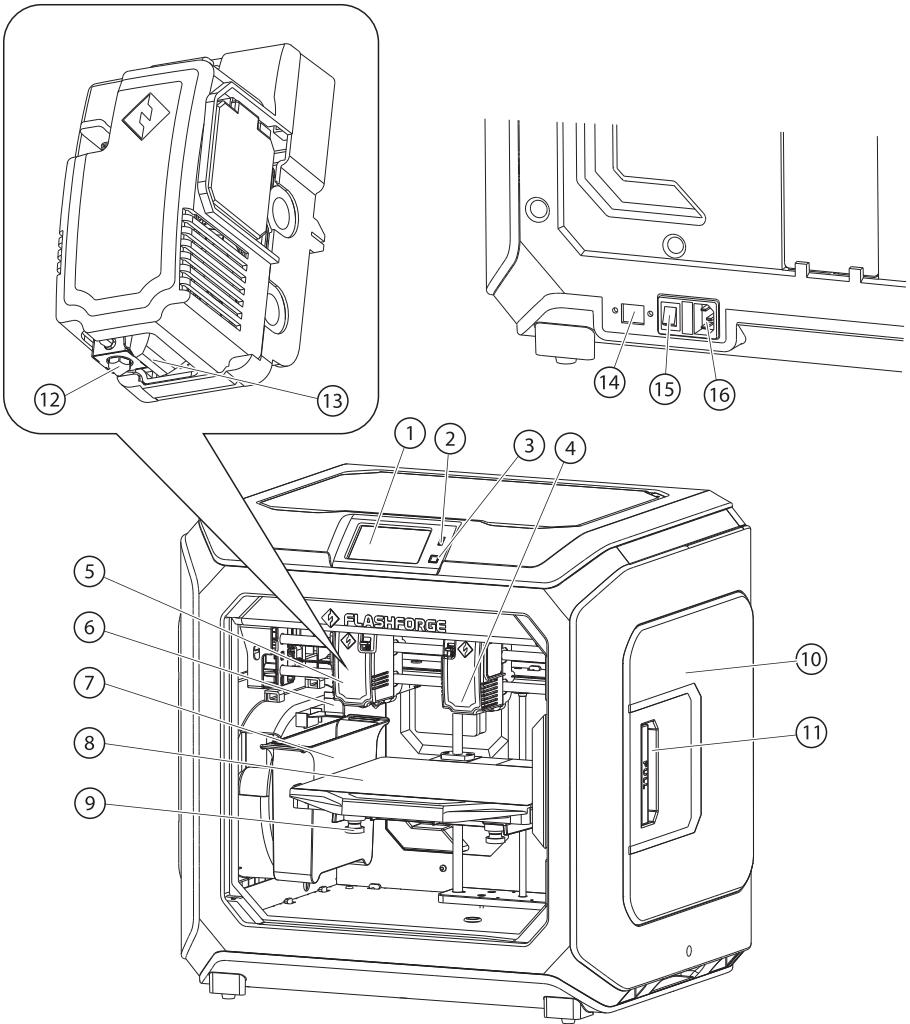

- |                     |                              |                            |                   |
|---------------------|------------------------------|----------------------------|-------------------|
| 1. Touch Screen     | 2. USB Stick Input           | 3. Touch Screen Bottom     | 4. Right Extruder |
| 5. Left Extruder    | 6. Nozzle Brush              | 7. Waste Box               | 8. Build Plate    |
| 9. Leveling Nut     | 10. Filament Cartridge Cover | 11. Cartridge Cover Handle | 12. Nozzle        |
| 13. Turbofan Baffle | 14. Network Input            | 15. Power Switch           | 16. Power Input   |

## Kit Contents

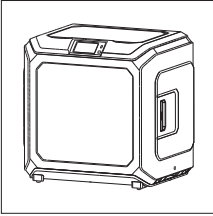

3D Printer

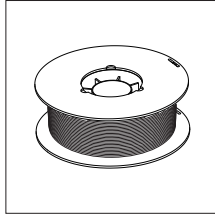

Filament Spool

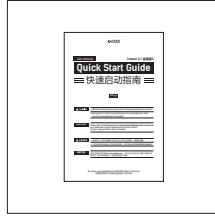

Quick Start Guide



After-sales Service Card

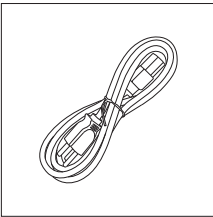

Power Cable

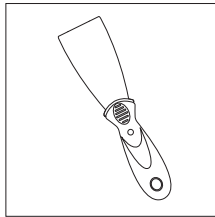

Metal Scraper

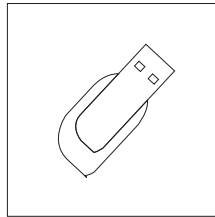

USB Stick

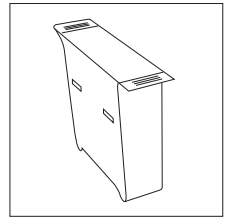

Waste Box

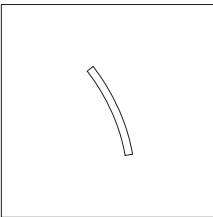

PTFE Tube

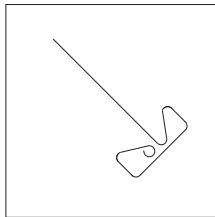

Unclogging Pin Tool

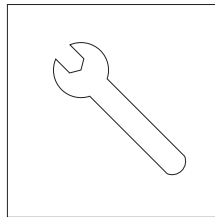

Wrench

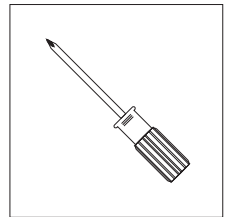

Screwdriver

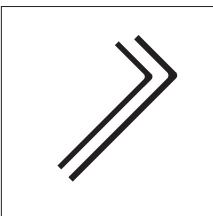

Allen Wrench

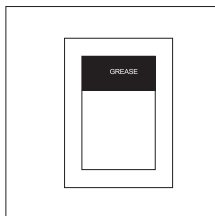

Grease

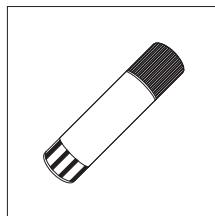

Solid Glue

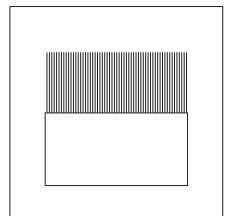

Nozzle Brush

## Leveling Build Platform

### How to change language

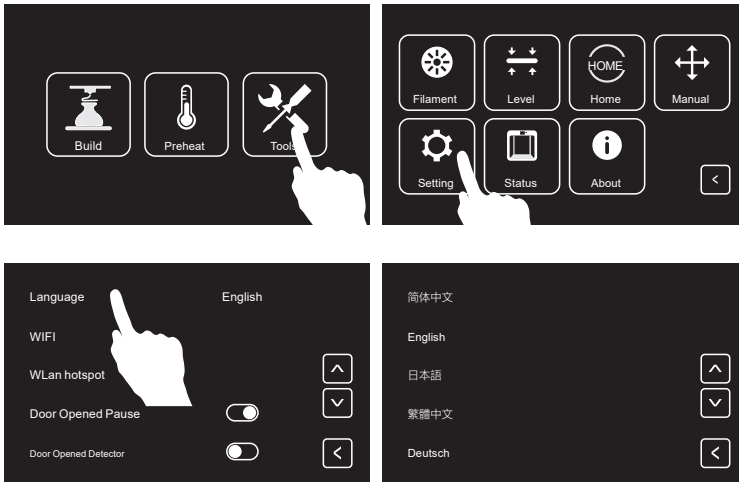

### How to use the leveling nuts

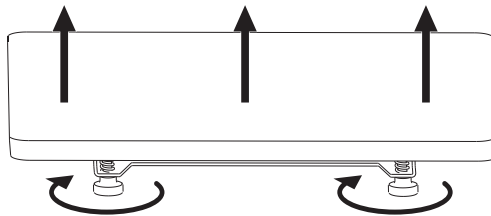

#### Rotate the nut clockwise

Raise the build plate to reduce the distance between the nozzle and build plate.

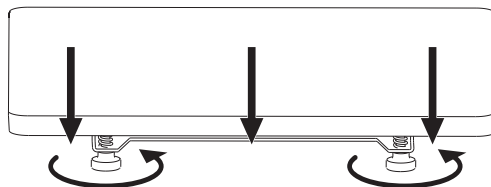

#### Rotate the nut anticlockwise

Lower the build plate to increase the distance between the nozzle and build plate.

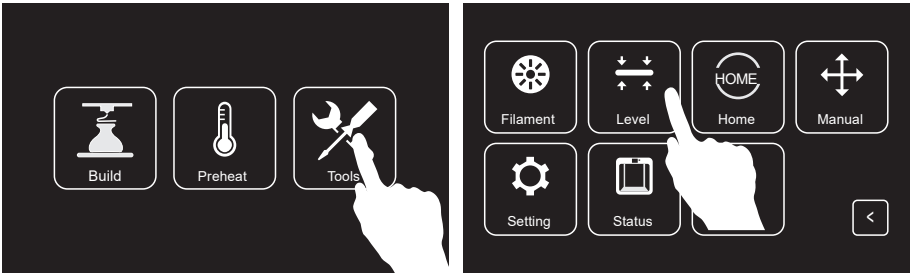

1. Tap[Tools], tap[Level]to level the build plate.

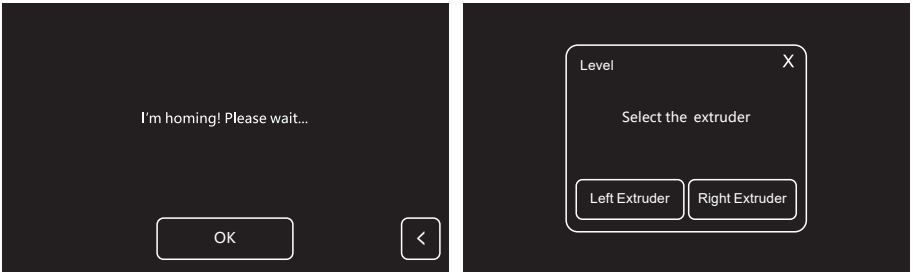

2. Wait for the extruder and the build plate moving, after moving completed, choose to use which extruder to level the build plate: left or right.

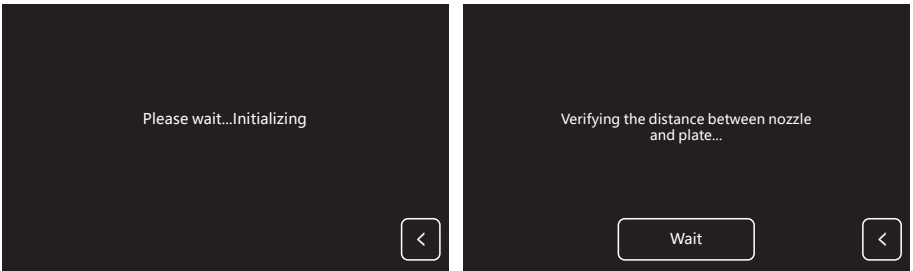

3. After leveling extruder confirmed,extruder will move to the first point to verify the distance between nozzle and build plate. If verify completed, extruder will move to the second point to verify the distance.

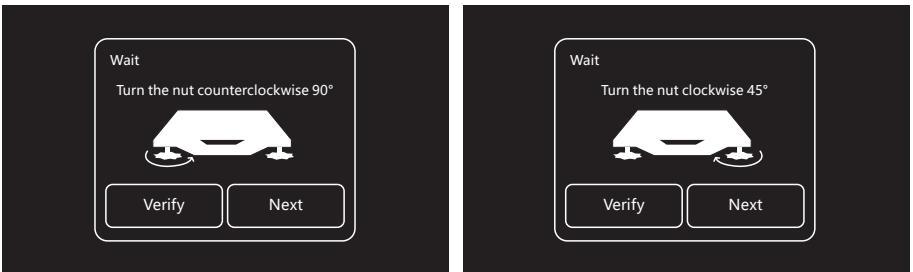

4. If the distance is not appropriate, please follow the prompts to adjust again till you see [OK] button. Repeat steps 4 to level the second and third points. Then tap [Finish] to exit.

## Install Waste box and Nozzle brush

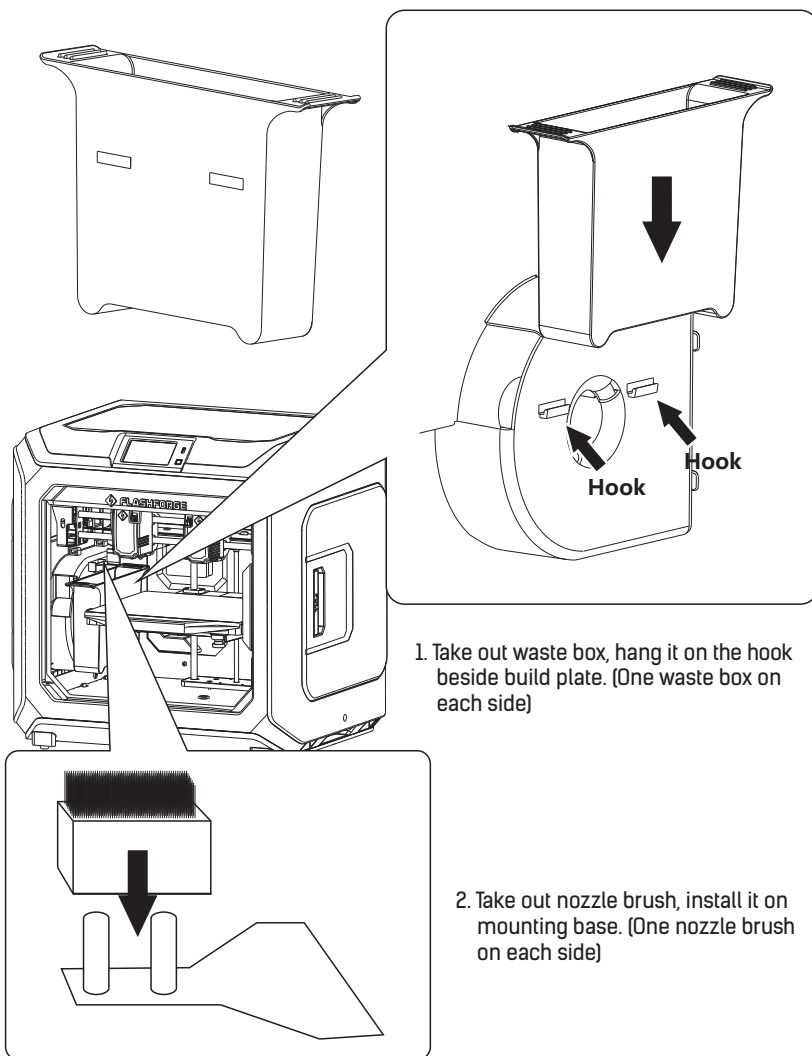



## Install Filament

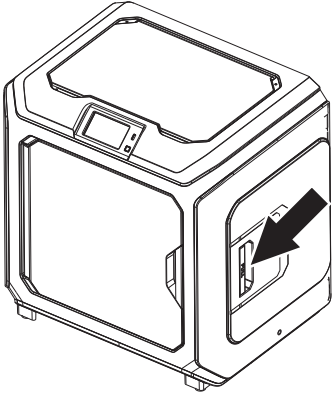

1. Open the filament cover.

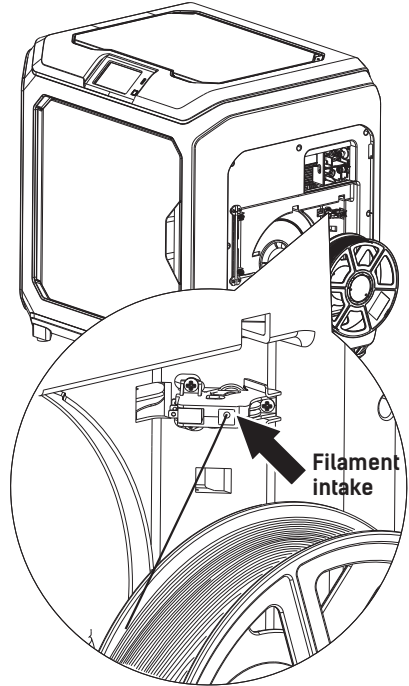

2. Insert the filament into filament intake.

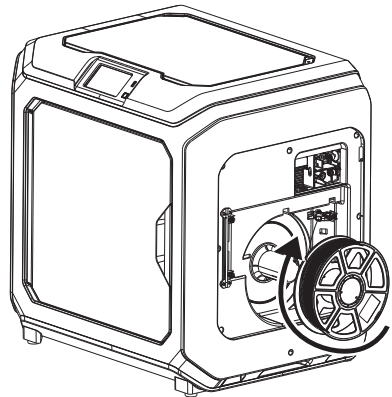
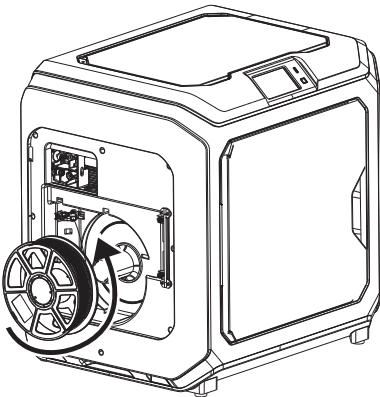

3. Notice: For filament convenient rotation, please install filament follow the direction shown in the picture.

**When installing filament on the left side, please unload filament anticlockwise;  
when installing filament on the right side, please unload filament clockwise.**

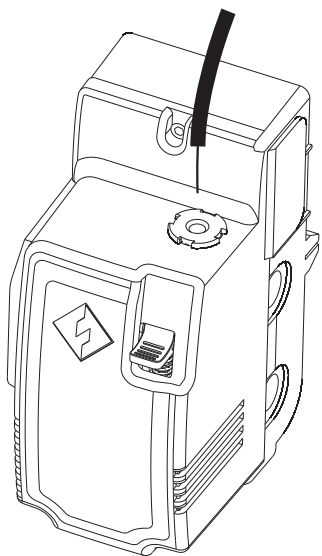

4. Insert filament into filament intake continuously until filament goes through filament guidetube.

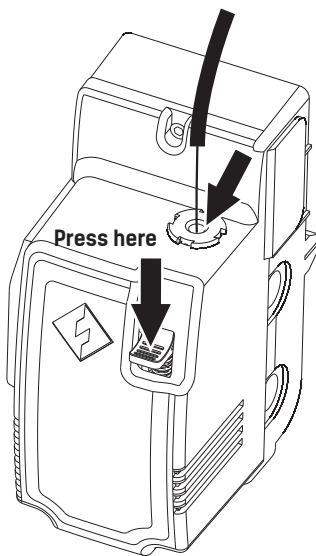

5. Press the spring presser, put filament vertically into the left filament intake to the bottom.

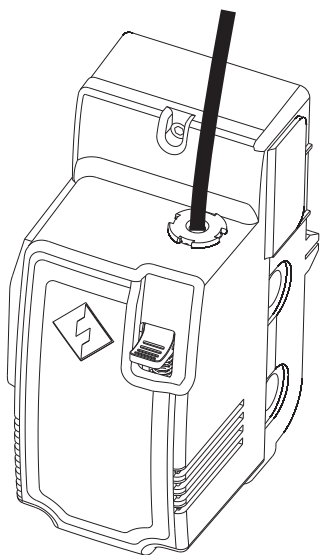

6. Insert filament guidetube into filament intake to fix.

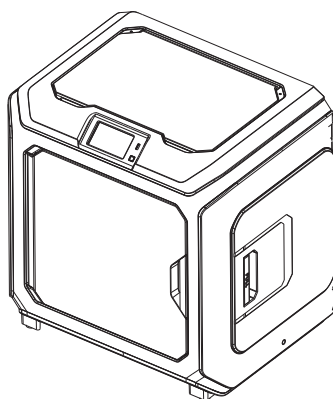

7. Put the spool of filament on the spool holder, close the filament cover.

## Load Filament

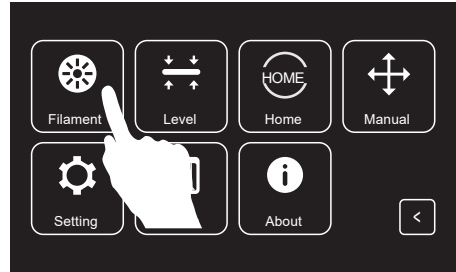
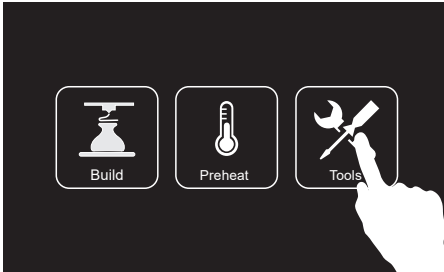

1. Tap [Tools], [Filament] to enter the filament interface.

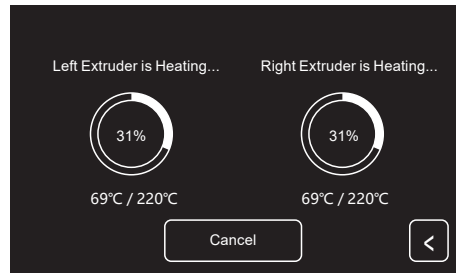
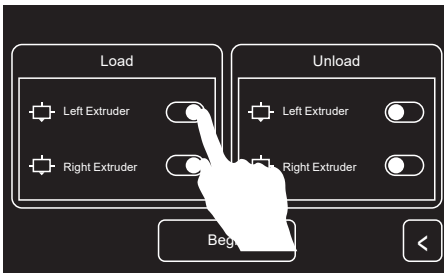

2. Flip the switch after corresponding extruder to load corresponding extruder. 3. Tap [Begin], the extruder will start heating.

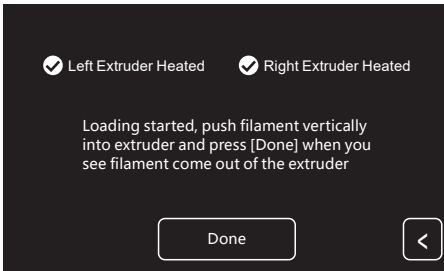

4. Once heated, filament will be drawn through the extruder. Continue extruding until the extruder provides a steady flow of filament. Tap [Done], go back. Tap leftwards arrow to go back to the home screen.

**Attention:** If extruder can not unload in a long time, please check if you have inserted filament into the bottom of extruder.

## Calibration

Please operate under the guidance of customer service for the first calibration.

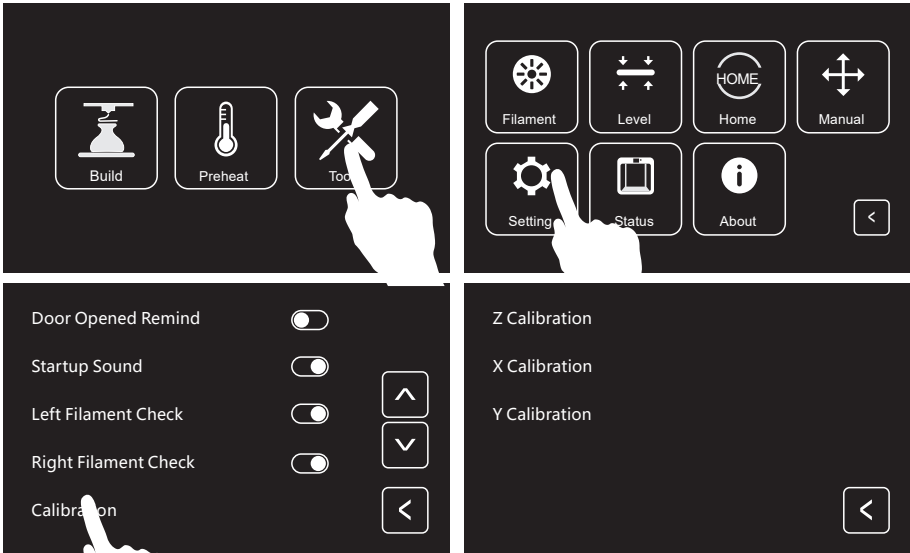

Tap [Tools], tap [Setting], tap [calibration] in setting page.

## Z Calibration

Please level before Z-axis calibration.  
Please refer to the 06 page for leveling

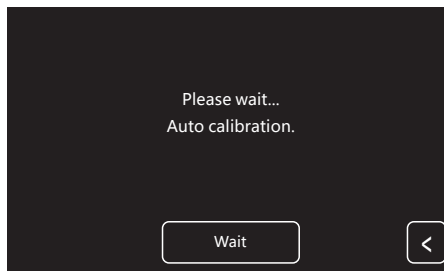

1. Tap [Z-axis calibration] and wait for Z-axis calibration of extruder and build plate. Do not interrupt during the calibration process.

## X Calibration

Check if the lines printed by 2 extruders aligned on X-axis to judge if the extruders on the same X-axis.

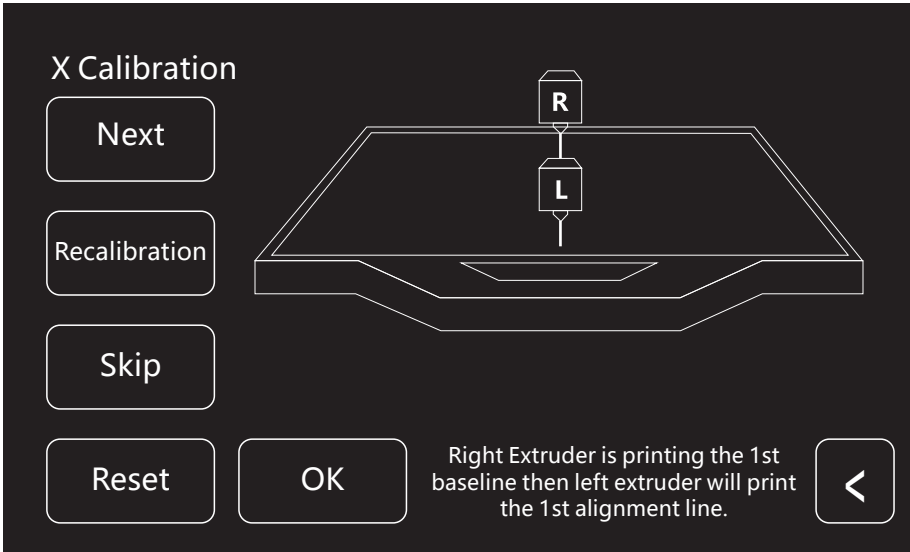

1. Tap [X-axis calibration] and wait for extruders heating up. After heating up till target temperature, 2 lines will be printed in sequence. Check if the 2 lines are aligned after printing. Meanwhile, the pop-up window will appear.

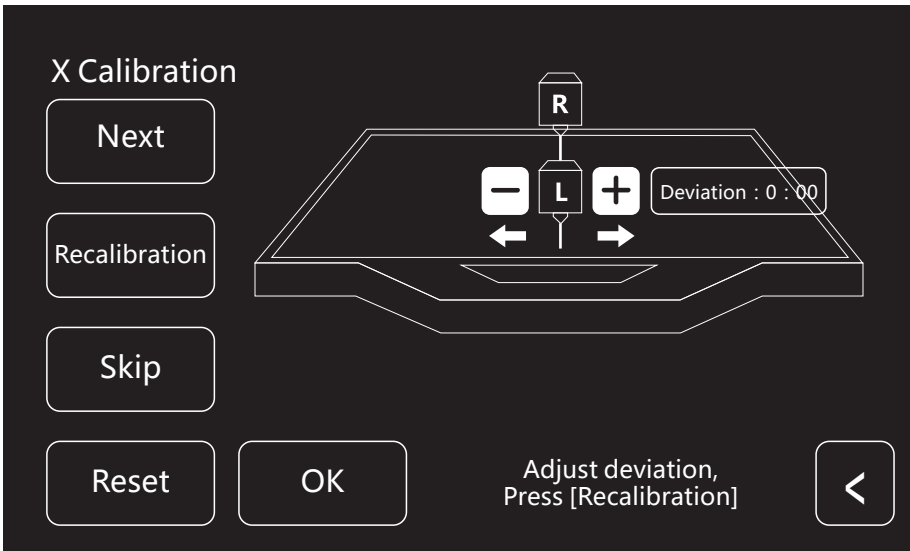

2. If the 2 lines are totally aligned, Tap [Yes], X-axis calibration is done. If the 2 lines are not totally aligned, Tap [No]. Adjust position of extruders according to actual situation. After that, clean the filament on build plate and Tap [Recalibration]. Repeat step 2 till the 2 lines are totally aligned.

## Y Calibration

Check if the lines printed by 2 extruders aligned on Y-axis to judge if the extruders on the same Y-axis.

Y Calibration

Next

Recalibration

Skip

Reset

OK

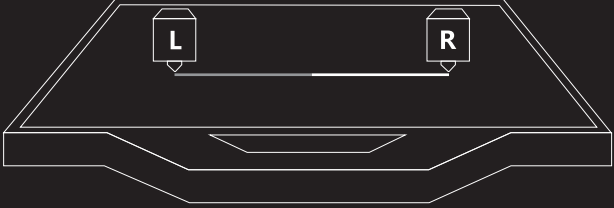

Right Extruder is printing the 1st baseline and then left extruder will print the 1st alignment line.

<

1. Tap [Y-axis calibration] and wait for extruders heating up. After heating up till target temperature, 2 lines will be printed in sequence. Check if the 2 lines are aligned after printing. Meanwhile, the pop-up window will appear.

Y Calibration

Next

Recalibration

Skip

Reset

OK

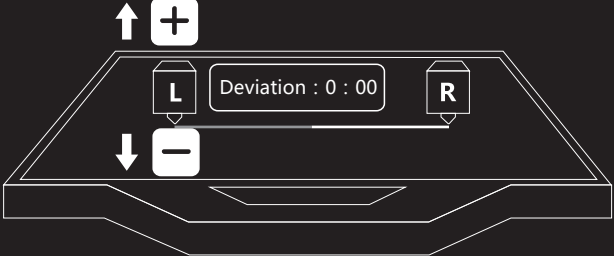

Deviation : 0 : 00

Adjust deviation, Press [Recalibration]

<

2. If the 2 lines are totally aligned, Tap [Yes], Y-axis calibration is done. If the 2 lines are not totally aligned, Tap [No]. Adjust position of extruders according to actual situation. After that, clean the filament on build plate and Tap [Recalibration]. Repeat step 2 till the 2 lines are totally aligned.

## First Print

Before the first printing, please complete the leveling, loading and calibration correctly under the guidance of the quick start guide.

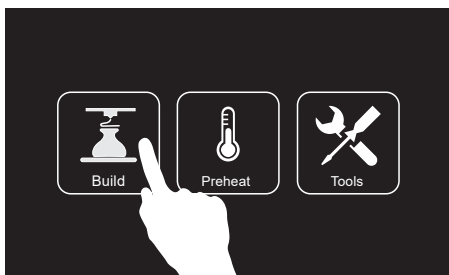

1. Tap [Build].

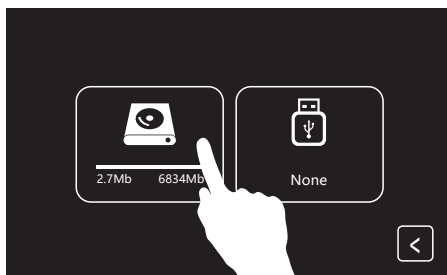

2. Tap [Local memory] to choose print files.



3. Choose the preset print file [PG.gx].

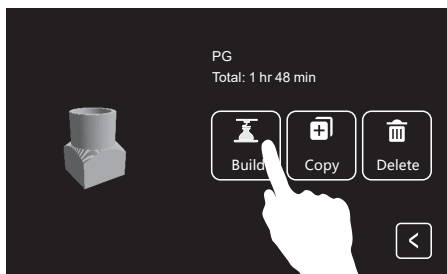

4. Tap [Build].

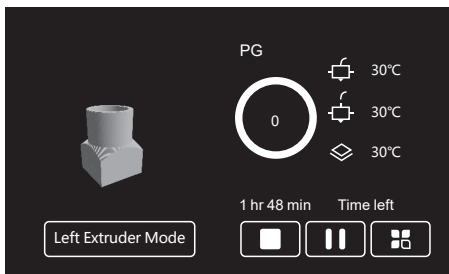

5. The printer starts to heat up and will start printing after heating completed.

## Unload Filament

Please follow steps below if you need to unload filament in daily use.

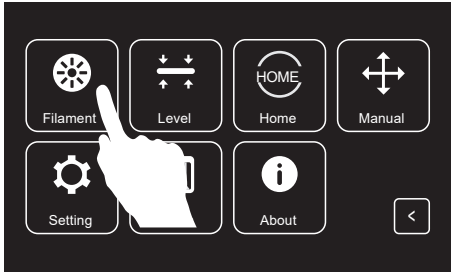
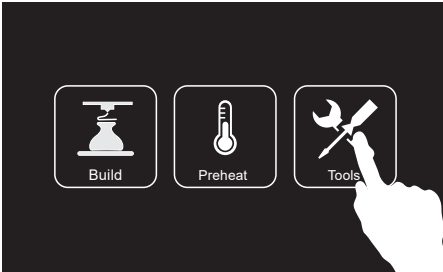

1. Tap [Tools], [Filament] to enter the filament interface.

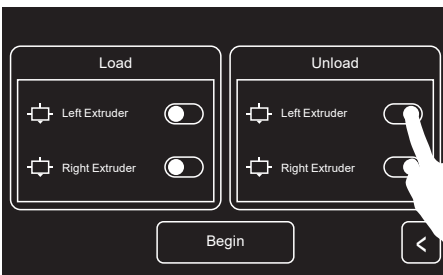

2. Tap the unload switch after corresponding extruder to unload corresponding extruder.

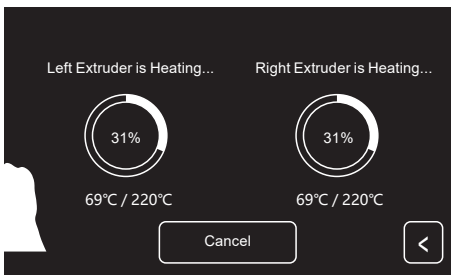

3. Tap [Begin], the extruder will start heating. The printer will start unloading filament after heating completed.

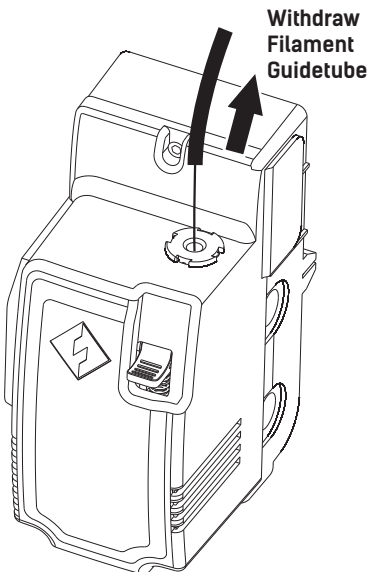

4. Pull filament guide tube out of filament intake, leave filament 10cm to pull filament easily.

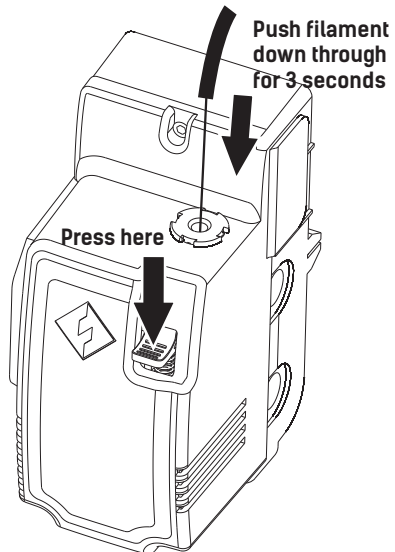

5. Press spring presser and push filament down through for 3 seconds, then pull out vertically quickly.



## 开箱



1. 剪断包装扎带，撕除缠绕膜。

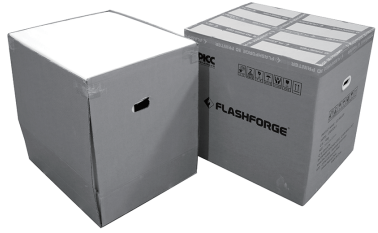

2. 向上提起外包装箱。



3. 移除顶部泡棉。



4. 移除打印机四周的泡棉。

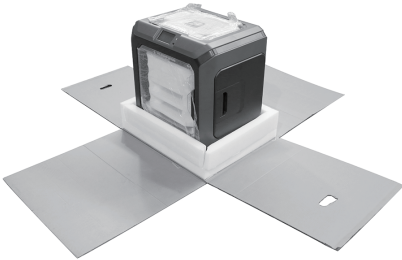

5. 割开纸箱四角的胶带露出打印机。打开气泡袋露出打印机。



6. 移除固定顶部的胶带，打开顶盖。

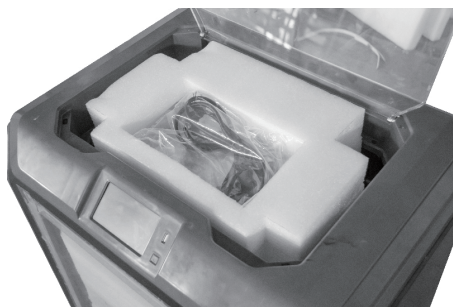

7. 取出顶部配件及泡棉。



8. 移除固定打印机前门的胶带。



9. 取出内部的泡沫块，其中包含两个废料盒及两卷3D打印耗材。

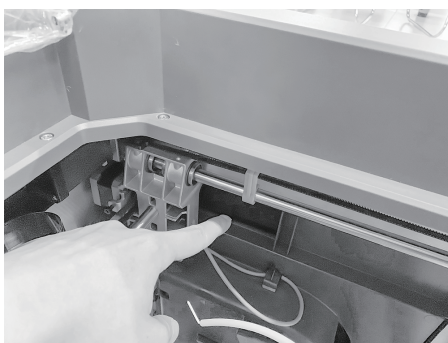
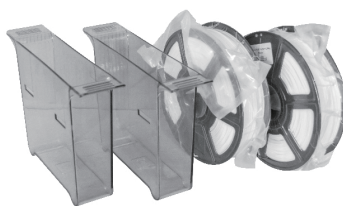

10. 移除X轴同步带和Y轴同步带上的卡扣。

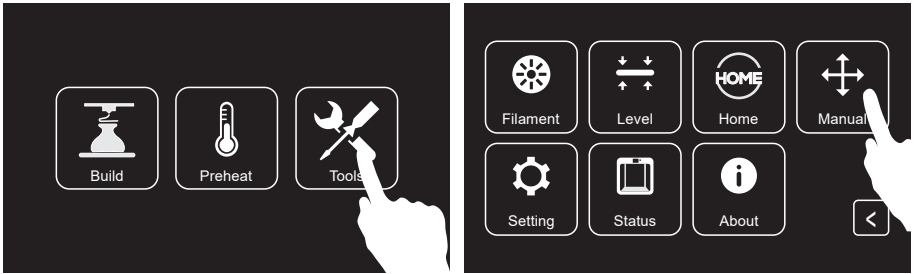

11. 取出电源线，插入打印机背部的电源线接口，通电后打开电源开关。开机完成后，在触摸屏上依次点击[Tools]、[Manual]进入手动控制界面。

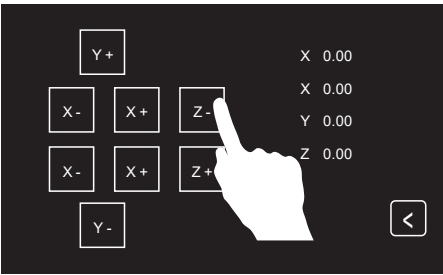

12. 持续按住[Z-]，直到打印平台上升到较高的位置，方便取出下方的泡沫块。

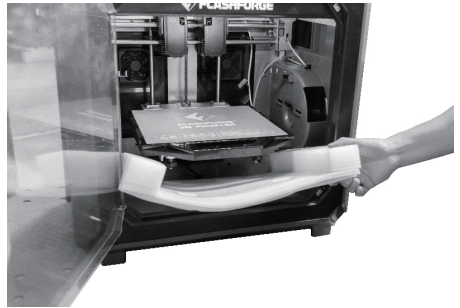

13. 移除打印平台下方的泡沫块。



14. 开箱完成！建议妥善保管开箱过程中移除的配件，以便方便日后保存或运输使用。

## 部件介绍

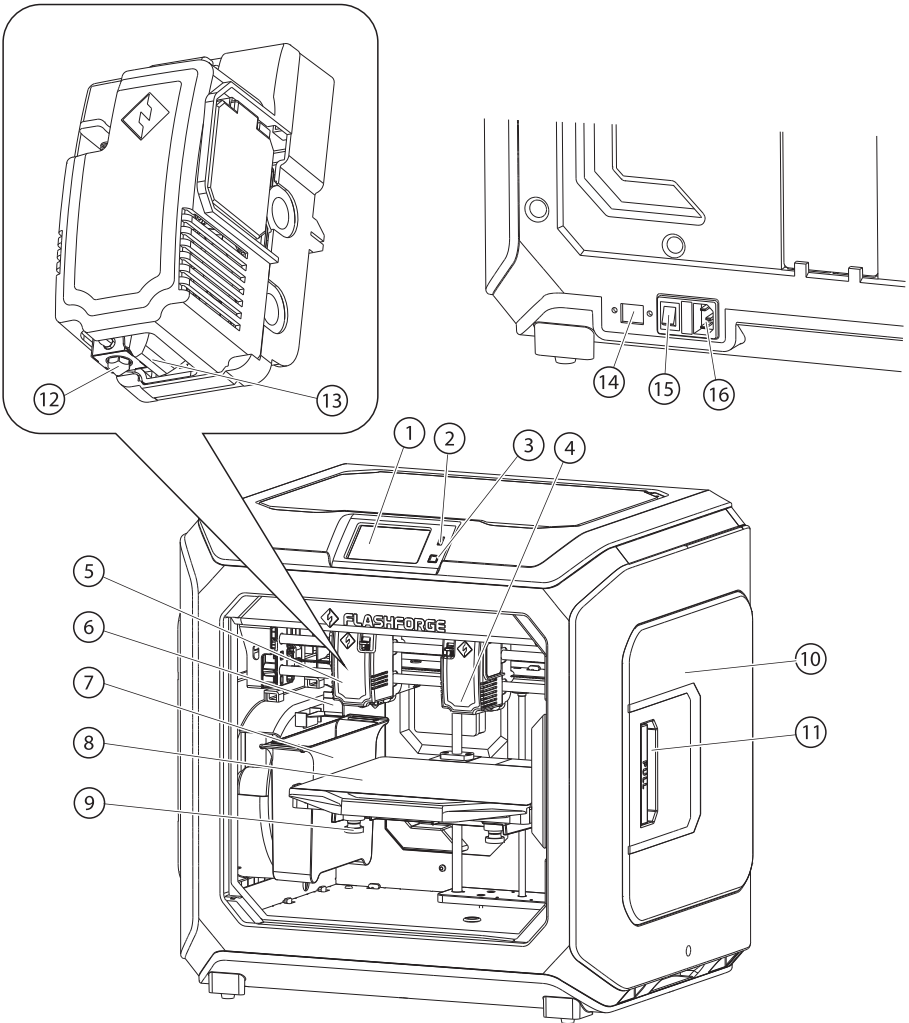

- |           |         |          |           |          |
|-----------|---------|----------|-----------|----------|
| 1. 触摸屏    | 2. U盘插口 | 3. 触摸屏开关 | 4. 右喷头    | 5. 左喷头   |
| 6. 喷嘴刷    | 7. 废料盒  | 8. 打印平台  | 9. 调平螺母   | 10. 丝盘盖  |
| 11. 丝盘盖把手 | 12. 喷嘴  | 13. 导风嘴  | 14. 以太网接口 | 15. 电源开关 |
| 16. 电源线接口 |         |          |           |          |

## 装箱物品

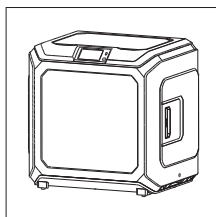

3D打印机

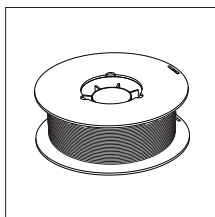

3D打印耗材

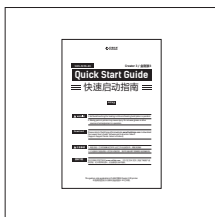

快速启动指南

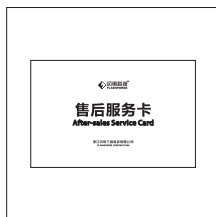

售后服务卡

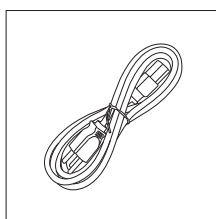

电源线

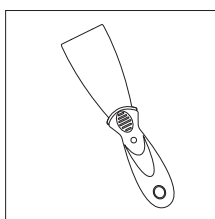

铲子

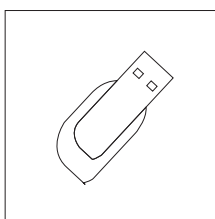

U盘

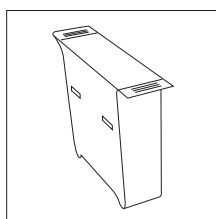

废料盒

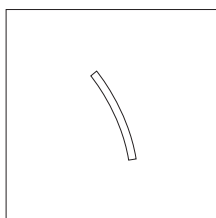

聚四氟管

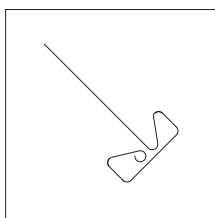

通针

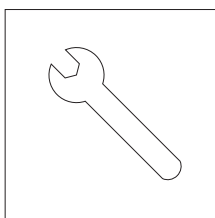

扳手

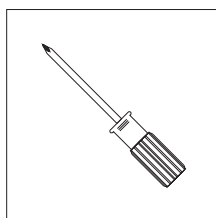

十字螺丝刀

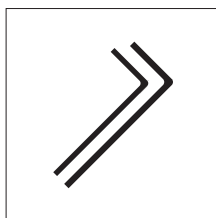

内六角扳手

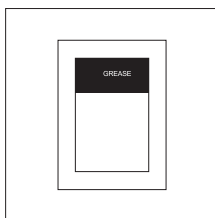

润滑脂

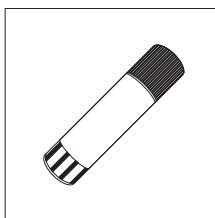

固体胶

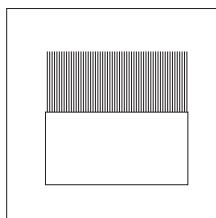

喷嘴刷

## 调平

### 将液晶屏语言设置为中文

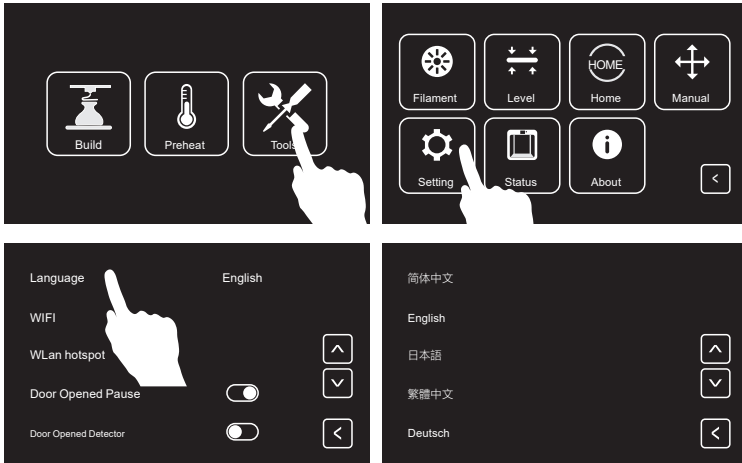

1. 在触摸屏上依次点击[Tools]、[Setting]、[Language]，选择[简体中文]。
2. 在语言设置完成后，返回上一界面，准备开始调平。在调平之前，让我们先了解一下调平螺母的作用。

### 如何通过调平螺母调节打印平台

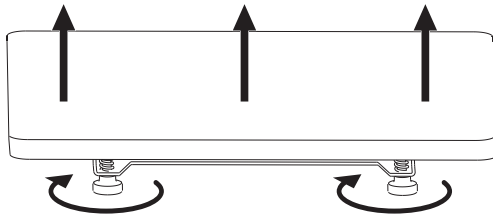

#### 顺时针旋转螺母

打印平台上升，喷嘴与平台之间间距变小

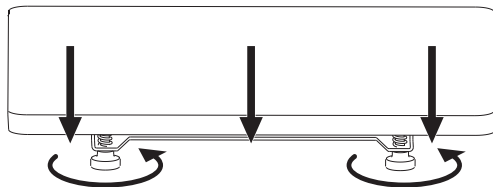

#### 逆时针旋转螺母

打印平台下降，喷嘴与平台之间间距变大

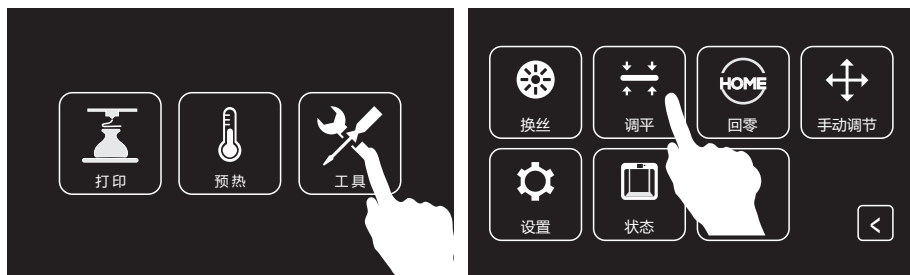

1. 在触摸屏上依次点击[工具]、[调平]开始调平。

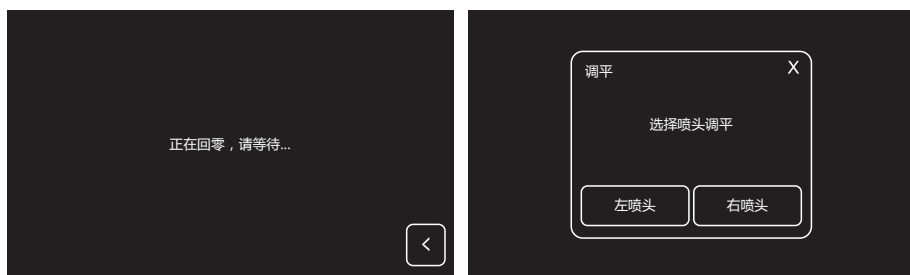

2. 在喷头和打印平台停止运动后, 选择使用哪个喷头进行调平。

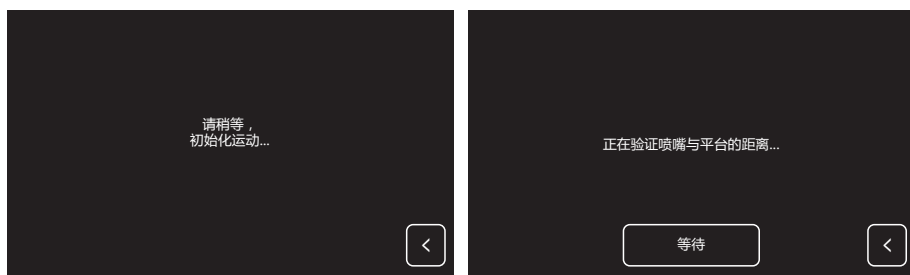

3. 选择完成后, 喷头开始对第一个调平点进行距离验证。验证完成后, 喷头会运动到第二个调平点进行距离验证。

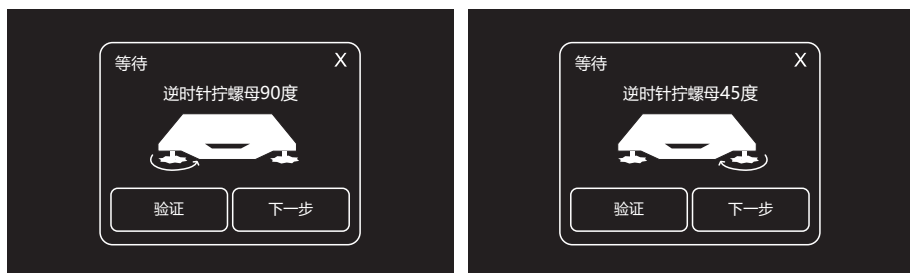

4. 在第二和第三个调平点的距离验证过程中, 如果喷嘴和打印平台之间的距离不合适, 请根据液晶屏上的提示信息进行相应的操作。第二个调平点验证通过后点击[OK], 进行第三个调平点的调平, 同样根据液晶屏上的提示信息进行相应的操作。第三个调平点完成后, 调平结束。

## 安装废料盒与喷嘴刷

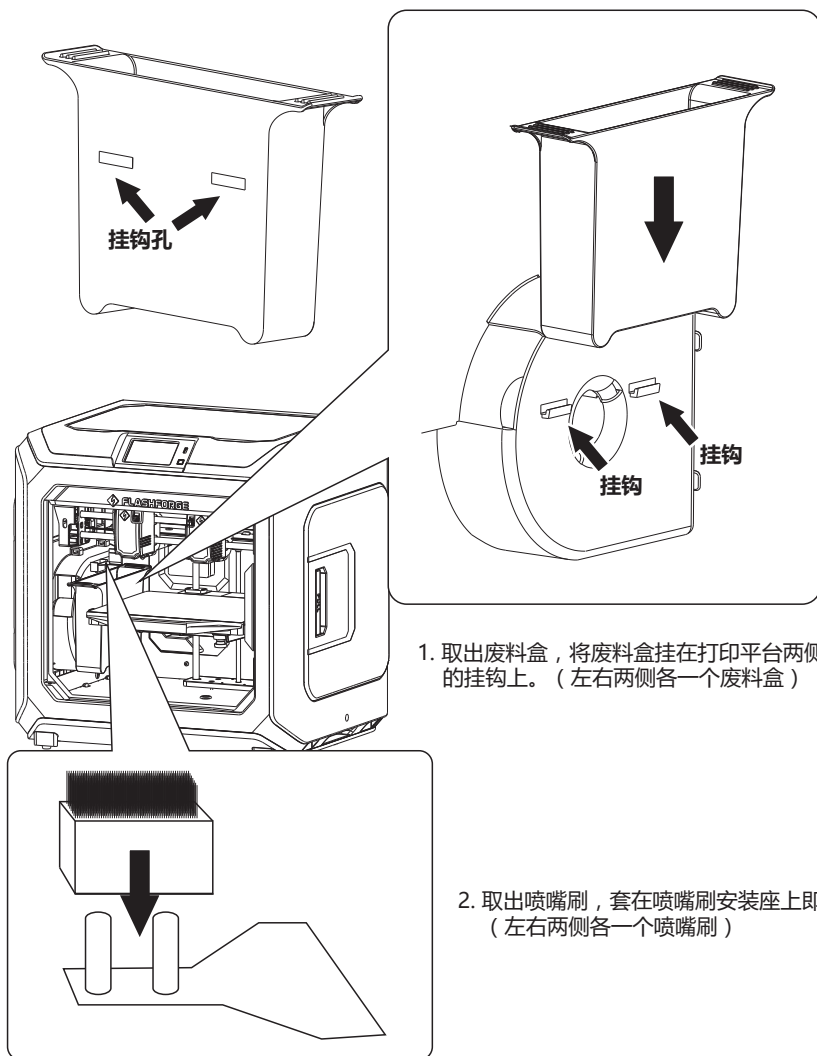

1. 取出废料盒，将废料盒挂在打印平台两侧的挂钩上。（左右两侧各一个废料盒）

2. 取出喷嘴刷，套在喷嘴刷安装座上即可。（左右两侧各一个喷嘴刷）



## 安装耗材

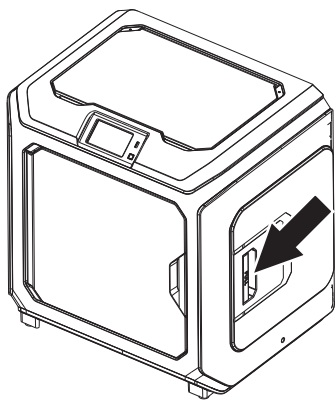

1. 打开丝盘盖。

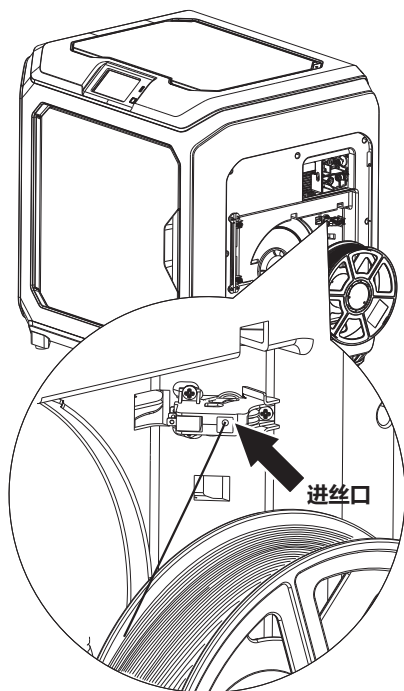

2. 取出耗材，将耗材插入进丝口中。

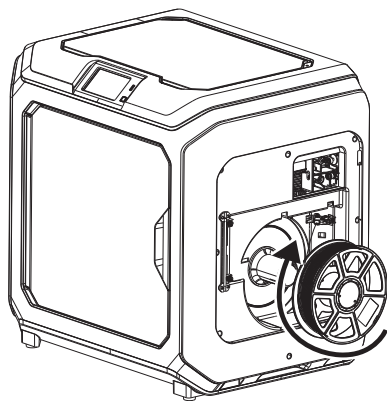
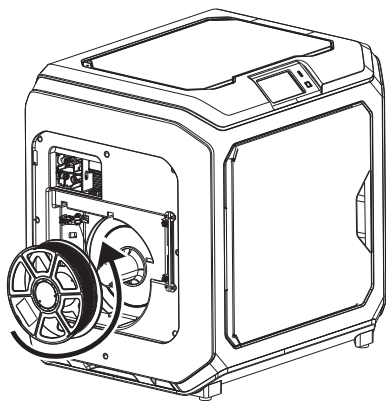

3. 注意：为方便耗材转动顺畅，请按图中所示的方向安装耗材。  
安装左侧耗材时，请按逆时针方向出丝；安装右侧耗材时，请按顺时针出丝。

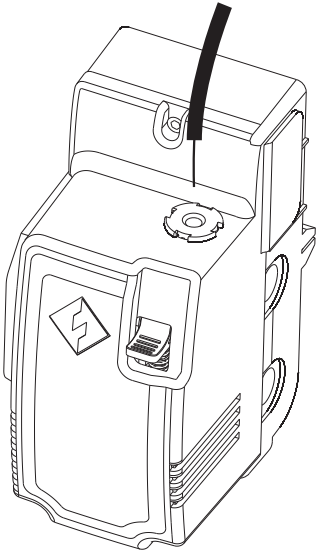

4. 持续将耗材送入进丝口，直到耗材从导丝管穿出。

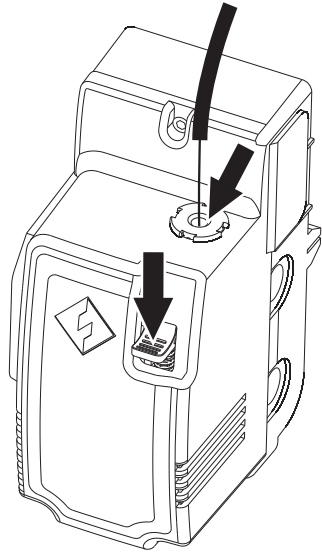

5. 按下喷头前方的进丝压板，将耗材垂直插入喷头，直到无法继续插入。松开进丝压板。

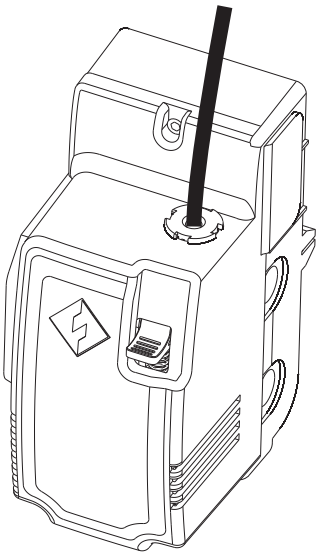

6. 将导丝管插入喷头进丝孔中固定。

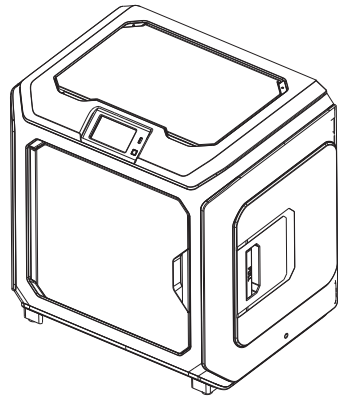

7. 最后将丝盘固定在丝盘架上，盖上丝盘盖。

## 进 丝



1. 点击[工具]、[换丝]进入进丝退丝界面。

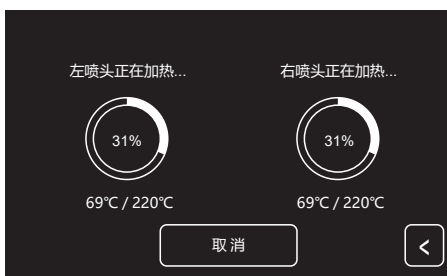
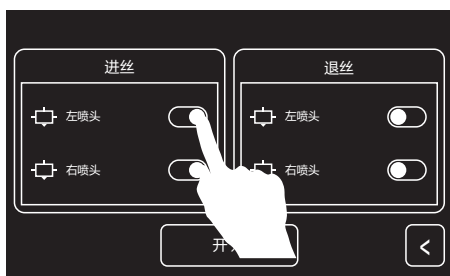

2. 点击[进丝]。点击对应喷头后面的开关按钮来选择该喷头是否执行进丝操作。

3. 选择完成后点击[开始]，选中的喷头开始加热。



4. 加热到预定温度后开始进丝，当看到耗材均匀出丝时点击[完成]返回上一界面。按返回箭头回到主界面。

**注意：若喷头长时间未出丝，请检查安装耗材时是否正确将耗材插入喷头底部。**

## 校正

首次使用校准功能，请在客服指导下操作。

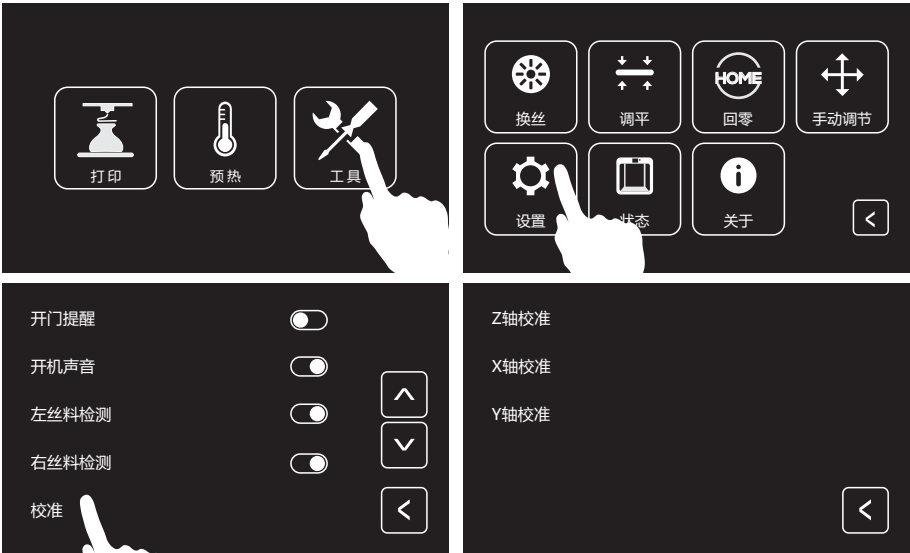

1. 依次点击[工具]、[设置]，在设置页面中找到并点击[校准]功能。

## Z轴校准

Z轴校准之前，请先进行调平。调平方法参见第18页。



1. 点击触摸屏[Z轴校准]，等待喷头和平台Z轴校准。校准过程中，不要中断。

## X轴校准

通过比对两个喷头在X轴方向打印的直线是否重合，判断两个喷头在同一条X轴上。

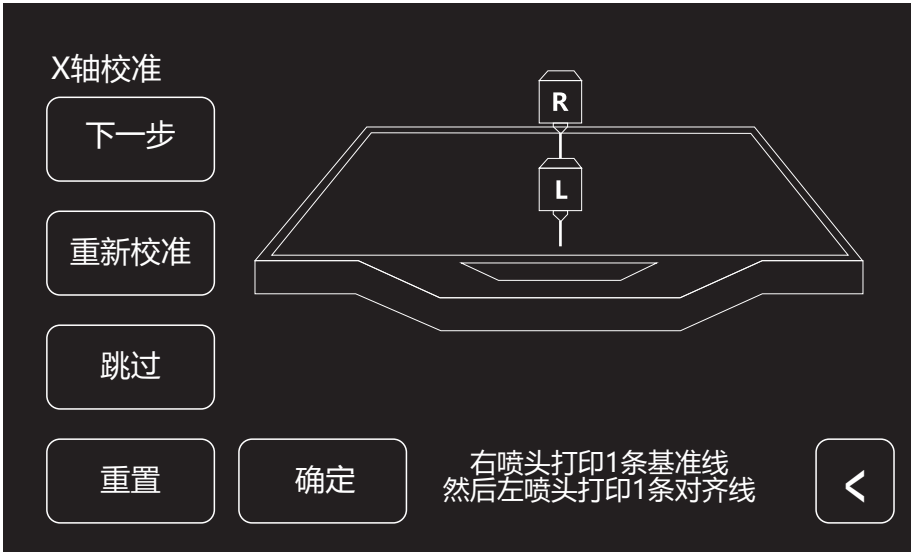

1. 点击触摸屏[X轴校准]，等待两个喷头加热；加热到目标温度，两个喷头依次打印一条直线。打印完毕，检查两条线是否重合；同时，触摸屏弹出确认窗口。

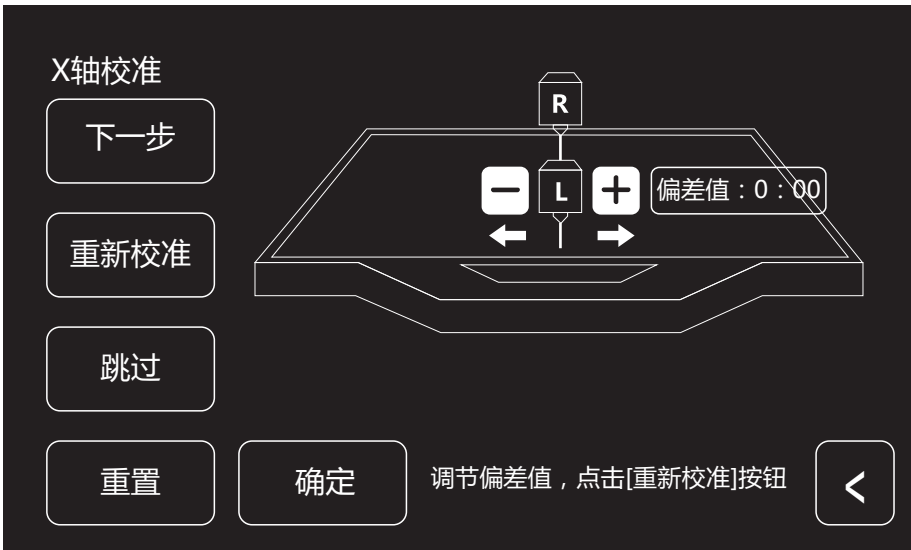

2. 若两条线完全重合，点击[是]，X轴校准完成。若两条线没有完全重合，点击[否]；根据实际情况调整喷头位置。调整结束后，清理打印平台上的耗材，并点击[重新校准]；重复上述步骤，直至打印的两条直线完全重合。

## Y轴校准

通过比对两个喷头在Y轴方向打印的直线是否重合，判断两个喷头在同一条Y轴上。

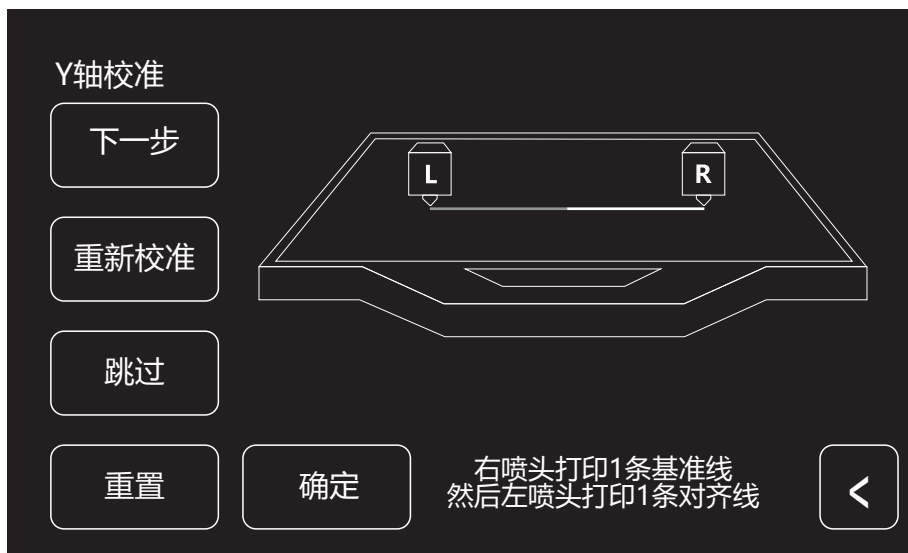

1. 点击[Y轴校准]，等待两个喷头加热。加热到目标温度，两个喷头依次打印一条直线。打印完毕，检查两条线是否重合，同时触摸屏弹出确认窗口。

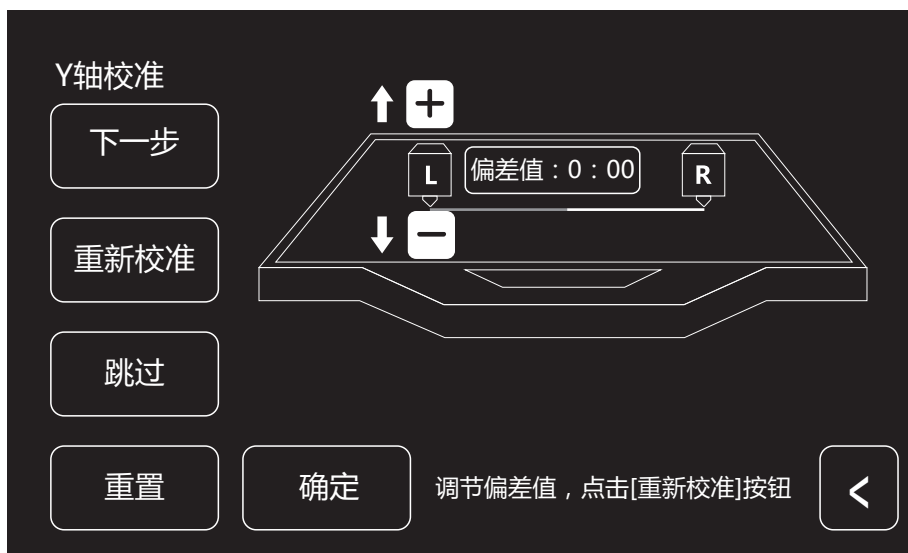

2. 若两条线没有完全重合，点击[否]。根据实际情况调整喷头位置。调整结束后，清理打印平台上的耗材，并点击[重新校准]；重复上述步骤，直至打印的两条直线完全重合。

## 首次打印

首次打印前，请在快启的指引下正确地完成调平、进丝和校准。

### 打印建议

1. 打印开始前请确保打印机已经经过调平；
2. 打印开始前确保耗材安装正确，没有打结或卡住；
3. 喷头内可能残留有少量耗材，请进丝一段时间，确保上一次打印的耗材已经全部挤出；
4. 使用ABS耗材打印时，请装上顶罩，关闭前门；  
使用PLA耗材打印时，请移除顶罩，打开前门；
5. 打印开始前请将喷头耗材清理干净；
6. 不可在长时间无人看守的情况下使用3D打印机；



1. 点击[打印]。

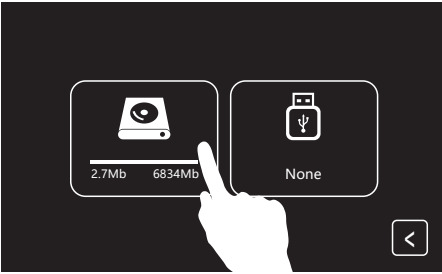

2. 点击[内部存储]进入打印模型选择界面。

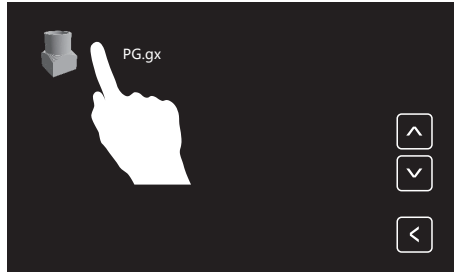

3. 选择预设文件[PG.gx]。

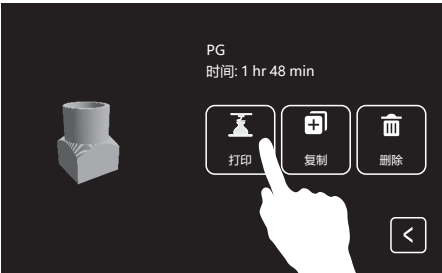

4. 点击[打印]。



5. 打印机开始加热，加热完成后开始打印。

## 退丝操作

在日常使用中，如果需要更换耗材，建议按下列步骤操作。



1. 点击[工具]、[换丝]进入进丝退丝界面。

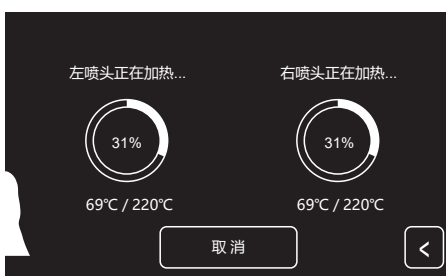
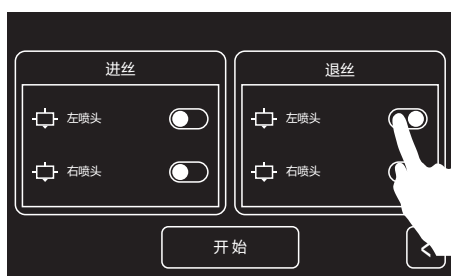

2. 点击[退丝]。点击对应喷头后面的开关按钮来选择该喷头是否执行退丝操作。

3. 选择完成后点击[开始]，选中的喷头开始加热。加热完成后开始退丝。

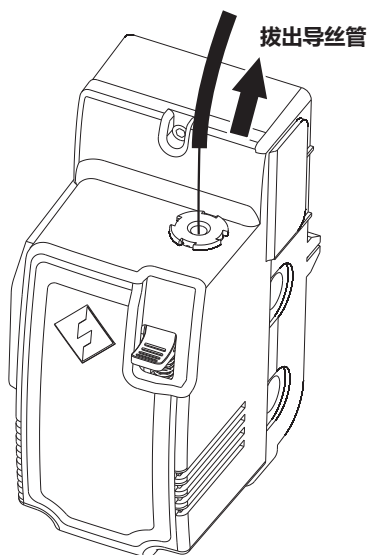

4. 拔出导丝管。

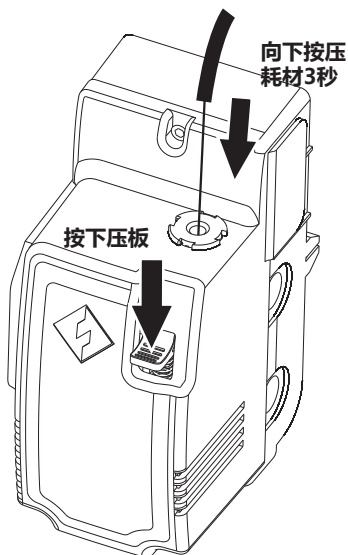

5. 按下进丝压板，将耗材向下按压3秒后快速垂直拔出。







YouTube



优酷自频道

Scan QR to Get More  
After-Sales Support  
扫描二维码获得更多售后支持



售后专线 : [support@ff3dp.com](mailto:support@ff3dp.com)

After-Sales Service: [support@ff3dp.com](mailto:support@ff3dp.com)

电话 : 400 6991063 官方网站 : [www.sz3dp.com](http://www.sz3dp.com) 地址 : 浙江省金华市仙源路518号

Tel: +86 579 82273989 Web: [www.flashforge.com](http://www.flashforge.com) Add: 2/F, No.518, Xianyuan Road, Jinhua, Zhejiang, China