

BMA 360

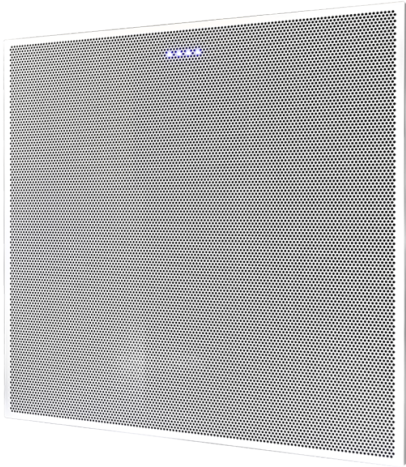

The patented BMA 360 is the world's most technologically advanced ceiling tile beamforming mic array, delivering unrivaled audio performance and deployment ease.

The world's first truly wideband, frequency invariant beamforming mic array with uniform gain response across all frequency bands. FiBeam™ technology gives users the ultimate in natural and full fidelity audio across all beams and within a single beam.

- > Further advancements in adaptive steering (think of it as smart switching) provide impeccable coverage of each conference participant as well as support for camera tracking.
- > 6G Acoustic Echo Cancellation (AEC) delivers unparalleled per-beam full-duplex audio performance.
- > On-board audio algorithms, like noise reduction, filtering, and Automatic Level Control, eliminate the need for per-beam processing in a DSP mixer - requiring fewer DSP mixer resources.
- > Built-in, robust power amplifiers, configurable as 4 x 15 Watt or 2 x 30 Watt, provide flexibility for driving loudspeakers.
- > ClearOne's breakthrough technologies, FiBeam, DsBeam, and 6G AEC combine to create VividVoice™, a significant advancement for professional conferencing.
- > Integrated features significantly reduce system design complexity, simplify installation, consume less rack space, and lower system cost.
- > Daisy-chain up to three ceiling tiles via P-Link for divisible rooms or larger conference setups – for simpler wiring and longer distances compared to networked “home run” connections via Ethernet.
- > Single workflow for configuration using CONSOLE® AI software. Competing products require practitioners to program multiple system components using different toolsets: Ethernet switches, Ceiling Tiles, DSP mixers, and the Dante Controller.
- > Supports three different ceiling grid types: 24 in, 600 mm, and 625 mm. It incorporates a VESA-mount hole pattern that supports pole mounting. Hard-ceiling mount adapter kits are also available.

APPLICATIONS

- Audio conferencing
- Video conferencing

WORKSPACES

- Conference rooms
- Boardrooms
- Courtrooms
- Classrooms
- Telemedicine theaters

AUDIO CONFERRING

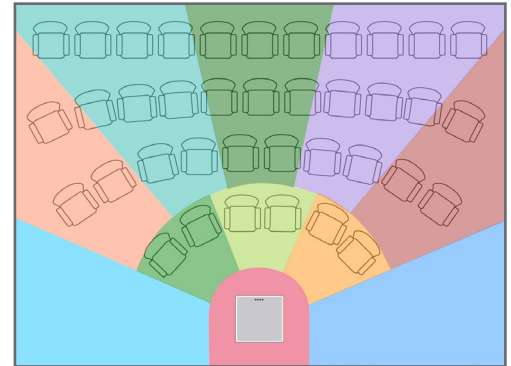

Superior Beam Topology

A dramatically new approach to precision beamforming provides a new beam topology to easily achieve distortion-free, full 360-degree coverage of any room shape and any seating arrangement using ClearOne *Audio Intelligence*™.

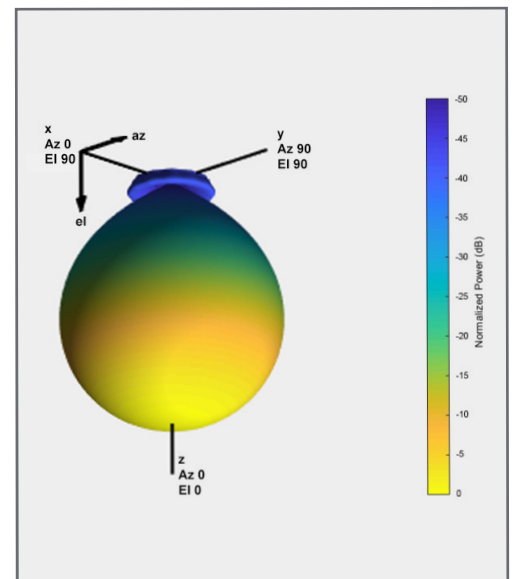

Deep Sidelobe Beamforming

Deep Sidelobe Beamforming, DsBeam™, provides unparalleled sidelobe depth, below -40 dB, resulting in superior rejection of reverb and noise in difficult spaces for superb clarity and intelligibility

You're not beamforming unless you're beamforming with ClearOne!™

MICROPHONES

Connections

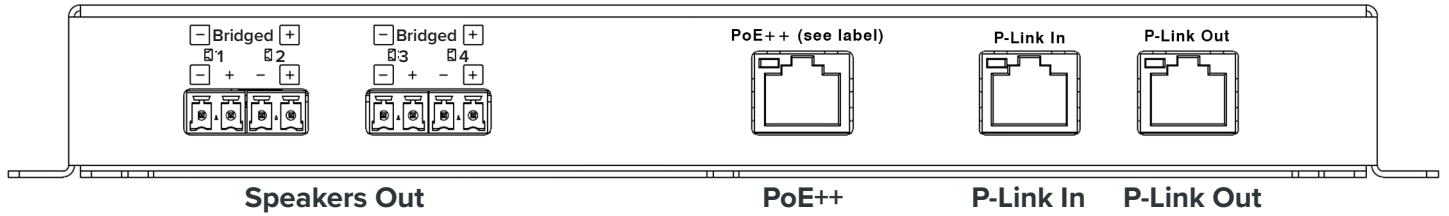

System Diagram

Three daisy-chained BMA 360 microphone arrays, with 2x30W and 4x15W speaker configurations, connected to a CONVERGE® Pro 2

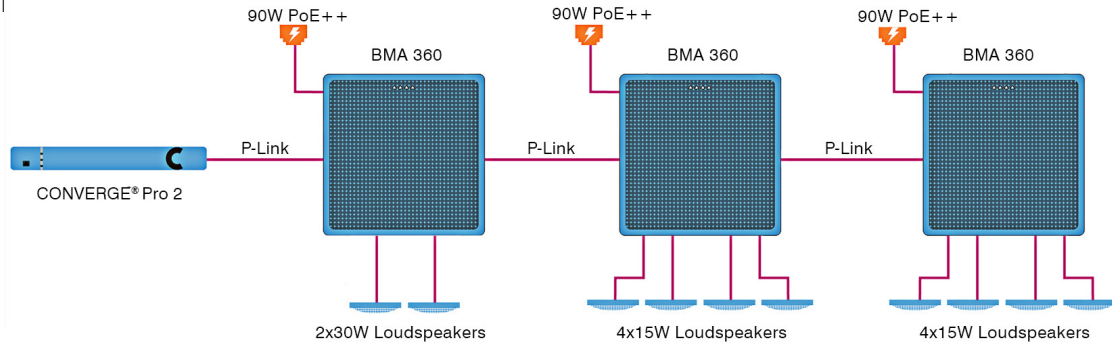

Room Coverage

Full Circle/Square

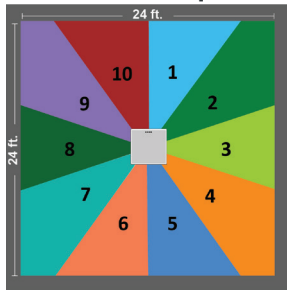

Room size	Beams
10' x 10' to 18' x 18'	6
12' x 12' to 20' x 20'	8
22' x 22' to 24' x 24'	10

Rectangular



Room size	Beams
10' x 14' to 18' x 22'	6
10' x 16' to 18' x 24'	8
12' x 22' to 20' x 36'	12

Semi-Circle/Classroom

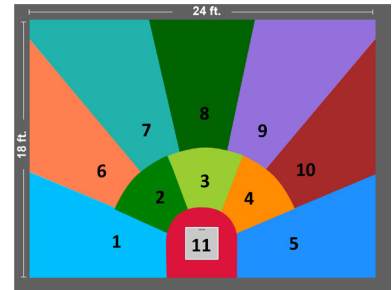

Room size	Beams
16' x 8' to 22' x 16'	6
24' x 18'	11

Note: The example room sizes are based on a 10 ft. ceiling.

Deep Sidelobe Beamforming

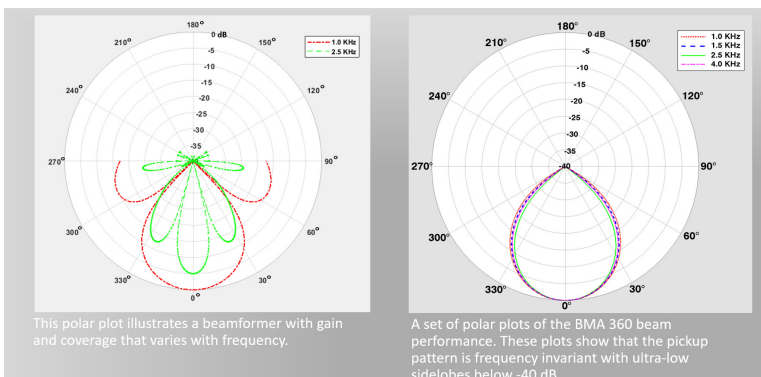

MICROPHONES

Polar Plots (Broadside)

Typical Far Field Performance

Narrow Beam, HPBW = 35°

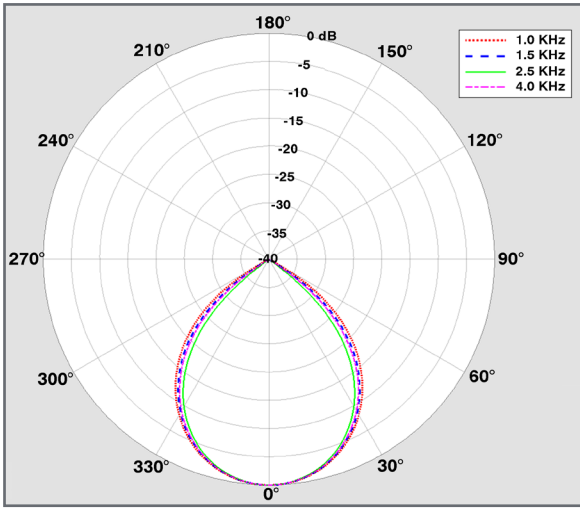

Medium Beam, HPBW = 45°

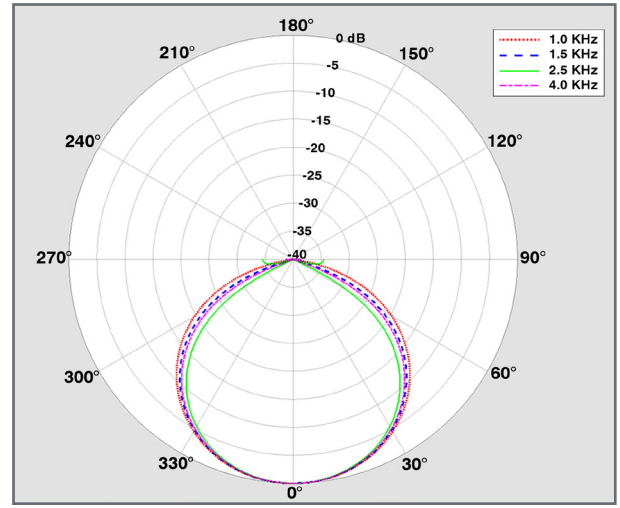

Gain response is frequency invariant for all beamwidths.

Wide Beam, HPBW = 55°

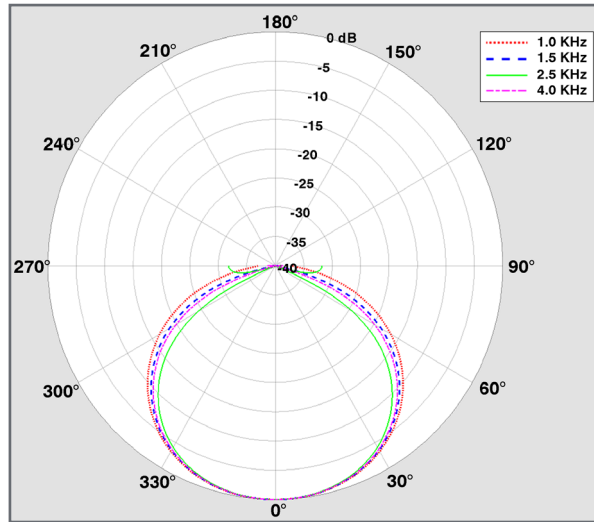

HPBW = Half Power Beamwidth

Frequency Response (Broadside)

Typical Frequency Response

Frequency response measured directly on-axis from a distance of 2 meters.

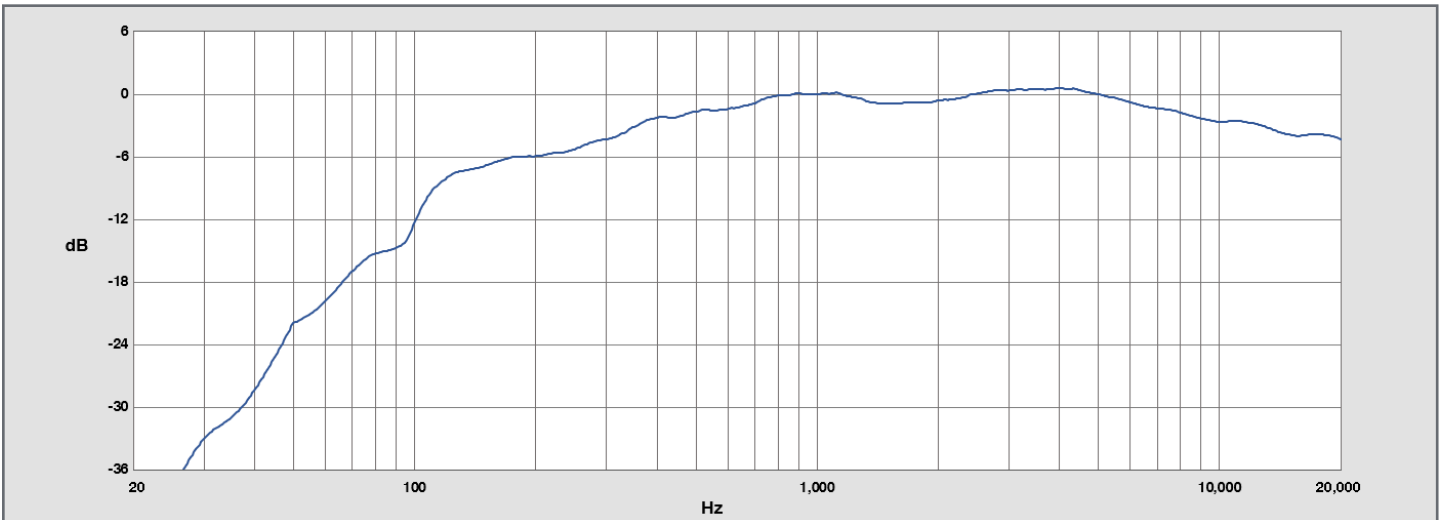

BMA 360

BEAMFORMING FEATURES

- True Frequency Invariant Beamformer: Gain response is unvarying across frequency
- Beamwidths: 35°, 45° and 55° with Frequency Invariance
- Beamforming Range: 100 Hz to 20 KHz
- Deep Sidelobes: Down to 45 dB of depth
- Beam Pointing Accuracy: 0.2 dB
- Dynamic Range: 20 Hz to 20 KHz, > 70 dB
- Number of Beams: 6, 8, 10, 11, or 12
- Room Patterns: Full Circle/Square, Rectangular, Semi-Circle/Classroom
- Coverage Sizes: 24 sizes from small 10 ft x 10 ft up to extra large 36 ft x 20 ft
- Ceiling Height: Configurable with CONSOLE AI from 7 ft to 20 ft

AMPLIFIER OUTPUT

- Type: 5.08mm Header, Phoenix-type Euroblock
- Audio: 4 channels
- Output Power: 4x15W Max, 8 Ω load, or 2x30W, 4Ω load, Bridged
- Frequency Response: 20Hz – 22kHz, +/- 0.5dB

CONFIGURATION

- Acoustic Echo Cancellation (AEC) On/Off
- Noise Cancellation (NC) on/off. Range: 6 to 25 dB depth.
- Automatic Level Control (ALC) On/Off
- Gain Adjust
- Mute On/Off

SOFTWARE

- CONSOLE® AI

DIMENSION & WEIGHT

- 24 in:
23.72 x 23.72 x 2.13 in (602.5 x 602.5 x 54.1 mm)
- 600 mm:
592.5 x 592.5 x 54.1 mm (23.33 x 23.33 x 2.13 in)
- Product Weight: 9 lbs, 4.1 kg
- Shipping Weight: 12.85 lbs, 5.83 kg

MOUNTING

- Ceiling Mount: 24 in, 600 & 625 mm drop-ceiling grid
- VESA® Mount ready: 100 mm hole pattern, M4x10 mm

P-LINK PERIPHERAL BUS PORT

- Ports Type: RJ-45
- P-Link In and Out: Proprietary peripheral bus
- P-Link Power ¹
 - 56V 36W IEEE 802.3at compliant devices or equivalent, Mode B

- Cable: Solid core 23AWG, factory terminated Cat6
- Distance
 - Normal distance mode: Up to 200 ft (60 m)
 - Long distance mode: To be supported with a future firmware upgrade.

POE ++ ² PORT

- Port Type: RJ45 PoE power
- Power on all pairs
- 56V 90W IEEE 802.3bt compliant devices or equivalent, Mode A and B, Midspan
- Cable: Solid core, 23AWG, factory terminated Cat6

POE REQUIREMENTS

- No speakers: 36W PoE, connected via P-Link or PoE++
- Speakers: Requires 56V 90W IEEE 802.3bt PoE, must be via direct PoE++ port on the BMA 360

POWER SELECTION

- Automatically senses and switches to whichever input port has PoE power

POWER AND THERMAL

- Power Source: PoE injector or equivalent
- Power Consumption:
 - 100-240VAC, 50/60 Hz
 - 23 Watt typical without speaker amp
 - 55W at 1/3 power x 4 @ 1kHz
- Thermal: 270 BTU/hr at max power
- Operating Temperature: 14 °F/-10 °C to 104 °F/40 °C ambient temperature

ACCESSORIES

- 910-3200-202 PoE Power supply kit, 36W *
- 910-3200-207 PoE Power supply kit, 70W
- 910-3200-209 PoE Power supply kit, 90W*
- 910-3200-205-AI Brackets, convert 600 to 625mm
- 910-3200-208-CB BMA CT Conduit Box

MOUNTS FOR NON-TILE CEILINGS

- 910-3200-210 BMA 360 Surface-Mount Kit 24in
- 910-3200-210-I BMA 360 Surface-Mount Kit 600mm
- 910-3200-212 BMA 360 Recessed-Mount Kit 24in
- 910-3200-212-I BMA 360 Recessed-Mount Kit 600mm

PART NUMBERS

- 910-3200-208 BMA 360
- 910-3200-208-I BMA 360 INTERNATIONAL

SALES AND INQUIRIES

Headquarters

5225 Wiley Post Way
Suite 500
Salt Lake City, UT 84116

US & Canada

Tel: 801.975.7200
Fax: 801.303.5711

International

Tel: +1.801.975.7200
global@clearone.com

Sales

Tel: 801.975.7200
sales@clearone.com

Tech Support

Tel: 801.974.3760
techsupport@clearone.com