

EP-Series Ultra HD LCD Displays User Guide



Copyright © 3 Jun 2015 by Planar Systems, Inc. All rights reserved.

Contents of this publication may not be reproduced in any form without permission of Planar Systems, Inc.

Trademark Credits

Windows™ is a trademark of Microsoft Corp.

All other companies are trademarks or registered trademarks of their respective companies.

Disclaimer

The information contained in this document is subject to change without notice. Planar Systems, Inc. makes no warranty of any kind with regard to this material. While every precaution has been taken in the preparation of this manual, the Company shall not be liable for errors or omissions contained herein or for incidental or consequential damages in connection with the furnishing, performance, or use of this material.

Warranty and Service Plans

Planar warranty and service plans will help you maximize your investment by providing great support, display uptime, and performance optimization. From post-sale technical support to a full suite of depot services, our services are performed by trained Planar employees. When you purchase a Planar product, you get more than a display, you get the service and support you need to maximize your investment. To find the latest warranty and service information regarding your Planar product, please visit <http://www.planar.com/support>

RoHS Compliance Statement

The Planar EP-Series is fully RoHS compliant.

Part Number: 020-1280-00

Table of Contents

- EP-Series Ultra HD LCD Displays User Guide** i

- Introduction**1
 - Safety Information2
 - Safety Precautions.....2
 - Recommended Usage.....4
 - VESA Mounts, General Description.....6
 - Cleaning the Display7

- Package Contents**.....8
 - Unpacking the Display8
 - Installing the Cable Clips 12

- Dimensions** 13
 - EP5814K 13
 - EP5814K-T 14
 - Planar EP Series - Standard Inputs..... 15

- Installing the Display** 16
 - Before You Begin..... 16
 - Installing OPS Expansion (Optional)..... 18

- Operating the Display** 19
 - OSD Keypad..... 19
 - Remote Control Receiver 20
 - LED Indicators..... 21
 - Using the Display in Portrait Mode..... 21

Using the Display in Flat or Tilted Orientation	21
Using the Remote Control	22
Turning the Display On	25
Turning the Display Off	26
Adjusting the Volume	26
Selecting the Input Source	26
Navigating Through the Menus	26
Using the Touch Screen	48
Performing basic functions	48
Touchscreen MultiTouch Driver Installation	50
Touchscreen (PQ Labs) MultiTouch Platform Content	50
Uninstalling the MultiTouch Driver	51
Multi-Touch Functions	51
LAN Control	52
Supported Operating Systems	52
Installation	53
Configuring VCOM	56
Function Descriptions	58
Setting Up Email Alerts	62
Login	62
Administrator	64
TCP Mode, UDP Mode and UART	67
SMTP	67
Reset Device	68
Signal Compatibility	69

Specifications71

Troubleshooting73

Accessing Planar’s Technical Support Website74

Introduction

The Ultra HD resolution Planar EP-Series LCD displays offer best-in-class reliability with the stunning image quality of 4K resolution. The displays come standard with commercial-grade features required for digital signage, corporate, and control room environments.

Also available in touch versions, Ultra HD Planar EP-Series displays bring interactivity to the 4K immersive experience.

Caution: This manual is intended for use by qualified service persons and end users with experience installing LCD displays.

Safety Information

Before using the Planar EP-Series, please read this manual thoroughly to help protect against damage to property, and to ensure personnel safety.

- Be sure to observe the following instructions.
- For your safety, be sure to observe ALL the warnings detailed in this manual.
- For installation or adjustment, please follow this manual's instructions, and refer all servicing to qualified service personnel.

Safety Precautions

- **If water is spilled or objects are dropped inside the display, remove the power plug from the outlet immediately.** Failure to do so may result in fire or electrical shock. Contact your dealer for inspection.
- **If the display is dropped or the chassis is damaged, remove the power plug from the outlet immediately.** Failure to do so may result in fire or electrical shock. Contact your dealer for inspection.

WARNING! Wall mounts must be secure.

- **If the display is hung on a wall, the wall must be strong enough to hold it.** Simply mounting it to wallboard or wall paneling won't be adequate or safe.

Caution: The screen could be damaged by heavy pressure.

- **Slight pressure on the LCD will cause distortion of the image.** Heavier pressure will cause permanent damage. Displays should be mounted where viewers cannot touch the screen or insert small objects in the openings that will create hazards by contacting bare conductive parts.

Caution: The front polarizer is soft and subject to scratches from sharp objects.

- **The polarizer is a thin sheet of film laminated to the outside layer of glass on the LCD screen.** Take care when handling items near the screen.
- **If the power cord or plug is damaged or becomes hot, turn off the main power switch of the display. Make sure the power plug has cooled down and remove the power plug from the outlet.** If the display is still used in this condition, it may cause a fire or an electrical shock. Contact your dealer for a replacement.

Important Safety Instructions

- 1** Read these instructions.
- 2** Keep these instructions.
- 3** Heed all warnings.
- 4** Follow all instructions.
- 5** Do not use the display near water.
- 6** Clean the LCD screens with an LCD screen cleaner or LCD wipes.
- 7** Do not install near any heat sources such as radiators, heat registers, stoves or other apparatus (including amplifiers) that produce heat.
- 8** Do not defeat the safety purpose of the polarized or grounding type plug. A polarized plug has two blades with one wider than the other. A grounding type plug has two blades and a third grounding prong. The wide blade or the third prong is provided for your safety. When the provided plug does not fit into your outlet, consult an electrician for the replacement of the obsolete outlet.
- 9** Protect the power cord from being walked on or pinched, particularly at plugs, convenience receptacles and the point where they exit from any of the displays.
- 10** Only use the attachments/accessories specified by the manufacturer.
- 11** Unplug all displays during lightning storms or when unused for long periods of time.
- 12** You must follow all National Electrical Code regulations. In addition, be aware of local codes and ordinances when installing your system.
- 13** Refer all servicing to qualified service personnel. Servicing is required when any of the displays have been damaged in any way. For example, if the AC power cord or plug is damaged, liquid has been spilled or objects have fallen into a display, the displays have been exposed to rain or moisture, do not operate normally or have been dropped.
- 14** Keep the packing material in case the equipment should ever need to be shipped.
- 15** Wall mounts must be secure. The wall must be strong enough to hold all displays, brackets and cables.

- 16 Slight pressure on the LCD will cause distortion of the image. Heavier pressure will cause permanent damage. Displays should be mounted where viewers cannot touch the screen or insert small objects in the openings that will create hazards by contacting bare conductive parts.
- 17 The front polarizer is soft and subject to scratches from sharp objects. The polarizer is a thin sheet of film laminated to the outside layer of glass on the LCD screen. Take care when handling items near the screen.

Recommended Usage

In order to get the most out of your LCD, use the following recommended guidelines to optimize the display.

Burn-In Versus Temporary Image Retention

Burn-in causes the screen to retain an image essentially forever, with little or no way to correct the problem. Under normal use, an LCD will not experience burn-in, as plasma displays do, nor will it retain images in any way.

Normal use of an LCD is defined as displaying continuously changing video patterns or images. However, LCDs can experience *temporary* image retention when recommended usage guidelines are not followed.

What is Temporary Image Retention?

Temporary image retention (TIR) can occur when a static image is displayed continuously for extended periods of time (12 hours or longer). An electrical charge differential may build up between the electrodes of the liquid crystal, which causes a negative-color video image (color-inverted and brightness-inverted version of the previous image) to be retained when a new image is displayed. This behavior is true for any LCD device from any LCD manufacturer.

TIR is not covered under warranty. See standard warranty terms and conditions for details. Here are some guidelines to help you avoid TIR:

- Use the LCD to show a screen saver, moving images or still pictures that change regularly. When using high-contrast images, reposition the images frequently.
- Turn off the LCD when it is not in use. To use your source computer's Power Options Properties, set up your computer to turn off the display when not in use.

Caution: For optimal performance, we suggest turning off the backlight power on the display for six hours per day.

European Union Disposal Information

English

- Disposal of old Electrical & Electronic Equipment (Applicable throughout the European Union and other European countries with separate collection programs)

This symbol found on your product or on its packaging, indicates that this product should not be treated as household waste when you wish to dispose of it. Instead, it should be handed over to an applicable collection point for the recycling of electrical and electronic equipment. By ensuring this product is disposed of correctly, you will help prevent potential negative consequences to the environment and human health, which could otherwise be caused by inappropriate disposal of this product. The recycling of materials will help to conserve natural resources.



This symbol is only valid in the European Union. If you wish to discard this product, please contact your local authorities or dealer and ask for the correct method of disposal.

Español

- Deshecho de equipos eléctricos y electrónicos (aplicable a la Unión Europea y a otros países europeos con programas de reciclaje independientes)

La presencia de este símbolo en el propio producto o en su material de embalaje, indica que no se debe tratar como residuo doméstico cuando desee deshacerse de él. En su lugar, debe entregarlo en el punto limpio correspondiente de reciclaje de equipos eléctricos y electrónicos. Asegurándose de que este producto se desecha de forma correcta, ayudará a evitar posibles consecuencias negativas para la conservación del medioambiente y la salud humana, consecuencias que podrían darse si se desecha del producto de forma inadecuada. El reciclado de materiales ayuda a conservar los recursos naturales.



Este símbolo solamente es válido en la Unión Europea. Si desea deshacerse de este producto, póngase en contacto con las autoridades locales o con su distribuidor y pida información sobre el método de disposición adecuado.

Português

- Eliminação de equipamentos eléctricos e electrónicos usados (aplicável na União Europeia e noutros países europeus com programas próprios de recolha destes equipamentos)

Este símbolo, colocado no produto ou na respectiva embalagem, indica que o produto não deve ser tratado como lixo doméstico quando da sua eliminação. Em vez disso, deve ser entregue num ponto de recolha de equipamentos eléctricos e electrónicos para posterior reciclagem. Ao garantir a correcta eliminação deste produto, estará a evitar consequências potencialmente negativas tanto para o ambiente como para a saúde humana. A reciclagem de materiais ajuda a preservar os recursos naturais.



Este símbolo apenas é válido na União Europeia. Se quiser eliminar este produto, contacte as entidades locais ou o seu fornecedor para ficar a saber qual o método de eliminação correcto.

Svenska

- Avfall av förbrukad elektrisk och elektronisk utrustning (Tillämpbart i hela Europeiska unionen och andra europeiska länder med separata samlingsprogram)

Den här symbolen som finns på din produkt eller på dess förpackning påvisar att produkten inte ska behandlas som hushållsavfall när du vill slänga bort den. Istället ska den lämnas över till en lämplig uppsamlingspunkt för återvinning av elektriska och elektroniska utrustningar. Genom att tillförsäkra att den här produkten återvinns på ett riktigt sätt hjälper du till med att förhindra möjliga negativa konsekvenser för miljön och mänsklig hälsa. Det kan annars orsakas på grund av olämplig sophantering av den här produkten. Återvinning av material kommer att hjälpa till att bevara naturtillgångar.



Den här symbolen är endast giltig inom den Europeiska unionen. Om du vill slänga bort den här produkten ska du kontakta lokala myndigheter eller återförsäljare, och fråga efter lämplig avfallsmetod.

Français

- Mise au rebut des équipements électriques et électroniques usagés (Valable dans l'ensemble de l'Union Européenne ainsi que dans les pays européens disposant de programmes distincts de collecte des déchets)

Ce symbole appliqué sur votre produit ou sur son emballage indique que ce produit ne doit pas être traité comme un déchet ménager lorsque vous voulez le mettre au rebut. Il doit au contraire être remis à un site de collecte agréé pour le recyclage des équipements électriques et électroniques. En veillant à ce que ce produit soit mis au rebut de façon adéquate, vous contribuerez à prévenir les conséquences potentiellement négatives sur l'environnement et sur la santé humaine qui risqueraient de se produire en cas de mise au rebut inappropriée de ce produit. Le recyclage des matériaux contribuera également à économiser les ressources naturelles.



Ce symbole n'est valable que dans l'Union Européenne. Si vous souhaitez mettre ce produit au rebut, veuillez prendre contact avec les autorités locales ou avec votre revendeur et renseignez-vous sur la méthode de mise au rebut correcte.

Italiano

- Smaltimento delle attrezzature elettriche ed elettroniche usate (applicabile in tutta la Comunità Europea ed altri Paesi Europei che applicano programmi di raccolta differenziata)

Il simbolo trovato sul prodotto, o sulla sua confezione, indica che il prodotto non può essere trattato come i domestici quando è il momento di smaltirlo. Al contrario, deve essere consegnato ad un centro di raccolta specializzato nel riciclaggio di attrezzature elettriche ed elettroniche. Assicurando che il corretto smaltimento di questo prodotto, si aiuterà a prevenire potenziali conseguenze negative sull'ambiente e sulla salute umana, che possono essere provocate da uno scorretto smaltimento di questa attrezzatura. I materiali riciclati aiuteranno a conservare le risorse naturali.



Questo simbolo è valido solo nell'Unione Europea. Per smaltire questo prodotto, mettersi in contatto con le autorità locali - o con il rivenditore - e chiedere informazioni sul corretto metodo di smaltimento.

Polski

- Usowanie zużytego sprzętu elektrycznego i elektronicznego (Dotyczy krajów Unii Europejskiej i innych krajów europejskich z oddzielnymi programami zbiórki odpadów)

Obecność tego symbolu na produkcie lub na opakowaniu z produktem oznacza, że tego produktu nie można wyrzucić razem z odpadkami domowymi. Należy go przekażać do punktu zbiórki w celu poddania recyklingowi podzespołów elektrycznych i elektronicznych. Usunięcie tego produktu w prawidłowy sposób, pomoże w zabezpieczeniu przed negatywnym wpływem odpadów na środowisko i zdrowie ludzi, powodowanym przez niewłaściwe usowanie produktu. Przetwarzanie materiałów pomaga w zachowaniu zasobów naturalnych.



Ten symbol obowiązuje wyłącznie w krajach Unii Europejskiej. Informacje dotyczące prawidłowej metody usunięcia tego produktu, można uzyskać u władz lokalnych lub u dostawcy.

Suomi

- Vanhjojen sähkö- ja elektroniikkalaitteiden hävittäminen (Soveltuva kaikilla Euroopan unionin alueella, sekä muissa Euroopan maissa, joilla on erilliset keräysohjelmat)

Jos tuotteesta tai sen pakkauksessa on tämä symboli, sitä ei pidä hävittääessä käsitellä tavallisena kotitalousjätteenä, vaan se kuuluu toimittaa sähkö- ja elektroniikkalaitteiden kierrätyspisteeseen. Varmistamalla, että tämä tuote hävitetään asiaankuuluvalla tavalla autat estämään mahdollisia ympäristölle ja ihmisille koltuvia negatiivisia seurauksia, joita sen vääränlainen hävittäminen voi aiheuttaa. Materiaalien kierrättäminen auttaa säilyttämään luonnonvarjoja.



Tämä symboli on voimassa ainoastaan Euroopan unionin alueella. Jos haluat hävittää tämän tuotteen, ota yhteyttä paikallisiin viranomaisiin tai jälleenmyyjään ja tiedustele asiaankuuluvia hävittäistapoja.

Deutsch

- Entsorgung von elektrischen & elektronischen Altgeräten (geltend für die europäische Gemeinschaft und andere europäische Länder mit separaten Sammelprogrammen)

Dieses Symbol, zu finden auf Ihrem Produkt oder dessen Verpackung, macht Sie darauf aufmerksam, dass dieses Produkt bei der Entsorgung nicht als Hausmüll behandelt werden darf. Statt dessen sollte es an eine Sammelstelle zum Recycling von elektrischen und elektronischen Altgeräten gegeben werden. Helfen Sie mit, potenziell schädliche Einflüsse auf Umwelt und Gesundheit, die durch eine unsachgemäße Entsorgung dieses Produktes entstehen können, zu vermeiden und entsorgen Sie dieses Produkt ordnungsgemäß. Recycling hilft, natürliche Rohstoffe einzusparen.



Dieses Symbol ist nur innerhalb der europäischen Gemeinschaft gültig. Wenn Sie dieses Produkt entsorgen möchten, wenden Sie sich bitte an Ihre örtliche Behörde und fragen Sie nach der ordnungsgemäßen Entsorgungsmethode.

Nederlands

- Verwijderen van oude elektrische en elektronische apparatuur (toepasbaar in de volledige Europese Unie en andere Europese landen met afzonderlijke programma's voor afvalverzameling)

Dit symbool dat op het product of zijn verpakking is aangebracht, geeft aan dat dit product niet mag worden behandeld als huishoudelijk afval als u het wilt wegwerpen. U moet het afgeven bij een specifiek verzamelpunt voor de recyclage van elektrische en elektronische apparatuur. Door te garanderen dat u dit product op de correcte manier wegwerpt, helpt u potentiële negatieve gevolgen voor het milieu en de menselijke gezondheid, die zouden kunnen worden veroorzaakt door een onrechtmatig wegwerpen van het product, te voorkomen. De recyclage van materialen helpt het behoud van natuurlijke bronnen.



Dit symbool is alleen geldig in de Europese Unie. Als u dit product wenst weg te gooien, dient u contact op te nemen met uw lokale instanties voor details over de gepaste methode voor afvalverwijdering.

Waste Electrical and Electronic Equipment (WEEE) Directive In the European Union, this label indicates that this product should not be disposed of with household waste. It should be deposited at an appropriate facility to enable recovery and recycling. EEE complies with Directive 'Regulation on the Restriction of the Use of Certain Hazardous Substances in Electrical and Electronic Equipment'



Waste Electrical and Electronic Equipment (WEEE) Directive In the European Union, this label indicates that this product should not be disposed of with household waste. It should be deposited at an appropriate facility to enable recovery and recycling. EEE complies with Directive 'Regulation on the Restriction of the Use of Certain Hazardous Substances in Electrical and Electronic Equipment'

Waste Electrical and Electronic Equipment (WEEE) Yönergeleri Avrupa Birliği'nde bu etiket, ürünün ev elektroniği aletleri atıkları ile imha edilemeyeceğini gösterir. Kurtarmak ve geri dönüşümünü sağlamak için uygun şartlarda saklanması gerekir. EEE Yönetmeliğine Uygunluk Ve Elektronik Eşyalarda Bazı Zararlı Maddelerin Kullanımın Sinirlendirilmesine Dair Yönetmelik.



Waste Electrical and Electronic Equipment (WEEE) Yönergeleri Avrupa Birliği'nde bu etiket, ürünün ev elektroniği aletleri atıkları ile imha edilemeyeceğini gösterir. Kurtarmak ve geri dönüşümünü sağlamak için uygun şartlarda saklanması gerekir. EEE Yönetmeliğine Uygunluk Ve Elektronik Eşyalarda Bazı Zararlı Maddelerin Kullanımın Sinirlendirilmesine Dair Yönetmelik.

Normal Usage Guidelines

Normal use of the LCD is defined as operating in the open air to prevent heat buildup, and without direct or indirect heat sources such as lighting fixtures, heating ducts, or direct sunlight that can cause the modules to experience high operating temperatures. For all modules, do not block fans or ventilation openings. If the LCD module will be installed in a recessed area with an LCD surround or enclosure, ensure adequate openings are applied for proper air flow and ventilation.

At 3000 meters or below, the maximum ambient operating temperature for the LCD module cannot be above 40° C nor below the minimum ambient operating temperature of 0° C. If one of these conditions exists, it is up to the installer to ensure that module placement is changed, thermal shielding is provided and/or additional ventilation is provided to keep the display within its nominal operating parameters.

Cooling Requirements

For optimal performance, active cooling by the installer should be planned for when the ambient temperature at the top of the wall is predicted to be above the specified ambient temperature for the panel. Cooling may be done behind the displays and depending on the wall configuration, it may be helpful to place air ducts (AC) at every third display tall.

VESA Mounts, General Description

VESA mounts are used to secure the Planar EP-Series for display. The display can be installed using a variety of VESA mounts available through Planar. If you do not have a VESA mount and would like to purchase one, contact Planar.

If you purchased a VESA mount, you should have received a separate box with mounting supplies and an Installation manual. Follow these instructions carefully.

Keep in mind the following general installation guidelines:

- Screw length is crucial and will vary depending on the type of mount you use. Total screw length will include the penetration length plus the length required by the type of VESA mount in use.
- Mount spacers may be required to accommodate the protruding back panel of the OPS slot.

Caution: Shorter screws will result in insufficient mounting strength and longer screws could puncture parts inside the display.

- Prior to installation, make sure you know where all of the mounting points are located.
- Follow all safety precautions outlined in the VESA Installation manual.
- Verify the parts received with the list shown in the VESA Installation manual.

Cleaning the Display

If dust has collected on the power plug, remove the plug from the outlet and clean off the dust. Dust build-up may cause a fire.

Remove the power plug before cleaning. Failure to do so may result in electrical shock or damage.

Keep the following points in mind when cleaning the surface of the display:

- When the surface of the display becomes dirty, wipe the surface lightly with a soft clean cloth.
- If the surface requires additional cleaning, use LCD screen cleaner or LCD wipes, which are available at most electronics stores.
- Do not let cleaner seep into the display, as it may cause electrical shock or damage.

Package Contents

Unpacking the Display

The display is packed in a cardboard box using foam to protect it during shipping.

Before unpacking the display, prepare a stable, level and clean surface near a wall outlet.

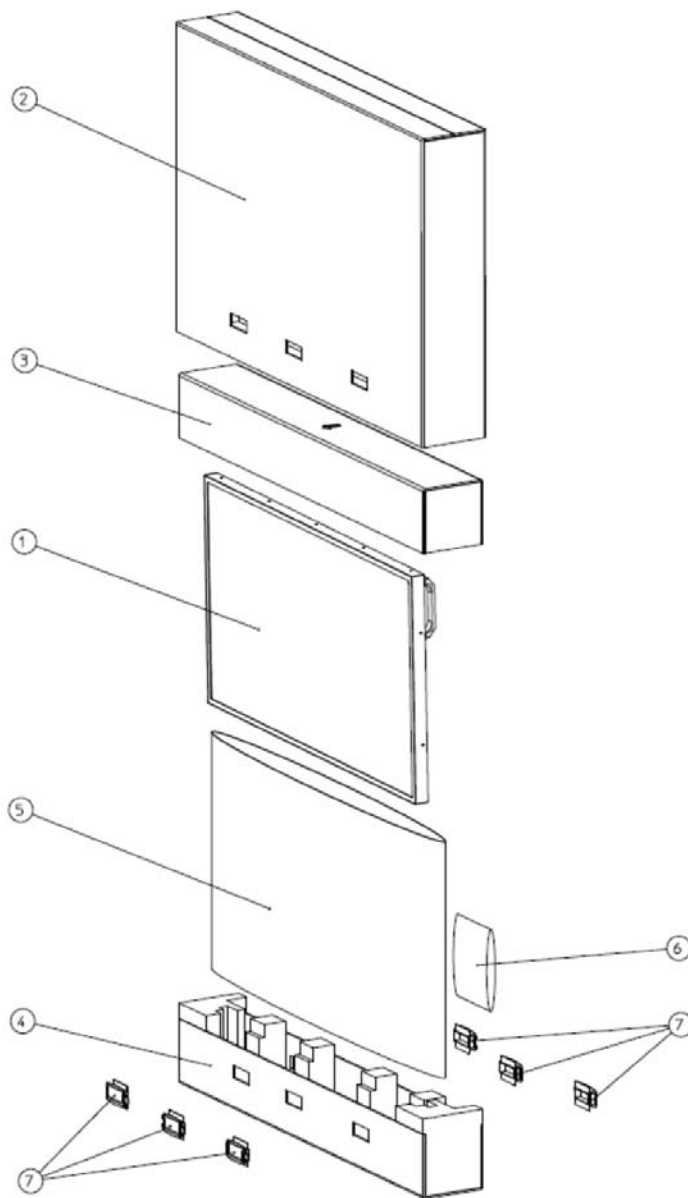

- 1** Place the LCD panel box in an upright position and remove the carton locks from the bottom first.
- 2** Remove the entire top of the box and the top shipping foam.
- 3** Remove the accessory bag and packing list.



Item	Description	Quantity
1	LCD panel	1
2	Carton	1
3	Foam Cushion Top	1
4	Foam Cushion Bottom	1
5	Polyurethane Bag	1
6	Accessory Bag	1
7	Carton Lock	6

Contents of the Accessory Kit

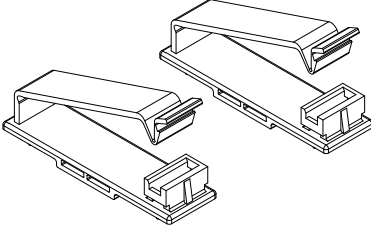
Part	Picture	Quantity
HDMI Cable		1
USB Drive		1
USB Cable (For Touch version)		1
Power cord		1
IR extender cable		1

Part	Picture	Quantity
Cable Clips		2
OSD Remote (AAA batteries included)		1

Installing the Cable Clips

The cable clips included in the Accessory Kit are used to assist with cable management. These clips snap into place as shown in the image below.

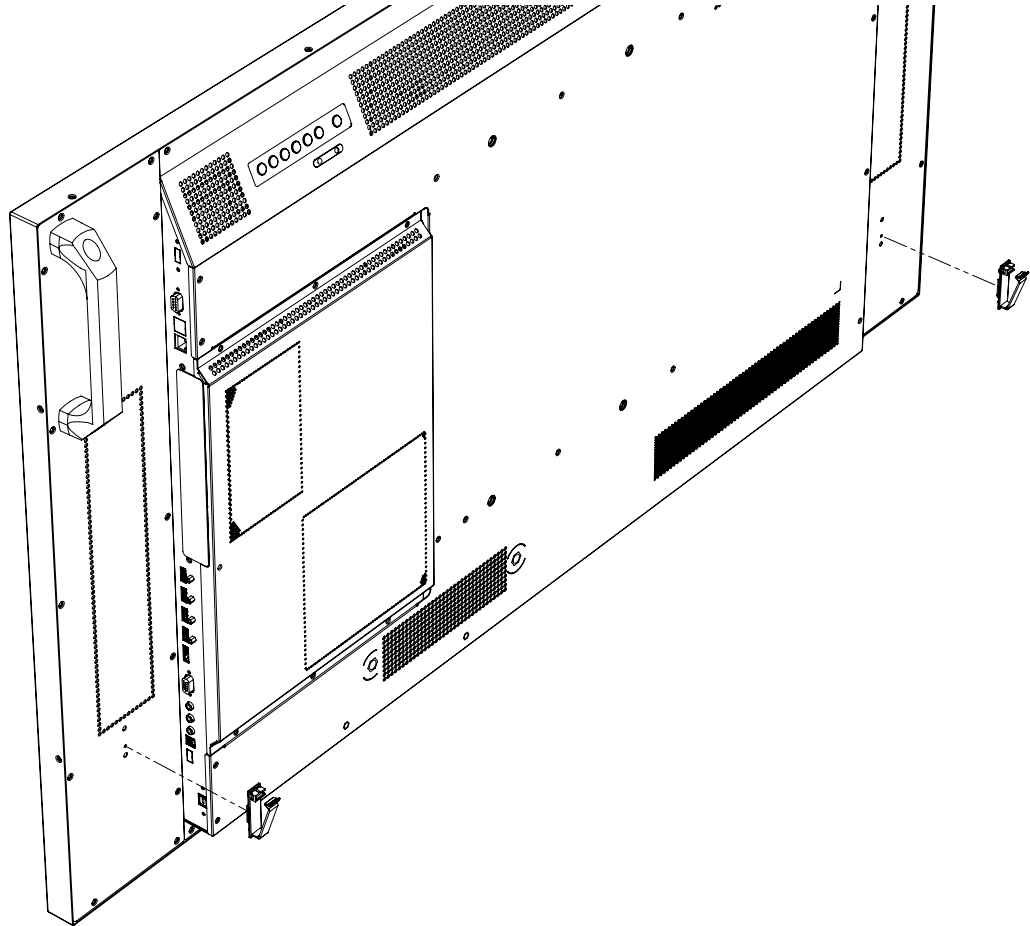

Dimensions

EP5814K

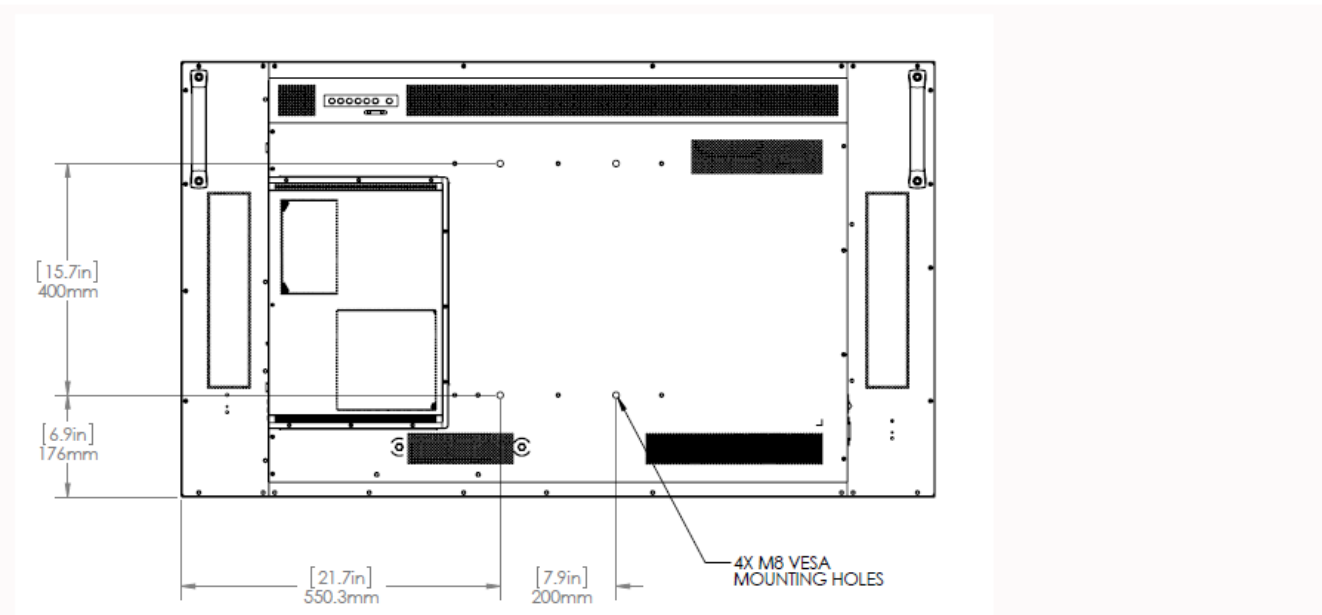
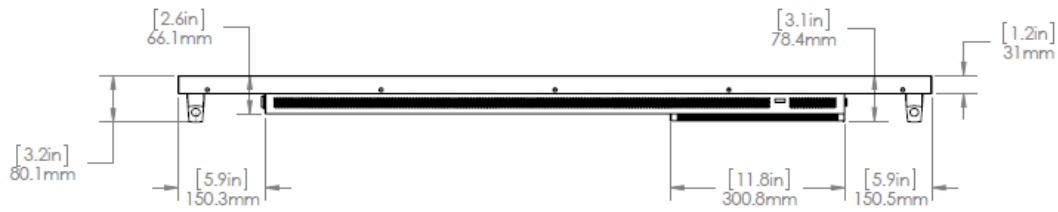
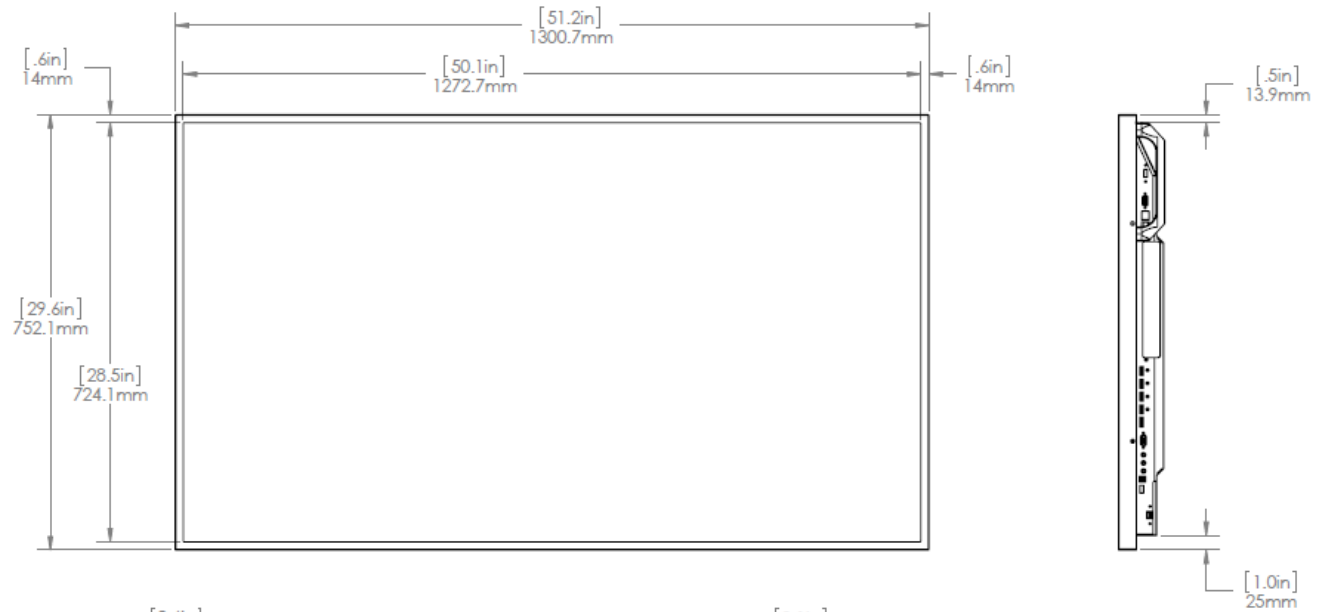

EP5814K-T

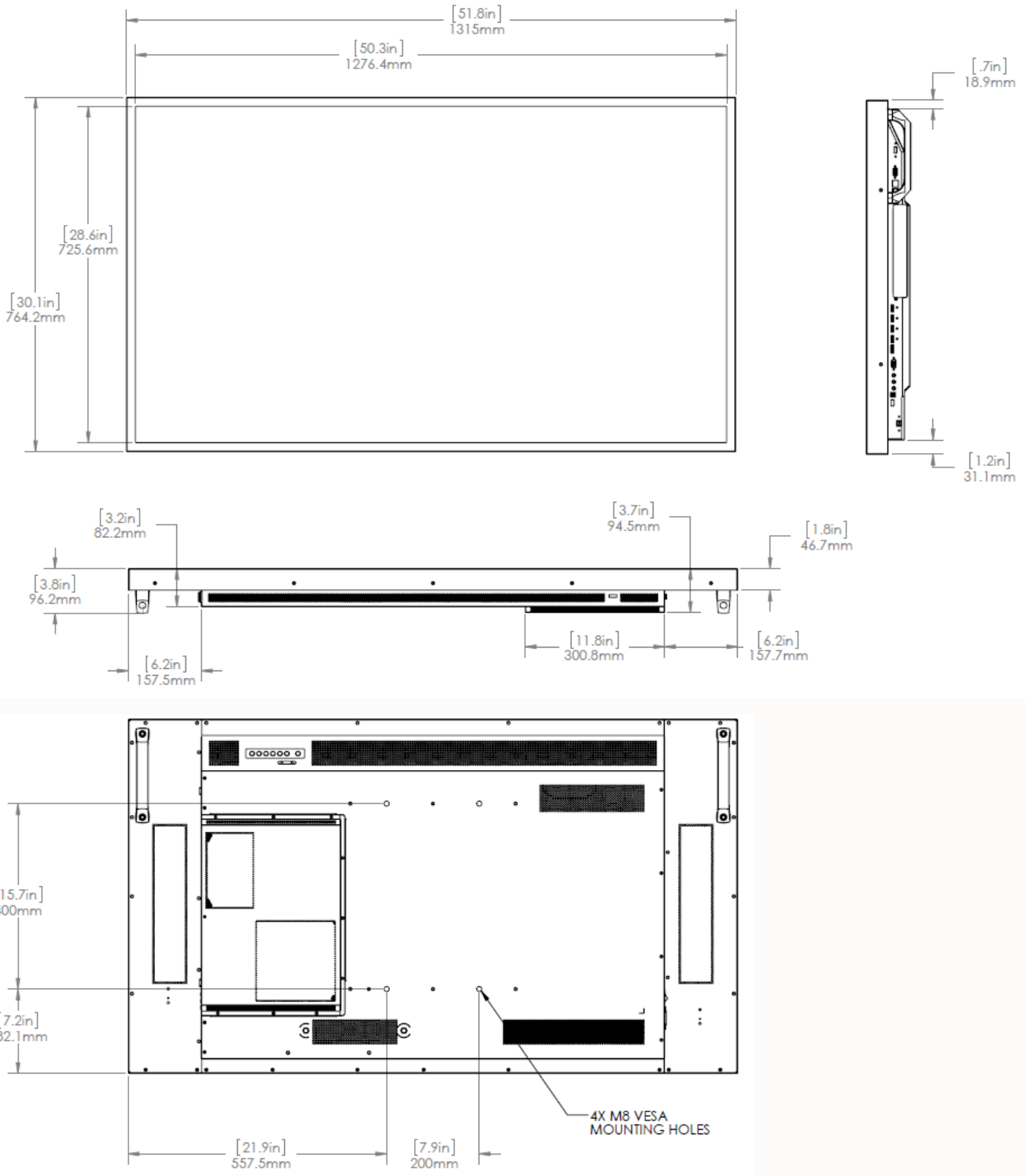

Planar EP Series - Standard Inputs

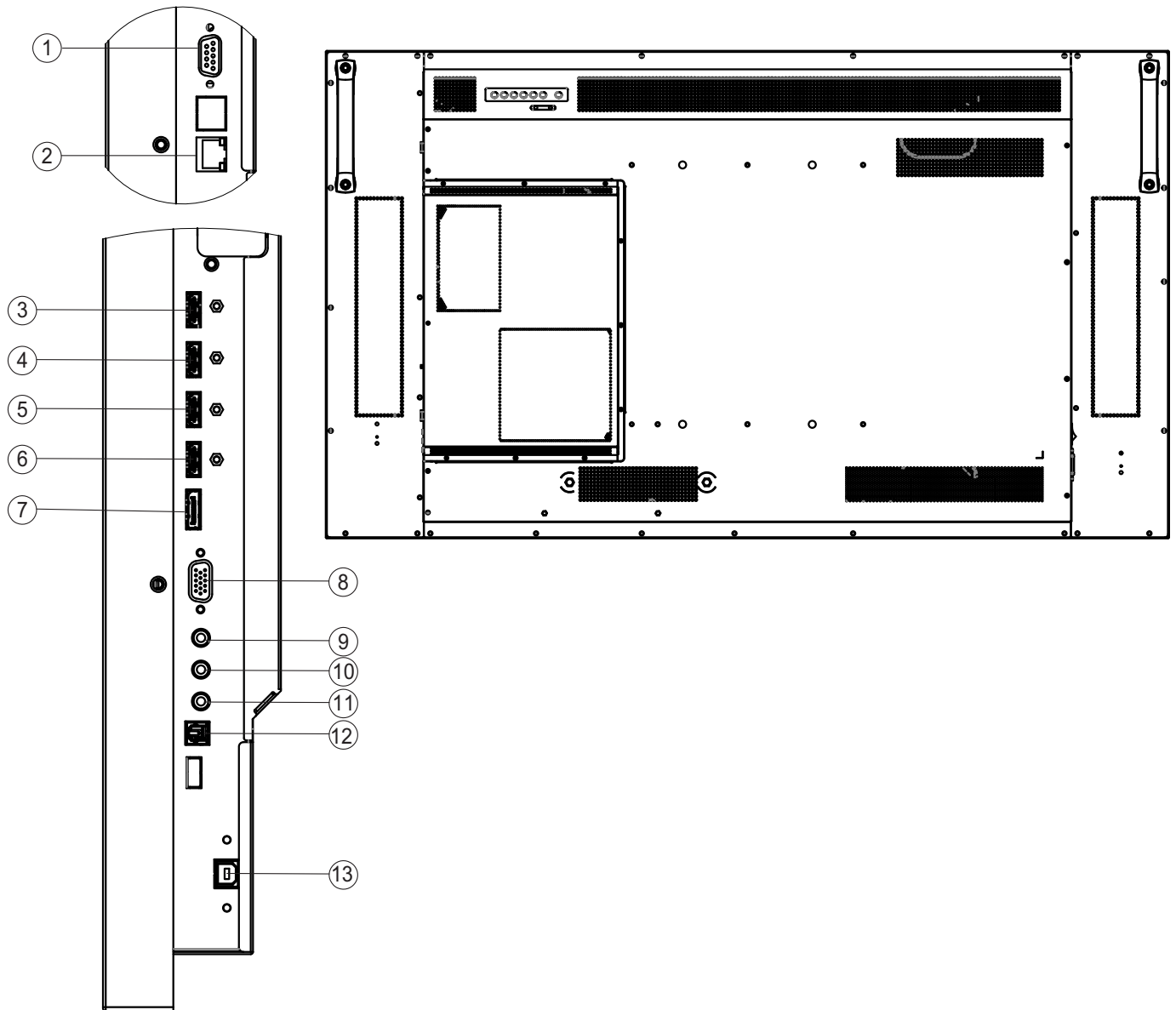

1	RS-232	8	VGA
2	LAN	9	PC Audio In
3	HDMI 1	10	IR Extender
4	HDMI 2	11	PC Audio Out
5	HDMI 3	12	S/PDIF Out
6	HDMI 4	13	Touch USB (for Touch version)
7	DisplayPort		

Installing the Display

This section explains how to install your display. We suggest that you read the entire section before you attempt to install the unit.

Before You Begin

Make sure you have all the items in these lists before you begin unpacking and installing your display(s).

Tools/Equipment List

Depending on your installation, you may need one or more of the following items:

- String/string level
- Digital/laser level
- Ladders/lift
- Back brace
- Stud finder (if hanging display on a wall)

Other Things You May Need

- LCD screen cleaner or LCD wipes - available at most electronics stores
- At least two very strong people to help lift units into place

Plan Your Installation

You should have a detailed plan of how the units are to be configured. The plan should include calculations for the following:

- Power (maximum of five units per 20A circuit for 115V operation)
- Cable runs
- Ventilation and cooling requirements
- If hanging display on a wall, location of studs in the wall

Prepare Your Installation Location

You should have prepared the area where you will install the unit. If custom enclosures are part of the installation, they must be fully designed to accommodate the installation of the displays, as well as the installed unit and ventilation and cooling requirements.

If your installation included a lot of construction or dust, it is **highly recommended** that you clean all of the screens after the wall installation and configuration are complete.

Cable Length Recommendations

Cable length performance may vary between different cables and sources. The recommended maximum DisplayPort length is 3m for DisplayPort 1.2 and 5m for DisplayPort 1.1. HDMI cable length is recommended for up to 15m.

Installing OPS Expansion (Optional)

The Planar EP-Series displays are equipped with an expansion slot that supports the Intel® Open-Pluggable Specification (OPS). The slot will support OPS devices such as PC's, SDI modules, HDBaseT receivers, etc.

To install an OPS device, remove the protective cover on the display and slide the device firmly into position. When installed, the OPS device will be connected internally to the display. No external video or power cables are required.

For convenience, two Type-A USB 2.0 ports and one Type-A USB 3.0 port are provided on the rear cover of the display. When an OPS device is installed, these USB ports can be used for a keyboard, webcam, USB drive, or other peripherals.

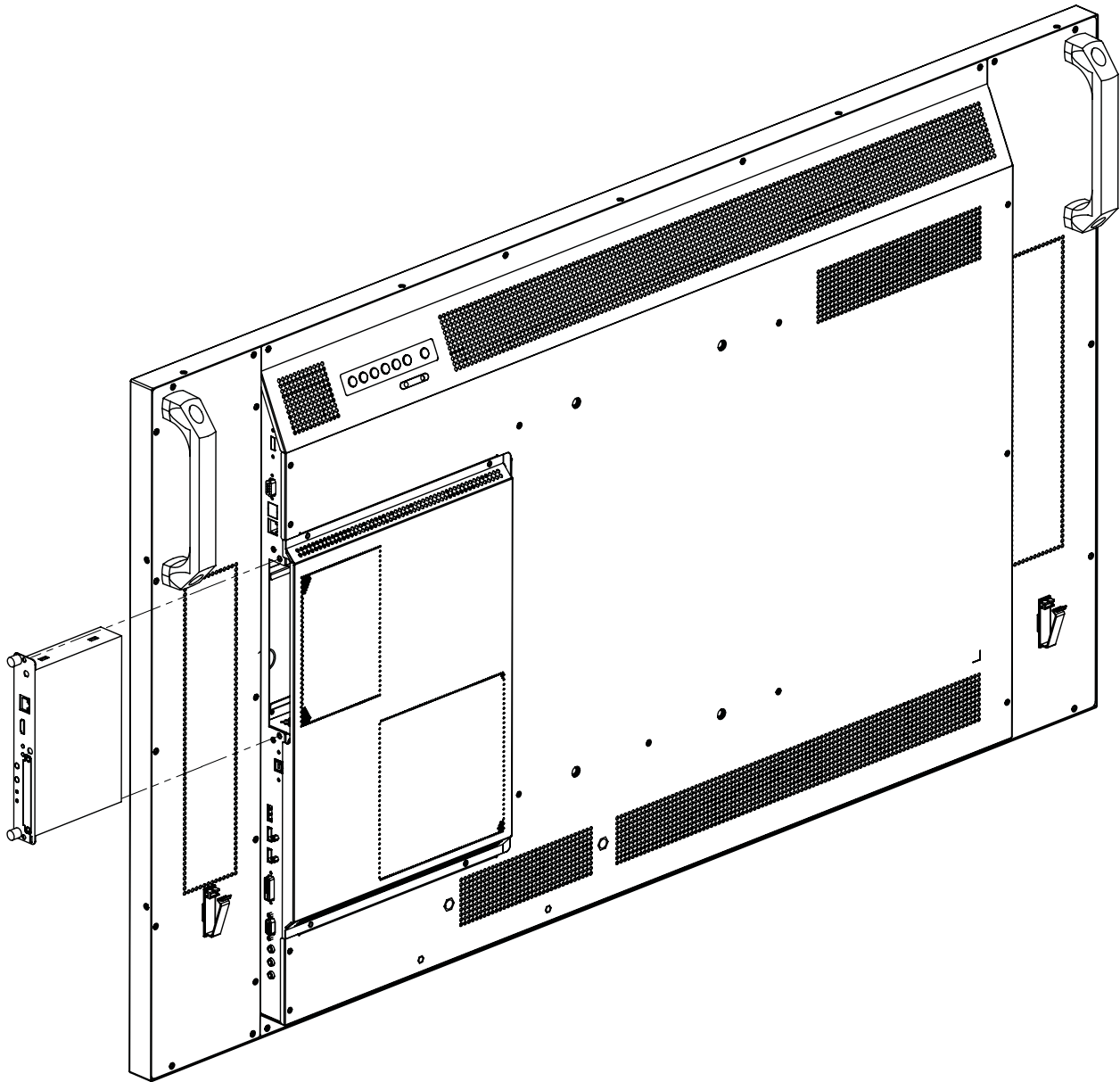

Operating the Display

OSD Keypad

The OSD keypad is located on the rear of the display.

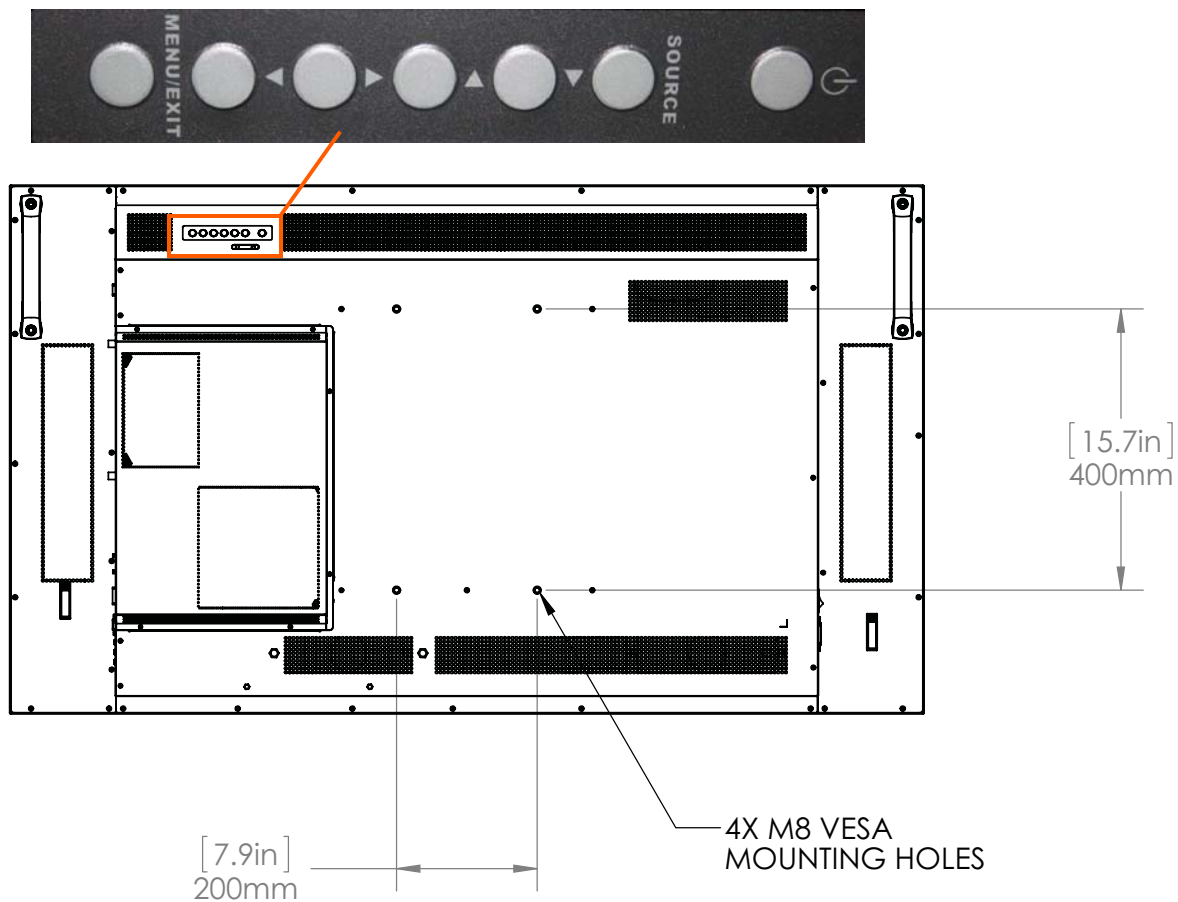

OSD Keypad Buttons

Key	Descriptions
Power	Power on/Power off
Source	Source selection (toggle)
▶	Menu Right/Increase value
◀	Menu Left/Decrease value
▲	Menu Up
▼	Menu Down
Menu/Exit	Menu/Exit

Remote Control Receiver

The remote control receiver is located near the keypad on the rear of the display. Use the IR extender cable for operating the remote from the front of the display.

Power ON standby indicator,
Remote control receiver

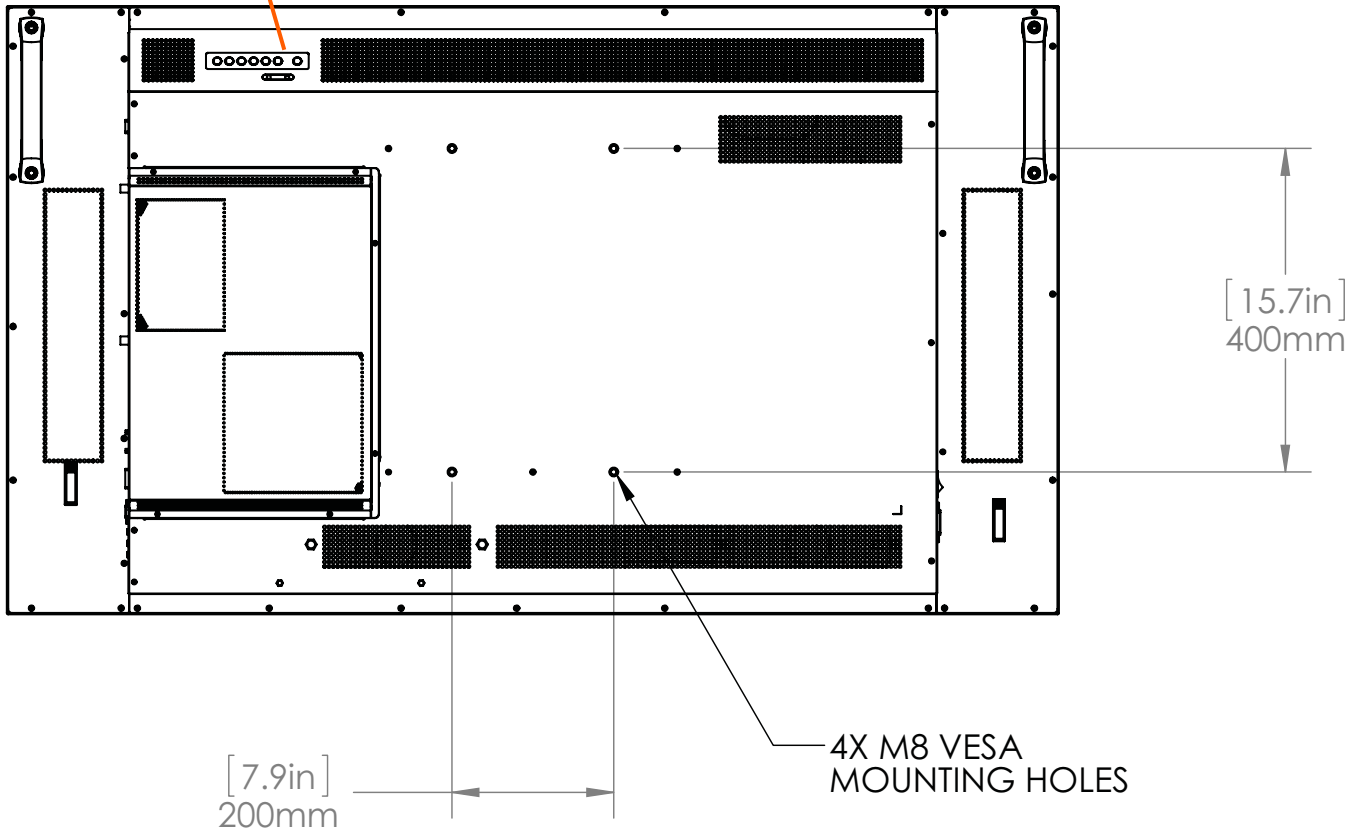

LED Indicators

The LED indicator light is located on the rear of the display near the keypad. The following table explains what the different colors and blink patterns mean.

LED On

Power Status	Condition
Green	Power on
Blinking Orange	No signal
Orange	Power saving mode
Off	AC off
Off	Power off

Using the Display in Portrait Mode

When using the display in the portrait position and looking at the rear of the display, it should be rotated according to the arrow stickers on the back of the display. This will allow for proper ventilation. Then select the OSD rotation of landscape or portrait on the OSD menu (MAIN MENU > OSD SETTINGS > OSD ROTATION).

Caution: Improper ventilation may shorten the life of the display.





Using the Display in Flat or Tilted Orientation

The display is not recommended for use in flat orientation for tabletop, floor, or ceiling installations. LCD panels of this size are at risk of panel deflection, which can cause cosmetic sagging, brightness uniformity issues, a shortened life span, and malfunction of optional touch sensors. Installations where the display is tilted downward or upward at an angle may also be prone to these issues and are not recommended.

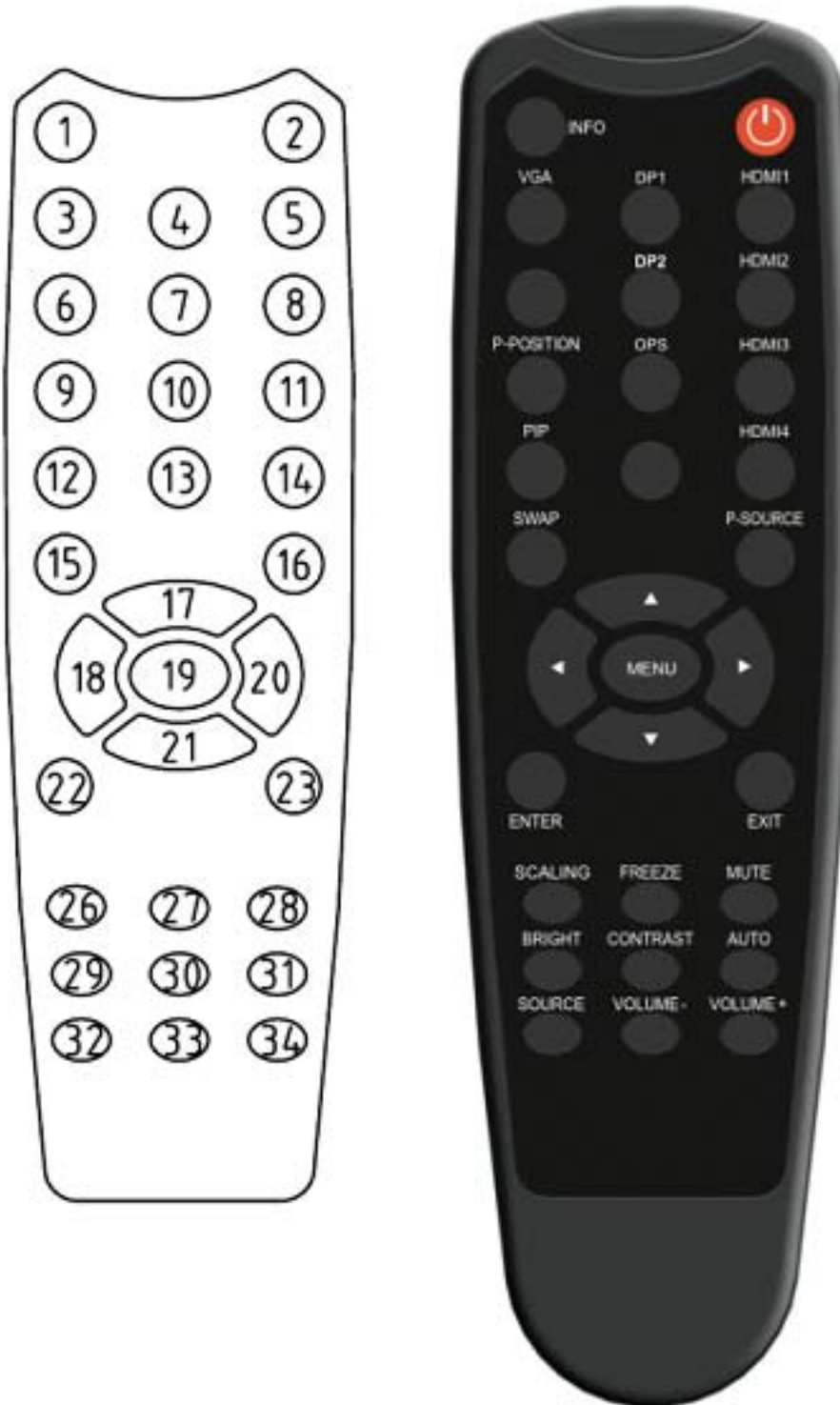
Using the Remote Control

Below is a picture of the remote control and its corresponding Hex codes. See the following page for button descriptions and Hex codes.



Num	Function	Customer Code	Hex Code	Description
1	INFO	40AF	04FB	Provides source and resolution information
2		40AF	1CE3	Turns the display on and off
3	VGA	40AF	07F8	Selects the PC's VGA source
4	DP1	40AF	08F7	Selects the DisplayPort 1 source
5	HDMI1	40AF	09F6	Selects the HDMI source 1
6				Not used
7				Not used
8	HDMI2	40AF	0CF3	Selects the HDMI source 2
9	P-position	40AF	1AE5	Selects the PiP (Picture-in-Picture) position
10	OPS	40AF	15EA	Selects the OPS source
11	HDMI3	40AF	10EF	Selects the HDMI source 3
12	PIP	40AF	11EE	Selects the Multi-Source View
13				Not used
14	HDMI4	40AF	16E9	Selects the HDMI source 4
15	SWAP	40AF	06F9	Swaps the main input source with source 2
16	P-SOURCE	40AF	13EC	Selects the PiP (Picture-in-Picture) source
17		40AF	02FD	Navigates up through submenus and settings
18		40AF	01FE	Navigates back through submenus and settings
19	MENU	40AF	0EF1	Opens the display's on-screen menu system. When the menu system is already open, pressing this button will select the previous submenu.
20		40AF	03FC	Navigates forward through submenus and settings

Num	Function	Customer Code	Hex Code	Description
21	▼	40AF	19E6	Navigates down through submenus and settings
22	ENTER	40AF	12ED	Selects highlighted menu choices
23	EXIT	40AF	05FA	Closes the menu system
26	SCALING	40AF	14EB	Toggles between different aspect ratios (Auto, Native, 4 x 3, 16 x 9, 16 x 10 and Letterbox)
27	FREEZE	40AF	43BC	Freezes the current source image
28	MUTE	40AF	00FF	Turns off the sound
29	BRIGHT	40AF	17E8	Adjusts the brightness
30	CONTRAST	40AF	18E7	Adjusts the contrast
31	AUTO	40AF	1EE1	Synchronizes the display to the source
32	SOURCE	40AF	0FF0	Allows selection of the different sources
33	VOLUME -	40AF	1BE4	Decreases the sound volume
34	VOLUME +	40AF	1DE2	Increases the sound volume

Locking/Unlocking the OSD Menus

You can lock or unlock the OSD menus by pressing a series of key commands on the remote control. To **lock** the menu, press the following keys on the remote in the order listed: ENTER, ENTER, EXIT, EXIT, ENTER and EXIT. To **unlock** it, simply follow the same sequence.

Depending on whether you locked or unlocked the menu, you will see one of the following messages on the screen.



Changing the Remote Control Battery

- 1 Remove the battery cover.**
Slide back and remove the battery cover in the direction of the arrow.

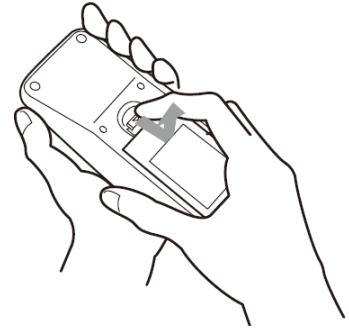

- 2 Insert the batteries.**
Align and insert two AAA batteries according to their plus and minus ports (as indicated in the remote control).

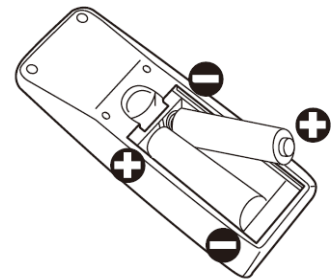

- 3 Close the battery cover.**
Replace the battery cover in the direction of the arrow and snap it back into place.

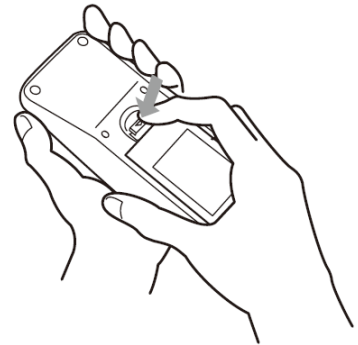

Turning the Display On

- 1** Insert the power cord into the display and into the power outlet.
- 2** Ensure the AC switch is set to “—”.
- 3** Press the power button on the remote or side control panel.

Turning the Display Off

With the power on, press the power button on the remote or side control panel to put the LCD panel in a standby mode. To turn off power completely, turn the AC switch to “O” or disconnect the AC power cord from the power outlet.

Note: If there is no signal for a certain period of time, the LCD panel will automatically go into standby mode.

Adjusting the Volume

- 1 Using the remote, press the VOLUME - or VOLUME + to increase or decrease the volume.
- 2 Press the MUTE button to temporarily turn off all sound. To restore the sound, press the MUTE button again.

Note: The analog audio out is variable. S/PDIF is fixed.

Selecting the Input Source

Do one of the following:

- Using the remote, press the desired source button (DP1, HDMI1, HDMI2, HDMI3, HDMI4, VGA).
- Press the source button on the display’s keypad. Use the arrow buttons (▲ ▼) to select one of the following input sources and press ENTER: DISPLAYPORT1, HDMI1, HDMI2, HDMI3, HDMI4, VGA.

Note: When the display cannot find a source, a “No signal” message will appear.

Navigating Through the Menus

- 1 With the power on, press MENU. The INPUT menu appears.
- 2 Within the menu, use ▲, ▼, ◀, ▶ and ENTER to navigate through the menus and adjust options.
- 3 Press MENU to return to the previous menu. To exit the menu system, press EXIT.

Input Menu

This menu is used for selecting the input sources. Up to four sources can be displayed at the same time.

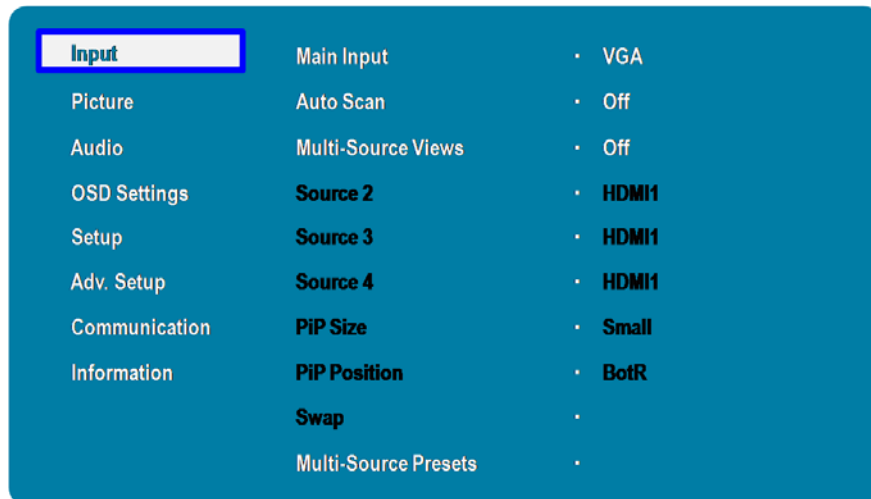

Main Input

Select the Main Input source

Options: DisplayPort1, HDMI1, HDMI2, HDMI3, HDMI4, VGA, OPS

Auto Scan

Select whether the display will automatically scan for a Main Input source

Options: On, Off; **Default:** Off

Multi-Source Views

Select the Multi-Source View mode

Options: Off, PiP, Dual View, Dual View Portrait, Triple View, Quad View

Default: Off

Source 2

Select the second source

Options: DisplayPort1, HDMI1, HDMI2, HDMI3, HDMI4, VGA, OPS

Note: This function is only available when Multi-Source Views is set to PiP, Dual View, Dual View Portrait, Triple View or Quad View. If HDMI1 was selected as another source, OPS cannot be selected. If OPS was selected as another source, HDMI1 cannot be selected.

Source 3

Select the third source

Options: DisplayPort1, HDMI1, HDMI2, HDMI3, HDMI4, VGA, OPS

Note: This function is only available when Multi-Source Views is set to Triple View or Quad View. If HDMI1 was selected as another source, OPS cannot be selected. If OPS was selected as another source, HDMI1 cannot be selected.

Source 4

Select the fourth source

Options: DisplayPort1, HDMI1, HDMI2, HDMI3, HDMI4, VGA, OPS

Note: This function is only available when Multi-Source Views is set to Quad View. If HDMI1 was selected as another source, OPS cannot be selected. If OPS was selected as another source, HDMI1 cannot be selected.

PIP Size

Select the size of the PiP (Picture-in-Picture)

Options: Small, Mid, Large

Note: This function is only available when Multi-Source Views is set to PiP

PIP Position

Set the position of the PiP (Picture-in-Picture)

Options: TopR (Top Right), TopL (Top Left), BotR (Bottom Right), BotL (Bottom Left)

Note: This function is only available when Multi-Source Views is set to PiP

Swap

Swap the Main Input source with Source 2

Note: This function is only available when Multi-Source Views is set to PiP, Dual View, or Dual View Portrait

Multi-Source Presets

Save or Recall Multi-Source Preset1, Preset2, Preset3 or Preset4

Note: See page 29 for more information.

Multi-Source Presets Submenu

Save and recall up to four configurations of single or multi-source layouts. Source selection and location are saved within each preset.

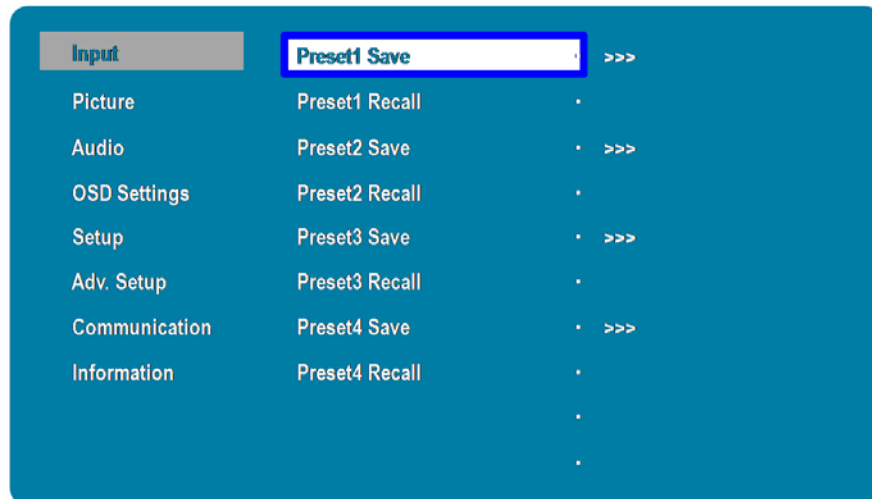

Saving Configurations

- 1 Set up the single or multi-source layout as desired.
- 2 Select PRESET1 SAVE, PRESET2 SAVE, PRESET3 SAVE, or PRESET4 SAVE to assign the configuration to one of the preset slots.

Recalling Stored Configurations

- 1 Select PRESET1 RECALL, PRESET2 RECALL, PRESET3 RECALL, or PRESET4 RECALL in the on screen menu to recall the desired saved configuration. Presets can be also be recalled from RS-232.

Note: Presets can be overridden but cannot be deleted.

Picture Menu

This menu is used for making common image adjustments.

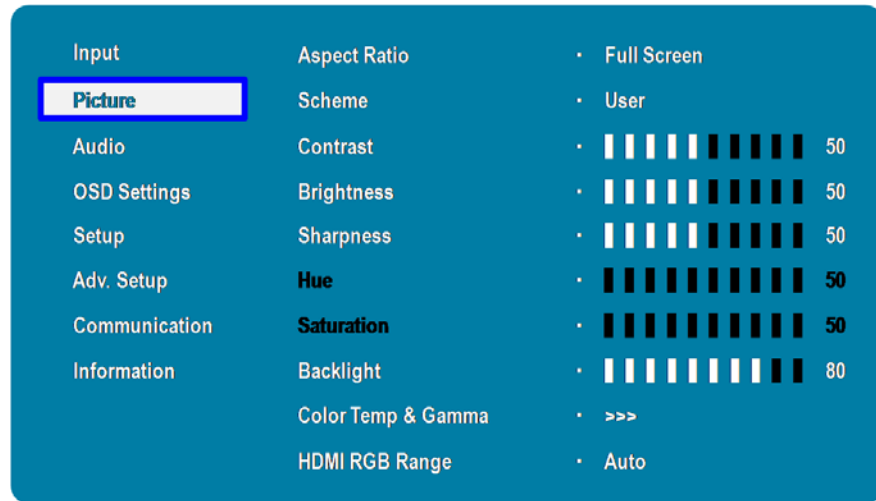

Aspect Ratio

Adjust the aspect ratio of the screen. The first selection is for the main source, and the second selection is for sources 2-4.

Options: Full Screen, Letterbox, 4:3, 1:1; **Default:** Full Screen

Scheme

Press ◀ or ▶ to select one of the following:

Options: User, Vivid, Cinema, Game, Sport; **Default:** User

Contrast

Increase or decrease the contrast of picture. Press ◀ or ▶ to select the desired level.

Range: 0~100; **Default:** 50

Brightness

Increase or decrease the brightness of picture. Press ◀ or ▶ to select the desired level.

Range: 0~100; **Default:** 50

Sharpness

Adjust the definition of picture. Press ◀ or ▶ to select the desired level.

Range: 0~100; **Default:** 50

Hue

Increase or decrease the green hue. Press ◀ or ▶ to select the desired level.

Range: 0~100; **Default:** 50

Note: This function is not available when displaying PC or graphics sources

Saturation

Adjust the brilliance and brightness. Press ◀ or ▶ to select the desired level.

Range: 0~100; **Default:** 50

Note: This function is not available when displaying PC or graphics sources

Backlight

Increase or decrease the intensity of the LCD backlight. Press ◀ or ▶ to select the desired level.

Range: 0~100; **Default:** 80

Color Temp and Gamma

Select gamma

Options: Off, 1.85, 1.9, 1.95, 2.0, 2.05, 2.10, 2.15, 2.2, 2.25, 2.3, 2.35, 2.4, 2.45, 2.5, 2.55, 2.6

Default: 2.2

Select color temperature

Options: User, 3200K, 5000K, 6500K, 7500K, 9300K; **Default:** 9300K

HDMI RGB Range

Select RGB range for HDMI sources

Options: Auto, Full, Limited; **Default:** Auto

Picture Menu – RGB Adjust Submenu (Color Temp = User)



Red Gain

Set Color Temperature to “User” in order to adjust this setting.

Range: 0~100

Default: 100

Green Gain

Set Color Temperature to “User” in order to adjust this setting.

Range: 0~100

Default: 100

Blue Gain

Set Color Temperature to “User” in order to adjust this setting.

Range: 0~100

Default: 100

Red Offset

Set Color Temperature to “User” in order to adjust this setting.

Range: 0~100

Default: 50

Green Offset

Set Color Temperature to “User” in order to adjust this setting.

Range: 0~100

Default: 50

Blue Offset

Set Color Temperature to “User” in order to adjust this setting.

Range: 0~100

Default: 50

Audio Menu

This menu is used for adjusting audio settings.

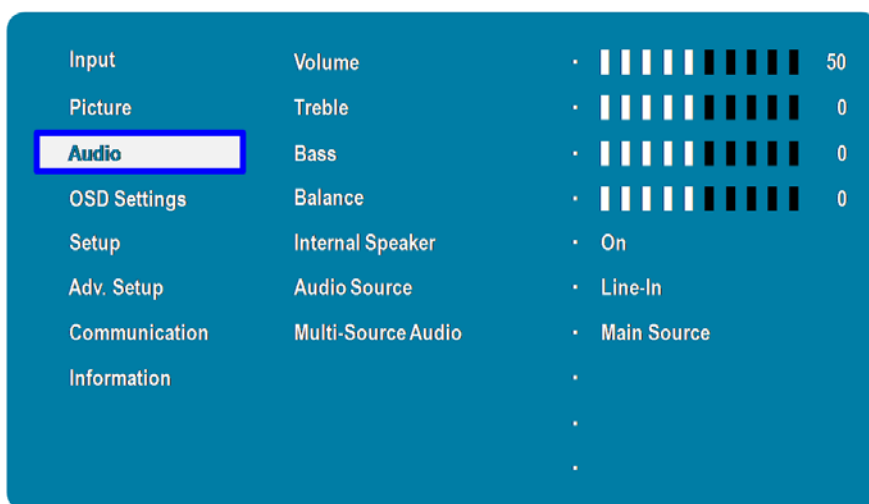

Volume

Adjust the sound. Press ◀ or ▶ to select the desired level.

Range: 0~100

Default: 50

Treble

Adjust the sound in high tones (treble). Press ◀ or ▶ to select the desired level.

Range: -6~+6

Default: 0

Bass

Adjust the sound in low tones (bass). Press ◀ or ▶ to select the desired level.

Range: -6~+6

Default: 0

Balance

Adjust the balance of the left and right speakers. Press ◀ or ▶ to select the desired level.

Range: -6~+6

Default: 0

Internal Speaker

Turn the internal speaker on or off

Default: On

Audio Source

Select the audio source for the Main input

Options: DisplayPort1, HDMI1, HDMI2, HDMI3, HDMI4, Line-In

Multi-Source Audio

Select the audio source that is played through the display's internal speakers, audio out and digital audio out

Options: Main Source, Source 2, Source 3, Source 4

Default: Main Source

Note: Adjustments to the Audio Source setting will override selections made to Multi-Source Audio. Do not change the Audio Source setting if you plan to make audio source selections in Multi-Source Audio.

Off-screen audio sources can be selected from Audio Source.

OSD Settings Menu

This menu is used to make initial setup adjustments to the OSD (On-Screen Display) menu and other on-screen messages.

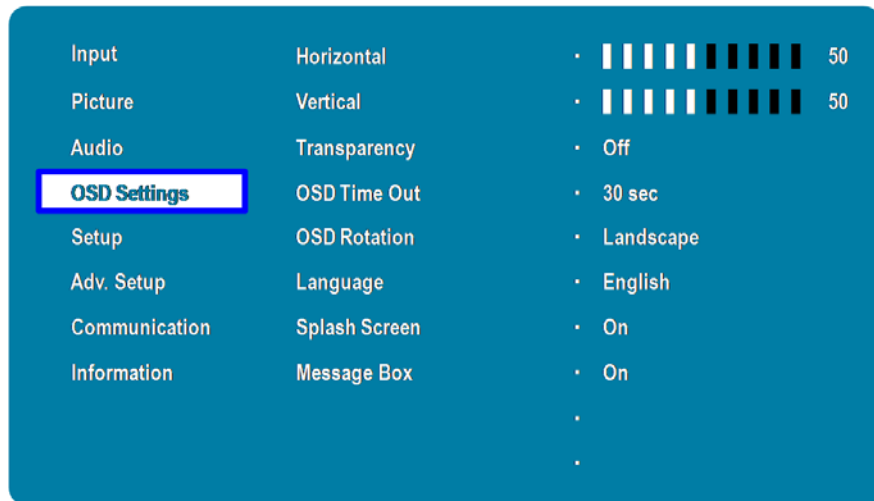

Horizontal

Adjust the horizontal position of the OSD menu. Press ◀ or ▶ to select the desired level.

Range: 0~100

Default: 50

Vertical

Adjust the vertical position of the OSD menu. Press ◀ or ▶ to select the desired level.

Range: 0~100

Default: 50

Transparency

Submenu to adjust the transparency of the OSD menu. Press ◀ or ▶ to select the desired level.

Options: Off, 1, 2, 3, 4

Default: Off

OSD Timeout

Submenu to adjust the time in seconds before the OSD menu disappears. Press ◀ or ▶ to select the desired level.

Options: 5 sec, 10 sec, 20 sec, 30 sec, 60 sec

Default: 30 sec

OSD Rotation

Select the OSD Rotation. Press ◀ ▶ to select the rotation.

Options: Landscape, Portrait

Default: Landscape

Language

Select the OSD language

Splash Screen

Select whether a splash screen appears when the monitor is powered up

Options: On, Off

Default: On

Message Box

Select whether a message box is displayed on screen

Options: On, Off

Default: On

Setup Menu

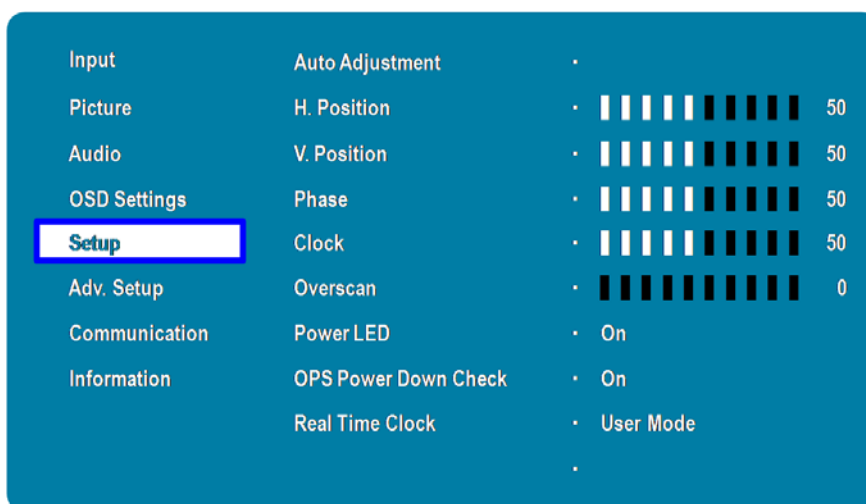

Auto Adjustment

Force the display to reacquire and lock to the input signal (VGA source only). This is useful when the signal quality is marginal. Note: This feature does not continually reacquire the signal.

Options: No, Yes

Default: No

H. Position

Adjust the horizontal position of the image (VGA source only). Press ◀ or ▶ to select the desired level.

Range: 0~100

Default: 50

V. Position

Adjust the vertical position of the image (VGA source only). Press ◀ or ▶ to select the desired level.

Range: 0~100

Default: 50

Phase

Adjust the phase of the displayed signal (VGA source only). Press ◀ or ▶ to select the desired level.

Range: 0~100

Clock

Adjust the clock of the displayed signal (VGA source only). Press ◀ or ▶ to select the desired level.

Range: 0~100

Overscan

Adjust the zoom (overscan) of the image

Default: 0

Power LED

Enable or disable the status LED

Options: On, Off

Default: On

OPS Power Down Check

Allow the display to skip waiting for the OPS module to power down when the display is powering down

Default: On

Real Time Clock

See details on next page

Real Time Clock Submenu

This menu is used to set the internal clock of the display, and to power on and power off the display at preset times if desired.

Current Time			
2015 / 05 / 21		09 : 40 Thursday	
Timer Mode	User Mode		
Week	Enable	Power On	Power Off
Monday	<input type="checkbox"/>	00 : 00	00 : 00
Tuesday	<input type="checkbox"/>	00 : 00	00 : 00
Wednesday	<input type="checkbox"/>	00 : 00	00 : 00
Thursday	<input type="checkbox"/>	00 : 00	00 : 00
Friday	<input type="checkbox"/>	00 : 00	00 : 00
Saturday	<input type="checkbox"/>	00 : 00	00 : 00
Sunday	<input type="checkbox"/>	00 : 00	00 : 00

Current Time

Set the year, month, day, and time of day

Options: User Mode, Workday Mode, Everyday Mode

Real Time Clock – User Mode

Current Time	2015 / 05 / 21 09 : 40 Thursday		
Timer Mode	User Mode		
Week	Enable	Power On	Power Off
Monday	<input type="checkbox"/>	00 : 00	00 : 00
Tuesday	<input type="checkbox"/>	00 : 00	00 : 00
Wednesday	<input type="checkbox"/>	00 : 00	00 : 00
Thursday	<input type="checkbox"/>	00 : 00	00 : 00
Friday	<input type="checkbox"/>	00 : 00	00 : 00
Saturday	<input type="checkbox"/>	00 : 00	00 : 00
Sunday	<input type="checkbox"/>	00 : 00	00 : 00

User Mode

Select the power on/off time for each day of the week

Options: Disable, Enable

Use the arrow keys to specify the on and off times.

Real Time Clock – Workday Mode

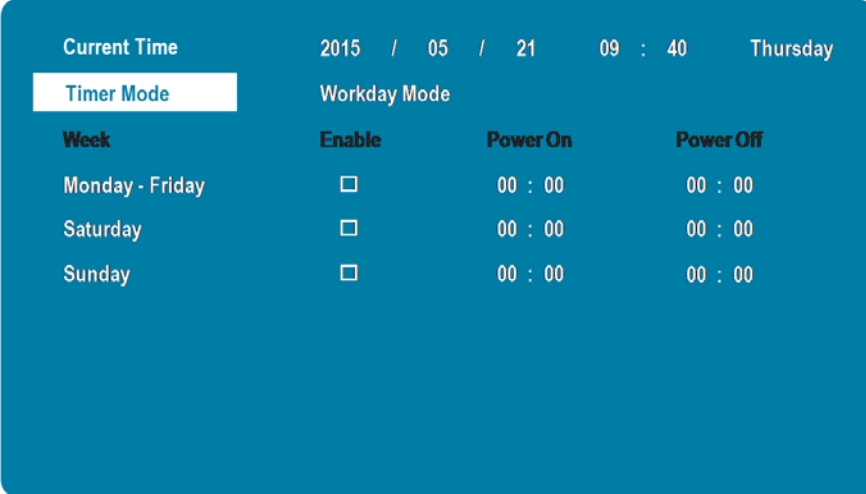

Current Time	2015 / 05 / 21 09 : 40 Thursday		
Timer Mode	Workday Mode		
Week	Enable	Power On	Power Off
Monday - Friday	<input type="checkbox"/>	00 : 00	00 : 00
Saturday	<input type="checkbox"/>	00 : 00	00 : 00
Sunday	<input type="checkbox"/>	00 : 00	00 : 00

Workday Mode

Select the power on/off time for Monday–Friday, Saturday, and Sunday

Options: Disable, Enable

Use the arrow keys to specify the on and off times.

Real Time Clock – Everyday Mode

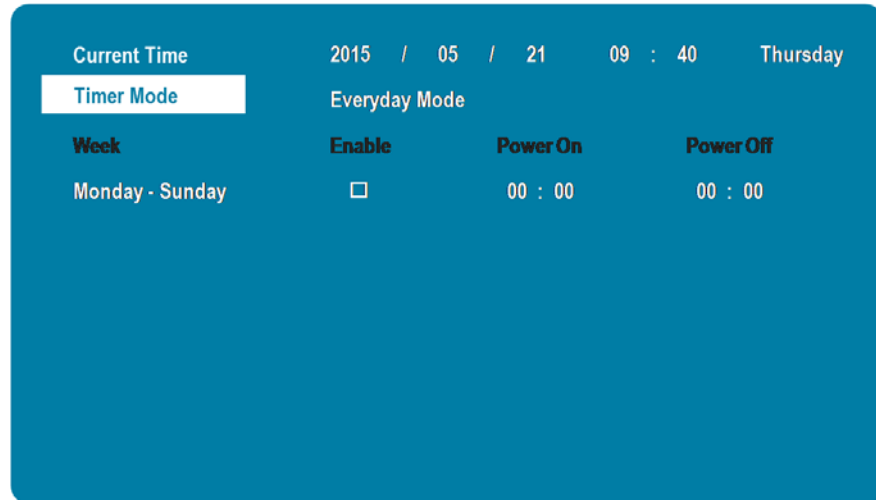

Everyday Mode

Select the power on/off time for all days of the week

Options: Disable, Enable

Use the arrow keys to specify the on and off times.

Advanced Setup Menu

Input	Smart Light Control	• Off
Picture	IRFM	• Off
Audio	MEMC	• Off
OSD Settings	Local Dimming	• Off
Setup	Noise Reduction	• Off
Adv. Setup	Power Saving Config	• Wake On VGA
Communication	DP Ver.	• 1.2
Information	EDID Setup	• HDMI 4K2K DP 4K2K
	Touch Control	• Auto
	Factory Reset	• No

Smart Light Control

Enable dynamic contrast (DCR) or ambient light sensor

Options: Off, DCR, Light Sensor

Default: Off

IRFM

Create slight frame motion to help avoid image retention

Options: On, Off

Default: Off

MEMC

Enable motion estimation motion compensation (frame interpolation). This improves smoothness for fast motion video content.

Options: Off, Low, Medium, High

Default: Off

Local Dimming

Enable local dimming of the LCD backlight. This improves black levels and contrast; however for some content it may introduce artifacts.

Options: On, Off

Default: Off

Noise Reduction

Reduce random noise in the video content

Options: Off, Low, Medium, High

Default: Off

Power Saving Config

Options: Wake on VGA, Wake on All, Always On

Default: Wake on VGA

Note: For Wake on VGA and Wake on All, the display will enter power saving mode if no signal is received for 5 minutes.

DP Ver.

Select DisplayPort version of the DisplayPort inputs

Options: 1.1, 1.2

Default: 1.2

Note: DisplayPort 1.2 is the more modern standard and supports 3840x2160 @ 60 Hz resolution. However, sometimes DisplayPort 1.1 is needed for compatibility with older graphics cards.

EDID Setup

Select EDID (Extended Display Identification Data) of the HDMI and DisplayPort inputs

Options: 4K2K, 1080p

Default: 4K2K

Note: Use the 1080p setting for the broadest support of lower resolution sources. Use the 4K2K setting to support high resolution sources such as 3840x2160.

Touch Control

Select whether the touchscreen controls the internal OPS PC, or controls an external PC via the Touch USB connector

Options: Auto, OPS, External

Default: Auto

Factory Reset

Restore all settings to their default

Options: No, Yes

Default: No

Communication Menu

This menu configures the display's RS-232 and Ethernet communication ports.

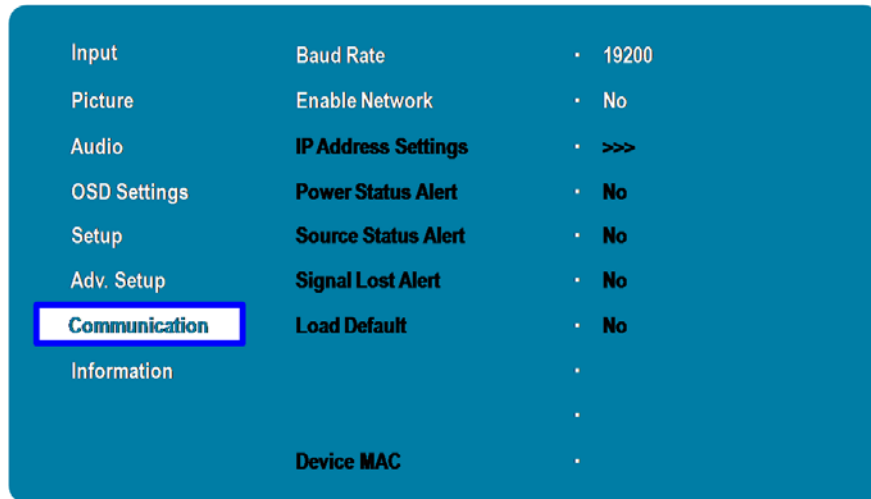

Baudrate

Select the baud rate of the display's RS-232 port

Options: 115200, 38400, 19200, 9600

Default: 19200

Enable Network

Enable the display's built-in Ethernet port

Options: No, Yes

Default: No

IP Address Settings

Enable Dynamic IP mode or set the static IP address of the display's Ethernet port

Power Status Alert

Enable an automatic alert when the display is powered down

Options: No, Yes

Default: No

Source Status Alert

Enable an automatic alert when the source is changed

Options: No, Yes

Default: No

Signal Lost Alert

Enable an automatic alert when the video signal is lost

Options: No, Yes

Default: No

Load Default

Load default communication settings

Options: No, Yes

Default: No

Device MAC

Shows the MAC address of the display

Assigning an IP Address to the Display

To assign an IP address to your display, access the IP Address Settings Menu in the **Communication** menu. Consult your system administrator if you do not know how to configure the parameters shown in the menu.

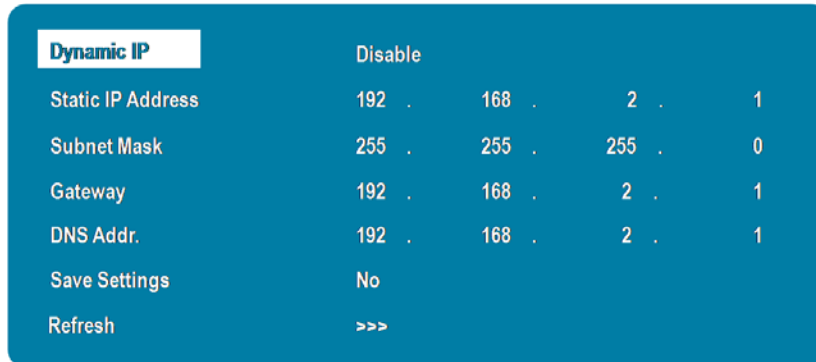

The default settings are shown below.

Item	Setting
Dynamic IP	Disable
Static IP Address	192.168.2.1
Subnet Mask	255.155.155.0
Gateway	192.168.2.1
DNS Addr.	192.168.2.1

Information Menu

This read-only menu provides information on the active sources and the latest firmware version.

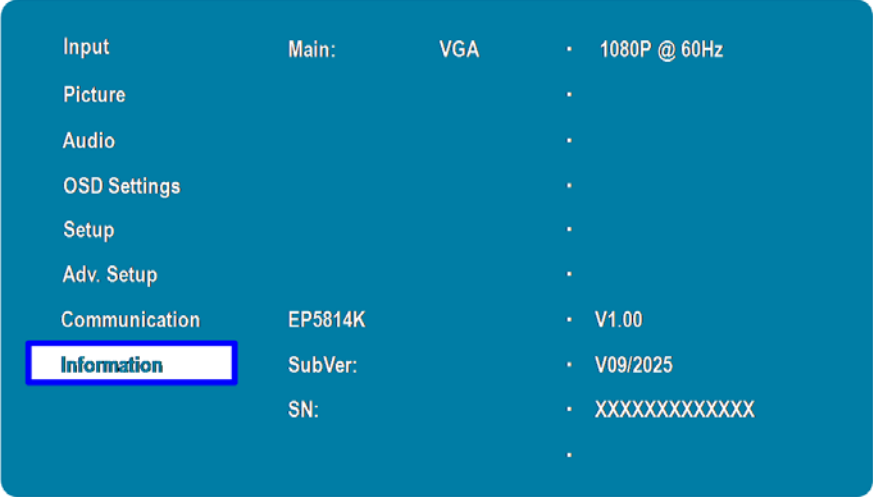

Using the Touch Screen

You can use the touch screen to control your operating system. The touch screen can emulate basic mouse functions and supports multi-touch functions for Windows 7* and Windows 8*. The following table shows a list of functions you can use on the touch screen.

Note: *Ensure that you have installed the USB cable on the display to a computer.

Note: If an OPS PC is installed in the OPS slot, the OPS PC will automatically be connected internally to the touch system. The touch functionality is configurable via the Touch Control setting.

Performing basic functions

The following table shows how to perform basic tasks using the touch screen for Windows 8, Windows 7, Vista, XP, Mac OSX, and Linux.

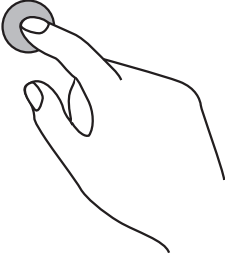
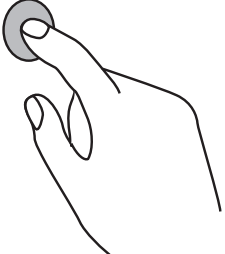
Function	Action	
Click	Tap the screen once.	
Double-Click	Tap the screen twice.	

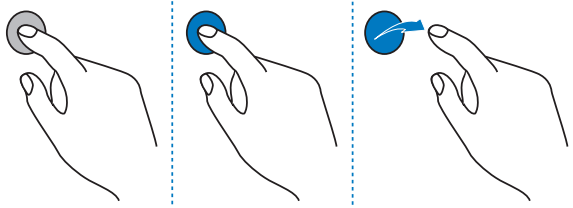
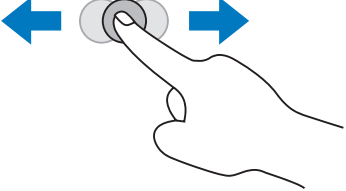
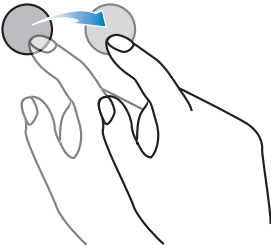
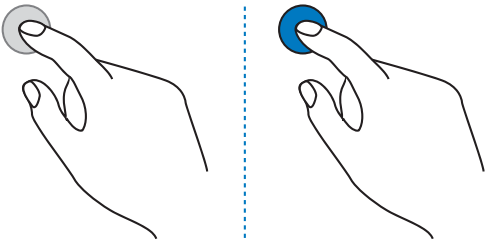
<p>Right-click</p>	<p>Press on the target. Hold and wait for a blue ring to appear. Release your finger.</p>	
<p>Drag or select</p>	<p>Drag one finger left or right.</p>	
<p>Pan up/down /back/forward</p>	<p>Quickly drag your finger (flick) in a desired direction.</p>	
<p>Wake up from Windows sleep mode (S3)</p>	<p>Press and hold for four seconds.</p>	

Touchscreen MultiTouch Driver Installation

- 1 With the PC on, plug in the USB memory stick to the USB drive.
- 2 Locate and open the USB drive.
- 3 Double-click on the “mt_driver_kit [xxxxxx].exe” to install the driver.
- 4 Follow installation prompts until driver installation is complete.

Once driver installation is complete, the touchscreen is ready for use.

Touchscreen (PQLabs) MultiTouch Platform Content

The PQLabs Software is used for troubleshooting and calibration. The different menus are described below.

- 1 On the PC, select the **Start** menu, **All Programs** and then **PQLabs Software**.
- 2 Click on “MultiTouch Platform” to open the PQLabs MultiTouch Platform window.

Touchscreen Information

- Serial Number – Displays the serial number of the connected touchscreen.
- Firmware Version – Displays the firmware version of the touchscreen selected under the “Serial Number” dropdown menu.
- Touch Points – Displays the number of touch points for which the touchscreen is capable.
- Status – Displays the current status of the touchscreen.

Calibration

- **Calibration** – Starts a 4-point calibration of the touchscreen. Perform the programmed touchscreen calibration process. At the conclusion of the calibration routine your touchscreen device is ready to use and will perform with accurately positioned touch points.
- **Reset Calibration** – Resets calibration to factory default settings.

Utility

- Diagnose – Starts the “MultiTouchDoctor” program. This can be used to troubleshoot issues with the touchscreen.

Options

- Default settings on options have the following programs enabled: Tuio Support, Flash Tuio Support, Handwriting Optimization, Enable Windows Native Touch, Enable Mouse/Keyboard Simulation, and Launch When Windows Starts Up.
- Flexible Scan Rate is at a default setting.

Uninstalling the MultiTouch Driver

- 1 On the PC, select the **Start** menu, **All Programs** and the **PQLabs Software**
- 2 Click on the MultiTouch Driver.
- 3 Select the Uninstall option.

Multi-Touch Functions

The following table shows how to perform multi-touch tasks using the touch screen for Windows 7 - Home Premium, Professional, Enterprise and Ultimate versions.

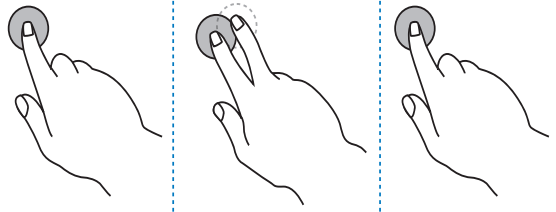
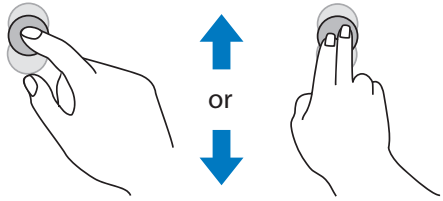
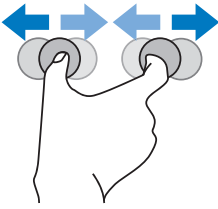
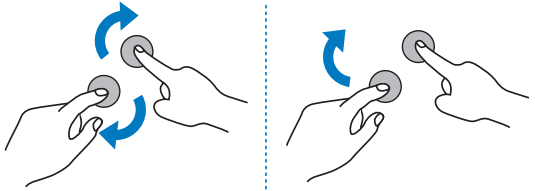
Function	Action	
Right-click	Press on the target. Tap the screen with another finger. Release the second finger.	
Scrolling	Drag one or two fingers up or down.	
Zoom	Move two fingers apart or toward each other.	
Rotate	<ul style="list-style-type: none"> • Move two fingers in opposing directions • Use one finger to pivot around the other. 	

LAN Control

The Planar EP-Series supports extending access to the RS232 commands over a network connection using a virtual COM port (VCOM). The VCOM driver installer is included on the USB drive that came with your display.

Note: RS232 commands over LAN can be achieved by opening a TCP connection to Port 23 to the display. The LAN control functionality is most frequently used by control systems, and they won't be able to use the VCOM drivers

Supported Operating Systems

The utility supports the following operating systems:

- Windows XP
- Windows Vista
- Windows 7
- Windows 8 and 8.1

Installation

Use the following instructions to install the VCOM driver.

- 1 Launch the vcomsetup.exe file.
- 2 You may see a security warning similar to the following example. Click Run to continue.

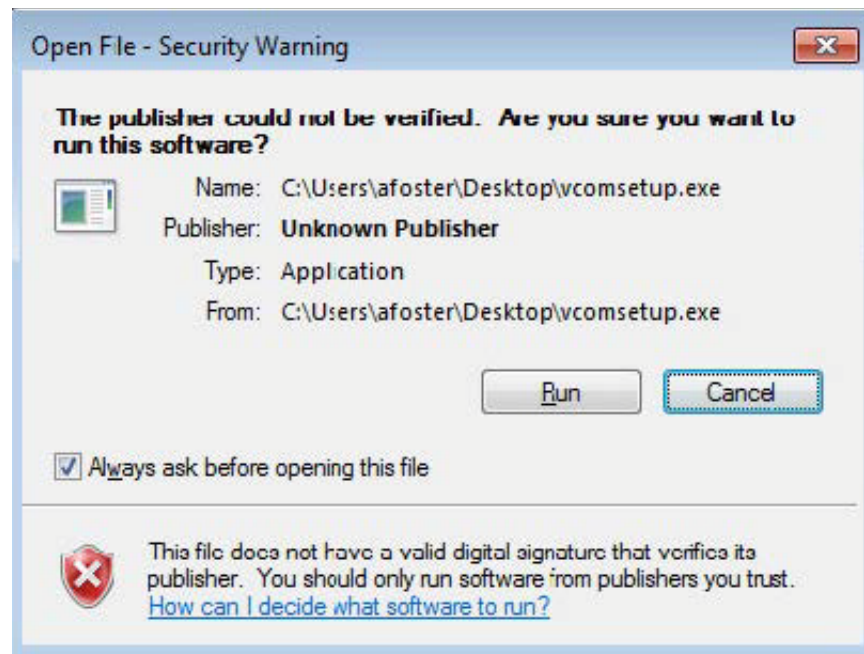

- The vcomsetup.exe installer installs both the VCOM virtual serial port and also a utility (WinPcap) for finding your displays on the network. Follow the steps in the two installers, accepting defaults and license agreements as needed.

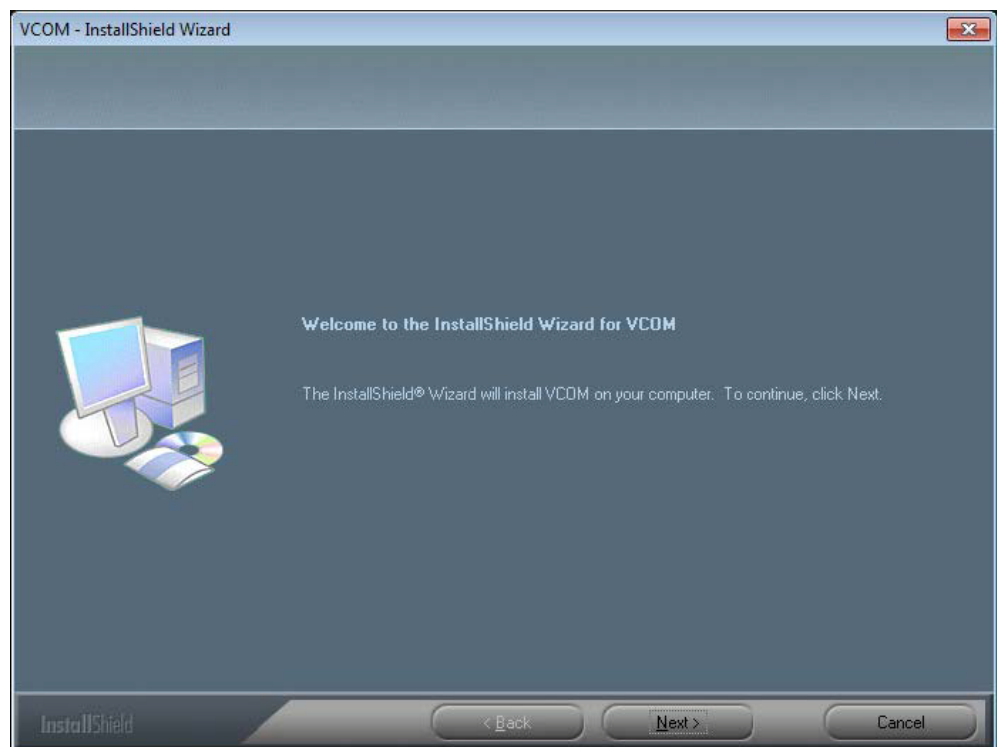
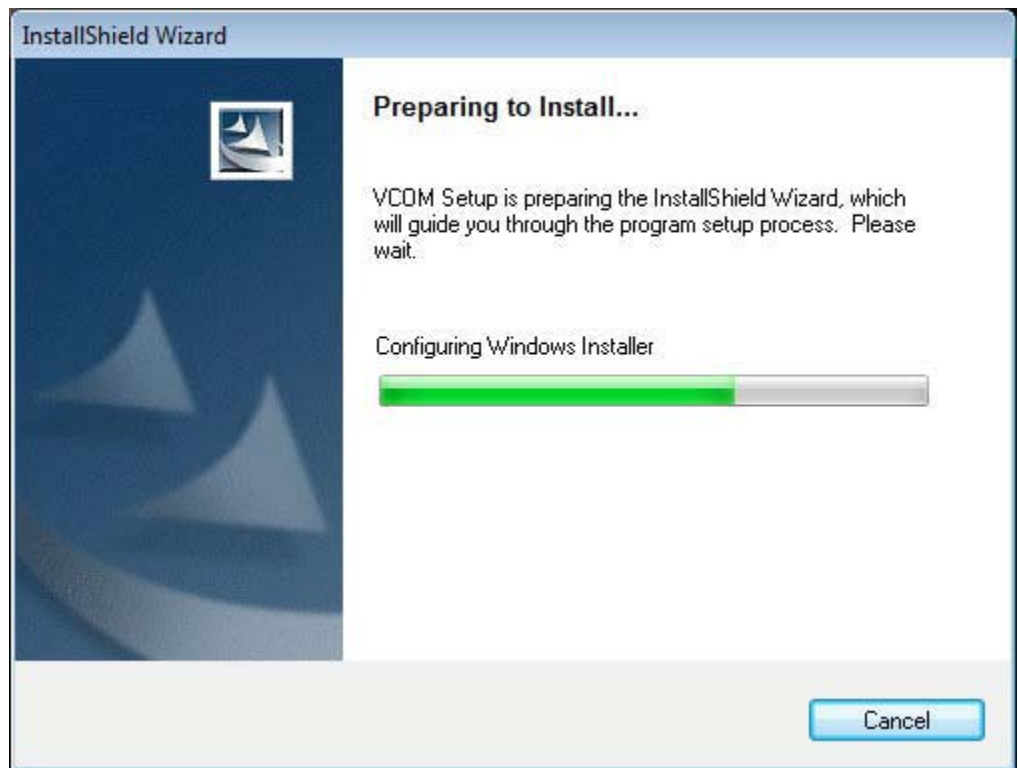



- 4 When the installers are finished, you will see a VCOM icon on your desktop and you find two new folders in your start menu: IC Plus corp (with VCOM sub folder) and WinPcap. If you need to uninstall the software, there are shortcuts to uninstall from these menus.



Configuring VCOM

Use the VCOM shortcut to launch the VCOM setup utility. The utility starts up on the Device Info page, shown below. The controls on this page allow you to find and configure each display that you want to access via virtual COM ports.

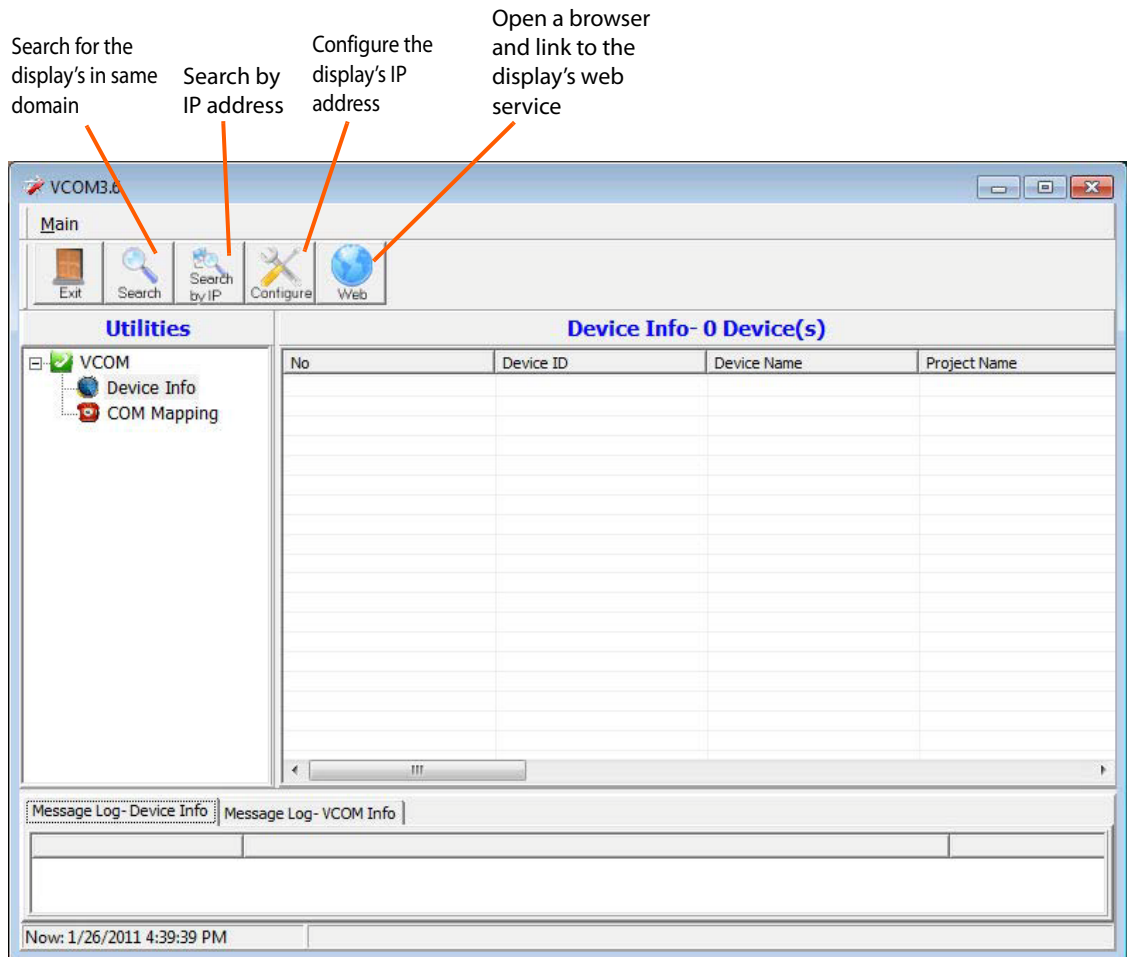

Function Descriptions

Search

In the Device Info page, click the Search icon. This function searches for any devices that are connected to the same network segment (maximum of 254 devices) as your PC. Any devices found will be listed in the Device Info table.

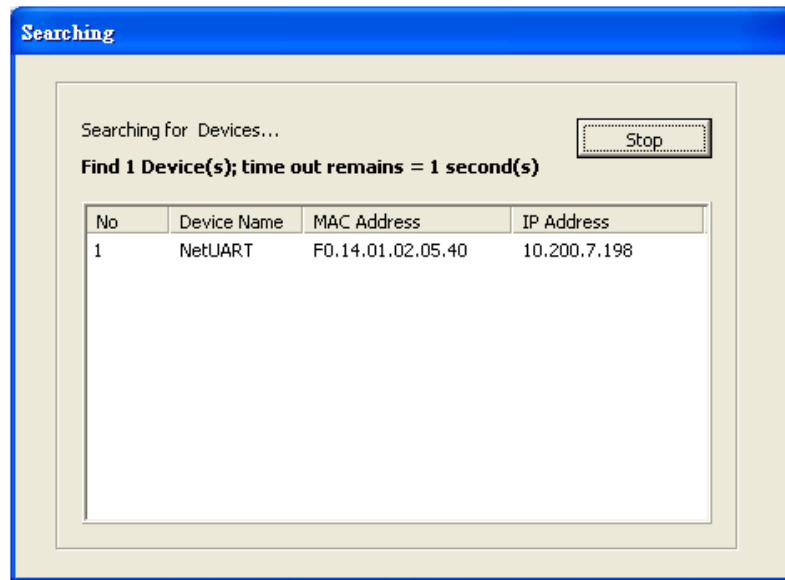

Search By IP

On the Device Info page, click the Search by IP icon. This function searches for any devices in the given IP address range. Any devices found will be listed in the Device Info table.

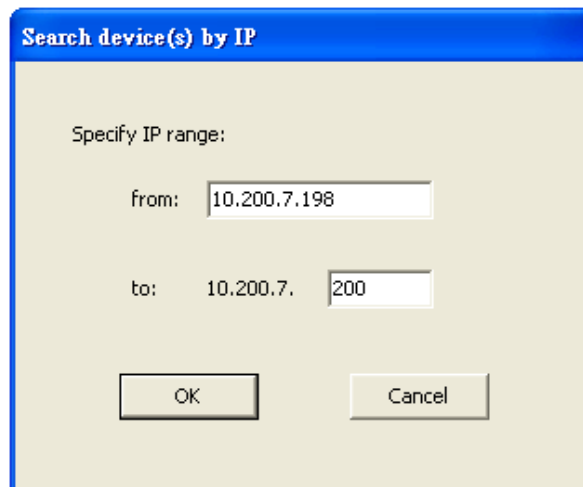

Configure IP Address

This function allows you to configure the network settings of the selected device. We recommend using the on-screen menus or the web interface described in the User Guide instead of this function.

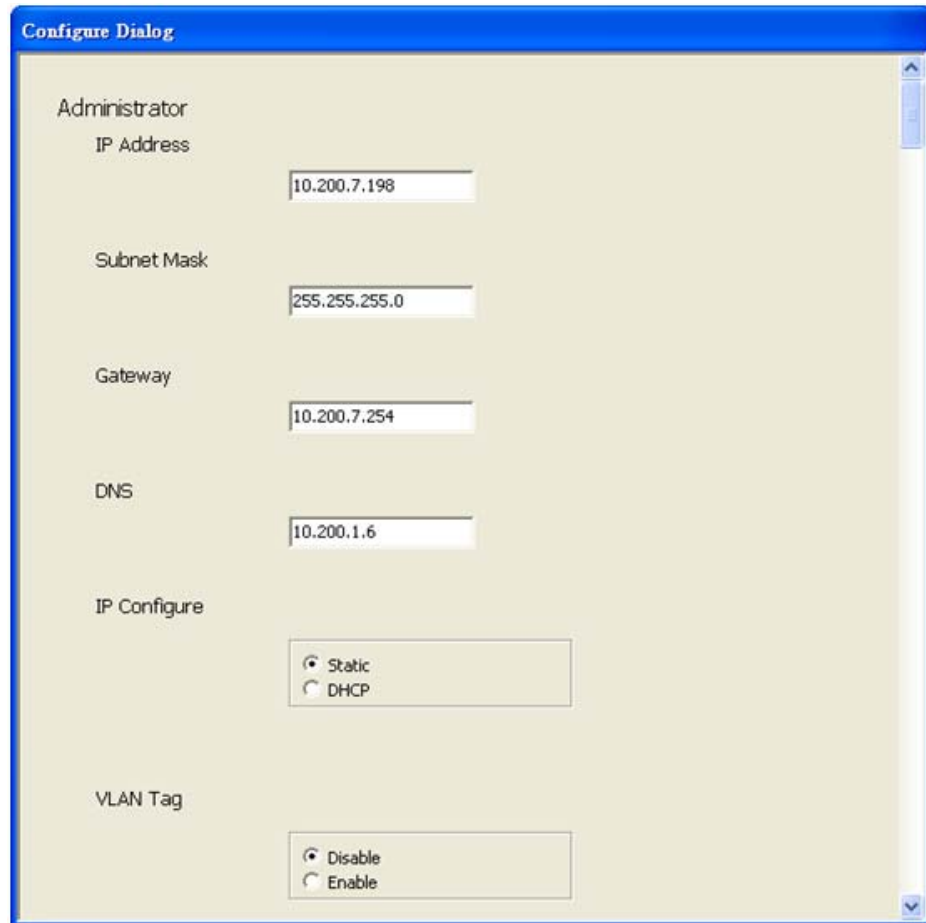

The screenshot shows a 'Configure Dialog' window with the following fields and options:

- Administrator**
- IP Address**: 10.200.7.198
- Subnet Mask**: 255.255.255.0
- Gateway**: 10.200.7.254
- DNS**: 10.200.1.6
- IP Configure**:
 - Static
 - DHCP
- VLAN Tag**:
 - Disable
 - Enable

Note: To cancel this function, scroll to the bottom and click the Cancel button.

Web

Click the Web icon to launch your default browser and link it to the display's web service.

Adding a Virtual COM Port

To add a virtual COM port, click the Add icon on the COM Mapping page to open the following dialog window.

The screenshot shows the 'Add VCOM' dialog box. It contains a table with the following data:

No	Device Name	MAC Address	IP Address
1	NetUART	F0.14.01.02.05.40	10.200.7.198

Below the table, the 'TCP/UDP' section has 'TCP' selected. The 'Server/Client' section has 'Client' selected. The 'IP Address' field contains '10.200.7.198'. The 'COM' field is set to '22' and the 'Remote Port' field is set to '23'. The 'Enable Control Connection' checkbox is checked. The reconnection interval is set to '1' second(s).

Select the display you want to control from the table and accept defaults, as shown. Make a note of the COM number assigned to the new VCOM port. Click OK to create the new port. The new port appears in the COM Mapping table.

You can view details for the virtual COM port device using Device Manager, shown below.

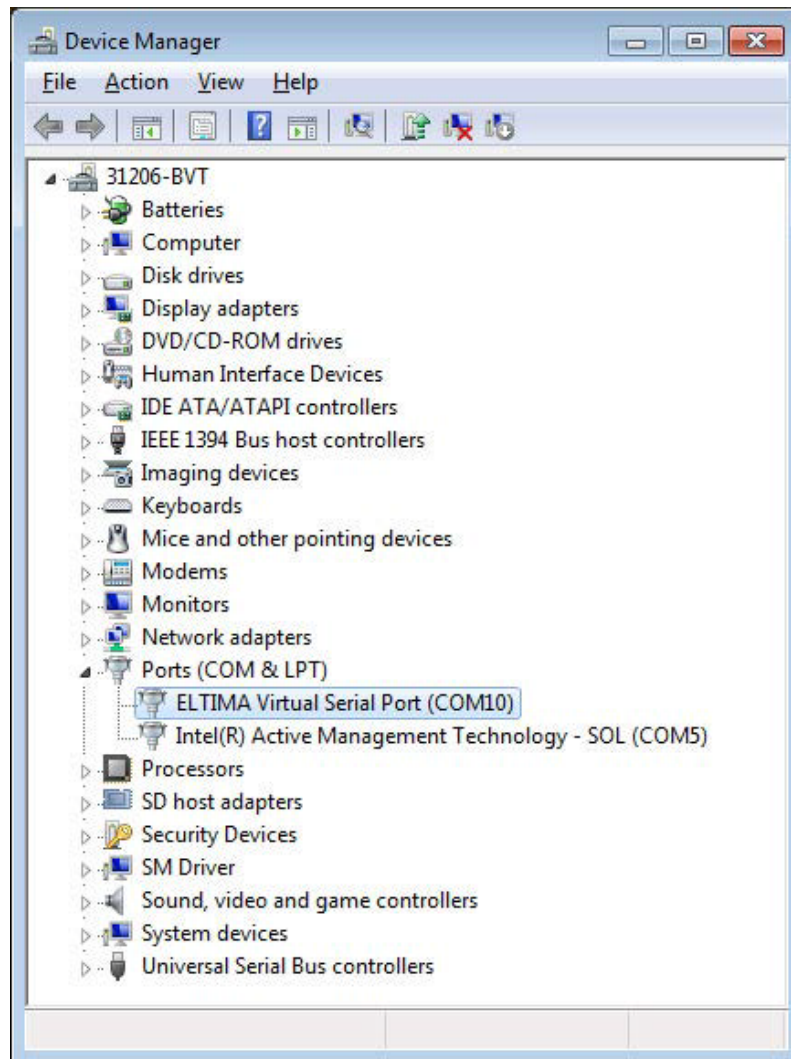

Removing a COM Port

On the COM Mapping page, select the COM port you want to delete and click the REMOVE button.

Setting Up Email Alerts

The web service allows you to configure the settings required to send email alerts. If you are not using email alerts, you do not need to use the web service and can skip this section.

Login

When you direct your browser to the network IP address of the display, you are prompted to login as shown here.

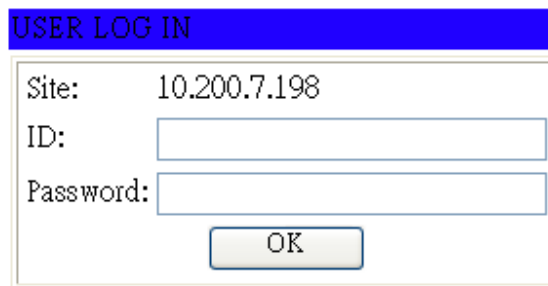

USER LOG IN

Site: 10.200.7.198

ID:

Password:

OK

The default ID is **admin** and the default password is **system**.

Note: Cookies and JavaScript must be enabled in your browser.

Note: If your session times out or if you enter an incorrect ID or password, you will see the following message.



When you first login, you will see the System Status page, as shown here.



When image experience matters.

Administrator

- [TCP Mode](#)
- [UDP Mode](#)
- [UART](#)
- [SMTP](#)
- [Reset Device](#)

System Status

Kernel Version	V2018 (Dec 08 2010 10:08:13)
MAC Address	00:1F:B6:00:00:22
Nickname	<input type="text" value="NetUART"/> <input type="button" value="Update"/> Please refresh web page after press "updated" button.

Note:
Comment name only can use "0-9","a-z","A-Z","_","-"

Administrator

Click on the word Administrator under the Planar logo to show/hide these menu items.

Authentication Configuration

Set user ID and password for login to the web service.

PLANAR
When image experience matters.

Administrator

- [Authentication Configuration](#)
- [System IP Configuration](#)
- [System Status](#)
- [Load default setting](#)
- [Firmware update](#)
- [Boot Loader upgrade](#)
- TCP Mode**
- UDP Mode**
- UART**
- SMTP**
- Reset Device**

Authentication Configuration

Setting	Value
Username	admin max:15
Password Confirm max:15

Please refresh web page after press "updated" button.

Note:
Comment name only can use "0-9","a-z","A-Z"

System IP Configuration

You can view and/or change the network settings here. However, for best results, we recommend that you use the on-screen display menus.

PLANAR
When image experience matters.

Administrator

- [Authentication Configuration](#)
- [System IP Configuration](#)
- [System Status](#)
- [Load default setting](#)
- [Firmware update](#)
- [Boot Loader upgrade](#)
- TCP Mode**
- UDP Mode**
- UART**
- SMTP**
- Reset Device**

System IP Configuration

Setting	Value
IP Address	192 . 168 . 2 . 1
Subnet Mask	255 . 255 . 255 . 0
Gateway	192 . 168 . 2 . 1
DNS	192 . 168 . 2 . 1
IP Configure	<input type="radio"/> Static <input checked="" type="radio"/> DHCP
VLAN Tag	<input checked="" type="radio"/> Disable <input type="radio"/> Enable : VLAN ID 0

Please refresh web page after press "updated" button.

If your network requires a VLAN tag, your network administrator will give you a number from 1 to 4094 to enter here.

System Status

- Kernel version - Shows the firmware version for the network interface.
- MAC Address - Shows the unique address assigned to the network interface.
- Nickname - Enter a device tag, up to 12 characters. This tag will appear in email alerts, which help you identify the source of the alert.

PLANAR
When image experience matters.

Administrator

- [Authentication Configuration](#)
- [System IP Configuration](#)
- [System Status](#)
- [Load default setting](#)
- [Firmware update](#)
- [Boot Loader upgrade](#)
- [TCP Mode](#)
- [UDP Mode](#)
- [UART](#)
- [SMTP](#)
- [Reset Device](#)

System Status

Kernel Version	V2018 (Dec 08 2010 10:08:13)	
MAC Address	00:1F:B6:00:00:22	
Nickname	NetUART	<input type="button" value="Update"/>

Please refresh web page after press "updated" button.

Note:
Comment name only can use "0-9", "a-z", "A-Z", "_", "-"

Load Default Setting

- 1 Click the LOAD button to return the network interface to default settings.

Load Default Setting to EEPROM

- 2 After a few seconds, you will see a green box with the message "Setting Saved RESET." Click the RESET button to restart the network interface.

Setting Saved
RESET

- 3 Make sure the IP address in your browser is correct and then click OK.



- 4 When the process is complete, you should see the login page again.

Firmware Update and Boot Loader Upgrade

In most cases, you will not need to update firmware for the network interface. If you do, contact Planar's Technical Support Department. See "Accessing Planar's Technical Support Website" on page 74 for more information.

WARNING! Do not use the controls in these two sections unless you have received a specific procedure and firmware from Planar. Following improper procedures can disable the network interface and require factory repair service.

TCP Mode, UDP Mode and UART

For normal operation, you will not need to change any settings on these pages. If you do need to change information, Planar's Technical Support Department will provide you with more information.

SMTP

SMTP setup

Enable SMTP	<input type="checkbox"/> Enable, Port: <input type="text" value="25"/>
SMTP server address	<input type="text" value="smtp.xxx.yyy"/>
SMTP Login Information	<input type="checkbox"/> Enable Username: <input type="text" value="username"/> Password: <input type="password" value="••••••"/>
Mail to	<input type="text" value="xxx@yyy.zzz"/> max: 200
Mail from	<input type="text" value="xxx@yyy.zzz"/>

Your network administrator must provide information for the following fields:

- Enable SMTP - Make sure this checkbox is checked. Port 25 is the default.
- SMTP Server Address - Name or IP address of the mail server.
- SMTP Login Information - If required, check the ENABLE box and enter a username and password.
- Mail to - Enter the destination email addresses. Separate multiple addresses with a semi-colon.
- Mail from - Enter the email address from which you want to send alerts.

SMTP 01 Warning	
Subject	Power Status Change Alert
Message Body	SMTP 01 body max: 100

SMTP 02 Warning	
Subject	Source Change Alert
Message Body	SMTP 02 body max: 100

SMTP 03 Warning	
Subject	Signal Lost Alert
Message Body	SMTP 03 body max: 100

You can edit the subject and body of the email warnings, which are sent when there is a power status change, source change and signal lost. The SMTP 04 and 05 warnings are not used.

Reset Device

Click the RESET button to reboot the network interface. Note that the current settings are not changed.

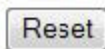

Signal Compatibility

Signal Type	Resolution	Frame rate (Hz)	Line Rate (kHz)	Pixel Rate (MHz)	HDMI - RGB	DisplayPort - RGB	VGA - RGB	References
PC	640x480	60	31.469	25.175	x	x	x	VESA DMT, CEA-861-E Format 1
	640x480	72	37.861	31.500	x	x	x	VESA DMT
	640x480	74.99	37.500	31.500	x	x	x	VESA DMT
	640x480	85	43.269	36.000	x	x	x	VESA DMT
	800x600	56.25	35.156	36.000	x	x	x	VESA DMT
	800x600	60.32	37.890	40.000	x	x	x	VESA DMT
	800x600	72	48.077	50.000	x	x	x	VESA DMT
	800x600	75	46.875	49.500	x	x	x	VESA DMT
	800x600	85.06	53.674	56.250	x	x	x	VESA DMT
	1024x768	60	48.363	65.000	x	x	x	VESA DMT
	1024x768	70	56.476	75.000	x	x	x	VESA DMT
	1024x768	75.03	60.023	78.750	x	x	x	VESA DMT
	1024x768	85.03	68.677	94.500	x	x	x	VESA DMT
	1152x864	75	67.500	108.000	x	x	x	VESA DMT
	1280x720	59.98	44.444	64.000	x	x	x	VESA CVT-R
	1280x720	59.86	44.772	74.500	x	x	x	VESA CVT
	1280x720	74.78	56.456	95.750	x	x	x	VESA CVT
	1280x768	60	47.4	68.250	x	x	x	VESA DMT
	1280x768	60	47.776	79.500	x	x	x	VESA CVT
	1280x800	59.91	49.306	71.000	x	x	x	VESA CVT-R
	1280x800	59.81	49.702	83.000	x	x	x	VESA CVT
	1280x1024	60.02	63.981	108.000	x	x	x	VESA DMT
	1280x1024	75.02	79.976	135.000	x	x	x	VESA DMT
	1280x1024	85.02	91.146	157.500	x	x	x	VESA DMT
	1360x768	60	47.712	85.500	x	x	x	VESA DMT
	1400x1050	60	64.7	101.000	x	x	x	VESA CVT-R
	1400x1050	60	65.317	121.750	x	x	x	VESA CVT
1440x900	59.901	55.469	88.750	x	x	x	VESA CVT-R	
1440x900	59.88	55.935	106.500	x	x	x	VESA CVT	
1600x1200	60	75.000	162.000	x	x	x	VESA DMT	

Signal Type	Resolution	Frame rate (Hz)	Line Rate (kHz)	Pixel Rate (MHz)	HDMI - RGB	DisplayPort - RGB	VGA - RGB	References
PC	1680x1050	59.883	55.469	119.000	x	x	x	VESA CVT-R
	1680x1050	59.954	65.290	146.250	x	x	x	VESA CVT
	1920x1080	60	66.587	138.500	x	x	x	VESA CVT-R
	2560x1440	59.951	88.787	241.500	x	x		VESA CVT-R
	2560x1600	59.972	98.713	268.500	x	x		VESA CVT-R
	3840x2160	24	52.438	209.750	x	x		VESA CVT-R
	3840x2160	30	65.688	262.750	x	x		VESA CVT-R
	3840x2160	50	110.500	442.000		x		VESA CVT-R
	3840x2160	60	133.313	533.250		x		VESA CVT-R
EDTV	480p	60	31.469	27.000	x	x		ITU-R BT.1358, CEA-861-E Format 17 & 18
	576p	50	31.250	27.000	x	x		SMPTE 125M, CEA-861-E Format 6 & 7
HDTV	1080i	50	28.125	74.500	x	x		SMPTE 274M, CEA-861-E Format 20
	1080i	60	33.750	74.250	x	x		SMPTE 274M, CEA-861-E Format 5
	720p	50	37.500	74.250	x	x		SMPTE 296M, CEA-861-E Format 19
	720p	60	45.000	74.250	x	x		SMPTE 296M, CEA-861-E Format 4
	1080p	24	27.000	74.250	x	x		SMPTE 274M, CEA-861-E Format 32
	1080p	25	28.125	74.250	x	x		SMPTE 274M, CEA-861-E Format 33
	1080p	30	33.750	74.250	x	x		SMPTE 274M, CEA-861-E Format 34
	1080p	50	56.250	148.500	x	x		SMPTE 274M, CEA-861-E Format 31
	1080p	60	67.500	148.500	x	x		SMPTE 274M, CEA-861-E Format 16
UHDTV	3840x2160	24	54.000	297.000	x	x		SMPTE ST 2036-1:2009, HDMI 1.4b VIC 1
	3840x2160	25	56.250	297.000	x	x		SMPTE ST 2036-1:2009, HDMI 1.4b VIC 2
	3840x2160	30	67.500	297.000	x	x		SMPTE ST 2036-1:2009, HDMI 1.4b VIC 3
	3840x2160	50	112.500	594.000		x		CEA-861-F Format 96
	3840x2160	60	135.000	594.000		x		CEA-861-F Format 97

Specifications

	Item	Model	Specification
LCD panel	Resolution		3840 x 2160
	Aspect Ratio		16:9
	Screen Size		58"
	Orientation		Landscape/Portrait
	Brightness (typ.)		450 cd/m ²
	Contrast Ratio		3000:1
	Viewing Angle (Typ.)		178°
	Response Time		6.5 ms
	Color Gamut		72% NTSC
	Display Color		1.07G colors
	Pixel Pitch		0.334(H) x 0.334(V)
	Auto Brightness Control		Ambient Light Sensor
	Features		OPS Slot, On/Off Scheduling, TAA Compliant
Touch	Touch Technology	EP5814K-T	6 pt IR
	Supporting OS	EP5814K-T	Windows 8, 7, Vista, XP, Mac OSX, and Linux
Connectivity	Standard Inputs		HDMI x 4 / DisplayPort / VGA / IR
	Audio Input		PC Audio In (Jack)
	Audio Output		R/L Line Out (Jack)
	Control and Monitoring		LAN RJ45, RS232 In, IR, Keypad (lockable)

Mechanical	Display Weight	EP5814K	Display Weight: 84 lbs (36 kg); Shipping Weight: 97 lbs (44 kg)
		EP5814K-T	Display Weight: 112 lbs (51 kg); Shipping Weight: 130 lbs (59 kg)
	Mounting		VESA 400 mm x 200 mm
	Display Dimensions	EP5814K	51.2" x 29.6" x 3.2" (1300.7 mm x 752.1 mm x 80.1 mm)
		EP5814K-T	51.8" x 30.1" x 3.8" (1315.0 mm x 764.2 mm x 96.2 mm)
	Bezel Width	EP5814K	0.6" (14.0 mm)
		EP5814K-T	0.7" (19.3 mm)
	Enclosure		Metal, Industrial
	Fanless		Yes
Speakers		10W x 2 Built-In	
Usage	Recommended Usage		Up to 24x7 Operation
	Backlight		E-LED
	Backlight Life		30,000 Hours Min
Power Source	Input Voltage/ Frequency		AC 100V~240V; 50-60 Hz
Environment	Storage Temperature		Min -4°F ~ Max 140° F (-20°C ~ Max 60°C)
	Operating Temperature		Min 32°F ~ 104°F (0°C ~ Max 40°C) 10,000 ft (3000 m) altitude
	Humidity		20~90% RH
	Approvals		FCC Class A, UL, CE

Troubleshooting

Before calling service personnel, please check the following table for a possible cause of the problem you are experiencing. Please note the following:

- Perform the adjustments according to "Operating the Display" on page 19.
- If the problem you have experienced isn't described below or you can't correct the problem, stop using the display and contact Planar's Technical Support Department. (See "Accessing Planar's Technical Support Website" on page 74)

Issue	Check for the following
No image is displayed	Make sure the correct source is selected.
	Make sure the main power switch is turned ON.
	Check that the source equipment is operating correctly.
	Make sure the input signal is compatible with this display.
The image is not centered	Make sure the input signal is compatible with this display.
The remote control doesn't work	Make sure the batteries are new and are installed correctly. Ensure the remote is aimed at the IR sensor.
	Make sure the remote control sensor is plugged in correctly.
	Make sure the remote is aimed towards the back of the display, where the sensor is located.
The picture color looks poor	Check the picture settings. Reset the display.
	If you are using YUV terminals, make sure cables are correctly connected.
	Check ADC calibration.

Accessing Planar's Technical Support Website

Go to <http://www.planar.com/support> to locate the following support documents and resources:

- User Guide
- RS232 User Manual
- Touchscreen drivers
- Standard warranties
- Planar support hotline number and email

Index

A

accessory kit, 10
adjusting volume, 26
administrator in web service, 64
audio settings menu, 27
authentication configuration page, 64
avoiding temporary image retention, 4

B

basic settings menu, 27
batteries
 changing in the remote, 25

C

cable clamps
 installation, 12
cleaning the display, 7
Connecting the Touchscreen, 48
cooling requirements, 6

D

default setting
 loading in web service, 65
dimensions, 13
display settings menu, 27

E

exemptions for product use, 8

H

HD-SDI board
 installing, 19

I

image settings menu, 27
input source
 selecting, 26
installation, 16
 cable clamps, 12
 HD-SDI board, 19
 OPS expansion slot, 18
 safety precautions, 3
introduction, 1
ip system configuration, 64

L

LAN control, 52
locking, 24

M

menus
 audio settings, 27
 basic settings, 27
 display settings, 27
 image settings menu, 27
 using, 26

N

navigating, 26
navigating menus, 26
network interface
 resetting, 68
normal usage guidelines, 6

O

OPS expansion slot
 installation, 18
osd menus, 24, 26
unlocking, 24

P

package contents, 8
product usage
 exemptions, 8

R

recommended usage, 4
remote control
 changing the batteries, 25
 using, 22
resetting the network interface, 68
RS232 network connection, 52

S

safety
 during installation, 3
 information, 2
 precautions, 2
 precautions during use, 4
selecting input source, 26
service plans, ii
signal compatibility, 69
signal source input, 18
SMTP setup page, 67
specifications, 71
supported timings, 69
system ip configuration page, 64
system status page, 63, 65

T

temporary image retention
 avoiding, 4
 definition, 4
timings, 69
TIR *see temporary image retention*
touchscreen
 using the touchscreen, 48
troubleshooting, 73
turning off the displays, 26
turning on the displays, 25

U

unpacking the displays, 8
using the remote, 22

V

VCOM
 configuration, 56
 driver installation, 53
vesa mounts, 6
volume, 26

W

warranty
 exemptions, 8
 information, ii
web service, 62
 administrator, 64
 authentication configuration, 64
 loading default setting, 65
 reset device, 68
 SMTP setup page, 67
 system ip configuration, 64
 system status, 63
 system status page, 65