





OWNER'S MANUAL

# MEDICAL MONITOR

Please read this manual carefully before operating your set and retain it for future reference.

27HJ712C

Please note that this information is for proper use and safety of the equipment. The following symbols may indicate a hazardous situation in which, if not heeded, may result in serious injury or even death to the user or others, or damage to the equipment.

 <b>WARNING</b>	<p>Indicates warning and safety instructions. If not adhered to, it could result in death or serious injury to the user or others.</p>
 <b>CAUTION</b>	<p>Indicates a hazardous situation which, if not heeded, may result in minor or moderate injury to the user or others, or damage to the equipment.</p>

### **For users in the United States**

- United State federal law restricts this equipment to be used by or on the order of a physician.

### **For users in other countries**

- This equipment is to be used by or on the order of a licensed person under the related laws for each country.

### **WARNING**

- To avoid the risk of electric shock, this equipment must only be connected to a supply mains with protective earth.
- Do not modify this equipment without authorization of the manufacturer.

### **Intended use**

- This Medical Monitor is intended to provide color displays and images from various medical imaging systems.



Authorized representative in the European community.

**LG Electronics European Shared Service Center B.V.**

Krijgsman 1, 1186 DM Amstelveen, The Netherlands

Tel: +31-20-456-3132

**LG Electronics Inc.**

77, Sanho-daero, Gumi-si, Gyeongsangbuk-do, 39381, Republic of Korea

Tel: +82-1544-8777



# SAFETY INFORMATION

## Safety Standard

### Medical Device Classification

<b>Classification by protection type against Electric Shock</b>	Class I equipment
<b>Mode of operation</b>	Continuous Operation
<b>Environment of Use</b>	This equipment is not suitable for use in the presence of flammable anesthetic or oxygen.

### Regulations

#### Safety and Electromagnetic Compatibility Information

This equipment has been tested and found to comply with the limits for medical devices in IEC 60601-1-2. These limits are designed to provide reasonable protection against harmful interference in a typical medical installation.

This equipment generates, uses and can radiate radio frequency energy. If not installed and used in accordance with the instructions, it may cause harmful interference to other devices in the vicinity.

However, there is no guarantee that interference will not occur in a particular installation. If this equipment does cause harmful interference to other devices, which can be determined by turning the equipment off and on, the user is encouraged to try to correct the interference by one or more of the following measures.

- Reorient or relocate the equipment.
- Increase the separation between the equipment.
- Connect the equipment into an outlet on a circuit different from that to which the other devices are connected.
- Contact manufacturer or authorized agent for help.

#### Radio Frequency compliance

##### FCC (For USA)

#### FCC NOTICE

This device complies with part 15 of the FCC Rules. Operation is subject to the following two conditions: (1) This device may not cause harmful interference, and (2) this device must accept any interference received, including interference that may cause undesired operation.

**FCC CAUTION**

Changes or modifications not expressly approved by the party responsible for compliance could void the user's authority to operate the equipment. This transmitter must not be co-located or operated in conjunction with any other antenna or transmitter.

**FCC WARNING**

This equipment may generate or use radio frequency energy changes or modifications to this equipment may cause harmful interference unless the modifications are expressly approved in the instruction manual.

The user could lose the authority to operate this equipment if an unauthorized change or modification is made.

Note: This equipment has been tested and found to comply with the limits for a Class A digital device, pursuant to part 15 of the FCC Rules. These limits are designed to provide reasonable protection against harmful interference when the equipment is operated in a commercial environment.

This equipment generates, uses, and can radiate radio frequency energy and, if not installed and used in accordance of this equipment in a residential area is likely to cause harmful interference in which cause the user will be required to correct the interference at his own expense.

**For Europe****DECLARATION OF CONFORMITY**

The complete Declaration of Conformity may be requested through the following postal address:

LG Electronics European Shared Service Center B.V., Krijgsman 1, 1186 DM Amstelveen, The Netherlands

or can be requested at our dedicated DoC website: <http://www.lg.com/global/support/cedoc/cedoc#>

**Electro-Magnetic Compatibility Information****Electro-Magnetic Emissions**

This EUT is intended for use in the electromagnetic environment specified below.

The customer or the user of the EUT should assure that it is used in such an environment.

Immunity Test	Compliance	Electromagnetic Environment – Guidance
RF Emissions CISPR 11	Group 1	The EUT uses RF energy only for its internal function. Therefore, its RF emissions are very low and are not likely to cause any interference in nearby electronic equipment.
RF Emissions CISPR 11	Class A	The EUT is suitable for use in all establishments, including domestic establishments and those directly connected to the public low-voltage power supply network that supplies buildings used for domestic purposes.
Harmonic emissions IEC 61000-3-2	A	
Voltage fluctuations/ Flicker emissions IEC 61000-3-3	Complies	

### Electro-Magnetic Immunity

This EUT is intended for use in the electromagnetic environment specified below.

The customer or the user of the EUT should assure that it is used in such an environment.

Immunity Test	IEC 60601-1-2 Test Level	Compliance Level	Electromagnetic Environment – Guidance
Electrostatic discharge (ESD) IEC 61000-4-2	± 8 kV contact ± 2 kV, ± 4 kV, ± 8 kV, ± 15 kV air	± 8 kV contact ± 15 kV air	Floors should be wood, concrete or ceramic tile. If floors are covered with synthetic material, the relative humidity should be at least 30%.
Electrical fast transient/burst IEC 61000-4-4	± 2 kV 100 kHz repetition frequency	± 2 kV 100 kHz repetition frequency	Mains power quality should be that of a typical commercial or hospital environment.
Surge Line-to-line IEC 61000-4-5	± 0,5 kV, ± 1 kV	± 1 kV	Mains power quality should be that of a typical commercial or hospital environment.
Surge Line-to-ground IEC 61000-4-5	± 0,5 kV, ± 1 kV, ± 2 kV	± 2 kV	
Voltage dips IEC 61000-4-11	0 % $U_i$ ; 0,5 cycle At 0°, 45°, 90°, 135°, 180°, 225°, 270° and 315°	0 % $U_i$ ; 0,5 cycle At 0°, 45°, 90°, 135°, 180°, 225°, 270° and 315°	Mains power quality should be that of a typical commercial or hospital environment. If the user of the EUT image intensifier requires continued operation during power mains interruptions, it is recommended that the EUT image intensifier be powered from an uninterruptible power supply or a battery.
	0 % $U_i$ ; 1 cycle and 70 % $U_i$ ; 25/30 cycles Single phase: at 0°	0 % $U_i$ ; 1 cycle and 70 % $U_i$ ; 25/30 cycles Single phase: at 0°	
Voltage interruptions IEC 61000-4-11	0 % $U_i$ ; 250/300 cycle	0 % $U_i$ ; 250/300 cycle	
RATED power frequency magnetic fields (50/60Hz) IEC 61000-4-8	30 A/m	30 A/m	Power frequency magnetic fields should be at levels characteristic of a typical location in a typical commercial or hospital environment.

### ! NOTE

- $U_i$  is the A.C mains voltage prior to application of the test level.

Immunity Test	IEC 60601-1-2 Test Level	Compliance Level	Electromagnetic Environment – Guidance
Conducted disturbances induced by RF fields IEC 61000-4-6	3 V 0,15 MHz – 80 MHz 6 V in ISM bands between 0,15 MHz and 80 MHz 80 % AM at 1 kHz	3 V 0,15 MHz – 80 MHz 6 V in ISM bands between 0,15 MHz and 80 MHz 80 % AM at 1 kHz	Portable and mobile RF communications equipment should be used no closer to any part of the EUT, including cables, than the recommended separation distance calculated from the equation applicable to the frequency of the transmitter.
Radiated RF EM fields IEC 61000-4-3	3 V/m 80 MHz – 2,7 GHz 80 % AM at 1 kHz	3 V/m 80 MHz – 2,7 GHz 80 % AM at 1 kHz	<p>Recommended separation distance:</p> $d = \left[ \frac{3,5}{V_1} \right] \sqrt{P}$ $d = \left[ \frac{3,5}{E_1} \right] \sqrt{P} \quad 80 \text{ MHz to } 800 \text{ MHz}$ $d = \left[ \frac{7}{E_1} \right] \sqrt{P} \quad 800 \text{ MHz to } 2.7 \text{ GHz}$ <p>Where P is the maximum output power rating of the transmitter in watts(W) according to the transmitter manufacturer and d is the recommended separation distance in meters(M).</p> <p>Field strengths from fixed RF transmitters as determined by an electromagnetic site survey, should be less than the compliance level in each frequency range.</p> <p>Interference may occur in the vicinity of equipment marked with the following symbol:</p> 

## ! NOTE

- At 80 MHz and 800 MHz, the higher frequency range applies.
- These guidelines may not apply in all situations. Electromagnetic propagation is affected by absorption and reflection from structures, objects and people.

- 1 Field strengths from fixed transmitters, such as base stations for radio (cellular/cordless) telephones and land mobile radios, amateur radio, AM and FM radio broadcast and TV broadcast cannot be predicted theoretically with accuracy. To assess the electromagnetic environment due to fixed RF transmitters, an electromagnetic site survey should be considered. If the measured field strength in the location in which the EUT is used exceeds the applicable RF compliance level above, the EUT should be observed to verify normal operation. If abnormal performance is observed, additional measures may be necessary, such as re-orienting or relocating the EUT.
- 2 Over the frequency range 150 kHz to 80 MHz, field strengths should be less than [V1] V/m.

**Test specifications for ENCLOSURE PORT IMMUNITY to RF wireless communications equipment**

Test frequency (MHz)	Band <sup>a)</sup> (MHz)	Service <sup>a)</sup>	Modulation <sup>b)</sup>	Maximum power (W)	Distance (m)	IMMUNITY TEST LEVEL (V/m)
385	380 – 390	TETRA 400	Pulse modulation <sup>b)</sup> 18 Hz	1,8	0,3	27
450	430 – 470	GMRS 460, FRS 460	FM <sup>c)</sup> ± 5 kHz deviation 1 kHz sine	2	0,3	28
710	704 – 787	LTE Band 13, 17	Pulse modulation <sup>b)</sup> 217 Hz	0,2	0,3	9
745						
780						
810	800 – 960	GSM 800/900, TETRA 800, iDEN 820, CDMA 850, LTE Band 5	Pulse modulation <sup>b)</sup> 18 Hz	2	0,3	28
870						
930						
1 720	1 700 – 1 990	GSM 1800; CDMA 1900; GSM 1900; DECT; LTE Band 1, 3, 4, 25; UMTS	Pulse modulation <sup>b)</sup> 217 Hz	2	0,3	28
1 845						
1 970						
2 450	2 400 – 2 570	Bluetooth, WLAN, 802.11 b/g/n, RFID 2450, LTE Band 7	Pulse modulation <sup>b)</sup> 217 Hz	2	0,3	28
5 240	5 100 – 5 800	WLAN 802.11 a/n	Pulse modulation <sup>b)</sup> 217 Hz	0,2	0,3	9
5 500						
5 785						

**! NOTE**















• If necessary to achieve the IMMUNITY TEST LEVEL, the distance between the transmitting antenna and the ME EQUIPMENT or ME SYSTEM may be reduced to 1 m. The 1 m test distance is permitted by IEC 61000-4-3.



a) For some services, only the uplink frequencies are included.

b) The carrier shall be modulated using a 50 % duty cycle square wave signal.

c) As an alternative to FM modulation, 50 % pulse modulation at 18 Hz may be used because while it does not represent actual modulation, it would be worst case.

## Symbols

Symbols	Descriptions
	Refer to instruction manual/ booklet
	Alternate current
	Direct current
	Standby symbol
	Warning
	Caution
	UL classified mark of medical equipment with respect to electrical shock, fire and mechanical hazards only in accordance with ANSI/AAMI ES60601-1 (2005) + AMD 1 (2012), CAN/ CSA-C22.2 No. 60601-1 (2014)
	Manufacturer
	Date of manufacture
	Serial number
	Non-ionizing radiation
	WEEE: Waste Electrical and Electronic Equipment
	Authorized representative in the European community.
	CE Marking
	Temperature limit

	Humidity limitation
	Pressure limitation
<b>Rx</b> ONLY	For the customers in the U.S.A. Caution Federal law (United States of America) restricts this device to sale by or on the order of a licensed healthcare practitioner.

## Warning

**WARNING:** To avoid the risk of electric shock, this equipment must only be connected to a supply mains with protective earth.



### Connection

Do not connect the monitor with anything other than specified.

Otherwise, it may result in fire or electric shock.

To avoid the risk of electric shock, this monitor must only be connected to supply mains with protective earth.



### Handling

Always be sure to keep checking the condition of the system and the patient to ensure they are normal during the use of the monitor. If any problem is found, take appropriate measures, such as stopping the operation of the monitor; as required.

Never disassemble or modify the monitor as it may result in fire or electric shock.

Also, since the monitor incorporates parts that may cause electric shocks and other hazardous parts, touching them may cause death or serious injury.

Do not hit or drop the monitor. The monitor may be damaged if it receives a strong jolt, which may result in fire or electric shock if the monitor is used without being repaired.



The operator must not touch connectors of the monitor and the patient simultaneously.



The product has lower breaking capacity type. So do not install at the building power system prospective short-circuit current exceeding 35 A.

## Caution



Do not install the ME Equipment in a location without easy disconnect accessibility.



### Environment of Use and Storage

Do not install the monitor in a location with the conditions listed below. Otherwise, it may result in failure or malfunction, cause fire or injury.

- Close to facilities where water is used.
- Where it will be exposed to direct sunlight.
- Close to air-conditioner or ventilation equipment.
- Close to heat source such as a heater.
- Prone to vibration
- Unsecure location place.
- Dusty environment.
- Saline or sulfurous environment.
- High temperature or humidity.
- Freezing or condensation.

Do not place the storage case in a location with the conditions listed below.

- Where the cable of the monitor unit will be strongly pulled when the monitor is put into the case, otherwise, the cable may be damaged, resulting in fire or electric shock.
- Where someone might get their foot caught in the cable of the monitor.



### Handling

For safety reasons, be sure to turn off the power when monitor is not used. This monitor is contraindicated for pregnant woman.



MANUFACTURER will make available on request circuit diagrams, component part lists, descriptions, calibration instructions, or other information that will assist SERVICE PERSONNEL to repair those parts of ME EQUIPMENT.



### Location of Cables



Make sure all cables are located so that they cannot be stepped on, tripped over, or otherwise subjected to damage or stress.



If the monitor is defective, do not disassemble the monitor randomly. Maintenance of the monitor should be done by a manufacturer.

# SAFETY PRECAUTIONS

The Safety Precautions are intended to prevent unexpected danger or harm by helping the user to use the product safely and for its intended purpose.

 <b>WARNING</b>	Failure to follow the instructions may result in serious injury or even death.
 <b>CAUTION</b>	Failure to follow the instructions may result in minor injury to people or damage to the product.

## Precautions When Installing the Product

### **WARNING**

- Do not place the product close to heat sources such as radiators, fires, stoves, etc.
- Be careful when disinfecting the product, as some disinfectants may cause fire.
- Do not install the product in a damp or dusty area.
- If the product emits smoke, strange odors or sounds, disconnect the power cord and contact the manufacturer.
- Do not leave the power or signal cable, etc. in walkways.
- Do not install the product onto a wall close to sources of oil or oil mist.
- If the product has been dropped or its case is damaged, turn off the power and unplug the power cord from the power outlet.

### **CAUTION**

- Ensure that the product is installed at least 100 mm away from the wall for good ventilation to prevent deformation of the product or a fire due to the increase in the internal temperature.
- Keep the product away from direct sunlight.
- Do not install the product close to hot objects, such as lights.
- Make sure the air vents are not blocked by a tablecloth or curtain.
- Do not install the product near magnetic field generating equipment, such as transformers or high-voltage power lines.

Installing the product in locations that do not meet the general conditions may seriously damage the product's picture quality, life cycle and appearance. Please check with our service engineer before installing in such locations.

**Locations that do not meet the general conditions:** places where the product is not intended for use, such as those where fine dust or oil mist is generated, places where chemicals are used, places where the temperature is too high or low, places where the humidity is too high, or places where the product is likely to be used for a long period of time (e.g. airports or train stations).

## Precautions for the AC/DC Adaptor and Power



### WARNING

- If water or a foreign substance enters the product (power cord or AC/DC adaptor), disconnect the power cord immediately and contact the manufacturer.
- Always connect the power cord to a grounded outlet.
- Do not touch the power plug or AC/DC adaptor with wet hands. If the pins of the plug are wet or dusty, clean and dry them before use.
- Insert the power plug securely so that it does not come loose. Do not use the product if the power outlet is loose.
- Make sure the power cord is fully inserted into the AC/DC adaptor.
- Do not insert any conductive objects into the device connection end of the power cord, while the power cord is inserted into the wall outlet. Avoid touching the power plug immediately after pulling from the wall outlet.
- Be sure to use the power cords and AC/DC adaptors provided or ones approved by LG Electronics, Inc.
- Use the product at the rated voltage only.
- Disconnect the power cable when not using the product for long periods.
- Always pull by the plug when unplugging the power cord. Do not bend the power cord with excessive force.
- Take care not to step on or place heavy objects (electronic appliances, clothing, etc.) on the power cord or AC/DC adaptor. Be careful not to damage the power cord or AC/DC adaptor with sharp objects.
- Never disassemble, repair or modify the power cord or AC/DC adaptor.
- To turn off the main power, remove the power cord, which should be positioned so it is easy to access for operation.
- If the product is connected to an AC wall outlet, it will not be disconnected from the AC power source even if you turn off the switch.



### CAUTION

- Do not remove the power cord when the product is in use.
- Be sure to keep the outlet, AC/DC adaptor and pins of the power plug clean from dust, etc.
- Do not turn the monitor on or off by plugging in or unplugging the power plug from the power outlet. (Do not use the power plug as a switch.)
- Keep the power cord away from heating devices.

## Precautions When Transporting the Product



### WARNING

- Before moving the product, disconnect the power cord and all other connected cables.
- When carrying the product, make sure the screen faces forward and hold it firmly in both hands.

 **CAUTION**

- Do not discard the delivery box with the original packaging. Put the product in the box when carrying.
- When moving or unpacking the product, make sure that two or more people safely lift it because it is heavy. Using the product after it has fallen may result in electric shock or fire. Contact the manufacturer.

## Precautions When Using the Product

 **WARNING**

- Do not disassemble, repair or modify the product by yourself. If the product needs to be checked, reset or repaired, contact the manufacturer.
- Do not allow water to enter the product and keep the product dry at all times.
- If there is a gas leak, do not touch the power outlet. Open the windows for ventilation.
- Do not impact the front or sides of the screen with a hard object, such as a metal object. Do not scratch the screen.
- If liquid or a foreign object falls into the product, switch the product off and unplug it from the wall outlet. Contact the manufacturer.
- Stop using the product if no image appears on the screen or no sound is heard. Switch the product off immediately. Unplug the product from the power outlet and contact the manufacturer.
- Do not use the product in any environment with excessively high temperatures or humidity.
- Do not use high-voltage electrical products near the product. This may result in product malfunction due to electric shock. (e.g. electrical mosquito swatter)

 **CAUTION**

- Do not use or store the product near inflammables.
- Take a break to protect your health and vision when using the product for long periods of time.
- Do not push hard against the screen surface or scratch it with your hands or sharp objects, such as a nail, pencil or pen.
- Keep the product clean.
- Refer to the Owner's Manual and set the product to the correct resolution and frequency. Otherwise, you may experience blurred vision.
- Do not leave the product where it can get wet. Do not place anything containing liquid on top of the product, such as a flower vase.
- Because the LCD requires high technology consisting of hundreds of pixels, pixelated spots (red, green, white or black) may appear on the screen during use. This is normal for an LCD screen and not an error, nor is it related to the monitor's performance.
- Given the nature of the viewing angle, the brightness and color of the LCD may vary between the left and right or top and bottom, depending on the viewing position. This is normal for an LCD screen and not an error, nor is it related to the monitor's performance.

## Precautions for Connecting to Other Medical Devices

Take the following precautions before using this product or connecting it to other medical devices.

- Stop using this device for medical purposes if you experience interruptions or discomfort in executing medical activities.
- Quick movements, shaking and the focus of the video displayed on the monitor, its distance from the user, the user's point of view, the user's physical fitness and other factors may cause discomfort (eye fatigue, dizziness, vomiting, nausea, etc.).
- Before using the product, check that the image of the connected device displays properly on the screen of this product.

## Recommendation for Using Multiple Units

- Electronic products may fail unexpectedly. If using the monitor for medical, emergency or any other critical use, we strongly recommend that you use multiple monitors or have a spare monitor ready.

## Precautions When Cleaning the Product

The medical LCD monitor's front protective panel may become damaged when using solvents such as thinner or benzene, acidic, alkaline or corrosive detergents, chemical cleaning fibers, etc. and the finish material on the surface.

- Unplug the power cord before cleaning.
- Never spray water directly onto the monitor or use thinner or benzene solvents, acidic, alkaline or corrosive detergents, or cleaning or sterilizing chemical cleaning fibers, etc. as they may damage the product.
- To clean the product, unplug the power cord and wipe it gently with a soft cloth. Do not spray with water or wipe with a wet cloth. When cleaning the product or the screen, do not use cleansers, automobile or industrial thinners, abrasives or wax, benzene, alcohol, etc., as this may damage the product.
- To clean the front frame, spray water onto a soft cloth two to four times and wipe in one direction only.
- Do not rub the product with a stained cloth using more force than necessary. This may scratch the surface of the product.
- Do not allow the product to remain in contact with rubber or vinyl resin for extended periods. The surface finish may deteriorate or the coating may peel off.
- If you do not clean the product, dust will accumulate inside and may create a fire hazard or malfunction.

## Image Sticking Precautions

- Displaying a still image for a prolonged period may damage the screen, resulting in image sticking. Most third-party products have the same issue. Damage resulting from long-term static images is not covered by product warranty.

# LICENSE

Each model has different licenses. Visit [www.lg.com](http://www.lg.com) for more information on the license.



The terms HDMI and HDMI High-Definition Multimedia Interface, and the HDMI logo are trademarks or registered trademarks of HDMI Licensing LLC in the United States and other countries.



VESA, VESA logo, DisplayPort compliance logo and DisplayPort compliance logo for dual-mode source devices are all registered trademarks of the Video Electronics Standards Association.



The SuperSpeed USB Trident logo is a registered trademark of USB Implementers Forum, Inc.

# PRODUCT SPECIFICATIONS

The product specifications are subject to change without prior notice for product improvements.

" ~ " refers to alternating current (AC), " --- " refers to direct current (DC).

LCD Screen	Type	TFT (Thin Film Transistor) LCD (Liquid Crystal Display) Screen	
	Pixel Pitch	0.1554 mm x 0.1554 mm	
Resolution	Maximum resolution	3840 x 2160 @ 60 Hz	
	Recommended resolution		
Video signal	Horizontal frequency	30 kHz to 135 kHz	
	Vertical frequency	56 Hz to 61 Hz	
Input Connectors	HDMI IN1, HDMI IN2, DP(DisplayPort) IN, H/P, USB (SS) 1, 2, USB UP (SS)		
Power Source	Power Rating	19 V --- 3.42 A	
	Power consumption	Max 65 W Sleep Mode: ≤ 0.5 W Off Mode: ≤ 0.3 W	
AC/DC Adaptor	DA-65J19 type, manufactured by Asian Power Devices Inc. (APD) Input: 100-240 V~ 50-60 Hz, 1.5-0.7 A Output: 19 V --- 3.42 A Class I		
Environmental Conditions	Operating Conditions	Temperature	0 °C to 40 °C
		Humidity	0 % to 80 %
		Pressure	700 hPa to 1060 hPa
	Storing Conditions	Temperature	-20 °C to 60 °C
		Humidity	0 % to 85 %
		Pressure	500 hPa to 1060 hPa

Dimensions (mm)	Monitor Size (Width x Height x Depth)	
	With Stand	615.0 x 425.2 x 222.6
	Without Stand	615.0 x 365.1 x 42.7
Weight (without packaging) (kg)	With Stand	6.2
	Without Stand	4.7

# TABLE OF CONTENTS

## ASSEMBLY AND PREPARING----- 18

- Product Composition----- 18
- Supported Drivers and Software----- 19
- Component and Button Description ----- 20
  - How to Use the Joystick Button
  - Input Connector
- Moving and Lifting the Monitor----- 23
- Installing the Monitor ----- 24
  - Assembling the Stand base
  - Arranging Cables
  - Installing on a Table
  - Adjusting the Angle
  - Adjusting the Stand Height
  - Pivot Feature
  - Using the Kensington lock
  - Detaching the Stand Body
  - Installing the wall mount plate
  - Installing on the Wall

## USING THE MONITOR----- 33

- Connecting to a PC----- 33
  - HDMI connection
  - DisplayPort Connection
- Connecting AV Devices----- 34
  - HDMI Connection
- Connecting Peripherals----- 35
  - USB Cable connection - PC
  - Connecting Headphones
- Service only port ----- 36

## USER SETTINGS ----- 37

- Activating the Main Menu ----- 37
  - Main Menu Features
- User Settings----- 38
  - Menu Settings
  - Quick Settings
  - PBP
  - Picture
  - General
  - Reset

## TROUBLESHOOTING ----- 52

## PRODUCT SPECIFICATION ----- 54

- Factory Support Mode ----- 54
  - DisplayPort
  - HDMI
- HDMI Timing (Video) ----- 55
- Power LED----- 55

# ASSEMBLY AND PREPARING

## Product Composition

Please check whether all the components are included in the box before using the product. If there are any missing components, contact the retailer where you purchased the product. Note that the product and related components may look different from those shown here.

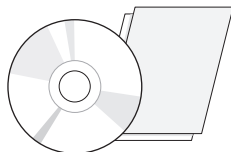

CD (Owner's Manual/Software)/  
Regulatory Manual/Cards



Power Cord

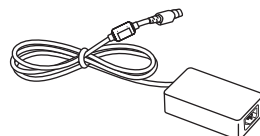

AC/DC Adaptor

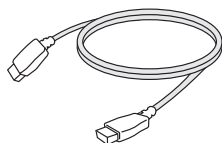

HDMI Cable

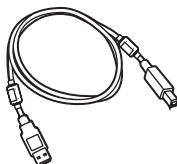

or

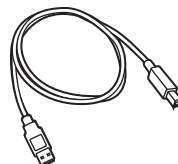

A-B type USB 3.0 Cable



DisplayPort Cable



Cable Holder

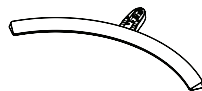

Stand Base

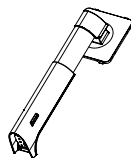

Stand Body

**CAUTION**

- Always use genuine LG components to ensure safety and product performance.
- The product warranty will not cover damage or injury caused by the use of unauthorized components.
- It is recommend that use the supplied components.
- If you use generic cables not certified by LG, the screen may not display or there may be image noises.
- Need to use the authorized components about the below accessories. Unauthorized components may be cause of the damage and malfunction of the product.

Component	Standard
<b>HDMI Cable</b>	Support HDMI 2.0 version, UL, Impedance 100ohm
<b>DisplayPort Cable</b>	Support DISPLAYPORT 1.2a version, UL, Impedance 100ohm
<b>USB 3.0 Cable</b>	Support USB 3.0, UL
<b>Power Cord</b>	US – Approved Medical grade regulation Others – Approved country safety regulation

The AC/DC adaptors and etc. except the upper components need to be used only supplied by manufacturer.

**NOTE**

- The components may look different from those illustrated here.
- Without prior notice, all product information and specifications contained in this manual are subject to change to improve the performance of the product.
- To purchase optional accessories, visit an electronics store or an online shopping site, or contact the retailer from which you purchased the product.
- The power cord provided may differ depending upon the region.

## Supported Drivers and Software

Check the drivers and software supported by your product and refer to the manuals on the CD enclosed in the product package.

Drivers and Software	Installation Priority	27HJ712C
<b>Monitor Driver</b>	Recommended	0
<b>Dual Controller</b>	Optional	0
<b>True Color Pro</b>	Optional	0

- Required and Recommended: You can download and install the latest version from the enclosed CD or from the LGE website ([www.lg.com](http://www.lg.com)).
- Optional: You can download and install the latest version from the LGE website ([www.lg.com](http://www.lg.com)).



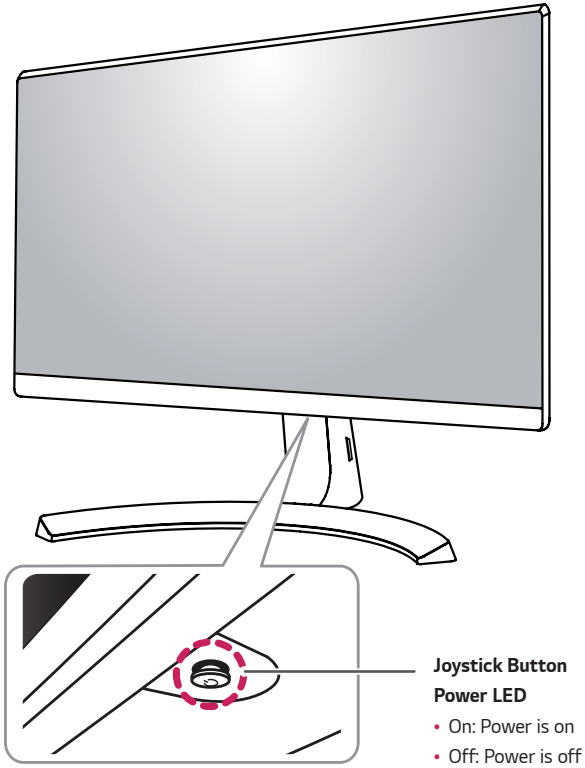

## Component and Button Description



## How to Use the Joystick Button

You can easily control the functions of the monitor by pressing the joystick button or moving it left/right with your finger.

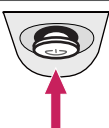
### Basic Functions

		<b>Power on</b>	Press the joystick button once with your finger to turn on the monitor.
		<b>Power off</b>	Press and hold the joystick button once with your finger to turn off the monitor.
		<b>Volume Control</b>	You can control the volume by moving the joystick button left/right.



### NOTE

- The joystick button is located at the bottom of the monitor.

# Input Connector

ENGLISH

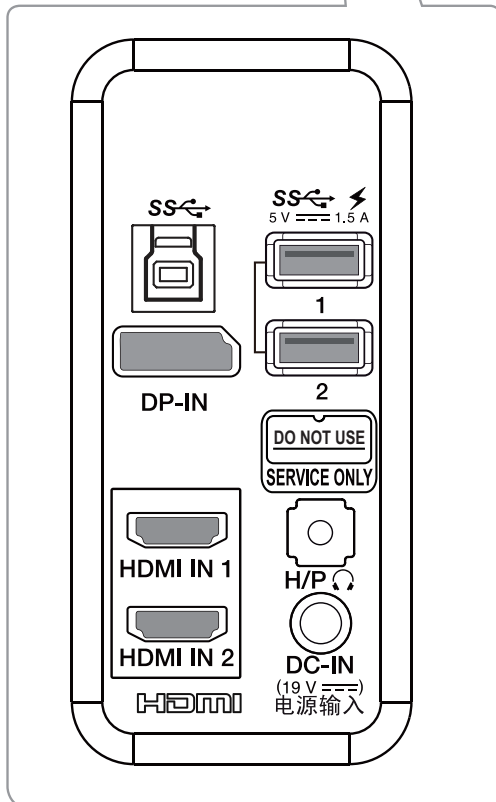
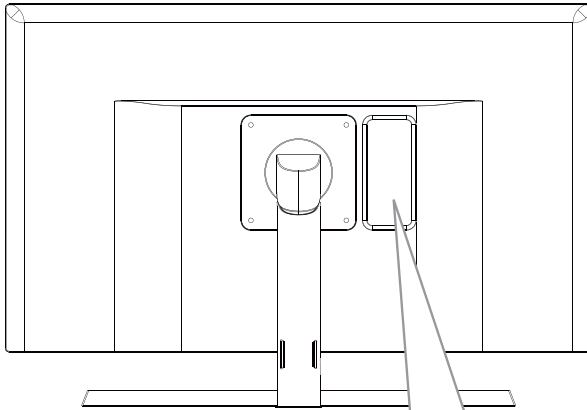

## Moving and Lifting the Monitor

When moving or lifting the monitor, follow these instructions to prevent the monitor from being scratched or damaged and to ensure safe transportation regardless of its shape or size.

- It is advisable to place the monitor in the original box or packing material before attempting to move it.
- Before moving or lifting the monitor, disconnect the power cord and all cables.
- Hold the bottom and side of the monitor frame firmly. Do not hold the panel itself.

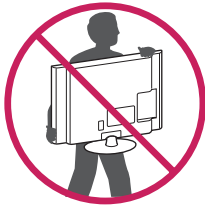
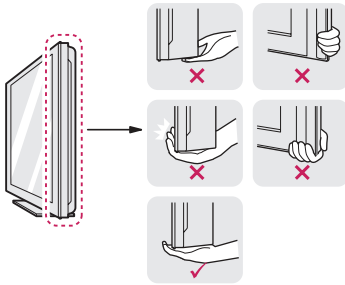

- When holding the monitor, the screen should face away from you to prevent it being scratched.
- When moving the monitor, avoid any strong shock or vibrations to the product.
- When moving the monitor, keep it upright, never turn the monitor on its side or tilt it sideways.

### CAUTION

- As far as possible, avoid touching the monitor screen.
  - This may result in damage to the screen or some of the pixels used to create images.

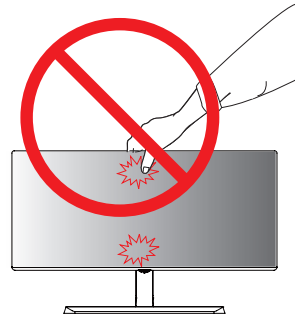

- If you use the monitor panel without the stand base, its joystick button may cause the monitor to become unstable and fall, resulting in damage to the monitor or human injury. In addition, this may cause the joystick button to malfunction.

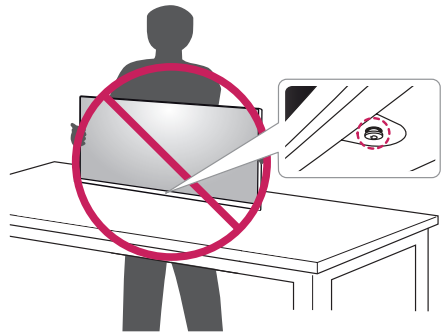

## Installing the Monitor

### Assembling the Stand base

- Illustrations in this document represent typical procedures, so they may look different from the actual product.

1

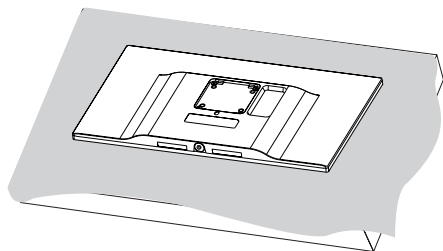

#### CAUTION

- To protect the screen from scratches, cover the surface with a soft cloth.

2

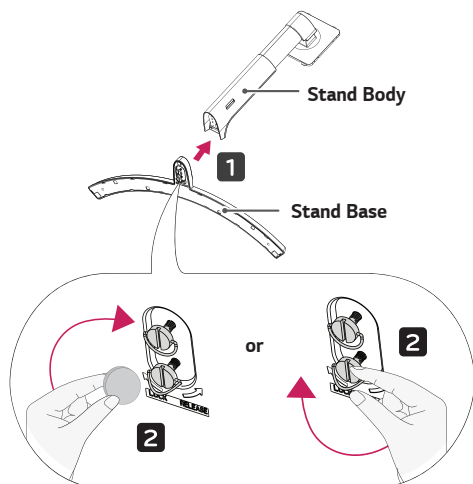

3

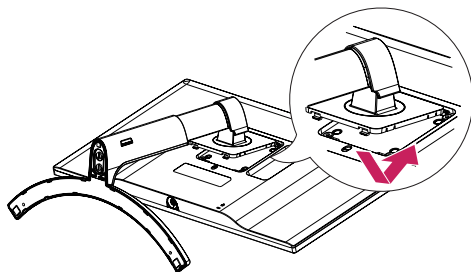

4

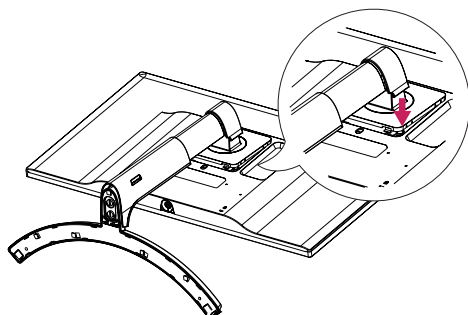

#### NOTE

- Press the stand until the button reaches the top.

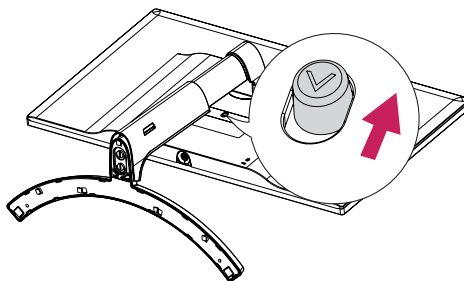



## CAUTION

- Illustrations in this document represent typical procedures, so they may look different from the actual product.
- Do not apply foreign substances (oils, lubricants, etc.) to the screw parts when assembling the product. (Doing so may damage the product.)
- Applying excessive force when tightening screws may cause damage to the monitor. Damage caused in this way will not be covered by the product warranty.
- Do not carry the monitor upside down by just holding the base. This may cause the monitor to fall off the stand and could result in personal injury.
- When lifting or moving the monitor, do not touch the monitor screen. The force applied to the monitor screen may cause damage to it.



## NOTE

- You can disassemble the stand in the reverse order of the assembly.

## Arranging Cables

Arrange the cables using the cable holder as shown in the illustration.

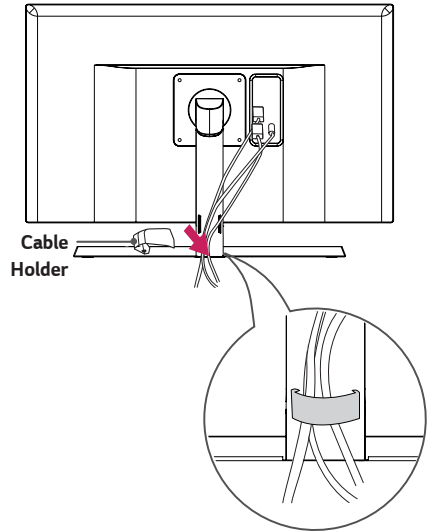

## Installing on a Table

- 1 Lift the monitor and place it on the table in an upright position. Place at least 100 mm away from the wall to ensure sufficient ventilation.

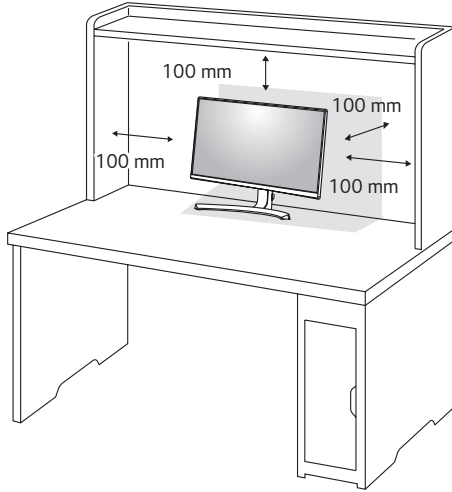

- 2 Connect the power adapter to the monitor and then plug the power cord into the wall outlet.

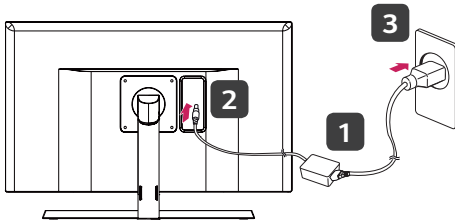

- 3 Press the joystick button on the bottom of the monitor to turn on the monitor.



### CAUTION

- Unplug the power cord prior to moving or installing the monitor. There is risk of electric shock.

### Cautions When Connecting Power Cord

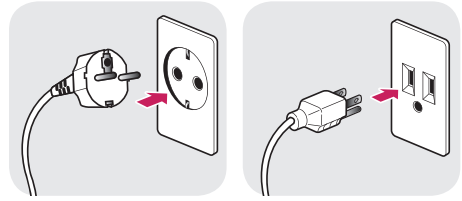

100-240 V ~

- Make sure to use the power cord that is provided in the product package and connect it to a grounded power outlet.
- If you need another power cord, please contact your local dealer or the nearest retail store.

## Adjusting the Angle

- 1 Place the monitor in an upright position, mounted on the stand base.
- 2 Adjust the angle of the screen. The angle of the screen can be adjusted forwards or backwards for a comfortable viewing experience.

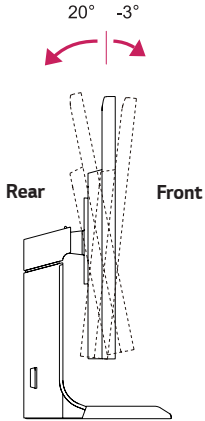

### ! WARNING

- To avoid injury to the fingers when adjusting the screen, do not hold the lower part of the monitor's frame as illustrated below.

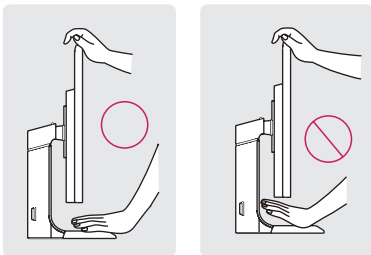

## Adjusting the Stand Height

- 1 Place the monitor mounted on the stand base in an upright position.
- 2 Handle the monitor with both hands for safety.

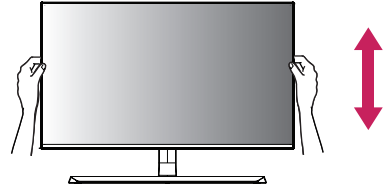

- 3 The height can be adjusted up to 110.0 mm.

110.0 mm

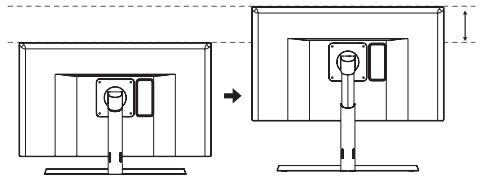

### ! WARNING



- Do not put your fingers or hand between the screen and the base (chassis) when adjusting the screen's height.

## Pivot Feature

The pivot feature allows the monitor to rotate 90° clockwise.

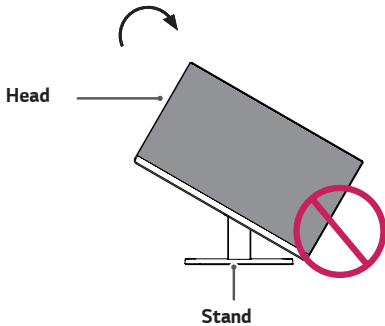

### ! WARNING

- To avoid scratching the stand base, make sure that when rotating the monitor using the pivot feature, the stand does not make contact with the monitor.

1 Raise the monitor to the maximum height.

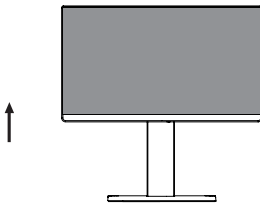

2 Adjust the angle of the monitor in the direction of the arrow as shown in the figure.

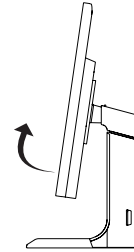

3 Rotate the monitor clockwise as shown in the figure.

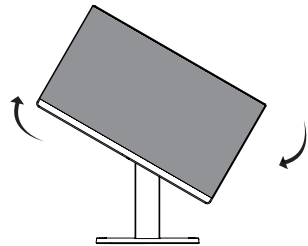

4 Complete the installation by rotating the monitor 90° as shown below.



## ! NOTE

- Auto Pivot feature of the display is not supported.
- The screen can be rotated easily using the screen pivot shortcut key provided with your Windows operating system. Note that some Windows versions and some graphics card drivers may use different settings for the screen pivot key or may not support the pivot key at all.
- Windows screen pivot shortcut keys
  - 0°: Ctrl + Alt + Up arrow key (↑)
  - 90°: Ctrl + Alt + Left arrow key (←)
  - 180°: Ctrl + Alt + Down arrow key (↓)
  - 270°: Ctrl + Alt + Right arrow key (→)

## ! WARNING

- Take care when rotating the monitor if the cable is connected.
- To avoid injury when rotating the display, do not place your fingers between the display and the stand base.

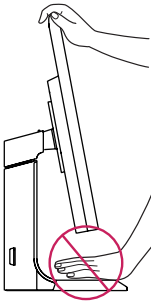

## Using the Kensington lock

The Kensington security system connector is located at the back of the Monitor set.

For more information on installation and usage, refer to the Kensington lock owner's manual or visit the website at <http://www.kensington.com>.

Connect the Kensington security system cable between the Monitor set and a table.

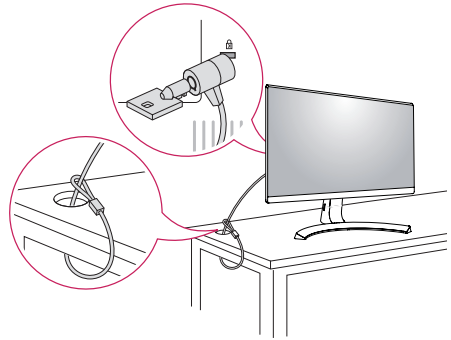

## ! NOTE

- The Kensington security system is optional. You can obtain optional accessories from most electronics stores.

## Detaching the Stand Body

- 1 Place the monitor's screen face down. To protect the screen from scratches, cover the surface with a soft cloth.
- 2 Remove the stand from the monitor by pressing the button on the bottom center of the back of the monitor.

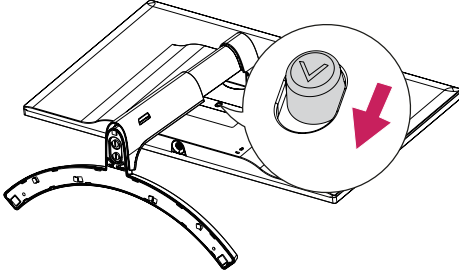

## Installing the wall mount plate

This monitor supports the specification of the standard wall mount plate or compatible device.

- 1 Place the screen face down. To protect the screen from scratches, cover the surface with a soft cloth.
- 2 Using a screwdriver, remove the four screws at the back of the monitor.
- 3 Place the wall mount plate onto the monitor and align it with the screw holes.
- 4 Tighten the four screws to fix the plate to the monitor using a screwdriver.

### **NOTE**

- The wall mount plate is sold separately.
- For more information on installation, refer to the wall mount plate's installation guide.
- Be careful not to use excessive force when mounting the wall mount plate, as this can damage the monitor's screen.

## Installing on the Wall

Install the monitor at least 100 mm away from the wall and leave about 100 mm of space at each side of the monitor to ensure sufficient ventilation. Detailed installation instructions can be obtained from your local retail store. Alternatively, please refer to the manual for how to install and set up a tilting wall mounting bracket.

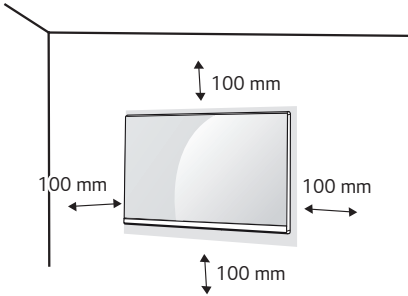

To install the monitor to a wall, attach a wall mounting bracket (optional) to the back of the monitor. Make sure that the wall mounting bracket is securely fixed to the monitor and to the wall.

- 1 If you use screw longer than standard, the monitor might be damaged internally.
- 2 If you use improper screw, the product might be damaged and drop from mounted position. In this case, LG Electronics is not responsible for it.

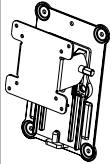
<b>Wall Mount (mm)</b>	100 x 100
<b>Standard screw</b>	M4 x L10
<b>Number of screws</b>	4
<b>Wall Mount Plate (Optional)</b>	RW120 

### ! NOTE

- Use the screws specified by the VESA standard.
- The wall mount kit includes the installation guide and all necessary parts.
- The wall mounting bracket is optional. The accessories can be purchased at your local retail store.
- The length of the screw may differ for each wall mounting bracket. Ensure the correct length screw is used.
- For more information, please refer to the user manual for the wall mounting bracket.

**CAUTION**

- Unplug the power cord before moving or installing the monitor to avoid electric shocks.
- Installing the monitor on the ceiling or on a slanted wall may result in the monitor falling off, which could lead to injury. Please use the genuine LG wall mounting bracket. For more information, contact your local retail store or a qualified installer.
- Applying excessive force when fastening screws may cause damage to the monitor. Damage caused in this way will not be covered by the product warranty.
- Use the wall mounting bracket and screws that confirm to the VESA standard. Damage caused by the use or misuse of inappropriate components will not be covered by the product warranty.
- Screw length from outer surface of back cover should be under 8 mm.

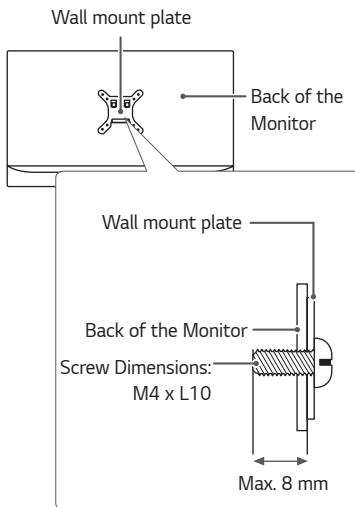

# USING THE MONITOR

## CAUTION

- Make sure to use the supplied HDMI cable of the product. Otherwise, this may cause the device to malfunction.
- Connecting your PC to the monitor using the HDMI cable may cause device compatibility issues.
- Using a DVI to HDMI / DP (DisplayPort) to HDMI cable may cause compatibility issues.
- Use a certified cable with the HDMI logo attached. If you do not use a certified HDMI cable, the screen may not display or a connection error may occur.
- Recommended HDMI cable types
  - High-Speed HDMI®/™ Cable
  - High-Speed HDMI®/™ Cable with Ethernet

## Connecting to a PC

- This monitor supports the \*Plug and Play feature.

\* Plug and Play: A feature that allows you to add a device to your computer without having to reconfigure anything or install any manual drivers.

### HDMI connection

Transmits digital video and audio signals from your PC to the monitor. Connect your PC to the monitor using the HDMI cable as shown in the illustration below.

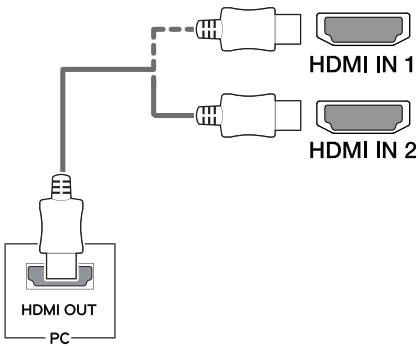

## DisplayPort Connection

Transmits digital video and audio signals from your PC to the monitor. Connect the monitor to your PC using the DisplayPort cable as shown in the illustration below.

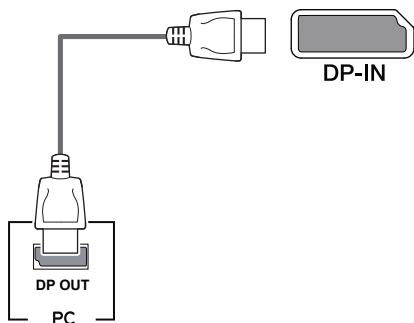

### ! NOTE

- There may be no video or audio output depending on the DP (DisplayPort) version of the PC.
- Make sure to use the supplied DisplayPort cable of the product. Otherwise, this may cause the device to malfunction.
- If you use generic cables not certified by LG, the screen may not display or there may be image noises.

## Connecting AV Devices

### HDMI Connection

HDMI transmits digital video and audio signals from your AV device to the monitor. Connect your AV device to the monitor using the HDMI cable as shown in the illustration below.

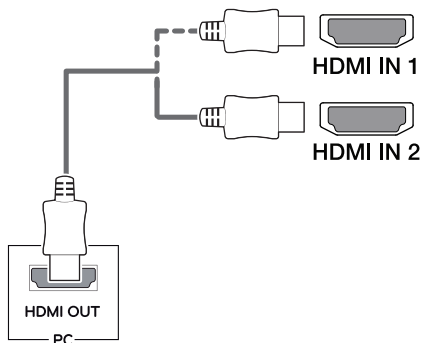

### ! NOTE

- Make sure to use the supplied HDMI cable of the product. Otherwise, this may cause the device to malfunction.
- Using a DVI to HDMI / DP (DisplayPort) to HDMI cable may cause compatibility issues.
- Use a certified cable with the HDMI logo attached. If you do not use a certified HDMI cable, the screen may not display or a connection error may occur.
- Recommended HDMI cable types
  - High-Speed HDMI®/™ Cable
  - High-Speed HDMI®/™ Cable with Ethernet

## Connecting Peripherals

### USB Cable connection - PC

The USB port on the product functions as a USB hub.

#### NOTE

- Make sure to install the most recent Windows OS service pack before using the product.
- Peripheral devices are sold separately.
- A keyboard, mouse, or USB device can be connected to the USB port.
- Go to **General > Quick Charge** to set **Quick Charge** to **On** or **Off**.
- The charging speed may vary depending on the device.

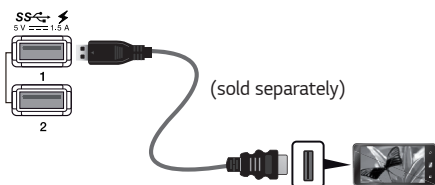

### HDMI/DP (DisplayPort) connection

To use USB 3.0, connect the A-B type USB 3.0 cable of the product to the PC.

Peripheral devices connected to the USB IN port can be controlled from the PC.

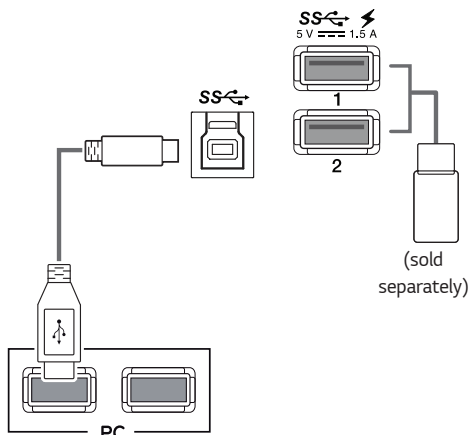

#### CAUTION

Cautions When Using a USB Device

- A USB device with an automatic recognition program installed, or that uses its own driver, may not be recognized.
- Some USB devices may not be supported or may not work properly.
- It is recommended to use a USB hub or hard disk drive with power supplied. (If the power supply is not adequate, the USB device may not be recognized properly.)

## Connecting Headphones

Connect peripherals to the monitor via the headphones port. Connect as illustrated.

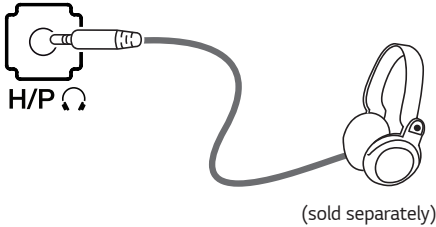

### ! NOTE

- Peripheral devices are sold separately.
- If you use angled earphones, it may cause a problem with connecting another external device to the monitor. Therefore, it is recommended to use straight earphones.



Angled



Straight

- Depending on the audio settings of the PC and external device, headphones and speaker functions may be limited.

## Service only port

The port is used only for "Service".



# USER SETTINGS

## Activating the Main Menu

- 1 Press the joystick button on the bottom of the monitor.
- 2 Move the joystick up/down (▲/▼), and left/right (◀/▶) to set the options.
- 3 Press the joystick button once more to exit the main menu.

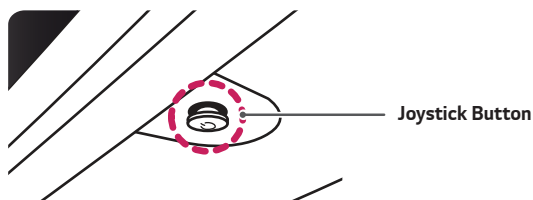

Button	Menu Status	Description
	<b>Main menu disabled</b>	Enables the main menu.
	<b>Main menu enabled</b>	Exits the main menu. (Holding down the button to turn off the monitor: You can turn off the monitor this way at any time, including when the OSD is on.)
	◀ <b>Main menu disabled</b>	Adjusts the monitor volume level.
	◀ <b>Main menu enabled</b>	Enters the <b>Menu</b> features.
	▶ <b>Main menu disabled</b>	Adjusts the monitor volume level.
	▶ <b>Main menu enabled</b>	Enters the <b>Input</b> feature.
	▲ <b>Main menu disabled</b>	Enables the main menu.
	▲ <b>Main menu enabled</b>	Enters the <b>Picture Mode</b> feature.
	▼ <b>Main menu disabled</b>	Enables the main menu.
	▼ <b>Main menu enabled</b>	Turns off the monitor.

## Main Menu Features

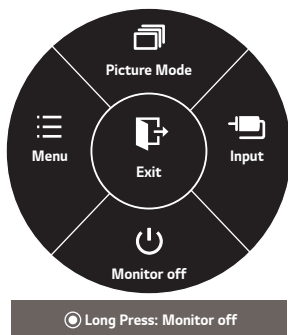

Main Menu	Description
Menu	Configures the screen settings.
Picture Mode	Optimizes the screen for picture mode.
Input	Sets input mode.
Monitor off	Turns off the monitor.
Exit	Exits the main menu.

## User Settings

### Menu Settings

- 1 To view the OSD menu, press the joystick button at the bottom of the monitor and then enter the **Menu**.
  - 2 Configure the options by moving the joystick up/down/left/right.
  - 3 To return to the upper menu or set other menu items, move the joystick to ◀ or pressing (Ⓞ/Ok) it.
  - 4 If you want to exit the OSD menu, move the joystick to ◀ until you exit.
- When you enter the menu, instructions on how to use the button will appear in the bottom right corner of the screen.



Quick Settings



PBP



Picture



General



Reset

Each option is described below.

Menu		Description
Quick Settings	Brightness	Adjusts the color contrast and brightness of the screen.
	Contrast	
	Volume	Adjusts the volume level.
		 <b>NOTE</b> • You can adjust <b>Mute/ Unmute</b> by moving the joystick button to ▼ in the <b>Volume</b> menu.
	Input	Selects the input mode.
	Ratio	Adjusts the aspect ratio of the screen.
PBP	PBP	Displays the screens of two input modes on one monitor.
Picture	Picture Mode	Changes the picture mode to the one optimized for a given feature.
	Picture Adjust	Adjusts the <b>Brightness Stabilization, SUPER RESOLUTION+, Sharpness, Black Level, HDMI ULTRA HD Deep Color, DFC, Response Time, Black Stabilizer, and Uniformity.</b>
	Color Adjust	Adjusts the <b>Gamma, Color Temp, and Six Color.</b>
General		Sets <b>Language, SMART ENERGY SAVING, Power LED, Automatic Standby, DisplayPort 1.2, Quick Charge, Buzzer, and OSD Lock.</b>
Reset		Restores the default settings.
◀	Exit	Exits the OSD menu.



## CAUTION

- Your monitor's OSD (On Screen Display) may differ slightly from that shown in this manual.

## Quick Settings

- 1 To view the OSD menu, press the joystick button at the bottom of the monitor and then enter the **Menu**.
- 2 Go to **Quick Settings** by moving the joystick.
- 3 Configure the options following the instructions that appear in the bottom right corner.
- 4 To return to the upper menu or set other menu items, move the joystick to ◀ or pressing (○/Ok) it.
- 5 If you want to exit the OSD menu, move the joystick to ◀ until you exit .

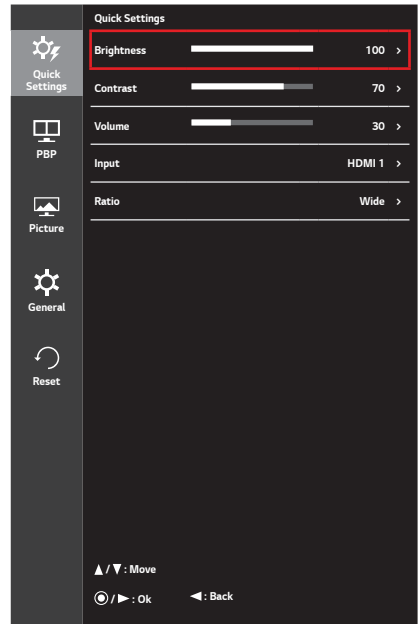

Each option is described below.

Menu > Quick Settings	Description
<b>Brightness</b>	<p>Adjusts the brightness of the screen.</p> <p><b>NOTE</b></p> <ul style="list-style-type: none"> <li>• You can adjust the <b>Brightness Stabilization</b> to <b>On/ Off</b> by pressing the ▼ button in the <b>Brightness</b> menu.</li> <li>• When the <b>Brightness Stabilization</b> is <b>On</b>, <b>Brightness</b> menus become disabled.</li> <li>• When the <b>Brightness Stabilization</b> is <b>On</b>, <b>SMART ENERGY SAVING</b> and <b>DFC</b> menus become disabled.</li> </ul>
<b>Contrast</b>	Adjusts the color contrast of the screen.

Menu > Quick Settings	Description	
<b>Volume</b>	Adjusts the volume level.   <b>NOTE</b> <ul style="list-style-type: none"> <li>You can adjust <b>Mute/ Unmute</b> by moving the joystick button to ▼ in the <b>Volume</b> menu.</li> </ul>	
<b>Input</b>	Selects the input mode.	
<b>Ratio</b>	Adjusts the aspect ratio of the screen.	
	<b>Wide</b>	Displays the video in widescreen, regardless of the video signal input.
	<b>Original</b>	Displays video according to the aspect ratio of the video signal input.
	<b>1:1</b>	The aspect ratio is not adjusted from the original.

 **NOTE**

- The display may look the same for **Wide**, **Original**, and **1:1** options at the recommended resolution (3840 x 2160).
- The ratio is disabled in the interlaced signal.

## PBP

- 1 To view the OSD menu, press the joystick button at the bottom of the monitor and then enter the **Menu**.
- 2 Go to **PBP** by moving the joystick.
- 3 Configure the options following the instructions that appear in the bottom right corner.
- 4 To return to the upper menu or set other menu items, move the joystick to ◀ or pressing (●/Ok) it.
- 5 If you want to exit the OSD menu, move the joystick to ◀ until you exit .

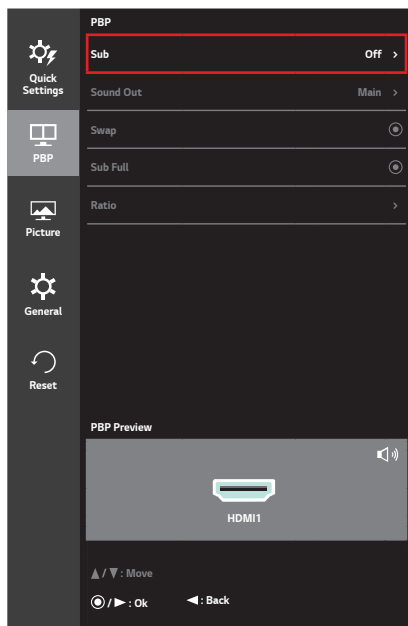

Each option is described below.

Menu > PBP	Description				
<b>Sub</b>	Displays the screens of two input modes on one monitor.				
	<b>PBP Connection</b>		<b>Sub Screen (Right)</b>		
			<b>HDMI 1</b>	<b>HDMI 2</b>	<b>DisplayPort</b>
	<b>Main Screen (Left)</b>	<b>HDMI 1</b>	X	X	O
<b>HDMI 2</b>		X	X	O	
	<b>DisplayPort</b>	O	O	X	
<b>Sound Out</b>	Changes the audio output in <b>PBP</b> mode.				
	<b>Main</b>	Selects the input for <b>Main</b> .			
	<b>Sub</b>	Selects the input for <b>Sub</b> .			
<b>Swap</b>	Toggles between the main screen and sub screen in <b>PBP</b> mode.				
<b>Sub Full</b>	Converts the sub screen in <b>PBP</b> mode to wide screen.				

Menu > PBP	Description		
<b>Ratio</b>	Adjusts the aspect ratio of the main screen or sub screen.		
	<b>Main</b>	<b>Wide</b>	Displays the video to fit the PBP screen, regardless of the video signal input.
		<b>Original</b>	Displays the video in the aspect ratio of the video signal input on the PBP screen.
	<b>Sub</b>	<b>Wide</b>	Displays the video to fit the PBP screen, regardless of the video signal input.
<b>Original</b>		Displays the video in the aspect ratio of the video signal input on the PBP screen.	

 **NOTE**

- When the **Sub** mode is **Off**, **Sound Out**, **Swap**, **Sub Full**, and **Ratio** menus become disabled. The **Main / Sub** options for **Ratio** become disabled if there is no signal.
- The optimal resolution for **PBP** mode is set automatically when **PBP** mode is set.

## Picture

- 1 To view the OSD menu, press the joystick button at the bottom of the monitor and then enter the **Menu**.
- 2 Go to **Picture** by moving the joystick.
- 3 Configure the options following the instructions that appear in the bottom right corner.
- 4 To return to the upper menu or set other menu items, move the joystick to ◀ or pressing (●/Ok) it.
- 5 If you want to exit the OSD menu, move the joystick to ◀ until you exit .

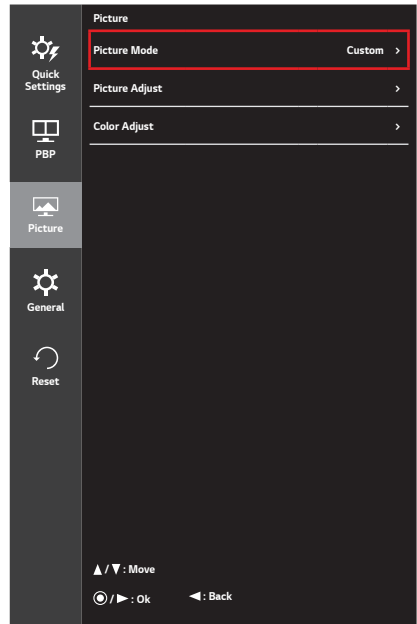

Each option is described below.

Menu > Picture	Description	
Picture Mode	Custom	Allows the user to adjust each element. The color mode of the main menu can be adjusted.
	Mono	Mono (black and white) color mode.
	Reader	Optimizes the screen for viewing documents. You can brighten the screen in the OSD menu.
	sRGB	A standard RGB color space for the monitor and printer.
	Color Weakness	This mode is for users who cannot distinguish between red and green. It enables users with color weakness to easily distinguish between the two colors.

Menu > Picture	Description		
<b>Picture Mode</b>	<b>EBU</b>	A standard TV PAL color space for broadcasting.	
	<b>REC709</b>	A standard HDTV color space for broadcasting.	
	<b>SMPTE-C</b>	A standard TV NTSC color space for broadcasting.	
	<b>DICOM</b>	A mode optimized for viewing medical images. You can brighten the screen in the OSD menu.	
	<b>Calibration 1</b>	Adjusts to the last calibrated screen.	
	<b>Calibration 2</b>	Adjusts to the previously calibrated screen.	
<div style="display: flex; align-items: center;">  <div> <p><b>NOTE</b></p> <ul style="list-style-type: none"> <li>• If the <b>Picture Mode</b> is changed in the DP (DisplayPort) input, the screen may flicker or the resolution of your PC screen may be affected.</li> <li>• <b>Calibration 2:</b> Installation of TRUE COLOR PRO and proceeding Calibration will enable this menu.</li> </ul> </div> </div>			
<b>Picture Adjust</b>	<b>Brightness Stabilization</b>	Maintains the brightness configured for medical environments.	
		<b>On</b>	Adjusts the brightness automatically.
	<b>Off</b>	Deactivates the function, and allows the user to configure the brightness.	
	<b>SUPER RESOLUTION+</b>	<b>High</b>	Optimized picture quality is displayed when a user wants crystal clear images. It is effective for high quality video or game.
		<b>Middle</b>	The optimized picture quality is displayed when a user wants images between low and high modes for comfortable viewing. It is effective for UCC or SD video.
		<b>Low</b>	The optimized picture quality is displayed when a user wants smooth and natural images. It is effective for slow-moving pictures or still images.
		<b>Off</b>	Select this option for everyday viewing. <b>SUPER RESOLUTION+</b> is turned off in this mode.

Menu > Picture	Description					
Picture Adjust	<b>Sharpness</b>		Adjusts the sharpness of the screen.			
	<b>Black Level</b>		Sets the offset level (for HDMI only). • Offset: as a reference for a video signal, this is the darkest color the monitor can display.			
			<b>High</b>	Keeps the current contrast ratio of the screen.		
			<b>Low</b>	Lowers the black levels and raises the white levels from the current contrast ratio of the screen.		
	<b>HDMI ULTRA HD Deep Color</b>		Provides sharper images when connected to a device supporting ULTRA HD Deep Color.			
			<b>4K@ 60 Hz Support Format<sup>1)</sup></b>			
			<b>Resolution</b>	<b>Frame rate(Hz)</b>	<b>Color Depth / Chroma Sampling</b>	
					<b>8 bit</b>	<b>10 bit</b>
			3840 x 2160	59.94	YCbCr 4:2:0	
					YCbCr 4:2:2	
60.00				YCbCr 4:4:4	-	
	RGB 4:4:4	-				
		1) Supported when <b>HDMI ULTRA HD Deep Color</b> is set to <b>On</b> .				
		 <b>NOTE</b> <ul style="list-style-type: none"> <li>• If the connected device does not support ULTRA HD Deep Color, the feature may not work properly.</li> <li>• If a problem occurs, set the <b>HDMI ULTRA HD Deep Color</b> option to <b>Off</b>.</li> </ul>				
<b>DFC</b>		<b>On</b>	Adjusts the brightness automatically according to the screen.			
		<b>Off</b>	Disables the <b>DFC</b> .			

Menu > Picture	Description		
Picture Adjust	Response Time	<p>Sets a response time for displayed pictures based on the speed of the screen.</p> <p>For a normal environment, it is recommended that you use <b>Middle</b>. For a fast-moving picture, it is recommended that you use <b>High</b>.</p> <p>Setting to <b>High</b> may cause image sticking.</p>	
		High	Sets the response time to High.
		Middle	Sets the response time to Middle.
		Low	Sets the response time to Low.
		Off	Does not use the response time improvement feature.
	Black Stabilizer	<p>You can control the black contrast to have better visibility in dark scenes.</p> <p>Increasing the <b>Black Stabilizer</b> value brightens the low gray level area on the screen. (You can easily distinguish objects on dark game screens.)</p> <p>Reducing the <b>Black Stabilizer</b> value darkens the low gray level area and increases the dynamic contrast on the screen.</p>	
	Uniformity	<p>Adjusts the uniformity of screen brightness.</p> <p> <b>NOTE</b></p> <ul style="list-style-type: none"> <li>Enabling <b>Uniformity</b> may reduce the overall brightness of the image.</li> </ul>	
		On	Enables the <b>Uniformity</b> feature.
		Off	Disables the <b>Uniformity</b> feature.

Menu > Picture	Description		
<b>Color Adjust</b>	<b>Gamma</b>	<p>Custom gamma settings: <b>Gamma 1.8, Gamma 2.0, Gamma 2.2, Gamma 2.4, Gamma 2.6, DICOM Gamma Curve, Off.</b></p> <p>The higher the gamma value, the darker the image becomes. Likewise, the lower the gamma value, the lighter the image becomes.</p>	
	<b>Color Temp</b>	<b>Manual</b>	Adjusts the color temperature in 500K increments. (Note that 9300K is supported rather than 9500K.)
		<b>Custom</b>	The user can customize the red, green and blue color.
		<b>6500K</b>	Sets the picture color to the color temperature of a reddish 6500K.
		<b>8500K</b>	Sets the picture color to the color temperatures of 8500K, setting to a color between red and blue.
		<b>9300K</b>	Sets the picture color to the color temperature of a bluish 9300K.
<b>Color Adjust</b>	<b>Red</b>	You can customize the picture color using red, green and blue.	
	<b>Green</b>		
	<b>Blue</b>		
	<b>Six Color</b>	Fulfills your color requirements by adjusting the hue and saturation of the six colors (red, green, blue, cyan, magenta and yellow). The settings are then saved.	
		<b>Hue</b>	Adjusts the tone of the screen colors.
	<b>Saturation</b>	Adjusts the saturation of the screen colors. The lower the value, the less saturated and brighter the colors become. The higher the value, the more saturated and darker the colors become.	
	<b>Reset</b>	Returns the colors to the default settings.	

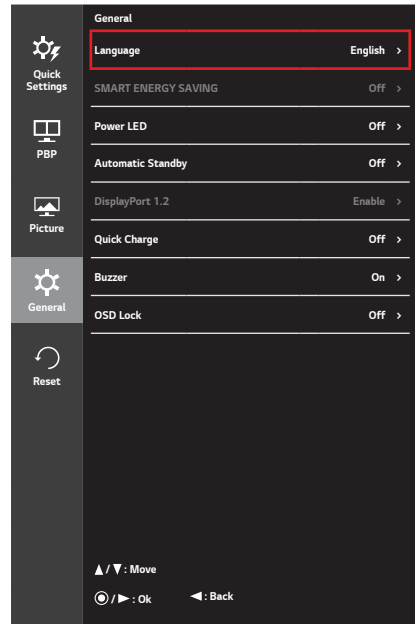

## General

- 1 To view the OSD menu, press the joystick button at the bottom of the monitor and then enter the **Menu**.
- 2 Go to **General** by moving the joystick.
- 3 Configure the options following the instructions that appear in the bottom right corner.
- 4 To return to the upper menu or set other menu items, move the joystick to ◀ or pressing (●/Ok) it.
- 5 If you want to exit the OSD menu, move the joystick to ◀ until you exit .



Each option is described below.

Menu > General	Description	
<b>Language</b>	Sets the menu screen to the desired language.	
<b>SMART ENERGY SAVING</b>	<b>High</b>	Saves energy using the high-efficiency <b>SMART ENERGY SAVING</b> feature.
	<b>Low</b>	Saves energy using the low-efficiency <b>SMART ENERGY SAVING</b> feature.
	<b>Off</b>	Disables the <b>SMART ENERGY SAVING</b> feature.
<b>Power LED</b>	Turns the power LED on the front of the monitor <b>On</b> or <b>Off</b> .	
	<b>On</b>	The power LED turns on automatically.
<b>Off</b>	The power LED turns off.	
<b>Automatic Standby</b>	Feature that automatically turns off the monitor when there is no movement on the screen for a period of time. You can set a timer for the auto-off function. ( <b>Off</b> , <b>4 H</b> , <b>6 H</b> , and <b>8 H</b> )	

Menu > General	Description					
<b>DisplayPort 1.2</b>	Enables or disables DisplayPort 1.2.   <b>NOTE</b> <ul style="list-style-type: none"> <li>• Be sure to configure this option according to the DisplayPort version supported by your graphics card. Set this option to <b>Disable</b> if your graphics card does not support DisplayPort 1.2.</li> <li>• When <b>DisplayPort 1.2</b> is disabled, you cannot use the 10-bit output of your video card.</li> </ul>					
<b>Quick Charge</b>	<b>Quick Charge</b> is a feature that rapidly charges the device connected to the USB 3.0 port.  <table border="1" data-bbox="296 448 408 531"> <tr> <td data-bbox="296 448 408 491"><b>On</b></td> <td data-bbox="408 448 1057 491">Enables <b>Quick Charge</b>.</td> </tr> <tr> <td data-bbox="296 491 408 531"><b>Off</b></td> <td data-bbox="408 491 1057 531">Disables <b>Quick Charge</b>.</td> </tr> </table>		<b>On</b>	Enables <b>Quick Charge</b> .	<b>Off</b>	Disables <b>Quick Charge</b> .
<b>On</b>	Enables <b>Quick Charge</b> .					
<b>Off</b>	Disables <b>Quick Charge</b> .					
<b>Buzzer</b>	This feature lets you set the sound generated from <b>Buzzer</b> when your monitor powers on to <b>On</b> or <b>Off</b> .  <table border="1" data-bbox="296 595 408 675"> <tr> <td data-bbox="296 595 408 635"><b>On</b></td> <td data-bbox="408 595 1057 635">Enables your monitor's <b>Buzzer</b>.</td> </tr> <tr> <td data-bbox="296 635 408 675"><b>Off</b></td> <td data-bbox="408 635 1057 675">Disables your monitor's <b>Buzzer</b>.</td> </tr> </table>		<b>On</b>	Enables your monitor's <b>Buzzer</b> .	<b>Off</b>	Disables your monitor's <b>Buzzer</b> .
<b>On</b>	Enables your monitor's <b>Buzzer</b> .					
<b>Off</b>	Disables your monitor's <b>Buzzer</b> .					
<b>OSD Lock</b>	This feature disables the configuration and adjustment of menus.  <table border="1" data-bbox="296 715 408 786"> <tr> <td data-bbox="296 715 408 754"><b>On</b></td> <td data-bbox="408 715 1057 754">Enables <b>OSD Lock</b>.</td> </tr> <tr> <td data-bbox="296 754 408 786"><b>Off</b></td> <td data-bbox="408 754 1057 786">Disables <b>OSD Lock</b>.</td> </tr> </table>  <b>NOTE</b> <ul style="list-style-type: none"> <li>• All features are disabled except <b>Brightness, Contrast, Volume, Input</b> in <b>Quick Settings</b>, and <b>OSD Lock</b> in <b>General</b>.</li> </ul>		<b>On</b>	Enables <b>OSD Lock</b> .	<b>Off</b>	Disables <b>OSD Lock</b> .
<b>On</b>	Enables <b>OSD Lock</b> .					
<b>Off</b>	Disables <b>OSD Lock</b> .					

## Reset

- 1 To view the OSD menu, press the joystick button at the bottom of the monitor and then enter the **Menu**.
- 2 Go to **Reset** by moving the joystick.
- 3 Configure the options following the instructions that appear in the bottom right corner.
- 4 To return to the upper menu or set other menu items, move the joystick to ◀ or pressing (●/Ok) it.
- 5 If you want to exit the OSD menu, move the joystick to ◀ until you exit .

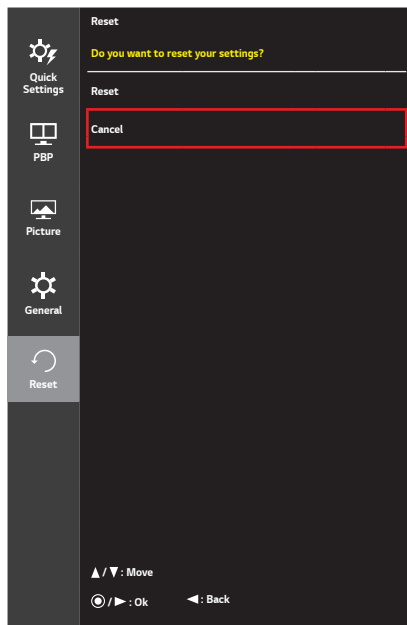

Each option is described below.

Menu > Reset	Description
<b>Do you want to reset your settings?</b>	
<b>Reset</b>	Restores the default settings.
<b>Cancel</b>	Cancel the reset.

# TROUBLESHOOTING

<b>Nothing is displayed on the screen.</b>	
Is the monitor's power cord plugged in?	<ul style="list-style-type: none"> <li>• Check if the power cord is correctly plugged into the power outlet.</li> </ul>
Is the power LED on?	<ul style="list-style-type: none"> <li>• Check the power cable connection and press the power button.</li> </ul>
Is the power on and the power LED displaying white?	<ul style="list-style-type: none"> <li>• Check that the connected input is enabled (<b>Menu &gt; Quick Settings &gt; Input</b>).</li> </ul>
Is the power LED blinking?	<ul style="list-style-type: none"> <li>• If the monitor is in sleep mode, move the mouse, or press any key on the keyboard, to switch the display on.</li> <li>• Check if the computer is turned on.</li> </ul>
Is the <b>OUT OF RANGE</b> message being displayed?	<ul style="list-style-type: none"> <li>• This occurs when signals transferred from the PC (graphics card) are out of the horizontal or vertical frequency range of the monitor. Please see the Product Specification section of this manual to set the appropriate frequency.</li> </ul>
Is the <b>No Signal</b> message being displayed?	<ul style="list-style-type: none"> <li>• This is displayed when the signal cable between the PC and the monitor is missing or disconnected. Check the cable and reconnect it.</li> </ul>

<b>The OSD Lock message is being displayed.</b>	
Are some functions not available when you press the Menu button?	<ul style="list-style-type: none"> <li>• The OSD is locked. Go to <b>Menu &gt; General</b> and set <b>OSD Lock</b> to <b>Off</b>.</li> </ul>

<b>The screen retains an image.</b>	
Does image sticking occur even when the monitor is turned off?	<ul style="list-style-type: none"> <li>• Displaying a still image for a prolonged time may cause damage to the screen, resulting in the retention of the image.</li> <li>• To extend the lifetime of the monitor, use a screensaver.</li> </ul>

<b>Screen display is unstable and shaky. / Images displayed on the monitor leave shadow trails.</b>	
Did you select the appropriate resolution?	<ul style="list-style-type: none"> <li>• If the selected resolution is HDMI 1080i 60/50 Hz (interlaced), the screen may be flickering. Change the resolution to 1080p or the recommended resolution.</li> </ul>

 **NOTE**

- **Vertical Frequency:** In order to display an image, the screen must be refreshed dozens of times per second, like a fluorescent lamp. The number of times the screen is refreshed per second is called vertical frequency, or refresh rate, and is represented by Hz.
- **Horizontal Frequency:** The time it takes to display one horizontal line is called the horizontal cycle. If 1 is divided by the horizontal interval, the result is the number of horizontal lines displayed per second. This is called horizontal frequency and is represented by kHz.
- Check if the graphics card's resolution or frequency is within the range allowed by the monitor and set it to the recommended (optimal) resolution **Control Panel > Display > Settings** in Windows. (The settings may differ depending on the operating system (OS) you use.)
- Not setting the graphics card to the recommended (optimal) resolution may result in blurred text, a dimmed screen, a truncated display area or misalignment of the display.
- The setting methods may be different depending on the computer or operating system, and some resolutions may not be available depending on the performance of the graphics card. If this is the case, contact the manufacturer of the computer or graphics card for assistance.
- Some graphics cards may not support 3840 x 2160 resolution. If the resolution cannot be displayed, contact the manufacturer of your graphics card.

<b>The display color is abnormal.</b>	
Does the display appear discolored (16 colors)?	<ul style="list-style-type: none"> <li>• Set the color to 24 bit (true color) or higher. In Windows, go to <b>Control Panel &gt; Display &gt; Settings &gt; Color Quality</b>. (The settings may differ depending on the operating system (OS) you use.)</li> </ul>
Does the display color appear unstable or monochrome?	<ul style="list-style-type: none"> <li>• Check if the signal cable is connected properly. Reconnect the cable or reinsert the PC's graphics card.</li> </ul>
Are there spots on the screen?	<ul style="list-style-type: none"> <li>• When using the monitor, pixilated spots (red, green, blue, white, or black) may appear on the screen. This is normal for an LCD screen. It is not an error, nor is it related to the monitor's performance.</li> </ul>

<b>Do you see an "Unrecognized monitor, Plug and Play (VESA DDC) monitor found" message?</b>	
Have you installed the display driver?	<ul style="list-style-type: none"> <li>• Be sure to install the display driver from the display driver CD (or diskette) that comes with your display. Or, you can also download the driver from our web site: <a href="http://www.lg.com">http://www.lg.com</a>.</li> <li>• Make sure to check if the graphics card supports Plug and Play function.</li> </ul>

<b>No sound from the headphone port or speaker.</b>	
Are images displayed using DisplayPort or HDMI input without sound?	<ul style="list-style-type: none"> <li>• Try increasing the volume using the button on the monitor.</li> <li>• Set the audio output of the PC to the monitor you are using. On Microsoft Windows, go to <b>Control Panel &gt; Hardware and Sound &gt; Sound &gt; set the monitor as default device</b>. (The settings may differ depending on the operating system (OS) you use.)</li> </ul>

# PRODUCT SPECIFICATION

Specifications are subject to change without notice.

## Factory Support Mode

### DisplayPort

Preset Mode	Horizontal Frequency (kHz)	Vertical Frequency (Hz)	Polarity (H/V)	Remarks
640 x 480	31.469	59.94	-/-	
800 x 600	37.879	60.317	+/+	
1024 x 768	48.363	60	-/-	
1152 x 864	54.347	60.05	+/+	
1280 x 720	45	60	+/+	
1280 x 1024	63.981	60.02	+/+	
1600 x 900	60	60	+/+	
1920 x 1080	67.5	60	+/-	
1920 x 2160	133.32	60	+/-	Recommended resolution for PBP
2560 x 1440	88.79	59.95	+/-	
3840 x 2160	66.66	30	+/-	
3840 x 2160	133.32	60	+/-	

## HDMI

Presets Mode	Horizontal Frequency (kHz)	Vertical Frequency (Hz)	Polarity (H/V)	Remarks
640 x 480	31.469	59.94	-/-	
800 x 600	37.879	60.317	+/+	
1024 x 768	48.363	60	-/-	
1152 x 864	54.347	60.05	+/+	
1280 x 720	45	60	+/+	
1280 x 1024	63.981	60.02	+/+	
1600 x 900	60	60	+/+	
1920 x 1080	67.5	60	+/-	
1920 x 2160	133.29	60	+/-	Recommended resolution for PBP
2560 x 1440	88.79	59.95	+/-	
3840 x 2160	67.5	30	+/-	
3840 x 2160	135	60	+/-	When the <b>HDMI ULTRA HD Deep Color</b> is set to <b>On</b>

## HDMI Timing (Video)

Presets mode	Horizontal Frequency (kHz)	Vertical Frequency (Hz)	Remarks
480p	31.5	60	
720p	45.0	60	
1080p	67.5	60	
2160p	135	60	When the <b>HDMI ULTRA HD Deep Color</b> is set to <b>On</b>

## Power LED

Mode	LED Color
On Mode	White
Sleep Mode	Flashing White
Off Mode	Off



To obtain the source code under GPL, LGPL, MPL, and other open source licenses, that is contained in this product, please visit <http://opensource.lge.com>.

In addition to the source code, all referred license terms, warranty disclaimers and copyright notices are available for download.

LG Electronics will also provide open source code to you on CD-ROM for a charge covering the cost of performing such distribution (such as the cost of media, shipping, and handling) upon email request to [opensource@lge.com](mailto:opensource@lge.com). This offer is valid for three (3) years from the date on which you purchased the product.

Read the Owner's Manual (CD) carefully and keep it at hand. Please note that the label attached to the product provides information for product support.

Model \_\_\_\_\_  
Serial No. \_\_\_\_\_

**WARNING:** This equipment is compliant with Class A of CISPR 32. In a residential environment this equipment may cause radio interference.