

**SAMSUNG**

# USER MANUAL

---

**LS03 SERIES**

**T H E**  
**F R A M E**

Thank you for purchasing this Samsung product.

To receive more complete service, please register your product at [www.samsung.com](http://www.samsung.com)



Model \_\_\_\_\_ Serial No. \_\_\_\_\_

If you have any questions, please call us at 1-800-SAMSUNG (1-800-726-7864) for assistance.

# Before Reading This User Manual

This TV comes with this user manual and an embedded e-Manual.

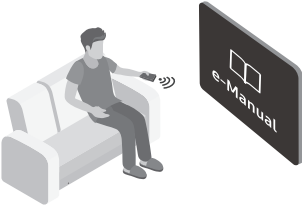

Before reading this user manual, review the following:

	<p><b>User Manual</b></p>	<p>Read this provided user manual to see information about product safety, installation, accessories, initial configuration, and product specifications.</p>
	<p><b>e-Manual</b></p>	<p>For more information about this TV, read the e-Manual embedded in the product.</p> <ul style="list-style-type: none"> <li>To open the e-Manual,           <ul style="list-style-type: none"> <li> &gt;  <b>Settings</b> &gt; <b>Support</b> &gt; <b>Open e-Manual</b></li> </ul> </li> </ul>





Scan this QR code with your smart device to visit Samsung's online Customer Service Center. You can also use your PC to visit "www.samsung.com" and click Support. On the website, you can download the user manual and see its contents on your PC or mobile device.

## Learning the e-Manual's assistance functions

	<p><b>Search</b></p>	<p>Select an item from the search results to load the corresponding page.</p>
	<p><b>Index</b></p>	<p>Select a keyword to navigate to the relevant page.</p>
	<p><b>Recently Viewed Topics</b></p>	<p>Select a topic from the list of recently viewed topics.</p>







- Some menu screens cannot be accessed from the e-Manual.

## Learning the functions of the buttons that appear on e-Manual topic pages

	<p><b>Try Now</b></p>	<p>Access the associated menu item and try out the feature directly.</p>
	<p><b>Link</b></p>	<p>Access an underlined topic referred to on an e-Manual page immediately.</p>

# Warning! Important Safety Instructions

Please read the Safety Instructions before using your TV.

<b>CAUTION</b>			Class II product: This symbol indicates that a safety connection to electrical earth (ground) is not required.
<b>RISK OF ELECTRIC SHOCK. DO NOT OPEN.</b>			
CAUTION: TO REDUCE THE RISK OF ELECTRIC SHOCK, DO NOT REMOVE COVER (OR BACK). THERE ARE NO USER SERVICEABLE PARTS INSIDE. REFER ALL SERVICING TO QUALIFIED PERSONNEL.			AC voltage: Rated voltage marked with this symbol is AC voltage.
	This symbol indicates that high voltage is present inside. It is dangerous to make any kind of contact with any internal part of this product.		DC voltage: Rated voltage marked with this symbol is DC voltage.
	This symbol indicates that this product has included important literature concerning operation and maintenance.		Caution. Consult instructions for use: This symbol instructs the user to consult the user manual for further safety related information.

- The slots and openings in the cabinet and in the back or bottom are provided for necessary ventilation. To ensure reliable operation of this apparatus and to protect it from overheating, these slots and openings must never be blocked or covered.
  - Do not place this apparatus in a confined space, such as a bookcase or built-in cabinet, unless proper ventilation is provided.
  - Do not place this apparatus near or over a radiator or heat register, or where it is exposed to direct sunlight.
  - Do not place vessels (vases etc.) containing water on this apparatus, as this can result in a fire or electric shock.
- Do not expose this apparatus to rain or place it near water (near a bathtub, washbowl, kitchen sink, or laundry tub, in a wet basement, or near a swimming pool, etc.). If this apparatus accidentally gets wet, unplug it and contact an authorized dealer immediately.
- This apparatus uses batteries. In your community, there might be environmental regulations that require you to dispose of these batteries properly. Please contact your local authorities for disposal or recycling information.
- Do not overload wall outlets, extension cords, or adaptors beyond their capacity, since this can result in fire or electric shock.
- Power-supply cords should be placed so that they are not likely to be walked on or pinched by items placed upon or against them. Pay particular attention to cords at the plug end, at wall outlets, and at the point where they exit from the appliance.
- To protect this apparatus from a lightning storm, or when left unattended and unused for long periods of time, unplug it from the wall outlet and disconnect the antenna or cable system. This will prevent damage to the set due to lightning and power line surges.

- Before connecting the AC power cord to the DC adaptor outlet, make sure that the voltage designation of the DC adaptor corresponds to the local electrical supply.
- Never insert anything metallic into the open parts of this apparatus. This may cause a danger of electric shock.
- To avoid electric shock, never touch the inside of this apparatus. Only a qualified technician should open this apparatus.
- Be sure to plug in the power cord until it is firmly seated. When unplugging the power cord from a wall outlet, always pull on the power cord's plug. Never unplug it by pulling on the power cord. Do not touch the power cord with wet hands.
- If this apparatus does not operate normally - in particular, if there are any unusual sounds or smells coming from it - unplug it immediately and contact an authorized dealer or service center.
- Be sure to pull the power plug out of the outlet if the TV is to remain unused or if you are to leave the house for an extended period of time (especially when children, elderly, or disabled people will be left alone in the house).
  - Accumulated dust can cause an electric shock, an electric leakage, or a fire by causing the power cord to generate sparks and heat or by causing the insulation to deteriorate.
- Be sure to contact an authorized Samsung service center for information if you intend to install your TV in a location with heavy dust, high or low temperatures, high humidity, chemical substances, or where it will operate 24 hours a day such as in an airport, a train station, etc. Failure to do so may lead to serious damage to your TV.
- Use only a properly grounded plug and wall outlet.
  - An improper ground may cause electric shock or equipment damage. (Class I Equipment only.)
- To turn off this apparatus completely, disconnect it from the wall outlet. To ensure you can unplug this apparatus quickly if necessary, make sure that the wall outlet and power plug are readily accessible.
- Store the accessories (batteries, etc.) in a location safely out of the reach of children.
- Do not drop or strike the product. If the product is damaged, disconnect the power cord and contact a Samsung service center.
- To clean this apparatus, unplug the power cord from the wall outlet and wipe the product with a soft, dry cloth. Do not use any chemicals such as wax, benzene, alcohol, thinners, insecticide, air fresheners, lubricants, or detergents. These chemicals can damage the appearance of the TV or erase the printing on the product.
- Do not expose this apparatus to dripping or splashing.
- Do not dispose of batteries in a fire.
- Do not short-circuit, disassemble, or overheat the batteries.
- There is danger of an explosion if you replace the batteries used in the remote with the wrong type of battery. Replace only with the same or equivalent type.
- **WARNING - TO PREVENT THE SPREAD OF FIRE, KEEP CANDLES AND OTHER ITEMS WITH OPEN FLAMES AWAY FROM THIS PRODUCT AT ALL TIMES.**
- Use care when touching the TV after it has been on for some time. Some parts can be warm to the touch.
- **State of California Proposition 65 Warning**
  - **WARNING - This product contains chemicals known to the State of California to cause cancer and birth defects or other reproductive harm.**



## Internet security

Samsung takes a number of steps to protect its Internet-compatible Smart TVs against unauthorized incursions and hacking. For example, certain sensitive communications between the TV and the Internet servers are encrypted. In addition, the TV's operating system has adopted controls to prevent the installation of unauthorized applications. Although we take steps to protect your Smart TV and personal information, no Internet-connected device or transmission is completely secure. We therefore encourage you to take additional steps to safeguard your TV, secure your Internet connection, and minimize the risk of unauthorized access. These steps are listed below:

- When Samsung releases software updates to improve the security of your TV, you should promptly install these updates. To automatically receive these updates, turn on **Auto Update** in the TV's menu (🏠 > ⚙️ **Settings** > **Support** > **Software Update** > **Auto Update**). When an update is available, a popup message appears on the TV screen. Accept the software download and update by selecting YES when prompted. Take steps to secure your wireless router and network. Your router's manual should provide additional details about how to implement the following measures:
  - Secure your wireless router's management settings with a unique password to prevent unauthorized changes to security related settings.
  - Implement standard encryption (e.g., WPA2 encryption) on your wireless router to secure your wireless network signal.
  - Secure access to your wireless network with a hard-to-guess password.
  - Confirm your router's firewall setting is enabled (if so equipped).
  - Make sure that all your Internet-connected devices are behind your network's firewall.
  - If your router or modem has a standby mode button, use it to disconnect your home network from the Internet when it is not in use.
- Use strong passwords for all your Internet accounts (Netflix, Facebook, etc.). If your TV has a camera, recess the camera into the TV's bezel when it is not in use. Recessing the camera makes it inoperative.
- If any unexpected messages appear on your TV screen requesting permission to link a device or enable a remote session, do NOT accept.
- Do not visit suspicious web sites and do not install any suspicious programs. We recommend that users install only those authorized apps provided by Samsung through Samsung Smart Hub.

Figures and illustrations in this User Manual are provided for reference only and may differ from the actual product appearance. Product design and specifications may change without notice.

# Contents

	Before Reading This User Manual	2
	Warning! Important Safety Instructions	3
<b>01</b>	<b>TV Installation</b>	
	One Invisible Connection Guide	7
	Mounting the TV on a wall	8
	Providing proper ventilation for your TV	9
	Safety Precaution: Securing the TV to the wall to prevent falling	9
	Using the Cover Cap	10
	Precautions when installing the TV with a stand	10
<b>02</b>	<b>Using Art Mode</b>	
	Viewing images	11
	Setting the style of the selected image	13
	Setting up Art mode	14
	Using Art mode with the SmartThings app	14
<b>03</b>	<b>The Samsung Smart Remote</b>	
	About the Buttons on the Samsung Smart Remote	15
	Pairing the TV to the Samsung Smart Remote	16
	Installing batteries into the Samsung Smart Remote	16
<b>04</b>	<b>Initial Setup</b>	
	Using the TV Controller	17
<b>05</b>	<b>Troubleshooting and Maintenance</b>	
	Troubleshooting	18
	Precautions when using Art mode	20
	What is Remote Support?	20
	Eco Sensor and screen brightness	21
	Caring for the TV	21
<b>06</b>	<b>Specifications and Other Information</b>	
	Specifications	22
	Environmental Considerations	22
	Decreasing power consumption	23
	Dimensions	24
	Licenses	24
	<b>FCC and Warranty Information</b>	
	Federal Communication Commission Interference Statement	25
	LIMITED WARRANTY TO ORIGINAL PURCHASER	26

# 01 TV Installation

## One Invisible Connection Guide

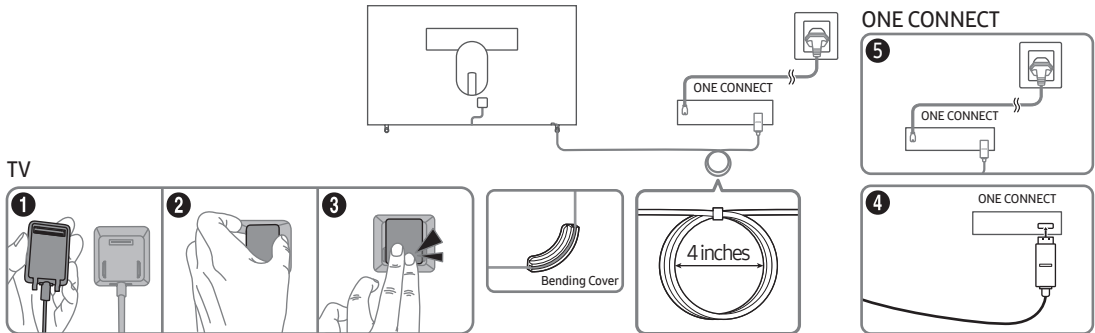

To connect the One Invisible Connection to the One Connect and your TV, follow these steps:

1. After the TV is completely set up and placed in its final position, connect the One Invisible Connection to the One Connect and the TV as shown in Steps 1 to 4 above.  
**WARNING:** Make sure that both connectors are fully and firmly connected. If either connector is not connected properly, there is a danger of severe electric shock.

2. Connect the One Connect AC power cord to the One Connect, and then connect the cord to a wall outlet as shown in Step 5 above.

**WARNING:** Follow the directions exactly. Be sure to connect the power cord to the wall outlet as the last step. Always disconnect the power cord from the wall outlet before disconnecting the One Invisible Connection from the back of the TV or from the One Connect.

- See the illustrated Quick Setup Guide for more information.



- When connecting the One Invisible Connection, use a Bending Cover, which prevents the cable of the One Invisible Connection from being bent at a 90 degree angle, to bend the cable. Failure to do so may cause damage to the cable.
- When connecting the One Invisible Connection, pay attention to the shapes and sizes of its connectors so that they are connected correctly. Failure to do so may cause product malfunction.
- When connecting the One Invisible Connection, be careful not to twist the cable of the One Invisible Connection. Failure to do so may cause performance degradation of the TV or damage to the cable.
- When arranging the remaining cable, refer to the figure above for the correct arrangement.
- Take care not to subject the cable to any of the actions below. The One Invisible Connection contains a power circuit. You could damage the cable and subject yourself to an electric shock.
- Handle the One Connect box carefully. It is heavy.



Bending



Twisting



Pulling



Pressing on



Electric shock

### CLASS 1 LASER PRODUCT

- Caution - Invisible laser radiation when open. Do not stare into beam.
    - Do not bend the One Invisible Connection cable excessively. Do not cut the cable.
    - Do not place heavy objects on the cable.
    - Do not disassemble either of the cable connectors.
  - Caution - Use of controls, adjustments, or the performance of procedures other than those specified herein may result in hazardous radiation exposure.
3. Connect your peripherals (antenna, cable box, Blu-ray player, etc.) to the One Connect box. See the Accessories Kit Guide for details.

# Mounting the TV on a wall



If you mount this TV on a wall, follow the instructions exactly as set out by the manufacturer. Unless it is correctly mounted, the TV may slide or fall and cause serious injury to a child or adult and serious damage to the TV.

For models providing wall mount adapters, install them as shown in the figure below before installing the wall mount kit.

- Refer to the installation manual included with the Samsung wall mount kit.

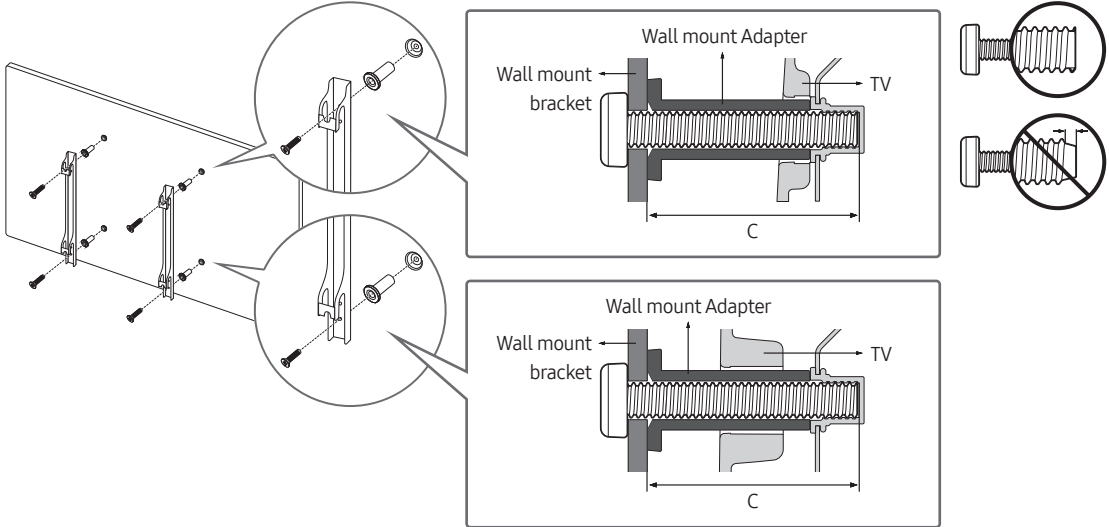

- Samsung Electronics is not responsible for any damage to the product or injury to yourself or others if you choose to install the wall mount on your own.
- To order the wall mount kit, contact Samsung Customer Care at 1-800-SAMSUNG (1-800-726-7864).
- You can install your wall mount on a solid wall perpendicular to the floor. Before attaching the wall mount to surfaces other than plaster board, contact your nearest dealer for additional information. If you install the TV on a ceiling or slanted wall, it may fall and result in severe personal injury.
- When installing a wall mount kit, we recommend you fasten all four VESA screws.
- If you want to install a wall mount kit that attaches to the wall using two top screws only, be sure to use a Samsung wall mount kit that supports this type of installation. (You may not be able to purchase this type of wall mount kit, depending on the geographical region.)
- Standard dimensions for wall mount kits are shown in the table below.
- If you are installing a third-party wall mount, note that the length of the screws you can use to attach the TV to the wall mount is shown in column C in the table below.

TV size in inches	VESA screw hole specs (A * B) in millimeters	C (mm)	Standard Screw	Pitch (mm)	Quantity	
43	200 x 200	43-45	M8	1.25	4	
55-65	400 x 400					





Do not install your wall mount kit while your TV is turned on. This may result in personal injury from electric shock.

- Do not use screws that are longer than the standard dimension or do not comply with the VESA standard screw specifications. Screws that are too long may cause damage to the inside of the TV set.
- For wall mounts that do not comply with the VESA standard screw specifications, the length of the screws may differ depending on the wall mount specifications.
- Do not fasten the screws too firmly. This may damage the product or cause the product to fall, leading to personal injury. Samsung is not liable for these kinds of accidents.
- Samsung is not liable for product damage or personal injury when a non-VESA or non-specified wall mount is used or when the consumer fails to follow the product installation instructions.
- Do not mount the TV at more than a 15 degree tilt.
- Always have two people mount the TV onto a wall.

## Providing proper ventilation for your TV

When you install your TV and One Connect, maintain a distance of at least 4 inches between the TV and One Connect with other objects (walls, cabinet sides, etc.) to ensure proper ventilation. Failing to maintain proper ventilation may result in a fire or a problem with the product caused by an increase in its internal temperature.

When you install your TV with a stand or a wall mount, we strongly recommend you use parts provided by Samsung Electronics only. Using parts provided by another manufacturer may cause difficulties with the product or result in injury caused by the product falling.

## Safety Precaution: Securing the TV to the wall to prevent falling



**Caution:** Pulling, pushing, or climbing on the TV may cause the TV to fall. In particular, ensure your children do not hang on or destabilize the TV. This action may cause the TV to tip over, causing serious injuries or death. Follow all safety precautions provided in the Safety Flyer included with your TV. For added stability and safety, you can purchase and install the anti-fall device as described on the next page.



**WARNING:** Never place a television set in an unstable location. The television set may fall, causing serious personal injury or death. Many injuries, particularly to children, can be avoided by taking simple precautions such as

- Using cabinets or stands recommended by the manufacturer of the television set.
  - Only using furniture that can safely support the television set.
  - Ensuring the television set is not overhanging the edge of the supporting furniture.
  - Not placing the television set on tall furniture (for example, cupboards or bookcases) without anchoring both the furniture and the television set to a suitable support.
  - Not placing the television set on cloth or other materials that may be located between the television set and supporting furniture.
  - Educating children about the dangers of climbing on furniture to reach the television set or its controls.
- If you are retaining and relocating the television set that you are replacing with this new set, you should apply the same precautions to the old set.
- When you have to relocate or lift the TV for replacement or cleaning, be sure not to pull out the stand.

## Preventing the TV from falling

1. Using the appropriate screws, firmly fasten a set of brackets to the wall.  
Confirm that the screws are firmly attached to the wall.
  - You may need additional material such as wall anchors depending on the type of wall.
2. Using the appropriately sized screws, firmly fasten a set of brackets to the TV.
  - For the screw specifications, refer to "Standard Screw" in the table on page 8.
3. Connect the brackets fixed to the TV and the brackets fixed to the wall with a durable, heavy-duty string, and then tie the string tightly.
  - Install the TV near the wall so that it does not fall backwards.
  - Connect the string so that the brackets fixed to the wall are at the same height as or lower than the brackets fixed to the TV.

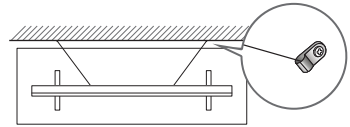
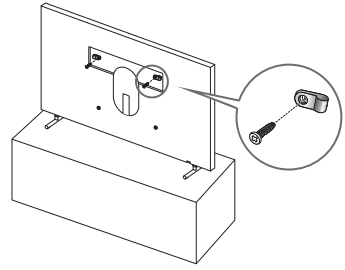

## Using the Cover Cap

When you do not use the VESA wall mount, you can cover the wall mount screw holes with cover caps. See the image below.

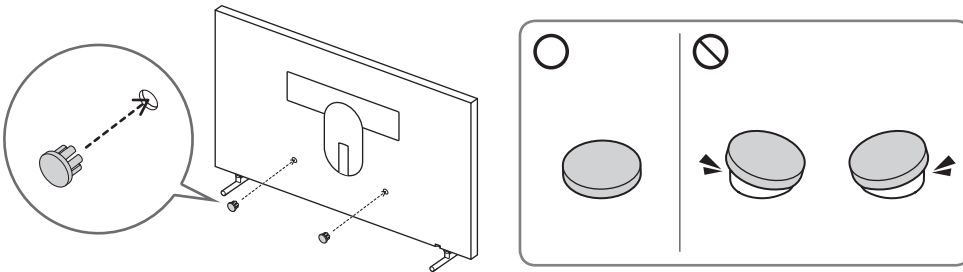

## Precautions when installing the TV with a stand

When you install the TV with a stand, avoid placing the stand on the back part of the table surface. Failure to do so may cause the motion sensor at the bottom of the TV not to work properly.

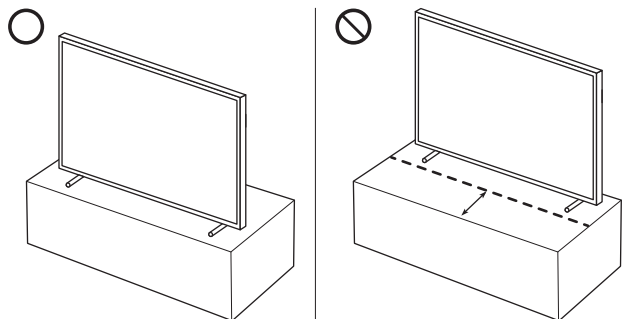

## 02 Using Art Mode

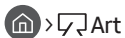

You can use Art mode function to display image content such as artworks or pictures when you are not watching TV in full screen mode.

- Press the button on the remote control to switch to TV mode or Art mode.
- Press the button in Art mode to switch to TV mode.
- To turn off the TV completely, press and hold the button on the remote control, or press the TV Controller button at the bottom of the TV.
  - If you use a remote control other than the Samsung Smart Remote, the TV may not be turned off completely.
- In Art mode, the brightness and color tone of your TV are automatically adjusted depending on the ambient, and the TV can be automatically turned on or off.
  - The TV is set by default so that the screen turns off automatically when the ambient light dims in Art mode.
- You can use Art mode settings ( > Art > Settings) on the TV or SmartThings app on your mobile device to set the motion sensor settings so that the TV can detect visual changes including user movements and turn on or off automatically.
- In Art mode, you can connect your mobile device to the TV using the SmartThings app on the mobile device to view photos on the mobile device.
  - This function may not be supported depending on the TV model or mobile device.
  - Supported features may differ depending on the version of the SmartThings app.

### Viewing images

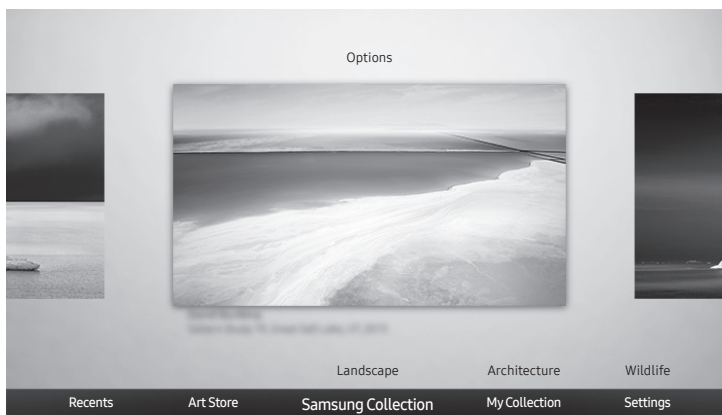

- The image on your TV may differ from the image above depending on the model and geographical area.

To view an image in Art mode, select one of the menus below. To switch to the sub menu where you can select images, press the Select button, one of the four directional buttons, or button in Art mode. Then, use the directional buttons on the remote control to move to desired image, and then press the Select button. ✓ Set appears at the top of the selected image, and you can view the selected image in Art mode.

- **Recents**  
You can manipulate the last selected image.
- **Art Store**  
You can go to **Art Store** to purchase various images.
  - The **Art Store** may not appear depending on the network connection status.

- **Samsung Collection**

You can choose images from different topics.

- **My Collection**

You can use the **Favorite** function to view a list of artworks and photos that you set as your favorites. You can also select the desired ones among the images saved on an external storage device or a mobile device and save them in **My Collection > My Photos**.

- In order to fetch the images from your mobile device, the SmartThings app must have been installed in your mobile device.

## Import images from an external storage device

1. Connect an external storage device that contains images to the TV.
  2. Use the directional buttons on the remote control to move to **My Collection**, and then move to the connected external storage device.
  3. Use the directional buttons on the remote control to move to **Options** at the top of the screen, and then select **Save**.
  4. Use the directional buttons on the remote control to move to an image, and then press the Select button.
    - You can select multiple images.
  5. Use the directional buttons on the remote control to move to **Save to My Photos** at the top of the screen, and then press the Select button.
  6. The selected image or images are saved in **My Collection > My Photos**.
- Recommended resolutions: 3840 x 2160 (16:9)

## Buying images from Art Store

1. Use the directional buttons on the remote control to move to **Art Store**.
2. Use the directional buttons on the remote control to move to a topic, and press the Select button. The images corresponding to the topic appear on the screen.
3. Use the directional buttons on the remote control to move to an image, and press the Select button.
4. Use the directional buttons on the remote control to move to **Buy** at the top of the screen, and then press the Select button to buy the selected image.
5. Use the directional buttons on the remote control to select payment methods, and then press the Select button.
6. Follow the on-screen instructions to procedure payment.

## Subscribing to The Art Store Membership

When you subscribe to **The Art Store Membership**, you can use **Art Store** unlimitedly and enjoy various art works by replacing them with new ones according to your preferences.

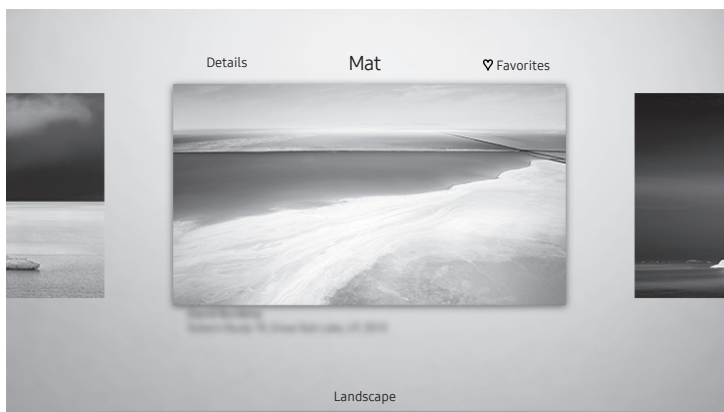

1. Use the directional buttons on the remote control to move to **Art Store > Membership**.
2. Follow the on-screen instructions to enter your membership information.

## Setting the style of the selected image



- The image on your TV may differ from the image above depending on the model and geographical area.

Use the directional buttons on the remote control to move to **Options** at the top of the screen. You can use the following menus:

- **Details**  
You can find more information about the image.
- **Mat**  
You can apply various border styles and colors to the image according to your preferences.
- **Favorite**  
You can set (or not set) an image that you prefer as a favorite item by pressing the Select button on the remote control. You can view a list of items set as your favorites in **My Collection > Favorites**.
  -  **Favorite:** Not set as a favorite.
  -  **Favorite:** Set as a favorite.

### Apply a border style and a color to an image

1. Using the directional buttons on the remote control to move to the image whose border style and color you want to change, move to **Mat** at the top of the screen, and then press the Select button.
2. Use the directional buttons on the remote control to select the border style and color that you want.
3. Change the border style and then press the Select button to move the focus to the image.
4. To save the selected border style and color, press the Select button again.
  - If you press the  button to exit, the border style and color you changed are not saved.

## Setting up Art mode

In Art mode, use the directional buttons on the remote control to move to the **Settings** menu item at the bottom. You can adjust the following functions:

- **Color & Brightness**  
Use the directional buttons on the remote control to move to **Modify** at the top, and then press the Select button. In the next screen, adjust the picture color and brightness. After selecting the desired settings, press the Select button on the remote control.
  - To immediately set **Color & Brightness** while enjoying Art mode, press the  button on the remote control.
- **Sleep After**  
If no motion is detected around the TV for the set time, the TV turns off automatically. Use the directional buttons on the remote control to move to the top items. After selecting the desired time, press the Select button on the remote control.
- **Motion Detector**  
The sensitivity of the motion sensor function can be adjusted. Use the directional buttons on the remote control to move to the top items. After selecting the desired sensitivity, press the Select button on the remote control.
- **Night Mode**  
When this function is turned on, the TV turns off automatically if no light is detected around the TV. Use the directional buttons on the remote control to move to the top items, and then turn this function on or off.

## Using Art mode with the SmartThings app

Once you have installed the SmartThings app on your mobile device, you can use the following functions:

You can download the SmartThings app from Google Play Store, Samsung Apps, or the App Store.

- The features or terminology may vary depending on the version of the SmartThings app.
- On tablet devices, Art mode features may not be supported by the SmartThings app.
- **Selecting images**
- **Subscribing to The Art Store Membership**
- **Creating Collage:** Combine multiple images into one image.
- **Applying border styles and colors to images**
- **Setting the color tone and the brightness for Art mode**
- **Setting Sleep After:** When no motion is detected for the time specified in Art mode, the TV turns off automatically.
- **Setting Night Mode:** Set The Frame to turn off automatically if no light is detected in the room.
- **Setting Motion Detector:** Set the sensor sensitivity so that the TV turns on automatically when motion is detected in Art mode.

# 03 The Samsung Smart Remote

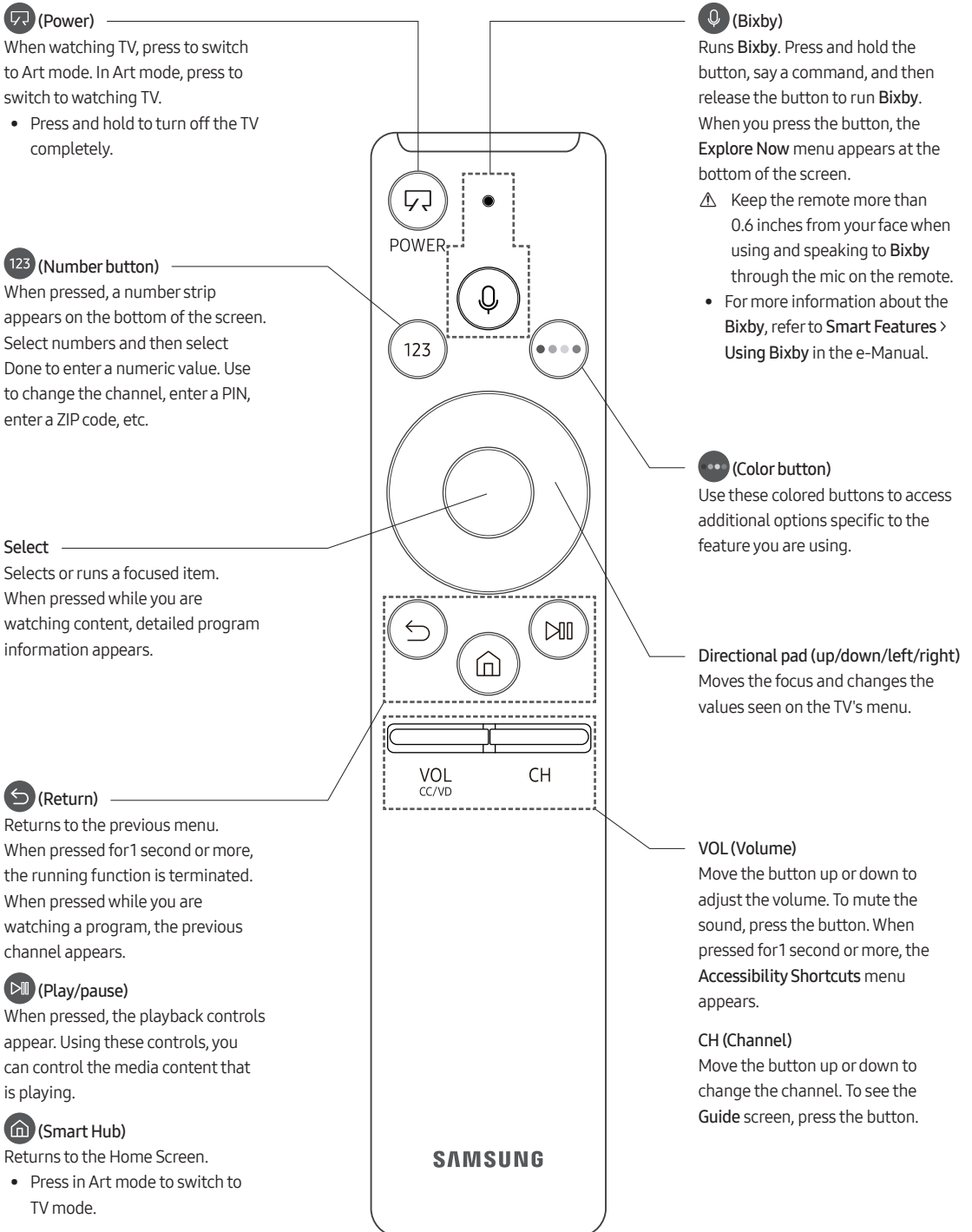

## About the Buttons on the Samsung Smart Remote

- The images, buttons, and functions of the Samsung Smart Remote may differ depending on the model.

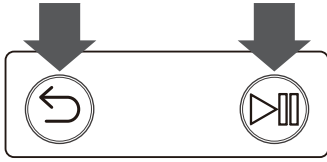

## Pairing the TV to the Samsung Smart Remote



When you turn on the TV for the first time, the Samsung Smart Remote pairs to the TV automatically. If the Samsung Smart Remote does not pair to the TV automatically, point it at the remote control sensor of the TV, and then press and hold the buttons labeled  and  as shown in the figure on the left simultaneously for 3 seconds or more.

## Installing batteries into the Samsung Smart Remote

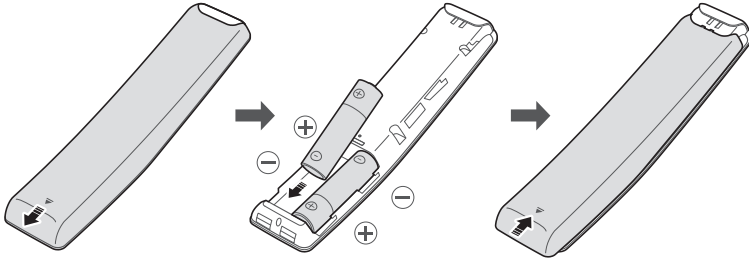

To install the batteries, push the rear cover open in the direction of the arrow in the illustration on the left, and then insert the batteries as shown in the figure. Make sure that the positive and negative ends are facing in the correct direction.

- Alkaline batteries are recommended for longer battery life.



# 04 Initial Setup

When you turn on your TV for the first time, it immediately starts the Initial Setup. Follow the instructions displayed on the screen and configure the TV's basic settings to suit your viewing environment.

- Noise may occur temporarily when the TV communicates with mobile devices.
- The SmartThings app is available on mobile devices for Android 6.0 or higher and iOS10 or higher.
- To perform initialization by using the SmartThings app, the mobile device must have been connected via Wi-Fi.
- When the pop-up for setup does not appear automatically on the SmartThings app of your mobile device, proceed with the process after manually adding the TV using **Add Device** on the dashboard of the SmartThings app.

## Using the TV Controller

You can turn on the TV with the **TV Controller** button at the bottom of the TV, and then use the Control Menu. The **Control menu** appears when the TV Controller is pressed while the TV is On. For more information about its usage, refer to the figure below.

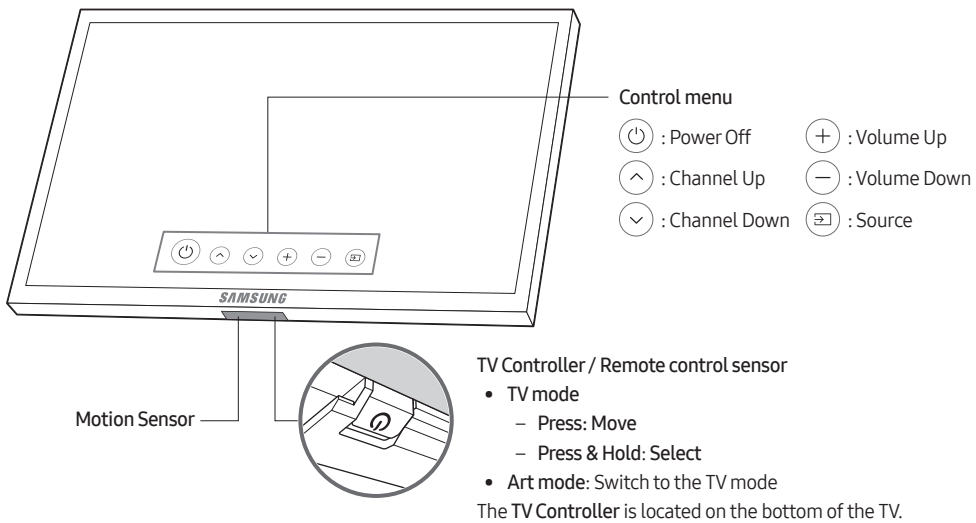

- When you press the **TV Controller** button, be careful not to press the motion sensor close to it.
- In Art mode, the power indicator at the bottom of the TV remains off.
- After detaching the Customizable Frame (sold separately) from the TV, push up the remote control sensor so that it returns to its original position.
  - Do not push up the remote control sensor strongly. There is a risk of damage.

# 05 Troubleshooting and Maintenance

## Troubleshooting

If the TV seems to have a problem, first review this list of possible problems and solutions. Alternatively, review the Troubleshooting Section in the e-Manual. If none of the troubleshooting tips apply, please visit "www.samsung.com" and click Support or contact the call center listed on the back cover of this manual.

- For detailed information on troubleshooting, watch the troubleshooting videos at [www.samsung.com/spsn](http://www.samsung.com/spsn).
- This TFT LED panel is made up of sub pixels which require sophisticated technology to produce. There may be, however, a few bright or dark pixels on the screen. These pixels will have no impact on the performance of the product.
- To keep your TV in optimum condition, upgrade to the latest software. Use the **Update Now** or **Auto Update** functions on the TV's menu (🏠 > ⚙️ Settings > Support > Software Update > Update Now or Auto Update).

### The TV won't turn on.

- Make sure that the AC power cord is securely plugged in to the TV and the wall outlet.
- Make sure that the wall outlet is working and the power indicator at the bottom of the TV is lit and glowing a solid red.
- Try pressing the Power (⏻) button at the bottom of the TV to make sure that the problem is not with the remote control. If the TV turns on, refer to "Remote control does not work" below.

### There is no picture/video/sound, or a distorted picture/video/sound from an external device, or "Weak or No Signal" is displayed on the TV, or you cannot find a channel.

- Make sure the connection to the device is correct and that all cables are fully inserted.
- Remove and reconnect all cables connected to the TV and the external devices. Try new cables if possible.
- Confirm that the correct input source has been selected (🏠 > Source).
- Perform a TV self diagnosis to determine if the problem is caused by the TV or the device (🏠 > ⚙️ Settings > Support > Self Diagnosis > Start Picture Test or Start Sound Test).
- If the test results are normal, reboot the connected devices by unplugging each device's power cord and then plugging it in again. If the issue persists, refer to the connection guide in the user manual of the connected device.
- If you are not using a cable box or satellite box, and your TV is receiving TV signals from an antenna or a cable wall connector, run **Auto Program** to search for channels (🏠 > ⚙️ Settings > Broadcasting > Auto Program).

### The remote control does not work.

- Check if the power indicator at the bottom of the TV blinks when you press the remote's Power button. If it does not, replace the remote control's batteries.
- Make sure that the batteries are installed with their poles (+/-) in the correct direction.
- Try pointing the remote directly at the TV from 5 ft. to 6 ft. (1.5~1.8 m) away.
- If your TV came with a Samsung Smart Remote (Bluetooth Remote), make sure to pair the remote to the TV.

### The cable box or satellite box remote control doesn't turn the TV on or off or adjust the volume.

- Program the cable box or satellite box remote control to operate the TV. Refer to the cable box or satellite box user manual for the SAMSUNG TV code.

## The TV settings are lost after 5 minutes.

- The TV is in the Retail Mode. Change the Usage Mode in the System Manager Menu to Home Mode (🏠 > ⚙️ Settings > General > System Manager > Usage Mode > Home Mode).

## Intermittent Wi-Fi

- Make sure the TV has a network connection (🏠 > ⚙️ Settings > General > Network > Network Status).
- Make sure the Wi-Fi password is entered correctly.
- Check the distance between the TV and the Modem/Router. The distance should not exceed 50 ft (15.2 m).
- Reduce interference by not using or turning off wireless devices. Also, verify that there are no obstacles between the TV and the Modem/Router. (The Wi-Fi strength can be decreased by appliances, cordless phones, stone walls/ fireplaces, etc.)

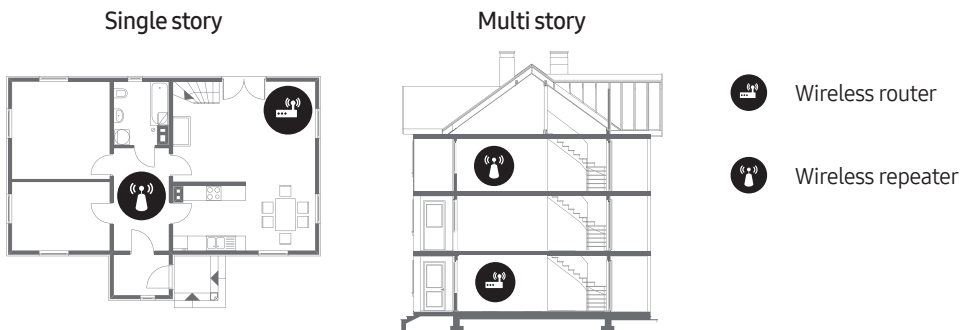

- Contact your Internet Service Provider (ISP) and ask them to reset your network circuit to re-register the Mac addresses of your new Modem/Router and the TV.



## Video App problems (Youtube etc)

- Change the DNS to 8.8.8.8. Select (🏠 > ⚙️ Settings > General > Network > Network Status > IP Settings > DNS Setting > Enter manually > DNS Server > enter 8.8.8.8 > OK.
- Reset by selecting (🏠 > ⚙️ Settings > Support > Self Diagnosis > Reset Smart Hub.

## The TV remains on or does not turn on automatically.

- If the surrounding area is too dark or bright, the motion sensor may not work normally. The performance of the motion sensor may be affected by the installation environment (height, tilt, obstacles). If the clothes you wear or your skin color is similar to the surrounding shading, the motion sensor may not work properly.
- The TV responds to all visual changes around it (lights, displays, dogs, out-of-window changes, and other occurrences). You can adjust the response level by adjusting the motion detection sensitivity. (🏠 > 🎨 Art > ⚙️ Settings > Motion Detector)

## Precautions when using Art mode

- The motion sensor is located at the bottom of the TV. Do not block the sensor at the front of the TV. The motion sensor as well as the brightness and color tone of the screen can be affected.
- Art mode uses algorithms to minimize image burn-in that can be caused by displaying still images on the screen for long periods of time.
- The performance of the sensor may vary depending on the TV installation and operating environment.
  - The screen brightness and color tone may be affected depending on the color of the floor on which the TV stands.
  - In an environment where special light sources other than standard light sources (halogen, fluorescent) are used, the sensor's motion recognition performance may vary depending on the positions, types, and number of the light sources.
  - If the area around the TV is too dark or bright, the screen brightness may be limited or the sensor may not work normally.
  - If the TV is installed too high or too low, the sensor may not work normally.
  - The motion sensor may sense motion from a flashing LED, a pet, a car moving outside the window, or other occurrence and start operating.
- Depending on the **Auto Power Off** function settings, the TV may turn off when there is no user input in Art mode, such as inputs from the remote control.
-  >  **Settings** > **General** > **System Manager** > **Time** > **Sleep Timer** and **Off Timer** function does not work in Art mode.



## What is Remote Support?

Samsung Remote Support service offers you one-on-one support with a Samsung Technician who can remotely:

- Diagnose your TV
- Adjust the TV settings for you
- Perform a factory reset on your TV
- Install recommended firmware updates



### How does Remote Support work?

You can easily get Samsung Remote Support service for your TV.

1. Call the Samsung Contact Center and ask for remote support.
2. Open the menu on your TV, and then go to the **Support** section. ( >  **Settings** > **Support**)
3. Select **Remote Management**, then read and agree to the service agreements. When the PIN screen appears, provide the PIN number to the technician.
4. The technician will then access your TV.

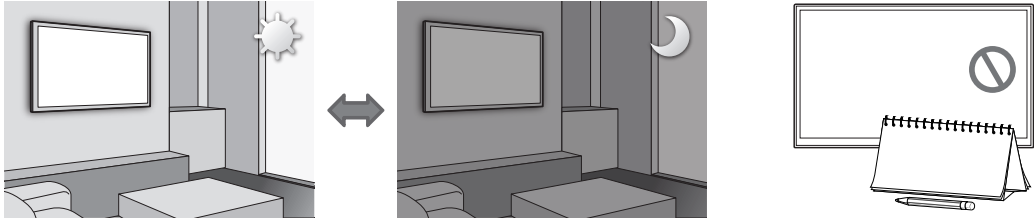
## Eco Sensor and screen brightness



Eco Sensor adjusts the brightness of the TV automatically. This feature measures the light in your room and optimizes the brightness of the TV automatically to reduce power consumption. If you want to turn this off, go to  >  Settings > General > Eco Solution > Ambient Light Detection.

- If the screen is too dark while you are watching TV in a dark environment, it may be due to the **Ambient Light Detection** function.
- The eco sensor is located at the bottom of the TV. Do not block the sensor with any object. This can decrease picture brightness.

## Caring for the TV

- If a sticker was attached to the TV screen, some debris can remain after you remove the sticker. Please clean the debris off before watching TV.
- The exterior and screen of the TV can get scratched during cleaning. Be sure to wipe the exterior and screen carefully using a soft cloth to prevent scratches.
- Do not spray water or any liquid directly onto the TV. Any liquid that goes into the product may cause a failure, fire, or electric shock.
- To clean the screen, turn off the TV, then gently wipe away smudges and fingerprints on the panel with a micro-fiber cloth. Clean the body or panel of the TV with a micro-fiber cloth dampened with a small amount of water. After that, remove the moisture with a dry cloth. While cleaning, do not apply strong force to the surface of the panel because it can damage the panel. Never use flammable liquids (benzene, thinner, etc.) or a cleaning agent. For stubborn smudges, spray a small amount of screen cleaner on a micro-fiber cloth, and then use the cloth to wipe away the smudges.

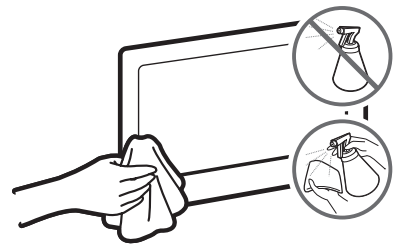

# 06 Specifications and Other Information

## Specifications

Model Name	UN43LS03N	UN55LS03N
Display Resolution	3840 x 2160	3840 x 2160
Screen Size Diagonal Measured Diagonally	43" Class 42.5 inches	55" Class 54.6 inches
Sound (Output)	20 W	40 W
Dimensions (W x H x D) Body	38.1 x 21.9 x 1.7 inches (966.6 x 556.8 x 42.5 mm)	48.6 x 27.9 x 1.7 inches (1235.0 x 707.8 x 42.5 mm)
With stand	38.1 x 23.6 x 7.9 inches (966.6 x 599.8 x 200.0 mm)	48.6 x 29.6 x 7.9 inches (1235.0 x 750.7 x 200.0 mm)
Weight Without Stand With Stand	24.7 lbs (11.2 kg) 25.8 lbs (11.7 kg)	41.0 lbs (18.6 kg) 42.1 lbs (19.1 kg)
Model Name	UN65LS03N	
Display Resolution	3840 x 2160	
Screen Size Diagonal Measured Diagonally	65" Class 64.5 inches	
Sound (Output)	40 W	
Dimensions (W x H x D) Body	57.2 x 32.7 x 1.7 inches (1453.9 x 830.9 x 42.5 mm)	
With stand	57.2 x 34.5 x 11.6 inches (1453.9 x 875.5 x 294.0 mm)	
Weight Without Stand With Stand	56.0 lbs (25.4 kg) 57.8 lbs (26.2 kg)	

## Environmental Considerations

Operating Temperature	50°F to 104°F (10°C to 40°C)
Operating Humidity	10% to 80%, non-condensing
Storage Temperature	-4°F to 113°F (-20°C to 45°C)
Storage Humidity	5% to 95%, non-condensing

## Notes

- Design and specifications are subject to change without prior notice.
- This device is a Class B digital apparatus.
- For information about the power supply, and more information about power consumption, refer to the information on the label attached to the product.
  - On One Connect models, the label is attached to the bottom of the One Connect.
  - On most models, the label is attached to the back of the TV. (On some models, the label is inside the cover terminal.)
- Typical power consumption is measured according to Energy Star Program requirements for televisions.
- Your TV and its accessories may look different than the product images presented in this manual, depending on the model.
- All drawings are not necessarily to scale. Some dimensions are subject to change without prior notice. Refer to the dimensions before installing your TV. Not responsible for typographical or printed errors.
- To connect a LAN cable, use a CAT 7 (\*STP type) cable for the connection.
  - \* Shielded Twist Pair

© 2018 Samsung Electronics America, Inc

Dispose unwanted electronics through an approved recycler.

To find the nearest recycling location, go to our website:

[www.samsung.com/recyclingdirect](http://www.samsung.com/recyclingdirect) or call, (877) 278 - 0799

## Decreasing power consumption

When you shut the TV off, it enters Standby mode. In Standby mode, it continues to draw a small amount of power. To decrease power consumption, unplug the power cord when you don't intend to use the TV for a long time.

## Dimensions

Port panel detail / Rear view

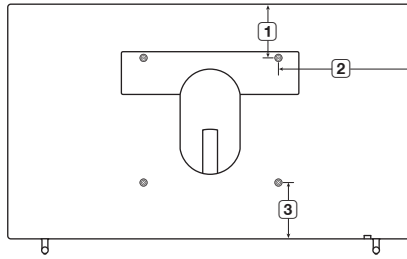

- The displayed image may differ from your TV, depending on the model.

(Unit: inches)

Model name	①	②	③
UN43LS03N	2.8	15.1	11.2
UN55LS03N	5.7	16.4	6.4
UN65LS03N	10.6	20.7	6.4

## Licenses

**DOLBY AUDIO™**

POWERED BY  
**QUICKSET®**

**HEVC Advance™**  
Covered by Patents at [patentlist.hevcadvance.com](http://patentlist.hevcadvance.com)

**HDMI™**  
HIGH-DEFINITION MULTIMEDIA INTERFACE

The terms HDMI and HDMI High-Definition Multimedia Interface, and the HDMI Logo are trademarks or registered trademarks of HDMI Licensing LLC in the United States and other countries.



# FCC and Warranty Information

## Federal Communication Commission Interference Statement

This equipment has been tested and found to comply with the limits for a Class B digital device, pursuant to Part 15 of the FCC Rules. These limits are designed to provide reasonable protection against harmful interference in a residential installation. This equipment generates, uses and can radiate radio frequency energy and, if not installed and used in accordance with the instructions, may cause harmful interference to radio communications. However, there is no guarantee that interference will not occur in a particular installation. If this equipment does cause harmful interference to radio or television reception, which can be determined by turning the equipment off and on, the user is encouraged to try to correct the interference by one of the following measures:

- Reorienting or relocating the receiving antenna.
- Increasing the separation between the equipment and receiver.
- Connecting the radio or TV to an outlet that is on a different circuit than the equipment.
- Consulting the dealer or an experienced radio/TV technician for help.

**FCC Caution:** Any changes or modifications not expressly approved by the party responsible for compliance could void the user's authority to operate this equipment.

This device complies with Part 15 of the FCC Rules. Operation is subject to the following two conditions: (1) This device may not cause harmful interference, and (2) this device must accept any interference received, including interference that may cause undesired operation.

For products available in the US and Canadian markets, only channels 1~11 are available. You cannot select other channels.

This device and its antenna(s) must not be co-located or operated in conjunction with any other antenna or transmitter.

### **FCC Radiation Exposure Statement:**

This equipment complies with FCC radiation exposure limits set forth for an uncontrolled environment. This equipment should be installed and operated so there is at least 8 inches (20 cm) between the radiator and your body.

## LIMITED WARRANTY TO ORIGINAL PURCHASER

This SAMSUNG brand product, as supplied and distributed by SAMSUNG and delivered new, in the original carton to the original consumer purchaser, is warranted by SAMSUNG against manufacturing defects in materials and workmanship for period of:

Categories	Parts	Labor	Size	Service
LCD/LED TV	1 Year	1 Year	42" and Larger	Carry-In or In Home
			40" and Smaller	Carry-In

- For commercial use, the warranty is 90 Days Parts and Labor.

This limited warranty begins on the original date of purchase, and is valid only on products purchased and used in the United States. To receive warranty service, the purchaser must contact SAMSUNG for problem determination and service procedures.

Warranty service can only be performed by a SAMSUNG authorized service center. The original dated bill of sale must be presented upon request as proof of purchase to SAMSUNG or SAMSUNG's authorized service center.

SAMSUNG will repair or replace this product, at our option and at no charge as stipulated herein, with new or reconditioned parts or products if found to be defective during the limited warranty period specified above. All replaced parts and products become the property of SAMSUNG and must be returned to SAMSUNG. Replacement parts and products assume the remaining original warranty, or ninety (90) days, whichever is longer.

Certain products are eligible for In-home service at Samsung's discretion. To receive in-home service, the product must be unobstructed and accessible to service personnel. If during in-home service, repair cannot be completed, it may be necessary to remove, repair and return the product. If in-home service is unavailable, SAMSUNG may elect, at our option, to provide for transportation of our choice to and from a SAMSUNG authorized service center. Otherwise, transportation to and from the SAMSUNG authorized service center is the responsibility of the purchaser.

This limited warranty covers manufacturing defects in materials and workmanship encountered in normal, and except to the extent otherwise expressly provided for in this statement, noncommercial use of this product, and shall not apply to the following, including, but not limited to: damage which occurs in shipment; delivery and installation; applications and uses for which this product was not intended; altered product or serial numbers; cosmetic damage or exterior finishes; accidents, abuse, neglect, fire, water, lightning or other acts of nature; use of products, equipment, systems, utilities, services, parts, supplies, accessories, applications, installations, repairs, external wiring or connectors not supplied or authorized by SAMSUNG which damage this product or result in service problems; incorrect electrical line voltage, fluctuations and surges; customer adjustments and failure to follow operating instructions, cleaning, maintenance and environmental instructions that are covered and prescribed in the instruction book; reception problems and distortion related to noise, echo, interference or other signal transmission and delivery problems; or brightness related to normal aging or any other issues if the TV is used for commercial or non-normal consumer use. SAMSUNG does not warrant uninterrupted or error-free operation of the product.

THERE ARE NO EXPRESS WARRANTIES OTHER THAN THOSE LISTED AND DESCRIBED ABOVE, AND NO WARRANTIES WHETHER EXPRESS OR IMPLIED, INCLUDING, BUT NOT LIMITED TO, ANY IMPLIED WARRANTIES OF MERCHANTABILITY OR FITNESS FOR A PARTICULAR PURPOSE, SHALL APPLY AFTER THE EXPRESS WARRANTY PERIODS STATED ABOVE, AND NO OTHER EXPRESS WARRANTY OR GUARANTY GIVEN BY ANY PERSON, FIRM OR CORPORATION WITH RESPECT TO THIS PRODUCT SHALL BE BINDING ON SAMSUNG. SAMSUNG SHALL NOT BE LIABLE FOR LOSS OF REVENUE OR PROFITS, FAILURE TO REALIZE SAVINGS OR OTHER BENEFITS, OR ANY OTHER SPECIAL, INCIDENTAL OR CONSEQUENTIAL DAMAGES CAUSED BY THE USE, MISUSE OR INABILITY TO USE THIS PRODUCT, REGARDLESS OF THE LEGAL THEORY ON WHICH THE CLAIM IS BASED, AND EVEN IF SAMSUNG HAS BEEN ADVISED OF THE POSSIBILITY OF SUCH DAMAGES. NOR SHALL RECOVERY OF ANY KIND AGAINST SAMSUNG BE GREATER IN AMOUNT THAN THE PURCHASE PRICE OF THE PRODUCT SOLD BY SAMSUNG AND CAUSING THE ALLEGED DAMAGE. WITHOUT LIMITING THE FOREGOING, PURCHASER ASSUMES ALL RISK AND LIABILITY FOR LOSS, DAMAGE OR INJURY TO PURCHASER AND PURCHASER'S PROPERTY AND TO OTHERS AND THEIR PROPERTY ARISING OUT OF THE USE, MISUSE OR INABILITY TO USE THIS PRODUCT SOLD BY SAMSUNG NOT CAUSED DIRECTLY BY THE NEGLIGENCE OF SAMSUNG. THIS LIMITED WARRANTY SHALL NOT EXTEND TO ANYONE OTHER THAN THE ORIGINAL PURCHASER OF THIS PRODUCT, IS NONTRANSFERABLE AND STATES YOUR EXCLUSIVE REMEDY.

Some states do not allow limitations on how long an implied warranty lasts, or the exclusion or limitation of incidental or consequential damages, so the above limitations or exclusions may not apply to you. This warranty gives you specific legal rights, and you may also have other rights which vary from state to state.

To obtain warranty service, please contact SAMSUNG at:

Samsung Electronics America, Inc.  
85 Challenger Road  
Ridgefield Park, NJ 07660-2112  
1-800-SAMSUNG (726-7864) – [www.samsung.com](http://www.samsung.com)

The benefits of this Limited Warranty extend only to the original purchaser of Samsung products from an authorized Samsung reseller. THIS LIMITED WARRANTY SHALL NOT APPLY TO ANY SAMSUNG PRODUCTS PURCHASED FROM UNAUTHORIZED RESELLERS OR RETAILERS, EXCEPT IN STATES WHERE SUCH RESTRICTION MAY BE PROHIBITED. For a list of Samsung authorized retailers, please go to: [http://www.samsung.com/us/peaceofmind/authorized\\_resellers.html](http://www.samsung.com/us/peaceofmind/authorized_resellers.html).

# SAMSUNG

## Contact SAMSUNG WORLD WIDE

If you have any questions or comments relating to Samsung products, please contact the SAMSUNG customer care center.

Country	Customer Care Center ☎	Web Site	Address
CANADA	1-800-SAMSUNG (726-7864)	<a href="http://www.samsung.com/ca/support">www.samsung.com/ca/support</a> (English) <a href="http://www.samsung.com/ca_fr/support">www.samsung.com/ca_fr/support</a> (French)	Samsung Electronics Canada Inc. 2050 Derry Road West Mississauga, Ontario L5N 0B9 Canada
U.S.A	1-800-SAMSUNG (726-7864)	<a href="http://www.samsung.com/us/support">www.samsung.com/us/support</a>	Samsung Electronics America, Inc. 85 Challenger Road Ridgefield Park, NJ 07660

accessibility contact information in U.S.A. : [accessibility@sea.samsung.com](mailto:accessibility@sea.samsung.com)

Scan the QR code to view our helpful how-to videos



Scan this QR code with your smart phone to see helpful videos.

If you experience issues, please do not take the TV back to the store.

In the United States of America, call us at 1-800-SAMSUNG (1-800-726-7864) or visit us at [www.samsung.com](http://www.samsung.com) or [www.samsung.com/spsn](http://www.samsung.com/spsn) for support and warranty service.



For more information, see "Troubleshooting" in this manual.

