



| PZN2410  
LCD Monitor

# USER'S GUIDE

[www.planar.com](http://www.planar.com)

The information contained in this document is subject to change without notice. This document contains proprietary information that is protected by copyright. All rights are reserved. No part of this document may be reproduced, translated to another language or stored in a retrieval system, or transmitted by any means, electronic, mechanical, photocopying, recording, or otherwise, without prior written permission. Windows is a registered trademark of Microsoft Inc. Other brand or product names are trademarks of their respective holders.

# | TABLE OF CONTENTS

FOR YOUR SAFETY .....	3
PRECAUTIONS .....	4
SPECIAL NOTES ON LCD MONITORS .....	6
BEFORE YOU OPERATE THE MONITOR .....	6
FEATURES .....	6
PACKAGE LIST .....	7
Installation instructions .....	8
Attach the base and cable organizer .....	8
CONTROLS AND CONNECTORS .....	9
ADJUSTING THE VIEWING ANGLE .....	10
OPERATING INSTRUCTIONS .....	11
GENERAL INSTRUCTIONS .....	11
FRONT PANEL CONTROL .....	12
HOW TO ADJUST A SETTING .....	13
ADJUSTING THE PICTURE .....	14
PLUG AND PLAY .....	16
TECHNICAL SUPPORT (FAQ) .....	18
ERROR MESSAGE & POSSIBLE SOLUTION .....	18
APPENDIX .....	19
SPECIFICATIONS .....	19
FACTORY PRESET TIMING TABLE .....	20
CONNECTOR PIN ASSIGNMENT .....	21
WALL MOUNTING (OPTIONAL) .....	24
PLANAR SUPPORT .....	25

## | FOR YOUR SAFETY

Before operating the monitor, please read this manual thoroughly. This manual should be retained for future reference.

### **FCC Class B Radio Frequency Interference Statement**

#### **WARNING: (FOR FCC CERTIFIED MODELS)**

**NOTE:** This equipment has been tested and found to comply with the limits for a Class B digital device, pursuant to Part 15 of the FCC Rules. These limits are designed to provide reasonable protection against harmful interference in a residential installation. This equipment generates, uses and can radiate radio frequency energy, and if not installed and used in accordance with the instructions, may cause harmful interference to radio communications. However, there is no guarantee that interference will not occur in a particular installation. If this equipment does cause harmful interference to radio or television reception, which can be determined by turning the equipment off and on, the user is encouraged to try to correct the interference by one or more of the following measures:

1. Reorient or relocate the receiving antenna.
2. Increase the separation between the equipment and receiver.
3. Connect the equipment into an outlet on a circuit different from that to which the receiver is connected.
4. Consult the dealer or an experienced radio/TV technician for help.

#### **NOTICE:**

1. The changes or modifications not expressly approved by the party responsible for compliance could void the user's authority to operate the equipment.
2. Shielded interface cables and AC power cord, if any, must be used in order to comply with the emission limits.
3. The manufacturer is not responsible for any radio or TV interference caused by unauthorized modification to this equipment. It is the responsibilities of the user to correct such interference.

#### **WARNING:**

To prevent fire or shock hazard, do not expose the monitor to rain or moisture. Dangerously high voltages are present inside the monitor. Do not open the cabinet. Refer servicing to qualified personnel only.

This device complies with Part 15 of the FCC Rules. Operation is subject to the following two conditions: (1) This device may not cause harmful interference, and (2) this device must accept any interference received, including interference that may cause undesired operation.

## Disposal of waste equipment by user in private household in the European Union



This symbol on the product or on its packaging indicates that this product must not be disposed of with your other household waste. Instead, it is your responsibility to dispose of your waste equipment by handing it over to a designated collection point for the recycling of waste electrical and electronic equipment. The separate collection and recycling of your waste equipment at the time of disposal will help to conserve natural resources and ensure that it is recycled in a manner that protects human health and the environment. For more information about where you can drop off your waste equipment for recycling, please contact your local city office, your household waste disposal service or the shop where you purchased the product.

## PRECAUTIONS

- Do not use the monitor near water, e.g. near a bathtub, washbowl, kitchen sink, laundry tub, swimming pool or in a wet basement.
- Do not place the monitor on an unstable cart, stand, or table. If the monitor falls, it can injure a person and cause serious damage to the appliance. Use only a cart or stand recommended by the manufacturer or sold with the monitor. If you mount the monitor on a wall or shelf, use a mounting kit approved by the manufacturer and follow the kit instructions.
- Slots and openings in the back and bottom of the cabinet are provided for ventilation. To ensure reliable operation of the monitor and to protect it from overheating, be sure these openings are not blocked or covered. Do not place the monitor on a bed, sofa, rug, or similar surface. Do not place the monitor near or over a radiator or heat register. Do not place the monitor in a bookcase or cabinet unless proper ventilation is provided.
- The monitor should be operated only from the type of power source indicated on the label. If you are not sure of the type of power supplied to your home, consult your dealer or local power company.
- The monitor is equipped with a three-pronged grounded plug, a plug with a third (grounding) pin. This plug will fit only into a grounded power outlet as a safety feature. If your outlet does not accommodate the three-wire plug, have an electrician install the correct outlet, or use an adapter to ground the appliance safely. Do not defeat the safety purpose of the grounded plug.
- Unplug the unit during a lightening storm or when it will not be used for long period of time. This will protect the monitor from damage due to power surges.
- Do not overload power strips and extension cords. Overloading can result in fire or electric shock.
- Never push any object into the slot on the monitor cabinet. It could short circuit parts causing a fire or electric shock. Never spill liquids on the monitor.

- Do not attempt to service the monitor by yourself; opening or removing covers can expose you to dangerous voltages and other hazards. Please refer all servicing to qualified service personnel.
- To ensure satisfactory operation, use the monitor only with UL listed computers which have appropriate configured receptacles marked between 100 - 240V AC, Min. 5A.
- The wall socket shall be installed near the equipment and shall be easily accessible.
- Do not operate the product over 16 hours per day.

## SPECIAL NOTES ON LCD MONITORS

The following symptoms are normal with LCD monitor and do not indicate a problem.

### NOTES AND CLEANING

- Due to the nature of the fluorescent light, the screen may flicker during initial use. Turn off the Power Switch and then turn it on again to make sure the flicker disappears.
- You may find slightly uneven brightness on the screen depending on the desktop pattern you use.
- The LCD screen has effective pixels of 99.99% or more. It may include blemishes of 0.01% or less such as a missing pixel or a pixel lit all of the time.
- Due to the nature of the LCD screen, an after image of the previous screen may remain after switching the image, when the same image is displayed for hours. In this case, the screen is recovered slowly by changing the image or turning off the Power Switch for hours.
- When the screen becomes black or flashing, or cannot illuminate any more, contact your dealer or service center to replace parts. Don't repair the screen by yourself!
- To keep the monitor looking new, periodically clean it with a soft cloth. Stubborn stains may be removed with a cloth lightly dampened with a mild detergent solution. Never use strong solvents such as thinner, benzene, or abrasive cleaners, since these will damage the cabinet. As a safety precaution, always unplug the monitor before cleaning it.
- Do not scratch the screen with hard things as it may cause permanent damage.
- Do not allow liquids into monitor as it will result in component damage.

## BEFORE YOU OPERATE THE MONITOR

### FEATURES

- 23.8" (60.4 cm) Wide Screen TFT Color Monitor
- Crisp, Clear Display for Windows
- Recommended Resolutions: 1920\*1080@60Hz
- Ergonomic Design
- Space Saving, Compact Case Design



Use extreme caution when unpacking your monitor as the deskstand is spring-loaded. Failure to follow the instructions below may lead to physical harm.

1. Lay the monitor flat on an even surface –display facing up.
2. Remove Styrofoam
3. Remove the orange strap
4. Remove the bag.

# PACKAGE LIST

The product package should include the following items:

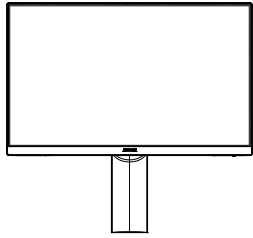

Monitor



Cable Organizer



User's Guide

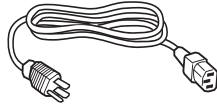

Power cable

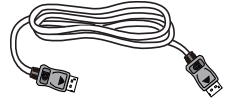

DP cable

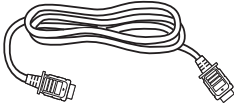

HDMI cable

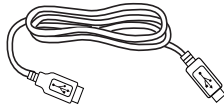

USB 3.0 cable

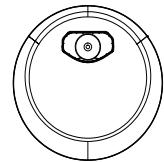

Base



# Installation instructions

## Attach the base and cable organizer

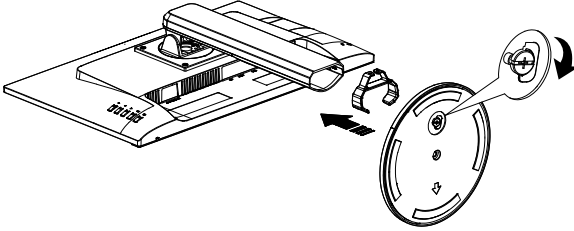

# CONTROLS AND CONNECTORS

## POWER CORD

### Power Source:

1. Make sure that the power cord is the correct type required in your area.
2. This monitor has an internal universal power supply that allows operation in either 100/120V AC or 220/240V AC voltage area (No user adjustment is required.)
3. Connect the AC-power cord into the monitor's power input socket, The AC-power cord may be connected to either a wall power outlet or the power outlet socket on your PC, depending on the type of power cord supplied with your monitor.

## SIGNAL CABLE

**Connecting the Signal Cable :** Plug one end of the signal cable to the LCD monitor and the other end to a computer or a video source.

**Caution:** If the AC outlet is not grounded (with three holes), install the proper grounding adapter (not supplied).

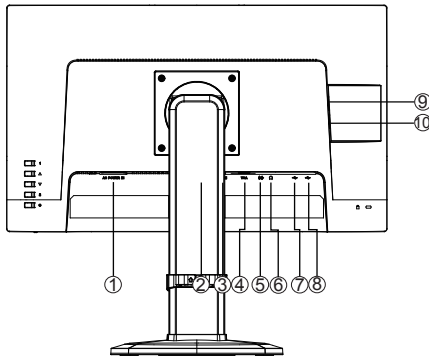

Figure 2 Connecting Cables

1.	AC input	6.	Audio output
2.	DP input	7.	Upstream
3.	HDMI input	8.	Downstream
4.	VGA input	9.	Downstream and charging port
5.	Audio input	10.	Downstream

## ADJUSTING THE VIEWING ANGLE

- For optimal viewing it is recommended to look at the full face of the monitor, then adjust the monitor's angle to your own preference.
- Hold the stand so you do not topple the monitor when you change the monitor's angle.
- You are able to adjust the monitor's angle from  $-5^{\circ}$  to  $20^{\circ}$ .

### Swivel

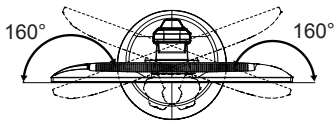

### Tilt

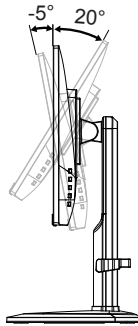

### Pivot

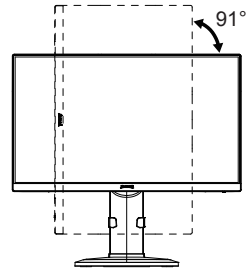

Figure 3

## NOTES

- Do not touch the screen when you change the angle. It may cause damage or break the screen.
- Careful attention is required not to catch your fingers or hands when you change the angle.

# OPERATING INSTRUCTIONS

## GENERAL INSTRUCTIONS

The control buttons are located at the back of the monitor (See Figure 4). Press the power button to turn the monitor on or off. By changing these settings, the picture can be adjusted to your personal preferences.

- The power cord should be connected.
- Connect the video cable from the monitor to the video card.
- Press the power button to turn on the monitor. The power indicator will light up.

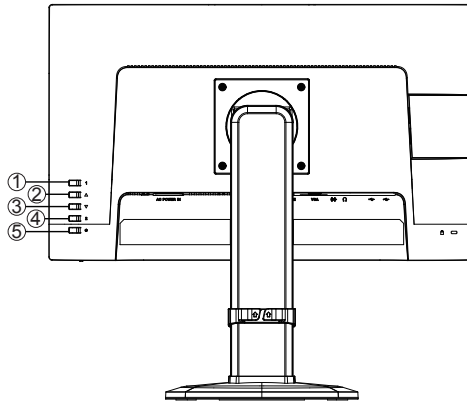

Figure 4 External Control Button

1.	OSD On / Off / Exit Selection
2.	Scroll Up / Adjust Increase / Blue Light Reducer / Volume
3.	Scroll Down / Adjust Decrease / ECO
4.	Input select / Confirm selection / Auto
5.	Power On / Off

## PANEL CONTROL

- **Power Button:**  
Press this button to switch ON/OFF monitor's power.
- **Power Indicator:**  
Blue — Power on mode.  
Orange — Power saving mode.
- **[1]: OSD / Exit :**  
Activates OSD menu or exit selection.
- **▲ : Volume / Blue Light Reducer :**  
Activates the volume control when the OSD is OFF or navigate through adjustment icons when OSD is ON or adjust a function when function is activated.  
Blue Light Reducer hot key: When the OSD is OFF, press and hold the UP key for 3 seconds will be Blue Light Reducer function.
- **▼ : ECO**  
Activates the ECO control when the OSD is OFF or navigate through adjustment icons when OSD is ON or adjust a function when function is activated.
- **[2]: Input Select / Enter :**  
When the OSD is OFF, pressing [2] button will call out input select. Use the up/down arrow to select input. Press [2] to confirm selection.  
**OSD Lock Function:** All 4 buttons are locked except Power button. Hold the [1] button for 5 seconds to lock/unlock.  
**Power & OSD Lock Function:** All 5 buttons including the Power button are locked. Hold the Power key for 5 seconds to lock/unlock.

## NOTES

- Do not install the monitor in a location near heat sources such as radiators or air ducts, or in a place subject to direct sunlight, or excessive dust or mechanical vibration or shock.
- Save the original shipping carton and packing materials, as they will come in handy if you ever have to ship your monitor.
- For maximum protection, repackage your monitor as it was originally packed at the factory.

## HOW TO ADJUST A SETTING

1. Press the [1]-button to activate the OSD window.
2. Press ▲ or ▼ to navigate through the functions. Once the desired function is highlighted, press the [2]-button to activate it. If the function selected has a sub-menu, press ▲ or ▼ again to navigate through the sub-menu functions. Once the desired function is highlighted, press [2]-button to activate it.
3. Press ▲ or ▼ to change the settings of the selected function. To exit and save, select the [1] function.
4. If you want to adjust any other function, repeat steps 2-3.

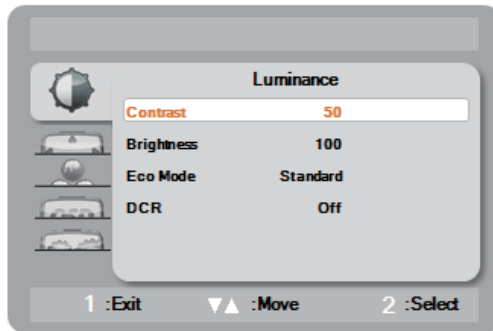







Figure 5 The OSD Message

## ADJUSTING THE PICTURE

Main Menu Item	Main Menu Icon	1 <sup>st</sup> Sub Menu Item	Description
Luminance		Contrast	Adjusts contrast levels.
		Brightness	Adjusts backlight levels.
		Eco Mode	Picture Adjustment, Standard: Brightness = 90, Contrast = 50. Brightness, Contrast Adjustable
			Text: Brightness = 20, Contrast = 50. Brightness, Contrast Grayed.
			Internet: Brightness = 40, Contrast = 50. Brightness, Contrast Grayed.
			Game: Brightness = 60 Contrast = 50, Brightness, Contrast Grayed.
			Movie: Brightness = 80, Contrast = 50, Brightness, Contrast Grayed.
			Sports: Brightness = 100, Contrast = 50, Brightness, Contrast Grayed.
			DCR
		DPS	DPS (Display Power Saver) On/Off.
Image Setup		Clock	Adjust picture Clock to reduce Vertical-Line noise.
		Phase	Adjust Picture Phase to reduce Horizontal-Line noise.
		H. Position	Adjust the horizontal position of the picture.
		V. Position	Adjust the vertical position of the picture.
		Image Ratio	Select Image Aspect Ratio.
		OD	Overdrive Adjustment.
		Color Range	Select color range for HDMI only.

Main Menu Item	Main Menu Icon	1 <sup>st</sup> Sub Menu Item	Description
Color Temp.		Warm	Warm Color Temperature.
		Normal	Normal Color Temperature.
		Cool	Cool Color Temperature.
		User	Adjust R.G.B levels as desired. User-R: Red Gain from Digital-register. User-G: Green Gain from Digital-register. User-B: Blue Gain from Digital-register.
		sRGB	Recall sRGB Color Temperature.
		Blue Light Reducer	(15% reduction) - VIDEO – Ideal for watching videos (30% reduction) - WEB BROWSING – Ideal for web browsing (50% reduction) - READING – Ideal for reading (70% reduction)- LOW LIGHT – Ideal for low ambient lighting environments
OSD Setup		H. Position	Adjust the horizontal position of the OSD.
		V. Position	Adjust the vertical position of the OSD.
		Timeout	Adjust the OSD timeout.
		Language	Set OSD display language . ( English is default setting )
Extra		Input Select	Select input.
		DDC/CI	Select DDC/CI On or Off.
		Reset	Set Monitor to default status.
		Information	Show the resolution, H/V as above format including all video timing.



## **PLUG AND PLAY**

### **Plug & Play DDC2B Feature**

This monitor is equipped with VESA DDC2B capabilities according to the VESA DDC STANDARD. It allows the monitor to inform the host system of its identity and, depending on the level of DDC used, communicate additional information about its display capabilities.

The DDC2B is a bidirectional data channel based on the I<sup>2</sup>C protocol. The host can request EDID information over the DDC2B channel.

**THIS MONITOR WILL APPEAR TO BE NON-FUNCTIONAL IF THERE IS NO VIDEO INPUT SIGNAL. IN ORDER FOR THIS MONITOR TO OPERATE PROPERLY, THERE MUST BE A VIDEO INPUT SIGNAL.**

This monitor meets the Green monitor standards as set by the Video Electronics Standards Association (VESA) and The Swedish Confederation Employees (NUTEK). This feature is designed to conserve electrical energy by reducing power consumption when there is no video-input signal present. When there is no video input signal this monitor, following a time-out period, will automatically switch to an OFF mode. This reduces the monitor's internal power supply consumption. After the video input signal is restored, full power is restored and the display is automatically redrawn. The appearance is similar to a "Screen Saver" feature except the display is completely off. The display is restored by pressing a key on the keyboard, or clicking the mouse.

### **USING THE RIGHT POWER CORD :**

The accessory power cord for the Northern American region is the wallet plug with NEMA 5-15 style and is UL listed and CSA labeled. The voltage rating for the power cord shall be 125 volts AC.

Supplied with units intended for connection to power outlet of personal computer: Please use a cord set consisting of a minimum No. 18 AWG, type SJT or SVT three conductors flexible cord. One end terminates with a grounding type attachment plug, rated 10A, 250V, CEE-22 male configuration. The other end terminates with a molded-on type connector body, rated 10A, 250V, having standard CEE-22 female configuration.

Please note that power supply cord needs to use VDE 0602, 0625, 0821 approval power cord in European countries.

## TECHNICAL SUPPORT (FAQ)

Problem & Question	Possible Solution
Power LED is not on	<ul style="list-style-type: none"> <li>* Check if the Power Switch is in the ON position.</li> <li>* Power Cord should be connected.</li> </ul>
No Plug & Play	<ul style="list-style-type: none"> <li>* Check if the PC system is Plug &amp; Play compatible.</li> <li>* Check if the Video Card is Plug &amp; Play compatible.</li> <li>* Check if the D-15 plug pin of Video Cable is bent.</li> </ul>
Picture is fuzzy	<ul style="list-style-type: none"> <li>* Adjust the Contrast and Brightness Controls.</li> </ul>
Picture bounces or a wave pattern is present in the picture	<ul style="list-style-type: none"> <li>* Move electrical devices that may cause electrical interference.</li> </ul>
The power LED is ON (Amber) but there's no video or no picture.	<ul style="list-style-type: none"> <li>* Computer Power Switch should be in the ON position.</li> <li>* Computer Video Card should be snugly seated in its slot.</li> <li>* Make sure monitor's video cable is properly connected to the computer.</li> <li>* Inspect monitor's video cable and make sure none of the pins are bent.</li> <li>* Make sure computer is operational by hitting the CAPS LOCK key on the keyboard while observing the CAPS LOCK LED. The LED should either turn ON or OFF after hitting the CAPS LOCK key.</li> </ul>
Missing one of the primary colors (RED, GREEN, or BLUE)	<ul style="list-style-type: none"> <li>* Inspect the monitor's video cable and make sure that none of the pins are bent.</li> </ul>
Screen image is not centered or sized properly.	<ul style="list-style-type: none"> <li>* Adjust pixel frequency (CLOCK) and PHASE.</li> </ul>
Picture has color defects (white does not look white)	<ul style="list-style-type: none"> <li>* Adjust RGB color or select color temperature.</li> </ul>
Poor brightness or contrast	<ul style="list-style-type: none"> <li>* When the brightness of the screen lowers after being used for a certain period and the function of the display is affected, send it to our authorized service center for repair.</li> </ul>
Horizontal or vertical disturbances on the screen	<ul style="list-style-type: none"> <li>* Adjust CLOCK and PHASE.</li> </ul>

## **TECHNICAL SUPPORT (FAQ)**

CLOCK (pixel frequency) controls the number of pixels scanned by one horizontal sweep. If the frequency is not correct, the screen shows vertical stripes and the picture has not correct width.

PHASE adjusts the phase of the pixel clock signal. With a wrong phase adjustment the picture has horizontal disturbances in light picture.

For PHASE and CLOCK adjustment use "dot-pattern".

## **ERROR MESSAGE & POSSIBLE SOLUTION**

### **NO SIGNAL:**

1. Check that the signal-cable is properly connected, if the connector is loose, tighten the connector's screws.
2. Check the signal-cable's connection pins for damage.

### **INPUT NOT SUPPORT:**

Your computer has been set to unsuitable display mode, set the computer to display mode given in the following table.

# APPENDIX

## SPECIFICATIONS

LCD Panel	Driving system	TFT Color LCD
	Size	60.4cm (23.8")
	Pixel pitch	0.2745 (H) × 0.2745 (V)
Input	Video	Digital
	H-Frequency	30kHz – 85kHz
	V-Frequency	48-76Hz
Display Colors		16.7M
Dot Clock		174.5MHz
Max. Resolution		1920 × 1080@60Hz
Plug & Play		DDC 1/2B/CI or VESA DDC2B™
Power Consumption	ON Mode	22W (typ.)
	OFF Mode	<0.5W
Input Connector		15-pin D-Sub, 20-pin DP, 19-pin HDMI
Input Video Signal		15-pin D-Sub, 20-pin DP, 19-pin HDMI
USB Downstream Port	USB 2.0 Location: Downside of monitor x 2 Output Voltage: 5.0V Output current: 500ma	
	USB 3.0 Location: Side of monitor x 1 (Blue) Output Voltage: 5.0V Output current: 900ma	
	USB 3.0 BC1.2 Location: Side of monitor x 1 (Yellow) Output Voltage: 5.0V Output current: 1500ma	
Power Source		100~240VAC, 50/60Hz
Environmental Considerations		Operating Temp.: 0°C to 40°C Storage Temp.: -20°C to 60°C Operating Humidity: 10% to 85%
Dimensions (W x H X D)		540.5mm x (502.1~373.9)mm × 244.5mm
Weight (N. W.)		5.63kg

## FACTORY PRESET TIMING TABLE

<b>RESOLUTION</b>	<b>HORIZONTAL FREQUENCY(KHZ)</b>	<b>VERTICAL FREQUENCY(Hz)</b>
640x480@60Hz	31.469	59.940
640x480@67Hz	35.000	66.667
640x480@72Hz	37.861	72.809
640x480@75Hz	37.500	75.00
720x400@70Hz	31.469	70.087
800x600@56Hz	35.156	56.250
800x600@60Hz	37.879	60.317
800x600@72Hz	48.077	72.188
800x600@75Hz	46.875	75.000
832x624@75Hz	49.725	74.551
1024x768@60Hz	48.363	60.004
1024x768@70Hz	56.476	70.069
1024x768@75Hz	60.023	75.029
1280x1024@60Hz	63.981	60.020
1280x1024@75Hz	79.976	75.025
1152x864@75Hz	67.500	75.000
1280x960@60Hz	60.000	60.000
1280x720@50Hz	37.500	50.000
1280x720@60Hz	45.000	60.000
1440x900@60Hz	55.935	59.887
1440x900@60Hz	55.469	59.901
1440x900@75Hz	74.984	70.635
1680x1050@60Hz	65.290	59.954
1680x1050@60Hz	64.674	59.883
1920x1080@50Hz	56.250	50.000
1920x1080@60Hz	67.500	60.000

## CONNECTOR PIN ASSIGNMENT

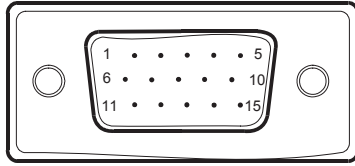

15 - Pin Color Display Signal Cable

PIN NO.	DESCRIPTION	PIN NO.	DESCRIPTION
1.	Red	9.	+5V
2.	Green	10.	Ground
3.	Blue	11.	Ground
4.	Ground	12.	DDC-Serial Data
5.	Detect Cable	13.	H-Sync
6.	R-Ground	14.	V-Sync
7.	G-Ground	15.	DDC-Serial Clock
8.	B-Ground		

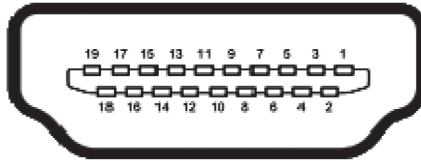

19 - Pin Color Display Signal Cable

PIN NO.	DESCRIPTION	PIN NO.	DESCRIPTION
1.	TMDS Data 2+	11.	TMDS Clock Shield
2.	TMDS Data 2 Shield	12.	TMDS Clock
3.	TMDS Data 2-	13.	CEC
4.	TMDS Data 1+	14.	Reserved (N.C. on device)
5.	TMDS Data 1 Shield	15.	SCL
6.	TMDS Data 1-	16.	SDA
7.	TMDS Data 0+	17.	DDC/CEC Ground
8.	TMDS Data 0 Shield	18.	+5V Power
9.	TMDS Data 0-	19.	Hot Plug Detect
10.	TMDS Clock+		

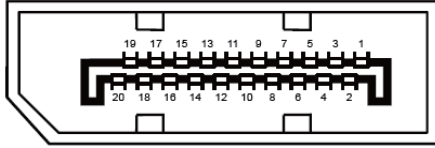

20 - Pin Color Display Signal Cable

PIN NO.	DESCRIPTION	PIN NO.	DESCRIPTION
1.	ML_Lane 3 (n)	11.	GND
2.	GND	12.	ML_Lane 0 (p)
3.	ML_Lane 3 (p)	13.	CONFIG1
4.	ML_Lane 2 (n)	14.	CONFIG2
5.	GND	15.	AUX_CH(p)
6.	ML_Lane 2 (p)	16.	GND
7.	ML_Lane 1 (n)	17.	AUX_CH(n)
8.	GND	18.	Hot Plug Detect
9.	ML_Lane 1 (p)	19.	Return DP_PWR
10.	ML_Lane 0 (n)	20.	DP_PWR



## WALL MOUNTING (OPTIONAL)

Refer to the instructions that come with the base mounting kit. To convert your display from a desk-mounted to a wall-mounted display, do the following:

1. Verify that the power button is turned Off, then disconnect the power cord.
2. Remove the plastic covers from the back of the display.
3. Remove the four screws attaching the base (screw dimension: M4 x 12mm).
4. Attach the mounting bracket from the VESA compatible wall mounting kit (100 mm x 100 mm distance).
5. Attach the display to the wall, following the instructions in the wall-mounting kit.

**NOTE:** For use only with wall mount bracket with minimum weight/load: 26.5lb (12kg.)

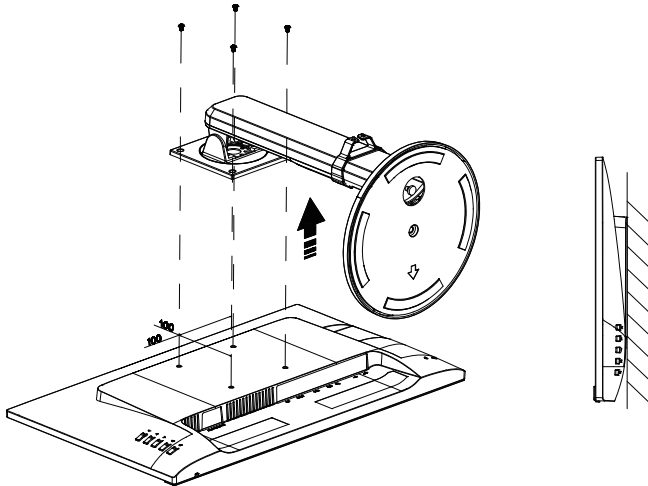

# | PLANAR SUPPORT

## **Cables and Accessories**

To find cables and accessories for your Planar monitor, touch screen or other Planar products visit our online store at [www.PlanarOnline.com](http://www.PlanarOnline.com)

## **Technical Support**

Visit Planar at <http://www.planar.com/support> for operations manuals, touch screen drivers, warranty information and access to Planar's Technical Library for online troubleshooting.

To speak with Planar Customer Support please have you model and serial number available and dial:

## **Planar Support**

Tel: 1-866-PLANAR1 (866-752-6271) or +1 503-748-5799 outside the US.

Hours: 24 hours a day, 7 days a week.

**Toll or long distance charges may apply.**

## **Planar Systems, Inc.**

Customer Service

24x7 Online Technical Support: <http://www.planar.com/support>

Planar Address: 1195 NE Compton Drive, Hillsboro, OR 97006 USA

Tel: 1-866-PLANAR1 (866-752-6271), or +1 503-748-5799 outside the United States,

Hours: 24 hours a day, 7 days a week

©04/2019 Planar Systems, Inc.

Planar is a registered trademark of Planar Systems, Inc. Other brands and names are the property of their respective owners. Technical information in this document is subject to change without notice.



Q41G24M193504A