

SAMSUNG Galaxy Watch3



User manual

Contents

Getting started

Device Layout: [LTE model](#) | [Bluetooth model](#)

Set up your device: [Charge the battery](#) | [Wireless PowerShare](#) | [Wear the Watch](#)

Start using your device: [Turn on your device](#) | [Activation](#) | [Galaxy Wearable app](#) | [Lock or unlock your device](#) | [Home key settings](#) | [Navigation](#) | [Change the watch face](#) | [Quick panel](#) | [Notifications](#) | [Water lock mode](#) | [Do not disturb](#) | [Goodnight mode](#) | [Theater mode](#) | [Daily briefing](#) | [Enter text](#)

Apps

[Navigate the apps screen](#) | [Messages](#) | [Phone](#) | [Contacts](#) | [Bixby](#) | [Samsung Health](#) | [Weather](#) | [Calendar](#) | [Galaxy Store](#) | [Samsung Pay](#) | [Reminder](#) | [Microsoft Outlook](#) | [Music](#) | [Gallery](#) | [Find My Phone](#) | [Alarm](#) | [World clock](#) | [Timer](#) | [Stopwatch](#) | [Spotify](#) | [PPT Controller](#) | [Voice Recorder](#) | [Samsung Health Monitor](#)

Settings

Connections: [Bluetooth](#) | [Mobile networks](#) | [Wi-Fi](#) | [NFC](#) | [Disconnection alerts](#) | [Airplane mode](#) | [Connect to a new phone](#)

Sound and vibration: [Sound mode](#) | [Ringtone](#) | [Notification sound](#) | [Volume](#) | [Ringtone vibration](#) | [Notification vibration](#) | [Vibration intensity](#) | [Long vibration](#) | [System sounds](#) | [Vibration feedback](#)

Display: [Adjust screen brightness](#) | [Set the screen timeout](#) | [Show last app](#) | [Background style](#) | [Font style](#) | [Show charging info](#)

Device maintenance: [Date and time](#) | [Power saving mode](#) | [Watch only mode](#) | [Optimize battery](#) | [Related settings](#) | [Reset the Watch](#) | [Location](#)

Lockscreen and security: [Set a screen lock](#) | [Permission manager](#)

Accessibility: [Screen Reader](#) | [Visibility enhancements](#) | [Hearing enhancements](#) | [Advanced settings](#) | [Text to speech](#)

Other: [Screen wake-up](#) | [Touch sensitivity](#) | [Watch status](#) | [Watch info](#)

Learn More

[Videos](#) | [Tips](#) | [Samsung Care](#) | [Talk to an agent](#)

Legal information

[Samsung Knox](#) | [Maintaining water and dust resistance](#) | [Military Specification](#) | [Restricting children's access to your mobile device](#)

Getting started

LTE model

Bluetooth model

Set up your device

Start using your device



LTE model

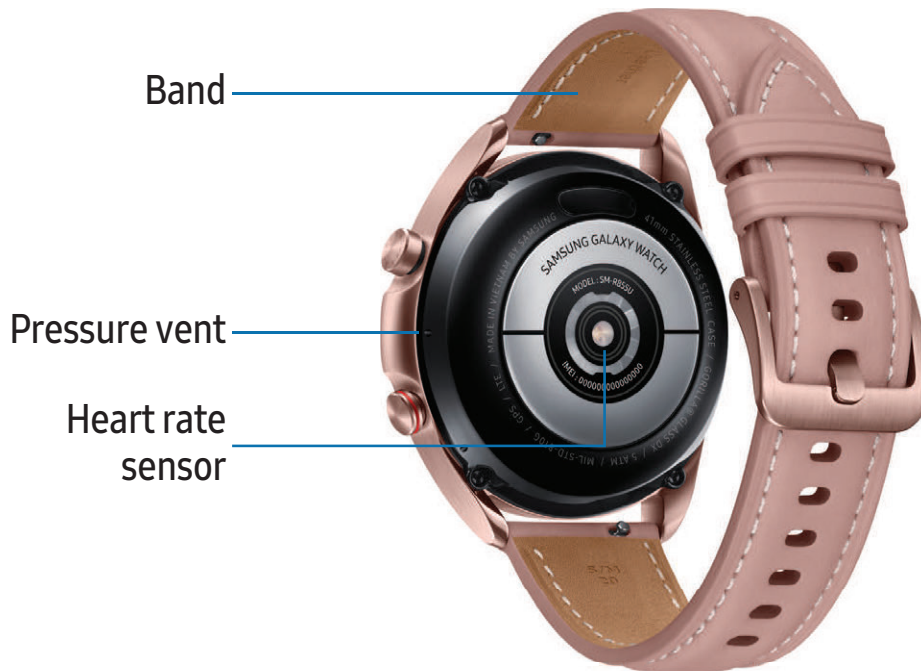

Bluetooth model

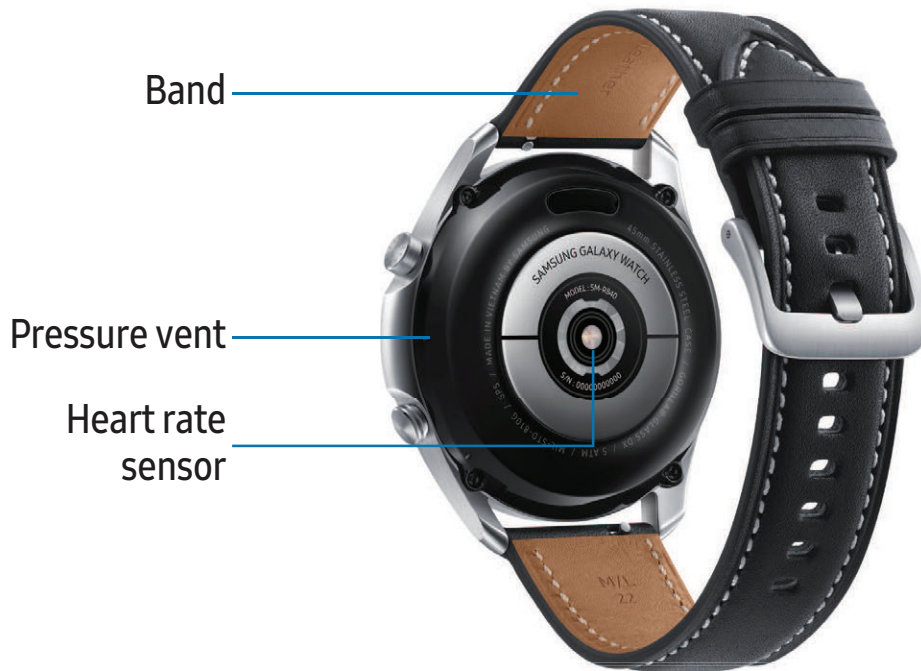

Set up your device

[Charge the battery](#) | [Wireless PowerShare](#) | [Wear the Watch](#)

Learn more about your device hardware, assembling and charging, and how to get started using your new device.

⚠ CAUTION Do not insert sharp objects into the atmospheric pressure sensor, the pressure vent, speaker, or the microphone. Inner components of the watch may be damaged along with the water-resistance feature.

Charge the battery

Your device is powered by a rechargeable battery.

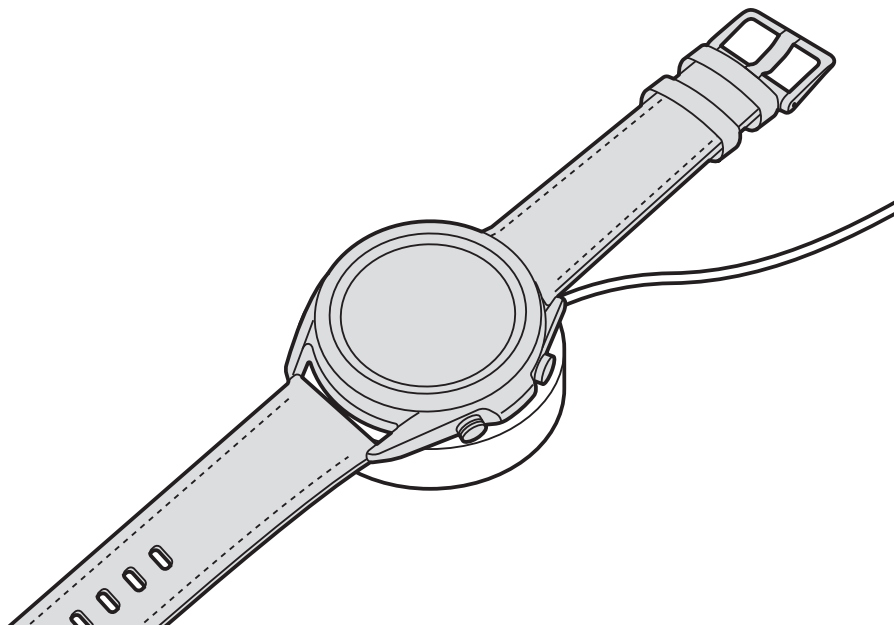

1. Connect the wireless charger to a USB charging port.
2. Place the watch onto the wireless charger, aligning the center of your watch with the center of the wireless charger.
3. After fully charging, disconnect the watch from the wireless charger.

 **CAUTION** The charging head for plugging the USB cable into a wall outlet is not included. Use only Samsung charging devices rated with an output voltage of 5v and an output current of over 150mA (sold separately). Samsung accessories are designed for your device to maximize battery life. Using other accessories may void your warranty and may cause damage.

 **NOTE** Prevent the USB charger port and the small end of the charger cable from coming into contact with conductive materials, such as liquids, dust, metal powders, and pencil leads.

While charging, the device and the charger may become hot. This does not affect the device's lifespan or performance and is in the device's normal range of operation.

Remove the device from the charger and wait for the device to cool down. For more information, visit <https://www.samsung.com/us/support/answer/ANS00076952>.

 **NOTE** Do not disassemble, modify, or repair your device. Placing objects, such as magnetic stripe cards, including credit cards, phone cards, passbooks, and boarding passes, next to the device or charger may cause damage from the charger or device's magnetic field.

Wireless PowerShare

Wirelessly charge your device using a supported Samsung smartphone. Some features are not available while sharing power.



1. From the smartphone, open the Notification panel and, tap  **Wireless PowerShare** to enable this feature.
2. With the smartphone face down, place the device on the back of the smartphone to charge. A notification sound or vibration occurs when charging begins.

 **NOTE** Wireless PowerShare works with most Qi-Certified devices. Requires minimum 30% battery to share. Speed and power efficiency of charge varies by device. May not work with some accessories, covers, or other manufacturer's devices. If you have trouble connecting or charging is slow, remove any cover from each device. May affect call reception or data services, depending on your network environment.

For best results when using Wireless PowerShare, please note:

- Remove any accessories or cover before using the feature. Depending on the type of accessory or cover, Wireless PowerShare may not work properly.
- The location of the wireless charging coil may vary by device, so you may need to adjust the placement to make a connection. When charging starts, a notification or vibration will occur, so the notification will help you know you've made a connection.
- Call reception or data services may be affected, depending on your network environment.
- Charging speed or efficiency can vary depending on device condition or surrounding environment.
- Do not use headphones.

Wear the Watch

Wrap the watch firmly around your lower arm just above your wrist as shown below. Do not fasten the watch too tightly.

⚠ WARNING Wear the device correctly. If you feel discomfort while using the device, stop using it. If your device becomes hot, please remove it until it cools.



1. Open the buckle and place the strap around your wrist.
2. Fit the strap to your wrist, insert the pin into an adjustment hole, and then secure the buckle to close it.

Strap tips and precautions

- Some people may experience discomfort when wearing the watch for prolonged periods.
- If you have sensitive skin or fasten the watch too tightly, you may feel some discomfort.
- Do not expose the straps to very wet conditions. Wet straps can cause skin irritations. Dry the straps first. If you experience skin irritation when wearing the watch, stop wearing it and consult a physician.

Replace the strap

Detach the strap from the watch to replace it with a new one.

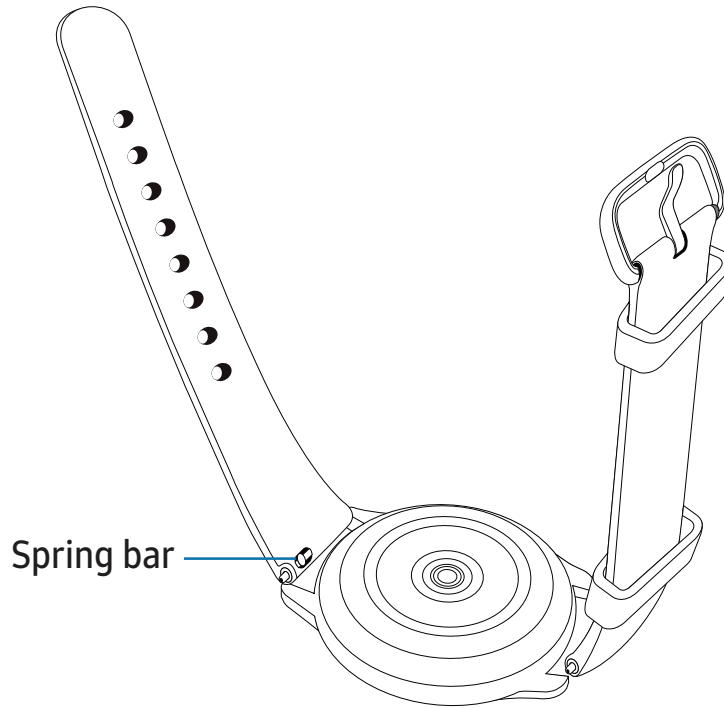

To remove the strap:

- Slide the strap's spring bar inward and pull the strap away from the watch.

To replace the strap:

1. Insert one end of the spring bar into the hole on the side of the watch.
2. Slide the other spring bar inward, and release it once the strap is in place.

Adjust the titanium strap

You can make the titanium strap longer or shorter for a better fit.

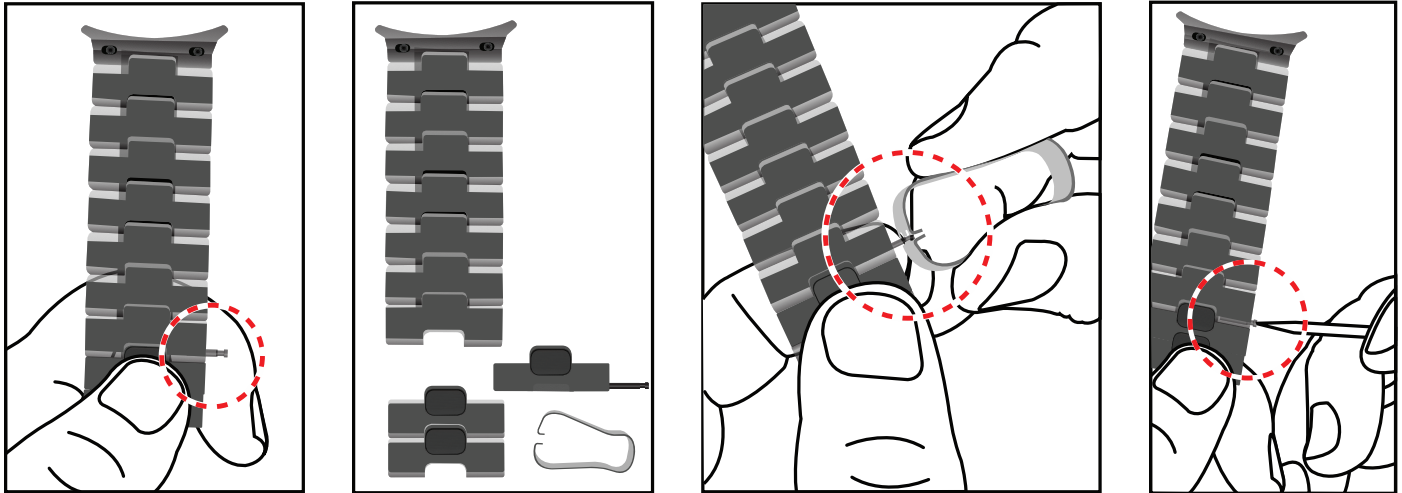

1. Press the button on the strap. The pin will pop out.
2. Use the provided tool to remove the pin.
3. Remove or add links to adjust the strap to your desired length.
4. Replace the pin using a small pointed object.

Start using your device

[Turn on your device](#) | [Activation](#) | [Galaxy Wearable app](#) | [Lock or unlock your device](#) | [Home key settings](#) | [Navigation](#) | [Change the watch face](#) | [Quick panel](#) | [Notifications](#) | [Water lock mode](#) | [Do not disturb](#) | [Goodnight mode](#) | [Theater mode](#) | [Daily briefing](#) | [Enter text](#)

Turn on your device

Use the Home key to turn your watch on or off.

- Press and hold the **Home** key.
 - To turn the watch off, swipe down from the top of the watch screen to open the Quick panel, and tap  > **Power off**.

 **TIP** To restart the watch, press and hold the **Home** and **Back** keys for more than seven seconds.

Activation

The Galaxy Watch3 (R845U and R855U) are 4G LTE-enabled. Get texts, alerts, and make and receive calls, even when you leave your phone behind.

Consult your service provider for more information about activation.



Galaxy Wearable app

To connect your watch to a smartphone, install the Galaxy Wearable app on the smartphone. You can download the app from the Galaxy Store or the Google Play™ store.

Galaxy Wearable is compatible with select devices using Android 5.0 and later with at least 1.5 GB RAM. Supported devices may vary by carrier and device. Some features may not be available. For best results, connect with compatible Samsung Galaxy devices. Visit samsung.com/us/support/owners/app/galaxy-wearable-watch for a list of compatible smartphones.

Connect the watch to a smartphone

Turn on the watch before connecting to your phone.

1. From the Apps screen of the smartphone, tap  **Galaxy Wearable**. If necessary, update the app to the latest version.
2. Tap **Get started** and select your device.
3. When the Bluetooth® pairing request window is displayed, confirm the passkeys displayed on your watch and smartphone match, and then tap  **OK**.
4. Follow the prompts to complete the connection.

When the devices are connected, a tutorial is displayed on the watch's screen. Follow the prompts to learn basic controls.

Back up data

The watch can only be connected to one smartphone at a time. When you connect the watch to a new smartphone, the watch automatically resets and all data is removed from its memory. Make sure you back up any important data stored on your watch.

1. From  **Galaxy Wearable**, tap the **Home** tab.
2. Tap **Account and backup** > **Back up data**.



Remote connection

Set the watch to remotely connect to the smartphone when a Bluetooth connection between the devices is not available. With this connection, you can still receive notifications from your smartphone. The watch and smartphone must be connected to the same Wi-Fi® network in order to receive notifications and calls.

To enable or disable this feature:

1. From  **Galaxy Wearable**, tap the **Home** tab.
2. Tap **Account and backup** > **Remote connection**.

Disconnect

1. From  **Galaxy Wearable**, tap the **Home** tab.
2. Tap  **Menu** > **Disconnect**.

Lock or unlock your device

By default your screen is not locked. You can use the screen lock feature to secure your device. See [Set a screen lock](#).

When enabled, your watch locks when you remove it from your wrist or when the screen times out while you are wearing it.

To lock the watch:

- Cover the screen with your palm.

To unlock the watch:

- Press any key to turn on the watch screen.
 - If you have a lock screen enabled, press any key to enter your pattern or pin and unlock the watch.

Home key settings

You can customize the shortcuts assigned to the Home key.

Double press

Choose which feature is launched when the Home key is pressed twice. By default this option is set to open the Recent apps list.

1. From  **Settings**, tap **Advanced** > **Home key**.
2. Tap **Double press**, and choose a shortcut to enable it.

Press and hold

Choose which feature is launched when you press and hold the Home key. By default this option is set to wake Bixby.

1. From  **Settings**, tap **Advanced** > **Home key**.
2. Tap **Press and hold**, and choose a shortcut to enable it.

Navigation

The touchscreen responds best to a light touch from the pad of your finger. Using excessive force or a metallic object on the touchscreen may damage the tempered glass surface and void the warranty.

Tap

Lightly tap the screen to launch an app or select a menu item.



Swipe

Lightly drag your finger vertically or horizontally across the screen to view panels.



Drag

Touch and hold an item, and then move it to a new location.



Rotate

Lightly press and drag your finger clockwise or counterclockwise using the digital bezel on the edge of the screen to move through a list.



Change the watch face

From the smartphone:

1. From  **Galaxy Wearable**, tap the **Watch faces** tab.
2. Tap a watch face.
3. Tap **Customize** to select a background and items to display on the watch face.

From the watch:

- Touch and hold the watch face. Swipe left or right to choose a new style.

Watch face settings

Customize the watch face style, order, and notifications.

- From  **Settings**, tap **Watch faces**. The following options are available:
 - **Select watch face:** Select a watch face type.
 - **Watch always on:** Set the watch to display the time when the screen is turned off.
 - **Watch face order:** Display the most recent watch face or create a custom order.
 - **Notification indicator:** Enable or disable the notification indicator.
 - **Show status:** Indicators are icons that show the current status of your watch on the watch face.
 - **Ongoing icons:** Show icons for ongoing events such as a workout or voice memo.

Widgets

You can instantly check your health and activity information and view app information, such as weather and schedules, for some connected mobile devices.

Add Widgets

To add more widgets on the Home screen:

1. Swipe to the end of the Widget screens, and tap **Add widget**.
2. Select a widget.

The selected widget is displayed in a new panel.

Move Widgets

- Touch and hold a widget and then drag it to the desired location.

Remove Widgets

- Touch and hold a widget, and then tap  **Remove**.

Quick panel

Instead of navigating through the Settings menu, you can access commonly used settings through the Quick panel, where you can also view the Status bar.







- Swipe down from the top of the watch screen to open the Quick panel.
 - Tap a quick setting to open it.
 - Touch and hold a quick setting to edit the placement, remove a setting, or add a new setting.



Status bar

Indicator icons display at the top of the screen in the Status bar. Swipe down from the top of the watch screen to view the Status bar.

Indicator icons

-  Battery full
-  Bluetooth connected
-  Bluetooth enabled, but not connected
-  Wi-Fi connected
-  LTE network connected (LTE model only)
-  Signal strength (LTE model only)

Notifications

Stay up to date with events, notifications, and messages from your smartphone. When you receive a notification, information about the notification, such as its type, is displayed on the screen while the watch is vibrating.

- From the watch screen, swipe right and tap a notification to view details.



View a list of notifications for each app

You can view a list of notifications from the same app.

1. From the watch screen, swipe right to view notifications.
2. Tap the number at the bottom of the notification.

Clear all notifications

Instead of individually clearing notifications, you can clear all notifications at once.

1. From the watch screen, swipe right to view notifications.
2. Swipe right until you reach the end of the notifications screens, and then tap **Clear all**.



Block notifications

You can choose to block notifications from some apps. Not all apps support Block notifications.

1. From the watch screen, swipe right to view notifications.
2. Tap a notification from the app that you want to block, and tap again to view the details.
3. Tap  **More options** > **Block notifications**.

Notification settings



Change settings for the notification feature.

1. From the Apps screen of the smartphone, tap  **Galaxy Wearable** > **Home tab** > **Notifications**.
2. Tap  to activate it, and then tap to select items:
 - **Show only while wearing:** Show notifications on your watch only while it is being worn.
 - **Show while using phone:** Show notifications from your phone on your watch while you are using your phone.
 - **Turn on for new apps:** Automatically turn on notifications for newly installed apps.

Water lock mode

You can use Water lock mode to exercise in the water. While in Water lock mode, touchscreen, wake-up gestures, and watch always on will be disabled.

1. Swipe down from the top of the watch to open the Quick settings panel.
2. Tap  to put the watch in Water lock mode.

 **TIP** You can also enable Water lock mode from the Setting menu. From **Advanced**, tap **Water lock**. Tap  to enable.

Exit water lock mode

1. Press and hold the **Home** key for two seconds to turn off the mode. The watch will make sounds to eject water from the speaker.
2. Press the **Home** key to stop the sound.
3. Shake the watch to remove any water from the pressure sensor.



Eject water

You can use the eject water feature to help clear out water from your watch. The watch will make sounds to help eject water from the speaker.

1. From  **Settings**, tap **Advanced** > **Water lock**.
2. Tap **Eject water with sound** > **Play sound**.

Do not disturb

Use these options to determine block out time where notifications are turned off, and during which time periods you want to enter this mode.



- From  **Settings**, tap **Advanced** > **Do not disturb**, and tap  to enable an option:
 - **Turn on now**: Enable this option and set the time period.
 - **Sync Do not disturb**: Match Do not disturb settings on your phone and watch.

 **TIP** You can also access Do not disturb from Quick settings. Swipe down from the top of the watch, and tap **Do not disturb**.

Goodnight mode

Goodnight mutes all alerts, except for alarms and notifications. This keeps the screen off and mutes most sounds while you sleep.



1. Swipe down from the top of the watch to open the Quick settings panel.
2. Tap  to put the watch in Goodnight mode.

 **TIP** You can also access Goodnight mode from the Settings menu. From **Advanced**, tap **Goodnight mode**. Tap  to enable.

Theater mode

Theater mode keeps the screen turned off and silences all sounds.

1. Swipe down from the top of the watch to open the Quick settings panel.
2. Tap  to put the watch in Theater mode.

 **TIP** You can also access Theater mode from the Settings, tap **Advanced** > **Theater mode**, and tap  to enable this feature.

Daily briefing

Receive morning and evening summaries of your schedule, health information, and reminders.

- From  **Settings**, tap **Advanced** > **Daily briefing**, and tap an option:
 - **Set briefing times:** Manually set up when you will receive briefings.
 - **Help:** Tap to view help information on this feature.

Enter text

Text can be entered by speaking or by using a keyboard.





Default keyboard

Select a default keyboard type for text input.

- From  **Settings**, tap **General** > **Input** > **Default keyboard** and select your default keyboard.



Voice input

Instead of typing your text, you can speak it.

- Tap  **Voice input** and speak the message you want to enter. Tap **Send** when you are finished.
 - Tap  **More options** > **Input languages** to change the language. Voice input is not supported in some languages.

Emojis

You can add emojis to your message.

- Tap  **Emojis**, and choose an emoji.
 - To insert stickers and bitmojis, tap  **Stickers**.

Keyboard

Use the keyboard to enter your message.

- Tap  **Keyboard**, and then use your finger to write text, or swipe right to view the keyboard mode options.

Keyboard settings

Change the Samsung keyboard settings.

- From  **Settings**, tap **General** > **Input** > **Keyboard settings**, and tap options to customize:
 - **Input languages**: Select languages for text input.
 - **Handwriting**: Enable handwriting mode.
 - **Smart typing**: Customize features like predictive text, auto capitalize, and auto punctuate.
 - **Key-tap feedback**: Set the watch to vibrate when you tap a key on the keyboard.
 - **Reset keyboard settings**: Return your keyboard to the default settings.
 - **Clear personalized data**: Remove word predictions and other personalized data.

Apps

Navigate the apps screen

Messages

Phone

Contacts

Bixby

Samsung Health

Samsung Health Monitor

Weather

Calendar

Galaxy Store

Samsung Pay

Reminder

Microsoft Outlook

Music

Spotify

Gallery

Find My Phone

Alarm

World clock

Timer

Stopwatch

PPT Controller

Voice Recorder



Navigate the apps screen



[Hide apps](#) | [Uninstall apps](#) | [Apps Settings](#)

The Apps list displays all preloaded and downloaded apps. Apps can be downloaded from the Galaxy Store.

- From the watch screen, press the **Home** key to open the Apps screen.
 - To scroll through the list of apps, rotate the bezel.
 - To view other panels, swipe the screen to the left or right.
 - To view recently opened apps, tap  **Recent apps**.

Hide apps

You can hide apps that you do not want to see on your watch.

1. From  **Galaxy Wearable** on your phone, tap the **Home** tab > **Apps** > **Manage apps**.
2. Tap  **Hide** next to the apps you do not want to see on your watch, then tap **Save**.

Uninstall apps

Uninstall apps you have download.

1. From Apps on your watch, touch and hold an app.
2. Tap  **Uninstall**. This option is not available for all apps.

Apps Settings

Customize how apps are displayed on the Apps screen.

App layout

Choose how to view your apps.

- From  **Settings**, tap **Apps** > **Layout**, and choose an option:
 - **Rotary view**: Use the digital rotating bezel to quickly browse apps by rotating.
 - **List view**: Arrange the apps in a list.

Auto open apps

Set an app to launch without tapping the app. When the indicator icon hovers over an app, the app will be launched automatically.

- From  **Settings**, tap **Apps** > **Auto open apps** to enable this feature.

Sort apps

Choose how to arrange the apps on the Apps screen.

- From  **Settings**, tap **Apps** > **App order**, and choose an option:
 - **Most recent first:** Recently used apps to appear first.
 - **Custom:** Arrange the apps to your preference.
 - From the Apps screen, touch and hold an app, and then drag it to the desired location.

App permissions

Configure permissions for each installed app.

1. From Apps, tap  **Settings**.
2. Tap **Apps** > **Permissions**.
3. Tap each feature to enable or disable permission to access or use the feature.



Messages

View messages and reply to or call the sender using the watch.







Send messages

Create and send messages from your watch.

1. From Apps, tap  **Messages** >  **Compose**.
2. Tap **Recipient** to enter a phone number, or  **Contacts** to add a number you have saved.
3. Choose a keyboard or quick message to compose your message. Quick messages and emojis send automatically.
4. Tap **Send**.

Edit Quick messages

Edit or add templates used for replying to messages.

1. From  **Galaxy Wearable**, tap the **Home** tab > **Apps**.
2. Tap  **Settings** next to Messages.
 - To edit a message, select it and edit the text.
 - To create additional templates, tap  **Add**.
 - To delete or rearrange messages, tap  **Edit**.

Delete messages

Delete messages from your watch.

- Swipe to the right on the watch screen to open a message, then drag the message up to  **Delete**.

SOS messages

Send a message with your location to designated contacts when you are in an emergency situation.

Set up SOS messages:

- From  Galaxy Wearable, tap the **Home** tab > **SOS**.
 - **Emergency contacts:** Designate an emergency contact.
 - **Make SOS calls to:** Call you emergency contact in an emergency.
 - **Send SOSes:** Press the Home key quickly 3 times to send an SOS message.
 - **Detect falls:** Makes an SOS call and send an SOS message when a hard fall is detected.



 **TIP** After you have set up SOS messages in the Galaxy Wearable app, you can enable SOS messages and Detect falls from the Settings menu on the watch. From Settings, tap **Advanced** > **SOS** to customize.

Send SOS messages:

- Press the **Home** key quickly three times to send an SOS message.

Message settings

Customize the Messages app.

1. From Apps, tap  **Messages**.
2. Tap  **More options** > **Settings**, and tap an option to customize:
 - **Send as audio:** Enable to send recordings instead of texts.
 - **Blocked numbers and messages:** View your blocked numbers and messages.
 - **Emergency alerts:** Enable and customize emergency alerts.





Phone

Make and answer calls on your phone from your watch.



Make a call

Make a call from your watch.

1. From Apps, tap  Phone.
2. Tap  Keypad and enter a number or tap  Contacts and select a contact to call.
3. Tap  Call.

Answer a call

Answer incoming calls.

- On the incoming call screen, drag  **Answer** to the right to answer the call on your phone.

Reject a call

Reject incoming calls.

- Tap  **Decline** and drag it to the left to reject a call and send it to your voicemail.

End a call

End a call from your watch.



- Tap  **End** when you are ready to end your call.

Contacts

View your smartphone's contact list.



Create a contact

You can search for a contact or scroll through the list to find one by name.

1. From the Apps screen, tap  **Contacts**.
2. Tap  **Add**, and then enter the contact information.
3. Tap **Save**.



Find a contact

You can search for a contact or scroll through the list to find one by name.

- From  **Contacts**, tap  **Search**, and then enter characters to find contacts that match.

Call or message a contact

You can send a message or make a phone call from Contacts.

- From  **Contacts**, tap the contact you want to connect with, and tap an option:
 -  **Call**: Begin a phone call with the contact.
 -  **Message**: Type a message to the contact.

Bixby

Bixby is a voice service that helps you use your watch more conveniently. You can talk to Bixby to launch a function or provide you with information. To use Bixby, your mobile device must be connected to a Wi-Fi or mobile network, and you must sign in to your Samsung account.

1. From Apps, tap  **Bixby**.
2. Follow the prompts to set up Bixby.



Use Bixby

To launch Bixby for voice commands:

- Quickly press the **Home** key twice, or say "Hi Bixby."

Enable voice launch

You can launch Bixby using your own voice command. You can only use this feature when the watch screen is turned on.

- From  **Bixby**, tap  **More options** > **Voice wake-up** to enable this feature.

Change the language

Change the speech recognition language.

- From  **Bixby**, tap  **More options** > **Language**, and then choose a language.

Samsung Health

When synced with a compatible smartwatch, the Samsung Health application is a great companion to your routine. You can set goals, record and manage health-related data, check your progress and receive useful information. Recent info is stored on your smartwatch for quick access, and you can view historical info in the app on the synced smartphone.

○ From the Apps screen, tap  **Samsung Health**.

 **CAUTION** The ECG app is not intended for users with known arrhythmias other than atrial fibrillation or users under 22 years old. Users should not interpret or take clinical action based on the device output without consultation of a qualified healthcare professional. The ECG app is not intended to replace traditional methods of diagnosis or treatment.

The SpO2 measurement, VO2 Max, heart rate, and trip detection software functions are not intended to diagnose disease or other conditions, or to cure, mitigate, treat, or prevent disease.

The accuracy of the information and data provided by a device and its related software, including heart rate readings, may be affected by factors such as environmental conditions, skin condition, specific activity performed while using/wearing the device, settings of the device, user configuration/user-provided information, placement of the sensor on the body, and other end-user interactions. For more information on proper wear and use, visit samsung.com/us/heartratesensor.

Before you start exercising

While moderate physical activity, such as brisk walking, is safe for most people, health experts suggest that you talk with a qualified healthcare professional before starting a new exercise routine, especially if you are unsure of your health status, or if you have any of the following conditions or symptoms:

- Pregnancy
- Heart disease; Asthma or lung disease; Diabetes, or liver or kidney disease; and Arthritis



- Symptoms suggestive of heart, lung, or other serious disease, such as:
 - Pain or discomfort in your chest, neck, jaw, or arms during physical activity;
 - Dizziness or loss of consciousness;
 - Shortness of breath with mild exertion or at rest, or when lying down or going to bed;
 - Ankle swelling, especially at night;
 - A heart murmur or a rapid or pronounced heartbeat; or
 - Muscle pain when walking upstairs or up a hill that goes away when you rest.

Steps

Your watch counts the number of steps you have taken and measures the distance traveled.

- From  **Samsung Health**, tap **Steps** to view a graph of your step count records.

To set your steps target:

1. From  **Samsung Health**, tap **Steps**.
2. Swipe up, tap  **Settings**, and then tap **Step target**.
3. Swipe up or down to set the target.
4. Tap **Done**.

Exercise

Record your exercise information using Samsung Health's exercise feature.

1. From  **Samsung Health**, tap **Exercise**.
2. Tap **Work out** and swipe to an activity type.
 - If available, tap **...** to enter the exercise information.
3. Tap the activity to start monitoring your exercise. Your heart rate measurement will be displayed after you begin your exercise.
 - When you swipe right or left you can view exercise information, such as calories burned and current speed.

4. Press the **Back** key to pause the workout.
 - Press the **Back** key again to resume the workout.
 - Tap **Finish** to complete your workout and view your workout summary.
5. Swipe to and tap **View log** to see your workout log.

 **NOTE** Measured distance may differ from the actual distance due to uneven strides, walking in place, and pacing around.

Auto workout tracking

The watch automatically recognizes workouts after 10 minutes of exercise and begins recording exercise information. If you stop exercise for more than one minute, then the auto workout tracking feature deactivates. You can view and enable or disable the exercises supported by the auto workout tracking feature.

1. From  **Samsung Health**, tap **Settings**.
2. Tap **Workout detection** > **Activities to detect**.
3. Tap an activity type to enable or disable auto workout tracking.

Running coach

Set your watch to receive coaching messages for proper pacing while running.

1. From  **Samsung Health**, tap **Exercise**.
2. Tap **Work out** > **Running coach** to begin workout.
 - Tap **⋮** to adjust exercise information.

Sleep

Automatically track your sleep patterns.

1. From  **Samsung Health**, tap **Sleep**.
2. Swipe up to view your sleep data.



Heart rate

Measure and record your heart rate. Take heart rate measurements when you are seated and relaxed.

1. From  **Samsung Health**, tap **Heart rate**.
2. Tap **Measure** to begin measuring your heart rate.
 - After a moment, your current heart rate is displayed on the screen.
3. Tap **Tag** to select a status tag for your measured heart rate.
 - The watch displays information about your heart rate in relation to your selected tag.

Track your heart rate and stress

The watch can be configured to automatically measure and track your heart rate and stress.

1. From  **Samsung Health**, tap **Heart rate**.
2. Swipe up, tap  **HR and stress measurement**, and select a measuring interval.
 - **Measure continuously:** The watch measures your heart rate and stress continuously, regardless of your movement.
 - **Every 10 mins while still:** The watch measures your heart rate every ten minutes when you are relaxed.
 - **Manual measurement only:** The watch measures your heart rate or stress only when you check it manually.
3. Tap **Help** to view help information for using the HR and stress measurement feature.

Stress

Keep track of your stress. Breathing exercises are also available to help reduce stress.

1. From  **Samsung Health**, tap **Stress**.
2. Tap **Measure** to measure your current stress level.

Breathing exercise

Use the Breathe feature to help reduce stress.

1. From  **Samsung Health**, tap **Stress**.
2. After taking a stress measurement, the Breathe feature is available. Tap **Breathe** for the following options:
 - **Start**: Begin the breathing exercise.
 - **Settings**: Configure the following options:
 - **Target**: Adjust the target cycles per minute.
 - **Inhale/Exhale**: Adjust the time for inhaling and exhaling.
 - **Vibration**: Enable or disable vibration between inhale and exhale prompts.
 - **Sound**: Enable or disable sound for the breathing exercise.

Oxygen level

Keep track of your oxygen level, also known as saturation of percutaneous oxygen (SpO2).



1. From  **Samsung Health**, tap **SpO2**.
2. Place your hand flat on a table near your heart.
3. Tap **Measure** to measure your current oxygen level.
 - After a moment, your current oxygen level is displayed on the screen.
4. Tap **Tag** to select a status tag for your measured oxygen level.

Food

Keep track of your calorie intake from food.



1. From  **Samsung Health**, tap **Food**.
2. Tap **Add** when you eat something to enter the following information:
 - **Meal type**: Enter the type of meal you had.
 - **Cal**: Swipe up or down to select the calories consumed.

To set your daily calorie target:



1. From  **Samsung Health**, tap **Food**.
2. Swipe down and tap  **Set target**.
3. Set the daily calorie number.
4. Tap **Done**.

Water

Record and track how many glasses of water you drink each day.

1. From  **Samsung Health**, tap **Water**.
2. Tap  **Add** when you drink a glass of water.
 - To decrease the count, tap  **Remove**.

To set your daily water target:

1. From  **Samsung Health**, tap **Water**.
2. Swipe down and tap  **Set target**.
3. Tap  to enable water tracking.
4. Tap **Daily target** and set the number.
5. Tap **Done**.

Together

Compete with other Samsung Health users.

Steps leaderboard

Add challenges through Samsung Health on your smartphone.

- From Apps, tap  **Samsung Health** > **Together**. Here you can add friends and challenges.

View challenges on your Watch

View your challenges and rank on the Steps leaderboard.

1. From  Samsung Health, tap **Together**.
2. Tap a list to see your challenges.

Women's health

Record and track your menstrual cycle.

- From  Samsung Health, tap **Women's health**.
 - Tap **Enter period** to record your menstrual cycle.
 - Swipe up on the screen to view your ovulation and predicted period information.
 - Tap **Add log** to record your symptoms.

Settings

Customize your Samsung Health settings.

1. From  Samsung Health, tap **Settings**.
2. Tap an item to customize:
 - **Profile**: Update your personal profile.
 - **Units**: Change units for distance, temperature, and volume.
 - **Workout detection**: Set the watch to recognize and encourage you when it detects that you are exercising.
 - **Inactive time alerts**: Set the watch to alert you if you have been still for almost an hour.
 - **HR and stress measurement**: Configure automatic heart rate and stress measurements.
 - **Data permissions**: Configure access permissions to your health data.
3. Tap **Help** for a description of Samsung Health.

Samsung Health Monitor

Use the Samsung Health Monitor app to track and record electrocardiogram (ECG) measurements, analyze them quickly, and share the results with experts.

To view detailed reports of your ECG readings on your smartphone, install the Samsung Health Monitor app. You can download the app from the Galaxy Store or the Google Play™ store.

1. From your smartphone, tap  **Samsung Health Monitor**. If necessary, update the app to the latest version.
2. Tap **Continue** and create your profile.

Measure ECG

Use your Galaxy watch to record ECG for 30 seconds similar to a standard single-lead ECG. The ECG Monitor app will also check the recording for signs of Atrial Fibrillation—a common form of irregular heart rhythm.

Requires Samsung Galaxy smartphone with Android 7 or later, and Samsung Health Monitor app (available only at the Samsung Galaxy app store).

 **CAUTION** The ECG app is not intended for users with known arrhythmias other than atrial fibrillation or users under 22 years old. Users should not interpret or take clinical action based on the device output without consultation of a qualified healthcare professional. The ECG app is not intended to replace traditional methods of diagnosis or treatment.

1. From  **Samsung Health Monitor**, tap **ECG**.
2. Rest your finger lightly on the **Back** key to begin the ECG.
 - After a moment, your ECG is displayed on the screen.
3. Tap **Add** to add any symptoms you are experiencing.
4. Tap **Done** when you are finished.

Share your report

You can view your ECG readings as daily, weekly, and monthly charts, or view detailed reports for each measurement. You can share the PDF report of your ECG recording with your healthcare provider using Samsung Health Monitor app on your compatible Galaxy phone.

1. From your smartphone, tap  **Samsung Health Monitor**.
2. Tap **See details** to view the latest report or **View history** to see all available reports.
3. Tap **Share this report** and choose a sharing method to send a PDF.



Weather

View weather information on the watch for locations set on the smartphone when the devices are connected.

- From Apps, tap  **Weather**. Swipe through the screens to view the weather information.
 - To add a city, rotate the bezel to the last screen and tap **Add location**.



Calendar

View events scheduled on the smartphone.

1. From Apps, tap  **Calendar**.
2. Swipe right or left to view different months.

Add events

1. From  **Calendar**, tap a day.
2. Tap **Add an event**.
3. Enter the event information, and tap **Save**.

Galaxy Store

Samsung Galaxy Store provides a quick and easy way to find and download free premium apps that are compatible with your Galaxy device. A Samsung account is required to purchase and download apps.

- From Apps, tap  Galaxy Store.

Samsung Pay

Pay almost anywhere that accepts a debit, credit, or gift card. Samsung Pay supports Near Field Communication (NFC) to allow quick and secure payment through standard credit card readers. For more information, see samsung.com/us/samsung-pay.

Set up Samsung Pay

1. From Apps, tap  Samsung Pay.
2. Follow the prompts to complete the setup.

Make a payment

1. From any screen, press and hold the **Back** key to launch  Samsung Pay.
2. Enter your four-digit PIN.
3. Select a card, tap **Pay**, and then hold the watch near the terminal.

 **NOTE** You can use Samsung Pay for up to 5 transactions without the smartphone. This may vary depending on the bank/institution issuing the account.

Reminder

Add reminders for events and set alarms outside of the Calendar app.

Create a reminder

Set up and track reminders on your watch:

1. From Apps, tap  **Reminder**.
2. Tap **Add a reminder**, and then speak to record your reminder.
 - Tap **Write memo** to type the reminder.
3. Tap **Set time** to schedule the reminder.
4. Tap **Save** when finished.

Complete a reminder

To mark reminders complete:



1. From  **Reminder**, tap the reminder you want to complete.
2. Tap the circle to mark it as complete with a check mark.

Microsoft Outlook

View emails and reply to them.

Read emails

View emails on your watch.

1. From Apps, tap  **Microsoft Outlook**.
2. Tap a message to view its content.
3. Tap  **More options** for additional options:
 - **Star**: Mark the email as important.
 - **Show on phone**: View the email on your smartphone.
 - **Delete**: Delete the email.



Reply to emails

Compose and send email messages on your watch.

1. From  **Microsoft Outlook**, tap an email to open the email screen.
2. Tap an icon or a quick reply to compose and send your message.

Delete emails

Delete emails on your watch.

1. From  **Microsoft Outlook**, scroll through the inbox to the email you want to delete.
2. Tap  **More options** > **Delete**.
3. Select the email again, and then tap **Delete**.





Music

Play music from your watch.





Play music from the watch

You can play music from the watch through Bluetooth headphones (not included).

1. From Apps, tap  **Music**.
2. Tap the output until the  **Watch** icon is displayed.
3. Tap  **More options** for the following options:
 - **Shuffle**: Enable or disable shuffle.
 - **Repeat**: Tap to repeat all songs, tap again to repeat once, and tap again to turn off repeat.
 - **Add to Favorites**: Add a track to your favorites.
 - **Listen using**: Select which audio output type to use for playback.
 - **Set as ringtone**: Set the current track as your ringtone.
 - **Delete**: Remove the current track.
4. Tap  **Play music** to play music.
5. Swipe up from the bottom of the screen to open the library screen, where you can view the current song, playlist, and queue music.

Play music on your smartphone

When you select a smartphone to play music from, you can control playback of the music with your watch. The music plays on your smartphone.

1. From  **Music**, tap the output until the  **Phone** icon is displayed.
2. Tap  **Play music** to play music on your smartphone.
3. The music plays on your smartphone and the watch displays the music controller screen.

Import music

Import music saved on your smartphone to your watch.

1. From  **Galaxy Wearable**, tap the **Home** tab.
2. Tap **Add content to your watch > Add tracks**.
3. Select files and tap **Done**.

To sync recently added music on your smartphone with your watch:

1. From  **Galaxy Wearable**, tap the **Home** tab.
2. Tap **Add content to your watch**.
3. Tap **Add tracks** or tap **Auto sync**, music will be synced while the watch's battery power is at least fifteen percent.

Spotify



Access music and podcasts on your device. You can listen to artists and albums, or create your own playlist of your favorite songs.

- From **Apps**, tap  **Spotify**.

Gallery

View and manage images stored on the watch.

View images

1. From **Apps**, tap  **Gallery**.
2. Swipe through the image list and then tap an image to view it.
 - To zoom in or out, double tap the image.
 - To delete an image, tap  **More options** > **Delete**, and then tap  **Ok** to confirm.

Import and export images

Images can be exchanged between your watch and smartphone.

Import images from your smartphone



Send images or entire albums from your smartphone to your watch.

1. From  Galaxy Wearable, tap the **Home** tab.
2. Tap **Add content to your watch** > **Copy images to watch**.
3. Select files or albums and tap **Done**.

To automatically sync images on your smartphone with your watch:

1. From  Galaxy Wearable, tap the **Home** tab.
2. Tap **Add content to your watch** > **Auto sync** to enable. Images will be synced while the watch battery power is at least 15 percent.
 - **Image limit:** Set a limit to the number of images that can be synced to your watch.
 - **Albums to sync:** Select which Gallery albums to sync to your watch.

Export images to your smartphone

1. From  Gallery, tap the image you want to send to the smartphone.
2. Tap  **More options** >  **Copy to phone**.



Take a screenshot

Capture an image of your screen. It is automatically saved to the Gallery app.

- From any screen, press the **Home** and **Back** keys at the same time.





Find My Phone

If you misplace your smartphone, your watch can help you find it.

1. From Apps, tap  Find My Phone.
2. Tap  Start.
 - The Phone vibrates and the screen turns on.
3. Tap **Dismiss** on your smartphone or drag  Stop to the right on the watch.

Find your Watch

You can also locate your watch by making it light up and make sounds from the Galaxy Wearable app.

1. From  Galaxy Wearable, tap the Home tab > Find My Watch.
2. Tap  Start.
3. Drag  Stop to the right on the watch or tap  Stop on the smartphone.

Alarm



Set an alarm to ring at a specific time.

Create an alarm

Create an alarm event. You can set one-time or recurring alarms.

1. From Apps, tap  Alarm.
2. Tap **Add** and enter the time.
3. Tap **Next**, and select the days to repeat the alarm.
4. Tap **Save** when finished.

Stop or snooze an alarm

- Drag  Cancel to the right to stop an alarm or drag  Snooze to the left to snooze.

Delete an alarm

You can delete an alarm that you created.

- From  **Alarm**, tap and hold an alarm, and then tap **Delete**.

World clock

Keep track of the current time in multiple cities around the globe.



Add cities

Keep track of the time in multiple cities:

1. From Apps, tap  **World clock**.
2. Tap **Add** to add a city to your World clock.
3. Tap a location on the map, or tap **All cities** to search for the city you want to add.
4. Tap the city to add it to your World clock.
 - To add more cities, tap **Add**.

Remove cities

To remove a City:

1. From  **World clock**, tap  **More options** by the city you want to remove.
2. Tap  **Delete**, and select the city again.
3. Tap **Delete** to confirm.

Timer

Set a countdown timer for up to 99 hours, 59 minutes, and 59 seconds.

Set a timer

Create an alarm event. You can set one-time or recurring alarms.

1. From Apps, tap  **Timer**.
2. Tap a time or **Custom** to set the Timer.
3. Tap **Start**.

Stop the timer

- Drag  **Cancel** to the right when the timer goes off.

Stopwatch

The Stopwatch lets you time events down to a hundredth of a second.

1. From Apps, tap  **Stopwatch**.
2. Tap **Start** to begin timing.
 - To keep track of lap times, tap **Lap**.
3. Tap **Stop** to end timing.
 - To continue timing after stopping the clock, tap **Resume**.
 - To reset the Stopwatch to zero, tap **Reset**.

PPT Controller

You can use PPT Controller to connect to a computer, phone, or tablet using Bluetooth and control PowerPoint presentations with your watch.

To connect:





1. From Apps, tap  PPT Controller.
2. Tap a device in the list to connect your watch.
3. Select your watch from the Bluetooth list on the device.
4. Follow the on-screen instructions to complete the connection. The watch and device will be connected by Bluetooth.

To disconnect:

- From  PPT Controller, tap  More options > Connect new device.

Control PPT slides with the watch

You can remotely control the PowerPoint slides with your watch.



1. Open the PowerPoint presentation on your connected device.
2. From  PPT Controller, tap  Play to start the slideshow on your device.
 - Tap  Next or rotate the bezel to the right to move to the next slide.
 - Swipe up from the bottom of the watch screen, and tap  Previous or rotate the bezel to the left to move to the previous slide.
 - Swipe up from the bottom of the watch screen, and tap Touchpad to move the cursor on the device by swiping on the watch screen.
3. Swipe up from the bottom of the watch screen, and tap  Stop to finish controlling slides with your watch.

Presentation alerts

You can set alerts on your watch to warn you when you are close to the end of your presentation time, or at various intervals during your presentation.



Wrap-up alerts

Receive a notification after a set time.

1. From  PPT Controller, tap  **More options** > **Wrap-up alert**.
2. Tap  to enable this feature.
3. Tap **Set alert for**, and enter the time that your presentation needs to be finished.







Interval alerts

Receive a notification at set intervals during your presentation to help keep you on track.

1. From  PPT Controller, tap  **More options** > **Interval alerts**.
2. Tap  to enable this feature.
3. Tap **Interval type**, and choose to base intervals on time or slides.
4. Tap **Set interval**, and enter the interval that you want to receive notifications.

Voice Recorder

Use your voice to record memos.

1. From Apps, tap  **Voice Recorder**.
2. Tap  **Record** or  **Speech-to-text** and begin recording your message.
 - To stop recording and delete the memo, tap .
 - To pause the recording, tap  **Pause**.
3. Tap  **Stop** when you are finished.

Settings

Access Settings

Display

Sound and vibration

Connections

Device maintenance

Accessibility



Security and privacy

Other settings



Access Settings

You can personalize your device by configuring various setting options.

- From Apps, tap  **Settings**, or swipe down from the top of the screen to open the status panel and tap  **Settings**.

Display

[Adjust screen brightness](#) | [Set the screen timeout](#) | [Show last app](#) | [Background style](#) | [Font style](#) | [Show charging info](#)

You can configure the screen brightness, timeout delay, font size, and many other display settings.

Adjust screen brightness

Manually adjust the brightness of the display.

- From  **Settings**, tap **Display** and select an option:
 - **Brightness:** Manually adjust the brightness of the display.
 - **Auto low brightness:** Set the watch to automatically adjust the brightness depending on ambient light conditions.

Set the screen timeout

Set the length of time the watch waits before turning off the display's backlight.

- From  **Settings**, tap **Display** > **Screen timeout**, and select a timeout value.

Show last app

Set the length of time the watch shows displays last app used when you turn the screen on.

- From  **Settings**, tap **Display** > **Show last app**, and select a timeout value.

Background style

Select a background for the watch screens. This will be applied to every screen except your main watch screen.

- From  **Settings**, tap **Display** > **Background style** and select a background.



Font style

Customize the font style and size on your watch.

- From  **Settings**, tap **Display** > **Font** and choose an option to customize:
 - **Font style:** View and select a font.
 - **Font size:** Choose from small, medium, and large.

Show charging info

Display the battery level until full.

1. From  **Settings**, tap **Display** > **Show charging info**.
2. Tap  to enable the feature.

Sound and vibration

[Sound mode](#) | [Ringtone](#) | [Notification sound](#) | [Volume](#) | [Ringtone vibration](#) | [Notification vibration](#) | [Vibration intensity](#) | [Long vibration](#) | [System sounds](#) | [Vibration feedback](#)

Configure the vibrations used to indicate notifications, screen touches, and other interactions.

Sound mode

Switch between sound modes, while preserving the individual sound settings you have made.

1. From  **Settings**, tap **Sound and vibration**.
2. Tap **Sound mode**, and then select a mode:
 - **Sound**: Enable sounds for notifications and alerts.
 - **Vibrate**: Use vibration only for notifications and alerts.
 - **Mute**: Set your device to make no sounds.

Ringtone

Choose from preset ringtones or add your own.

1. From  **Settings**, tap **Sound and vibration**.
2. Tap **Ringtone**.
3. Tap a ringtone to hear a preview, or tap **Add from watch** to use an audio file as a ringtone.
4. Tap **OK** to select it.

Notification sound

Choose from preset notification sounds.

1. From  **Settings**, tap **Sound and vibration** > **Notification sound**.
2. Tap a notification sound to hear a preview, and tap **OK** to select it.

Volume

Set volume levels.

1. From  **Settings**, tap **Sound and vibration** > **Volume**.
2. Swipe the screen from right to left to adjust the volume levels for different modes.

Ringtone vibration

Vibrate for calls.

1. From  **Settings**, tap **Sound and vibration**.
2. Tap **Ringtone vibration** and select a vibration pattern.
3. Tap **OK** to confirm.

Notification vibration

Choose a vibration pattern for new notifications.

- From  **Settings**, tap **Sound and vibration** > **Notification vibration** and select a vibration pattern. Tap **OK** to confirm.

Vibration intensity

Configure the vibration intensity.

- From  **Settings**, tap **Sound and vibration** > **Vibration intensity**, and select your preferred intensity level. Tap **OK** to confirm.

Long vibration

Increase the duration of the vibration for calls and notifications.

- From  **Settings**, tap **Sound and vibration** > **Long vibration** to enable this feature.



System sounds

Enable sounds for actions like tapping the screen and charging the watch.

1. From  **Settings**, tap **Sound and vibration**.
2. Tap **System sounds**, and then an option to enable it:
 - **Touch sounds**: Play tones when you touch or tap the screen to make selections.
 - **Ticking sound**: Hear a ticking sound similar to a mechanical watch every second.
 - **Hourly chime**: Hear a sound and feel a vibration at the start of each hour.
 - **Unlock sound**: Play a sound when you lock or unlock the screen.
 - **Charging sound**: Play a sound when a charger is connected.
 - **Dialing keypad**: Play a tone when dialing numbers on the Phone keypad.

Vibration feedback

Enable vibrations when the watch screen is tapped.

- From  **Settings**, tap **Sound and vibration** > **Vibration feedback**, and tap  to enable.



Connections

[Bluetooth](#) | [Mobile networks](#) | [Wi-Fi](#) | [NFC](#) | [Disconnection alerts](#) | [Airplane mode](#) | [Connect to a new phone](#)

Manage connections between your device and a variety of networks and other devices.

Bluetooth

Use Bluetooth to connect the watch to a smartphone or an optional headset for playing music (headset not included).

1. From  **Settings**, tap **Connections** > **Bluetooth**.
2. Tap  to turn on the feature.
 - Tap **Bluetooth audio** to connect a Bluetooth audio device to the watch.

Mobile networks

Customize your mobile networks. This feature is only available on the LTE model.

1. From  **Settings**, tap **Connections**.
2. Tap **Mobile networks**, and tap an option to customize:
 - **Mobile networks**: Enable or disable using mobile data.
 - **Mobile data**: Enable mobile data.
 - **Data roaming**: Enable data roaming.
 - **Network mode**: Select a network mode.
 - **Network operators**: Choose a network operator.
 - **Access Point Names**: Select and APN.

Wi-Fi

Activate the Wi-Fi feature to connect to a Wi-Fi network.

1. From  **Settings**, tap **Connections** > **Wi-Fi**.
2. Tap **Auto**, **Always on**, or **Always off**.

Connect to a Wi-Fi network

This feature is available when the watch is not connected to the smartphone through Bluetooth.

1. From  **Settings**, tap **Connections** > **Wi-Fi**.
2. Tap **Wi-Fi networks** > **Scan**, and select a network from the list.
 - Networks that require a password display a lock icon.
3. Enter the password if required, and tap **Connect**.

 **NOTE** Once the watch connects to a Wi-Fi network, the watch reconnects to that network each time it is available without requiring a password. To prevent the watch connecting to the network automatically, select the network, and then tap **Forget**.



Sync Wi-Fi profiles

Set the device to sync the list of saved Wi-Fi networks with your watch.

1. From  **Galaxy Wearable**, tap the **Home** tab.
2. Tap **Sync phone settings** > **Sync Wi-Fi networks**.

NFC

Near Field Communication (NFC) allows you to communicate with another device without connecting to a network. Make payments and buy tickets for transportation or events after downloading and configuring the required apps.

1. From  **Settings**, tap **Connections** > **NFC**.
2. Tap  to enable the feature, and tap **Tap and pay** to set the default payment app for mobile payments.

Make payments with the NFC feature

Before you can use the NFC feature to make payments, you must register for the mobile payment service. To register or get more information about the service, contact your service provider.

1. From  **Settings**, tap **Connections** > **NFC**.
2. Touch the top of the watch's touchscreen to the credit card reader.

 **NOTE** The payment services list may not include all available payment apps.

Open with NFC

You can select supported apps to open with NFC.

1. From  **Settings**, tap **Connections** > **NFC**.
2. Tap **Open with NFC**, and select an app.

Disconnection alerts



Receive alerts when disconnected from Bluetooth.

1. From  **Settings**, tap **Connections** > **Disconnection alerts** to enable this feature.
2. Tap **Type** to choose an alert style.

Airplane mode

Airplane mode disconnects your device from all networks and turns off connectivity features, such as phone calls and Wi-Fi.

- From  **Settings**, tap **Connections** > **Airplane mode** to enable this option.

 **TIP** You can also access Airplane mode from Quick settings. Swipe down from the top of the watch, and tap .

Connect to a new phone

Connect your watch to a new mobile device. This feature is available when the watch is connected to a smartphone. Otherwise, **Connect to phone** is displayed. For more information, see [Back up data](#).

- From  **Settings**, tap **Connect to new phone** and follow the prompts.

Device maintenance

[Date and time](#) | [Power saving mode](#) | [Watch only mode](#) | [Optimize battery](#) | [Related settings](#) | [Reset the Watch](#) | [Location](#)

View the status of your device's battery, storage, and memory. You can also automatically optimize your device's system resources.



Date and time

You can set the date and time manually. These options are only available when your watch is not connected to your mobile device.

- From  **Settings**, tap **General** > **Date and time**.
 - **Automatic**: Use the network to set date and time.
 - **Set date**: Set the date manually.
 - **Set time**: Set the time manually.
 - **Select time zone**: Select the time zone manually.
 - **Use 24-hour format**: Set the format for displaying time.

Power saving mode

Activate Power saving mode to save battery power by limiting the watch's functions, such as:



- Use a grayscale Home screen.
- Turn off all functions except calls, messages, and notifications.
- Turn off Wi-Fi and mobile networks (if applicable).
- Limit performance.
 1. From  **Settings**, tap **Battery** > **Power mode**.
 2. Tap **Power saving**, and then tap  **OK**.

To disable Power saving mode:

- From the Home screen, tap **OFF**, and then tap  **OK**.

Watch only mode

Activate Watch only mode to save battery power by limiting the watch's functions to only showing the time.

1. From  **Settings**, tap **Battery** > **Power mode**.
2. Tap **Watch only**, and then tap  **OK**.

To disable watch only mode:

- Press and hold the **Home** key for three seconds.

Optimize battery

You can automatically optimize your watch system resources to save your battery.

1. From  **Settings**, tap **Battery** > **Optimize battery**.
2. View the list of features that can be modified to improve the watch battery life.
3. Tap **Optimize**.

Related settings

View system resources that typically drain battery life in one list to quickly modify and optimize settings.

1. From  **Settings**, tap **Battery** > **Related settings**.
2. View the list of features that can be modified to improve the watch battery life and tap an option to change the settings for that feature.



Reset the Watch

Reset settings to their factory default values and delete all data.

1. From  **Settings**, tap **General** > **Reset**.
2. Tap **Reset** again to confirm.

Location

Some apps may require location services to be turned on for full functionality.

1. From  **Settings**, tap **Location**.
2. Tap  to enable this feature, and select a mode.
 - **GPS, Wi-Fi, and mobile networks:** Use GPS, Wi-Fi, and mobile networks.
 - **Wi-Fi and mobile networks:** Use Wi-Fi and mobile networks only.
 - **GPS:** Use GPS only.
3. Tap **Permissions** to view apps and features that have permission to access your location information.

Accessibility

[Screen Reader](#) | [Visibility enhancements](#) | [Hearing enhancements](#) | [Advanced settings](#) | [Text to speech](#)

Accessibility services are special features that make using the device easier for those with certain physical disabilities.

For more information about Accessibility for Samsung products, please contact us at accessibility@sea.samsung.com.

Screen Reader

Use special controls and settings that let you navigate without needing to see the screen.

- From  **Settings**, tap **Accessibility** > **Screen reader** for the following options:
 - **Voice Assistant:** Receive spoken feedback when using your device, such as what you touch, select, or activate.
 - **Tutorial:** Learn how to use Voice assistant.
 - **Settings:** Configure Voice assistant to better assist you.

Visibility enhancements

You can configure Accessibility features to assist with visual aspects of your device.

- From  **Settings**, tap **Accessibility** > **Visibility enhancements** for the following options:
 - **Triple tap magnify:** Triple tap to zoom in and out. After zooming out, drag two fingers apart or together to adjust the zoom level.
 - **Grayscale:** Remove all colors from the display, and use shades of gray.
 - **Negative colors:** Reverse the display of colors from white text on a black background to black text on a white background.
 - **Color lens:** Adjust the screen colors if you have difficulty reading the text.

Hearing enhancements

You can configure Accessibility features to assist with audial aspects of the device.

- From  **Settings**, tap **Accessibility** > **Hearing enhancements** and tap an option:
 - **Mute all sounds**: Turn off all notifications and audio for privacy.
 - **Mono audio**: Switch audio from stereo to mono when using one earphone.

Advanced settings

You can configure Accessibility features.

- From  **Settings**, tap **Accessibility** > **Advanced settings** for the following options:
 - **Vibration watch**: The watch will use vibrations to communicate the time.
 - **Notification reminder**: Enable and customize notification reminders.
 - **Two finger triple tap**: Use two fingers when using the gesture triple tap.

Text to speech

To set accessibility settings related to Text to speech:

- From  **Settings**, tap **General** > **Text-to-speech** and select a mode:
 - **Language**: Choose the language for spoken text.
 - **Speech rate**: Set the speed at which the text is spoken.
 - **Read notifications aloud**: Set the watch to read out notifications received on your watch.
 - **Install voice data**: Install voice data for use with text-to-speech.

Security and privacy



[Set a screen lock](#) | [Permission manager](#)

You can secure your device and protect your data by setting a screen lock.

Set a screen lock



It is recommended that you secure your device using a screen lock.

1. From  **Settings**, tap **Security and privacy** > **Lock**.
2. Tap **Type** to select a screen lock type:
 - **Pattern**: Create a pattern that you draw on the screen to unlock your device.
 - **PIN**: Set a PIN to use for unlocking the device when it is removed from your wrist and the screen is turned off.
 - **None**: Do not lock the screen.
3. Tap **Use for** to select when your lock screen will be used.

 **TIP** View helpful information about using the screen lock feature from  **Settings** > **Security and privacy** > **Lock**, tap **Help**.

Permission manager

Apps might access features of your watch that you permit them to (like the sensors, microphone, or location) when they are running in the background, not just when you are using the app. You can set your watch to notify you when this happens.

1. From  **Settings**, tap **Security and privacy** > **Permission manager**.
2. Tap a category, then tap an app to select which permissions you want to be notified about by tapping .

Other settings

[Screen wake-up](#) | [Touch sensitivity](#) | [Watch status](#) | [Watch info](#)

Configure features on your device that make it easier to use.



Screen wake-up

Use a gesture to turn on the watch screen.

- From  **Settings**, tap **Advanced** > **Screen wake-up**, and tap an option to enable:
 - **Wake-up gesture**: Lift your wrist to turn on the watch screen.
 - **Touch wake-up**: Touch the watch screen to turn it on.
 - **Bezel wake-up**: Rotate the bezel to turn on the watch screen.

Touch sensitivity

Set the watch to allow use of the touch screen with gloves on.

1. From  **Settings**, tap **Advanced** > **Touch sensitivity**.
2. Tap  to enable this feature.

 **TIP** You can also enable touch sensitivity by holding down the **Home** key and tapping **Touch sensitivity**.

Watch status

Access information about the watch.

1. From  **Galaxy Wearable**, tap the **Home** tab > **About watch**.
2. Tap an option below:
 - **Battery**: View battery life, usage information, and change your watch's power mode.
 - **Storage**: View storage information and free up space.
 - **Memory**: Enhance performance of your watch and manage background apps.
 - **Device**: See device identification codes for your watch.
 - **Legal information**: View the legal information for the watch.

- **Software information:** See the current software and Knox versions and available updates.
- **Battery information:** View the capacity and rating of your watch's battery.
- **Install unknown apps:** Set the watch to allow the installation of apps from unknown sources.

Watch info

View information about the watch.

- From  **Settings**, tap **About watch** to view information about your watch:
 - **Watch phone number:** View the phone number assigned to your watch (LTE model only).
 - **Model number:** Check your watch's model number.
 - **Serial number:** View your watch's serial number.
 - **IMEI:** View your watch's IMEI number.
 - **Storage:** Check the available storage space.
 - **Device:** Access device information about the watch.
 - **Legal info:** Access legal information related to the watch.
 - **Software:** Check your watch's software version and security status.
 - **Battery:** Check the watch's battery voltage and capacity.
 - **Debugging:** Activate or deactivate USB debugging mode when developing apps for the watch.



TIP To view the user manual from the  **Galaxy Wearable** app on your smartphone, tap the **Home** tab > **Tips and user manual**.

Learn more

Videos

youtube.com/samsungcare

Tips

samsung.com/us/support/tips

Samsung Care

samsung.com/us/support

Talk to an agent

Contact us on Facebook Messenger

Find us on Facebook

Follow us on Twitter

Legal information

READ THIS INFORMATION BEFORE USING YOUR MOBILE DEVICE.

Arbitration Agreement - This Product is subject to a binding arbitration agreement between you and SAMSUNG ELECTRONICS AMERICA, INC. (“Samsung”). You can opt out of the agreement within 30 calendar days of the first consumer purchase by emailing optout@sea.samsung.com or calling 1-800-SAMSUNG (726-7864) and providing the applicable information.

The full Arbitration Agreement, Standard One-year Limited Warranty, End User License Agreement (EULA), and Health & Safety Information for your device are available online at <https://www.samsung.com/us/Legal/Gear-HSGuide>.

If your device required Federal Communications Commission (FCC) approval, you can view the FCC certification on the watch by opening **Settings** > **About watch** > **Device**.

Samsung Knox

Samsung Knox is Samsung’s security platform and is a mark for a Samsung device tested for security with enterprise use in mind. Additional licensing fee may be required. For more information about Knox, please refer to: samsung.com/us/knox.

Maintaining water and dust resistance

 **CAUTION** To avoid electric shock and damage to your device, do not charge device while it is wet or in an area where it could get wet. Do not handle device, charger or cords with wet hands while charging.

The device is not impervious to dust and water damage in any situation. It is important that all compartments are closed tightly.

Follow these tips carefully to prevent damage to the device and maintain dust and water resistance performance:

Water resistant based on 5ATM rating, which means submersion up to 50 meters per ISO standard 22810:2010. Not intended for scuba diving. Avoid excessive, sudden temperature changes, and high velocity activities. Falls and shocks may breach integrity.

After use in sea water, rinse in fresh water and dry device. Despite this classification, your device is not impervious to water damage in any situation. It is important that all compartments are closed tightly.

Follow these tips carefully to prevent damage to the device.

- Whenever your device gets wet, dry it thoroughly with a clean, soft cloth. Failure to rinse the device in fresh water and dry it as instructed may cause the device to suffer from operability or cosmetic issues.
- Do not expose the device to water at high pressure.
- If the device is dropped or receives an impact, the water and dust resistant features of the device may be damaged.

Military Specification

This device passed military specification (MIL-STD-810G) testing against specific conditions, including drops from 3.2 feet, extreme temperatures, dust, shock/vibration, and low pressure/high altitude. Device may not perform as described in all extreme conditions.

Restricting children's access to your mobile device

Your device is not a toy. Do not allow children to play with it because they could hurt themselves and others, or damage the device. Keep the device and all its parts and accessories out of the reach of small children.

Samsung Electronics America, Inc.

Address:

85 Challenger Road
Ridgefield Park
New Jersey 07660

Phone: 1-800-SAMSUNG (726-7864)

Internet: samsung.com

©2020 Samsung Electronics America, Inc. Samsung, Samsung Galaxy, Samsung Health and Samsung Galaxy Watch are all trademarks of Samsung Electronics Co., Ltd.

Other marks are the property of their respective owners.



Some multimedia (audio/video) files contain Digital Rights Management (DRM) technology to verify you have the right to use the files. Preloaded apps on your device may not be compatible with DRM-protected files.

Screen images are simulated. Appearance of device may vary.

The actual available capacity of the internal memory is less than the specified capacity because the operating system and default applications occupy part of the memory. The available capacity may change when you upgrade the device.

Please check with your service provider to verify qualifying services/features.