

J Series

3D mapping

Amusement

Arenas/Stadiums

Broadcast

Corporate

Energy

Events/Large venues

Government

Higher education

Home theater

Houses of worship

Manufacturing

Medical training

Scientific research

And more...



Designed with your image in mind.

CHRISTIE[®]



- ▲ 13,200-22,000 center lumens
SXGA+ (1400 x 1050)
HD (1920 x 1080)
WUXGA (1920 x 1200)
- ◀ View the Christie J Series video

- ▲ 6850-9350 center lumens
SXGA+ (1400 x 1050)
HD (1920 x 1080)
WUXGA (1920 x 1200)



Reliability is in its genes. Performance is its genius.

Superior performance, high brightness and crisp, clear images – these are what you expect in a Christie® 3-chip DLP® projector. We've taken these features, added even more, and wrapped them up in the most compact chassis in its class. Welcome to the Christie J Series. This series of Christie projectors couples the benefits of Xenon illumination – for the most natural color accuracy and stability – with the next level of technology, performance and flexibility.

Creating visually compelling displays is paramount to your success. That's our business too, so we've made higher brightness, Christie Twist™, 3D upgradability and flexibility standard in this series. You'll see we've upgraded our existing 3-chip DLP platform with the features and functionality that you rely on to share, collaborate and create.

We've kept your bottom line in mind, as well. We've made sure that this new series can use existing lenses¹, lamps, input cards², stacking hardware and other Christie accessories.

The Christie J Series includes 2D and Mirage (3D-capable) models that are available in a broad range of brightness levels and resolutions. Whether your application is in broadcast, energy, entertainment, government, higher education, houses of worship, live events, manufacturing or medical, choose the model that fits your needs and budget, and know that all this is backed by Christie's three-year warranty and our industry-leading service and support.

^{1,2} See note on page 12.

Up to 22,000 lumens of Xenon brightness

You've told us how much you love Xenon technology and we think we know why. The continuous light quality, stable color temperature, excellent color reproduction and relatively little color shift give you eye-catching live displays, easily combat other light sources in the room and still wow your audiences time and again. That's reliability you can trust.

Available in brightness levels ranging from 6200 ANSI (6850 center) lumens through 20,000 ANSI (22,000 center) lumens and three resolutions, SXGA+ (1400 x 1050), HD (1920 x 1080) and WUXGA (1920 x 1200), each model offers more brightness per pound than the competition and ensures that your content can be shown in its native resolution, without scaling.

Advantages of Xenon lamps

Provides the highest level of on-screen performance, both for brightness and color accuracy

The spectrum of a Xenon lamp results in relatively little color shift over time

A Xenon lamp emits a continuous wavelength spectrum of light throughout the visible range (roughly 400 nm to 700 nm), which approximates the neutral white color of natural daylight

Reaches full brightness in far less time than other lamp technologies

Great for illuminating very large screens or high ambient environments

Xenon lamps have the best color rendering index (CRI) of any lamp technology out there

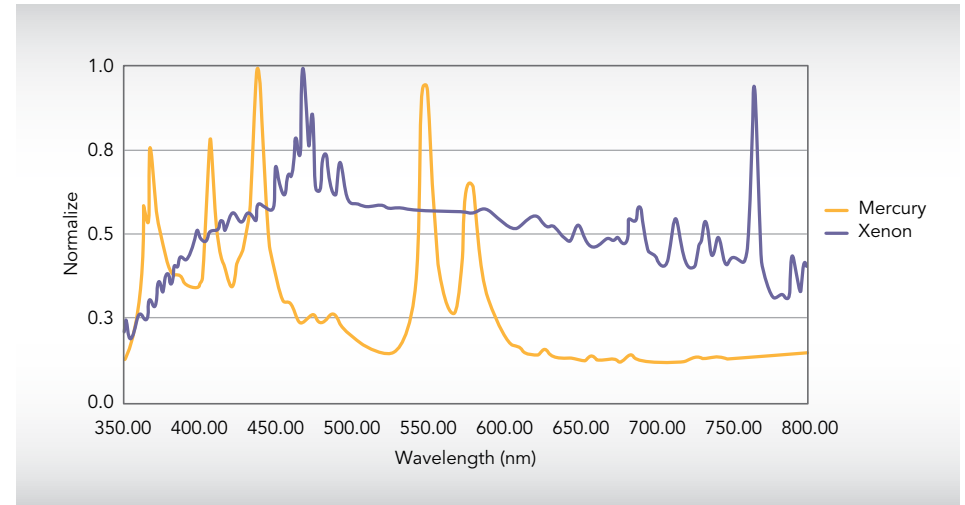

▲ Xenon vs high pressure Mercury lamps

Christie J Series models¹

Model	Center lumens	Resolution
Christie DS+8K-J	7500	SXGA+
Christie DS+10K-J	9350	SXGA+
Christie HD7K-J	6850	HD
Christie HD9K-J	8800	HD
Roadster S+14K-J	13,750	SXGA+
Roadster S+18K-J	17,600	SXGA+
Roadster S+22K-J	22,000	SXGA+
Roadster HD14K-J	13,200	HD
Roadster HD16K-J	15,400	HD
Roadster HD20K-J	20,000	HD
Roadster WU20K-J	20,000	WUXGA

Only Xenon in its class

Christie is the only manufacturer to offer Xenon models that provide less than 10,000 lumens. The 1.0kW and 1.2kW Cermax[®] lamps make it possible for us to provide models in the 7000- to 10,000-lumen category.

The Christie J Series offers the best color performance of any product in this market space.

Yellow notch filter

Available as an optional feature for all Christie J Series models, the yellow notch filter is an optical color management device that emulates film-like color. It creates greater separation between the primary colors, RGB, resulting in a larger available color gamut for better reproduction of skin tones and richer color depth and saturation. This is especially apparent in green and red tones, resulting in a more life-like display on the screen. This color filter must be factory installed at time of purchase.

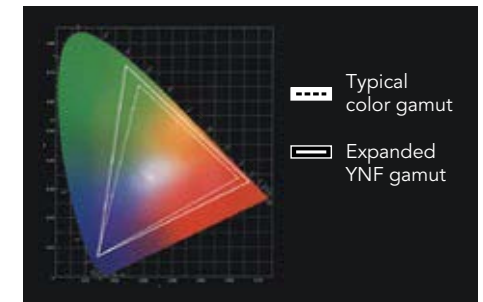

▲ Optional yellow notch filter is ideal for video applications



▲ Standard color gamut



▲ Expanded color gamut

¹ Lumens values are for projectors that do not have yellow notch filter installed.

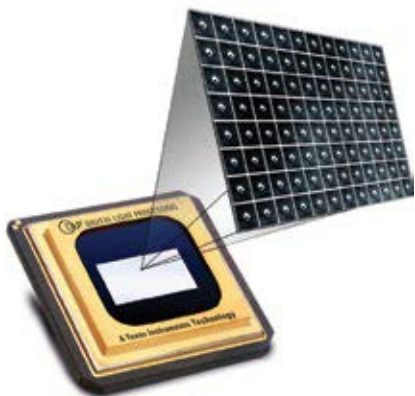

▲ 3-chip DLP technology

Crisp, clean images time and again

There are many factors that determine the quality of an image – 3-chip DLP technology, high-quality optics and world-class 10-bit image processing ensure you display the best image. You need all of these elements working together if you're going to present clear, detailed, true-to-life images and information. The Christie J Series encompasses all of this and more. We've also added a dust-sealed engine and optics to help protect your investment and keep maintenance costs low. Liquid cooling and a thermal-feedback system keep your projector at a temperature that ensures optimal performance.

Image quality

Based on 3-chip DLP technology, high-quality optics and world-class 10-bit image processing, the Christie J Series delivers:

- High brightness
- Excellent color
- Excellent uniformity
- High reliability (>100,000 hours MTBF for DMDs)
- High contrast
- Excellent fill ratio

Dust-sealed engine

Christie J Series projectors are designed with dust-sealed engines and optics. Since dust and dirt cannot affect the system, image quality is maintained and maintenance costs are lower. Optional fog juice filters are available for projectors exposed to harsh environments.

Liquid cooling

Christie Roadster and Christie Mirage models (equipped with a 2.0kW, 2.4kW or 3kW lamp) include a thermal-feedback system and a liquid-cooling module for the DMDs to continually maintain the projector's temperatures in the correct operating range. This improves the overall DMD performance and reliability when used in harsh environments. It also enables the projector to operate in temperatures up to 104°F (40°C) allowing for use in less than ideal conditions.

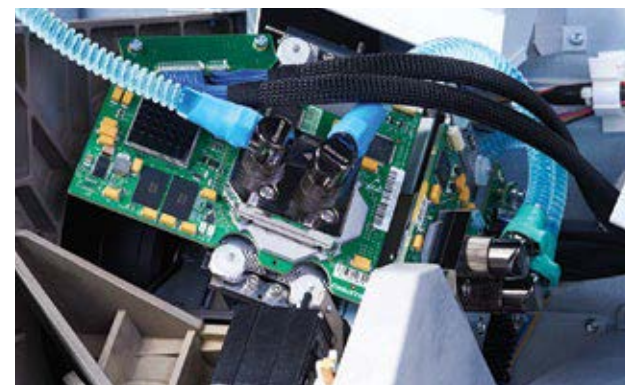

▲ Liquid cooling

◀ Solomon Victory Theater National World War II Museum, New Orleans, LA

Taking performance to a new level

We've embedded powerful features such as Christie Twist and an Intelligent Lens System (ILS™), edge blending and color matching capabilities to ensure that setup and maintenance of your displays are repeatable, quick and easy. Monitoring and controlling your displays from a distance are made simple with our ChristieNET™ web interface. And, when you're close to your projector our intuitive LCD keypad gives straightforward, easy access to manage your display. Additional hardware or software is no longer required; making your life easier.

The Christie J Series platform supports existing stacking hardware, lenses¹, input cards² and other Christie accessories (e.g. portrait lens adapter); as well, the new lamp modules for the Christie J Series can be used with legacy Xenon projector models. This keeps money in your pocket and your displays amazing audiences.

^{1,2} See note on page 12.



▲ Grammy award winner Alicia Keys' "As I Am" world tour

Embedded Christie Twist

Standard in all Christie J Series models, Christie Twist enables seamless edge blending of multiple curved images faster and more easily than through traditional, manual methods. Controlled by an easy-to-use GUI, you can expertly control and edge blend or stack multiple curved images. As well, images can be warped to fit virtually any dimension or shape display. Embedded Christie Twist ensures that all J Series projectors work with value-added accessories, such as Christie AutoStack™.



▲ Easy-to-use GUI



▲ Easy-to-use GUI



▲ Image on curved screen – without blending



▲ Curved screen – with blending

"For a recent show, I needed to project onto a multi-dimensional stage with two double-stacked Christie Roadster projectors. I used one PC-based video server per projector to be able to fit the predesigned image and content onto the stage surface, as well as geometrical adjustments to each image independently in order to converge them all.

If Christie Twist had been installed in the projectors, I could have used two computers instead of four, had less image lag, and it would have been cheaper and faster to get the job done. I now see that it makes complete sense to have Christie Twist on every projector used in projection mapping displays because it makes set up easier, reduces the number of the video servers needed for the job and decreases the failure points of the whole system."

Bart Kresa
BARTKRESA design

Intelligent Lens System (ILS)

The ILS automatically recognizes and calibrates a lens when it is installed. Stepper motor-based encoding ensures that motor drift does not occur, as typically found with DC encoded motors, providing accurate and repeatable recall of all lens offset, zoom and focus positions. This lens system ensures that the images adjust to optimize screen coverage and maintain alignment in applications with moving screens or variable aspect ratios.



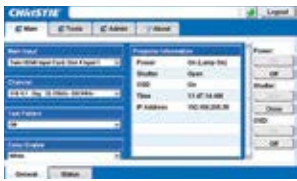

▲ Main page controls and information



▲ Virtual On Screen Display (OSD): access full menu structure, remotely



▲ Status and diagnostics: display alarm events for quick projector monitoring and diagnosis



▲ Admin screen includes upload, backup, restore and more

ChristieNET web interface and Virtual On-Screen Display (OSD)

ChristieNET enables users to access all projector menus and controls through a web interface without disrupting the live presentation. This allows for real-time adjustments and monitoring of each projector on the network – regardless of geographic location. It's easy to set up and maintain the projector system remotely. You don't need to see the screen to set up the system, making it ideal for applications where the screen is rigged or far away. The menus do not show on the projector screen so it won't be a distraction during live performances. A new status screen shows alarms, lamp info, or any system information. The easy-to-use interface lets you upload, backup and restore settings, as well as designate permission-based users.



▲ Intuitive, user-friendly keypad

LCD keypad

This easy-to-use LCD keypad includes:

Contextual menus provide a fully-featured, intuitive interface that removes the need for a cluttered keypad

Large, four line LCD display

Adjustable brightness and timed LCD off mode

Intuitive, user-friendly keypad design that lights up when features are active

Active keys are color-coded amber to indicate that selections will result in changes visible to the audience

LiteLOC

The LiteLOC™ feature automatically manages your display's brightness levels over time so that you can match the brightness of a multiple projector system in tiled or blended arrays. This feedback system continuously monitors lamp brightness so that, as the lamp goes through its natural brightness decay, the system increases the lamp power in order to maintain consistent brightness.

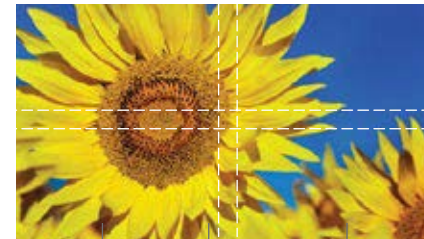

Color matching Edge blending



Overlapping image edges

▲ Without edge blending

▲ With edge blending

Embedded edge blending and color matching

Advanced blending capabilities and Comprehensive Color Adjustment (CCA™) ensure digitally accurate color matching and uniformity across multi-screen blended or tiled images.



▲ Without LiteLOC



▲ With LiteLOC

Christie understands 3D

Today, a wide range of applications make use of 3D technology to provide a host of benefits – from decreased costs through virtual design prototyping, increased effectiveness while exploring oil deposits and wells, never-seen-before perspectives designed for medical and scientific research programs, or having fun at a theme park. But it's not just any 3D technology that has been used – only Christie has been there since the beginning. A true pioneer in the development of 3D projection technology, only Christie can offer the expertise required for today's emerging 3D display applications.

Our Christie Mirage J Series of 3D-capable projectors offers complete compatibility with today's 3D standards. They offer brightness levels ranging from 6200 ANSI (6850 center) lumens through 20,000 ANSI (22,000 center) lumens and contrast ratios that include SXGA+ (4:3), HD (16:9) and WUXGA (16:10). The most compact 3-chip DLP active stereo projectors in their class, this series of projectors delivers crisp, detailed images with excellent color and brightness.

These projectors offer complete compatibility with today's 3D home entertainment requirements and are ready for Blu-ray™ 3D video, PS3 and other gaming consoles, meeting the mandatory 3D spec for HDMI v1.4a. To ensure your 3D solution is complete, Christie also offers a range of accessories that include: 3D glasses (active and passive), emitters and modulators.

Powered by dual image processing, the Christie Mirage J Series displays full resolution at a native frame rate up to 120Hz. Two standard Dual link DVI input cards support 330 MHz bandwidth for full resolution Dual input 3D.

For the ultimate home theater including Blu-ray 3D video content, the Christie Mirage J Series uses triple flash to provide the best images possible, no matter how fast-motion your content might be. You can count on Christie to ensure the highest image quality and a comfortable theater-like viewing experience.



◀ View the Christie Mirage J Series video

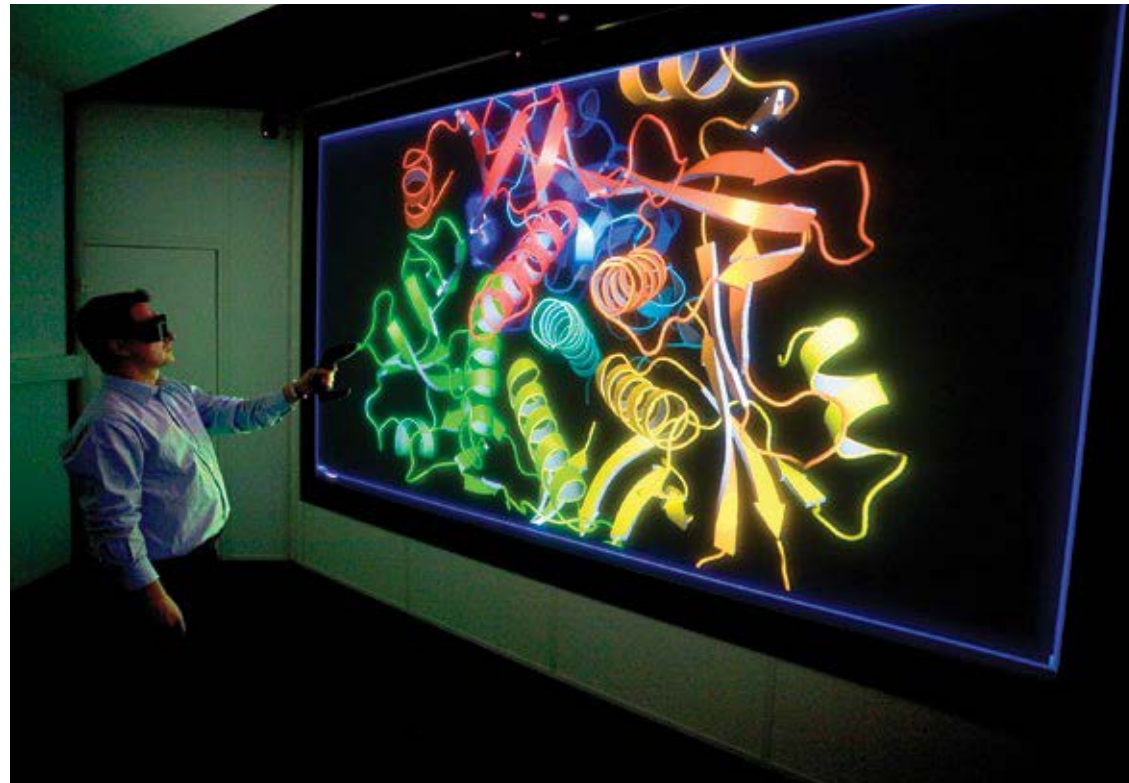

▲ University of Reims Champagne-Ardenne (URCA), 3D display used for scientific research and development

Christie Mirage J Series models¹

Model	Center lumens	Resolution
Mirage DS+8K-J	7500	SXGA+
Mirage S+14K-J	13,750	SXGA+
Mirage S+18K-J	17,600	SXGA+
Mirage S+22K-J	22,000	SXGA+
Mirage HD7K-J	6850	HD
Mirage HD14K-J	13,200	HD
Mirage HD16K-J	15,400	HD
Mirage HD20K-J	20,000	HD
Mirage WU7K-J	6850	WUXGA
Mirage WU14K-J	13,200	WUXGA
Mirage WU20K-J	20,000	WUXGA

¹ Lumens values are for projectors that do not have yellow notch filter installed.

Active stereoscopic viewing – single projector

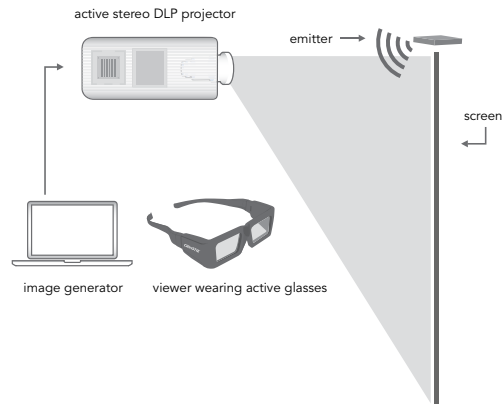

Passive stereoscopic viewing – single projector

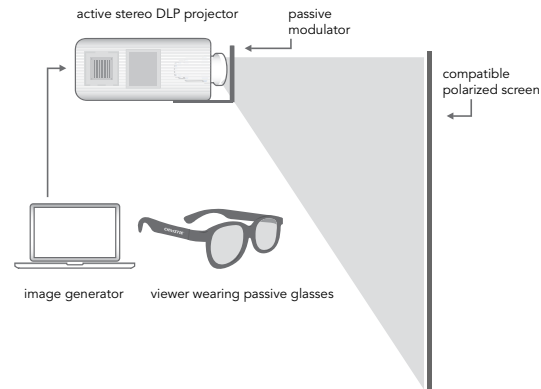

Active stereoscopic viewing – multiple projectors

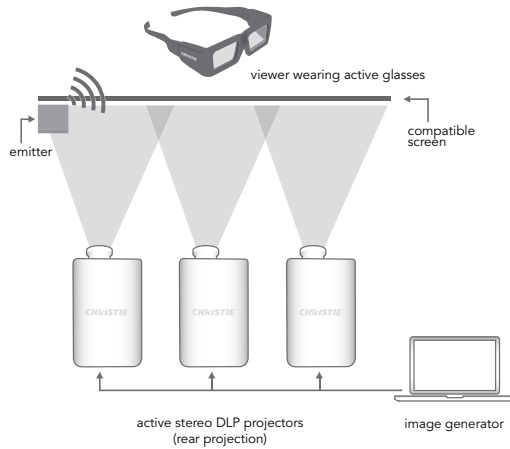

Active stereoscopic viewing

Active stereoscopic displays provide the best 3D imagery available today. Active stereo is typically used for applications where life-like color reproduction and finite detail are required for precise content in key decision-making applications. Offering the most detailed and life-like 3D images, the Christie Mirage J Series uses Xenon-based illumination for the best color reproduction and can be used with Christie Mirage 3D active stereoscopic accessories, including an emitter and LCD shutter glasses. For applications that require a larger display for 1:1 scale visuals, you can use multiple Christie Mirage J Series projectors blended into a single, larger display.

Passive stereoscopic viewing

When it comes to 3D for a larger crowd, passive stereoscopic displays offer the best return on investment. Using low-cost polarized glasses that can be given away or recycled after a single use, a passive stereo display is a cost effective way to deliver quality 3D images. Combine a silver screen and Christie Mirage J Series projectors with Christie Mirage 3D accessories, including our passive modulator and circular polarized 3D glasses, and you can bring incredible eye-popping 3D to even the largest of audiences!

Active single projector versus stacked dual projectors

Single, active 3D projection eliminates the need to stack, align and color match projectors and continually monitor and match brightness of two projectors for consistent left eye/right eye display. Typically for comparable brightness, single active 3D projection will operate with less noise, heat, physical space requirements and consumables along with fewer failure points and overall lower power consumption.

Christie Mirage J Series

In addition to offering the highest brightness and a variety of resolutions while operating at a full 120Hz, the Christie Mirage J Series is flexible in terms of its input capabilities, and the type of stereo you wish to utilize. The Christie Mirage J Series creates stunning 3D imagery from a single projector whether you want to run commercial-grade 3D inputs like native 60Hz per eye or the latest consumer standards like Blu-ray triple flash or broadcast side-by-side.

Source	Input signal type	Dual DVI input card DVI-D	VGA	HDMI	Analog BNC input card RGB/YPrPb	SDI
Data/Graphics	frame sequential - native 3D	• Range 96-120Hz (48-60Hz per eye, >165MPixels < 330M Pixels)	•	•		•
		• Range 96-120Hz (48-60Hz per eye, <165MPixels)	•	•	•	•
	frame doubled <165MPixel	• Range 48-60Hz (24-30Hz per eye) doubled to 96-120Hz	•	•	•	•
	dual input 3D each input <165MPixel	• 2 input cards: 48-60Hz per eye. Two identical formats, frame-locked, passive 3D inputs are fed into the projector and frame-interleaved to create active 96-120Hz 3D	•	•	•	•
		• 1 input card: 48-60Hz per eye. Two passive 3D inputs are fed into the projector, one per eye on the same input card and frame-interleaved to create active 96-120Hz 3D			•	•
frame tripled – triple flash	• 48Hz (24Hz per eye) tripled to 144Hz	•	•	•	•	

Source	Input signal type	Dual DVI input card DVI-D	VGA	HDMI	Analog BNC input card RGB/YPrPb	SDI
Blu-ray	for movie content: <165MPixel					
	frame packing	• 1080p @ 23.98/24Hz	•	•		
	frame tripled – triple flash (automatically) ¹	• Range 48Hz (24Hz per eye) tripled to 144Hz		•		
PS3, XBOX, PC	for game content: <165MPixel					
	frame packing	• 720p @ 50 or 59.94/60Hz	•	•		
Sat/Cable, Set top box etc.	for broadcast content: <165MPixel					
	side-by-side horizontal	• 1080i @ 50 or 59.94/60Hz	•	•	•	•
		• 720p @ 50 or 59.94/60Hz	•	•	•	•
	top and bottom	• 1080p @ 23.97/24Hz	•	•	•	•
	• 720p @ 50 or 59.94/60Hz	•	•	•	•	

• = Available

Standard 3D inputs

Whether your data content or images are being generated by a computer, a Blu-ray player, a gaming console, or a server – 3D content comes in a wide variety of shapes and sizes. The way that your content is distributed can have an impact on your 3D experience.

3D upgradable

Christie also makes it easy to future proof your investment by being the first in the industry to offer upgrade paths for select 3-chip DLP projectors to Mirage Series models. Whether you need 3D capability today or tomorrow, Christie has the innovation, breadth of technologies, engineering strength and the integration expertise to offer the right display solutions to fit your business needs.



	Description	Part number
3D upgrade kits	3D upgrade kit for Christie DS+8K-J	132-101103-XX
	3D upgrade kit for Christie S+14K-J	132-103105-XX
	3D upgrade kit for Christie S+18K-J	132-105107-XX
	3D upgrade kit for Christie S+22K-J	132-107109-XX
	3D upgrade kit for Christie HD7K-J	132-102104-XX
	3D upgrade kit for Christie HD14K-J	132-104106-XX
	3D upgrade kit for Christie HD16K-J	132-106108-XX
	3D upgrade kit for Christie HD20K-J	132-108100-XX
	3D upgrade kit for Christie WU20K-J	132-109101-XX

¹ Blu-ray content is always forced to be triple flashed (144Hz output). No need to select "Triple Flash" from the menu as this is intended for DVI sources, not Blu-ray.



▲ Christie 3D active glasses



▲ Christie 3D passive glasses



▲ Emitter (active) – standard and long range



▲ Modulator (passive)

3D Accessories

	Description	Part number
Active stereo	Glasses – single	108-407102-XX
	Glasses – 5 pack	108-408103-XX
	Glasses – 10 pack	108-409104-XX
	Emitter – standard range	108-410106-01
	Emitter – long range	108-415101-01
Passive stereo	Glasses – single	108-412108-XX
	DepthQ polarization modulator	108-411107-XX

Benefits of 3D

Provides perspective not possible with traditional 2D software and tools

Reduces time to market

Excites audiences ... WOW! factor

Accelerates understanding and decision making

Enables faster, more intuitive interaction with data

Promotes collaboration and focus on collective strengths

Ensures greater accuracy of concepts and designs

Removes inherent boundaries found in traditional tools

Designed to work with you

Christie J Series is designed with many robust features that take some of the complexities out of your job. The easy-to-use lamp insertion mechanism lets you replace the lamp yourself quickly and easily. The portrait display adapter gives you the option to create displays in portrait orientation with 1.0kW or 1.2kW models, while the Christie Roadster models have built-in portrait capabilities. Even if you have existing rigging and stacking mounts, lenses¹, lamps, input cards², stacking hardware and other Christie accessories you can use them with the Christie J Series.



▲ Optional portrait display adapter



▲ Christie Roadster models have built-in portrait capabilities



▲ Stack projectors for redundancy or additional brightness



▲ Stacking kit

Rigging and stacking

Christie's stacking kit enables you to stack up to a maximum of three of the projectors (equipped with a 1.0kW or 1.2kW lamp) into a light-weight, sturdy frame. Customers with existing stacking mounts and hardware can use the same equipment with Christie J Series models. This means that you can effortlessly stack a Christie Roadster S+20K with a Christie Roadster S+22K-J, for example.

Hybrid stack

The stacking frame can also connect to the integral rigging points on any Christie Roadster model for a hybrid stack with a model that uses a 1.0kW or 1.2kW lamp. Adjustable mount wheels aid in projector alignment.

Portrait capabilities

Christie 3-chip DLP projectors offer the flexibility to project in portrait orientation. For models using a 1.0kW or 1.2kW lamp, the portrait display adapter makes the change in orientation easy. The adapter attaches to the projector's lens and enables you to project the image in portrait orientation instead of landscape. Christie Roadster models have built-in portrait capabilities and do not require the portrait display adapter.

Setup lights

Christie Roadster and Christie Mirage models (equipped with a 2.0kW, 2.4kW or 3kW lamp) include 'convenience lights' that allow for easy set up in dark environments.

Bulb replacement

Reduce your cost of ownership by replacing only the bulb – not the entire lamp module assembly (for models equipped with a 2.0kW, 2.4kW or 3.0kW lamp).



▲ Easy-to-use lamp insertion mechanism



▶ Setup lights



▲ Fog filter

▶ CT lens mount

Legacy compatibility

Lenses	The ILS lens adapter kit enables you to convert your existing CT ¹ lenses to function with Christie J Series projectors. The conversion kit includes complete instructions and allows you to make the change in the field. Christie J Series models can be shipped with a CT ¹ lens mount option (must be specified at time of purchase) to allow you to continue using existing CT lenses.
Lamps	Legacy Xenon lamp modules are compatible with the Christie J Series projectors. The new lamp modules for the Christie J Series will also work with legacy Xenon models e.g. 1.0kW lamp for a Christie DS+8K-J projector can be used in a Christie DS+6K projector. These lamp modules, with lamp memory cards, contain a serial number and hours of use information to make inventory and usage tracking quick and easy in all Christie J Series projectors. Lamp hour tracking capabilities are not enabled in legacy models.
Input cards	The input cards ² used in Christie M Series projectors are also compatible with Christie J Series models.
Rigging and stacking	Customers with existing stacking mounts and hardware can use the same equipment with the Christie J Series models.

Fog filter options

To help extend the life of your projector and protect your investment, optional fog juice filters are available for environments that require more than the protection of our dust-sealed engine.

The design of the fog juice filter kits – attached to the projector – reduces the affects of the oil or juice created by fog, smoke, hazers and pyrotechnics. These kits include easy-to-install external media mounts and one set of filters (internal and external). The life of the filters depends on the amount of bi-product captured, but they typically can last up to 20 hours.

Serviceability and support

All Christie 3-chip DLP projectors ship standard with a three-year warranty on parts and labor (including light engine).

Environmental commitment

We recognize our responsibility to control the impact our business activities, products and services have on the environment. We're fully committed to finding and using environmentally friendly solutions, and to meeting or exceeding applicable laws, regulations and organizational objectives. You'll notice that the Christie J Series includes features that support our commitment to being eco-friendly. As an industry leader, we are committed to the prevention of pollution and continual improvement through implementation of our ISO14001 registered environmental management system.

Efficiency

The lamps used in Christie J Series projectors produce the highest lumens per watt, enabling brighter images without additional power requirements. As well, liquid cooling with the thermal-feedback system in the Christie Roadster and Christie Mirage models (equipped with a 2.0kW,

2.4kW or 3kW lamp), improves performance and enables the projectors to run cooler in harsh environments, using less power to keep the DMDs cool. DLP projectors offer higher brightness from smaller units and consequently use less power to achieve the same levels of brightness.

Auto shut-off and eco mode

Reduce your cost of ownership by reducing power consumption and extending lamp life when the projector isn't being used. These projectors can run in eco mode, which reduces brightness and therefore reduces your power requirements and extends the life of your lamp. A reduction in the projector's thermal output minimizes energy use and possible air-conditioning needs.

Low power standby modes

Standby power consumption (phantom power draw) is less than 30W.

Bulb replacement

In Christie Roadster and Christie Mirage models (equipped with a 2.0kW, 2.4kW or 3kW lamp) you can replace bulbs instead of the entire lamp module assembly, reducing unnecessary waste and extra shipping requirements.



¹CT refers to the suite of lenses available for use with Christie's legacy Xenon platform. Note: ILS capabilities are not available with CT lenses and lens mount.

²Legacy input cards are not compatible with Christie J Series models.

Expanded lens suite

This full suite of fixed, short zoom and long zoom lenses for SXGA+, HD and WUXGA resolutions, provides the broadest range of lenses in this marketplace.

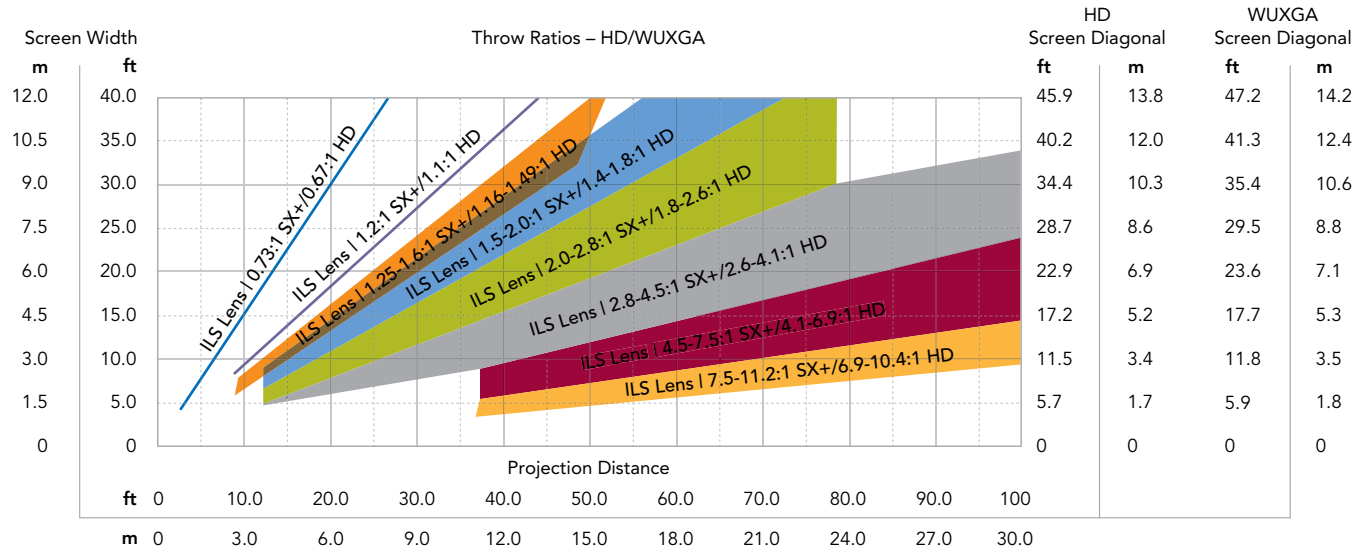
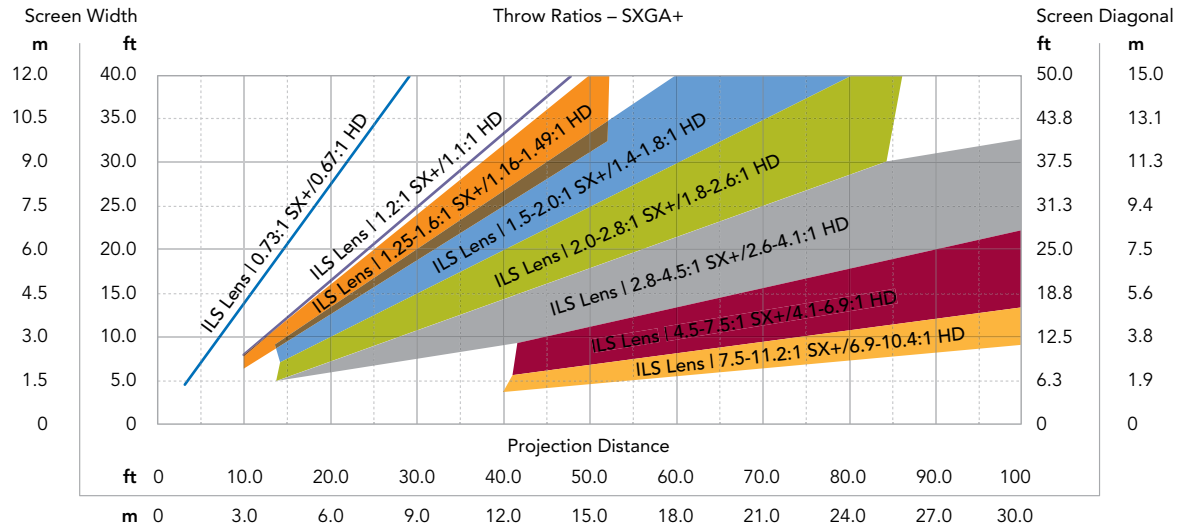

Lenses	Part number
ILS Lens 0.73:1 SX+/0.67:1 HD	118-100110-XX
ILS Lens 1.2:1 SX+/1.1:1 HD	118-100117-XX
ILS Lens 1.25-1.6:1 SX+/1.16-1.49:1 HD	118-100111-XX
ILS Lens 1.5-2.0:1 SX+/1.4-1.8:1 HD	118-100112-XX
ILS Lens 2.0-2.8:1 SX+/1.8-2.6:1 HD	118-100113-XX
ILS Lens 2.8-4.5:1 SX+/2.6-4.1:1 HD	118-100114-XX
ILS Lens 4.5-7.5:1 SX+/4.1-6.9:1 HD	118-100115-XX
ILS Lens 7.5-11.2:1 SX+/6.9-10.4:1 HD	118-100116-XX

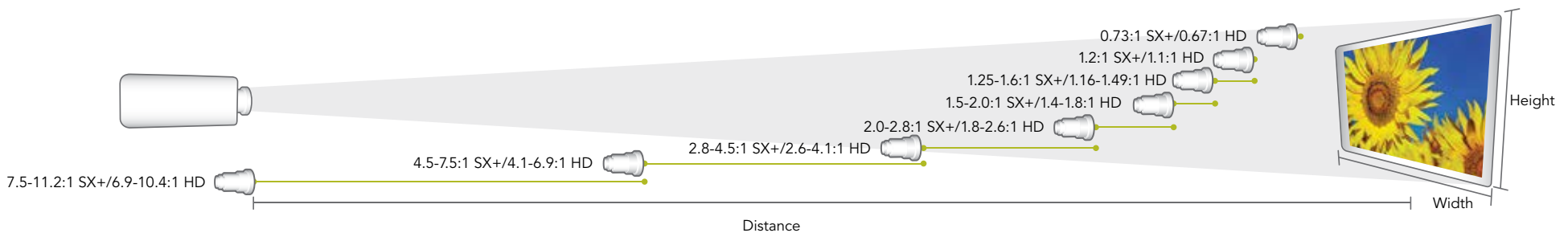

Throw distance values are subject to a +/- 5% lens tolerance.



▲ Analog input card

▲ DMX512 interface card

▲ Dual link DVI input card

▲ Dual 3G SD/HD-SDI input card

▲ Video decoder input card

▲ Twin HDMI input card

	Description	Part Number
Lamps	1.0kW Cermax Xenon pre-aligned lamp module	003-120117-XX
	1.2kW Cermax Xenon pre-aligned lamp module	003-120116-XX
	2.0kW Xenon bubble lamp module	003-120135-XX
	2.0kW Xenon lamp bare bulb kit	03-000887-XX
	2.4kW Xenon bubble lamp module	03-900518-XX
	2.4kW Xenon lamp bare bulb kit	03-000883-XX
	3.0kW Xenon bubble lamp module	003-000306-XX
	3.0kW Xenon lamp bare bulb kit	003-000305-XX
	Bulb alignment tool	38-804900-XX
Input cards	Analog input	108-309101-XX
	Dual link DVI input	108-312101-XX
	Video decoder input	108-310101-XX
	Dual SD/HD-SDI input	108-313101-XX
	Twin HDMI input	108-311101-XX
	DMX512 interface	108-314101-XX
Other	ILS lens adapter kit	108-331108-XX
	Portrait display adapter	118-116109-XX
	Fog juice filters	132-114107-XX
	Ceiling mount ¹	104-100001-XX
	Ceiling mount	104-104001-XX
	Ceiling mount extension	104-101001-XX
	Stacking kit	104-117101-XX
	Edge blending kit	104-102101-XX
	Remote IR sensor	104-106101-XX

Input cards

Each projector is equipped with four input card slots to ensure flexibility and compatibility with a variety of signals. The input cards used in Christie J Series projectors are also compatible with the Christie M Series models.

Analog input card

The Analog input card accepts an analog video signal input over a 5 BNC connector interface. It can accept RGBH&V signals over 5 connectors, as well as component YPbPr signals on the RGB inputs.

DMX512 interface card

This interface card supports the DMX512 communication standard through two 5-pin XLR connectors.

Dual link DVI input card

The Dual link DVI input card has a 15-pin VGA connector for analog signals and a DVI-I connector which can support a single- or dual link DVI HDCP video signal. This input card can also support 2D and 3D signals up to 330 MHz.

Dual 3G SD/HD-SDI input card

The Dual 3G SD/HD-SDI input card accepts both standard-definition (SD) and high-definition (HD) serial-digital-interface (SDI) signals, and enables you to connect two of either types of signal. Both single-link HD and dual-link HD signals are accepted. This card also has two 3G SD/HD-SDI outputs to enable “loop-through” for its respective input.

Video decoder input card

The Video decoder input card accepts various types of standard definition (SD) video, including CVBS (composite video), S-video, and component. It accepts NTSC 3.58, NTSC 4.4, PAL, PAL-N, PAL-M or SECAM formats. This card has two mini-DIN connectors (for S-video signals) and four BNC connectors that can be grouped to allow combinations of CVBS, S-Video, YPrPb or RGB video sources.

Twin HDMI input card

The Twin HDMI™ input card accepts two HDMI inputs and provides 12-bit deep color handling on the input. It also supports the HDMIv1.4a format required for 3D systems providing the projector is upgraded with 3D capabilities. Additionally, advanced loop-through allows any input on any input card to be looped through to the two HDMI outputs on the card.

This functionality ensures that when stacking systems with any input (DVI, RGBHV or HDMI), the Twin HDMI card can be used to send the signal to a second projector. This stacked system is also a passive loop-through providing the repeater projector has AC power, even when powered off, the signal will continue to be looped out to the second projector.

¹For models equipped with a 1.0kW or 1.2kW lamp

		DS+8K-J	DS+10K-J	HD7K-J	HD9K-J	Roadster S+14K-J	Roadster S+18K-J	Roadster S+22K-J	Roadster HD14K-J	
Image	brightness	• 6800 ANSI (7500 center) lumens @ 220V • 5100 ANSI I (5610 center) lumens @ 110V	• 8500 ANSI lumens (9350 center lumens)	• 6200 ANSI (6850 center) lumens @ 220V • 4650 ANSI (5100 center) lumens @ 110V	• 8000 ANSI lumens (8800 center lumens)	• 12,500 ANSI lumens (13,750 center lumens)	• 16,000 ANSI lumens (17,600 center lumens)	• 20,000 ANSI lumens (22,000 center lumens)	• 12,000 ANSI lumens (13,200 center lumens)	
	contrast	• 1600-2000:1 full field 650:1 ANSI								
	uniformity	• 90% brightness uniformity			• 80% brightness uniformity		• 90% brightness uniformity		• 80% brightness uniformity	
Display technology	type	• 3-chip 0.95" DMD								
	native resolution	• SXGA+ (1400 x 1050)			• HD (1920 x 1080)		• SXGA+ (1400 x 1050)		• HD (1920 x 1080)	
Lamp	type	• 1kW Cermax Xenon pre-aligned lamp module	• 1.2kW Cermax Xenon pre-aligned lamp module	• 1kW Cermax Xenon pre-aligned lamp module	• 1.2kW Cermax Xenon pre-aligned lamp module	• 2.0kW Xenon bubble lamp module	• 2.4kW Xenon bubble lamp module	• 3.0kW Xenon bubble lamp module	• 2.0kW Xenon bubble lamp module	
	estimated life	• 1500 hrs	• 1500 hrs	• 1500 hrs	• 1500 hrs	• 1000 hrs	• 750 hrs	• 750 hrs	• 1000 hrs	
Input	standard	• Analog • Dual link DVI				• Analog, Dual link DVI, 3G SD/HD-SDI, Video Decoder				
	optional	• Analog • Dual link DVI • 3G SD/HD-SDI • Video Decoder • Twin HDMI								
	signals	• HDTV formats VGA through to QXGA (2048 x 1536) • Accepts all current HDTV/DTV formats • Multi-standard video decoder • Horizontal and vertical scaling, all inputs								
	pixel clock	• 165 MHz (330 MHz high bandwidth mode)								
	scan rates	• Horizontal: 15-120kHz • Vertical: 23.97-150Hz								
Control and networking	• RS232 in/out • RS422 in • Ethernet (10/100) • USB Device • GPIO (RS232 9 Pin male connector) • Built-in backlit LCD keypad • Remote control (with optional wired XLR connection)									
Lenses	fixed	• ILS Lens 0.73:1 SX+/0.67:1 HD* • ILS Lens 1.2:1 SX+/1.1:1 HD								
	zoom	• ILS Lens 1.25-1.6:1 SX+/1.16-1.49:1 HD** • ILS Lens 1.5-2.0:1 SX+/1.4-1.8:1 HD • ILS Lens 2.0-2.8:1 SX+/1.8-2.6:1 HD • ILS Lens 2.8-4.5:1 SX+/2.6-4.1:1 HD • ILS Lens 4.5-7.5:1 SX+/4.1-6.9:1 HD • ILS Lens 7.5-11.2:1 SX+/6.9-10.4:1 HD								
	offsets	• ±100% Vertical • ±50% Horizontal • (* ±23%V ± 13%H) • (** ±70%V ±45%H)			• ±120% Vertical • ±54% Horizontal • (* ±35%V ±12%H) • (** ±102%V ±40%H)		• ±100% Vertical • ±50% Horizontal • (* ±23%V ±13%H) • (** ±70%V ±45%H)		• ±120% Vertical • ±54% Horizontal • (* ±35%V ±12%H) • (** ±102%V ±40%H)	
Accessories	standard	• IR remote • Line cord								
	optional	• Analog input card • Dual link DVI input card • Video decoder input card • Dual 3G SD/HD-SDI input card • Twin HDMI input card • DMX512 interface card • ILS lens adapter kit • Portrait display adapter (1.0kW and 2.0kW models only) • CT lens mount ¹ • Yellow notch filter ¹ • Fog juice filters (Roadster models only) • Ceiling mount • Ceiling mount extension • Stacking kit (1.0kW and 1.2kW models only) • Edge-blending kit • Remote IR sensor • Bulb alignment tool • Christie AutoStack (optional curve module available) • 3D upgrade kits ²								
Enhanced feature sets	• Embedded Christie Twist • Embedded image tiling • Intelligent Lens System (ILS) • 3D upgradable ² • Advanced block artifact reduction • ChristieNET Web interface • User-friendly, intuitive LCD keypad • Advanced loop-through twin HDMI card • Lamp memory module • Advanced, 10-bit processing • Automatic shut-off and ECO mode • Dust-sealed light engine • SNMP (simple network management protocol) • DHCP (dynamic host configuration protocol) • 24/7 operation • Hybrid stack • Compatibility with existing accessories					• Embedded Christie Twist • Embedded image tiling • Intelligent Lens System (ILS) • 3D upgradable • Advanced block artifact reduction • ChristieNET Web interface • User-friendly, intuitive LCD keypad • Advanced loop-through twin HDMI card • Lamp memory module • User-replaceable lamps • Advanced, 10-bit processing • Automatic shut-off and ECO mode • Dust-sealed light engine • SNMP (simple network management protocol) • DHCP (dynamic host configuration protocol) • 24/7 operation • Liquid cooling • Setup lights • Hybrid stack • Compatibility with existing accessories • Built-in portrait capabilities				
Power requirements (Dual lamp mode)	operating voltage	• 100-240 VAC @ 50/60Hz	• 200-240 VAC @ 50/60Hz	• 100-240 VAC @ 50/60Hz	• 200-240 VAC @ 50/60Hz	• 200-240 VAC @ 50/60Hz				
	maximum operating current	• 12A @ 100-120V • 8A @ 200-240V	• 10A @ 200V	• 12A @ 100-120V • 8A @ 200-240V	• 10A @ 200V	• 14A @ 200V	• 16A @ 200V	• 20A @ 200V	• 14A @ 200V	
	power	• 1200W	• 2000W	• 1200W	• 2000W	• 2800W	• 3200W	• 4000W	• 2800W	
	dissipation	• 4100 BTU/hr	• 6830 BTU/hr	• 4100 BTU/hr	• 6830 BTU/hr	• 9560 BTU/hr	• 10,925 BTU/hr	• 13,650 BTU/hr	• 9560 BTU/hr	
Dimensions	size	• (LxWxH): 22.3 x 26.0 x 12.9" (566 x 660 x 328mm)				• (LxWxH): 32.0 x 24.5 x 16.5" (815 x 621 x 419mm)				
	shipping size	• (LxWxH): 33.5 x 30.0 x 26.0" (851 x 762 x 660mm)				• (LxWxH): 41.0 x 32.5 x 29.5" (1041 x 825 x 749mm)				
	weight	• 88lbs (40kg) (without lens)				• 160lbs (72.5kg) (without lens)				
	shipping weight	• 125lbs (57kg)				• 200lbs (91kg)				
Operating environment	• Temperature: 40-104°F (5-40°C) • Humidity: 20-80% non-condensing									
Regulatory approvals	• Regulatory Approvals/Markings: Directives (EC) 2002/95/EC (RoHS); 2002/96/EC (WEEE); Regulation (EC) No. 1907/2006 (REACH) • CAN/CSA C22.2 No. 60950-1 • UL 60950-1 • IEC 60950-1 • FCC, Part 15, Subpart B, Class A • EN55022/CISPR22 Class A • EN55024 / CISPR24 • Certifications marks (check with CDS for latest update): cULus (Canada & US), CE (EU), CCC (China), GoST-R (Russia), KC (Korea), PSE (Japan), C-Tick (Australia & New Zealand), South Africa									
Limited warranty	• Three years parts and labor (including light engine)									

¹ Factory installed at time of purchase. ² Does not apply to DS+10K-J, HD9K-J. ³ Dimensions A, B and C are based on the lens being used.

Roadster HD16K-J	Roadster HD20K-J	Roadster WU20K-J
• 14,000 ANSI lumens (15,400 center lumens)	• 18,000 ANSI lumens (20,000 center lumens)	• 18,000 ANSI lumens (20,000 center lumens)

		• 3-chip 0.96" DMD • WU (1920 x 1200)
• 2.4kW Xenon bubble lamp module	• 3.0kW Xenon bubble lamp module	• 3.0kW Xenon bubble lamp module
• 750 hrs	• 750 hrs	• 750 hrs

		• ±112% Vertical • ±54% Horizontal • (* ±22%V ±6%H) • (** ±82%V ±38%H)
--	--	---

• 16A @ 200V	• 20A @ 200V	• 20A @ 200V
• 3200W	• 4000W	• 4000W
• 10,925 BTU/hr	• 13,650 BTU/hr	• 13,650 BTU/hr

Front view

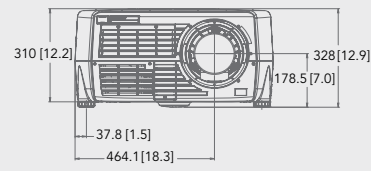

Side view³

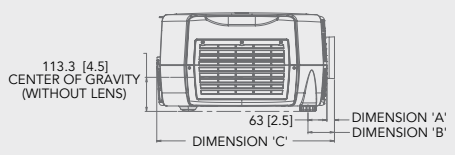

Top view

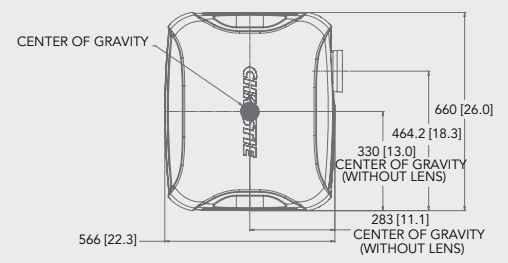

Underneath view

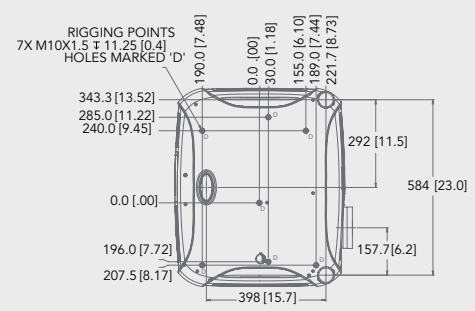

		Mirage DS+8K-J	Mirage HD7K-J	Mirage WU7K-J	Mirage S+14K-J	Mirage S+18K-J	Mirage S+22K-J	Mirage HD14K-J	Mirage HD16K-J	
Image	brightness	• 6800 ANSI (7500 center) lumens @ 220V • 5100 ANSI I (5610 center) lumens @ 110V	• 6200 ANSI (6850 center) lumens @ 220V • 4650 ANSI (5100 center) lumens @ 110V	• 6200 ANSI (6850 center) lumens @ 220V • 4650 ANSI (5100 center) lumens @ 110V	• 12,500 ANSI lumens (13,750 center lumens)	• 16,000 ANSI lumens (17,600 center lumens)	• 20,000 ANSI lumens (22,000 center lumens)	• 12,000 ANSI lumens (13,200 center lumens)	• 14,000 ANSI lumens (15,400 center lumens)	
	contrast	• 1600-2000:1 full field 650:1 ANSI								
	uniformity	• 90% brightness uniformity	• 80% brightness uniformity		• 90% brightness uniformity				• 80% brightness uniformity	
Display technology	type	• 3-chip 0.95" DMD			• 3-chip 0.96" DMD	• 3-chip 0.95" DMD				
	native resolution	• SXGA+ (1400 x 1050)	• HD (1920 x 1080)	• WUXGA (1920 x 1200)	• SXGA+ (1400 x 1050)			• HD (1920 x 1080)		
	frame delay	• As low as one frame								
Lamp	type	• 1.0kW Cermax Xenon pre-aligned lamp module			• 2.0kW Xenon bubble lamp module	• 2.4kW Xenon bubble lamp module	• 3.0kW Xenon bubble lamp module	• 2.0kW Xenon bubble lamp module	• 2.4kW Xenon bubble lamp module	
	estimated life	• 1500 hrs			• 1000 hrs	• 750 hrs	• 750 hrs	• 1000 hrs	• 750 hrs	
Input	standard	• Slot 1-2 populated, standard: two Dual Link DVI-D (330 MHz) input cards (each has VGA (165 MHz) for 3D or dual input 3D compatibility) with HDMI 1.3 receiver • Slot 3-4 unpopulated								
	optional	• Analog • Dual link DVI • SD/HD-SDI • Video decoder • Twin HDMI								
	signals	• HDTV formats VGA through to QWXGA (2560 x 1600) • Accepts all current 2D HDTV/DTV formats (optional input cards may be required) • HDMI 1.3 receiver supports mandatory HDMI 1.4a 3D modes of operation plus 24-144Hz triple flash 3D mode • Multi-standard video decoder • Horizontal and vertical scaling, all inputs								
	pixel clock	• 330 MHz								
scan rates	• Horizontal: 15-120kHz • Vertical: 23.97-150Hz (frame lock maximum 120Hz) • 48-60Hz frame doubled or dual input 3D • 48Hz (24Hz per eye) frame triple flash • 96-120Hz frame rate up to 1920 x 1200 • 24-144Hz									
Control and networking	• RS232 in/out • RS422 in • Ethernet (10/100) • USB Device • GPIO (RS232 9 Pin male connector) • Built-in backlit LCD keypad • Remote control (with optional wired XLR connection)									
Optical system	• Dust-sealed 3-chip DMD light engine • Motorized horizontal and vertical lens offset • Scheimpflug/Boresite (tilt) adjustment • Built-in light shutter • Tool-free lens insertion system									
Lenses	fixed	• ILS Lens 0.73:1 SX+ / 0.67:1 HD* • ILS Lens 1.2:1 SX+ / 1.1:1 HD								
	zoom	• ILS Lens 1.25-1.6:1 SX+ / 1.16-1.49:1 HD** • ILS Lens 1.5-2.0:1 SX+ / 1.4-1.8:1 HD • ILS Lens 2.0-2.8:1 SX+ / 1.8-2.6:1 HD • ILS Lens 2.8-4.5:1 SX+ / 2.6-4.1:1 HD • ILS Lens 4.5-7.5:1 SX+ / 4.1-6.9:1 HD • ILS Lens 7.5-11.2:1 SX+ / 6.9-10.4:1 HD								
	offsets	• ±100% Vertical • ±50% Horizontal • (* ±23%V ±13%H) • (** ±70%V ±45%H)	• ±120% Vertical • ±54% Horizontal • (* ±35%V ±12%H) • (** ±102%V ±40%H)	• ±112% Vertical • ±54% Horizontal • (* ±22%V ±6%H) • (** ±82%V ±38%H)	• ±100% Vertical • ±50% Horizontal • (* ±23%V ±13%H) • (** ±70%V ±45%H)	• ±120% Vertical • ±54% Horizontal • (* ±35%V ±12%H) • (** ±102%V ±40%H)	• ±120% Vertical • ±54% Horizontal • (* ±35%V ±12%H) • (** ±102%V ±40%H)	• ±120% Vertical • ±54% Horizontal • (* ±35%V ±12%H) • (** ±102%V ±40%H)	• ±120% Vertical • ±54% Horizontal • (* ±35%V ±12%H) • (** ±102%V ±40%H)	• ±120% Vertical • ±54% Horizontal • (* ±35%V ±12%H) • (** ±102%V ±40%H)
Accessories	standard	• IR remote • Line cord								
	optional	• ILS lens adapter kit • CT lens mount ¹ • Yellow notch filter ¹ • 3D glasses (active and passive) • 3D active emitter • 3D passive modulator • Stacking kit • DMX512 interface card • Analog input card • Dual link DVI input card • SD/HD-SDI input card • Video decoder input card • Twin HDMI input card • Ceiling mount • Ceiling mount extension • Remote IR sensor				• ILS lens adapter kit • CT lens mount ¹ • Yellow notch filter ¹ • 3D glasses (active and passive) • 3D active emitter • 3D passive modulator • Fog juice filters • DMX512 interface card • Analog input card • Dual link DVI input card • SD/HD-SDI input card • Video decoder input card • Twin HDMI input card • Remote IR sensor • Bulb alignment tool • Bare bulb kit • Ceiling mount • Ceiling mount extension				
Enhanced feature sets	• Embedded Christie Twist • Embedded image tiling • Intelligent Lens System (ILS) • Advanced block artifact reduction • ChristieNET web interface • User-friendly, intuitive LCD keypad • Advanced loop-through Twin HDMI card • Lamp memory module • User replaceable bulbs (2.0kW, 2.4kW and 3.0kW only) • Advanced 10-bit processing • Automatic shut-off and ECO mode • Dust-sealed light engine • SNMP (simple network management protocol) • DHCP (dynamic host configuration protocol) • Liquid cooling (2.0kW, 2.4kW, 3.0kW models only) • Setup lights (2.0kW, 2.4kW, 3.0kW models only) • Hybrid stack • Compatibility with legacy accessories									
Power requirements (Dual lamp mode)	operating voltage	• 100-240 VAC @ 50/60Hz	• 200-240 VAC @ 50/60Hz	• 100-240 VAC @ 50/60Hz	• 200-240 VAC @ 50/60Hz					
	maximum operating current	• 12A @ 100-120V • 8A @ 200-240V			• 14A @ 200V	• 16A @ 200V	• 20A @ 200V	• 14A @ 200V	• 16A @ 200V	
	power	• 1600W			• 2800W	• 3200W	• 4000W	• 2800W	• 3200W	
	dissipation	• 5460 BTU/hr			• 9560 BTU/hr	• 10,925 BTU/hr	• 13,650 BTU/hr	• 9560 BTU/hr	• 10,925 BTU/hr	
Dimensions	size	• (LxWxH): 22.3 x 26.0 x 12.9" (566 x 660 x 328mm)			• (LxWxH): 32.0 x 24.5 x 16.5" (815 x 621 x 419mm)					
	shipping size	• (LxWxH): 33.5 x 30.0 x 26.0" (851 x 762 x 660mm)			• (LxWxH): 41.0 x 32.5 x 29.5" (1041 x 825 x 749mm)					
	weight	• 88lbs (40kg) (without lens)			• 160lbs (72.5kg) (without lens)					
	shipping weight	• 125lbs (57kg)			• 200lbs (91kg)					
Operating environment	• Temperature: 40-104°F (5-40°C) • Humidity: 20-80% non-condensing									
Regulatory approvals	• Regulatory Approvals/Markings: Directives (EC) 2002/95/EC (RoHS); 2002/96/EC (WEEE); Regulation (EC) No. 1907/2006 (REACH) • CAN/CSA C22.2 No. 60950-1 • UL 60950-1 • IEC 60950-1 • FCC, Part 15, Subpart B, C • Certifications marks (check with CDS for latest update): cULus (Canada & US), CE (EU), CCC (China), GoS-T-R (Russia), KC (Korea), PSE (Japan), C-Tick (Australia & New Zealand), South Africa									
Limited warranty	• Three years parts and labor (including light engine)									

¹ Factory installed at time of purchase. ² Dimensions A, B and C are based on the lens being used.

Mirage HD20K-J	Mirage WU14K-J	Mirage WU20K-J
• 18,000 ANSI lumens (20,000 center lumens)	• 12,000 ANSI lumens (13,200 center lumens)	• 18,000 ANSI lumens (20,000 center lumens)

• 3-chip 0.96" DMD	• WUXGA (1920 x 1200)
--------------------	-----------------------

• 3.0kW Xenon bubble lamp module	• 2.0kW Xenon bubble lamp module	• 3.0kW Xenon bubble lamp module
• 750 hrs	• 1000 hrs	• 750 hrs

triple flash 3D

- ±112% Vertical
- ±54% Horizontal
- (* ±22%V ±6%H)
- (** ±82%V ±38%H)

• 20A @ 200V	• 14A @ 200V	• 20A @ 200V
• 4000W	• 2800W	• 4000W
• 13,650 BTU/hr	• 9560 BTU/hr	• 13,650 BTU/hr

Class A • EN55022/CISPR22 Class A • EN55024 / CISPR24

Front view

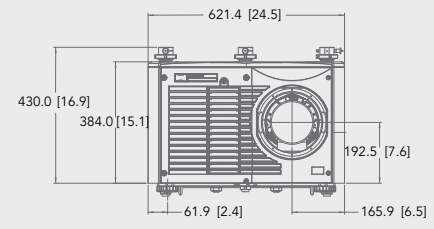

Side view²

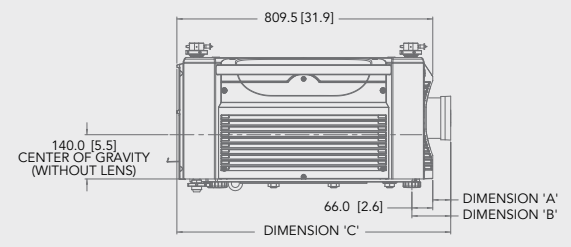

Top view

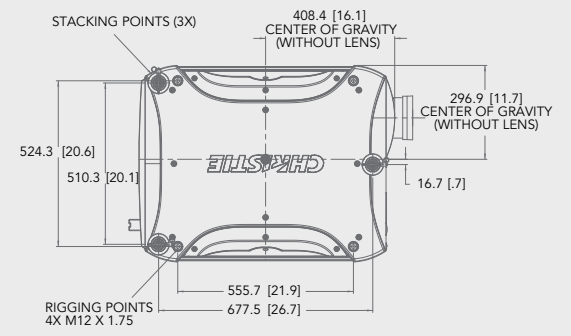

Underneath view

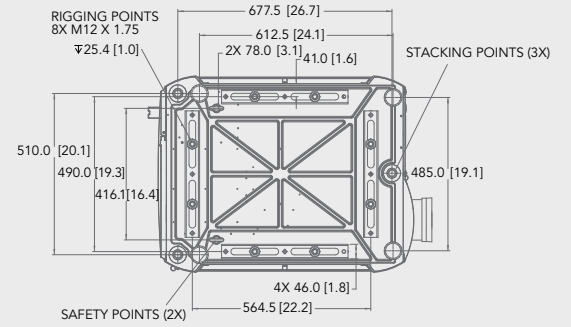

Corporate offices

Christie Digital Systems USA, Inc.
USA – Cypress
ph: 714 236 8610

Christie Digital Systems Canada Inc.
Canada – Kitchener
ph: 519 744 8005

Independent sales consultant offices

Italy
ph: +39 (0) 2 9902 1161

Worldwide offices

United Kingdom
ph: +44 (0) 118 977 8000

Germany
ph: +49 2161 664540

France
ph: +33 (0) 1 41 21 44 04

Spain
ph: +34 91 633 9990

Eastern Europe and
Russian Federation
ph: +36 (0) 1 47 48 100

Republic of South Africa
ph: +27 (0)11 510 0094

United Arab Emirates
ph: +971 4 3206688

India
ph: +91 80 6708 9999

Singapore
ph: +65 6877 8737

China (Shanghai)
ph: +86 21 6278 7708

China (Beijing)
ph: +86 10 6561 0240

Japan (Tokyo)
ph: 81 3 3599 7481

Korea (Seoul)
ph: +82 2 702 1601



ISO 9001
ISO 14001

Kitchener, Ontario



For the most current specification information, please visit www.christiedigital.com

 Copyright 2013 Christie Digital Systems USA, Inc. All rights reserved. All brand names and product names are trademarks, registered trademarks or tradenames of their respective holders. Christie Digital Systems Canada Inc.'s management system is registered to ISO 9001 and ISO 14001. Performance specifications are typical. Due to constant research, specifications are subject to change without notice.
Printed in Canada on recycled paper. 3500 Mar 13

CHRISTIE®