



This user manual includes detailed usage instructions for your camera. Please read this manual thoroughly.

USER MANUAL

WB250F/WB251F/WB280F

Click a topic

Basic troubleshooting

Quick reference

Contents

Basic functions

Extended functions

Shooting options

Playback/Editing

Wireless network

Settings

Appendixes

Index

Health and safety information

Always comply with the following precautions and usage tips to avoid dangerous situations and ensure peak performance of your camera.



Warning—situations that could cause injury to yourself or others

Do not disassemble or attempt to repair your camera.

This may result in electric shock or damage to the camera.

Do not use your camera near flammable or explosive gases and liquids.

This may cause a fire or explosion.

Do not insert flammable materials into the camera or store these materials near the camera.

This may cause a fire or electric shock.

Do not handle your camera with wet hands.

This may result in electric shock.

Prevent damage to subjects' eyesight.

Do not use the flash in close proximity (closer than 1 m/3 ft) to people or animals. If you use the flash too close to your subject's eyes, you can cause temporary or permanent eyesight damage.

Keep your camera away from small children and pets.

Keep your camera and all accessories out of the reach of small children and animals. Small parts may cause choking or serious injury if swallowed. Moving parts and accessories may present physical dangers as well.

Do not expose the camera to direct sunlight or high temperatures for an extended period of time.

Prolonged exposure to sunlight or extreme temperatures can cause permanent damage to your camera's internal components.

Avoid covering the camera or charger with blankets or clothes.

The camera may overheat, which may distort the camera or cause a fire.

Do not handle the power supply cord or go near the charger during a thunderstorm.

This may result in electric shock.

If liquid or foreign objects enter your camera, immediately disconnect all power sources, such as the battery or charger, and then contact a Samsung service center.

Comply with any regulations that restrict the use of a camera in a certain area.

- Avoid interference with other electronic devices.
- Turn off the camera when in an aircraft. Your camera can cause interference with aircraft equipment. Follow all airline regulations and turn off your camera when directed by airline personnel.
- Turn off the camera near medical equipment. Your camera can interfere with medical equipment in hospitals or health care facilities. Follow all regulations, posted warnings, and directions from medical personnel.

Avoid interference with pacemakers.

Maintain the distance between this camera and all pacemakers to avoid potential interference, as recommended by the manufacturer and research groups. If you have any reason to suspect that your camera is interfering with a pacemaker or other medical device, turn off the camera immediately and contact the manufacturer of the pacemaker or medical device for guidance.



Caution—situations that could cause damage to your camera or other equipment

Remove the batteries from your camera when storing it for an extended period of time.

Installed batteries may leak or corrode over time and cause serious damage to your camera.

Use only authentic, manufacturer-recommended, Lithium-ion replacement batteries. Do not damage or heat the battery.

Inauthentic, damaged, or heated batteries may cause a fire or personal injury.

Use only Samsung-approved batteries, chargers, cables and accessories.

- Using unauthorized batteries, chargers, cables or accessories can cause batteries to explode, damage your camera, or cause injury.
- Samsung is not responsible for damage or injuries caused by unapproved batteries, chargers, cables or accessories.

Use the battery only for its intended purpose.

Misusing the battery may cause a fire or electric shock.

Do not touch the flash while it fires.

The flash is very hot when fired and may burn your skin.

When you use the AC charger, turn off the camera before you disconnect the power to the AC charger.

Failing to do so may result in fire or electric shock.

Disconnect the charger from the wall socket when not in use.

Failing to do so may result in fire or electric shock.

Do not use a damaged power supply cord, plug, or loose outlet when you charge batteries.

This may cause a fire or electric shock.

Do not allow the AC charger to come in contact with the +/- terminals on the battery.

This may cause a fire or electric shock.

Do not drop or subject the camera to strong impacts.

Doing so may damage the screen or external or internal components.

Exercise caution when you connect cables or adapters and install batteries and memory cards.

If you force the connectors, improperly connect cables, or improperly install batteries and memory cards, you can damage ports, connectors, and accessories.

Keep cards with magnetic strips away from the camera case.

Information stored on the card may be damaged or erased.

Never use a damaged charger, battery, or memory card.

This may result in electric shock or camera malfunction or cause a fire.

Do not place the camera in or near magnetic fields.

Doing so may cause the camera to malfunction.

Do not use the camera if the screen is damaged.

If the glass or acrylic parts are broken, visit a Samsung Electronics Service Center to have the camera repaired.

Check that the camera is operating properly before use.

The manufacturer takes no responsibility for any loss of files or damage that may result from camera malfunction or improper use.

You must plug the small end of the USB cable into your camera.

If the cable is reversed, it may damage your files. The manufacturer is not responsible for any loss of data.

Avoid interference with other electronic devices.

Your camera emits radio frequency (RF) signals that may interfere with unshielded or improperly shielded electronic equipment, such as pacemakers, hearing aids, medical devices, and other electronic devices in homes or vehicles. Consult the manufacturers of your electronic devices to solve any interference problems you experience. To prevent unwanted interference, use only Samsung-approved devices or accessories.

Use your camera in the normal position.

Avoid contact with your camera's internal antenna.

Data transference and your responsibilities

- Data transferred via WLAN can be hacked, so avoid transferring sensitive data in public areas or on open networks.
- The camera manufacturer is not liable for any data transfers that infringe on copyrights, trademarks, intellectual property laws, or public decency ordinances.

Copyright information



- Microsoft Windows and the Windows logo are registered trademarks of the Microsoft Corporation.
- Mac and Apple App Store are registered trademarks of the Apple Corporation.
- Google Play Store is a registered trademark of Google, Inc.
- microSD™, microSDHC™, and microSDXC™ are registered trademarks of the SD Association.
- Wi-Fi®, the Wi-Fi CERTIFIED logo, and the Wi-Fi logo are registered trademarks of the Wi-Fi Alliance.
- Trademarks and trade names used in this manual are the property of their respective owners.

- Camera specifications or contents of this manual may be changed without prior notice due to an upgrade of the camera's functions.
- We recommend using your camera within the country where you purchased it.
- Use this camera responsibly and adhere to all laws and regulations concerning its use.
- You are not allowed to reuse or distribute any part of this manual without prior permission.

Outline of the User Manual

Basic functions	18
Learn about your camera's layout, icons, and basic functions for shooting.	
Extended functions	41
Learn how to capture a photo and record a video by selecting a mode.	
Shooting options	62
Learn how to set the options in Shooting mode.	
Playback/Editing	86
Learn how to play back photos or videos, and edit photos. Also, learn how to connect your camera to your computer or TV.	
Wireless network	110
Learn how to connect to wireless local area networks (WLANs) and use functions.	
Settings	130
Refer to options to configure your camera's settings.	
Appendixes	136
Get information about error messages, specifications, and maintenance.	

Indicators used in this manual

Mode	Indicator
Smart Auto	AUTO
Program	P
Aperture Priority, Shutter Priority, Manual	A S M
Smart	S
Best Face	
Magic Plus	
Settings	
Wi-Fi	Wi-Fi

Shooting mode icons

These icons appear in the text when a function is available in a mode. See the example below.

Note: The  or  mode may not support functions for all scenes or modes.

For example:



Adjusting the exposure manually (EV)  Available in Program, Aperture Priority, and Shutter Priority modes

Depending on the intensity of the ambient light, your photos may be too bright or dark. In these cases, you can adjust the exposure to get a better photo.



▲ Darker (-) ▲ Neutral (0) ▲ Brighter (+)

Icons used in this manual

Icon	Function
	Additional information
	Safety warnings and precautions
[]	Camera buttons. For example, [Shutter] represents the shutter button.
()	Page number of related information
→	The order of options or menus you must select to perform a step; for example: Select Face Detection → Normal (represents Select Face Detection , and then select Normal).
*	Annotation

Expressions used in this manual

Pressing the shutter

- Half-press [**Shutter**]: Press the shutter halfway down
- Press [**Shutter**]: Press the shutter all the way down

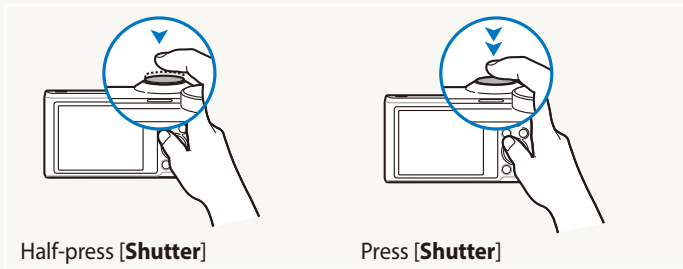

Subject, background, and composition

- **Subject:** The main object in a scene, such as a person, animal, or still life
- **Background:** The objects around the subject
- **Composition:** The combination of a subject and background

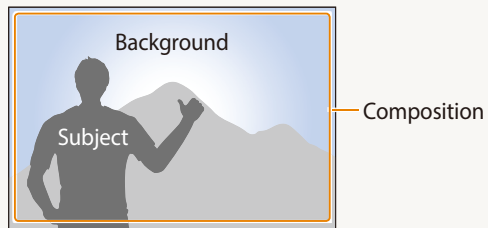

Exposure (Brightness)

The amount of light that enters your camera determines the exposure. You can alter the exposure by changing the shutter speed, aperture value, or ISO sensitivity. By altering the exposure, your photos will be darker or lighter.



▲ Normal exposure

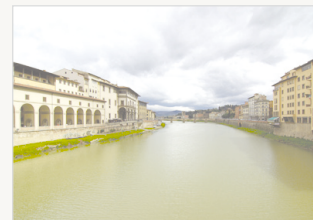

▲ Overexposure (too bright)

Special features of your camera

Using the Touch screen and camera buttons

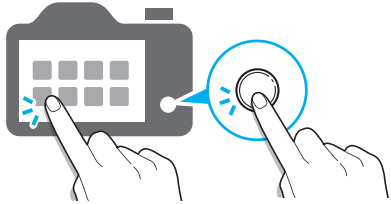

You can operate the camera by either touching the screen or pressing the camera buttons.

Using the DIRECT LINK button



Press the DIRECT LINK button to activate the Wi-Fi function that you have designated.

Setting a DIRECT LINK button option

You can select a Wi-Fi function to launch when you press the DIRECT LINK button.

1 Access Settings.

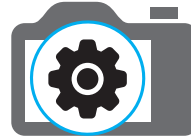

2 Access the DIRECT LINK button option.

3 Select a Wi-Fi feature from the list.

Special features of your camera

Using MobileLink

You can send files easily from your camera to a smart phone. The camera connects wirelessly to smart phones that support the MobileLink feature.

- 1 Install the **Samsung Smart Camera** application on the smart phone.



- 2 Access the **MobileLink** mode.
 - If a pop-up message appears, select an option.

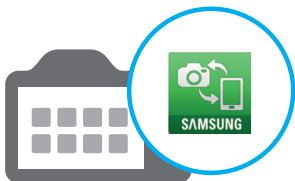

- 3 Launch the **Samsung Smart Camera** application on the smart phone.



- 4 Select the camera from the list and connect the smart phone to the camera.

- If a pop-up message appears on your camera, allow the smart phone to connect to your camera.



- 5 On the smart phone or camera, select files to transfer from the camera.



- 6 On the smart phone, touch the copy button or on the camera, select **Share**.



Special features of your camera

Using Remote Viewfinder

You can remotely control your camera from a smart phone. The camera connects to a smart phone wirelessly. Use the smart phone as a remote shutter release with the Remote Viewfinder feature. The captured photo will appear on the smart phone.

- 1 Install the **Samsung Smart Camera** application on the smart phone.



- 2 Access the **Remote Viewfinder** mode.



- 3 Launch the **Samsung Smart Camera** application on the smart phone.



- 4 Select the camera from the list and connect the smart phone to the camera.

- If a pop-up message appears on your camera, allow the smart phone to connect to your camera.



- 5 Touch and hold  to focus, and then release it to capture a photo.



- 6 Touch the thumbnail to view the photo.



Special features of your camera

Shooting samples – Macro

You can capture close up shots of small subjects, such as flowers or insects.



The example image may differ from the actual photo that you capture.



- 1 Select the macro option (🌷).





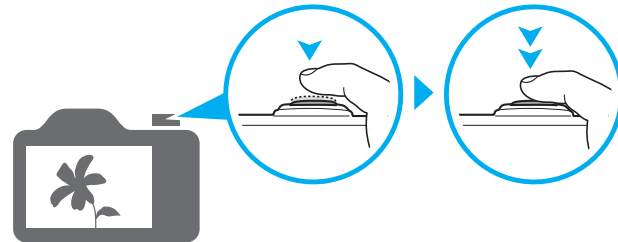







- 2 Capture a photo.



Basic troubleshooting

Learn to solve common problems by setting shooting options.

	The subject's eyes appear red.	<p>Red eye occurs when the subject's eyes reflect light from the camera flash.</p> <ul style="list-style-type: none">• Set the flash option to  Red-eye or  Red-eye Fix. (p. 65)• If the photo has already been captured, select  Red-eye Fix in the edit menu. (p. 99)
	Photos have dust spots.	<p>If dust particles are present in the air, you may capture them in photos when you use the flash.</p> <ul style="list-style-type: none">• Turn off the flash or avoid capturing photos in a dusty place.• Set ISO sensitivity options. (p. 68)
	Photos are blurred.	<p>Blurring can occur if you capture photos in low light conditions or hold the camera incorrectly. Use the OIS function or half-press [Shutter] to ensure the subject is in focus. (p. 39)</p>
	Photos are blurred when shooting at night.	<p>As the camera tries to let in more light, the shutter speed slows. This can make it difficult to hold the camera steady long enough to capture a clear photo and may result in camera shake.</p> <ul style="list-style-type: none">• Select Low Light Shot in  mode. (p. 49)• Turn on the flash. (p. 66)• Set ISO sensitivity options. (p. 68)• Use a tripod to prevent your camera from shaking.
	Subjects come out too dark because of backlighting.	<p>When the light source is behind the subject or when there is a high contrast between light and dark areas, the subject may appear too dark.</p> <ul style="list-style-type: none">• Avoid shooting toward the sun.• Set the flash option to  Fill in. (p. 66)• Adjust the exposure. (p. 77)• Set the Auto Contrast Balance (ACB) option. (p. 78)• Set the metering option to  Spot if a subject is in the center of the frame. (p. 78)

Quick reference



Capturing photos of people

- **S** mode > Beauty Face ▶ 49
- **FR** mode ▶ 52
- Red-eye/Red-eye Fix (to prevent or correct red-eye) ▶ 65
- Face Detection ▶ 74
- Self-Portrait ▶ 74



Capturing photos at night or in the dark

- **S** mode > Silhouette, Fireworks, Light Trace, Low Light Shot ▶ 49
- Flash options ▶ 66
- ISO sensitivity (to adjust the sensitivity to light) ▶ 68



Capturing action photos

- Shutter Priority mode ▶ 47
- **S** mode > Action Freeze, Continuous Shot ▶ 49
- Continuous ▶ 82



Capturing photos of text, insects, or flowers

- **S** mode > Macro ▶ 49
- Macro ▶ 69



Adjusting the exposure (brightness)

- **S** mode > Rich Tones ▶ 49
- ISO sensitivity (to adjust the sensitivity to light) ▶ 68
- EV (to adjust exposure) ▶ 77
- ACB (to compensate for subjects against bright backgrounds) ▶ 78
- Metering ▶ 78
- AE Bracket (to capture 3 photos of the same scene with different exposures) ▶ 83



Capturing photos of scenery

- **S** mode > Landscape, Waterfall ▶ 49
- **S** mode > Panorama ▶ 50



Applying effects to photos

- **★** mode > My Magic Frame ▶ 53
- **★** mode > Split Shot ▶ 55
- **★** mode > Motion Photo ▶ 56
- **★** mode > Photo Filter ▶ 57
- Image Adjust (to adjust Sharpness, Contrast, or Saturation) ▶ 84



Applying effects to videos

- **★** mode > Movie Filter ▶ 58



Reducing camera shake

- Optical Image Stabilization (OIS) ▶ 38

- Viewing files by category in Smart Album ▶ 89
- Viewing files as thumbnails ▶ 90
- Deleting all files on the memory ▶ 91
- Viewing files as a slide show ▶ 93
- Viewing files on a TV ▶ 100
- Connecting your camera to a computer ▶ 101
- Sending photos or videos via email ▶ 123
- Using photo or video sharing websites ▶ 124
- Adjusting sound and volume ▶ 132
- Adjusting the brightness of the display ▶ 133
- Changing the display language ▶ 134
- Setting the date and time ▶ 134
- Before contacting a service center ▶ 148

Contents

Basic functions	18
Unpacking	19
Camera layout	20
Using the DIRECT LINK button	22
Inserting the battery and memory card	23
Charging the battery and turning on your camera	24
Charging the battery	24
Turning on your camera	24
Performing the initial setup	25
Learning icons	27
Selecting modes	28
Icons on the Mode screen	28
Selecting options or menus	30
Selecting with buttons	30
Selecting by touch	31
Setting the display and sound	33
Setting the display type	33
Setting the sound	34
Capturing photos	35
Zooming	36
Reducing camera shake (OIS)	38
Tips for getting a clearer photo	39

Extended functions	41
Using the Smart Auto mode	42
Using the Program mode	44
Using the Aperture Priority, Shutter Priority, or Manual mode	45
Using the Aperture Priority mode	46
Using the Shutter Priority mode	47
Using the Manual mode	48
Using the Smart mode	49
Using the Panorama mode	50
Using the Best Face mode	52
Using the Magic Plus mode	53
Using the My Magic Frame mode	53
Using the Split Shot mode	55
Using the Motion Photo mode	56
Using the Photo Filter mode	57
Using the Movie Filter mode	58
Recording a video	59
Recording a video with the Smart Scene Detection function	60

Shooting options	62	Using Face Detection	74
Selecting a resolution and quality	63	Detecting faces	74
Selecting a resolution	63	Capturing a self portrait shot	74
Selecting a photo quality	64	Capturing a smile shot	75
Shooting in the dark	65	Detecting eye blinking	75
Preventing red-eye	65	Tips for detecting faces	76
Using the flash	65	Adjusting brightness and color	77
Setting a flash option	66	Adjusting the exposure manually (EV)	77
Adjusting the ISO sensitivity	68	Compensating for backlighting (ACB)	78
Changing the camera's focus	69	Changing the metering option	78
Using macro	69	Selecting a White Balance setting	79
Using auto focus	69	Using burst modes	82
Adjusting the focus area	71	Capturing continuous photos	82
Adjusting the focus by touch	71	Using the timer	83
		Capturing bracketed photos	83
		Adjusting images	84
		Reducing the sound of the zoom	85

Playback/Editing	86
Viewing photos or videos in Playback mode	87
Starting Playback mode	87
Viewing photos	92
Playing a video	94
Editing a photo	96
Resizing photos	96
Rotating a photo	96
Cropping a photo	97
Applying Smart Filter effects	97
Adjusting your photos	98
Viewing files on a TV	100
Transferring files to the computer	101
Transferring files to your Windows OS computer	101
Transferring files to your Mac OS computer	102
Using programs on the computer	104
Installing i-Launcher	104
Using i-Launcher	105

Wireless network	110
Connecting to a WLAN and configuring network settings	111
Connecting to a WLAN	111
Using the login browser	112
Network connection tips	113
Entering text	114
Sending photos or videos to a smart phone	115
Using a smart phone as a remote shutter release	116
Saving files to a smart phone automatically	118
Using Auto Backup to send photos or videos	119
Installing the program for Auto Backup on your PC	119
Sending photos or videos to a PC	119
Sending photos or videos via email	121
Changing email settings	121
Sending photos or videos via email	123
Using photo or video sharing websites	124
Accessing a website	124
Uploading photos or videos	124
Using AllShare Play to send files	126
Uploading photos to online storage	126
Viewing photos or videos on devices that support AllShare Play	127
Sending photos using Wi-Fi Direct	129

Settings	130
Settings menu	131
Accessing the settings menu	131
Sound	132
Display	132
Connectivity	133
General	134
Appendixes	136
Error messages	137
Camera maintenance	139
Cleaning your camera	139
Using or storing the camera	140
About memory cards	141
About the battery	144
Before contacting a service center	148
Camera specifications	151
Glossary	155
Index	160

Basic functions

Learn about your camera's layout, icons, and basic functions for shooting.

Unpacking	19	Selecting options or menus	30
Camera layout	20	Selecting with buttons	30
Using the DIRECT LINK button	22	Selecting by touch	31
Inserting the battery and memory card	23	Setting the display and sound	33
Charging the battery and turning on your camera	24	Setting the display type	33
Charging the battery	24	Setting the sound	34
Turning on your camera	24	Capturing photos	35
Performing the initial setup	25	Zooming	36
Learning icons	27	Reducing camera shake (OIS)	38
Selecting modes	28	Tips for getting a clearer photo	39
Icons on the Mode screen	28		

Unpacking

The following items are included in your product box.

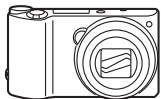

Camera



AC adapter/USB cable

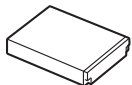

Rechargeable battery



Strap

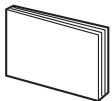

Quick Start Guide

Optional accessories



Camera case

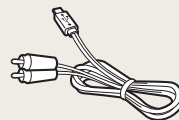

A/V cable

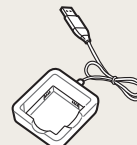

Battery charger



Memory card



Memory card/Memory card adapter



- The illustrations may differ slightly from the items shipped with your product.
- The items included in the box may differ depending on the model.
- You can purchase optional accessories at a retailer or a Samsung service center. Samsung is not responsible for any problems caused by using unauthorized accessories.

Camera layout

Before you start, familiarize yourself with your camera's parts and their functions.

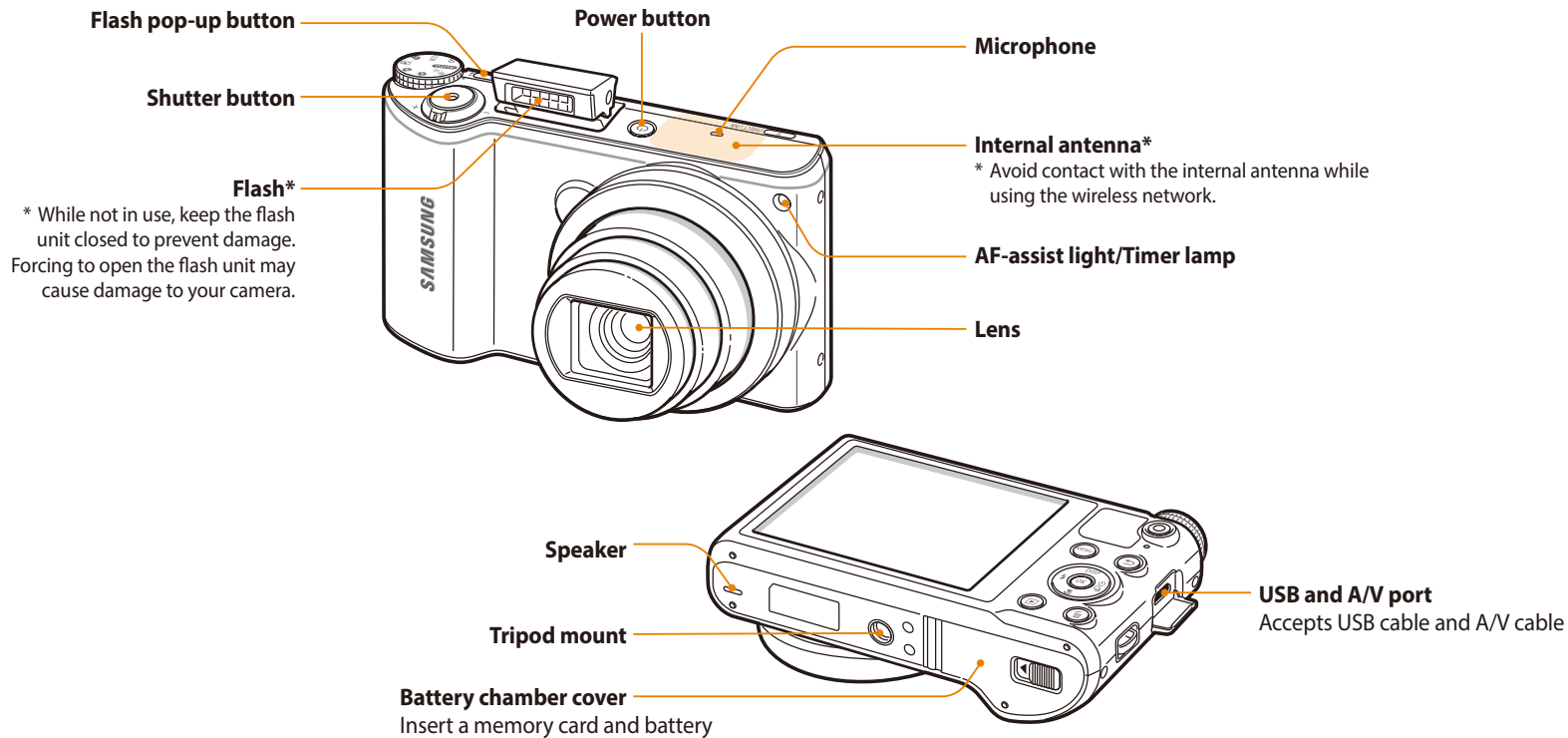

DIRECT LINK button

Start a preset Wi-Fi function

Status lamp

- **Blinking:** When the camera is saving a photo or video, being read by a computer, when the image is out of focus, there is a problem charging the battery, or when the camera is connecting to WLAN or sending a photo
- **Steady:** When the camera is connected to a computer, charging the battery, or when the image is in focus

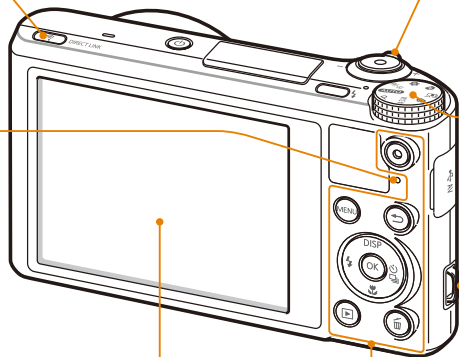

Display

Buttons
(p. 22)

Zoom button

- **In Shooting mode:** Zoom in or out
- **In Playback mode:** Zoom in on part of a photo or view files as thumbnails, or adjust the volume







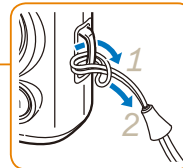



Mode dial

(p. 28)

Attaching the strap



Buttons

Button	Description		
	Start recording a video.		
	Access options or menus.		
	Go back.		
	Basic functions	Other functions	
	 DISP	Change the display option.	Move up
		Change the macro option.	Move down
		Change the flash option.	Move left
		Change the timer and burst options.	Move right
	Confirm the highlighted option or menu.		
	Enter Playback mode.		
	Delete files in Playback mode.		

Using the DIRECT LINK button

You can turn on the Wi-Fi feature conveniently with **[DIRECT LINK]**. Press **[DIRECT LINK]** to activate the Wi-Fi function that you have designated. Press **[DIRECT LINK]** again to return to the previous mode.

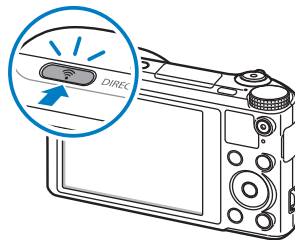

Setting a DIRECT LINK button option

You can select a Wi-Fi function to launch when you press **[DIRECT LINK]**.

- 1 Rotate the mode dial to .
- 2 Select **General** → **DIRECT LINK (Wi-Fi Button)**.
- 3 Select a Wi-Fi feature. (p. 135)

Inserting the battery and memory card

Learn how to insert the battery and an optional memory card into the camera.

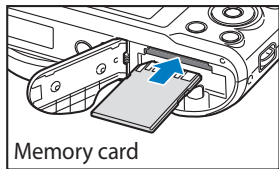
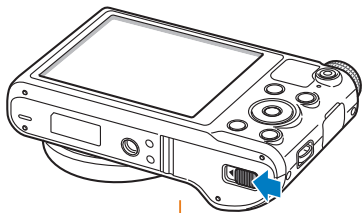

Memory card

Insert a memory card with the gold-colored contacts facing up.

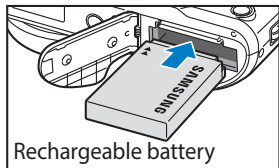

Rechargeable battery

Insert the battery with the Samsung logo facing up.

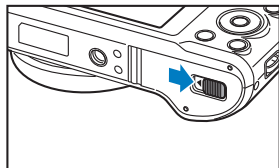
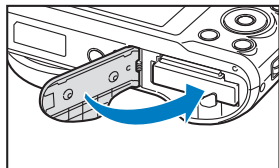

Removing the battery and memory card

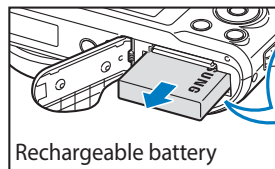

Rechargeable battery



Battery lock

Slide the lock down to release the battery.

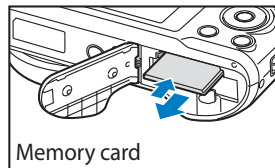

Memory card

Push the card gently until it disengages from the camera, and then pull it out of the slot.

Using the memory card adapter

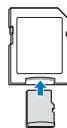

To use micro memory cards with this product, a PC, or a memory card reader, insert the card into an adapter.



You can use the internal memory for temporary storage if a memory card is not inserted.

Charging the battery and turning on your camera

Charging the battery

Before you use the camera for the first time, you must charge the battery. Plug the small end of the USB cable into your camera, and then plug the other end of the USB cable into the AC adapter.

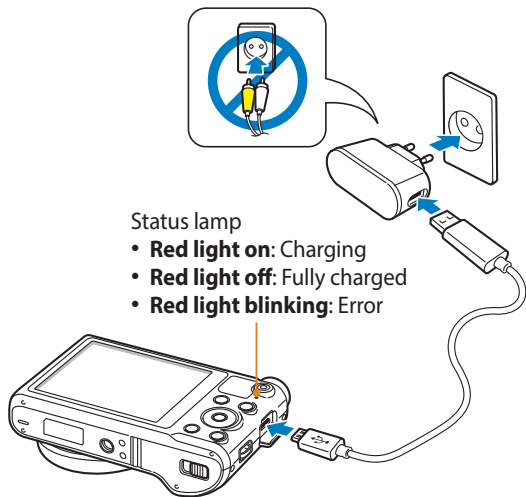

Use only the AC adapter and USB cable supplied with your camera. If you use another AC adapter (such as SAC-48), the camera battery may not charge or work properly.

Turning on your camera

Press [ON] to turn your camera on or off.

- The initial setup screen appears when you turn on the camera for the first time. (p. 25)

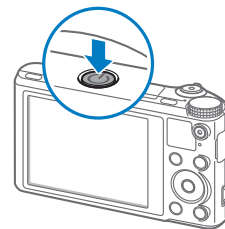

Turning on your camera in Playback mode

Press [▶]. The camera turns on and immediately accesses Playback mode.

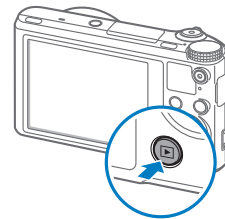

Performing the initial setup

When you turn on your camera for the first time, the initial setup screen appears. Follow the steps below to configure the camera's basic settings. The language is preset for the country or region where the camera is sold. You can change the language as desired. You can also select an item by touching it on the screen.

- 1 Press [] to select **Time Zone**, and then press [] or **[OK]**.
- 2 Press [**DISP**/] to select **Home**, and then press **[OK]**.
 - When you travel to another country, select **Visit**, and then select a new time zone.
- 3 Press [**DISP**/] to select a time zone, and then press **[OK]**.

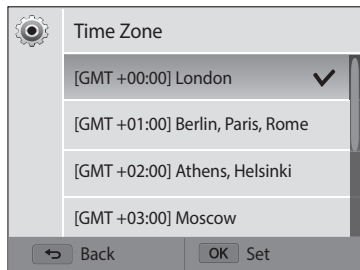





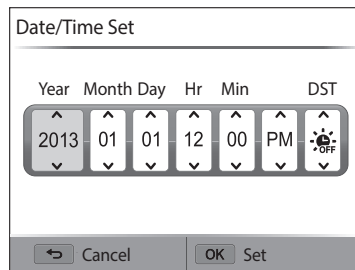

- 4 Press [].

- 5 Press [] to select **Date/Time Set**, and then press [] or **[OK]**.



- The screen may differ depending on the language selected.

- 6 Press [] to select an item.
- 7 Press [**DISP**/] to set the date, time, and daylight-saving time, and then press **[OK]**.

- 8 Press [>] to select **Date Type**, and then press [>] or [OK].
- 9 Press [DISP/>] to select a date type, and then press [OK].
- 10 Press [>] to select **Time Type**, and then press [>] or [OK].
- 11 Press [DISP/>] to select a time type, and then press [OK].
- 12 Press [>] to finish the initial setup.

Learning icons

The icons the camera displays on the screen change according to the mode you select or the options you set. If you change a shooting option, the corresponding icon will blink briefly in yellow.

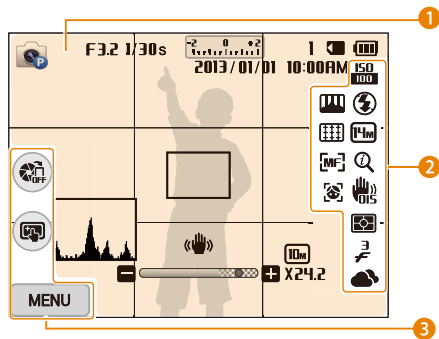

1 Shooting information

Icon	Description
	Shooting mode
F3.2	Aperture value
1/30s	Shutter speed
00:00:10	Elapsed recording time
	Exposure value
2013/01/01	Current date
10:00 AM	Current time
1	Available number of photos

Icon	Description
	Memory card inserted
	<ul style="list-style-type: none"> : Fully charged : Partially charged : Empty (Recharge) : Charging (Connected with the charger)
	Auto focus frame
	Camera shake
	Zoom indicator
	Photo resolution when the Intelli zoom is on
x24.2	Zoom ratio
	Histogram (p. 33)

2 Shooting option

Icon	Description
	ISO sensitivity
	Flash
	Photo resolution
	Video resolution

Icon	Description
	Frame rate (per second)
	Sound Alive on
	Intelli zoom on
	Optical Image Stabilization (OIS)
	Metering
	Burst option
	Timer
	White balance
	Image adjustment (sharpness, contrast, and saturation)
	Focus area
	Focus option
	Face detection

3 Shooting option (touch)

Icon	Description
	AutoShare On
	Touch AF option
MENU	Shooting options

Selecting modes

Use the mode dial to select a shooting mode or function. Rotate the mode dial to a desired mode. You can also select an icon on the Mode screen in some modes.

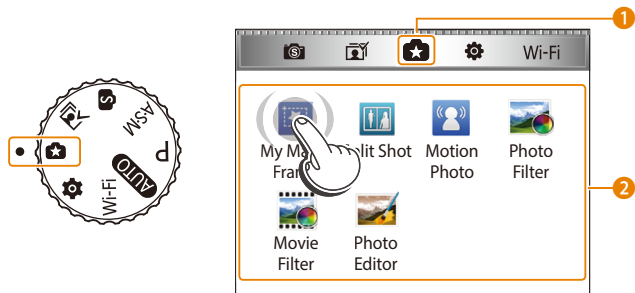















▲ For example: When you select **My Magic Frame** in Magic Plus mode

No.	Description
1	Current Mode screen <ul style="list-style-type: none">Rotate the mode dial to go to another mode screen.
2	Mode icons <ul style="list-style-type: none">Press [DISP/⏏/🔋/📶] to scroll to a desired mode, and then press [OK] to access the mode.Touch an icon to access a mode or function.

Icons on the Mode screen

Icon	Description
	Smart Auto: Capture a photo with a Scene mode selected automatically by the camera. (p. 42)
	Program: Capture a photo with settings you have adjusted manually. (p. 44)
	Aperture Priority: Set the aperture value manually while the camera automatically selects an appropriate shutter speed. (p. 46)
	Shutter Priority: Set the shutter speed manually while the camera automatically selects an appropriate aperture value. (p. 47)
	Manual: Adjust both the aperture value and the shutter speed manually. (p. 48)
	Smart: Capture a photo with options that are preset for a specific scene. (p. 49)
	Best Face: Capture multiple photos and replace faces to create the best possible image. (p. 52)

Icon	Description
	 My Magic Frame: Capture a photo and select an area to make it transparent. Overlay a newly captured photo onto the area. (p. 53)
	 Split Shot: Capture several photos and arrange them with preset layouts. (p. 55)
	 Motion Photo: Capture and combine a series of photos, and then select an area to be animated to create a GIF animation. (p. 56)
	 Photo Filter: Capture a photo with various filter effects. (p. 57)
	 Movie Filter: Record a video with various filter effects. (p. 58)
	 Photo Editor: Edit photos with various effects. (p. 96)
	Settings: Adjust settings to match your preferences. (p. 130)

Icon	Description
Wi-Fi	 MobileLink: Send photos or videos to a smart phone. (p. 115)
	 Remote Viewfinder: Use a smart phone as a remote shutter release and see a preview on your smart phone of an image from your camera. (p. 116)
	 Auto Backup: Send photos or videos that you captured with the camera to a PC wirelessly. (p. 119)
	 Email: Send photos or videos stored on the camera via email. (p. 121)
	 SNS & Cloud: Upload photos or videos to file sharing websites. (p. 124)
	 AllShare Play: Upload photos to AllShare Play online storage or view files on other AllShare Play supported devices. (p. 126)

Selecting options or menus



Press **[MENU]** to select an option or a menu. You can also touch the screen to select an option or a menu.

Selecting with buttons

Press **[MENU]**, and then press **[DISP]///** or **[OK]** to select an option or a menu.

1 In Shooting or Playback mode, press **[MENU]**.

2 Scroll to an option or a menu.

- To move up or down, press **[DISP]** or ****.
- To move left or right, press **** or ****.

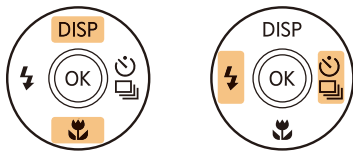

3 Press **[OK]** to confirm the highlighted option or menu.



Press **[**] to go back to the previous menu. Half-press **[Shutter]** to return to Shooting mode.

For example, to select a White Balance option in Program mode:

1 Rotate the mode dial to **P**.

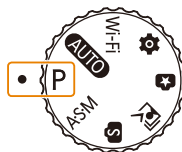

2 Press **[MENU]**.

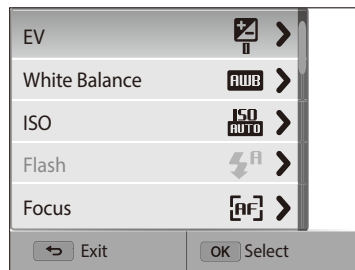

- 3 Press [DISP/☰] to select **White Balance**, and then press [☰] or [OK].

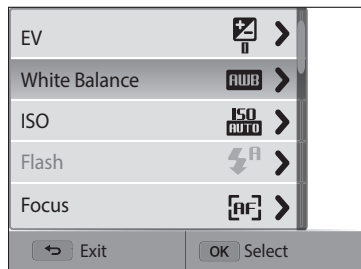

- 4 Press [⚡/☰] to select a White Balance option.

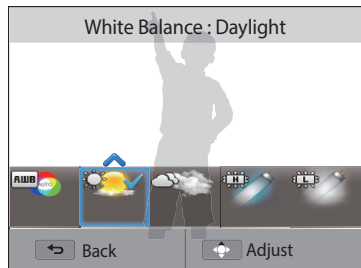

- 5 Press [OK] to save your settings.

Selecting by touch

Touch **MENU** on the screen, drag the option list up or down, and then touch an option to select it.

- 1 In Shooting or Playback mode, touch **MENU** on the screen.
- 2 Drag the option list up or down, and then touch an option.

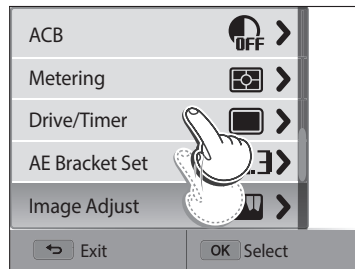

Learning touch gestures

 Do not use sharp objects, such as pens or pencils, to touch the screen. You can damage the screen.

Touching: Touch an icon to select a menu or option.

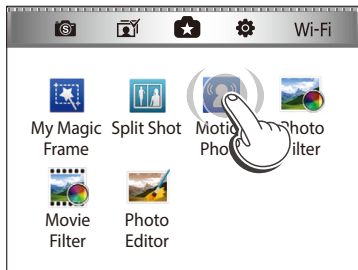

Dragging: Touch and hold an area on the screen, and then drag your finger.

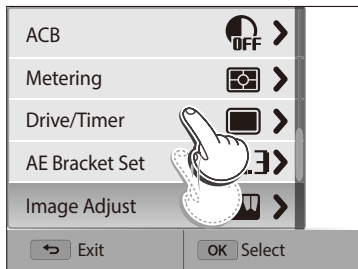

Flicking: Gently flick your finger across the screen.

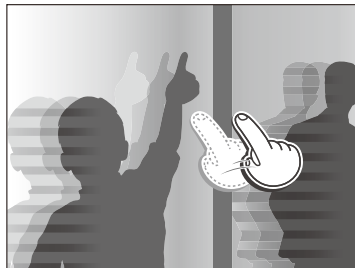

- The touch screen may not recognize your inputs if you touch multiple items at the same time.
- When you touch or drag the screen, discolorations may occur. This is not a malfunction, but a characteristic of the touch screen. Touch or drag lightly to minimize the discolorations.
- The touch screen may not work properly if you use the camera in extremely humid environments.
- The touch screen may not work properly if you apply screen protection film or other accessories to the screen.
- Depending on the viewing angle, the screen may appear dim. Adjust the brightness or viewing angle to improve the resolution.

Setting the display and sound

Learn how to change the basic display information and sound settings.

Setting the display type

You can select a display type for the Shooting or Playback mode. Each type displays different shooting or playback information. See the table below.

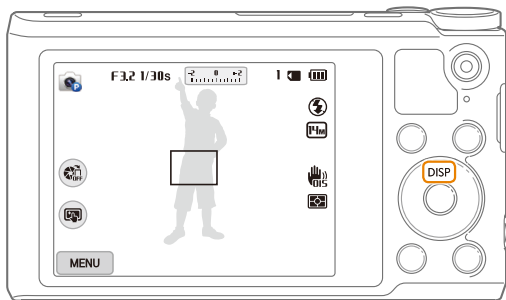

Press **[DISP]** repeatedly to change the display type.

Mode	Display type
Shooting	• Hide all information about shooting options.
	• Show all information about shooting options.
	• Show all information about shooting options and a histogram.
Playback	• Show information except shooting information and histogram.
	• Show all information about the current file.

About histograms

A histogram is a graph that illustrates how light is distributed in your photo. If the histogram has a high peak on the left, the photo is underexposed and will appear dark. A peak on the right of the graph means that the photo is overexposed and will appear washed out. The height of the peaks is related to color information. The more of a particular color, the taller the peak.



▲ Under-exposed

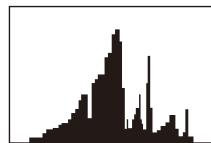

▲ Well-exposed



▲ Over-exposed

Setting the option display view

You can hide or show the option display appearing in some modes.

Press **[OK]** repeatedly.

- Hide the option display.
- Show the option display.

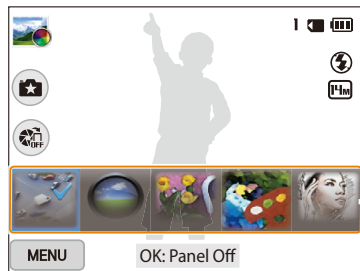

Option display

▲ For example, in Photo Filter mode

Setting the sound

Turn on or off the sound your camera emits when you perform functions.

- 1 Rotate the mode dial to .
- 2 Select **Sound** → **Beep Sound**.
- 3 Select an option.

Option	Description
Off	The camera does not emit any sounds.
On	The camera emits sounds.

Capturing photos

Learn how to capture photos easily and quickly in Smart Auto mode.

- 1 Rotate the mode dial to **AUTO**.

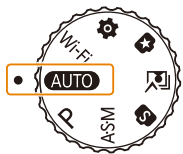

- 2 Align your subject in the frame.

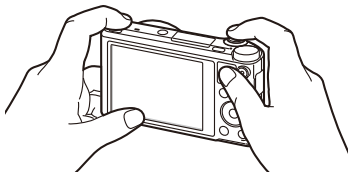

- 3 Half-press **[Shutter]** to focus.
 - A green frame means the subject is in focus.
 - A red frame means the subject is out of focus.

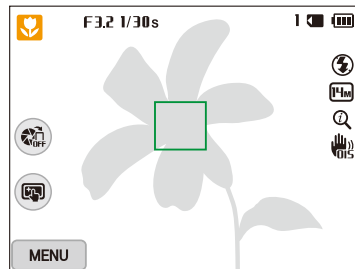

- 4 Press **[Shutter]** to capture a photo.
- 5 Press **[▶]** to view the captured photo.
 - To delete the photo, press **[⏏]**, and then select **Yes**.
- 6 Press **[▶]** to return to Shooting mode.



See page 39 for tips to get clearer photos.

Zooming

You can capture close-up photos by adjusting the zoom.

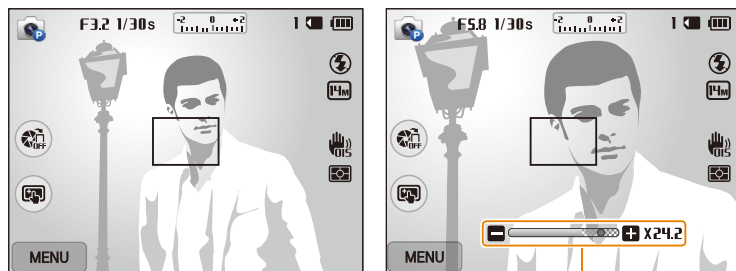

Zoom ratio

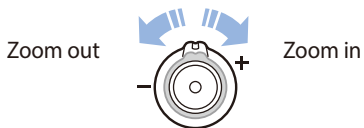

When you rotate the zoom button, the zoom ratio shown on the screen may change inconsistently.

Digital zoom P A S M

The Digital zoom is supported by default in Shooting mode. If you zoom in on a subject in Shooting mode and the zoom indicator is in the digital range, your camera is using the Digital zoom. By using both the 18X Optical zoom and 5X Digital zoom, you can zoom in up to 90 times.

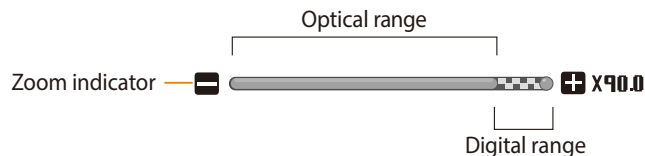

If you capture a photo with the Digital zoom, the photo quality may be lower than normal.

Intelli zoom

AUTO P A S M

If the zoom indicator is in the Intelli range, your camera is using the Intelli zoom. Photo resolution varies according to the zoom rate if you use the Intelli zoom. By using both the Optical zoom and Intelli zoom, you can zoom in up to 36 times.

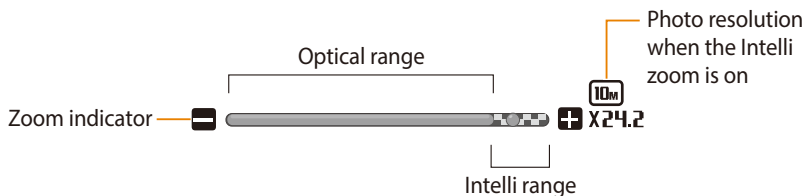

- The Intelli zoom helps you capture a photo with less quality deterioration than the Digital zoom. However, the photo quality may be lower than when you use the Optical zoom.
- The Intelli zoom is available only when you set a 4:3 resolution ratio. If you set another resolution ratio with Intelli zoom on, the Intelli zoom will be turned off automatically.
- The Intelli zoom is always on in Smart Auto mode.

Setting Intelli zoom

- 1 In Shooting mode, press [MENU].
- 2 Select **Intelli Zoom**.
- 3 Select an option.

Icon	Description
	Off: The Intelli zoom is deactivated.
	On: The Intelli zoom is activated.

Reducing camera shake (OIS) P A S M

Reduce camera shake optically in Shooting mode.

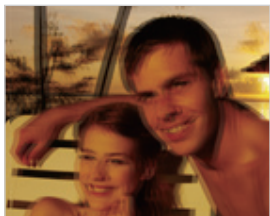

▲ Before correction

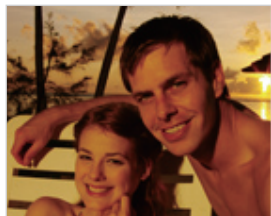

▲ After correction

- 1 In Shooting mode, press [MENU].
- 2 Select **OIS**.
- 3 Select an option.

Icon	Description
	Off: OIS is deactivated.
	On: OIS is activated.



- OIS may not function properly when:
 - you move your camera to follow a moving subject
 - you use the Digital zoom
 - there is too much camera shake
 - the shutter speed is slow (for example, when you capture night scenes)
 - the battery is low
 - you capture a close-up shot
- If you use the OIS function with a tripod, your images may be blurred by the vibration of the OIS sensor. Deactivate the OIS function when you use a tripod.
- If the camera is hit or dropped, the display will be blurry. If this occurs, turn off the camera, and then turn it on again.

Tips for getting a clearer photo

Holding your camera correctly

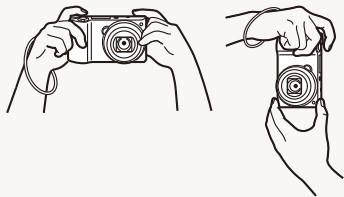

Ensure nothing is blocking the lens, flash, or microphone.

Half-pressing the shutter button

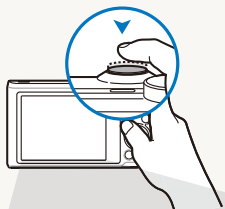

Half-press [**Shutter**] and adjust the focus. The camera adjusts the focus and exposure automatically.

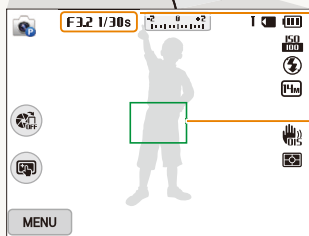

The camera sets the aperture value and shutter speed automatically.

Focus frame

- Press [**Shutter**] to capture the photo if the focus frame appears in green.
- Change the composition and half-press [**Shutter**] again if the focus frame appears in red.

Reducing camera shake



Set the Optical Image Stabilization option to reduce camera shake optically. (p. 38)

When is displayed

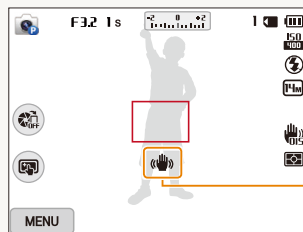

Camera shake

When you shoot in the dark, avoid setting the flash option to **Slow Sync** or **Off**. The aperture remains open longer and it may be harder to hold the camera steady long enough to capture a clear photo.

- Use a tripod or set the flash option to **Fill in**. (p. 66)
- Set ISO sensitivity options. (p. 68)



Preventing your subject from being out of focus

It may be difficult to get your subject in focus when:

- there is little contrast between the subject and background (for example, when your subject is wearing clothing that is similar in color to the background)
- the light source behind the subject is too bright
- the subject is shiny or reflective
- the subject includes horizontal patterns, such as blinds
- the subject is not positioned in the center of the frame



Using the focus lock

Half-press **[Shutter]** to focus. When the subject is in focus, you can reposition the frame to change the composition. When you are ready, press **[Shutter]** to capture your photo.

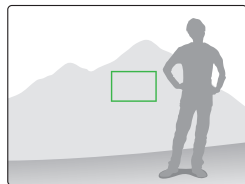
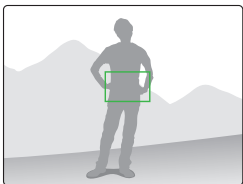

- When you capture photos in low light



Turn on the flash.
(p. 66)

- When subjects are moving rapidly

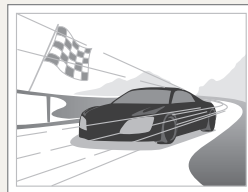

Use the Continuous shooting function.
(p. 82)

Extended functions

Learn how to capture a photo and record a video by selecting a mode.

Using the Smart Auto mode	42	Using the Magic Plus mode	53
Using the Program mode	44	Using the My Magic Frame mode	53
Using the Aperture Priority, Shutter Priority, or Manual mode	45	Using the Split Shot mode	55
Using the Aperture Priority mode	46	Using the Motion Photo mode	56
Using the Shutter Priority mode	47	Using the Photo Filter mode	57
Using the Manual mode	48	Using the Movie Filter mode	58
Using the Smart mode	49	Recording a video	59
Using the Panorama mode	50	Recording a video with the Smart Scene Detection function	60
Using the Best Face mode	52		



Using the Smart Auto mode

In Smart Auto mode, your camera automatically chooses the appropriate camera settings based on the type of scene it detects. The Smart Auto mode is helpful if you are not familiar with the camera settings for various scenes.

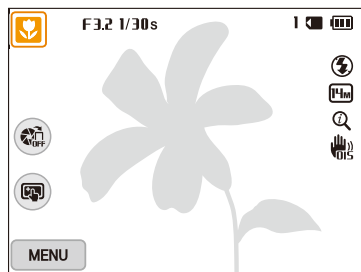
- 1 Rotate the mode dial to **AUTO**.
- 2 Align your subject in the frame.
 - The camera automatically selects a scene. An appropriate scene icon appears at the top left of the screen. The icons are listed below.



Icon	Description
	Landscapes
	Scenes with bright white backgrounds
	Landscapes at night
	Portraits at night
	Landscapes with backlighting

Icon	Description
	Portraits with backlighting
	Portraits
	Close-up photos of objects
	Close-up photos of text
	Sunsets
	Indoors, dark
	Partially lit
	Close-up with spot lighting
	Portraits with spot lighting
	Blue skies
	Forested areas
	Close-up photos of colorful subjects
	Camera is stabilized or on a tripod (when shooting in the dark)
	Actively moving subjects
	Fireworks (when using a tripod)

3 Half-press [**Shutter**] to focus.

4 Press [**Shutter**] to capture the photo.



- If the camera does not recognize an appropriate scene mode, it uses the default settings for the Smart Auto mode.
- Even if it detects a face, the camera may not select a portrait mode depending on the subject's position or lighting.
- The camera may not select the correct scene depending on the shooting conditions, such as camera shake, lighting, or distance to the subject.
- Even if you use a tripod, the camera may not detect the  mode if the subject is moving.
- The camera consumes more battery power, because it changes settings often to select appropriate scenes.

Using the Program mode

In Program mode, you can set most options, except the shutter speed and aperture value, which the camera sets automatically.

- 1 Rotate the mode dial to **P**.
- 2 Set the desired options.
 - For a list of options, refer to "Shooting options". (p. 62)

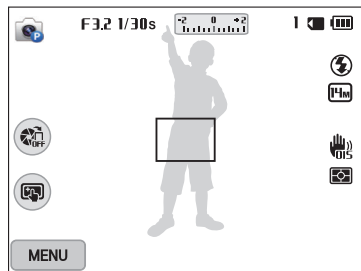

- 3 Align your subject in the frame, and then half-press [**Shutter**] to focus.
- 4 Press [**Shutter**] to capture the photo.

Using the Aperture Priority, Shutter Priority, or Manual mode

Adjust the aperture value or shutter speed to control the exposure of your photos. You can use these options in the Aperture Priority, Shutter Priority, and Manual modes.

Aperture value

The aperture is a hole that lets light into the camera. The aperture housing contains thin, metal plates that open and close, widening or narrowing the aperture, and controlling the amount of light that enters the camera. The size of the aperture is closely related to the brightness of a photo: the larger the aperture, the brighter the photo; the smaller the aperture, the darker the photo. Note that the larger the aperture value, the smaller the aperture size. For example, an aperture set to 5.6 is larger than an aperture set to 11.



▲ Small aperture value (The size of the aperture is large.)



▲ Large aperture value (The size of the aperture is small.)

Shutter speed

Shutter speed, which is an important factor in the brightness of a photo, refers to the amount of time it takes to open and close the shutter. A slow shutter speed allows more time to let light in. All things being equal, photos are brighter, but fast moving objects tend to blur. On the other hand, a fast shutter speed allows less time to let light in. Photos are darker, but objects in motion are captured more clearly.







▲ Slow shutter speed



▲ Fast shutter speed

Using the Aperture Priority mode

The Aperture Priority mode allows you to set the aperture value manually while the camera automatically selects an appropriate shutter speed.

- 1 Rotate the mode dial to **ASM**.
- 2 Select .
 - To select another mode when the mode dial is set to **ASM**, press [] or touch , and then select a mode.
- 3 Press [**OK**] → [/] to adjust the aperture value.
 - You can also touch the aperture value on the screen to view the dial.
 - You can also drag the dial on the screen to the left or right.
 - See page 45 for more information about the aperture value.

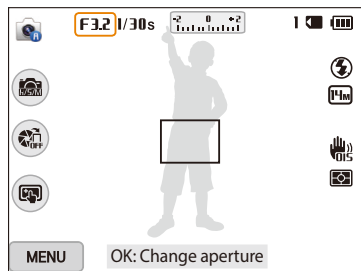





- 4 Press [**OK**] to save the setting.
- 5 Set options.
 - For a list of options, refer to "Shooting options". (p. 62)
- 6 Align your subject in the frame, and then half-press [**Shutter**] to focus.
- 7 Press [**Shutter**] to capture the photo.



When you set the ISO option to **Auto**, the shutter speed may not change automatically to match the aperture value. In this case, the camera finds an appropriate exposure value by changing the ISO option automatically when you capture a photo. To set the ISO option manually, press [**MENU**], and then select **ISO** → an option.

Using the Shutter Priority mode

The Shutter Priority mode allows you to set the shutter speed manually while the camera automatically selects an appropriate aperture value.

- 1 Rotate the mode dial to **ASM**.
- 2 Select .
 - To select another mode when the mode dial is set to **ASM**, press [] or touch , and then select a mode.
- 3 Press [**OK**] → [] to adjust the shutter speed.
 - You can also touch the shutter speed on the screen to view the dial.
 - You can also drag the dial on the screen to the left or right.
 - See page 45 for more information about the shutter speed.

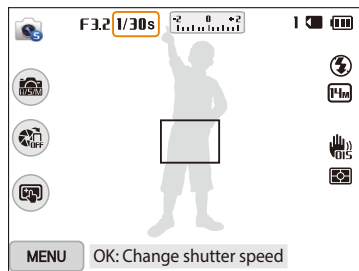





- 4 Press [**OK**] to save the setting.
- 5 Set options.
 - For a list of options, refer to "Shooting options": (p. 62)
- 6 Align your subject in the frame, and then half-press [**Shutter**] to focus.
- 7 Press [**Shutter**] to capture the photo.





When you set the ISO option to **Auto**, the aperture value may not change automatically to match the shutter speed. In this case, the camera finds an appropriate exposure value by changing the ISO option automatically when you capture a photo. To set the ISO option manually, press [**MENU**], and then select **ISO** → an option.

Using the Manual mode

The Manual mode allows you to adjust both the aperture value and the shutter speed manually.

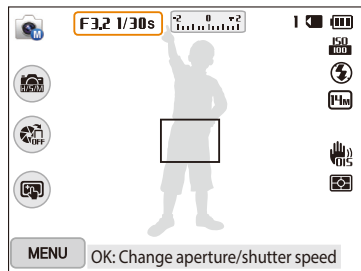
- 1 Rotate the mode dial to **ASM**.
- 2 Select .
 - To select another mode when the mode dial is set to **ASM**, press [] or touch , and then select a mode.
- 3 Press [**OK**] → [**DISP**/] to select the aperture value or shutter speed.
 - You can also touch the aperture value or shutter speed on the screen to view the dial.



- 4 Press [] to adjust the aperture value or shutter speed.
 - You can also drag the dials on the screen to the left or right.
- 5 Press [**OK**] to save the setting.
- 6 Set options.
 - For a list of options, refer to "Shooting options". (p. 62)
- 7 Align your subject in the frame, and then half-press [**Shutter**] to focus.
- 8 Press [**Shutter**] to capture the photo.

Using the Smart mode

In Smart mode, you can capture a photo with options that are preset for a specific scene.

- 1 Rotate the mode dial to **S**.
- 2 Select a scene.
 - To select another mode when the mode dial is set to **S**, press [**↵**] or touch **☺**, and then select a mode.

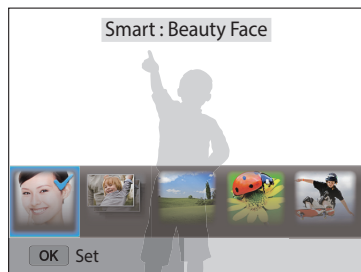

Option	Description
Beauty Face	Capture a portrait with options to hide facial imperfections.
Continuous Shot	Capture photos continuously.
Landscape	Capture still-life scenes and landscapes.
Macro	Capture small or close-up subjects.
Action Freeze	Capture subjects moving at high speed.
Rich Tones	Capture a photo with vibrant colors.

Option	Description
Panorama	Capture a wide panoramic scene in a single photo.
Waterfall	Capture scenes with waterfalls.
Silhouette	Capture subjects as dark shapes against a light background.
Sunset	Capture scenes at sunset, with natural-looking reds and yellows.
Low Light Shot	Capture multiple photos in low light conditions without a flash. The camera combines them to create a single image that is brighter and has less blurring.
Fireworks	Capture scenes with fireworks.
Light Trace	Capture scenes with the light trailing in low-light conditions.

- 3 Align your subject in the frame, and then half-press [**Shutter**] to focus.
- 4 Press [**Shutter**] to capture the photo.

Using the Panorama mode

In Panorama mode, you can capture a wide panoramic scene in a single photo. Capture and combine a series of photos to create a panoramic image.



▲ Shooting example

- 1 Rotate the mode dial to **S**.
- 2 Select **Panorama**.
- 3 Align your subject in the frame, and then half-press [**Shutter**] to focus.
 - Align the camera with the far left or the far right, or very top or bottom, of the scene you want to capture.
- 4 Press and hold [**Shutter**] to start shooting.

- 5 With [**Shutter**] pressed, slowly move the camera in the direction that will let it capture the rest of the panorama.
 - Arrows toward the direction of motion are displayed, and the entire shooting image is displayed in the preview box.
 - When the scenes are aligned, the camera captures the next photo automatically.

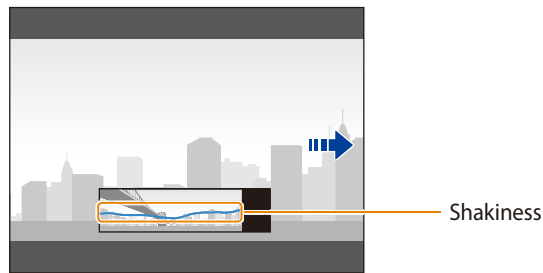

- 6 When you are finished, release [**Shutter**].
 - When you have captured all the necessary shots, the camera combines them into one panoramic photo.





- For best results when capturing panoramic photos, avoid the following:
 - moving the camera too quickly or too slowly
 - moving the camera too little to capture the next image
 - moving the camera at irregular speeds
 - shaking the camera
 - shooting in dark places
 - capturing moving subjects nearby
 - shooting conditions where the brightness or color of light is changing
- Photos taken are automatically saved, and shooting is stopped under the following conditions:
 - if you change the shooting direction while shooting
 - if you move the camera too rapidly
 - if you don't move the camera
- Selecting Panorama mode will disable the digital and optical zoom functions. If you select Panorama mode while the lens is zoomed in, the camera automatically zooms out to the default position.
- Some shooting options are not available.
- The camera may stop shooting due to the shooting composition or movement within the scene.
- Your camera may not capture the last scene in its entirety if you stop moving the camera exactly where you want the scene to end. To capture the entire scene, move your camera slightly beyond the point where you want the scene to end.

Using the Best Face mode

In Best Face mode, you can capture multiple photos and replace faces to create the best possible image. Use this mode to select the best image for each individual when capturing group photos.

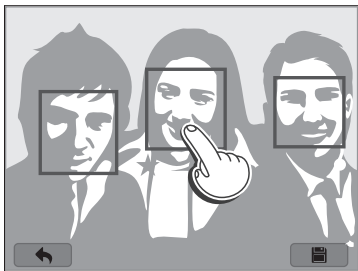
- 1 Rotate the mode dial to .
- 2 Align your subject in the frame, and then half-press [**Shutter**] to focus.
- 3 Press [**Shutter**] to capture the photo.
 - The camera captures 5 photos consecutively.
 - The first photo is set as the background image.
 - The camera automatically detects faces after shooting.
- 4 Touch a face to replace.



- 5 Touch the best image from the 5 faces that were captured.
 - Repeat steps 4 and 5 to replace the rest faces of the photo.
 - The  icon will appear on the image that the camera recommends.



- 6 Touch  to save the photo.







- Use a tripod to prevent your camera from shaking.
- The resolution is set to  or smaller.

Using the Magic Plus mode

In the Magic Plus mode, you can capture a photo with various effects.

Using the My Magic Frame mode

In My Magic Frame mode, you can make part of the photo transparent, and then capture a new photo within the transparent area.

- 1 Rotate the mode dial to .
- 2 Select 
 - To select another mode when the mode dial is set to , press [>] or touch , and then select a mode.
- 3 Half-press [**Shutter**] to focus, and then press [**Shutter**] to capture a background photo.
 - To select a background photo from your saved photos, press [**MENU**] and then select **Open Image** → an image. You cannot select a video file, GIF file, or a photo captured in Panorama mode.
- 4 Touch **Use**.
 - To recapture a background photo, touch **Retake**.

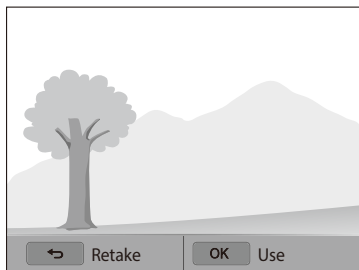

- 5 Select a frame.

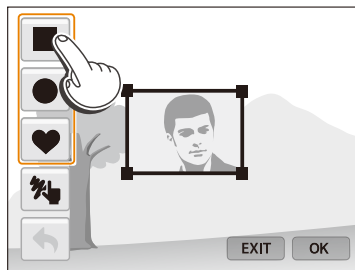

- To draw a new frame and set the thickness of the pen, touch .

- 6 Drag the corner of the box to adjust the size.

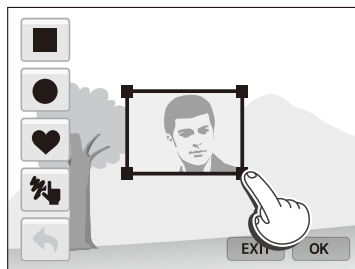

7 Drag the selected frame to place it to a desired location.

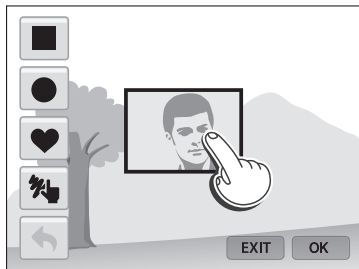

8 Press [OK].

9 Adjust the transparency by moving the sliders or touching the +/- icons to adjust.

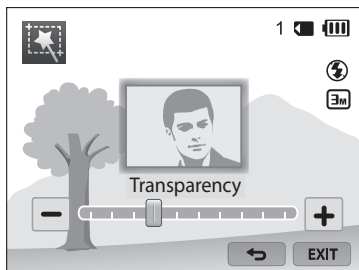

10 Align your subject in the frame, and then half-press [Shutter] to focus.

- To recapture a background photo, touch EXIT.

11 Press [Shutter] to capture a photo.

- Press [↶] to return to the previous screen.







12 Touch  to save the photo.





- Some shooting options are not available.
- The focus is set to the transparent area in the frame.
- The resolution is fixed at .

Using the Split Shot mode

In Split Shot mode, you can capture several photos and arrange them with preset layouts.

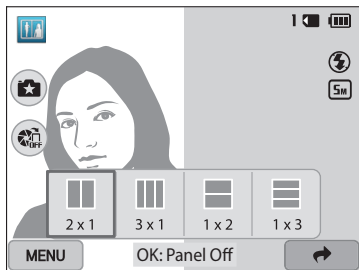
- 1 Rotate the mode dial to .
- 2 Select .
 - To select another mode when the mode dial is set to , press [] or touch , and then select a mode.
- 3 Select a split style.
 - To adjust the sharpness of the dividing line, press [**MENU**], and then select **Line Blur** → a value.
 - To apply a Smart Filter effect to part of the shot, press [**MENU**], and then select **Smart Filter** → an option. You can apply different Smart Filter effects to each part of the shot.
 - To adjust the size of the frame, drag the dividing line. Touch  or the split style again to discard your changes.







- 4 Align your subject in the frame, and then half-press [**Shutter**] to focus.
- 5 Press [**Shutter**] to capture a photo.
 - Repeat steps 4 and 5 to capture the rest of the photos.
 - To recapture a photo, press [].



- The resolution is set to  or smaller.
- The available zoom range may be less than in other shooting modes.



Using the Motion Photo mode

In Motion Photo mode, you can capture and combine a series of photos, and then select an area to be animated to create a GIF animation.

- 1 Rotate the mode dial to .
- 2 Select .
 - To select another mode when the mode dial is set to , press [] or touch , and then select a mode.
- 3 Align your subject in the frame, and then half-press [**Shutter**] to focus.
- 4 Press [**Shutter**] to capture the photo.
 - The camera captures multiple photos while the status lamp is blinking.

- 5 On the screen, draw an area to be animated.



- You can select multiple areas.
- To adjust the thickness of the brush, touch .
- To adjust the motion speed, touch +/- icon.
- To recapture a photo, touch EXIT.
- To draw the animated area again, touch .

- 6 Touch  to save the photo.



- The resolution is set to **VGA**.
- Use a tripod to prevent your camera from shaking.
- It may take longer to save files.

Using the Photo Filter mode

Apply various filter effects to your photos to create unique images.



Miniature



Vignetting





Fish-eye



Sketch

1 Rotate the mode dial to .

2 Select .

- To select another mode when the mode dial is set to , press [] or touch , and then select a mode.

3 Select an effect.

Option	Description
Miniature	Apply a tilt-shift effect to make the subject appear in miniature.
Vignetting	Apply the retro-looking colors, high contrast, and strong vignette effect of Lomo cameras.
Ink Painting	Apply a watercolor painting effect.
Oil Painting	Apply an oil painting effect.
Cartoon	Apply a cartoon painting effect.
Cross Filter	Add lines that radiate outward from bright objects to imitate the visual effect of a cross filter.
Sketch	Apply a pen sketch effect.
Soft Focus	Hide facial imperfections or apply dreamy effects.
Fish-eye	Blacken the edges of the frame and distort objects to imitate the visual effect of a fisheye lens.
Classic	Apply a black and white effect.
Retro	Apply a sepia tone effect.
Zooming Shot	Blur the edges of a photo to emphasize the subjects in the center.

4 Align your subject in the frame, and then half-press [**Shutter**] to focus.

5 Press [**Shutter**] to capture a photo.



- Depending on the option you select, the resolution may change to **5m** or smaller automatically.
- To apply filter effects to saved photos, press [**MENU**] and then select **Open Image** → an image.

Using the Movie Filter mode

Apply various filter effects to your videos to create unique images.

1 Rotate the mode dial to .

2 Select .

- To select another mode when the mode dial is set to , press [**↵**] or touch , and then select a mode.

3 Select an effect.

Option	Description
Miniature	Apply a tilt-shift effect to make the subject appear in miniature.
Vignetting	Apply the retro-looking colors, high contrast, and strong vignette effect of Lomo cameras.

Option	Description
Sketch	Apply a pen sketch effect.
Fish-eye	Distort close objects to imitate the visual effect of a fisheye lens.
Classic	Apply a black and white effect.
Retro	Apply a sepia tone effect.
Palette Effect 1	Create a vivid look with sharp contrast and strong color.
Palette Effect 2	Make scenes clean and clear.
Palette Effect 3	Apply a soft brown tone.
Palette Effect 4	Create a cold and monotone effect.

4 Press (Video recording) to start recording.

5 Press (Video recording) again to stop recording.



- If you select **Miniature**, playback speed will increase.
- If you select **Miniature**, you cannot record sound in the video.
- Depending on the option you select, the recording resolution may change to **VGA** or smaller automatically.

Recording a video

Record Full HD videos (1920 X 1080) of up to 20 minutes. The camera saves recorded videos as MP4 (H.264) files.



- H.264 (MPEG-4 part10/AVC) is a high-compression video format established by the international standards organizations ISO-IEC and ITU-T.
- If you use memory cards with slow write speeds, the camera may not save videos properly. Video recordings may be corrupted or fail to play back correctly.
- Memory cards with slow writing speeds will not support high-resolution videos. To record high-resolution videos, use memory cards with faster write speeds.
- If you activate the Image Stabilization function while recording a video, the camera may record the operating sound of the Image Stabilization function.
- If you use the zoom function when recording a video, the camera may record the noise of the zoom operating. To decrease zoom noise, use the Sound Alive function. (p. 85)

- 1 Rotate the mode dial to **P**, **A-S-M**, **S**, **[i]**, **[*]** or **AUTO**.
 - This feature may not be supported in some modes.
- 2 Set desired options.
 - For a list of options, refer to "Shooting options". (p. 62)
- 3 Press **[F2]** (Video recording) to start recording.
- 4 Press **[F2]** (Video recording) again to stop recording.

Pause recording

The camera allows you to temporarily pause a video while recording. With this function, you can record separate scenes as a single video.

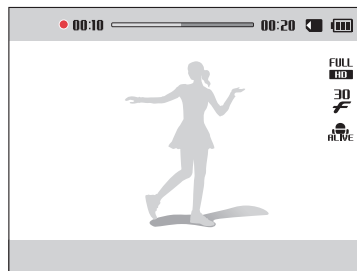

- Press **[OK]** to pause while recording.
- Press **[OK]** to resume.

Capturing still images while recording a video

You can capture still images while recording a video without switching to the photo shooting modes (up to 6 photos).

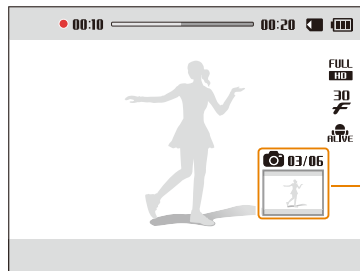

Images captured while recording a video

- Press [**Shutter**] to capture images while recording a video.
- Captured images will be saved automatically.







- Captured images will be automatically resized, depending on the size of the recorded video.
- You cannot capture still images when you pause the video recording.
- The quality of images captured while recording a video may be lower than those captured normally.
- This feature may not be supported in some modes.

Recording a video with the Smart Scene Detection function

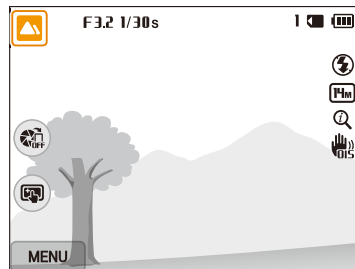
In Smart Auto mode, your camera automatically chooses the appropriate camera settings based on the scene it has detected.

- 1 Rotate the mode dial to **AUTO**.
- 2 Set the desired options.
 - For a list of options, refer to "Shooting options". (p. 62)
- 3 Align your subject in the frame.
 - The camera automatically selects a scene. An appropriate scene icon will appear at the top left of the screen.



Icon	Description
	Landscapes
	Sunsets
	Blue skies
	Forested areas

4 Press  (Video recording) to start recording.

5 Press  (Video recording) again to stop recording.



- If the camera does not recognize an appropriate scene mode, it uses the default settings for the Smart Scene Detection mode.
- The camera may not select the correct scene depending on the shooting conditions, such as camera shake, lighting, and distance to the subject.

Shooting options

Learn how to set the options in Shooting mode.

Selecting a resolution and quality	63	Capturing a smile shot	75
Selecting a resolution	63	Detecting eye blinking	75
Selecting a photo quality	64	Tips for detecting faces	76
Shooting in the dark	65	Adjusting brightness and color	77
Preventing red-eye	65	Adjusting the exposure manually (EV)	77
Using the flash	65	Compensating for backlighting (ACB)	78
Setting a flash option	66	Changing the metering option	78
Adjusting the ISO sensitivity	68	Selecting a White Balance setting	79
Changing the camera's focus	69	Using burst modes	82
Using macro	69	Capturing continuous photos	82
Using auto focus	69	Using the timer	83
Adjusting the focus area	71	Capturing bracketed photos	83
Adjusting the focus by touch	71	Adjusting images	84
Using Face Detection	74	Reducing the sound of the zoom	85
Detecting faces	74		
Capturing a self portrait shot	74		

Selecting a resolution and quality









Learn how to change the image resolution and quality settings.

Selecting a resolution AUTO P A S M S

As you increase the resolution, your photo or video will include more pixels, so it can be printed on larger paper or displayed on a larger screen. When you use a high resolution, the file size will also increase.





Setting the photo resolution

- 1 In Shooting mode, press **[MENU]**.
- 2 Select **Photo Size**.
- 3 Select an option.

Icon	Description
	4320 X 3240: Print on A1 paper.
	4320 X 2880: Print on A1 paper in wide ratio (3:2).
	4320 X 2432: Print on A2 paper in panorama ratio (16:9) or play back on an HDTV.
	3648 X 2736: Print on A2 paper.
	2832 X 2832: Print on A3 paper in 1:1 ratio.
	2592 X 1944: Print on A4 paper.
	1984 X 1488: Print on A5 paper.
	1920 X 1080: Print on A5 paper in panorama ratio (16:9) or play back on an HDTV.
	1024 X 768: Attach to an email.

Setting the video resolution



- 1 In Shooting mode, press **[MENU]**.
- 2 Select **Movie Size**.
- 3 Select an option.

Icon	Description
	1920 X 1080: High-quality HD files to play back on an HDTV.
	1280 X 720: HD files to play back on an HDTV.
	640 X 480: SD files to play back on an analog TV.
	320 X 240: Post on a web page.
	For Sharing: Post on a website using the wireless network (30 seconds maximum).

Selecting a photo quality P A S M

Set a photo quality setting. Higher image quality settings will result in larger file sizes. The camera compresses and saves the photos you capture in the JPEG format.

- 1 In Shooting mode, press **[MENU]**.
- 2 Select **Quality**.
- 3 Select an option.

Icon	Description
	Super Fine: Capture photos in super high quality.
	Fine: Capture photos in high quality.
	Normal: Capture photos in normal quality.

Shooting in the dark

Learn how to capture photos at night or in low light conditions.

Preventing red-eye P S

When the flash fires when you capture a photo of a person in the dark, a red glow may appear in the person's eyes. To prevent this, select **Red-eye** or **Red-eye Fix**. Refer to flash options in "Setting a flash option."



▲ Before correction



▲ After correction

Using the flash

Press the flash pop-up button to pop the flash up. When the flash unit pops up, the flash fires in accordance with the option you have selected. If you select **Off**, the flash does not fire even when it is popped up.

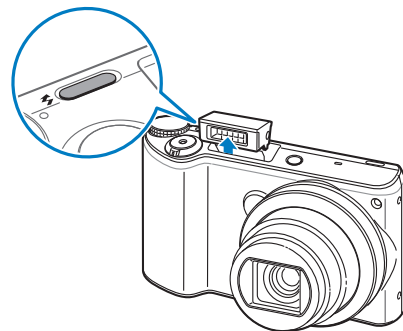

- While not in use, keep the flash unit closed to prevent damage.
- Forcing to open the flash unit may cause damage to your camera. Press down gently to close it.

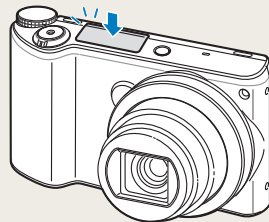

Setting a flash option AUTO P A S M S ★

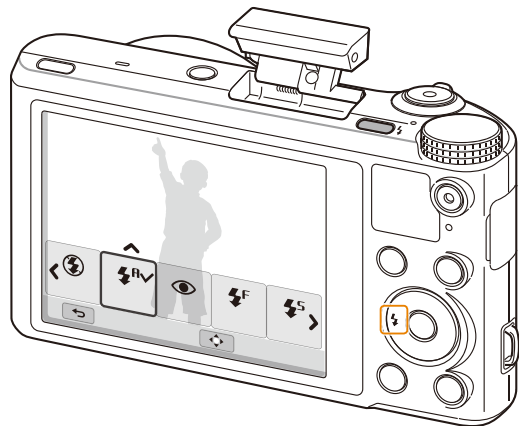

Use the flash when you capture photos in the dark or when you need more light in your photos.

- 1 Press the flash pop-up button to open the flash.
- 2 In Shooting mode, press [⚡].



3 Select an option.

Icon	Description
	Off: <ul style="list-style-type: none"> The flash will not fire. The camera will display the shake warning (⏏) when you are shooting in low light.
	Auto: The camera will select a proper flash setting for the scene it detects in Smart Auto mode.
	Auto: The flash will fire automatically when the subject or background is dark.
	Red-eye: <ul style="list-style-type: none"> The flash will fire twice when the subject or background is dark to reduce the red-eye effect. There is an interval between the 2 bursts of the flash. Do not move until the flash fires a second time.
	Fill in: <ul style="list-style-type: none"> The flash always fires. The camera automatically adjusts light intensity.

Icon	Description
	<p>Slow Sync:</p> <ul style="list-style-type: none"> The flash fires and the shutter stays open longer. This option is recommended when you want to capture more ambient light to reveal more details in the background. Use a tripod to prevent your photos from blurring. The camera will display the shake warning  when you are shooting in low light.
	<p>Red-eye Fix:</p> <ul style="list-style-type: none"> The flash fires twice when the subject or background is dark. The camera corrects red-eyes through its advanced software analysis. There is an interval between the 2 bursts of the flash. Do not move until the flash fires a second time.



Available options may differ depending on the shooting conditions.



- Flash options are not available if you set Burst options or select **Blink Detection, Self-Portrait**.
- Make sure that your subjects are within the recommended distance from the flash. (p. 152)
- If light from the flash is reflected or there is a substantial amount of dust in the air, tiny spots may appear in your photo.
- In some modes, you can also set the flash option by pressing [MENU], and then selecting **Flash**.

Adjusting the flash intensity

Adjust the flash intensity to avoid over-exposed or under-exposed photos.

- In Shooting mode, press [].
- Scroll to an option.
- Press [DISP].
- Press [] to adjust the intensity.
 - You can also drag the slider or touch +/- to adjust the intensity.

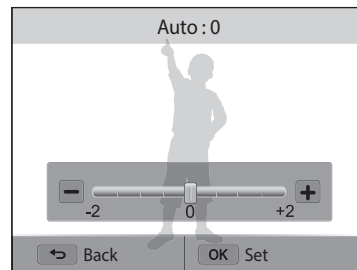

- Press [OK] to save your settings.



- Adjusting the flash intensity may not be effective if:
 - the subject is too close to the camera
 - you set a high ISO sensitivity
 - the exposure value is too big or too small
- In some shooting modes, you cannot use this function.

Adjusting the ISO sensitivity P A S M

The ISO sensitivity is the measure of a film's sensitivity to light as defined by the International Organization for Standardization (ISO). The higher ISO sensitivity you select, the more sensitive to light your camera becomes. Use a higher ISO sensitivity to capture better photos and reduce camera shake when not using the flash.

- 1 In Shooting mode, press [MENU].
- 2 Select **ISO**.
- 3 Select an option.
 - Select  to use an appropriate ISO sensitivity based on the brightness of the subject and lighting.



Higher ISO sensitivities may result in more image noise.

Changing the camera's focus

Learn how to adjust the camera's focus to suit the subject and the shooting conditions.

Using macro P A S M

Use macro to capture close-up photos of subjects, such as flowers or insects.



- Try to hold the camera firmly to prevent blurry photos.
- Turn off the flash if the distance to the subject is less than 15.7 in. (40 cm).



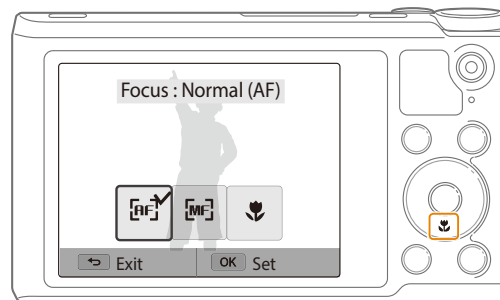

Using auto focus P A S M

To capture sharp photos, select the appropriate focus option according to your distance from the subject.

1 In Shooting mode, press [].





2 Select an option.

Icon	Description
	Normal (AF): Focus on a subject farther than 31 in. (80 cm) away. Farther than 138 in. (350 cm) away when you use the zoom.
	Manual Focus: Focus on a subject by adjusting the focus distance manually. (p. 70)
	Macro: Focus on a subject that is 2-31 in. (5-80 cm) from the camera. 71-138 in. (180-350 cm) when you use the zoom.
	Auto Macro: <ul style="list-style-type: none"> Focus on a subject farther than 2 in. (5 cm) away. Farther than 71 in. (180 cm) away when you use the zoom. Auto Macro is set automatically in some shooting modes.

Available options may differ depending on the shooting conditions.

 In some modes, you can also set the focus option by pressing [MENU], and then selecting **Focus**.

Adjusting the focus distance manually P A S M

- 1 In Shooting mode, press [].
- 2 Select **Manual Focus**.
- 3 Press [] to adjust the focus distance.
 - You can also drag the slider or touch +/- to adjust the focus distance.

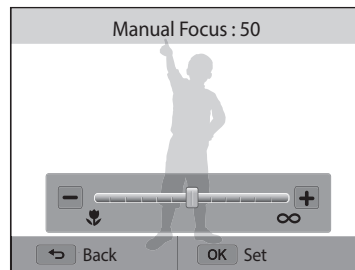



- 4 Press [OK] to save your settings.

 When you adjust the focus distance manually and the subject is out of focus, the photo may be blurry.

Adjusting the focus area P A S M

You can get clearer photos by selecting an appropriate focus area according to your subject's location in the scene.

- 1 In Shooting mode, press [MENU].
- 2 Select **Focus Area**.
- 3 Select an option.





Icon	Description
	Center AF: Focus on the center of the frame (suitable when subjects are located at or near the center).
	Multi AF: Focus on one or more of 9 possible areas.

Available shooting options may differ depending on the shooting mode.

Adjusting the focus by touch (AUTO) P A S M S

Focus on the subject or capture a photo by touching on the screen.

- 1 In Shooting mode, press [MENU].
- 2 Select **Touch AF**.
- 3 Select an option.

Icon	Description
	Off: Do not use the touch AF function.
	Touch AF: Focus on the subject that you touch on the screen.
	Tracking AF: Focus on and track the subject that you touch on the screen. (p. 72)
	One touch shot: Focus on the subject and capture a photo by touching the image on the screen. (p. 73)

Available shooting options may differ depending on the shooting conditions.



The focus will reset when you perform no operations for 5 seconds or press [Shutter] while the touch AF function is on.

Using tracking auto focus

Tracking AF allows you to track and automatically focus on your subject, even when you are moving.

- 1 In Shooting mode, press **[MENU]**.
- 2 Select **Touch AF** → **Tracking AF**.
- 3 Touch the subject you want to track in the touch area.
 - A focus frame appears on the subject and follows the subject as you move the camera.

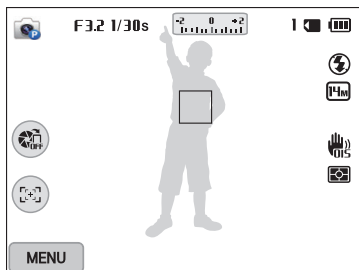

- The white frame means that your camera is tracking the subject.
- When you half-press **[Shutter]**, the green frame means that your subject is in focus.
- The red frame means that your camera failed to focus.

- 4 Press **[Shutter]** to capture the photo.



- If you do not select a focus area, the focus frame will appear in the center of the screen.
- Tracking a subject may fail when:
 - the subject is too small
 - the subject moves excessively
 - the subject is backlit or you are shooting in a dark place
 - colors or patterns on the subject and the background are the same
 - the subject includes horizontal patterns, such as blinds
 - the camera shakes excessively
- When tracking fails, the feature will be reset.
- If the camera fails to track the subject, you must reselect the subject to track.
- If the camera fails to focus, the focus frame will change to red and the focus will be reset.

Using One Touch Shot

You can capture a photo with the touch of your finger. As you touch on a subject, the camera focuses on the subject automatically and captures a photo.

- 1 In Shooting mode, press [MENU].
- 2 Select **Touch AF** → **One touch shot**.
- 3 Touch the subject to capture a photo.

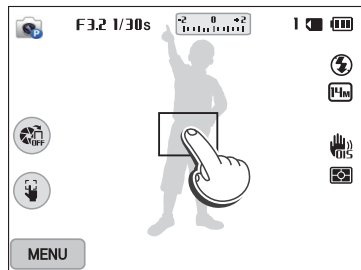

If you use this function, you cannot set Timer, Intelli zoom, and Burst options.

Using Face Detection P A S M

If you use Face Detection options, your camera can automatically detect a human face. When you focus on a human face, the camera adjusts the exposure automatically. Use **Blink Detection** to detect closed eyes or **Smile Shot** to capture a smiling face.

Detecting faces

Your camera automatically detects up to 10 human faces in one scene.

- 1 In Shooting mode, press **[MENU]**.
- 2 Select **Face Detection** → **Normal**.

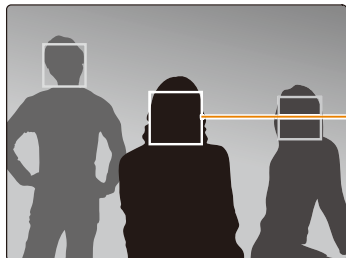

The face nearest the camera or nearest the center of the scene appears in a white focus frame and the rest of the faces appear in gray focus frames.



The closer you are to the subjects, the quicker your camera will detect faces.

Capturing a self portrait shot

Capture photos of yourself. The camera sets the focus distance to close-up, and then emits a beep when ready.

- 1 In Shooting mode, press **[MENU]**.
- 2 Select **Face Detection** → **Self-Portrait**.
- 3 Compose your shot with the lens facing you.
- 4 When you hear a quick beep, press **[Shutter]**.

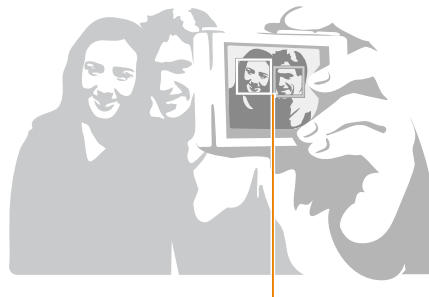

When faces are located in the center, the camera beeps rapidly.



If you turn **Volume** off in the sound settings, the camera will not emit a beep. (p. 132)

Capturing a smile shot

The camera automatically releases the shutter when it detects a smiling face.

- 1 In Shooting mode, press [MENU].
- 2 Select **Face Detection** → **Smile Shot**.
- 3 Compose your shot.
 - The camera automatically releases the shutter when it detects a smiling face.

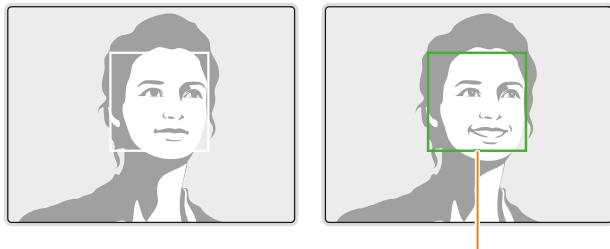

When your subject smiles broadly, your camera can detect the smile more easily.

Detecting eye blinking

If your camera detects closed eyes, it will automatically capture 3 photos in succession.

- 1 In Shooting mode, press [MENU].
- 2 Select **Face Detection** → **Blink Detection**.



Tips for detecting faces

- When your camera detects a face, it tracks the detected face automatically.
- Face Detection may not be effective when:
 - the subject is far from the camera (The focus frame will appear orange for Smile Shot and Blink Detection.)
 - it is too bright or too dark
 - the subject is not facing the camera
 - the subject is wearing sunglasses or a mask
 - the subject's facial expression changes drastically
 - the subject is backlit or the lighting conditions are unstable
- When you set Face Detection options, the AF area is automatically set to Multi AF.
- Depending on the Face Detection options you selected, some Shooting options may not be available.

Adjusting brightness and color

Learn how to adjust the brightness and color for better image quality.

Adjusting the exposure manually (EV) P A S

Depending on the intensity of the ambient light, your photos may be too bright or dark. In these cases, you can adjust the exposure to get a better photo.



▲ Darker (-)



▲ Neutral (0)



▲ Brighter (+)

1 In Shooting mode, press [MENU].

2 Select **EV**.

- You can also touch the exposure value on the screen to open the adjustment window.

3 Press [**EV**] to adjust the exposure.

- You can also drag the slider or touch +/- to adjust the exposure.
- The photo will be brighter as the exposure value increases.

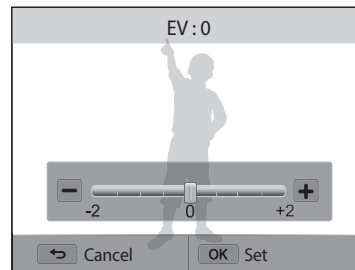

4 Press [**OK**] to save your settings.



- Once you adjust the exposure, the setting will be stored automatically. You may need to change the exposure value later to avoid overexposure or underexposure.
- If you cannot decide on an appropriate exposure, select the **AE Bracket** (Auto Exposure Bracket) option. The camera will capture 3 consecutive photos, each with a different exposure: normal, underexposed, and overexposed. (p. 83)

Compensating for backlighting (ACB) P A S M

When the light source is behind your subject or there is high contrast between your subject and the background, your subject is likely to appear dark in the photo. In this case, set the Auto Contrast Balance (ACB) option.

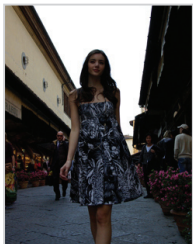

▲ Without ACB



▲ With ACB

- 1 In Shooting mode, press [MENU].
- 2 Select **ACB**.
- 3 Select an option.

Icon	Description
	Off: ACB (Auto Contrast Balance) is deactivated.
	On: ACB (Auto Contrast Balance) is activated.



The ACB feature is always on in Smart Auto mode.

Changing the metering option P A S M

The metering mode refers to the way in which a camera measures the quantity of light. The brightness and lighting of your photos will vary depending on the metering mode you select.

- 1 In Shooting mode, press [MENU].
- 2 Select **Metering**.
- 3 Select an option.

Icon	Description
	<p>Multi:</p> <ul style="list-style-type: none"> • Your camera divides the frame into several areas, and then measures the light intensity of each area. • Suitable for general photos.
	<p>Spot:</p> <ul style="list-style-type: none"> • Your camera measures only the light intensity at the very center of the frame. • If a subject is not in the center of the frame, your photo may be improperly exposed. • Suitable for a subject with backlighting.
	<p>Center-weighted:</p> <ul style="list-style-type: none"> • Your camera averages the meter reading of the entire frame with emphasis placed on the center. • Suitable for photos with subjects in the center of the frame.

Selecting a White Balance setting P A S M

The color of your photo depends on the type and quality of the light source. If you want the color of your photo to be realistic, select a White Balance setting that is appropriate for the lighting conditions, such as Auto WB, Daylight, Cloudy, or Tungsten.



 Auto WB



 Daylight











 Cloudy



 Tungsten

- 1 In Shooting mode, press [MENU].
- 2 Select **White Balance**.
- 3 Select an option.

Icon	Description
	Auto WB: Automatically set the White Balance based on the lighting conditions.
	Daylight: For outdoor photos on a sunny day.
	Cloudy: For outdoor photos on a cloudy day or in shadows.
	Fluorescent_H: For shooting under a daylight fluorescent or 3-way fluorescent light.
	Fluorescent_L: For shooting under white fluorescent light.
	Tungsten: For shooting indoor photos under incandescent bulbs or halogen lamps.
	Color Temp.: To adjust the color temperature of the light source. (p. 80)
	Custom Set: To use White Balance settings that you define. (p. 81)

Customizing preset White Balance options

You can customize preset White Balance options except **Auto WB** and **Custom Set**.

- 1 In Shooting mode, press [MENU].
- 2 Select **White Balance**.
- 3 Scroll to a desired option.
- 4 Press [DISP].
- 5 Press [DISP/🌿/⚡/👤] to adjust the value on the coordinates.
 - You can also touch an area on the screen.

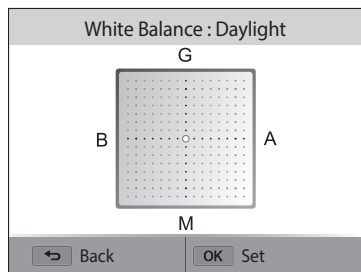

- **G**: Green
- **A**: Amber
- **M**: Magenta
- **B**: Blue

- 6 Press [OK] to save your settings.

Adjusting color temperature

- 1 In Shooting mode, press [MENU].
- 2 Select **White Balance** → **Color Temp.**
- 3 Press [DISP].
- 4 Press [⚡/👤] to adjust the color temperature to match your light source.
 - You can also drag the slider or touch +/- to adjust the color temperature.
 - You can capture a warmer photo with a higher color temperature setting (more yellow/red), and a cooler photo with a lower color temperature setting (more blue).

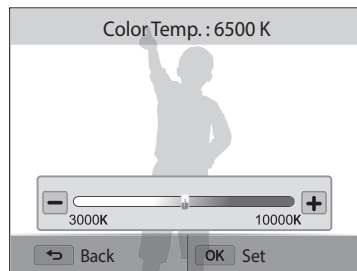

- 5 Press [OK] to save your settings.

Defining your own White Balance

You can customize the White Balance by capturing a photo of a white surface, such as a piece of paper, under the lighting conditions in which you intend to capture a photo. The White Balance feature will help you to match the colors in your photo with the actual scene.

- 1 In Shooting mode, press **[MENU]**.
- 2 Select **White Balance** → **Custom Set**.
- 3 Aim the lens at a piece of white paper, and then press **[Shutter]**.

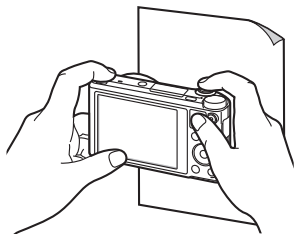





Using burst modes P A S M

It can be difficult to capture photos of fast-moving subjects or capture natural facial expressions and gestures of your subjects in photos. Also, it can be difficult to adjust the exposure correctly and select a proper light source. In these cases, select one of the burst modes. You can also set the timer to delay shooting.



Capturing continuous photos

- 1 In Shooting mode, press .
- 2 Select an option.



Icon	Description
	Continuous (8 fps): Capture 8 photos per second continuously. (You can capture up to 6 photos in one burst.)
	Continuous (3 fps): Capture 3 photos per second continuously. (You can capture up to 6 photos in one burst.)
	Single: Capture a single photo. (Single is not a burst option.)

- 3 Align your subject in the frame, and then half-press [**Shutter**] to focus.
 - 4 Press and hold [**Shutter**].
 - While you are pressing [**Shutter**], the camera captures photos continuously.
- 
 - Available options may differ depending on the shooting conditions.
 - Depending on the Face Detection options you selected, some shooting options may not be available.
 - It may take longer to save the photos depending on the memory card capacity and performance.
 - In some modes, you can also set the shooting option by pressing [**MENU**], and then selecting **Drive/Timer**.

Using the timer

1 In Shooting mode, press .

2 Select an option.

Icon	Option
	2 Sec: Capture a photo after a 2-second delay.
	10 Sec: Capture a photo after a 10-second delay.



- Press [**Shutter**] to cancel the timer.
- In some modes, you can also set the shooting option by pressing [**MENU**], and then selecting **Drive/Timer** or **Timer**.

Capturing bracketed photos

You can use the automatic exposure bracketing feature to capture multiple photos of the same subject with different exposure values.

1 In Shooting mode, press .

2 Select **AE Bracket**.



- When you press [**Shutter**], the camera captures 3 consecutive photos, each with a different exposure: normal, underexposed, and overexposed.
- Press [**MENU**], and then select **AE Bracket Set** to select exposure values.
- It may take longer to capture the photo. Use a tripod for best results.

Adjusting images P A S M

Adjust the sharpness, contrast, or saturation of your photos.

- 1 In Shooting mode, press [MENU].
- 2 Select **Image Adjust**.
- 3 Select an option.
 - Sharpness
 - Contrast
 - Saturation

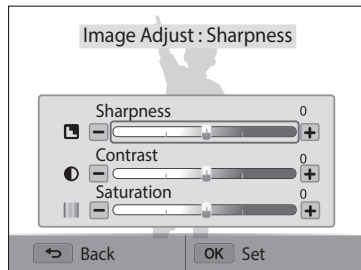

- 4 Press [/] to adjust each value.
 - You can also drag the sliders or touch +/- to adjust the values.

Sharpness	Description
-	Soften the edges on your photos (suitable for editing the photos on your computer).
+	Sharpen the edges to improve the clarity of your photos. (This may also increase the noise in your photos.)

Contrast	Description
-	Decrease the color and brightness.
+	Increase the color and brightness.

Saturation	Description
-	Decrease the saturation.
+	Increase the saturation.

- 5 Press [OK] to save your settings.





Select 0 if you do not want to apply any effects (suitable for printing).

Reducing the sound of the zoom

AUTO P A S M S [i] [star]

When you use the zoom while recording videos, the camera can record the sound of the zoom. Use the Sound Alive function to reduce the zoom noise.

- 1 In Shooting mode, press [MENU].
- 2 Select **Voice**.
- 3 Select an option.

Icon	Description
	Sound Alive On: Turn on the Sound Alive function to reduce the zoom noise.
	Sound Alive Off: Turn off the Sound Alive function. The camera can record the zoom noise.
	Mute: Do not record sounds.



- Do not block the microphone when you use the Sound Alive function.
- Recordings made with Sound Alive may differ from actual sounds.

Playback/Editing

Learn how to play back photos or videos, and edit photos. Also, learn how to connect your camera to your computer or TV.

Viewing photos or videos in Playback mode ...	87	Viewing files on a TV	100
Starting Playback mode	87	Transferring files to the computer	101
Viewing photos	92	Transferring files to your Windows OS	
Playing a video	94	computer	101
Editing a photo	96	Transferring files to your Mac OS computer	102
Resizing photos	96	Using programs on the computer	104
Rotating a photo	96	Installing i-Launcher	104
Cropping a photo	97	Using i-Launcher	105
Applying Smart Filter effects	97		
Adjusting your photos	98		

Viewing photos or videos in Playback mode

Learn how to play back photos or videos and how to manage files.

Starting Playback mode

View photos or play videos stored in your camera.

- 1 Press [▶].
 - The most recent file will be displayed.
 - If the camera is off, it will turn on and display the most recent file.
- 2 Press [⚡/📷] to scroll through files.
 - You can also drag the image left or right to move to another file.
 - Press and hold [⚡/📷] to scroll through files quickly.



- If you want to view files stored in the internal memory, remove your memory card.
- You may not be able to edit or play back files that were captured with other cameras, due to unsupported sizes (image size, etc) or codecs. Use a computer or another device to edit or play back these files.
- Photos or videos captured in portrait orientation do not rotate automatically and are displayed in landscape orientation by the camera and other devices.

Photo file information

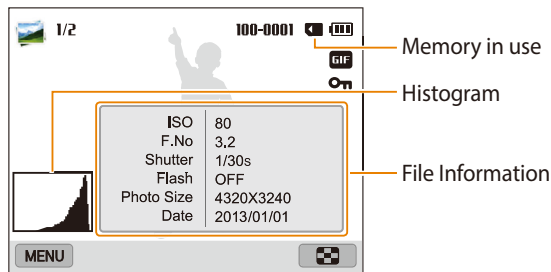

Icon	Description
1/2	Current file/Total files
100-0001	Folder name-File name
GIF	GIF file
H5	Photo captured continuously (See "Viewing files as a folder", p. 88)
On	Protected file
📷	View files as thumbnails (p. 90)



To display file information on the screen, press [DISP].

Video file information

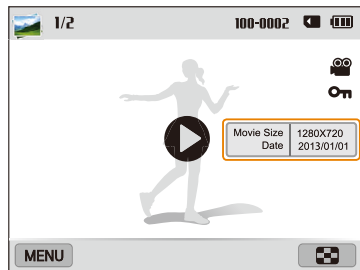

File Information

Icon	Description
1/2	Current file/Total files
100-0002	Folder name-File name
	Video file
	Protected file
	Play videos



To display file information on the screen, press [DISP].

Viewing files as a folder

Photos captured continuously appear as a folder.

- In Playback mode, press [/] or drag the image left or right to move to a desired folder.
 - The camera will automatically play back photos in the folder.

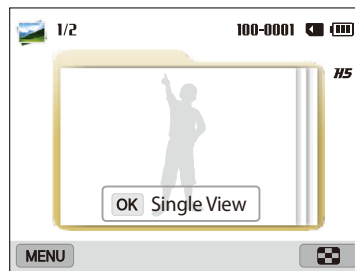

- Press [OK] or rotate [Zoom] to the right to open the folder.
 - You can also touch **OK Single View** on the screen to open the folder.
- Press [/] or drag the image left or right to move to another file.
- Press [OK] or rotate [Zoom] to the left to return to Playback mode.

Viewing files by category in Smart Album

View files by category, such as date or file type.

- 1 In Playback mode, rotate **[Zoom]** to the left.
- 2 Press **[MENU]**, and then select **Filter** → a category.
 - You can also touch **FILTER** to select a category.

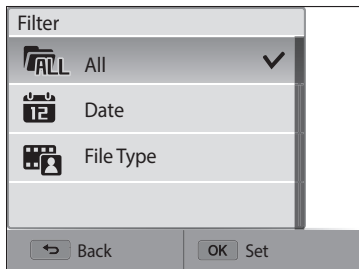

Icon	Description
	All: View files normally.
	Date: View files by the date they were saved.
	File Type: View files by the file type.

- 3 Select a list to open it.
- 4 Select a file to view it.
- 5 Rotate **[Zoom]** to the left to return to the previous view.



It may take some time for the camera to open Smart Album, change the category, or reorganize files.

Viewing files as thumbnails

Scan thumbnails of files.



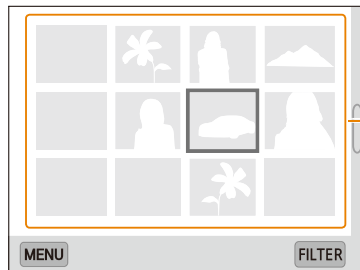

In Playback mode, rotate [**Zoom**] to the left to view thumbnails (12 at a time). Rotate [**Zoom**] to the left once more to display more thumbnails (24 at a time). Rotate [**Zoom**] to the right to return to the previous view.



Touch a file to display it in full screen view.



Press [**DISP** /  /  / ] or drag the screen up or down to move to the previous or next page of thumbnails.

Protecting a file

Protect a file from accidental deletion.

- 1 In Playback mode, select a file to protect.
- 2 Press [**MENU**], and then select **Protect** → **On**.
- 3 Repeat steps 1 and 2 to protect additional files.



You cannot delete or rotate a protected file.

Deleting files

Select files to delete in Playback mode.

Deleting a single file

You can select one file, and then delete it.

- 1 In Playback mode, select a file, and then press [].
- 2 When the pop-up message appears, select **Yes**.



You can also delete files in Playback mode by pressing [**MENU**], and then selecting **Delete** → **Delete** → **Yes**.

Deleting multiple files

You can select multiple files, and then delete them at once.

- 1 In Playback mode, press [MENU].
 - When in thumbnails view, press [MENU], select **Delete** → **Select**, and then skip to step 3, or press [⏏], select **Select**, and then skip to step 3.
- 2 Select **Delete** → **Multiple Delete**.
- 3 Scroll to each file you want to delete, and then press [OK].
 - Press [OK] again to cancel your selection.
 - You can also select files by touching them.
- 4 Press [⏏].
- 5 When the pop-up message appears, select **Yes**.

Deleting all files

You can select all files, and then delete them at once.

- 1 In Playback mode, press [MENU].
 - When in thumbnails view, press [MENU], select **Delete** → **Delete All**, and then skip to step 3, or press [⏏], select **Delete All**, and then skip to step 3.
- 2 Select **Delete** → **Delete All**.
- 3 When the pop-up message appears, select **Yes**.
 - All unprotected files are deleted.

Copying files to a memory card

Copy files from the internal memory to a memory card.

- 1 In Playback mode, press [MENU].
- 2 Select **Copy to Card**.

Viewing photos

Enlarge part of a photo or view photos as a slide show.

Enlarging a photo

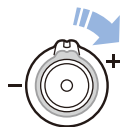

In Playback mode, rotate [**Zoom**] to the right to enlarge a portion of the photo. Rotate [**Zoom**] to the left to zoom out.

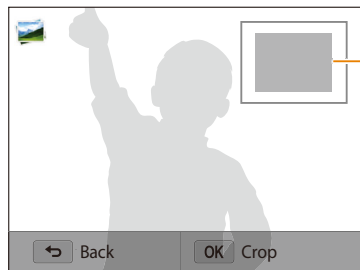

Enlarged area





To	Description
Move the enlarged area	<ul style="list-style-type: none"> Press [DISP / / /]. Drag the screen to see another part of the photo.
Trim the enlarged photo	Press [OK], and then select Yes . (The trimmed photo will be saved as a new file. The original photo is retained in its original form.)



When you view photos that were captured by another camera, the zoom ratio may differ.

Viewing panoramic photos

View photos captured in Panorama mode.



- 1 In Playback mode, scroll to a panoramic photo.
 - The entire panoramic photo appears on the screen.
- 2 Press [OK] or touch .
 - The camera automatically scrolls through the photo from left to right for a horizontal panoramic photo and from top to bottom for a vertical panoramic photo. The camera then switches to Playback mode.
 - While playing back a panoramic photo, press [OK] to pause or resume.
 - After you have paused the playback of a panoramic photo, press [DISP///] or drag the image to move the photo horizontally or vertically, depending on the direction you moved when capturing the photo.
- 3 Press [] to return to Playback mode.



You can play the panoramic photo by pressing [OK] or touching  only if the longest side of the photo is two or more times longer than the shortest side.

Viewing animated photos

View animated GIF files repeatedly that were captured in Motion Photo mode.

- 1 In Playback mode, scroll to a GIF file.
- 2 Press [OK] or touch .
- 3 Press [] to return to Playback mode.

Playing a slide show

Apply effects and audio to a slide show of your photos. The slide show function does not work for videos and GIF files.

- 1 In Playback mode, press [MENU].
- 2 Select **Slide Show Options**.
- 3 Select a slide show effect option.
 - Skip to step 4 to start a slide show with no effects.

* Default

Option	Description
Play Mode	Set whether or not to repeat the slide show. (One Play* , Repeat)
Interval	<ul style="list-style-type: none"> • Set the interval between photos. (1 sec*, 3 sec, 5 sec, 10 sec) • You must set the Effect option to Off to set the interval.

* Default

Option	Description
Music	Set background audio.
Effect	<ul style="list-style-type: none"> Set a scene change effect between photos. (Off, Calm*, Shine, Relax, Lively, Sweet) Select Off to cancel effects. When you use the Effect option, the interval between photos will be set to 1 second.

4 Press [**↶**].5 Select **Start Slide Show**.

6 View the slide show.

- Press [**OK**] to pause the slide show.
- Press [**OK**] again to resume the slide show.



- Press [**↶**] to stop the slide show and return to Playback mode.
- Rotate [**Zoom**] to the left or right or touch  at the bottom of the screen to adjust the volume level.

Playing a video

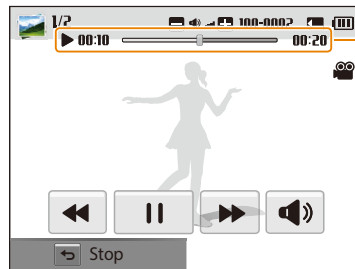

In Playback mode, you can view a video, and then capture or trim parts of the playing video. You can save the captured or trimmed segments as new files.

- In Playback mode, select a video, and then press [**OK**] or touch .
- View the video.







Current playback time/
Video length



Icon	Description
	Scan backward. Each time you touch the scan backward icon, you change the scan speed in this order: 2X, 4X, 8X.
	Pause or resume playback.

Icon	Description
	Scan forward. Each time you touch the scan forward icon, you change the scan speed in this order: 2X, 4X, 8X.
	Adjust the volume or mute the sound.

 When playing a movie, you can begin using features such as scanning backward, scanning forward, or pausing after the video has run for 2 seconds.



Trimming a video

- 1 In Playback mode, select a video, and then press [MENU].
- 2 Select **Trim Movie**.
- 3 Press [OK] or touch  to start playing the video.
- 4 Press [OK] or touch  at the point where you want the trimming to begin.
- 5 Press  or touch **Start Point**.
- 6 Press [OK] or touch  to resume playing the video.
- 7 Press [OK] or touch  at the point where you want the trimming to end.

- 8 Press  or touch **End Point**.
- 9 Press  or touch **Trim** to trim a video.
 - You can adjust the scene to be cropped by dragging the handles that appear on the progress bar.
- 10 When the pop-up message appears, select **Yes**.

-  • The original video should be at least 10 seconds long.
• The camera will save the edited video as a new file and leave the original video intact.

Capturing an image from video

- 1 While viewing a video, press [OK] or touch  at the point where you want to capture an image.
- 2 Press  or touch **Capture**.

-  • The resolution of the captured image will be the same as the original video.
• The captured image is saved as a new file.

Editing a photo

Learn how to edit photos.



- The camera will save edited photos as new files.
- When you edit photos, the camera will automatically convert them to a lower resolution. Photos that you rotate or resize manually are not automatically converted to a lower resolution.
- You cannot edit photos while viewing files as a folder. Open the folder and select a photo to edit each photo.
- Photos captured in some modes cannot be edited.

Resizing photos

Change the size of a photo and save it as a new file.

- 1 Rotate the mode dial to , and then select .
 - You can also press [MENU], and then select **Edit Image**.
- 2 Rotate [Zoom] to the left or touch OPEN to select a photo.
- 3 Touch , and then touch an option.



- 4 Touch to save.



Available resize options differ depending on the original size of the photo.

Rotating a photo

- 1 Rotate the mode dial to , and then select .
 - You can also press [MENU], and then select **Edit Image**.
- 2 Rotate [Zoom] to the left or touch OPEN to select a photo.
- 3 Touch , and then touch an option.

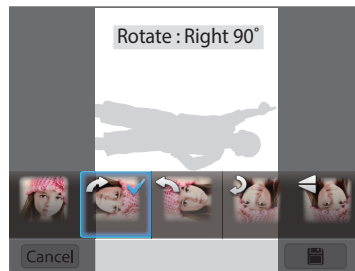





- 4 Touch to save.





The camera will overwrite the original file.

Cropping a photo

- 1 Rotate the mode dial to , and then select .
 - You can also press [MENU], and then select **Edit Image**.
- 2 Rotate [Zoom] to the left or touch OPEN to select a photo.
- 3 Touch , and then select an area to drag and crop.
- 4 Adjust the size of the area by dragging the corners of the box.
- 5 Touch  to save.

Applying Smart Filter effects

Apply special effects to your photos.

- 1 Rotate the mode dial to , and then select .
 - You can also press [MENU], and then select **Edit Image**.
- 2 Rotate [Zoom] to the left or touch OPEN to select a photo.
- 3 Touch , and then touch an option.
- 4 Touch **OK**.

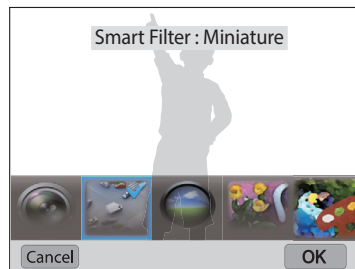

Option	Description
Off	No effect
Miniature	Apply a tilt-shift effect to make the subject appear in miniature. (The top and bottom of the photo will be blurred.)

Option	Description
Vignetting	Apply the retro-looking colors, high contrast, and strong vignette effect of Lomo cameras.
Ink Painting	Apply a watercolor painting effect.
Oil Painting	Apply an oil painting effect.
Cartoon	Apply a cartoon painting effect.
Cross Filter	Add lines that radiate outward from bright objects to imitate the visual effect of a cross filter.
Sketch	Apply a pen sketch effect.
Soft Focus	Hide facial imperfections or apply dreamy effects.
Fish-eye	Distort close objects to imitate the visual effect of a fisheye lens.
Classic	Apply a black and white effect.
Retro	Apply a sepia tone effect.
Zooming Shot	Blur the edges of a photo to emphasize the subjects in the center.

5 Touch  to save.



Adjusting your photos

Learn how to adjust the brightness, contrast, or saturation or how to correct the red-eye effect. If the center of a photo is dark, you can adjust it to be brighter. The camera will save an edited photo as a new file, but may convert it to a lower resolution.







- You can adjust brightness, contrast, and saturation and apply Smart Filter effects at the same time.
- You cannot apply the ACB, Face Retouch, and Red-eye Fix effects at the same time.
- If you have applied the ACB effect, you cannot adjust brightness, contrast, or saturation. If you have adjusted brightness, contrast, or saturation, you cannot apply the ACB effect.



Adjusting dark subjects, brightness, contrast, or saturation

- 1 Rotate the mode dial to , and then select .
 - You can also press [MENU], and then select **Edit Image**.
- 2 Rotate [**Zoom**] to the left or touch **OPEN** to select a photo.

3 Touch , and then select an adjusting option.

Icon	Description
	ACB (Adjust dark subjects)
	Brightness
	Contrast
	Saturation

- If you selected , skip to step 6.



4 Press [/] to adjust the option.

- You can also drag the slider or touch +/- to adjust the option.

5 Touch **OK**.

6 Touch  to save.

Retouching faces

1 Rotate the mode dial to , and then select .

- You can also press [MENU], and then select **Edit Image**.

2 Rotate [**Zoom**] to the left or touch OPEN to select a photo.

3 Touch , and then touch **Face Retouch**.

4 Press [**OK**].



5 Press [/] to adjust the option.

- You can also drag the slider or touch +/- to adjust the option.
- As the number increases, the skin tone becomes brighter and smoother.

6 Press [**OK**].

7 Touch  to save.

Removing red-eye

1 Rotate the mode dial to , and then select .

- You can also press [MENU], and then select **Edit Image**.

2 Rotate [**Zoom**] to the left or touch OPEN to select a photo.

3 Touch , and then touch **Red-eye Fix**.

4 Touch  to save.

Viewing files on a TV

Play back photos or videos by connecting your camera to a TV with the A/V cable.

- 1 Rotate the mode dial to .
- 2 Select **Connectivity** → **Video Out**.
- 3 Select the video signal output for your country or region. (p. 133)
- 4 Turn off your camera and TV.
- 5 Connect your camera to your TV with the A/V cable.

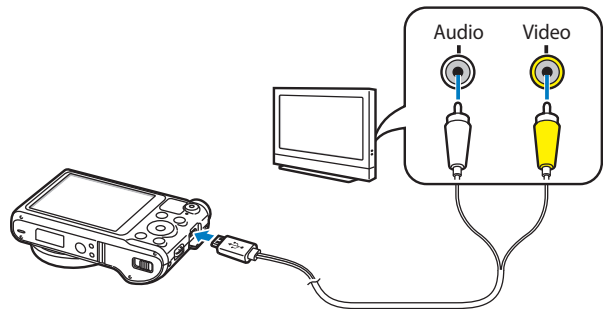

- 6 Turn on your TV, and then select the A/V video source with the TV remote control.
- 7 Turn on your camera.
 - The camera automatically enters into Playback mode when you connect it to a TV.
- 8 View photos or play videos using the camera buttons.



- Depending on the TV model, you may see some digital noise or part of an image may not appear.
- Images may not be centered on the TV screen depending on your TV settings.

Transferring files to the computer

Connect the camera to a computer to transfer files from the camera's memory card to the computer.

Transferring files to your Windows OS computer

Connect the camera to your computer as a removable disk.



Your computer must be running Windows XP, Windows Vista, Windows 7, or Windows 8 for you to connect the camera as a removable disk.

- 1 Rotate the mode dial to .
- 2 Select **Connectivity** → **i-Launcher** → **Off**.
- 3 Turn off the camera.
- 4 Connect the camera to your computer with the USB cable.



You must plug the small end of the USB cable into your camera. If the cable is reversed, it may damage your files. The manufacturer is not responsible for any loss of data.

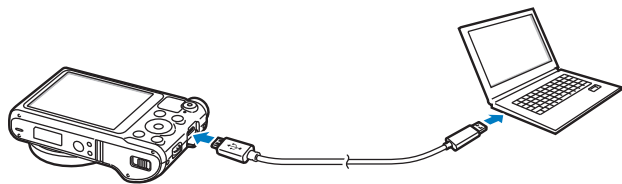

- 5 Turn on the camera.
 - The computer recognizes the camera automatically.
- 6 On your computer, select **My Computer** → **Removable Disk** → **DCIM** → **100PHOTO**.
- 7 Drag or save files to your computer.

Disconnecting the camera (for Windows XP)

With Windows Vista, Windows 7 and Windows 8, the methods for disconnecting the camera are similar.

- 1 If the status lamp on your camera is blinking, wait until it stops.
- 2 Click  on the tool bar at the bottom right of your computer screen.



- 3 Click the pop-up message.
- 4 Click the message box that indicates the camera can be removed safely.
- 5 Remove the USB cable.

Transferring files to your Mac OS computer

When you connect the camera to your Mac OS computer, the computer will automatically recognize the device. You can transfer files directly from the camera to the computer without installing any programs.



Mac OS 10.5 or later is supported.

- 1 Turn off the camera.
- 2 Connect your camera to your Mac OS computer with the USB cable.



You must plug the small end of the USB cable into your camera. If the cable is reversed, it may damage your files. The manufacturer is not responsible for any loss of data.

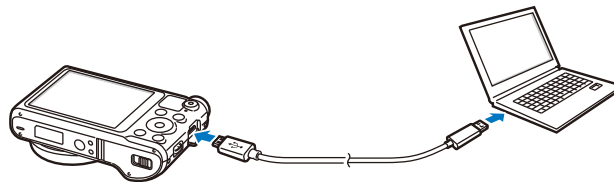

- 3 Turn on the camera.
 - The computer recognizes the camera automatically and displays a removable disk icon.
- 4 Open the removable disk.
- 5 Drag or save files to your computer.

Using programs on a computer

i-Launcher allows you to play back files with Multimedia Viewer and provides links so that you can download useful programs.

Installing i-Launcher

- 1 Rotate the mode dial to .
- 2 Select **Connectivity** → **i-Launcher** → **On**.
- 3 Turn off the camera.
- 4 Connect the camera to your computer with the USB cable.



You must plug the small end of the USB cable into your camera. If the cable is reversed, it may damage your files. The manufacturer is not responsible for any loss of data.

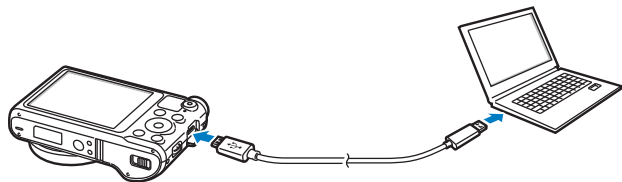

- 5 Turn on the camera.
- 6 When the pop-up window prompts you to install i-Launcher, select **Yes**.
 - If a pop-up window prompting you to run iLinker.exe appears, run it first.
 - When you connect the camera to a computer with i-Launcher installed, the program will launch automatically.
- 7 Follow the on-screen instructions to complete the installation.
 - An i-Launcher shortcut will appear on the computer.



- Before installing the program, ensure that the PC is connected to a network.
- To install i-Launcher on your Mac OS computer, click **Devices** → **i-Launcher** → **Mac** → **iLinker**.

Available programs when using i-Launcher

Option	Description
Multimedia Viewer	You can view files with Multimedia Viewer.
Firmware Upgrade	You can update the firmware of your camera.
PC Auto Backup	i-Launcher provides a link for downloading the PC Auto Backup program when you connect the camera to a computer. You can send photos or videos that you captured with the camera to a PC wirelessly.



If you use a Mac OS computer, only Firmware Upgrade and PC Auto Backup are available.

Using i-Launcher

i-Launcher allows you to play back files with Multimedia Viewer and provides a link to download the PC Auto Backup program.



- The requirements are recommendation only. i-Launcher may not work properly even when the computer meets the requirements, depending on the condition of your computer.
- If your computer does not meet the requirements, videos may not play correctly.



The manufacturer is not responsible for any damage that results from using unqualified computers such as a computer you assembled yourself.

Windows OS Requirements

Item	Requirements
CPU	Intel® Core™ 2 Duo 1.66 GHz or higher/ AMD Athlon X2 Dual-Core 2.2 GHz or higher
RAM	Minimum 512 MB RAM (1 GB or more recommended)
OS*	Windows XP SP2, Windows Vista, Windows 7, or Windows 8
Hard disk capacity	250 MB or more (1 GB and above recommended)
Others	<ul style="list-style-type: none"> • 1024 X 768 pixels, 16-bit color display compatible monitor (1280 X 1024 pixels, 32-bit color display recommended) • USB 2.0 port • nVIDIA Geforce 7600GT or higher/ ATI X1600 series or higher • Microsoft DirectX 9.0c or higher

* A 32-bit version of i-Launcher will be installed—even on 64-bit editions of Windows XP, Windows Vista, Windows 7, and Windows 8.

Mac OS requirements

Item	Requirements
OS	Mac OS 10.5 or higher
RAM	Minimum 256 MB RAM (512 MB or more recommended)
Hard disk capacity	Minimum 110 MB
Others	USB 2.0 port

Opening i-Launcher

On your computer, select **Start** → **All Programs** → **Samsung** → **i-Launcher** → **Samsung i-Launcher**. On your Mac, click **Applications** → **Samsung** → **i-Launcher**.

Using Multimedia Viewer

Multimedia Viewer allows you to play back files. From the Samsung i-Launcher screen, click **Multimedia Viewer**.



- Multimedia Viewer supports the following formats:
 - Videos: MP4 (Video: H.264, Audio: AAC), WMV (WMV 7/8/9), AVI (MJPEG)
 - Photos: JPG, GIF, BMP, PNG, TIFF, MPO
- Files that have been recorded with other manufacturers' devices may not play back smoothly.

Viewing photos



No.	Description
1	File name
2	Enlarged area
3	Histogram
4	Open the selected file.
5	Histogram button
6	Rotate to the left/Rotate to the right.
7	Move to the previous file/Move to the next file.
8	Fit the photo to the screen.
9	View the photo in its original size.
10	Zoom in/Zoom out
11	Switches between 2D and 3D mode.

Viewing videos



No.	Description
1	File name
2	Adjust the volume.
3	Open the selected file.
4	Move to the next file.
5	Stop
6	Pause
7	Move to the previous file.
8	Progress bar

Updating the firmware

From the Samsung i-Launcher screen, click **Firmware Upgrade**.

Downloading the PC Auto Backup program

From the Samsung i-Launcher screen, click **PC Auto Backup**. For information about installing the PC Auto Backup program, refer to page 119.

Wireless network





Learn how to connect to wireless local area networks (WLANs) and use functions.

Connecting to a WLAN and configuring network settings	111
Connecting to a WLAN	111
Using the login browser	112
Network connection tips	113
Entering text	114
Sending photos or videos to a smart phone ...	115
Using a smart phone as a remote shutter release	116
Saving files to a smart phone automatically ...	118
Using Auto Backup to send photos or videos ...	119
Installing the program for Auto Backup on your PC	119
Sending photos or videos to a PC	119
Sending photos or videos via email	121
Changing email settings	121
Sending photos or videos via email	123
Using photo or video sharing websites	124
Accessing a website	124
Uploading photos or videos	124
Using AllShare Play to send files	126
Uploading photos to online storage	126
Viewing photos or videos on devices that support AllShare Play	127
Sending photos using Wi-Fi Direct	129

Connecting to a WLAN and configuring network settings





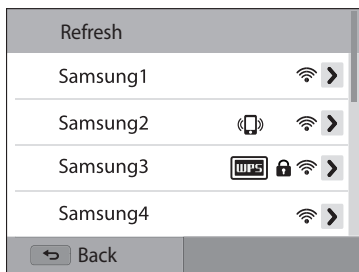

Learn to connect via an access point (AP) when you are in a range of a WLAN. You can also configure network settings.



Connecting to a WLAN

- 1 Rotate the mode dial to **Wi-Fi**.
- 2 Select , , , or .
- 3 Press [**MENU**], and then select **Wi-Fi Setting**.
 - In some modes, follow the on-screen instructions until the Wi-Fi Setting screen appears.
 - The camera automatically searches for available AP devices.
- 4 Select an AP.





- Select **Refresh** to refresh connectable APs.
- Select **Add wireless network** to add an AP manually.

Icon	Description
	Ad hoc AP
	Secured AP
	WPS AP
	Signal strength
	Press [] or touch to open AP setting options



- When you select a secured AP, a pop-up window appears. Enter the required passwords to connect to the WLAN. For information about entering text, refer to "Entering text". (p. 114)
- When a login page appears, refer to "Using the login browser". (p. 112)
- When you select an unsecured AP, the camera will connect to the WLAN.
- If you select a WPS profile supported AP, select  → **WPS PIN connection**, and then enter a PIN on the AP device. You can also connect to a WPS profile supported AP by selecting  → **WPS button connection** on the camera, and then pushing the **WPS** button on the AP device.

Setting network options

- 1 In the Wi-Fi Setting screen, move to an AP, and then press  or touch .
- 2 Select each option, and then enter the required information.

Option	Description
Network Password	Enter the network password.
IP Setting	Set the IP address automatically or manually.







Manually setting the IP address

- 1 In the Wi-Fi Setting screen, move to an AP, and then press  or touch .
- 2 Select **IP Setting** → **Manual**.
- 3 Select each option, and then enter the required information.



Option	Description
IP	Enter the static IP address.
Subnet Mask	Enter the subnet mask.
Gateway	Enter the gateway.
DNS Server	Enter the DNS address.

Using the login browser

You can enter your login information via the login browser when connecting to some APs, sharing sites, or cloud servers.

Button/Icon	Description
	Move to an item or scroll the page.
[OK]	Select an item.
	Close the login browser.
	Move to the previous page.
	Move to the next page.
	Stop loading the page.
	Reload the page.



- You may not be able to select some items depending on the page you connected to. This does not indicate a malfunction.
- The login browser may not close automatically after you log into some pages. If this occurs, close the login browser by pressing  or touching , and then proceed with the desired operation.
- It may take longer to load the login page due to the page size or network speed. If this occurs, wait until the login information input window appears.

Network connection tips

- The quality of the network connection will be determined by the AP.
 - The further the distance between your camera and the AP, the longer it will take to connect to the network.
 - If a nearby device is using the same radio frequency signal as your camera, it may interrupt your connection.
 - If your AP name is not in English, the camera may not be able to locate the device or the name may appear incorrectly.
 - For network settings or a password, contact your network administrator or network service provider.
 - If a WLAN requires authentication from the service provider, you may not be able to connect to it. To connect the WLAN, contact your network service provider.
 - Depending on the encryption type, the number of digits in the password may differ.
 - A WLAN connection may not be possible in all surroundings.
 - The camera may display a WLAN enabled printer on the AP List. You cannot connect to a network via a printer.
 - You cannot connect your camera to a network and a TV simultaneously.
 - Connecting to a network may incur additional charges. Costs will vary based on the conditions of your contract.
 - If you cannot connect to a WLAN, try another AP from the available AP list.
- A login page may appear when you select free WLANs provided by some network service providers. Enter your ID and password to connect to the WLAN. For information about registering or the service, contact the network service providers.
 - Be cautious when you enter personal information for an AP connection. Do not enter any payment or credit card information on your camera. The manufacturer is not liable for any problem caused by entering such information.
 - Available network connections may differ by country.
 - The WLAN feature of your camera must comply with radio transmission laws in your region. To ensure compliance, use the WLAN feature only in the country where you purchased the camera.
 - The process for adjusting network settings may differ, depending on network conditions.
 - Do not access a network that you are not authorized to use.
 - Before you connect to a network, ensure your battery is fully charged.
 - You cannot upload or send files captured in some modes.
 - Files that you transfer to another device may not be supported by the device. In this case, use a computer to playback the files.

Entering text

Learn how to enter text. The icons in the table below let you move the cursor, change the case, etc. Press [DISP/👉/👈/👆] to move to a desired key, and then press [OK] to enter the key. You can also touch a key to enter it.



Icon	Description
←	Delete the last letter.
◀ ▶	Move the cursor.
↑	In ABC mode, change the case.
Cancel	Stop entering text and return to the previous page.

Icon	Description
¹²³ !@# /ABC	Switch between Symbol mode and ABC mode.
␣	Enter a space.
Done	Save the displayed text.



- You can use only the English alphabets in some modes, regardless of the display language.
- To move to **Done** directly, press [▶].
- You can enter up to 64 characters.
- The screen may differ depending on the input mode.

Sending photos or videos to a smart phone

The camera connects to a smart phone that supports the MobileLink feature via a WLAN. You can easily send photos or videos to your smart phone.



- The MobileLink feature is supported by Galaxy series smart phones or Galaxy Tab models with the Android 2.2 OS or higher or iOS devices with the iOS 4.3 or higher. Before using this feature, check the device's firmware and update it if needed.
- You should install the Samsung Smart Camera application on your phone or device before using this feature. You can download the application from Samsung Apps, the Google Play Store, or the Apple App Store. The Samsung Smart Camera app is compatible with Samsung camera models manufactured in 2013 or later.
- When there are no files in the camera memory, you cannot use this feature.
- If you select files from the smart phone, you can view up to 1,000 recent files and send up to 150 files at a time. If you select files from the camera, you can view files that were selected from the camera. The maximum number of files that can be sent varies depending on the storage space of the smart phone.
- When you send Full HD videos using MobileLink feature, you may not be able to play back files on some devices.

- 1 On the camera, rotate the mode dial to **Wi-Fi**.
- 2 On the camera, select .
 - If the pop-up message that prompts you to download the application appears, select **Next**.
- 3 On the camera, select a sending option.
 - If you select **Select Files from Smartphone**, you can use your smart phone to view and share files stored on the camera.
 - If you select **Select Files from Camera**, you can select files to send from the camera.
- 4 On the smart phone, turn on the Samsung Smart Camera application.
 - For iOS devices, turn on the Wi-Fi feature before turning on the application.
- 5 Select the camera from the list and connect the smart phone to the camera.
 - The smart phone can connect to only one camera at a time.
- 6 On the camera, allow the smart phone to connect to your camera.
 - If the smart phone has been connected to your camera before, it is connected automatically.
- 7 On the smart phone or camera, select files to transfer from the camera.
- 8 On the smart phone, touch the copy button or on the camera, select **Share**.
 - The camera will send the files.

Using a smart phone as a remote shutter release





The camera connects to a smart phone that supports the Remote Viewfinder feature via a WLAN. Use the smart phone as a remote shutter release with the Remote Viewfinder feature. The captured photo will display on the smart phone.





- The Remote Viewfinder feature is supported by Galaxy series smart phones or Galaxy Tab models with the Android 2.2 OS or higher or iOS devices with the iOS 4.3 or higher. Before using this feature, check the device's firmware and update it if needed.
- You should install the Samsung Smart Camera application on your phone or device before using this feature. You can download the application from Samsung Apps, the Google Play Store, or the Apple App Store. The Samsung Smart Camera app is compatible with Samsung camera models manufactured in 2013 or later.

- 1 On the camera, rotate the mode dial to **Wi-Fi**.
- 2 On the camera, select .
 - If the pop-up message that prompts you to download the application appears, select **Next**.
- 3 On the smart phone, turn on the Samsung Smart Camera application.
 - For iOS devices, turn on the Wi-Fi feature before turning on the application.
- 4 Select the camera from the list and connect the smart phone to the camera.
 - The smart phone can connect to only one camera at a time.
- 5 On the camera, allow the smart phone to connect to your camera.
 - If the smart phone has been connected to your camera before, it is connected automatically.

- 6 On the smart phone, set the following shooting options.

Icon	Description
	Flash option
	Timer option
	Photo size
	Saving location
	Zoom ratio

- While using this feature, some buttons are not available on your camera.
- The zoom button and the shutter button on your smart phone will not function when using this feature.
- Remote Viewfinder mode supports the  and  photo sizes only.

7 On the smart phone, touch and hold  to focus.

- The focus is automatically set to **Multi AF**.

8 Release  to capture the photo.

- The photo will be resized to 640 X 360 when it is stored to the smart phone.



- When you use this feature, the ideal distance between the camera and the smart phone may vary, depending on your surroundings.
- The smart phone must be within 7 m of the camera to use this feature.
- It will take some time to capture the photo after you release  on the smart phone.
- The Remote Viewfinder function will deactivate when:
 - there is an incoming call on the smart phone
 - either the camera or the smart phone turns off
 - the memory is full
 - either device loses its connection to the WLAN
 - the Wi-Fi connection is poor or unstable

Saving files to a smart phone automatically

The camera connects to a smart phone that supports the AutoShare feature via a WLAN. When you capture a photo with your camera, the photo is saved to the smart phone automatically.



- The AutoShare feature is supported by Galaxy series smart phones or Galaxy Tab models with the Android 2.2 OS or higher or iOS devices with the iOS 4.3 or higher. Before using this feature, check the device's firmware and update it if needed.
- You should install the Samsung Smart Camera application on your phone or device before using this feature. You can download the application from Samsung Apps, the Google Play Store, or the Apple App Store. The Samsung Smart Camera app is compatible with Samsung camera models manufactured in 2013 or later.
- You must insert a memory card to use this feature.
- If you set this function, the setting is maintained even when you change the Shooting mode.
- This feature may not be supported in some modes.

- 1 On the camera, in Shooting mode, press [MENU].
- 2 On the camera, select **AutoShare** → **On**.
 - If the pop-up message that prompts you to download the application appears, select **Next**.
- 3 On the smart phone, turn on the Samsung Smart Camera application.
 - For iOS devices, turn on the Wi-Fi feature before turning on the application.
- 4 Select the camera from the list and connect the smart phone to the camera.
 - The smart phone can connect to only one camera at a time.
- 5 On the camera, allow the smart phone to connect to your camera.
 - If the smart phone has been connected to your camera before, it is connected automatically.
 - An icon that shows the connection status (📶) will appear on the camera's screen.
- 6 On the camera, capture a photo.
 - The captured photo is saved to the camera, and then transferred to the smart phone.
 - If you recorded a video, it is saved only to the camera.
 - A GIF file captured in Motion Photo mode is not saved on the smart phone.
 - The image file captured while recording a video is not saved on the smart phone.

Using Auto Backup to send photos or videos

You can send photos or videos that you captured with the camera to a PC wirelessly.

Installing the program for Auto Backup on your PC

- 1 Install i-Launcher on the PC. (p. 104)
- 2 Connect the camera to the PC with the USB cable.
- 3 When the Auto Backup program icon appears, click it.
 - The Auto Backup program is installed on the PC and the information about the PC will be stored to the camera. Follow the on-screen instructions to complete the installation.
 - You can also save the information about the PC to the camera by connecting the PC and the camera via Wi-Fi.
- 4 Remove the USB cable.



Before installing the program, ensure that the PC is connected to a network.

Sending photos or videos to a PC

- 1 Rotate the mode dial to **Wi-Fi**.
- 2 Select .
 - If the the pop-up message that prompts you to download the application appears, select **Next**.
 - You must configure the backup PC information to use the Auto Backup feature. For more details, refer to “Installing the program for Auto Backup on your PC”. (p. 119) If the Auto Backup program is installed on your PC, save the PC information via USB cable or Wi-Fi connection.
 - The camera will automatically attempt to connect to a WLAN via the most recently connected AP device.
 - If the camera has not previously been connected to a WLAN, it will search for available AP devices. (p. 111)

3 Select a backup PC.

- If you have performed a backup before, skip to step 4.

4 Select **OK**.

- To cancel sending, select **Cancel**.
- You cannot select individual files to backup. This function backs up only new files on the camera.
- The backup's progress will be shown on the PC monitor.
- When the transfer is completed, the camera will turn off automatically in approximately 30 seconds. Select **Cancel** to return to the previous screen and prevent the camera from turning off automatically.
- To turn off your PC automatically after the transfer is complete, select **Shut down PC after backup** → **On**.
- To change the backup PC, select .



- When you connect the camera to the WLAN, select the AP that is connected to the PC.
- The camera will search for available access points even if you are connecting to the same access point again.
- If you turn off the camera or remove the battery while sending files, the file transfer will be interrupted.
- While you are using this feature, the shutter control is disabled on your camera.
- You can connect only one camera to the PC at a time for sending files.
- The backup may be canceled due to network conditions.
- Photos or videos can be sent to a PC one time only. Files cannot be sent again even if you reconnect your camera to another PC.
- When there are no files in the camera memory, you cannot use this feature.
- You must turn off Windows Firewall and any other firewalls before using this feature.
- You can send up to 1,000 recent files.
- On the PC software, the server name must be entered in the Latin alphabet and can contain no more than 48 characters.
- When multiple file types are created at once, only the image files (JPG) will be sent to the PC with this feature.

Sending photos or videos via email

You can change settings in the email menu and send photos or videos stored on the camera via email.

Changing email settings

In the email menu, you can change settings for storing your information. You can also set or change the email password. For information about entering text, refer to "Entering text". (p. 114)

Storing your information

- 1 Rotate the mode dial to **Wi-Fi**.
- 2 Select .
 - The camera will automatically attempt to connect to a WLAN via the most recently connected AP device.
 - If the camera has not previously been connected to a WLAN, it will search for available AP devices. (p. 111)
- 3 Press [MENU].
- 4 Select **Sender Setting**.

- 5 Select the **Name** box, enter your name, and then select **Done**.

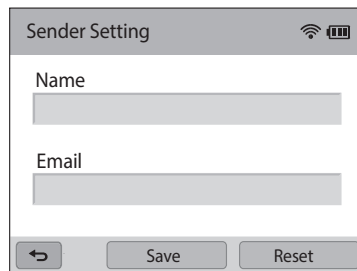

The screenshot shows a 'Sender Setting' menu on a camera's LCD screen. At the top, there is a title bar with 'Sender Setting' on the left and a Wi-Fi signal strength icon and a battery level icon on the right. Below the title bar, there are two text input fields. The first field is labeled 'Name' and the second is labeled 'Email'. At the bottom of the screen, there are three buttons: a back arrow button on the left, a 'Save' button in the center, and a 'Reset' button on the right.

- 6 Select the **Email** box, enter your email address, and then select **Done**.
- 7 Select **Save** to save your changes.
 - To delete your information, select **Reset**.

Setting an email password

- 1 Rotate the mode dial to **Wi-Fi**.
- 2 Select .
 - The camera will automatically attempt to connect to a WLAN via the most recently connected AP device.
 - If the camera has not previously been connected to a WLAN, it will search for available AP devices. (p. 111)
- 3 Press [**MENU**].
- 4 Select **Setting Password** → **On**.
 - To deactivate the password, select **Off**.
- 5 When the pop-up appears, select **OK**.
 - The pop-up disappears automatically even if you do not select **OK**.
- 6 Enter a 4-digit password.
- 7 Enter the password again.
- 8 When the pop-up appears, select **OK**.



If you lost your password, you can reset it by selecting **Reset** on the password setting screen. When you reset the information, the previously saved user's setting information, email address, and recently sent email list will be deleted.

Changing the email password

- 1 Rotate the mode dial to **Wi-Fi**.
- 2 Select .
 - The camera will automatically attempt to connect to a WLAN via the most recently connected AP device.
 - If the camera has not previously been connected to a WLAN, it will search for available AP devices. (p. 111)
- 3 Press [**MENU**].
- 4 Select **Change Password**.
- 5 Enter your current 4-digit password.
- 6 Enter a new 4-digit password.
- 7 Enter the new password again.
- 8 When the pop-up appears, select **OK**.

Sending photos or videos via email

You can send photos or videos stored on the camera via email. For information about entering text, refer to "Entering text". (p. 114)

- 1 Rotate the mode dial to **Wi-Fi**.
- 2 Select .
 - The camera will automatically attempt to connect to a WLAN via the most recently connected AP device.
 - If the camera has not previously been connected to a WLAN, it will search for available AP devices. (p. 111)
- 3 Select the **Sender** box, enter your email address, and then select **Done**.
 - If you have previously saved your information, it will be inserted automatically. (p. 121)
 - To use an address from the list of previous senders, select ▼ → an address.
- 4 Select the **Receiver** box, enter an email address, and then select **Done**.
 - To use an address from the list of previous recipients, select ▼ → an address.
 - Select + to add additional recipients. You can input up to 30 recipients.
 - Select X to delete an address from the list.
- 5 Select **Next**.

- 6 Select files to send.
 - You can select up to 20 files. The total size must be 7 MB or less.
- 7 Select **Next**.
- 8 Select the comment box, enter your comments, and then select **Done**.
- 9 Select **Send**.
 - The camera will send the email.



- Even if a photo appears to have transferred successfully, errors with the recipient's email account may cause the photo to be rejected or recognized as spam.
- You may not be able to send an email if no network connection is available or if your email account settings are incorrect.
- You cannot send an email if the file size exceeds the limit. The maximum photo resolution you can send is 2M and the longest video you can upload is 30 seconds at **QVGA** resolution or a video recorded using . If the selected photo resolution is higher than 2M, it will be automatically resized to a lower resolution.
- If you cannot send an email because of firewall or user authentication settings, contact your network administrator or network service provider.
- When there are no files in the camera memory, you cannot use this feature.
- You can also send an email in Playback mode by pressing [MENU], and then selecting **Share(Wi-Fi)** → **Email**.

Using photo or video sharing websites

Upload your photos or videos to file sharing websites. Available websites will be displayed on your camera. To upload files to some websites, you must visit the website and register before connecting your camera.

Accessing a website

- 1 Rotate the mode dial to **Wi-Fi**.
- 2 Select .
- 3 Select a website.
 - If the pop-up message that prompts you to create an account appears, select **OK**.
 - The camera will automatically attempt to connect to a WLAN via the most recently connected AP device.
 - If the camera has not previously been connected to a WLAN, it will search for available AP devices. (p. 111)
- 4 Enter your ID and password to log in.
 - For information about entering text, refer to "Entering text". (p. 114)
 - If you connected to SkyDrive, refer to "Using the login browser". (p. 112)
 - To select an ID from the list, select ▼ → an ID.
 - If you have previously logged in to the website, you may be logged in automatically.

Uploading photos or videos

- 1 Access the website with your camera.
- 2 Select files to upload.
 - You can select up to 20 files. The total size must be 10 MB or less. (On some websites, the total size or number of files may vary.)
- 3 Select **Upload**.
 - On some websites, you can enter your comments by selecting the comment box. For information about entering text, refer to "Entering text". (p. 114)



You must have an existing account on the file sharing website to use this feature.



- You can set an upload folder for Facebook by pressing **[MENU]**, and then selecting **Upload Folder (Facebook)** on the website's list screen.
- You cannot upload files if the file size exceeds the limit. The maximum photo resolution you can upload is 2M, and the longest video you can upload is 30 seconds at **QVGA** resolution or a video recorded using **240p**. If the selected photo resolution is higher than 2M, it will be automatically resized to a lower resolution. (On some websites, the maximum photo resolution may vary.)
- The method of uploading photos or videos may differ depending on the selected website.
- If you cannot access a website because of firewall or user authentication settings, contact your network administrator or network service provider.
- Uploaded photos or videos may be automatically titled with the date they were captured.
- The speed of your internet connection may affect how quickly photos upload or web pages open.
- When there are no files in the camera memory, you cannot use this feature.
- You can also upload photos or videos to file sharing websites in Playback mode by pressing **[MENU]**, and then selecting **Share(Wi-Fi)** → a desired website.
- You cannot upload videos to some websites.
- When you upload photos to SkyDrive, they will be resized to 2M while maintaining their aspect ratios.

Using AllShare Play to send files

You can upload files from your camera to AllShare Play online storage or view files on an AllShare Play device connected to the same AP.

Uploading photos to online storage

- 1 Rotate the mode dial to **Wi-Fi**.
- 2 Select  → **Web storage**.
 - If the guide message appears, select **OK**.
 - The camera will automatically attempt to connect to a WLAN via the most recently connected AP device.
 - If the camera has not previously been connected to a WLAN, it will search for available AP devices. (p. 111)
 - To change the size for uploaded photos, press **[MENU]**, and then select **Upload Image Size**.
 - If you have registered more than one web storage, you can select from the list by pressing **[MENU]**, and then selecting **Change Web storage**.

- 3 Enter your ID and password, and then select **Login** → **OK**.
 - For information about entering text, refer to "Entering text". (p. 114)
 - To select an ID from the list, select ▼ → an ID.
 - If you have previously logged in to the website, you may be logged in automatically.



To use this feature, you must create an AllShare Play account and an account with an affiliated online storage service using your PC. After finishing creating accounts, add your online storage account to AllShare Play.

- 4 Select files to upload, and then select **Upload**.



- If you have registered more than one web storage, select a web storage first.
- You cannot upload video files to AllShare Play online storage.
- When there are no files in the camera memory, you cannot use this feature.
- You can upload up to 20 files. The total size must be 10 MB or less.
- You can also upload photos in Playback mode by pressing **[MENU]**, and then selecting **Share(Wi-Fi)** → **AllShare Play**.

Viewing photos or videos on devices that support AllShare Play

- 1 Rotate the mode dial to **Wi-Fi**.
- 2 Select  → **Nearby devices**.
 - If the guide message appears, select **OK**.
 - The camera will automatically attempt to connect to a WLAN via the most recently connected AP device.
 - If the camera has not previously been connected to a WLAN, it will search for available AP devices. (p. 111)
 - You can set to allow only selected devices or all devices to connect by pressing [**MENU**], and then selecting **DLNA Access Control** on the screen.
 - A sharing file list is created. Wait until other devices can find your camera.
- 3 Connect the AllShare Play device to a network, and then turn on the AllShare Play feature.
 - Refer to your device's user manual for more information.
- 4 On the camera, allow the AllShare Play device to connect to your camera.
- 5 On the the AllShare Play device, select a camera to connect.

- 6 On the AllShare Play device, browse the shared photos or videos.
 - For information about searching for the camera and browsing the photos or videos on the AllShare Play device, refer to the device's user manual.
 - Videos may not play smoothly depending on the type of AllShare Play device or the network condition. If this happens, re-record the video in 640 X 480 or smaller quality and play it again. If videos do not play smoothly on your device over the wireless connection, try connecting the camera to the device with an A/V cable.

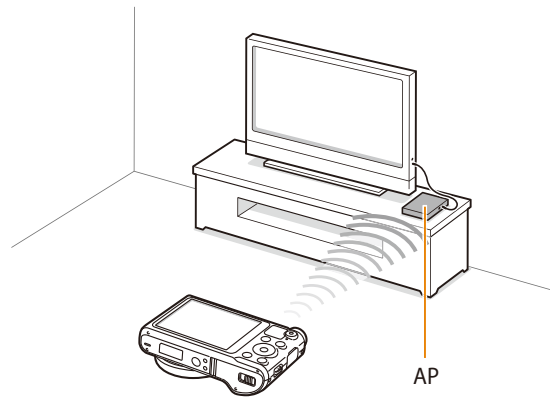

▲ A camera is connected to a TV that supports AllShare Play via WLAN.



- You can share up to 1,000 recent files.
- On an AllShare Play device, you can view only photos or videos captured with your camera.
- The range of the wireless connection between your camera and an AllShare Play device may vary depending on the specifications of the AP.
- If the camera is connected to 2 AllShare Play devices, playback may be slower.
- Photos or videos will be shared in their original sizes.
- You can use this feature only with devices that support AllShare Play.
- Shared photos or videos will not be stored on the AllShare Play device, but they can be stored in the camera to meet the device's specifications.
- Transferring photos or videos to the AllShare Play device may take some time depending on the network connection, the number of files to be shared, or the sizes of the files.
- If you power off the camera abnormally while viewing photos or videos on an AllShare Play device (for example, by removing the battery), the device considers the camera to still be connected.
- The order of photos or videos on the camera may be different than on the AllShare Play device.

- Depending on the number of photos or videos you want to share, it may take some time to load your photos or videos and complete the initial set-up process.
- While viewing photos or videos on the AllShare Play device, continuously using the device's remote or performing additional operations on the device may prevent this feature from working properly.
- If you reorder or sort files on the camera while viewing them on an AllShare Play device, you must repeat the initial set-up process to update the list of files on the device.
- When there are no files in the camera memory, you cannot use this feature.
- We recommend you use a network cable to connect your AllShare Play device to your AP. This will minimize any video 'Stuttering' you may experience when streaming content.
- To view files on an AllShare Play device using the **Nearby devices** feature, enable multicast mode on your AP.

Sending photos using Wi-Fi Direct

When the camera connects via a WLAN to a device that supports the Wi-Fi Direct function, you can send photos to the device. This feature may not be supported on some devices.

- 1 On the device, turn on the Wi-Fi Direct option.
- 2 On the camera, in Playback mode, scroll to a photo.
- 3 Press **[MENU]**, and then select **Share(Wi-Fi) → Wi-Fi Direct**.
 - When in the single image view, you can send only one photo at a time.
 - When in thumbnails view, you can select multiple photos. Select **Send** when you are finished selecting photos.
- 4 Select the device from the camera's list of Wi-Fi Direct devices.
 - Ensure that the device's Wi-Fi Direct option is turned on.
 - You can also select your camera from the device's list of Wi-Fi Direct devices.

- 5 On the device, allow the camera to connect to the device.
 - The photo will be sent to the device.



- You can send up to 20 files at a time.
- When there are no photos in the camera memory, you cannot use this feature.
- If you cannot connect to a Wi-Fi Direct device, update the device with the latest firmware. This feature may not be supported on some devices.

Settings

Refer to options to configure your camera's settings.

Settings menu	131
Accessing the settings menu	131
Sound	132
Display	132
Connectivity	133
General	134

Settings menu

Learn to configure your camera's settings.

Accessing the settings menu

- 1 Rotate the mode dial to .
- 2 Select a menu.

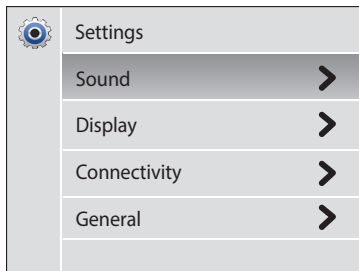

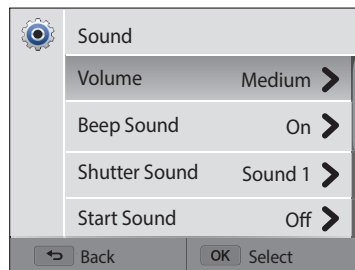

Option	Description
Sound	Set various camera sounds and the volume. (p. 132)
Display	Customize the display settings. (p. 132)
Connectivity	Set the connection options. (p. 133)
General	Change the settings for the camera system such as memory format and default file name. (p. 134)

- 3 Select an item.

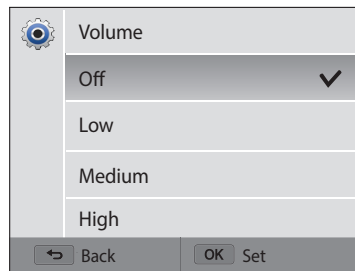

- 4 Select an option.



- 5 Press [

Settings 131

Sound

* Default



Item	Description
Volume	Set the volume of all sounds. (Off, Low, Medium* , High)
Beep Sound	Set the sound the camera emits when you press the buttons, switch modes, or touch the screen on or off. (Off, On*)
Shutter Sound	Set the sound the camera emits when you press the shutter button. (Off, Sound 1* , Sound 2, Sound 3)
Start Sound	Set the sound the camera emits when you turn on your camera. (Off* , Star Flight, Laser Show, Cloud)
AF Sound	Set the sound the camera emits when you half-press the shutter button on or off. (Off, On*)

Display

* Default

Item	Description
Start Image	<p>Set a start image to display when the camera turns on.</p> <ul style="list-style-type: none"> • Off*: Display no start image. • Logo: Display a default image stored in the internal memory. • User Image: Select User Image from the photos you captured in the memory. <p> • The camera will save only one User Image in the internal memory at a time.</p> <ul style="list-style-type: none"> • If you select a new photo as a User Image or reset your camera, the camera will delete the current image.
Guide Line	Select a guide to help you compose a scene. (Off* , 3 X 3, 2 X 2, Cross, Diagonal)
Date/Time Display	Set whether or not to display the date and time on the camera's display. (Off* , On)
Help Guide Display	Display a brief description of an option or menu. (Off, On*)

* Default

Item	Description
Display Brightness	Adjust the brightness of the screen. (Auto* , Dark , Normal , Bright)  Normal is fixed in Playback mode even if you have selected Auto .
Quick View	Set whether or not to review a captured image before returning to the Shooting mode. (Off , On*)  This feature does not work in some modes.
Power Save	If you perform no operations for 30 seconds, the camera automatically switches to Power save mode. (Off* , On)  In Power save mode, press any button other than [⏻] to resume using the camera.



Connectivity

* Default

Item	Description
Video Out	Set the video signal output for your region. <ul style="list-style-type: none"> • NTSC: USA, Canada, Japan, Korea, Taiwan, Mexico, etc • PAL (supports only BDGHI): Australia, Austria, Belgium, China, Denmark, England, Finland, France, Germany, Italy, Kuwait, Malaysia, Netherlands, New Zealand, Norway, Singapore, Spain, Sweden, Switzerland, Thailand, etc
i-Launcher	Set i-Launcher to launch automatically when you connect your camera to your computer. (Off , On*)

General





* Default

Item	Description
Network Information	View the Mac address and network certification number of your camera.
Language	Set a language for the display text.
Time Zone	Set the time zone for your location. When you travel to another country, select Visit , and then select the appropriate time zone. (Home* , Visit)
Date/Time Set	Set the date and time.
Date Type	Set a date format. (YYYY/MM/DD , MM/DD/YYYY , DD/MM/YYYY)  The default date type may differ depending on the language selected.
Time Type	Set the time format. (12 Hr , 24 Hr)  The default time type may differ depending on the language selected.

* Default

Item	Description
File No.	<p>Specify how to name files.</p> <ul style="list-style-type: none"> • Reset: Set the file number to start from 0001 when you insert a new memory card, format a memory card, or delete all files. • Series*: Set the file number to resume from the previous file number when you insert a new memory card, format a memory card, or delete all files.  <ul style="list-style-type: none"> • The default name of the first folder is 100PHOTO and the default name of the first file is SAM_0001. • The file number increases by one, from SAM_0001 to SAM_9999, each time you capture a photo or record a video. • The folder number increases by one, from 100PHOTO to 999PHOTO, each time a folder is full. • The maximum number of files that can be stored in one folder is 9,999. • The camera defines file names according to the Design rule for Camera File system (DCF) standard. If you intentionally change file names, the camera may not play back the files.

* Default

Item	Description
Imprint	<p>Set whether or not to display the date and time on captured photos. (Off*, Date, Date & Time)</p> <ul style="list-style-type: none">  The date and time will be displayed on the bottom right corner of the photo. Some printer models may not print the date and time properly. The photo will not display the date and time if: <ul style="list-style-type: none"> - you select  mode - you select Panorama in  mode - you select My Magic Frame or Motion Photo in  mode
Auto Power Off	<p>Set the camera to automatically turn off when you perform no operations for a specified period. (Off, 1 min, 3 min*, 5 min, 10 min)</p> <ul style="list-style-type: none">  Your settings will not change when you replace the battery. The camera will not automatically turn off when the camera is connected to a computer, or WLAN, and when you are playing a slide show or videos.
DIRECT LINK (Wi-Fi Button)	<p>Start a preset Wi-Fi function by pressing [DIRECT LINK]. (MobileLink*, AutoShare, Remote Viewfinder, Auto Backup, Email, SNS & Cloud, AllShare Play)</p>

* Default

Item	Description
AF Lamp	<p>Set a light to automatically turn on in dark places to help you focus. (Off, On*)</p>
Format	<p>Format the internal memory and the memory card. Formatting will delete all files, including protected files. (Yes, No)</p> <ul style="list-style-type: none">  Errors can occur if you use a memory card formatted by another brand of camera, a memory card reader, or a computer. Please format memory cards in the camera before using them to capture photos.
Reset	<p>Reset menus and shooting options. Date, time, language, and video output settings will not be reset. (Yes, No)</p>
Open Source Licenses	<p>View open source licenses.</p>

Appendixes

Get information about error messages, specifications, and maintenance.

Error messages	137
Camera maintenance	139
Cleaning your camera	139
Using or storing the camera	140
About memory cards	141
About the battery	144
Before contacting a service center	148
Camera specifications	151
Glossary	155
Index	160

Error messages

When the following error messages appear, try these remedies.

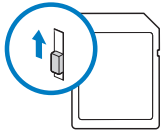
Error message	Suggested remedies
Card Error	<ul style="list-style-type: none">• Turn off your camera, and then turn it on again.• Remove your memory card, and then insert it again.• Format your memory card.
Card Locked	<p>You can lock an SD, SDHC, or SDXC card to prevent files from being deleted. Unlock the card when shooting.</p> 
Card not supported.	<p>The inserted memory card is not supported by your camera. Insert a SD, SDHC, or SDXC memory card.</p>
Connection failed.	<ul style="list-style-type: none">• The camera cannot connect to the network using the selected access point. Select another AP and try again.• The camera has failed to connect to the other devices. Try connecting again.

Error message	Suggested remedies
DCF Full Error	<p>File names do not match the DCF standard. Transfer the files from the memory card to your computer and format the card. Then, open the Settings menu and select File No. → Reset. (p. 134)</p>
Device disconnected.	<p>Network connection disconnected while transferring photos. Reselect a device that supports AllShare Play.</p>
File Error	<p>Delete the damaged file or contact a service center.</p>
File system not supported.	<p>Your camera does not support the FAT file structure of the inserted memory card. Format the memory card on the camera.</p>
Initialization failed.	<p>The camera has failed to locate a device that supports AllShare Play. Turn on devices on the network that support AllShare Play.</p>
Invalid password.	<p>The password for transferring files to another camera is wrong. Enter the correct password.</p>
Low Battery	<p>Insert a charged battery or recharge the battery.</p>

Error message	Suggested remedies
Memory Full	Delete unnecessary files or insert a new memory card.
No Image File	Capture photos or insert a memory card that contains some photos.
Photo transfer failed.	Network connection disconnected while transferring photos. Try restarting the AllShare Play feature.
Transfer failed.	<ul style="list-style-type: none">• The camera has failed to send a photo to the other camera. Try sending again.• The camera has failed to send an email or transfer a photo to a device that supports AllShare Play. Check the network connection and try again.

Camera maintenance

Cleaning your camera

Camera lens and display

Use a blower brush to remove dust and wipe the lens gently with a soft cloth. If any dust remains, apply lens cleaning liquid to a piece of lens cleaning paper and wipe gently.

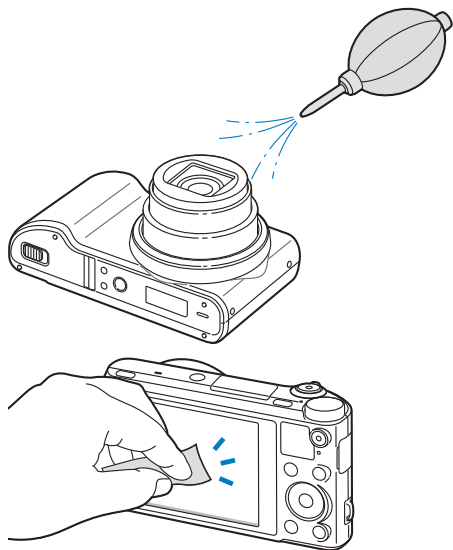

Camera body

Wipe gently with a soft, dry cloth.

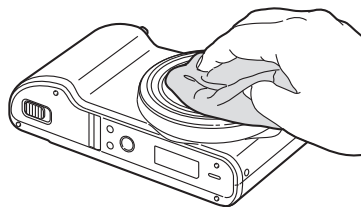

- Never use benzene, thinners, or alcohol to clean the device. These solutions can damage the camera or cause it to malfunction.
- Do not press on the lens cover or use a blower brush on the lens cover.

Using or storing the camera

Inappropriate places to use or store the camera

- Avoid exposing the camera to very cold or very hot temperatures.
- Avoid using your camera in areas with extremely high humidity, or where the humidity changes drastically.
- Avoid exposing the camera to direct sunlight and storing it in hot, poorly-ventilated areas, such as in a car during summer time.
- Protect your camera and the display from impact, rough handling, and excessive vibration to avoid serious damage.
- Avoid using or storing your camera in dusty, dirty, humid, or poorly-ventilated areas to prevent damage to moving parts and internal components.
- Do not use your camera near fuels, combustibles, or flammable chemicals. Do not store or carry flammable liquids, gases, or explosive materials in the same compartment as the camera or its accessories.
- Do not store the camera where there are mothballs.

Using on beaches or shores

- Protect your camera from sand and dirt when you use it on beaches or in similar areas.
- Your camera is not waterproof. Do not handle the battery, adapter, or memory card with wet hands. Operating the camera with wet hands may cause damage to your camera.

Storing for extended period of time

- When you store the camera for an extended period, place it in a sealed container with an absorbent material, such as silica gel.
- Over time, unused batteries will discharge and must be recharged before use.
- You must reset the date and time when you turn the camera on after the camera and battery have been separated for a prolonged period.

Using the camera with caution in humid environments

When you transfer the camera from a cold environment to a warm one, condensation can form on the lens or internal components of the camera. In this situation, turn off the camera and wait for at least 1 hour. If condensation forms on the memory card, remove the memory card from the camera and wait until all moisture has evaporated before reinserting it.

Other cautions

- Do not swing your camera by the strap. This may cause injury to yourself or others or damage to your camera.
- Do not paint your camera, as paint can clog moving parts and prevent proper operation.
- Turn off the camera when not using it.

- Your camera contains delicate parts. Avoid impacts to the camera.
- Protect the display from external force by keeping it in the case when not in use. Protect the camera from scratches by keeping it away from sand, sharp implements, or loose change.
- Do not use the camera if the screen is cracked or broken. Broken glass or acrylic could cause injury to your hands and face. Take the camera to a Samsung service center to have it repaired.
- Never place cameras, batteries, chargers, or accessories near, on, or in heating devices, such as microwave ovens, stoves, or radiators. These devices may be deformed and can overheat and cause a fire or explosion.
- Do not expose the lens to direct sunlight, as this may discolor the image sensor or cause it to malfunction.
- Protect the lens from fingerprints and scratches. Clean the lens with a soft, clean, debris-free lens cloth.
- The camera may turn off if struck or dropped. This is to protect the memory card. Turn on the camera to use it again.
- While you use the camera, it may heat up. This is normal and should not affect your camera's lifespan or performance.
- When you use the camera in low temperatures, it may take some time to turn on, the color of the display may be changed temporarily, or after-images may appear. These conditions are not malfunctions and they will correct themselves when the camera is returned to milder temperatures.

- Paint or metal on the outside of the camera may cause allergies, itchy skin, eczema, or swelling for people with sensitive skin. If you experience any of these symptoms, stop using the camera immediately and consult a doctor.
- Do not insert foreign objects into any of your camera's compartments, slots, or access points. Damage due to improper use may not be covered by your warranty.
- Do not allow unqualified personnel to service the camera or attempt to service the camera yourself. Any damage that results from unqualified service is not covered by your warranty.

About memory cards

Supported memory cards

This product supports SD (Secure Digital), SDHC (Secure Digital High Capacity), SDXC (Secure Digital eXtended Capacity), microSD, microSDHC, or microSDXC memory cards.

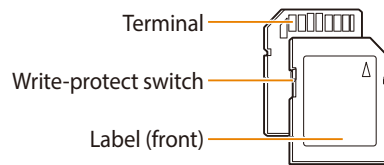

You can prevent files from being deleted by using the write-protect switch on an SD, SDHC, or SDXC card. Slide the switch down to lock or slide it up to unlock. Unlock the card when capturing photos and videos.

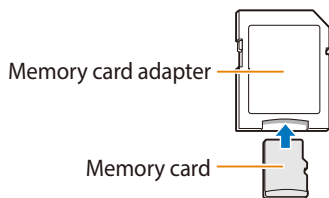

To use micro memory cards with this product, a PC, or a memory card reader, insert the card into an adapter.

Memory card capacity

The memory capacity may differ depending on the scenes you shoot or shooting conditions. These capacities are based on a 2 GB SD card:

Photo

Size	Super Fine	Fine	Normal
14M	248	489	722
12MP	277	546	805
10M	325	638	940
10M	341	669	984
8M	418	817	1,196
5M	638	1,228	1,777

Size	Super Fine	Fine	Normal
3M	1,006	1,897	2,692
2M	1,329	2,461	3,437
1M	2,508	4,359	5,780

Video

Size	30fps
FULL HD 1920 X 1080	Approx. 18' 03"
HD 1280 X 720	Approx. 25' 53"
VGA 640 X 480	Approx. 46' 12"
QVGA 320 X 240	Approx. 257' 31"
240 WEB For Sharing	Approx. 257' 31"

The figures above are measured without using the zoom function. Available recording time may vary if you use the zoom. Several videos were recorded in succession to determine the total recording time.

Cautions when using memory cards

- Avoid exposing memory cards to very cold or very hot temperatures (below 0 °C/32 °F or above 40 °C/104 °F). Extreme temperatures can cause memory cards to malfunction.
- Insert a memory card in the correct direction. Inserting a memory card in the wrong direction may damage your camera and memory card.
- Do not use memory cards that have been formatted by other cameras or by a computer. Reformat the memory card with your camera.
- Turn off the camera before you insert or remove the memory card.
- Do not remove the memory card or turn off your camera while the lamp is blinking, as this may damage your data.
- When the lifespan of a memory card has expired, you cannot store any more photos on the card. Use a new memory card.
- Do not bend, drop, or subject memory cards to heavy impact or pressure.
- Avoid using or storing memory cards near strong magnetic fields.
- Avoid using or keeping memory cards in areas with high temperatures, high humidity, or corrosive substances.
- Prevent memory cards from making contact with liquids, dirt, or foreign substances. If dirty, wipe the memory card clean with a soft cloth before you insert the memory card into your camera.
- Do not allow liquids, dirt, or foreign substances to come in contact with memory cards or the memory card slot. Doing so may cause memory cards or the camera to malfunction.
- When you carry a memory card, use a case to protect the card from electrostatic discharges.
- Transfer important data to other media, such as a hard disk, CD, or DVD.
- When you use the camera for an extended period, the memory card may become warm. This is normal and does not indicate a malfunction.



The manufacturer is not responsible for any loss of data.

About the battery



Use only Samsung-approved batteries.

Battery specifications

Specification	Description
Model	SLB-10A
Type	Lithium-ion battery
Cell capacity	1,030 mAh
Voltage	3.7 V
Charging time* (when the camera is switched off)	Approximately 240 min

* Charging the battery by connecting it to a computer may take longer.

Battery life

Average shooting time/ Number of photos		Test conditions (when the battery is fully charged)
Photos	Approximately 145 min/ Approximately 290 photos	The battery life was measured under the following conditions: in P mode, in darkness,  resolution, Fine quality, OIS on. <ol style="list-style-type: none"> 1. Set the flash option to Fill in, take a single shot, and zoom in or out. 2. Set the flash option to Off, take a single shot, and zoom in or out. 3. Perform steps 1 and 2, waiting 30 seconds between each step. Repeat the process for 5 minutes, and then turn off the camera for 1 minute. 4. Repeat steps 1 to 3.
Videos	Approximately 100 min	Record videos at  resolution and 30 FPS.

- The figures above are measured by Samsung's standards. Your results may differ, depending on your actual usage.
- Several videos were recorded in succession to determine the total recording time.
- When using network functions, the battery will be depleted more quickly.

Low battery message

When the battery has fully discharged, the battery icon will turn red and the "**Low Battery**" message will appear.

Notes about using the battery

- Avoid exposing batteries to very cold or very hot temperatures (below 0 °C/32 °F or above 40 °C/104 °F). Extreme temperatures can reduce the charging capacity of your batteries.
- When you use the camera for an extended period, the area around the battery chamber may become warm. This does not affect the normal use of the camera.
- Do not pull the power supply cord to disconnect the plug from the power outlet, as this may cause a fire or electric shock.
- In temperatures below 0 °C/32 °F, battery capacity and battery life may decrease.
- Battery capacity may decrease in low temperatures, but will return to normal in milder temperatures.
- Remove the batteries from your camera when storing it for an extended period. Installed batteries may leak or corrode over time and cause serious damage to your camera. Storing the camera for extended periods with the battery installed causes the battery to discharge. You may not be able to recharge a fully discharged battery.
- When you do not use the camera for an extended period (3 months or more), check the battery and recharge it regularly. If you let the battery discharge continually, its capacity and life may decrease, which can lead to a malfunction, fire, or explosion.

Cautions about using the battery

Protect batteries, chargers, and memory cards from damage

Prevent batteries from making contact with metal objects, as this can create a connection between the + and – terminals of your battery and lead to temporary or permanent battery damage and may cause a fire or electric shock.

Notes about charging the battery

- If the status lamp is off, make sure that the battery is inserted correctly.
- If the camera is on while charging, the battery may not fully charge. Turn off the camera before charging the battery.
- Do not use your camera when you are charging the battery. This may cause a fire or electric shock.
- Do not pull the power supply cord to disconnect the plug from the power outlet, as this may cause a fire or electric shock.
- Let the battery charge for at least 10 minutes before turning on the camera.
- If you connect the camera to an external power source when the battery is depleted, using high energy-consuming functions will cause the camera to turn off. To use the camera normally, recharge the battery.

- If you reconnect the power cable when the battery is fully charged, the status lamp turns on for approximately 30 minutes.
- Using the flash or recording videos depletes the battery quickly. Charge the battery until the red status lamp turns off.
- If the status lamp blinks in red, reconnect the cable, or remove the battery and insert it again.
- If you charge the battery when the cable is overheated or the temperature is too high, the status lamp may blink in red. Charging will start when the battery cools down.
- Overcharging batteries may shorten battery life. After charging is finished, disconnect the cable from your camera.
- Do not bend or place heavy objects on the AC cable. Doing so may damage the cable.

Notes about charging with a computer connected

- Use only the provided USB cable.
- The battery may not charge when:
 - you use a USB hub
 - other USB devices are connected to your computer
 - you connect the cable to the port on the front side of your computer
 - the USB port of your computer does not support the power output standard (5 V, 500 mA)

Handle and dispose of batteries and chargers with care

- Never dispose of batteries in a fire. Follow all local regulations when you dispose of used batteries.
- Never place batteries or cameras on or in heating devices, such as microwave ovens, stoves, or radiators. Batteries may explode when they are overheated.



Personal injury or death can occur if the battery is handled carelessly or improperly. For your safety, follow these instructions for proper battery handling:

- The battery can ignite or explode if not handled properly. If you notice any deformities, cracks, or other abnormalities in the battery, immediately discontinue use of the battery and contact a service center.
- Use only authentic, manufacturer-recommended battery chargers and adapters and charge the battery only by the methods described in this user manual.
- Do not place the battery near heating devices or expose it to excessively warm environments, such as the inside of an enclosed car in the summertime.
- Do not place the battery in a microwave oven.
- Avoid storing or using the battery in hot, humid places, such as spas or shower enclosures.
- Do not rest the camera on flammable surfaces, such as bedding, carpets, or electric blankets for a prolonged period.
- When the camera is switched on, do not leave it in any confined space for a prolonged period.
- Do not allow battery terminals to come in contact with metallic objects, such as necklaces, coins, keys, or watches.
- Use only authentic, manufacturer-recommended, Lithium-ion replacement batteries.

- Do not disassemble the battery or puncture it with any sharp object.
- Avoid exposing the battery to high pressure or crushing forces.
- Avoid exposing the battery to major impacts, such as dropping it from high places.
- Do not expose the battery to temperatures of 60 °C (140 °F) or above.
- Do not allow the battery to come in contact with moisture or liquids.
- Do not expose the battery to sources of excessive heat such as sunshine, fire or the like.

Disposal guidelines

- Dispose of the battery with care.
- Do not dispose of the battery in a fire.
- Disposal regulations may differ by country or region. Dispose of the battery in accordance with all local and federal regulations.

Guidelines for charging the battery

Charge the battery only by the methods described in this user manual. The battery can ignite or explode if not charged properly.

Before contacting a service center

If you are having trouble with your camera, try these troubleshooting procedures before you contact a service center. If you have attempted the suggested remedy and are still having problems with your device, contact your local dealer or service center.



When you leave your camera at a service center, be sure to also leave the other components that may have contributed to the malfunction, such as the memory card and battery.

Situation	Suggested remedies
Cannot turn on the camera	<ul style="list-style-type: none">• Ensure that the battery is inserted.• Ensure that the battery is inserted correctly. (p. 23)• Charge the battery.
The power turns off suddenly	<ul style="list-style-type: none">• Charge the battery.• Your camera may be in Auto Power Off mode. (p. 135)• The camera may turn off to prevent the memory card from being damaged due to an impact. Turn on your camera again.
The camera is losing battery power quickly	<ul style="list-style-type: none">• The battery may lose power more quickly in low temperatures (below 0 °C/32 °F). Keep the battery warm by putting it into your pocket.• Using the flash or recording videos depletes the battery quickly. Recharge if needed.• Batteries are consumable parts that must be replaced over time. Get a new battery if the battery life is diminishing quickly.

Situation	Suggested remedies
Cannot capture photos	<ul style="list-style-type: none">• There is no space on the memory card. Delete unnecessary files or insert a new card.• Format the memory card.• The memory card is defective. Get a new memory card.• Make sure that the camera is switched on.• Charge the battery.• Make sure that the battery is inserted correctly.
The camera freezes	Remove the battery and insert it again.
The camera heats up	While you use the camera, it may heat up. This is normal and should not affect your camera's lifespan or performance.
The flash does not work	<ul style="list-style-type: none">• The flash option may be set to Off. (p. 66)• You cannot use the flash in some modes.
The flash fires unexpectedly	The flash may fire due to static electricity. The camera is not malfunctioning.

Situation	Suggested remedies
The date and time are incorrect	Set the date and time in the display settings. (p. 134)
The display or buttons do not work	Remove the battery, and then insert it again.
The camera display responds poorly	If you use your camera at very low temperatures, it may cause the camera screen to malfunction or discolor. For better performance of your camera screen, use your camera in moderate temperatures.
The memory card has an error	<ul style="list-style-type: none"> • Turn off your camera, and then turn it on again. • Remove your memory card, and then insert it again. • Format your memory card. See "Cautions when using memory cards" for more detail. (p. 143)
Cannot play back files	If you change the name of a file, your camera may not play the file (the name of the file should meet the DCF standard). If you encounter this situation, play back the files on your computer.

Situation	Suggested remedies
The photo is blurry	<ul style="list-style-type: none"> • Make sure that the focus option you set is suitable for close-up shots. (p. 69) • Make sure that the lens is clean. If not, clean the lens. (p. 139) • Make sure that the subject is within range of the flash. (p. 152)
The colors in the photo do not match the actual scene	An incorrect White Balance can create unrealistic color. Select the proper White Balance option to suit the light source. (p. 79)
The photo is too bright	Your photo is overexposed. <ul style="list-style-type: none"> • Turn off the flash. (p. 66) • Adjust the ISO sensitivity. (p. 68) • Adjust the exposure value. (p. 77)
The photo is too dark	Your photo is underexposed. <ul style="list-style-type: none"> • Turn on the flash. (p. 66) • Adjust the ISO sensitivity. (p. 68) • Adjust the exposure value. (p. 77)

Situation	Suggested remedies
The TV does not display your photos	<ul style="list-style-type: none"> • Make sure that the camera is correctly connected to the TV with the A/V cable. • Make sure that your memory card contains photos.
Your computer does not recognize your camera	<ul style="list-style-type: none"> • Make sure that the USB cable is connected correctly. • Make sure that your camera is switched on. • Make sure that you are using a supported operating system.
Your computer disconnects the camera while transferring files	The file transmission may be interrupted by static electricity. Disconnect the USB cable and connect it again.
Your computer cannot play videos	Videos may not play on some video player programs. To play video files captured with your camera, use the Multimedia Viewer program that you can install with the i-Launcher program on your computer.

Situation	Suggested remedies
i-Launcher is not functioning properly	<ul style="list-style-type: none"> • End i-Launcher and restart the program. • Make sure that i-Launcher is set to On in the settings menu. (p. 133) • Depending on your computer's specifications and environment, the program may not launch automatically. In this case, click Start → All Programs → Samsung → i-Launcher → Samsung i-Launcher on your Windows computer. (For Windows 8, open Start screen, and then select All apps → Samsung i-Launcher.) Or, click Applications → Samsung → i-Launcher on your Mac OS computer.
Your TV or computer cannot display photos and videos that are stored on an SDXC memory card.	SDXC memory cards use the exFAT file system. Ensure that the external device is compatible with the exFAT file system before connecting the camera to the device.
Your computer does not recognize an SDXC memory card.	SDXC memory cards use the exFAT file system. To use SDXC memory cards on a Windows XP computer, download and update the exFAT file system driver from the Microsoft website.

Camera specifications









Image sensor	
Type	1/2.33" (Approximately 7.67 mm) BSI CMOS
Effective pixels	Approximately 14.2 mega-pixels
Total pixels	Approximately 16.4 mega-pixels
Lens	
Focal length	Samsung Lens f = 4.0–72.0 mm (35 mm film equivalent: 24–432 mm)
F-stop range	F3.2(W)–F5.8(T)
Zoom	<ul style="list-style-type: none"> Still image mode: 1.0–18.0X (Optical zoom X Digital zoom: 90.0X, Optical zoom X Intelli zoom: 36.0X) Playback mode: 1.0–14.4X (depending on image size)
Display	
Type	TFT LCD
Feature	3.0" (75.0 mm) 460K
Focusing	
Type	TTL auto focus (Center AF, Multi AF, Tracking AF, Face Detection AF, Touch AF), Manual Focus

Range		Wide (W)	Tele (T)
	Normal (AF)	31 in. (80 cm)-infinity	138 in. (350 cm)-infinity
	Macro	2-31 in. (5-80 cm)	71-138 in. (180-350 cm)
	Auto Macro	2 in. (5 cm)-infinity	71 in. (180 cm)-infinity
	Manual Focus	2 in. (5 cm)-infinity	71 in. (180 cm)-infinity
Shutter speed			
<ul style="list-style-type: none"> Auto: 1/8–1/2,000 sec. Program: 1–1/2,000 sec. Manual: 16–1/2,000 sec. 			
Exposure			
Control	Program AE, Aperture Priority AE, Shutter Priority AE, Manual Exposure		
Metering	Multi, Spot, Center-weighted, Face Detection		
Compensation	±2EV (1/3 EV Step)		
ISO equivalent	Auto, ISO 100, ISO 200, ISO 400, ISO 800, ISO 1600, ISO 3200		

Flash	
Mode	Auto, Red-eye, Fill in, Slow Sync, Off, Red-eye Fix
Range	<ul style="list-style-type: none"> • Wide: 11.81-133.07 in. (0.3–3.38 m) (ISO Auto) • Tele: 19.69-59.45 in. (0.5–1.51 m) (ISO Auto)
Recharging time	Approximately 4 sec.
Shake reduction	
Optical Image Stabilization (OIS)	
Effect	
Photo Shooting mode	<ul style="list-style-type: none"> • Photo Filter (Smart Filter): Miniature, Vignetting, Ink Painting, Oil Painting, Cartoon, Cross Filter, Sketch, Soft Focus, Fish-eye, Classic, Retro, Zooming Shot • Image Adjust: Sharpness, Contrast, Saturation
Video Shooting mode	Movie Filter (Smart Filter): Miniature, Vignetting, Sketch, Fish-eye, Classic, Retro, Palette Effect 1, Palette Effect 2, Palette Effect 3, Palette Effect 4
White Balance	
Auto WB, Daylight, Cloudy, Fluorescent_H, Fluorescent_L, Tungsten, Custom Set, Color Temp.	
Date Imprinting	
Date & Time, Date, Off	

Shooting	
Photos	<ul style="list-style-type: none"> • Modes: Smart Auto (Portrait, Night Portrait, Backlight Portrait, Night, Backlight, Landscape, White, Natural Green, Blue Sky, Sunset, Macro, Macro text, Macro Color, Tripod, Action, Fireworks, Candle, Spotlight, Spotlight (Macro), Spotlight (Portrait)), Program, Aperture Priority, Shutter Priority, Manual, Smart (Beauty Face, Continuous Shot, Landscape, Macro, Action Freeze, Rich Tones, Panorama, Waterfall, Silhouette, Sunset, Low Light Shot, Fireworks, Light Trace), Best Face, Magic Plus (My Magic Frame, Split Shot, Motion Photo, Photo Filter) • Burst: Single, Continuous (3 fps), Continuous (8 fps), AE Bracket • Timer: Off, 10 Sec, 2 Sec
Videos	<ul style="list-style-type: none"> • Modes: Smart Scene Detection (Landscape, Blue Sky, Natural Green, Sunset), Magic Plus (Movie Filter) • Format: MP4 (H.264) (Max recording time: 20 min) • Size: 1920 X 1080, 1280 X 720, 640 X 480, 320 X 240, 240 Web • Frame Rate: 30 fps • Sound Alive: Sound Alive On, Sound Alive Off, Mute • Capturing during recording • OIS: On, Off • Video editing (embedded): Pause during recording, Still image capture

Playback	
Photos	<ul style="list-style-type: none"> Type: Single image, Thumbnails, Multi Slide Show with Music and Effect, Movie clip, Smart Album* * Smart Album category: All, Date, File Type Edit: Resize, Rotate, Smart Filter, Crop Effect: Image Adjust (Brightness, Contrast, Saturation, ACB, Face Retouch, Red-eye Fix), Smart Filter (Normal, Miniature, Vignetting, Ink Painting, Oil Painting, Cartoon, Cross Filter, Sketch, Soft Focus, Fish-eye, Classic, Retro, Zooming Shot)
Videos	Edit: Still image capture, Time trimming
Storage	
Media	<ul style="list-style-type: none"> Internal memory: Approximately 9.5 MB External memory (Optional): SD card (2 GB guaranteed), SDHC card (up to 32 GB guaranteed), SDXC card (up to 64 GB guaranteed) Internal memory capacity may not match these specifications.
File format	<ul style="list-style-type: none"> Still Image: JPEG (DCF), EXIF 2.21 Movie Clip: MP4 (Video: MPEG-4.AVC/H.264, Audio: AAC)

Image size	Icon	Size
		4320 X 3240
	4320 X 2880	
	4320 X 2432	
	3648 X 2736	
	2832 X 2832	
	2592 X 1944	
	1984 X 1488	
	1920 X 1080	
	1024 X 768	

Wireless network

MobileLink, Remote Viewfinder, SNS & Cloud, Email, S/W Upgrade Notifier, AllShare Play, Auto Backup, AutoShare

Interface

Digital output connector	USB 2.0
Audio input/output	Internal speaker (Mono), Microphone (Mono)
Video output	A/V: NTSC, PAL (selectable)
DC power input connector	5.0 V

Power source

Rechargeable battery	Lithium-ion battery (SLB-10A, 1,030 mAh)
Connector type	Micro USB (5 pin)

The power source may differ depending on your region.

Dimensions (W X H X D)

4.18 X 2.43 X 0.85 in. (106.05 X 61.65 X 21.65 mm) (without protrusions)

Weight

6.49 oz (184 g) (without battery and memory card)

Operating Temperature

0–40 °C (32–104 °F)

Operating Humidity

5–85 %

Software

i-Launcher

Specifications may change without notice to improve performance.

Glossary

ACB (Auto Contrast Balance)

This feature automatically improves the contrast of your images when the subject is backlit or when there is a high contrast between your subject and the background.

AEB (Auto Exposure Bracket)

This feature automatically captures several images at different exposures to help you capture a properly-exposed image.

AF (Auto Focus)

A system that automatically focuses the camera lens on the subject. Your camera uses the contrast to focus automatically.

Aperture

The aperture controls the amount of light that reaches the camera's sensor.

Camera shake (Blur)

If the camera is moved while the shutter is open, the entire image may appear blurred. This occurs more often when the shutter speed is slow. Prevent camera shake by raising the sensitivity, using the flash, or using a faster shutter speed. Alternately, use a tripod, the DIS or OIS function to stabilize the camera.

Composition

Composition in photography means arranging objects in a photo. Usually, abiding by the rule of thirds leads to a good composition.

DCF (Design rule for Camera File system)

A specification to define a file format and file system for digital cameras created by the Japan Electronics and Information Technology Industries Association (JEITA).

Depth of field

The distance between the nearest and farthest points that can be acceptably focused in a photograph. Depth of field varies with lens aperture, focal length, and distance from the camera to the subject. Selecting a smaller aperture, for example, will increase the depth of field and blur the background of a composition.

Digital zoom

A feature that artificially increases the amount of zoom available with a zoom lens (Optical zoom). When using the Digital zoom, the image quality will deteriorate as the magnification increases.

EV Compensation

All the combinations of the camera's shutter speed and lens aperture that result in the same exposure.

EV (Exposure Value)

This feature allows you to quickly adjust the exposure value measured by the camera, in limited increments, to improve the exposure of your photos. Set the EV compensation to -1.0 EV to adjust the value one step darker and 1.0 EV to one step brighter.

Exif (Exchangeable Image File Format)

A specification to define an image file format for digital cameras created by the Japan Electronic Industries Development Association (JEIDA).

Exposure

The amount of light allowed to reach the camera's sensor. Exposure is controlled by a combination of the shutter speed, the aperture value, and ISO sensitivity.

Flash

A speed light that helps to create adequate exposure in low-light conditions.

Focal length

The distance from the middle of the lens to its focal point (in millimeters). Longer focal lengths result in narrower angles of view and the subject is magnified. Shorter focal lengths result in wider angles of view.

Histogram

A graphical representation of the brightness of an image. The horizontal axis represents the brightness and the vertical axis represents the number of pixels. High points at the left (too dark) and right (too bright) on the histogram indicate a photo that is improperly exposed.

H.264/MPEG-4

A high-compression video format established by international standard organizations ISO-IEC and ITU-T and developed by the Joint Video Team (JVT). This codec is capable of providing good video quality at low bit rates.

Image sensor

The physical part of a digital camera that contains a photosite for each pixel in the image. Each photosite records the brightness of the light that strikes it during an exposure. Common sensor types are CCD (Charge-coupled Device) and CMOS (Complementary Metal Oxide Semiconductor).

ISO sensitivity

The sensitivity of the camera to light, based on the equivalent film speed used in a film camera. At higher ISO sensitivity settings, the camera uses a higher shutter speed, which can reduce blur caused by camera shake and low light. However, images with high sensitivity are more susceptible to noise.

JPEG (Joint Photographic Experts Group)

A lossy method of compression for digital images. JPEG images are compressed to reduce their overall file size with minimal deterioration of the image resolution.

LCD (Liquid Crystal Display)

A visual display commonly used in consumer electronics. This display needs a separate backlight, such as CCFL or LED, to reproduce colors.

Macro

This feature allows you to capture close-up photos of very small objects. When using the macro feature, the camera can maintain a sharp focus on small objects at a near life-size ratio (1:1).

Metering

The metering refers to the way in which the camera measures the quantity of light to set the exposure.

MJPEG (Motion JPEG)

A video format which is compressed as a JPEG image.

Noise

Misinterpreted pixels in a digital image that may appear as misplaced or random, bright pixels. Noise usually occurs when photos are shot with a high sensitivity or when a sensitivity is automatically set in a dark place.

OIS (Optical Image Stabilization)

This feature compensates in real-time for shaking and vibrating while shooting. There is no image degradation compared to Digital Image Stabilization feature.

Optical zoom

This is a general zoom which can enlarge images with a lens and does not degrade the quality of images.

Quality

An expression of the rate of compression used in a digital image. Higher quality images have a lower rate of compression, which usually results in a larger file size.

Resolution

The number of pixels present in a digital image. High resolution images contain more pixels and typically show more detail than low resolution images.

Shutter speed

Shutter speed refers to the amount of time it takes to open and close the shutter, and it is an important factor in the brightness of a photo, as it controls the amount of light which passes through the aperture before it reaches the image sensor. A fast shutter speed allows less time to let light in and the photo becomes darker and more easily freezes subjects in motion.

Vignetting

A reduction of an image's brightness or saturation at the periphery (outer edges) compared to the center of the image. Vignetting can draw interest to subjects positioned in the center of an image.

White balance (color balance)

An adjustment of the intensities of colors (typically the primary colors red, green, and blue), in an image. The goal of adjusting the white balance, or color balance, is to correctly render the colors in an image.



**Correct Disposal of This Product
Waste Electrical & Electronic Equipment)**

(Applicable in countries with separate collection systems)

This marking on the product, accessories or literature indicates that the product and its electronic accessories (e.g. charger, headset, USB cable) should not be disposed of with other household waste at the end of their working life. To prevent possible harm to the environment or human health from uncontrolled waste disposal, please separate these items from other types of waste and recycle them responsibly to promote the sustainable reuse of material resources.

Household users should contact either the retailer where they purchased this product, or their local government office, for details of where and how they can take these items for environmentally safe recycling.

Business users should contact their supplier and check the terms and conditions of the purchase contract. This product and its electronic accessories should not be mixed with other commercial wastes for disposal.



PlanetFirst represents Samsung Electronics' commitment to sustainable development and social responsibility through eco-driven business and management activities.



Correct disposal of batteries in this product

(Applicable in countries with separate collection systems)

This marking on the battery, manual or packaging indicates that the batteries in this product should not be disposed of with other household waste at the end of their working life. Where marked, the chemical symbols Hg, Cd or Pb indicate that the battery contains mercury, cadmium or lead above the reference levels in EC Directive 2006/66. If batteries are not properly disposed of, these substances can cause harm to human health or the environment.

To protect natural resources and to promote material reuse, please separate batteries from other types of waste and recycle them through your local, free battery return system.

Index

A

AF-assist light

- Location 20
- Settings 135

AF Sound 132

AllShare Play 126

Aperture Priority mode 46

Aperture value 45

Auto Backup 119

Auto Contrast Balance (ACB)

- Playback mode 98
- Shooting mode 78

AutoShare 118

A/V port 20

B

Battery

- Caution 145
- Charging 24
- Inserting 23

Best face mode 52

Blink Detection 75

Brightness

- Playback mode 98
- Shooting mode 77

C

Camera maintenance 139

Camera specifications 151

Capturing an image from video 95

Charging 24

Cleaning

- Camera body 139
- Display 139
- Lens 139

Connecting to your Mac computer 102

Contrast

- Playback mode 98
- Shooting mode 84

D

Date/Time Set 134

Deleting files 90

Digital zoom 36

DIRECT LINK button 22

Disconnecting the camera 102

Display brightness 133

Display type 33

E

Editing photos 96

Editing videos

- Capturing 95
- Trimming 95

Enlarging 92

Error messages 137

Exposure 77

F

Face Detection 74

Flash

- Auto 66
- Fill in 66
- Off 66
- Red-eye 66
- Red-eye Fix 67
- Slow Sync 67

Focus area

- Center AF 71
- Multi AF 71

Formatting 135

Function button 22

G

Guide Line 132

H

Half-press shutter 39

I

Icons

- Playback mode 87
- Shooting mode 27

Image Adjustment

Brightness

- Playback mode 99
- Shooting mode 77

Contrast

- Playback mode 99
- Shooting mode 84

Red-eye 99

Saturation

- Playback mode 99
- Shooting mode 84

Sharpness 84

Imprint 135

Intelli zoom 37

ISO sensitivity 68

L

Language settings 134

M

Macro

- Auto Macro 70
- Macro 70
- Manual Focus 70

Magic Plus mode

- Motion Photo 56
- Movie Filter 58
- My Magic Frame 53
- Photo Filter 57
- Split Shot 55

Manual mode 48

Memory card

- Caution 143
- Insert 23

Menu button 22

Metering

- Center-weighted 78
- Multi 78
- Spot 78

MobileLink 115

Mode dial 21

Movie mode 59

O

One touch shooting 73

Optical Image Stabilization (OIS) 38

Optional accessories 19

P

Panorama mode 50

Playback button 22

Playback mode 87

Power button 20

Power save mode 133

Program mode 44

Protecting files 90

Q

Quick view 133

R

Red-eye

Playback mode 99

Shooting mode 65

Remote Viewfinder 116

Reset 135

Resolution

Playback mode 96

Shooting mode 63

Retouching faces 99

Rotating 96

S

Saturation

Playback mode 99

Shooting mode 84

Self portrait 74

Service center 148

Settings 134

Sharpness 84

Shooting portraits

Blink Detection 75

Face Detection 74

Self portrait 74

Smile Shot 75

Shutter button 20

Shutter Priority mode 47

Slide show 93

Smart Album 89

Smart Auto mode 42

Smart Filter

Photo shooting mode 57

Playback mode 97

Video recording mode 58

Smart mode 49

Smart Scene Detection mode 60

Smile Shot 75

Sound settings 34

Start Image 132

Status lamp 21

T

Thumbnails 90

Timer 83

Time settings 25

Time zone settings 25, 134

Touch screen

Dragging 32

Flicking 32

Touching 32

Tracking AF 72

Transferring files

Auto Backup 119

Email 121

Mac 102

Windows 101

Tripod mount 20

U

Unpacking 19

USB port 20

V

Video

Playback mode 94

Shooting mode 59

Video out 133

Viewing files

Animated photos 93

Folder 88

Panoramic photos 93

Slide show 93

Smart Album 89

Thumbnails 90

TV 100

W

Website

Accessing 124

Uploading photos or videos 124

White Balance 79

Wireless network 111

Z

Zoom

Using the zoom 36

Zoom button 21

Zoom sound settings 85



Please refer to the warranty that came with your product or visit our website, www.samsung.com, for after-sales service or inquiries.

CE 0678