



SR20H9050U
SR20H9030U

POWERbot

user manual

- * Before operating this unit, please read the instructions carefully.
- * For indoor use only.

English

imagine the possibilities

Thank you for purchasing a Samsung product.

SAMSUNG

Contents

03 Safety information

08 Installation

Accessories / Installation note

10 Charging

Automatic charging / Recharging / Low battery (Lo)

12 Installing the Virtual guard

Part name of the Virtual guard / Inserting batteries

14 Using POWERbot

Turning the power on/off / Using Auto clean mode / Using the cleaning modes / Recharging

16 Using the remote control

Power/Recharging / Cleaning mode / Additional function / Direction control / Point cleaning

18 Name of each part

Top / Bottom / Display panel

19 Setting time/schedule

Setting the time / Setting the schedule

20 Cleaning and maintaining

Cleaning the dustbin / Cleaning the sensors and the camera / Cleaning the Power brush / Cleaning the Driving wheel

22 Notes and cautions

Charging / In use / Cleaning and maintenance / About battery / About the IrDA sensor

24 Error codes

25 Troubleshooting

26 Open Source Announcement

27 Specifications

Safety information

SAFETY INFORMATION



- Before operating the appliance, please read this manual thoroughly and retain it for your reference.



- Because these following operating instructions cover various models, the characteristics of your vacuum cleaner may differ slightly from those described in this manual.

CAUTION/WARNING SYMBOLS USED



Indicates that a danger of death or serious injury exists.



Indicates that a risk of personal injury or material damage exists.

OTHER SYMBOLS USED



Indicates that a risk of personal injury or material damage exists.

Safety information

IMPORTANT SAFETY INSTRUCTIONS

When using an electrical appliance, basic precautions should be observed, including the following:

READ ALL INSTRUCTIONS BEFORE USING YOUR POWERbot.

Unplug from outlet when not in use and before conducting maintenance.

WARNING: to reduce the risk of fire, electric shock, or injury:

GENERAL

- Use only as described in this manual.
- Do not operate POWERbot or charger (station) if it has been damaged in any way.
- If the vacuum cleaner is not working as it should, has been dropped, damaged, left outdoors, or dropped in water, return it to a customer care center.
- Do not handle the charger (station) or POWERbot with wet hands.
- Use only on dry, indoor surfaces.
- This appliance can be used by children aged from 8 years and above and persons with reduced physical, sensory or mental capabilities or lack of experience and knowledge if they have been given supervision or instruction concerning use of the appliance in a safe way and understand the hazards involved.
- Children shall not play with the appliance. Cleaning and user maintenance shall not be made by children without supervision.

BATTERY Charger (station)

- Do not modify the polarized plug to fit a non-polarized outlet or extension cord.
- Do not use outdoors or on wet surfaces.
- Unplug the charger (station) from the outlet when not in use and before servicing.
- Use only the charger (station) supplied by the manufacturer to recharge.
- Do not use with a damaged cord or plug or a loose power outlet.
- Do not pull or carry by the cord, use the cord as a handle, close the door on the cord, or pull the cord around sharp edges or corners. Keep the cord away from heated surfaces.
- Do not use extension cords or outlets with inadequate current carrying capacity.
- Do not unplug by pulling on the cord. To unplug, grasp the plug, not the cord.
- Do not mutilate or incinerate batteries as they will explode at high temperatures.
- Do not attempt to open the charger (station). Repairs should only be carried out by a qualified customer care center.
- Do not expose the charger (station) to high temperatures or allow moisture or humidity of any kind to come into contact with the charger (station).

POWERbot

- Do not pick up hard or sharp objects such as glass, nails, screws, coins, and etc.
- Do not use without a filter in place. When servicing the unit, never put fingers or other objects into the fan chamber in case the unit accidentally turns on.
- Do not put any objects into openings. Do not use with any openings blocked; keep openings free of dust, lint, hair, and anything that may reduce air flow.
- Do not pick up toxic materials (chlorine bleach, ammonia, drain cleaner, etc.).
- Do not pick up anything that is burning or smoke, such as cigarettes, matches, or hot ashes.
- Do not use to pick up flammable or combustible liquids such as gasoline, nor use on areas where they may be present.
- Locations with candles or desk lamps on the floor.
- Locations with unattended fires (fire or embers).
- Locations with distilled alcohol, thinner, ashtrays with burning cigarettes, etc.
- Do not use POWERbot in an enclosed space filled with vapours given off by oil based paint, paint thinner, moth proofing substances, flammable dust, or other explosive or toxic vapours.
- Leaks from battery cells can occur under extreme usage or temperature conditions. If the liquid gets on skin, wash quickly with water. If the liquid gets into the eyes, flush them immediately with clean water for a minimum of 10 minutes. Seek medical attention.

Safety information

WARNING Power related

- ▶ Please prevent any risk of electric shock or fire.
 - Do not damage the power cord.
 - Do not pull the power cord too hard or touch the power plug with wet hands.
 - Do not use a power source other than 100-240 V~ and also do not use a multi outlet to supply power to number of devices at the same time. (Do not leave the cord carelessly on the floor.)
 - Do not use a damaged power plug, power cord or loose power outlet.
- ▶ Clean dust or any foreign matters on the pin and contact part of the power plug.
 - There is a risk of electric shock or malfunction.

WARNING Before use

- ▶ Do not use POWERbot near combustible materials.
 - Place near candle, desktop lamps, fireplace or near combustible materials such as gasoline, alcohol, thinners etc.
- ▶ The POWERbot is intended for household use therefore do not use it in an attic, basement, storage, industrial building, out of indoor space, places with moisture (such as bathroom, laundry), on the table or shelves.
 - The POWERbot can be damaged or malfunction.
- ▶ Install the Virtual guard in front of dangerous areas (such as stairs or railings) to prevent damaging the product or getting injured.
 - For your safety, always keep the cliff sensor clean.
- ▶ Be sure POWERbot does not pass through or touch any kind of liquids.
 - The POWERbot can be severely damaged and it may contaminate other areas if the wheels pass through liquid.

- ▶ Do not spill any liquids on the charger.
 - There is a risk of fire or electric shock.
- ▶ Do not use the charger for anything other than its intended purpose.
 - There is a risk of fire or severe damage to the charger.
- ▶ Always keep the cliff sensor clean for your safety.

WARNING In use

- ▶ If any abnormal sounds, smells or smoke come from POWERbot, immediately shut off the emergency switch at the bottom of POWERbot and contact a service center.

WARNING Cleaning and maintenance

- ▶ When power cord is damaged, contact a service center to get it replaced by certified repairman.
 - There is a risk of fire or electric shock.
- ▶ Please check with a Samsung Electronics service center when exchanging batteries.
 - Using batteries from other products can cause malfunction.

**CAUTION****Before use**

- ▶ Insert the dustbin before using POWERbot.
- ▶ Open room doors before cleaning in order to have all rooms cleaned and install a Virtual guard in front of entryway, balconies, bathrooms, or other areas where POWERbot may fall.
- ▶ Be careful with the followings for proper automatic recharging.
 - Always turn on the power of the charger.
 - Install the charger where POWERbot can easily find.
 - Do not leave any object in front of the charger.
- ▶ When installing the charger, do not leave the cord carelessly on the floor since POWERbot may get tangled by it.
- ▶ Do not use POWERbot on black colored floors.
 - The POWERbot may not be able to operate normally.
- ▶ Do not pick up POWERbot by the dustbin holder.
- ▶ Do not place any objects within 0.5 m to both sides and 1 m to the front of the charger.
- ▶ Make sure the charger's charging contact is not damaged or have any foreign matters on it.
- ▶ Do not install the charger in an area with a dark floor.
 - If the floor around the charger is dark, recharging is hindered.
- ▶ Move any obstacles that may disturb POWERbot's movement (such as children's indoor swing or slides) before cleaning.

**CAUTION****In use**

- ▶ Using POWERbot on thick carpet may damage both POWERbot and the carpet.
 - The POWERbot cannot pass over carpet that is thicker than 1 cm.
- ▶ Do not use POWERbot on tables or other high surfaces.
 - There is a risk of damage if it falls.
- ▶ The POWERbot may bump into chair, desk legs therefore move them away for faster and efficient cleaning.
- ▶ When POWERbot is operating, do not lift it up or carry it to another area.
- ▶ Do not hold by driving wheels of POWERbot when carrying it to another area.
- ▶ Do not put any objects on top of POWERbot since it may cause malfunction.
- ▶ Remove any large papers or plastic bags immediately when using POWERbot since they may block the intake.
- ▶ Do not aim the red pointer directly at people or animals.

**CAUTION****Cleaning and maintenance**

- ▶ Prevent any damage to POWERbot by complying the followings.
 - Do not clean POWERbot by spraying water directly onto it or use benzene, thinner, acetone or alcohol to clean it.
- ▶ Do not disassemble or repair POWERbot. This should only be done by a certified repairman.
- ▶ Always keep the obstacle sensor and cliff sensor clean.
 - If foreign matter accumulates, sensors may malfunction.

Installation

Power of the charger must be on at all times.

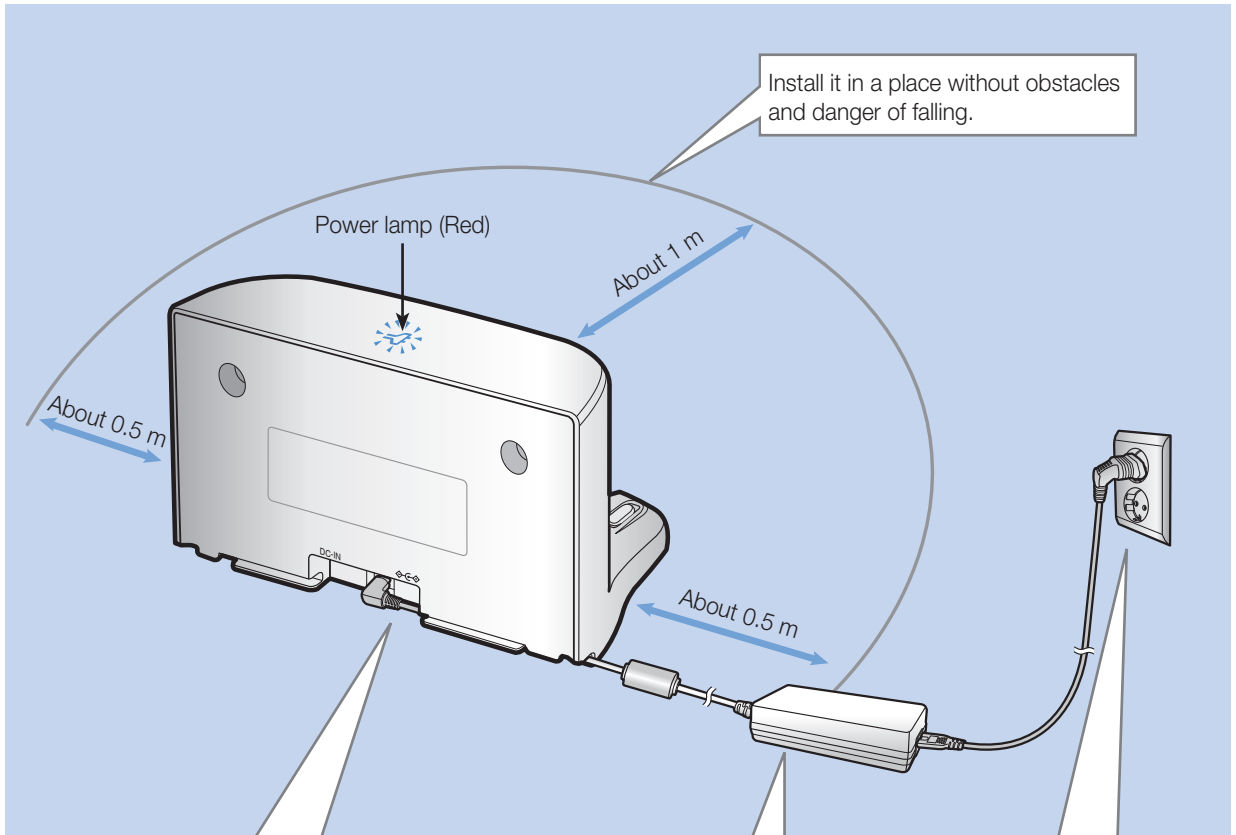

Install it in a place without obstacles and danger of falling.

Power lamp (Red)

About 1 m

About 0.5 m

About 0.5 m

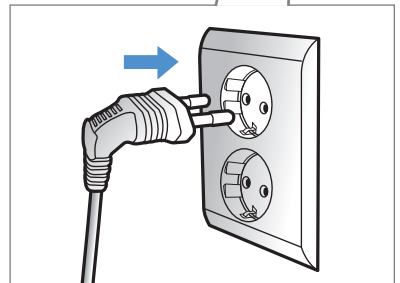
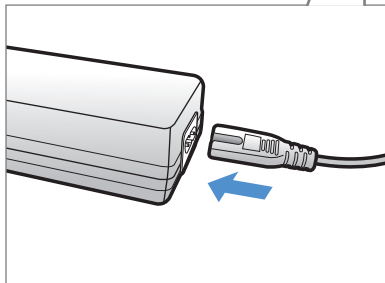
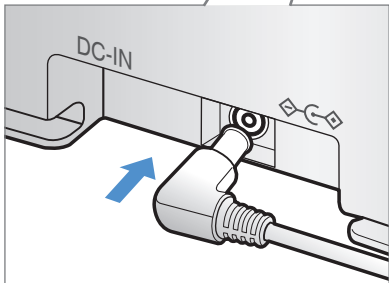

1 Connect the adapter jack to the charger





2 Connect the power cord to the adapter

3 Connect the power plug to the outlet

When using the adapter, the side with the sticker attached must face down.

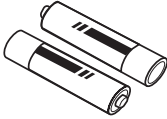
Power lamp (Red) will turn on.

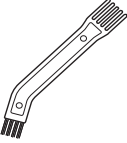
Accessories

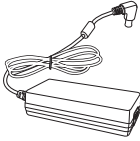
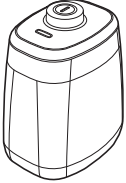
			
Remote control	Batteries (AAA type)	User manual/Quick guide	Spare filter
			
Cleaning brush	Power cord	Adapter	Virtual guard

Installation note

Note

- ▶ Install charger in a place where the floor and wall are level.
- ▶ It is best to install the charger along the grain of wooden floors.
- ▶ If the emergency switch is off, POWERbot will not charge even if it is docked on the charger.
- ▶ Always turn on the power of the charger.
 - If power is not supplied to the charger, POWERbot cannot find it and cannot automatically recharge.
 - If POWERbot is left detached from the charger, the battery will drain naturally.
- ▶ If POWERbot is in energy-saving mode, power will not come on even if the emergency switch is turned off and then on. Press and hold the [Start/Stop] button on POWERbot.

Charging

It takes approximately 160 minutes to completely charge when charging for the first time after purchase and can be used for approximately 60 minutes.



• Rated input voltage of this product is 100-240 V~.

Charging lamp during charging (green)

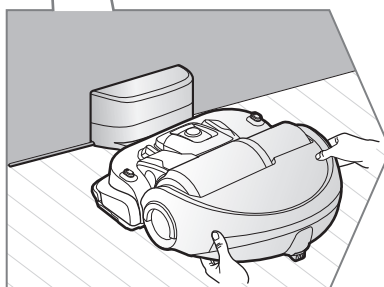
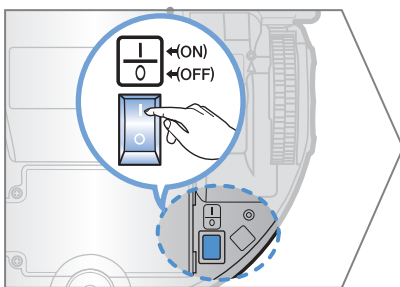
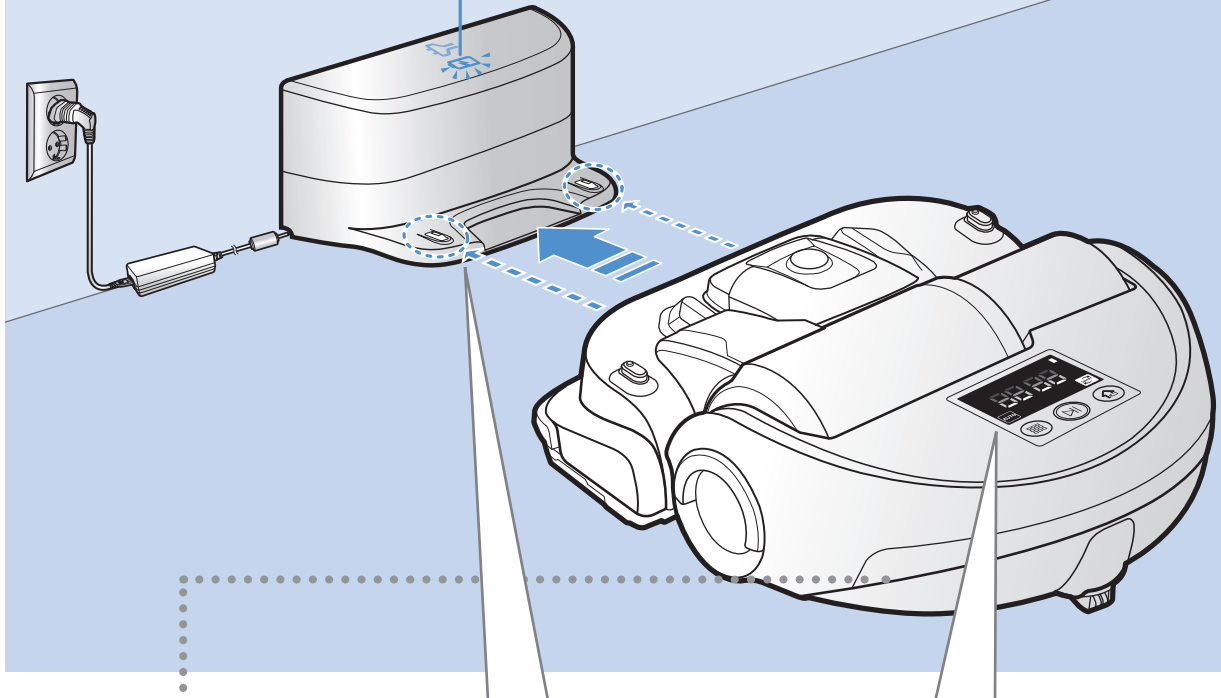

1 Turn on the emergency switch on the bottom

You must turn on the emergency switch to turn on POWERbot.

2 Manually charge POWERbot by placing it on the charger

Make sure charge pins of POWERbot and the charger is aligned.

3 Check the charging status

"**00:00**" will turn on according to charging progress and "FULL" will turn on when charging is complete.

Automatic charging

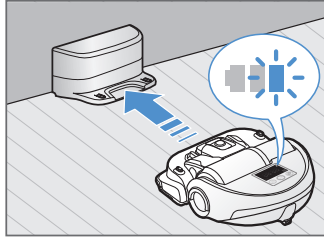

When the battery indicator blinks during cleaning, POWERbot will return to the charger to charge itself automatically.

Recharging



You may command POWERbot to recharge at the charger while it is in cleaning process.

Low battery (Lo)

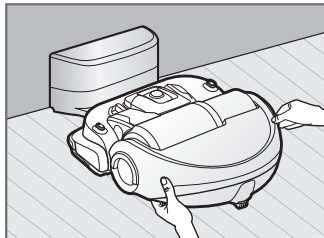

Manually charge POWERbot by placing it on the charger.

Steps to take if recharging is not being executed

Check the installation status of the charger when:

- ▶ charger is located in a place where POWERbot cannot easily access
- ▶ distance of the charger and POWERbot is over 5 m apart
 - It may take a long time for POWERbot to return to the charger for recharging

Manually charge POWERbot when:

- ▶ charger is located in a corner
- ▶ battery is fully exhausted
- ▶ POWERbot is stuck by obstacles (furniture etc.)
- ▶ POWERbot can't climb threshold near charger (Height of the threshold that POWERbot can climb: about 1.5 cm and below)
- ▶ when battery indicator blinks and "Lo" is displayed
- ▶ when POWERbot is set on Spot clean or Manual clean mode

Installing the Virtual guard

Infrared ray from the Virtual guard will restrict POWERbot from approaching certain area.

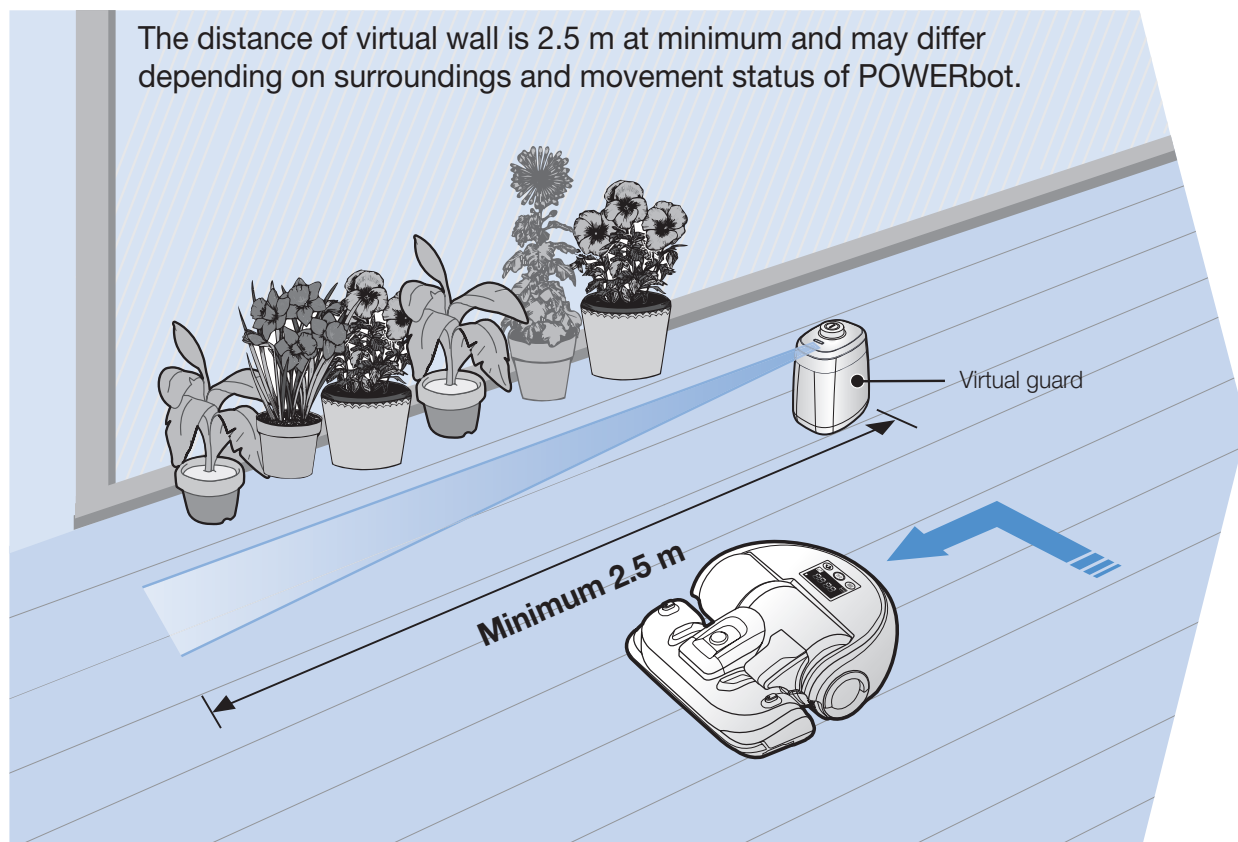

1 Press the Power button to turn it on

Power lamp (Red) will blink.

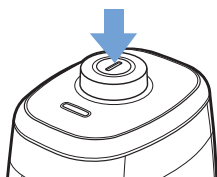

2 Install the Virtual guard where you want to restrict POWERbot's entrance

Make sure that distance sensor is facing at the desired direction you want to create a invisible barrier (which will restrict POWERbot's approach).

Part name of the Virtual guard

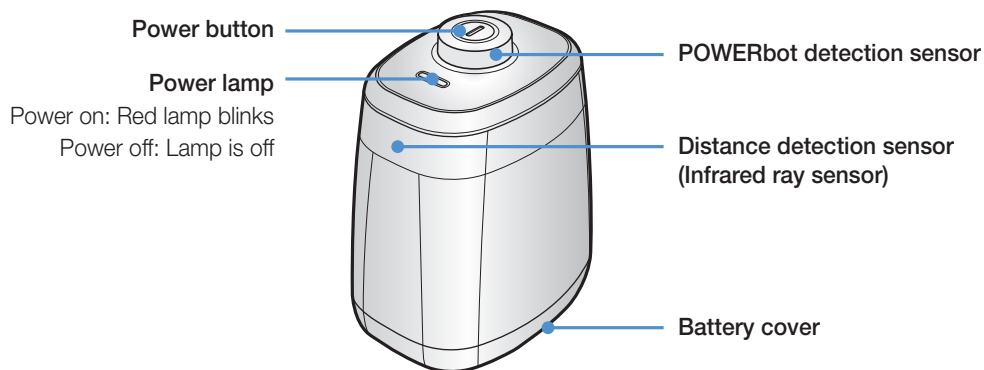

Inserting batteries

Batteries for Virtual guard must be purchased separately.

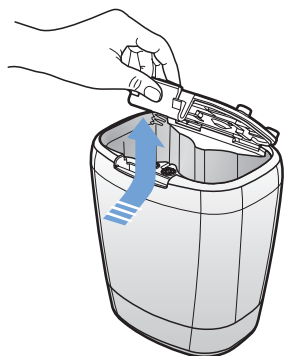

1 Open the battery cover of the Virtual guard by pressing the locking tab and lift it up.

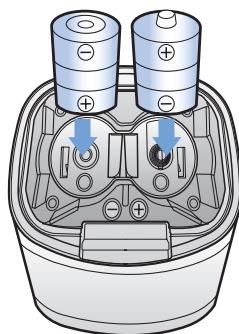

2 Insert the alkaline batteries (D type) as shown in the illustration (check the +, - polarity).

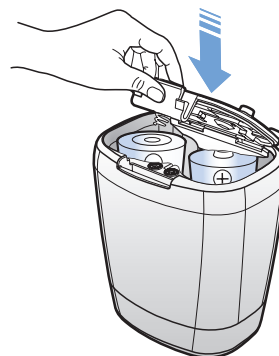

3 Insert the tip of the cover into the slot and push the other end to close the battery cover.

* Specification: type D (LR20) batteries

Using POWERbot

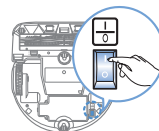

You must turn on the emergency switch before using POWERbot.

Turning the power on/off

Press the  button for more than 3 seconds



- When POWERbot is not used for 30 minutes, power will turn off automatically.
- You can turn on the power only by using the buttons on POWERbot.

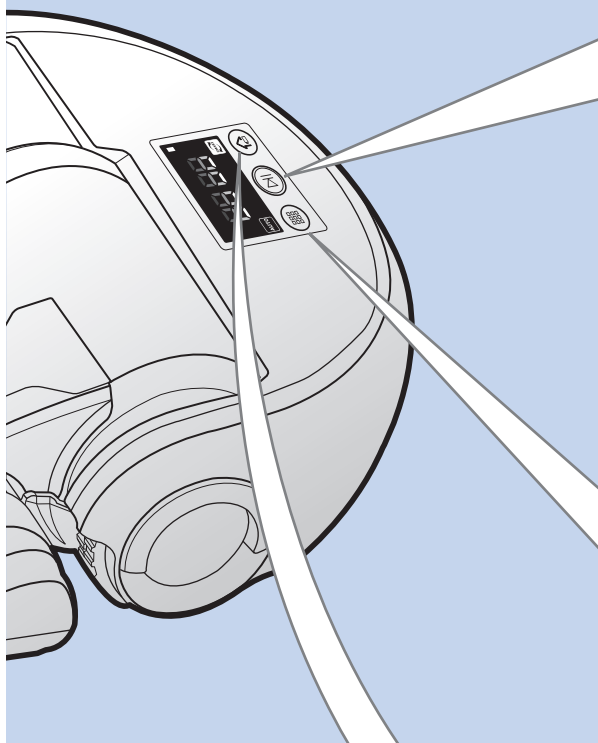

Using Auto clean mode

The POWERbot moves and cleans automatically until it cleans entire space once.



* Stop cleaning: Press the  button shortly

Using the cleaning modes

You can select the desired cleaning mode.

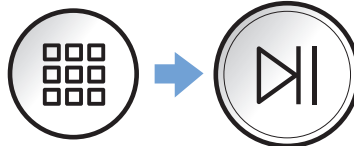







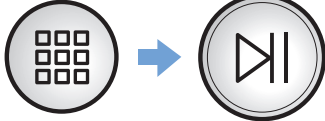

Recharging

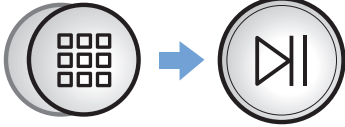
You may command POWERbot to recharge at the charger automatically while it is in cleaning process.

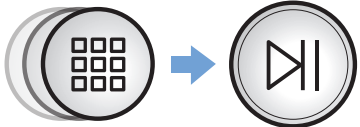

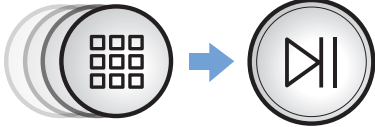
Selecting cleaning mode

Cleaning mode	How to select	Displayed icon
Auto clean	Press once 	
Spot clean	Press twice 	
Max clean	Press 3 times 	
Manual clean	Press 4 times  * Direction control can be done only by the remote control.	

* When POWERbot is being charged, you can only select the Auto clean or Max clean mode.

* When cleaning is done within 15 minutes in Auto clean mode, the cleaner will repeat cleaning one more time.

Cleaning method for each modes

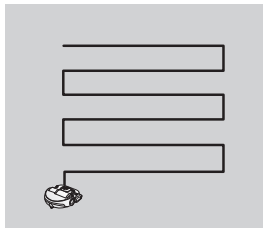

Auto clean

Cleans automatically until entire space is cleaned once.

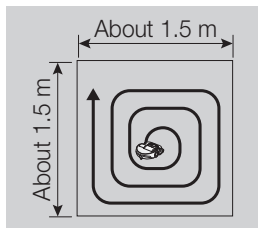

Spot clean

Cleans a localized area intensely. It can be used to clean bread or cookie crumbs.

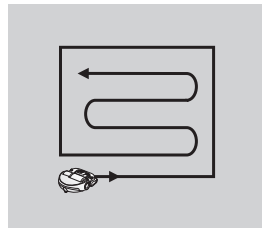

Max clean

Cleans until the battery is depleted.

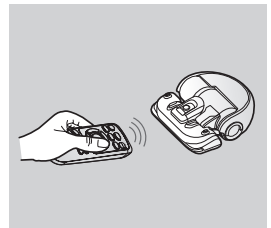





Manual clean











You can move POWERbot with the remote control to clean the desired spot.

Using the remote control







1 Power/Recharging

	[A Type]	[B Type]	
Power			Turn POWERbot's power on/off
Recharging			Select to recharge POWERbot at the charger while it is in cleaning process

2 Cleaning mode

Auto clean			Select to automatically clean the entire space once
Spot clean			Select to clean a localized area intensely
Max clean			Select to make POWERbot to clean until battery indicator flashes after reaching down to one level
Manual clean			Select to manually control and clean by using the remote control
Start/Stop			Select to start or stop cleaning process

3 Additional function

Silence mode			Select to clean with lower operation noise * Turbo mode is not available
Dust sensor mode			In Auto clean mode ▶ When dust intake is detected, suction of POWERbot will become stronger and it will move around that area to focuses on cleaning the surrounding area. In Spot/Max/Manual clean ▶ When dust intake is detected, suction of POWERbot will become stronger.
Sound			Each time you press this button, Sound Effects → Mute is selected in this sequence. * Remote control function NOT supported.

Inserting batteries

Open the battery cover by lifting it up while pressing the locking tab and insert the batteries as shown in the illustration. Then, close the cover until it clicks into place.

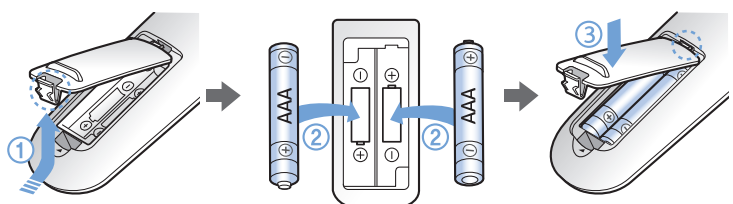

[A Type]

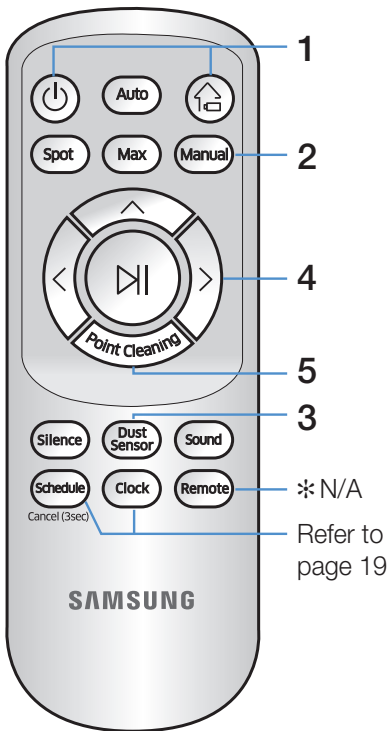

[B Type]

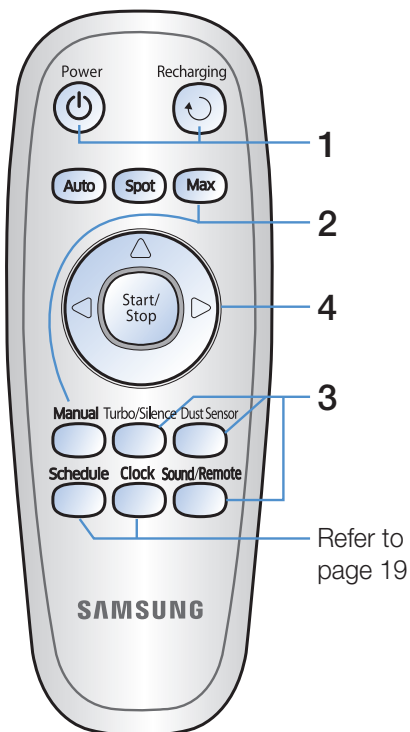

4 Direction control

[A Type]	[B Type]	
		Select to move forward
		Select to turn left
		Select to turn right

* Moving backward is not available

5 Point cleaning

- Only available in A type remote control

You can use the remote control to point and clean the desired spot while POWERbot is in cleaning process.

Point the red light on the floor within 50 cm around POWERbot's location.

Press and hold the Point cleaning button to move the red light to the desired spot. The POWERbot will follow the light while cleaning.

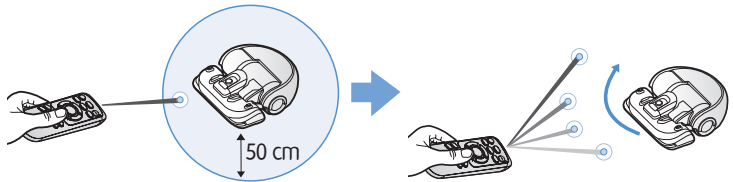

Operating distance of the remote control

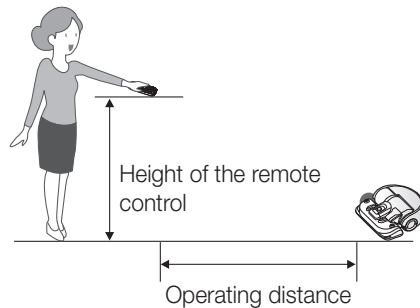

Height of the remote control	0.5 m	1 m	1.5 m
Operating distance	About 1.5 m	About 2 m	About 3 m

Name of each part

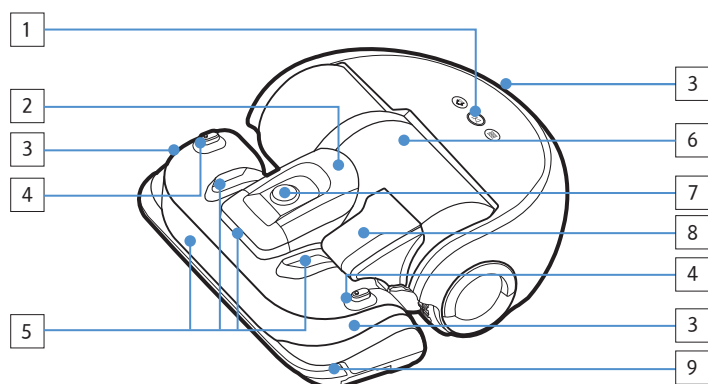

Top

1. Display panel
2. Dustbin holder
3. Remote control signal receiver
4. Virtual guard sensor
5. Obstacle sensor
6. Dustbin
7. Camera
8. Dustbin handle
9. Bumper sensor

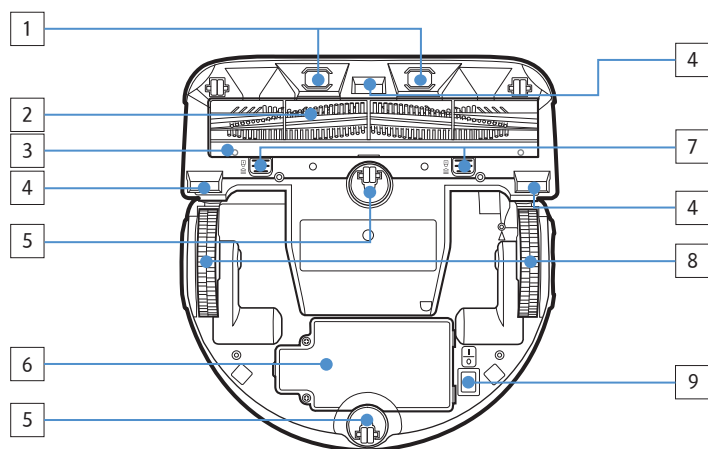

Bottom

1. Charge pins
2. Power brush
3. Power brush cover
4. Cliff sensor
5. Roller
6. Battery cover
7. Power brush cover button
8. Driving wheel
9. Emergency switch

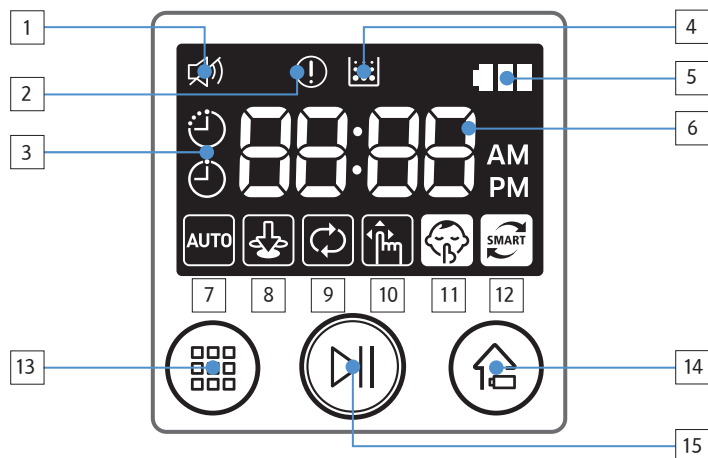

Display panel

1. Mute
2. Error indicator (Refer to page 24)
3. One-time/Daily schedule
4. Filter inspection
5. Battery indicator
6. Number display
7. Auto clean
8. Spot clean
9. Max clean
10. Manual clean
11. Silence mode
12. Dust sensor mode
13. Cleaning mode button
14. Recharging button
15. Start/Stop button

Setting time/schedule

B type remote control's , ,  buttons works in same manner as A type remote control.

Setting the time

You must set the current time before using the One-time/daily schedule.

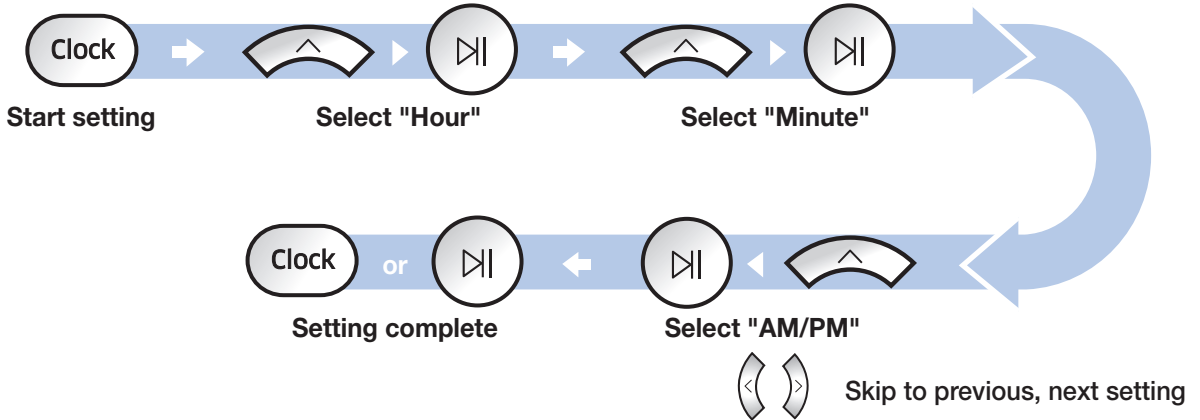

Setting the schedule

Setting/cancelling the schedule can only be done while POWERbot is docked on the charger.

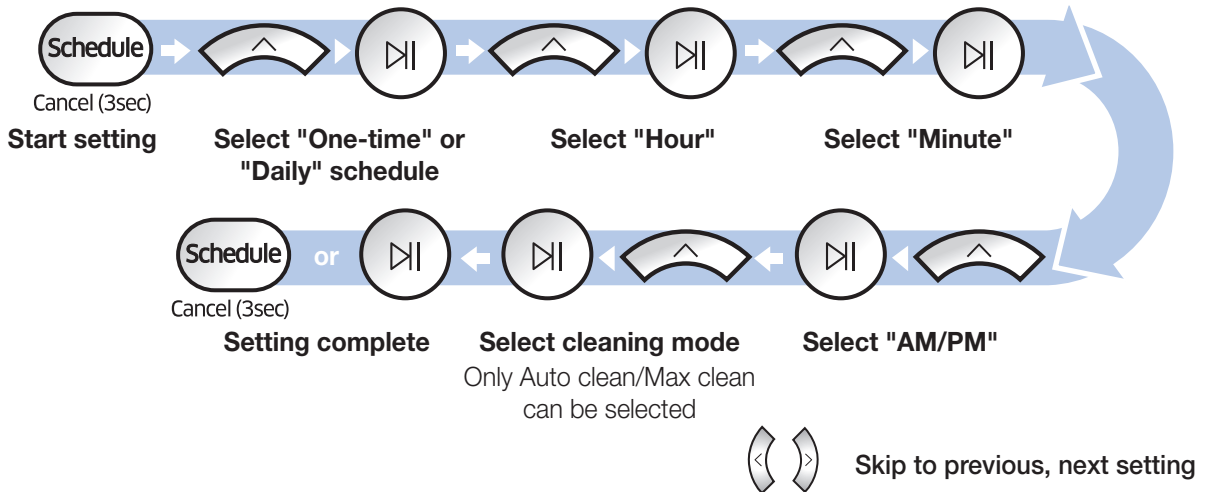





Cancelling during setup



▶ Setting will be canceled automatically when there's no input for 1 minute.

Cancelling One-time/Daily schedule

When both One-time/ Daily schedule is set	 →  →  Cancel (3sec) Press for 3 sec. Select the schedule Cancel complete
When either one of One-time or Daily schedule is set	 Cancel (3sec) Press for 3 sec.

Cleaning and maintaining

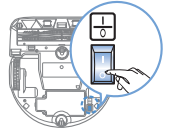

You must turn off the emergency switch before cleaning POWERbot.

Cleaning the dustbin

Clean the dustbin when filter inspection indicator () turns on or if there's too much dust in the dustbin.

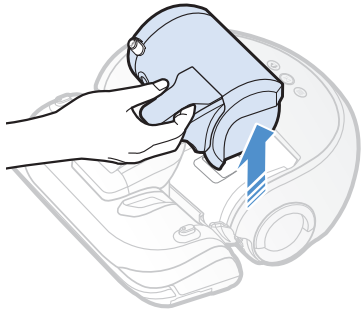

1 Remove the dustbin

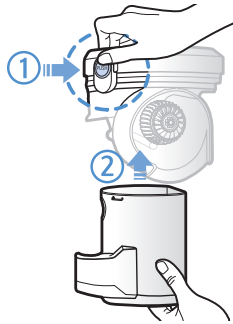

2 Remove the dustbin cover



3 Remove dust in the dustbin and cyclone unit

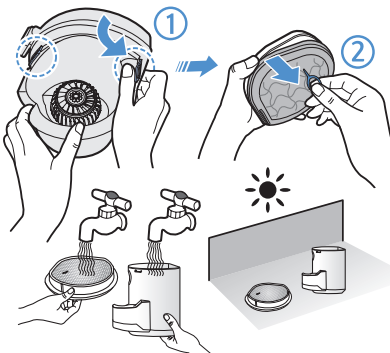

4 Detach the cyclone unit from the dustbin cover then wash the dustbin and the filter

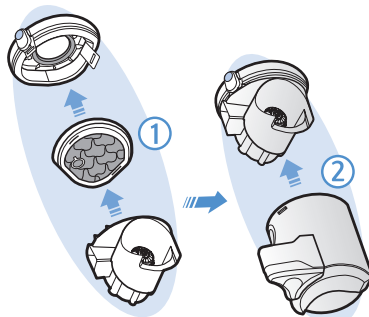

5 Reassemble the dustbin

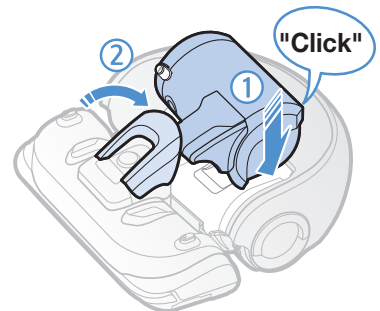

6 Reinsert the dustbin into the main body until it clicks

Cleaning the sensors and the camera

Lightly wipe with soft cloth.

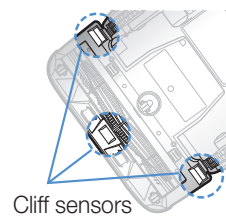
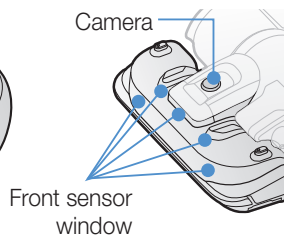
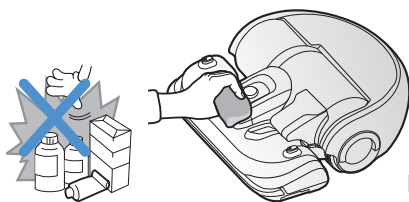

Cleaning the Power brush

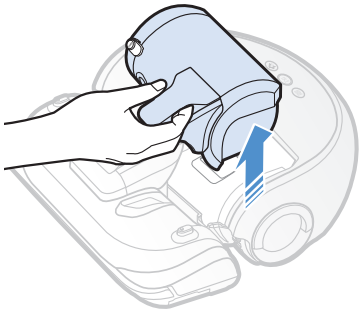

1 Remove the dustbin

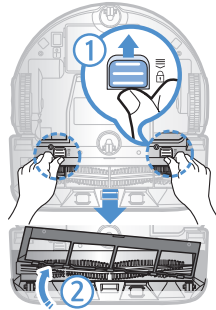

2 Remove the Power brush cover

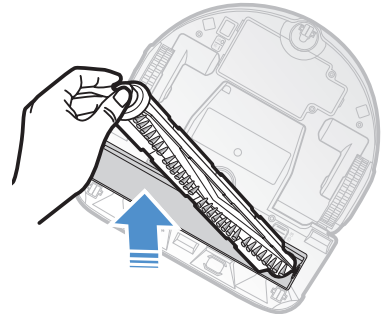

3 Remove the Power brush

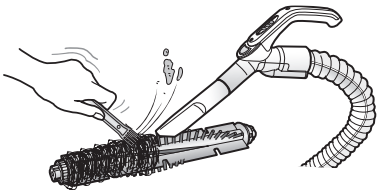

4 Clean the Power brush

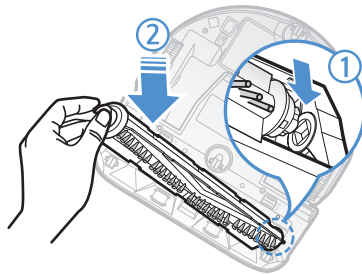

5 Reassemble the Power brush

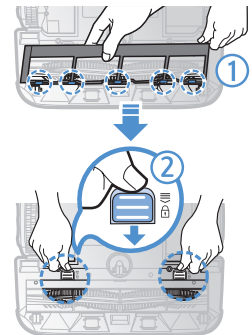

6 Reassemble the Power brush cover

Cleaning the Driving wheel

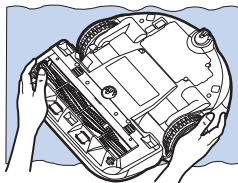

1 Put a soft cloth on the floor and place POWERbot upside-down.

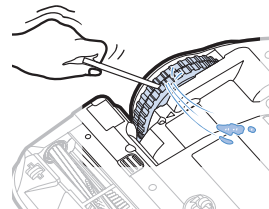

2 Use a blunt rod or tweezers to remove the foreign matters.

Notes and cautions

Charging

Note

- ▶ If the battery overheats during charging, it may take longer to charge.
- ▶ When automatic charging is not working, please check the followings.
 - Turn the emergency switch (on the bottom of POWERbot) off and on again.
 - Unplug the charger's power plug and then plug it back on.
 - Check whether there is any foreign matter in the charge pins and clean POWERbot and the charge pins of the charger with a dry cloth or rag.
 - Check for any obstacles such as reflective objects, chairs, etc. near the charger.
- ▶ If POWERbot is left detached from the charger, the battery will drain naturally.
 - Try to keep POWERbot being charged on the charger. (Turn off the emergency switch and leave the charger unplugged when planning to leave the house for long periods of time by going on a business trip or vacation, etc.,)

In use

Note

- ▶ The POWERbot may get caught on thresholds, etc. during cleaning.
 - To restart operation, shut off the emergency switch, move POWERbot to an area where it can move easily and then turn on the power again.
- ▶ The POWERbot cannot completely clean areas it cannot enter, such as corners, between the wall and sofa, etc.
 - Please use another cleaning tool to clean them regularly.

- ▶ The POWERbot cannot vacuum clumps of dirt, so some may remain on the floor after cleaning.
 - Please use another cleaning tool to clean them regularly.
- ▶ If POWERbot is turned off, power cannot be turned on by the [Power] button of the remote control. Press and hold the [Start/Stop] button on POWERbot.
- ▶ If the battery becomes low during Auto/Max clean mode, POWERbot will recharge and finish cleaning the remaining area after recharging. (Repeat cleaning frequency: 1 time)
- ▶ You cannot select and execute Max/Manual clean mode while charging.
- ▶ Do not unnecessarily move POWERbot or press buttons while it is in Auto/Max clean mode. It assumes that cleaning is complete and starts cleaning again from the beginning.

Cleaning and maintenance

Note

- ▶ If you washed the dustbin and filter with water
 - Dustbin: Completely wipe out the water.
 - Filter: Completely dry it in a shade before use.

Caution

- ▶ Watch your finger when attaching or detaching the filter, since they may get stuck in the dustbin's intake.
- ▶ To avoid blockages by foreign matter, do not let toothpicks, cotton swabs etc. from being vacuumed by POWERbot.
- ▶ If it is difficult to remove foreign matters from the Power brush, contact a service center.

- ▶ Since the power brush removes dirt from the floor during cleaning, foreign matters such as thread, long hair, etc. may get caught in it. Therefore check and clean it regularly.

About battery

Note

- ▶ Purchase batteries at service centers and check the genuine part symbol () and model name before purchasing.
- ▶ This battery is exclusive for Samsung Electronics POWERbot; do not use it for any other product.
- ▶ Do not disassemble or modify it.
- ▶ Do not throw the battery out in fire or heat it up.
- ▶ Do not connect any metallic object to the charging contacts (+, -).
- ▶ Store it in indoor (at 0 °C~40 °C).
- ▶ If the battery malfunctions, do not disassemble it yourself; contact your nearest service center.
- ▶ Battery charging time and usage time may decrease the more the battery is used. If the battery's lifespan has been exceeded, have it replaced at a service center.
- ▶ The battery warranty period is 6 months from the date of purchase.

About the IrDA sensor

Caution

- ▶ The infrared signal transmission may not be smooth in locations exposed to halogen lamps or in outdoor locations.
- ▶ The POWERbot uses 3 types of infrared devices and a device may not work in front of another device with a higher priority.
 - Infrared signal Priority: Remote control > Virtual guard > Charger
- ▶ When controlling POWERbot with the remote control, POWERbot may cross the invisible barrier set by the Virtual guard and enter the area you don't want it to enter, since remote control's signal has a higher priority.
- ▶ Different infrared signals may interfere with one another and cause malfunction to the devices if they are used together in a small space or in a close distance.
- ▶ Install the Virtual guard away from the charger as auto charging may be interrupted if the Virtual guard is near the charger.
- ▶ If more than one POWERbots are used simultaneously, they may malfunction due to interference of the infrared signals.

Error codes

1 Below error codes appear on the display panel

2 Turn off the emergency switch and check the below instructions and take appropriate action

3 Error code will disappear when you turn on the emergency switch

Error codes	Checklist
C 01	<p>Foreign matter caught in the Power brush.</p> <ul style="list-style-type: none"> ▶ Turn off the emergency switch and remove the foreign matter from the Power brush.
C 02	<p>Foreign matter caught in the left Driving wheel.</p> <ul style="list-style-type: none"> ▶ Turn off the emergency switch and remove the foreign matter from the Driving wheel.
C 03	<p>Foreign matter caught in the right Driving wheel.</p> <ul style="list-style-type: none"> ▶ Turn off the emergency switch and remove the foreign matter from the Driving wheel.
C 05	<p>Bumper sensor needs to be checked.</p> <ul style="list-style-type: none"> ▶ Turn off the emergency switch and turn it back on. ▶ When error code does not disappear, check if there's any small foreign matter between the bumper and the main body. If there is, pull the bumper slightly and remove the foreign matter.
C 06	<p>Foreign matter accumulated on the obstacle sensor.</p> <ul style="list-style-type: none"> ▶ Turn off the emergency switch and clean the front and rear sensor with a soft cloth.
C 07	<p>Foreign matter accumulated on the cliff sensor.</p> <ul style="list-style-type: none"> ▶ Turn off the emergency switch and clean the cliff sensor with a soft cloth.
no batt	<p>Battery malfunction or wire disconnected.</p> <ul style="list-style-type: none"> ▶ Turn off the emergency switch and turn it back on. ▶ Contact a service center if error code does not disappear.

Troubleshooting

Symptom	Checklist
<p>The POWERbot is not working at all.</p>	<ul style="list-style-type: none"> ▶ Check if the emergency switch is on. ▶ Check if all the icons are displayed on display panel. ▶ Check if the battery of POWERbot is depleted. <ul style="list-style-type: none"> - When "Lo" is displayed, carry POWERbot to the charger to charge it. ▶ Replace the batteries (AAA type) when the remote controller is not working.
<p>The POWERbot is stopped during cleaning process.</p>	<ul style="list-style-type: none"> ▶ When "Lo" is displayed on the display panel, carry POWERbot to the charger to charge it. ▶ When POWERbot is stuck by the obstacles such as cord, threshold etc, pick it up to remove it from the obstacle. <ul style="list-style-type: none"> - If any fabrics or strings are caught in the drive wheel, turn off the emergency switch and remove the fabrics or strings before using it again.
<p>Suction power is weak.</p>	<ul style="list-style-type: none"> ▶ If the "Filter inspection indicator" is on, turn off the emergency switch and clean the dustbin. ▶ When there's too much dust in the dustbin, suction power may get weakened. Turn off the emergency switch and empty the dustbin. ▶ If the intake (on bottom of POWERbot) is blocked by foreign matters, turn off the emergency switch and remove foreign matter from the intake. ▶ When noise suddenly increase, turn off the emergency switch and empty the dustbin.
<p>The POWERbot cannot find the charger.</p>	<ul style="list-style-type: none"> ▶ Check if there's power failure or whether the power plug is unplugged. ▶ Remove any obstacles around the charger that may disturb POWERbot from returning to the charger. ▶ When there's foreign matters on the charge pins that affects charging, clean the foreign matter.
<p>The POWERbot suddenly cleans diagonally.</p>	<ul style="list-style-type: none"> ▶ Check if the charger is installed along the grain of wooden floors or tiles. ▶ It may clean in diagonal direction for moving to another area in shortest route, or it made contact with any obstacles in that angle, or if it was charged at the charged at an angle, or grain of the wooden/tile floor is in that direction.
<p>Point cleaning is not working.</p>	<ul style="list-style-type: none"> ▶ If you point the red light directly on POWERbot, it may not move to desired direction. <ul style="list-style-type: none"> - Point the red light on the floor within 50 cm around POWERbot. ※ Do not use the point cleaning under direct sunlight, bright light or on dark floors.
<p>"Filter inspection indicator" is on even after the dustbin has been emptied.</p>	<ul style="list-style-type: none"> ▶ Use POWERbot after turning off the emergency switch and then turning it back on. ▶ Empty the dustbin again and re-clean the filter thoroughly.
<p>The POWERbot passes through the Virtual guard.</p>	<ul style="list-style-type: none"> ▶ If the batteries are depleted, replace them. (2 type D (LR20) batteries) ▶ If the lamp is off, check if the Virtual guard is turned off and turn it on.

Troubleshooting

Symptom	Checklist
The battery usage time of the Virtual guard is too short.	<ul style="list-style-type: none">▶ Check if you're using manganese drycell batteries and replace the batteries with new ones. (2 type D (LR20) batteries)
POWERbot moves around at the same place.	<ul style="list-style-type: none">▶ Check if Dust sensor mode is on.<ul style="list-style-type: none">- When POWERbot passes on a dusty area with Dust sensor mode on, it moves around that area to focus on cleaning. (Dust sensor mode can be turned on or off by the remote control. However, it will operate again if you turn off the emergency switch and then turn it back on.)▶ POWERbot moves around an area and the "DUST" is on the display panel even though there's no dust at the surrounding area.<ul style="list-style-type: none">- Check if foreign matters are caught between the dustbin and power brush and then remove them.

Open Source Announcement

The software included in this product contains open source software. You may obtain the complete corresponding source code for a period of three years after the last shipment of this product by sending an email to <mailto:oss.request@samsung.com>.

It is also possible to obtain the complete corresponding source code in a physical medium such as a CD-ROM; a minimal charge will be required.

The following URL <http://opensource.samsung.com/opensource/VR9000H/seq/0> leads to the download page of the source code made available and open source license information as related to this product. This offer is valid to anyone in receipt of this information.



Specifications

Classification	Item	Detail information
Mechanical specifications (POWERbot)	Size (Width x Height x Depth)	378 mm x 135 mm x 362 mm
	Weight	4.8 kg
	Sensor	Ceiling shape recognition (Visionary mapping plus TM)
	Button type of POWERbot	Touch type
Power specifications	Power voltage	100-240 V~, 50 Hz/60 Hz
	Power consumption	70 W
	Battery specifications	Lithium ion 21.6 V/ 84 Wh
Cleaning	Charging type	Automatic charging/Manual charging
	Cleaning mode	Auto, Spot, Max, Manual, One-time schedule, Daily schedule
	Charging time	Approximately 160 minutes
	Cleaning time	Approximately 60 minutes (Normal mode/ On the basis of hard floor)



If you have any questions or comments relating to Samsung products, please contact the SAMSUNG customer care center.

Country	Customer Care Center	Web Site
U.K	0330 SAMSUNG (7267864)	www.samsung.com
SOUTH AFRICA	0860 7267864 (SAMSUNG)	www.samsung.com
AUSTRALIA	1300 362 603	www.samsung.com
HONG KONG	(852) 3698-4698	www.samsung.com/hk www.samsung.com/hk_en/
MALAYSIA	1800-88-9999	www.samsung.com
SINGAPORE	1800-SAMSUNG (7267864)	www.samsung.com/ch_fr/ (French)



DJ68-00716C-03