

User Guide
22-inch clinical display

MDRC-2222 (option BL)
MDRC-2222 (option TS)
MDRC-2222 (option WP)

Barco NV

Beneluxpark 21, 8500 Kortrijk, Belgium

Phone: +32 56.23.32.11

Fax: +32 56.26.22.62

Support: www.barco.com/en/support

Visit us at the web: www.barco.com

Registered address: Barco NV

President Kennedypark 35, 8500 Kortrijk, Belgium

Phone: +32 56.23.32.11

Fax: +32 56.26.22.62

Support: www.barco.com/en/support

Visit us at the web: www.barco.com

TABLE OF CONTENTS

1. Welcome!	3
1.1 What's in the box	4
1.2 Product overview	4
2. Installation	7
2.1 Cable connections	7
2.2 Display position adjustment	8
2.3 VESA-mount installation	9
3. Operation	11
3.1 Recommendations for daily operation	11
3.2 Standby switching	12
3.3 OSD menu use	12
3.4 Power status LED	12
3.5 Control wheel locking/unlocking	12
3.6 Input source selection	13
3.7 Luminance adjustment	13
3.8 sRGB color space	13
3.9 QAWeb presets	14
3.10 Display functions	14
3.11 White point selection	15
3.12 Analog video settings	15
3.13 Power save mode	16
3.14 OSD menu language	16
3.15 OSD menu orientation	16
3.16 Factory reset	17
4. Maintenance	19
4.1 Scheduled maintenance	19
4.2 Cleaning	19
5. Important information	21
5.1 Safety information	21
5.2 Environmental information	23
5.3 Biological hazard and returns	25
5.4 Regulatory information	25
5.5 EMC notice	26
5.6 Explanation of symbols	29
5.7 Legal disclaimer	32
5.8 Technical specifications	32

1. WELCOME!

Introduction

Thank you for choosing this Eonis (MDRC-2222) display!

The 2 megapixel clinical display is built with healthcare specialists in mind. It combines consistent, high image quality and an attractive, versatile design with networked quality assurance.

The display comes in 3 versions:

- MDRC-2222 option BL: Black version
- MDRC-2222 option TS: Black version with protective capacitive antiglare touchscreen
- MDRC-2222 option WP: White version with protective antiglare screen

High image quality

The high-quality display presents sharp, bright images. The display's unique front consistency sensor automatically aligns the image quality every time the display is switched on. The image consistency makes collaboration between specialists easier. They can discuss images with colleagues at multiple locations, knowing that everyone is seeing identical images.

Centralized quality assurance

Eonis displays come complete with Barco's cloud-based MediCal QAWeb software, an online service for automated calibration, Quality Assurance and asset management. Praised in hospitals around the world, MediCal QAWeb allows healthcare IT and PACS administrators to centrally and remotely manage image quality across the healthcare organization, at the click of a button.

Smart design, fit for purpose

Barco's MDRC-2222 display features multiple mounting options and connections. The user-friendly height, tilt and pivot adjustments of the base allow the monitor to be positioned for maximum comfort to help ease the physical strains of a long work day.



CAUTION: Read all the important safety information before installing and operating your MDRC-2222. Please refer to the dedicated chapter in this user guide.

Warnings, cautions, notes and tips

There are four levels of precautionary or advisory statements that may be used in this user guide. In descending order of importance, they are:



WARNING: Describes hazards or dangers that might result in personal injury or death.



CAUTION: Describes hazards that could damage the product.



Gives additional information about the described subject.

1. Welcome!



Gives extra advice about the described subject.

1.1 What's in the box

Overview

- MDRC-2222 display
- 1x USB cable (2 m)
- 1x DisplayPort video cable (2 m)
- a set of AC power cords (depending on the region of operation)
- 1x user guide
- 1x CD containing MediCal QAWeb Agent and translated user guides



The user guide is available in other languages on www.barco.com/support



Keep your original packaging. It is designed for this display and is the ideal protection during transport and storage.

1.2 Product overview

Front

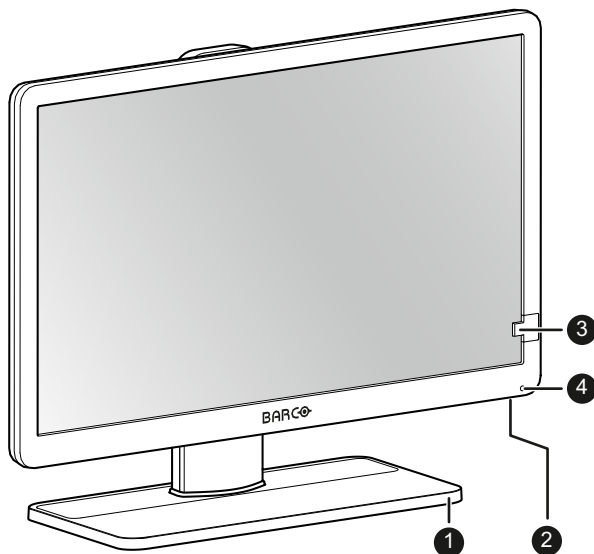

Image 1-1

1. Display stand
2. Control wheel
 - Push long (5 sec):
 - o to put display in standby mode
 - Push short:
 - o to exit standby mode
 - o to active the OSD menu
 - o to confirm selections in the OSD menu
 - Turn clockwise
 - o to scroll down in the OSD menu
 - o to increase values in the OSD menu
 - Turn counter clockwise
 - o to scroll up in the OSD menu
 - o to decrease values in the OSD menu
3. Front sensor
4. Power status LED
 - Off: Display not powered, or display is on but power LED function is disabled in OSD (see "Power status LED", page 12)
 - Steady green: Display operational
 - Blinking green: Display is entering standby mode
 - Steady orange: Display in standby mode

Back

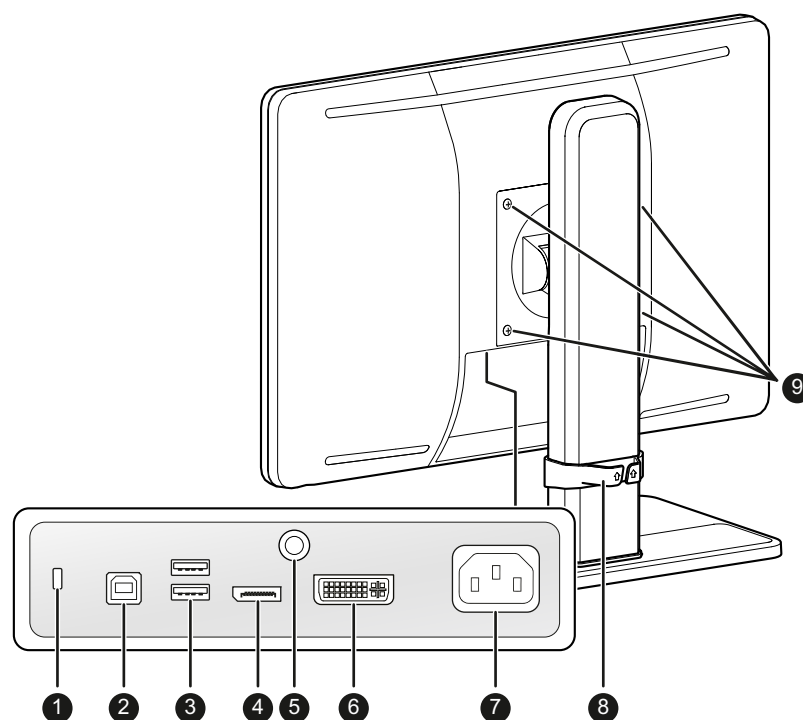

Image 1-2

1. *Welcome!*

1. Kensington security slot
2. USB-B 2.0 upstream connector
3. USB-A 2.0 downstream connectors (2x)
4. DisplayPort video input
5. Earth pin
6. DVI-I video input
7. 100 - 240 VAC mains power input (IEC C14)
8. Height-adjustable cable routing clip
9. VESA 100 mm mounting screw holes (4x)

2. INSTALLATION



WARNING: Read all the important safety information before installing and operating your monitor. Please refer to the dedicated chapter in this user guide.



WARNING: Sufficient expertise is required to install this equipment. All devices and complete setup must be tested before taking into operation.



CAUTION: When the display is assembled in the medical system, take care of the fixation of all cables, to avoid unwanted detachment.



CAUTION: The monitor is not intended to be sterilized.

2.1 Cable connections

To connect the cables

1. Connect one or more video source(s) to the corresponding video inputs. Use the appropriate video cable(s) to do this.
The input source to be displayed can be selected in the OSD menus (see "Input source selection", page 13).

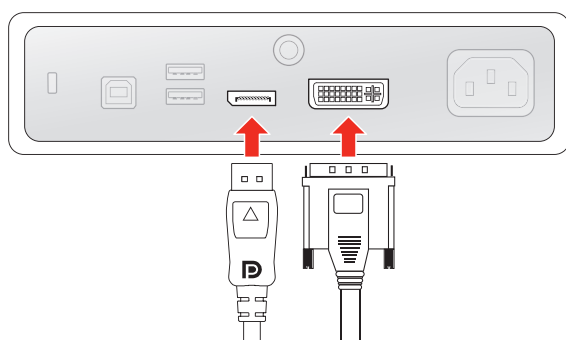

Image 2-1

2. Connect the USB upstream connector to a PC USB host to make use of QAWeb or any of the display USB downstream connectors (e.g. to connect a keyboard, mouse or other peripheral).

2. Installation



Image 2-2

3. Connect the mains power input to a **grounded** power outlet.

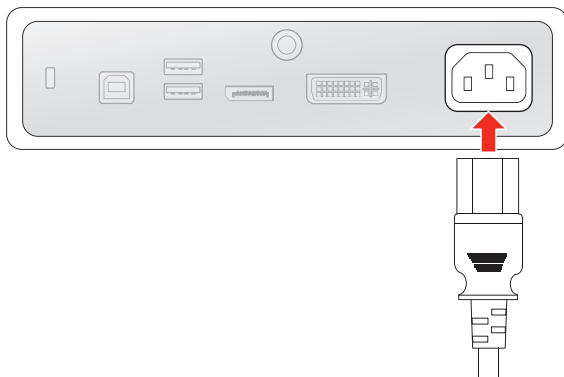

Image 2-3

4. If necessary for your application, earth the MDRC-2222 by connecting the earth pin to a grounded outlet by means of a yellow/green AWG18 wire (maximum admitted cable length according to national regulation requirements).

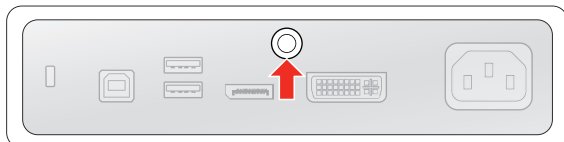

Image 2-4

5. Route all cables through the provided cable routing clip at the back of the display stand.

2.2 Display position adjustment

To adjust the display position

You can safely tilt, pivot, raise and lower the display as desired.

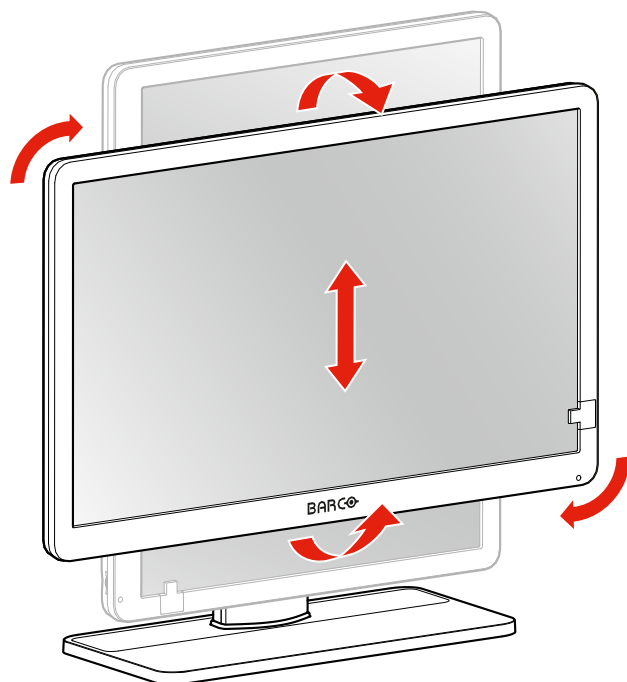

Image 2-5



WARNING: The display must be in its highest position before it can be properly pivoted.



The standard orientation of the video input is landscape. If you use the display in portrait mode, make sure you change the orientation of the video input via the screen settings of the computer.

2.3 VESA-mount installation

To mount the display on a VESA arm

The display panel, standard attached to the stand, is compatible with the VESA 100 mm standard.

2. Installation

1. Unscrew the four fixation screws to detach the panel from the stand.

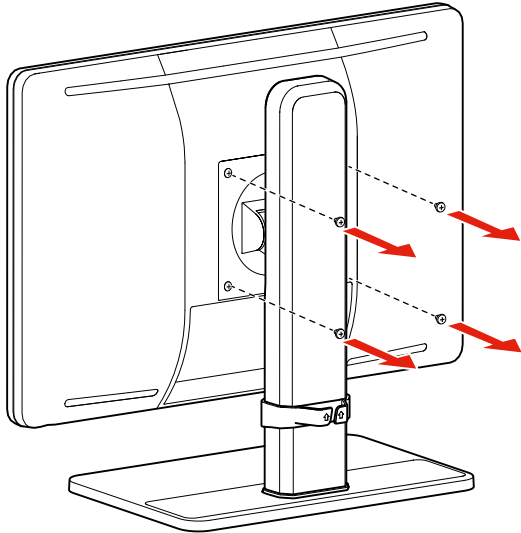

Image 2-6

2. Use 4 M4 screws to attach the panel to a VESA approved arm. Please respect the following rule to select an appropriate screw length:
 - $L_{\min} = T + W + 8 \text{ mm}$
 - $L_{\max} = T + W + 14 \text{ mm}$

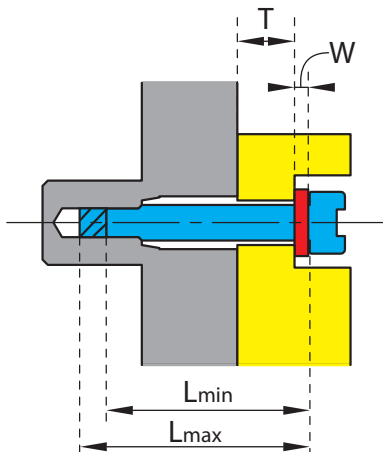

Image 2-7

3. OPERATION

3.1 Recommendations for daily operation

Optimize the lifetime of your display

Enabling the Display Power Management System (DPMS) of your display will optimize its lifetime by automatically switching off the backlight when the display is not used for a specified period of time. By default, DPMS is enabled on your display, but it also needs to be activated on your workstation. To do this, go to "Power Options Properties" in the "Control Panel".



Barco recommends setting DPMS activation after 20 minutes of non-usage.

Use a screen saver to avoid image retention

Prolonged operation of an LCD with the same content on the same screen area may result in a form of image retention.

You can avoid or significantly reduce the occurrence of this phenomenon by using a screen saver. You can activate a screen saver in the "Display properties" window of your workstation.



Barco recommends setting screen saver activation after 5 minutes of non-usage. A good screen saver displays moving content.

In case you are working with the same image or an application with static image elements for several hours continuously (so that the screen saver is not activated), change the image content regularly to avoid image retention of the static elements.

Understand pixel technology

LCD displays use technology based on pixels. As a normal tolerance in the manufacturing of the LCD, a limited number of these pixels may remain either dark or permanently lit, without affecting the performance of the product. To ensure optimal product quality, Barco applies strict selection criteria for its LCD panels.



To learn more about LCD technology and missing pixels, consult the dedicated white papers available at www.barco.com/healthcare.

Maximize quality assurance

QAWeb guarantees optimum and stabilized image quality in every private practice.

The front sensor on the MDRC-2222 works seamlessly with QAWeb to ensure a consistent image over time. It automatically stabilizes the image from the moment you switch on the display. What's more, QAWeb provides you with instant feedback on the status of the display.

3.2 Standby switching

About

- Push the control wheel long (5 sec) to put your display in standby mode
- Push the control wheel short (1 sec) to exit standby mode and activate your display

3.3 OSD menu use

To open the OSD menu

Shortly push the control wheel during normal operation to open the OSD menu. If the control wheel is locked, first unlock it as described in "Control wheel locking/unlocking", page 12.

The OSD main menu comes up in the left top of the screen. If no further actions are taken within the following 20 seconds, the OSD menu will disappear again (and the keyboard will lock if enabled).

To navigate the OSD menu

- Turn the control wheel (counter) clockwise to scroll through the different menu pages, to change values or to make selections.
- Push the control wheel to go into a submenu or confirm adjustments and selections.

3.4 Power status LED

Overview

The power status of the display is indicated by a LED at the front of the display. Below is an overview of the different LED color modes:

- Off: Not powered
- Steady green*: Operational
- Blinking green*: Entering standby mode
- Steady orange: In standby mode

* This default behavior can be changed so that the power status LED is also off when the display is operational or when entering standby mode.

To change the behavior of the power status LED

1. Bring up the OSD main menu.
2. Navigate to the *Adjustments > Settings* menu.
3. Enter the *Power Status LED* submenu.
4. Change the behavior of the power status LED as desired and confirm.

3.5 Control wheel locking/unlocking

About

To avoid unwanted or accidental activation of the control wheel, a lock mechanism can be enabled. This mechanism will lock the keyboard automatically, except while using the OSD menus.

To lock the control wheel

1. Bring up the OSD main menu.
2. Navigate to the *Adjustments > Settings > Keyboard lock* menu.
3. Switch the keyboard lock on or off.
4. Exit the OSD menu to activate the selected option.

To unlock the control wheel

During normal operation, turn and hold the control wheel **counter clockwise for 5 seconds**, until the *OSD unlocked* message appears.

3.6 Input source selection

About input source selection

The MDRC-2222 can have multiple video inputs connected. Switching between the different inputs can be done easily in the OSD menu.

To select the input source

1. Bring up the OSD main menu.
2. Navigate to the *Input selection* menu.
3. Select one of the available input sources and confirm.

3.7 Luminance adjustment

To adjust the luminance

1. Bring up the OSD main menu.
2. Navigate to the *Adjustments > Luminance* menu.
3. Set a luminance value as desired and confirm.

3.8 sRGB color space

About sRGB color space

The sRGB color space combines a display function and white point selection and is designed to match typical home and office viewing conditions. It is widely used in most computer applications.



When selecting *sRGB*, the *Display function* and *White point* selection options in the *Adjustments* menu will be disabled.

To select sRGB color space

1. Bring up the OSD main menu.
2. Navigate to the *Adjustments* menu.
3. Select *sRGB* and confirm.

3.9 QAWeb presets

About QAWeb presets

Display function, white point selection and ambient light conditions for your display can be applied from within the MediCal QAWeb application.



When selecting *QAWeb*, the *Display function* and *White point selection* options in the *Adjustments* menu will be disabled.

To select QAWeb presets

1. Bring up the OSD main menu.
2. Navigate to the *Adjustments* menu.
3. Select *QAWeb* and confirm.



The display USB upstream port must be connected to a PC with QAWeb installed on it before the QAWeb presets can be applied.

3.10 Display functions



Display function selection is disabled when *sRGB* or *QAWeb* are selected in the *Adjustments* menu.

About display functions

Native, uncorrected panels will display all grayscale/color levels with luminance increments that are not optimal for crucial diagnostic information. Studies have shown however, that in medical images certain grayscale/color parts contain more diagnostic information than others. To respond to these conclusions, display functions have been defined. These functions emphasize on these parts containing crucial diagnostic information by correcting the native panel behavior.

The available display functions for your MDRC-2222 are:

- *Native*: If you select Native, the native panel behavior will not be corrected.
- *Gamma 1.8* or *2.2*: Select one of these display functions in case the display is to replace a CRT display with a gamma of 1.8 or 2.2 respectively.
- *DICOM*: DICOM (Digital Imaging and Communications in Medicine) is an international standard that was developed to improve the quality and communication of digital images in radiology. In short, the DICOM display function results in more visible grayscales in the images. Barco recommends selecting the DICOM display function for most medical viewing applications.
The DICOM display function applies ambient light compensation (ALC) taking the ambient light conditions of your reading room into account. The available reading room options are:
 - *Darkroom*: Selects DICOM calibrated function, optimized for darkroom conditions (0 Lux)
 - *Office*: Selects DICOM function optimized for office conditions (60-180 Lux)
 - *Operation Room*: Selects DICOM function optimized for operating room conditions (300-400 Lux)



The settings of the display must be adapted to suit the requirements of the visualization software. In case of doubt, please contact the vendor of the visualization software.

To select a display function

1. Bring up the OSD main menu.
2. Navigate to the *Adjustments > Display function* menu.
3. Select one of the available display functions and confirm.

3.11 White point selection



White point selection is disabled when *sRGB* or *QAWeb* are selected in the *Adjustments* menu.

About white point selection

This setting allows you to modify the display white point, used as reference for all other colors to be displayed.

The available white point settings for your display are:

- *Native*: The native, unmodified color temperature of the LCD panel.
- *Bluebase*: Simulation of the bluebase film color temperature.
- *Clearbase*: Simulation of the clearbase film color temperature.
- *Programmable*: When selecting this setting, you will be able to manually adjust the video gain for the red, green and blue channel in separate submenus.

To select the white point

1. Bring up the OSD main menu.
2. Navigate to the *Adjustments > White point* menu.
3. Select one of the available white point presets.

3.12 Analog video settings



The following settings are only available when an analog video input source (DVI-A) is selected.

About analog video settings

When the analog video input source is active, a number of analog video settings becomes available:

- *Auto Adjust*: The analog video setting will automatically be adjusted
- *Geometry*: Allows to manually adjust the geometry settings of the analog video (clock frequency, clock phase, horizontal position, vertical position)
- *Level*: Allows to manually adjust the contrast and brightness levels of the analog video

To adjust the analog video settings

1. Bring up the OSD main menu.
2. Navigate to the *Adjustments > Analog* menu.
3. Adjust one of the available analog video settings as desired.

3.13 Power save mode

About power save mode

Enabling power save mode on your MDRC-2222 will optimize the display lifetime by automatically switching off the backlight when no video signal is detected after approximately 10 seconds.

To enable/disable power save mode

1. Bring up the OSD main menu.
2. Navigate to the *Adjustments > Settings* menu.
3. Enter the *Power save* submenu.
4. Select *On* or *Off* as desired and confirm.

3.14 OSD menu language

About the OSD menu language

By default, the OSD menu comes up in English. However, there's a wide range of other languages available for the OSD menu of your MDRC-2222.

To select the language of the OSD menu

1. Bring up the OSD main menu.
2. Navigate to the *Adjustments > Settings* menu.
3. Enter the *OSD Language* submenu.
4. Select one of the available languages.

3.15 OSD menu orientation

About the OSD menu orientation

The orientation of the OSD menu can be changed depending on the orientation of your display (landscape or portrait).

To change the orientation of the OSD menu

1. Bring up the OSD main menu.
2. Navigate to the *Adjustments > Settings* menu.
3. Enter the *OSD orientation* submenu.
4. Select *Landscape* or *Portrait* as desired and confirm.

3.16 Factory reset

About factory reset

A factory reset allows you to fully restore the display to its original factory setting.

To perform a factory reset

1. Bring up the OSD main menu.
2. Navigate to the *Adjustments > Settings* menu.
3. Enter the *Factory Reset* submenu.
4. Select *Yes* or *No* as desired and confirm.

3. Operation

4. MAINTENANCE

4.1 Scheduled maintenance

About

The MDRC-2222 does not require any scheduled maintenance or calibration activities. We recommend to use QAWeb with the Barco default tests and frequencies to calibrate and maintain the display, or to return the display to a Barco approved maintenance organization. In any case of doubts, please contact Barco Healthcare.

4.2 Cleaning



WARNING: Unplug the power cable from the mains power input before cleaning the display.



CAUTION: Take care not to damage or scratch the front glass or LCD. Be careful with rings or other jewelry and do not apply excessive pressure on the front glass or LCD.



CAUTION: Do not apply or spray liquid directly to the display as excess liquid may cause damage to internal electronics. Instead, apply the liquid to a cleaning cloth.

To clean the display

Clean the display using a sponge, cleaning cloth or soft tissue, lightly moistened with a recognized cleaning product for medical equipment. Read and follow all label instructions on the cleaning product. In case of doubt about a certain cleaning product, use plain water.

Possible cleaning solutions:

- 70% isopropyl alcohol
- 1.6% aqueous ammonia
- Cidex® (2.4% glutaraldehyde solution)
- Sodium hypochlorite (bleach) 10%
- “Green soap” (USP)
- 0.5% Chlorhexidine in 70% isopropyl alcohol
- Like Cleansafe® optical cleaning liquid

Do not use following products:

4. Maintenance

- Alcohol/solvents at higher concentration > 70%
- Strong alkalis lye, strong solvents
- Acid
- Detergents with fluoride
- Detergents with ammonia at higher concentration > 1.6%
- Detergents with abrasives
- Steel wool
- Sponge with abrasives
- Steel blades
- Cloth with steel thread

5. IMPORTANT INFORMATION

5.1 Safety information

General recommendations

Read the safety and operating instructions before operating the device.

Retain safety and operating instructions for future reference.

Adhere to all warnings on the device and in the operating instructions manual.

Follow all instructions for operation and use.

Electrical Shock or Fire Hazard

To prevent electric shock or fire hazard, do not remove cover.

No serviceable parts inside. Refer servicing to qualified personnel.

Do not expose this apparatus to rain or moisture.

Modifications to the unit

Do not modify this equipment without authorization of the manufacturer.

Type of protection (electrical):

Monitor with internal power supply: Class I equipment.

Degree of safety (flammable anesthetic mixture):

Equipment not suitable for use in the presence of a flammable anesthetic mixture with air or with oxygen or nitrous oxide.

The equipment shall not be operable when the air oxygen content is above 25%.

Non-patient care equipment

- Equipment primarily for use in a health care facility that is intended for use where contact with a patient is unlikely (no applied part).
- The equipment shall not be used with life support equipment.
- The user should not touch the equipment, nor its signal input ports (SIP)/signal output ports (SOP) and the patient at the same time.

Mission critical applications

We strongly recommend there is a replacement monitor immediately available in mission critical applications.

Use of electrical surgical knives

Provide as much distance as possible between the electrosurgical generator and other electronic equipment (such as monitors). An activated electrosurgical generator may cause interference with them and can disrupt the functionality of the display.

Power connection – Equipment with internal power supply

- This equipment must be earthed.
- Power requirements: The equipment must be powered by the AC mains voltage.
- The equipment is intended for continuous operation.

Transient over-voltage

To fully disengage the power to the device, please disconnect the power cord from the AC inlet.

Connections

Any external connection with other peripherals must follow the requirements of clause 16 of IEC60601-1 3rd. Ed. or Table BBB.201 of IEC 60601-1-1 for the medical electrical systems.

To maintain compliance with EMC Regulation, use only shielded interface cables for the connection to peripheral devices.

Power cords:

- Europe: H05VV-F or H05VVH2-F PVC cord with appropriate EU plug.
US and Canada: "hospital grade" cord-set has to be used, provided with instructions to indicate that grounding reliability can be achieved only when the equipment is connected to an equivalent receptacle marked hospital only or hospital grade. These instructions need to be marked either on the equip. or on a tag on the power cord
- Do not overload wall outlets and extension cords as this may result in fire or electric shock.
- Mains lead protection: Power cords should be routed so that they are not likely to be walked upon or pinched by items placed upon or against them, paying particular attention to cords at plugs and receptacles.
- The power supply cord should be replaced by the designated operator only at all time.
- Use a power cord that matches the voltage of the power outlet, which has been approved and complies with the safety standard of your particular country.

Grounding reliability

Grounding reliability can only be achieved when the equipment is connected to an equivalent receptacle.

Liquids and moisture

Never expose the monitor to liquids or moisture.

Never use the monitor near water - e.g. near a bathtub, washbasin, swimming pool, kitchen sink, laundry tub or in a wet basement.

The equipment is IP20 compliant.

Moisture condensation

Do not use monitor under rapid temperature and humidity change condition or avoid cold air from air-conditioning outlet directly.

Moisture may condense on the surface or inside of the unit, or create a mist residue inside the protection plate, this is not a malfunction of the product itself, although it may cause damage to the monitor.

If condensation happens, let the monitor stand unplugged until there is no condensation.

Ventilation

Do not cover or block any ventilation openings in the cover of the set. When installing the device in a cupboard or another enclosed location, heed the necessary space between the set and the sides of the cupboard.

Installation

Place the device on a flat, solid and stable surface that can support the weight of at least 3 devices. If you use an unstable cart or stand, the device may fall, causing serious injury to a child or adult, and serious damage to the device.

The display has been designed to be used in landscape and portrait position with a tilt of -5° to 22°.

When the equipment is attached to an arm, do not use the equipment as a handle or grip in order to move the equipment. Please refer to the instruction manual of the arm for instructions on how to move the arm with the equipment.

General warnings

- All devices and complete setup must be tested and validated before taking into operation.
- At end user application level it is necessary to foresee a backup unit in case the video falls away.

National Scandinavian Deviations for CL. 1.7.2

Finland: "Laitte on liitettävä suojamaadoituskoskettimilla varustettuun pistorasiaan"

Norway: "Apparatet må tilkoples jordet stikkontakt"

Sweden: "Apparaten skall anslutas till jordat uttag"



CAUTION: The enclosure has to be checked upon collision damage, refer to qualified service personnel.

5.2 Environmental information

Disposal Information

Waste Electrical and Electronic Equipment



■ This symbol on the product indicates that, under the European Directive 2012/19/EU governing waste from electrical and electronic equipment, this product must not be disposed of with other municipal waste. Please dispose of your waste equipment by handing it over to a designated collection point for the recycling of waste electrical and electronic equipment. To prevent possible harm to the environment or human health from uncontrolled waste disposal, please separate these items from other types of waste and recycle them responsibly to promote the sustainable reuse of material resources.

For more information about recycling of this product, please contact your local city office or your municipal waste disposal service.

For details, please visit the Barco website at: <http://www.barco.com/en/AboutBarco/weee>

Turkey RoHS compliance



■ Türkiye Cumhuriyeti: AEEE Yönetmeliğine Uygundur.

[Republic of Turkey: In conformity with the WEEE Regulation]

中国大陆 RoHS

Chinese Mainland RoHS

根据中国大陆《电器电子产品有害物质限制使用管理办法》(也称为中国大陆RoHS), 以下部分列出了Barco产品中可能包含的有毒和/或有害物质的名称和含量。中国大陆RoHS指令包含在中国信息产业部MCV标准:“电子信息产品中有毒物质的限量要求”中。

According to the “Management Methods for the Restriction of the Use of Hazardous Substances in Electrical and Electronic Products” (Also called RoHS of Chinese Mainland), the table below lists the names and contents of toxic and/or hazardous substances that Barco’s product may contain. The RoHS of Chinese

5. Important information

Mainland is included in the MCV standard of the Ministry of Information Industry of China, in the section "Limit Requirements of toxic substances in Electronic Information Products".

零件项目(名称) Component name	有毒有害物质或元素 Hazardous substances and elements					
	铅 Pb	汞 Hg	镉 Cd	六价铬 Cr6+	多溴联苯 PBB	多溴二苯醚 PBDE
印制电路配件 Printed Circuit Assemblies	x	o	o	o	o	o
液晶面板 LCD panel	x	o	o	o	o	o
外接电(线)缆 External Cables	x	o	o	o	o	o
内部线路 Internal wiring	o	o	o	o	o	o
金属外壳 Metal enclosure	o	o	o	o	o	o
塑胶外壳 Plastic enclosure	o	o	o	o	o	o
散热片(器) Heatsinks	o	o	o	o	o	o
电源供应器 Power Supply Unit	x	o	o	o	o	o
风扇 Fan	o	o	o	o	o	o
文件说明书 Paper Manuals	o	o	o	o	o	o
光盘说明书 CD manual	o	o	o	o	o	o

本表格依据SJ/T 11364的规定编制

This table is prepared in accordance with the provisions of SJ/T 11364.

o: 表示该有毒有害物质在该部件所有均质材料中的含量均在 GB/T 26572 标准规定的限量要求以下.

o: Indicates that this toxic or hazardous substance contained in all of the homogeneous materials for this part is below the limit requirement in GB/T 26572.

x: 表示该有毒有害物质至少在该部件的某一均质材料中的含量超出 GB/T 26572 标准规定的限量要求.

x: Indicates that this toxic or hazardous substance contained in at least one of the homogeneous materials used for this part is above the limit requirement in GB/T 26572.

在中国大陆销售的相应电子信息产品(EIP)都必须遵照中国大陆《电子电气产品有害物质限制使用标识要求》标准贴上环保使用期限(EFUP)标签。Barco产品所采用的EFUP标签(请参阅实例,徽标内部的编号使用于指定产品)基于中国大陆的《电子信息产品环保使用期限通则》标准。

All Electronic Information Products (EIP) that are sold within Chinese Mainland must comply with the "Marking for the restriction of the use of hazardous substances in electrical and electronic product" of Chinese Mainland, marked with the Environmental Friendly Use Period (EFUP) logo. The number inside the EFUP logo that Barco uses (please refer to the photo) is based on the "General guidelines of environment-friendly use period of electronic information products" of Chinese Mainland.



5.3 Biological hazard and returns

Overview

The structure and the specifications of this device as well as the materials used for manufacturing makes it easy to wipe and clean and therefore suitable to be used for various applications in hospitals and other medical environments, where procedures for frequent cleaning are specified.

However, normal use shall exclude biological contaminated environments, to prevent spreading of infections.

Therefore use of this device in such environments is at the exclusive risk of Customer. In case this device is used where potential biological contamination cannot be excluded.

Customer shall implement the decontamination process as defined in the latest edition of the ANSI/AAMI ST35 standard on each single failed Product that is returned for servicing, repair, reworking or failure investigation to Seller (or to the Authorized Service Provider). At least one adhesive yellow label shall be attached on the top site of the package of returned Product and accompanied by a declaration statement proving the Product has been successfully decontaminated.

Returned Products that are not provided with such external decontamination label, and/or whenever such declaration is missing, can be rejected by Seller (or by the Authorized Service Provider) and shipped back at Customer expenses.

5.4 Regulatory information

Indications for use

This display is intended to be used for viewing medical images by medical practitioners. This display is intended to be used in the near-patient environment, where the patients are conscious.

This display is not intended to be used for direct diagnosis and therapeutic interventional radiology.

FCC class B

This device complies with Part 15 of the FCC Rules. Operation is subject to the following two conditions: (1) this device may not cause harmful interference, and (2) this device must accept any interference received, including interference that may cause undesired operation.

This device has been tested and found to comply with the limits for a Class B digital device, pursuant to Part 15 of the FCC Rules. These limits are designed to provide reasonable protection against harmful interference in a residential installation. This device generates, uses and can radiate radio frequency energy and, if not installed and used in accordance with the instructions, may cause harmful interference to radio communications. However, there is no guarantee that interference will not occur in a particular installation. If this device does cause harmful interference to radio or television reception, which can be determined by turning the device off and on, the user is encouraged to try to correct the interference by one or more of the following measures:

- Reorient or relocate the receiving antenna.
- Increase the separation between the device and receiver.
- Connect the device into an outlet on a circuit different from that to which the receiver is connected.
- Consult the dealer or an experienced radio/TV technician for help.

5. Important information

Changes or modifications not expressly approved by the party responsible for compliance could void the user's authority to operate the equipment.

Canadian notice

CAN ICES-1/NMB-1

5.5 EMC notice

Electromagnetic emissions

The MDRC-2222 is intended for use in the electromagnetic environment (IEC 60601-1-2 4th edition) specified below. The customer or the user of the MDRC-2222 should assure that it is used in such an environment.

Emissions test	Compliance	Electromagnetic environment – Guidance
RF emissions CISPR 11	Group 1	The MDRC-2222 uses RF energy only for its internal function. Therefore, its RF emissions are very low and are not likely to cause any interference in nearby electronic equipment.
RF emissions CISPR 11	Class B	The MDRC-2222 is suitable for use in all establishments, including domestic establishments and those directly connected to the public low-voltage power supply network that supplies buildings used for domestic purposes.
Harmonic emissions IEC 61000-3-2	Not applicable: consumption less than 75W	
Voltage fluctuations/ flicker emissions IEC 61000-3-3	Complies	

This MDRC-2222 complies with appropriate medical EMC standards on emissions to, and interference from surrounding equipment. Operation is subject to the following two conditions: (1) this device may not cause harmful interference, and (2) this device must accept any interference received, including interference that may cause undesired operation.

Interference can be determined by turning the equipment off and on.

If this equipment does cause harmful interference to, or suffer from harmful interference of, surrounding equipment, the user is encouraged to try to correct the interference by one or more of the following measures:

- Reorient or relocate the receiving antenna or equipment.
- Increase the separation between the equipment and receiver.
- Connect the equipment into an outlet on a circuit different from that to which the receiver is connected.
- Consult the dealer or an experienced technician for help.

Electromagnetic immunity

The MDRC-2222 is intended for use in the electromagnetic environment (IEC 60601-1-2 4th edition) specified below. The customer or the user of the MDRC-2222 should assure that it is used in such an environment.

Immunity test	IEC 60601-1-2 4 th edition (2014) Test levels	Compliance level	Electromagnetic environment – guidance
Electrostatic discharge (ESD) IEC 61000-4-2	± 8kV contact ± 15kV air	± 8kV contact ± 15kV air	Floors should be wood, concrete or ceramic tile. If floors are covered with synthetic material, the relative humidity should be at least 30%
Electrical fast transient/burst IEC 61000-4-4	± 2kV for power supply lines ± 1kV for input/ output lines	± 2kV for power supply lines ± 1kV for input/ output lines	Mains power quality should be that of a typical commercial or hospital environment
Surge IEC 61000-4-5	± 1 kV line(s) to line(s) ± 2 kV line(s) to earth	± 1 kV line(s) to line(s) ± 2 kV line(s) to earth	Mains power quality should be that of a typical commercial or hospital environment
Voltage dips, short interruptions and voltage variations on power supply input lines IEC 61000-4-11	< 5% U_T ¹ (> 95% dip in U_T) for 0.5 cycle 40% U_T (60% dip in U_T) for 5 cycles 70% U_T (30% dip in U_T) for 25 cycles < 5% U_T (>95% dip in U_T) for 5s	< 5% U_T (> 95% dip in U_T) for 0.5 cycle 40% U_T (60% dip in U_T) for 5 cycles 70% U_T (30% dip in U_T) for 25 cycles < 5% U_T (>95% dip in U_T) for 5s	Mains power quality should be that of a typical commercial or hospital environment. If the user of the MDRC-2222 requires continued operation during power mains interruptions, it is recommended that the MDRC-2222 be powered from an uninterruptible power supply or a battery.
Power frequency (50/60 Hz) magnetic field IEC 61000-4-8	30 A/m	30 A/m	Power frequency magnetic fields should be at levels characteristic of a typical location in a typical commercial or hospital environment.
Conducted RF IEC 61000-4-6 Radiated RF IEC 61000-4-3	3 V/m @ 150 kHz to 80 MHz 9 to 28 V/m in communication service bands up to 6 GHz	3V/m @ 150 kHz to 80MHz 9 to 28 V/m in communication service bands up to 6 GHz	Portable and mobile RF communications equipment should be used no closer to any part of the MDRC-2222, including cables, than the recommended separation distance calculated from the equation applicable to the frequency of the transmitter. Recommended separation distance $d = 1.2\sqrt{P}$ $d = 1.2\sqrt{P}$ 80 MHz to 800 MHz $d = 2.3\sqrt{P}$ 800 MHz to 2.5 Ghz

1. is the a.c. mains voltage prior to application of the test level.

5. Important information

Immunity test	IEC 60601-1-2 4 th edition (2014) Test levels	Compliance level	Electromagnetic environment – guidance
			<p>Where P is the maximum output power rating of the transmitter in watts (W) according to the transmitter manufacturer and d is the recommended separation distance in meters (m).</p> <p>Field strengths from fixed RF transmitters, as determined by an electromagnetic site survey,² should be less than the compliance level in each frequency range.³</p> <p>Interference may occur in the vicinity of equipment marked with symbol:</p> 



At 80 MHz and 800 MHz, the higher frequency range applies.



These guidelines may not apply in all situations. Electromagnetic propagation is affected by absorption and reflection from structures, objects and people.

2. Field strengths from fixed transmitters, such as base stations for radio (cellular/cordless) telephones and land mobile radios, amateur radio, AM and FM radio broadcast and TV broadcast cannot be predicted theoretically with accuracy. To assess the electromagnetic environment due to fixed RF transmitters, an electromagnetic site survey should be considered. If the measured field strength in the location in which the MDRC-2222 is used exceeds the applicable RF compliance level above, the MDRC-2222 should be observed to verify normal operation. If abnormal performance is observed, additional measures may be necessary, such as re-orienting or relocating the MDRC-2222.

3. Over the frequency range 150 kHz to 80 MHz, field strengths should be less than 3 V/m.

Recommended separation distance

The MDRC-2222 is intended for use in an electromagnetic environment in which radiated RF disturbances are controlled. The customer of the user of the MDRC-2222 can help prevent electromagnetic interference by maintaining a minimum distance between portable and mobile RF communications equipment (transmitters) and the MDRC-2222 as recommended below, according to the maximum output power of the communications equipment.

Rated maximum output power of transmitter ⁴ W	Separation distance according to frequency of transmitter		
	150kHz to 80MHz $d=1.2\sqrt{P}$	80MHz to 800MHz $d=1.2\sqrt{P}$	800MHz to 2.5GHz $d=2.3\sqrt{P}$
0.01	0.12	0.12	0.23
0.1	0.38	0.38	0.73
1	1.2	1.2	2.3
10	3.8	3.8	7.3
100	12	12	23



At 80 MHz and 800 MHz, the separation distance for the higher frequency range applies.







These guidelines may not apply in all situations. Electromagnetic propagation is affected by absorption and reflection from structures, object and people.

5.6 Explanation of symbols















Symbols on the device

On the device or power supply, you may find the following symbols (nonrestrictive list):

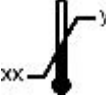



	Indicates the device meets the requirements of the applicable EC directives.
	Indicates compliance with Part 15 of the FCC rules (Class A or Class B)
	Indicates the device is approved according to the UL Recognition regulations
	Indicates the device is approved according to the UL Demko regulations
	Indicates the device is approved according to the CCC regulations

⁴ For transmitters rated at a maximum output power not listed above, the recommended separation distance d in meters (m) can be estimated using the equation applicable to the frequency of the transmitter. Where P is the maximum output power rating of the transmitter in watts (W) according to the transmitter manufacturer.

5. Important information



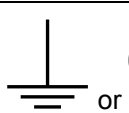

	Indicates the device is approved according to the VCCI regulations
	Indicates the device is approved according to the KC regulations
	Indicates the device is approved according to the BSMI regulations
	Indicates the device is approved according to the PSE regulations
	Caution: Federal law (United States of America) restricts this device to sale by or on the order of a licensed healthcare practitioner.
	Indicates the USB connectors on the device
	Indicates the DisplayPort connectors on the device
	Indicates the legal manufacturer
	Indicates the manufacturing date
	Indicates the temperature limitations ⁵ for the device to safely operate within specs.
	Indicates the device serial number
	Indicates the device part number or catalogue number
	Warning: dangerous voltage
	Caution
	Consult the operating instructions

5. Values for xx and yy can be found in the technical specifications paragraph.

	Indicates this device must not be thrown in the trash but must be recycled, according to the European WEEE (Waste Electrical and Electronic Equipment) directive
	Indicates Direct Current (DC)
	Indicates Alternating Current (AC)
	Stand-by
	Equipotentiality
	Protective earth (ground)

Symbols on the box

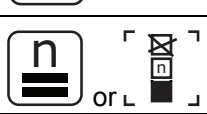
On the box of the device, you may find the following symbols (nonrestrictive list):

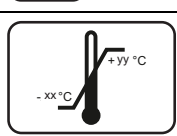
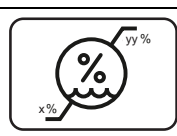
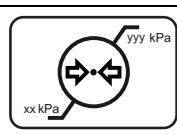
	Indicates a device that can be broken or damaged if not handled carefully when being stored.
	Indicates a device that needs to be protected from moisture when being stored.
	Indicates the storage direction of the box. The box must be transported, handled and stored in such a way that the arrows always point upwards.
	Indicates the maximum number of identical boxes which may be stacked on each other, where "n" is the limiting number.
	Indicates the weight of the box and that it should be carried with two persons.
	Indicates that the box should not be cut with a knife, a cutter or any other sharp object.
	Indicates the temperature limits ⁶ to which the device can be safely exposed when being stored.
	Indicates the range ⁶ of humidity to which the device can be safely exposed when being stored.
	Indicates the range ⁶ of atmospheric pressure to which the device can be safely exposed when being stored.

6. Values for xx and yy can be found in the technical specifications paragraph.

5.7 Legal disclaimer

Disclaimer notice

Although every attempt has been made to achieve technical accuracy in this document, we assume no responsibility for errors that may be found. Our goal is to provide you with the most accurate and usable documentation possible; if you discover errors, please let us know.

Barco software products are the property of Barco. They are distributed under copyright by Barco NV or Barco Inc., for use only under the specific terms of a software license agreement between Barco NV or Barco Inc. and the licensee. No other use, duplication, or disclosure of a Barco software product, in any form, is authorized.

Trademarks

All trademarks and registered trademarks are property of their respective owners.

Copyright notice

This document is copyrighted. All rights are reserved. Neither this document, nor any part of it, may be reproduced or copied in any form or by any means - graphical, electronic, or mechanical including photocopying, taping or information storage and retrieval systems - without written permission of Barco.

© 2017 Barco NV all rights reserved.

5.8 Technical specifications

MDRC-2222 (option BL)

Screen technology	LCD
Active screen size (diagonal)	546 mm (21.5")
Active screen size (H x V)	476 x 268 mm (18.7 x 10.5")
Aspect ratio (H:V)	16:9
Resolution	2MP (1920 x 1080 pixels)
Pixel pitch	0.248 mm
Color imaging	Yes
Gray imaging	Yes
Bit depth	30 bit
Viewing angle (H, V)	178°
Ambient light presets	Yes, reading room selection
Front sensor	Yes, Front Consistency Sensor
Maximum luminance (panel typical)	300 cd/m ²
DICOM calibrated luminance	180 cd/m ²
Contrast ratio (panel typical)	1000:1
Response time ((Tr + Tf)/2) (typical)	7.5 ms
Housing color	RAL 9004

Video input signals	1x DVI-I 1x DisplayPort
USB ports	1x USB 2.0 upstream (endpoint) 2x USB 2.0 downstream
Power rating	100-240 Vac, 50-60 Hz, 0.6-0.4 A
Power consumption	20 W (nominal) < 0.5 W (hibernate) < 0.5 W (standby)
Dimensions with stand (W x H x D)	Portrait: 337 x 525~602 x 201 mm Landscape: 514 x 388~498 x 201 mm
Dimensions w/o stand (W x H x D)	Portrait: 315 x 514 x 67 mm Landscape: 514 x 315 x 67 mm
Dimensions packaged (W x H x D)	700 x 240 x 460 mm
Net weight with stand	5.6 kg
Net weight w/o stand	3.3 kg
Net weight packaged	7.0 kg (without optional accessories)
Tilt	-5° to +22°
Pivot	90°
Height adjustment range	110 mm
Mounting standard	VESA (100 mm)
Screen protection	N/A
Recommended modalities	All digital images, except digital mammography
Certifications	CE (MDD 93/42/EEC; A1:2007/47/EC class I device) CE 2014/30/EU RoHS EN 60601-1-2 (2015) IEC 60950-1:2005 + A1:2009 + A2:2003 (2nd Edition) IEC 60601-1:2005 + C1:2006 + C2:2007 + A1:2012 ANSI/AAMI ES60601-1:A1:2012 + C1:2009/(R)2012 + A2:2010/(R)2012 CAN/CSA C22.2 No. 60601-1:2014 DEMKO EN 60601-1:2006 + A12:2014 + A1:2013 CCC GB4943.1-2011+ GB17625.1-2012 + GB/T9254-2008 VCCI KC FCC class B ICES001 Level B FDA class I device

5. Important information

Supplied accessories	User guide System disc DisplayPort cable USB cable AC mains cable (depending on the region)
QA software	MediCal QAWeb
Warranty	3 years
Operating temperature	0 °C to 40 °C
Storage temperature	-20 °C to 60 °C
Operating humidity	8% to 85% (non-condensing)
Storage humidity	5% to 95% (non-condensing)
Operating pressure	70 kPa
Storage pressure	50 to 106 kPa

MDRC-2222 (option TS)

Screen technology	LCD
Active screen size (diagonal)	546 mm (21.5")
Active screen size (H x V)	476 x 268 mm (18.7 x 10.5")
Aspect ratio (H:V)	16:9
Resolution	2MP (1920 x 1080 pixels)
Pixel pitch	0.248 mm
Color imaging	Yes
Gray imaging	Yes
Bit depth	30 bit
Viewing angle (H, V)	178°
Ambient light presets	Yes, reading room selection
Front sensor	Yes, Front Consistency Sensor
Maximum luminance (panel typical)	300 cd/m ²
DICOM calibrated luminance	180 cd/m ²
Contrast ratio (panel typical)	1000:1
Response time ((Tr + Tf)/2) (typical)	7.5 ms
Housing color	RAL 9004
Video input signals	1x DVI-I 1x DisplayPort
USB ports	1x USB 2.0 upstream (endpoint) 2x USB 2.0 downstream
Power rating	100-240 Vac, 50-60 Hz, 0.6-0.4 A

Power consumption	20 W (nominal) < 0.5 W (hibernate) < 0.5 W (standby)
Dimensions with stand (W x H x D)	Portrait: 337 x 525~602 x 201 mm Landscape: 514 x 388~498 x 201 mm
Dimensions w/o stand (W x H x D)	Portrait: 315 x 514 x 67 mm Landscape: 514 x 315 x 67 mm
Dimensions packaged (W x H x D)	700 x 240 x 460 mm
Net weight with stand	6.5 kg
Net weight w/o stand	4.2 kg
Net weight packaged	7.9 kg (without optional accessories)
Tilt	-5° to +22°
Pivot	90°
Height adjustment range	110 mm
Mounting standard	VESA (100 mm)
Screen protection	N/A
Recommended modalities	All digital images, except digital mammography
Certifications	CE (MDD 93/42/EEC; A1:2007/47/EC class I device) CE 2014/30/EU RoHS EN 60601-1-2 (2015) IEC 60950-1:2005 + A1:2009 + A2:2003 (2nd Edition) IEC 60601-1:2005 + C1:2006 + C2:2007 + A1:2012 ANSI/AAMI ES60601-1:A1:2012 + C1:2009/(R)2012 + A2:2010/(R)2012 CAN/CSA C22.2 No. 60601-1:2014 DEMKO EN 60601-1:2006 + A12:2014 + A1:2013 CCC GB4943.1-2011+ GB17625.1-2012 + GB/T9254-2008 VCCI KC FCC class B ICES001 Level B FDA class I device
Supplied accessories	User guide System disc DisplayPort cable USB cable AC mains cable (depending on the region)
QA software	MediCal QAWeb
Warranty	3 years

5. Important information

Operating temperature	0 °C to 40 °C
Storage temperature	-20 °C to 60 °C
Operating humidity	8% to 85% (non-condensing)
Storage humidity	5% to 95% (non-condensing)
Operating pressure	70 kPa
Storage pressure	50 to 106 kPa

MDRC-2222 (option WP)

Screen technology	LCD
Active screen size (diagonal)	546 mm (21.5")
Active screen size (H x V)	476 x 268 mm (18.7 x 10.5")
Aspect ratio (H:V)	16:9
Resolution	2MP (1920 x 1080 pixels)
Pixel pitch	0.248 mm
Color imaging	Yes
Gray imaging	Yes
Bit depth	30 bit
Viewing angle (H, V)	178°
Ambient light presets	Yes, reading room selection
Front sensor	Yes, Front Consistency Sensor
Maximum luminance (panel typical)	300 cd/m ²
DICOM calibrated luminance	180 cd/m ²
Contrast ratio (panel typical)	1000:1
Response time ((Tr + Tf)/2) (typical)	7.5 ms
Housing color	RAL 9016
Video input signals	1x DVI-I 1x DisplayPort
USB ports	1x USB 2.0 upstream (endpoint) 2x USB 2.0 downstream
Power rating	100-240 Vac, 50-60 Hz, 0.6-0.4 A
Power consumption	20 W (nominal) < 0.5 W (hibernate) < 0.5 W (standby)
Dimensions with stand (W x H x D)	Portrait: 337 x 525~602 x 201 mm Landscape: 514 x 388~498 x 201 mm
Dimensions w/o stand (W x H x D)	Portrait: 315 x 514 x 67 mm Landscape: 514 x 315 x 67 mm

Dimensions packaged (W x H x D)	700 x 240 x 460 mm
Net weight with stand	6.4 kg
Net weight w/o stand	4.1 kg
Net weight packaged	7.8 kg (without optional accessories)
Tilt	-5° to +22°
Pivot	90°
Height adjustment range	110 mm
Mounting standard	VESA (100 mm)
Screen protection	Protective, anti-glare glass cover
Recommended modalities	All digital images, except digital mammography
Certifications	CE (MDD 93/42/EEC; A1:2007/47/EC class I device) CE 2014/30/EU RoHS EN 60601-1-2 (2015) IEC 60950-1:2005 + A1:2009 + A2:2003 (2nd Edition) IEC 60601-1:2005 + C1:2006 + C2:2007 + A1:2012 ANSI/AAMI ES60601-1:A1:2012 + C1:2009/(R)2012 + A2:2010/(R)2012 CAN/CSA C22.2 No. 60601-1:2014 DEMKO EN 60601-1:2006 + A12:2014 + A1:2013 CCC GB4943.1-2011+ GB17625.1-2012 + GB/T9254-2008 VCCI KC FCC class B ICES001 Level B FDA class I device
Supplied accessories	User guide System disc DisplayPort cable USB cable AC mains cable (depending on the region)
QA software	MediCal QAWeb
Warranty	3 years
Operating temperature	0 °C to 40 °C
Storage temperature	-20 °C to 60 °C
Operating humidity	8% to 85% (non-condensing)
Storage humidity	5% to 95% (non-condensing)
Operating pressure	70 kPa
Storage pressure	50 to 106 kPa