

SAMSUNG

LED TV

Installation manual



Thank you for purchasing Samsung product.
To receive more service, please register your
product at

www.samsung.com/register

Model _____ Serial No. _____

Figures and illustrations in this User Manual are provided for reference only and may differ from actual product appearance. Product design and specifications may be changed without notice.

Introduction

This TV B2B (Business to Business) model is designed for hotels or the other hospitality businesses, supports a variety of special functions, and lets you limit some user (guest) controls.

Operational Modes

This TV has two modes: Interactive and Stand-alone mode.

- **Interactive mode:** In this mode, the TV communicates with and is fully or partially controlled by a connected Set Back Box (SBB) or Set Top Box (STB) provided by a hospitality SI (System Integration) vendor. When the TV is initially plugged in, it sends a command that attempts to identify the SSB or STB connected to it. If the TV identifies the SBB or STB and the SBB or STB identifies the TV, the TV gives full control to the SBB or STB.
- **Stand-alone mode:** In this mode, this TV works alone without an external SBB or the STB.

The TV has a Hotel (Hospitality) Menu that lets you easily set its various hospitality functions. Please see pages 27 to 32 .

The Menu also lets you activate or de-activate some TV and hospitality functions so you can create your optimal hospitality configuration.

Still image warning

Avoid displaying still images (such as jpeg picture files) or still image elements (such as TV channel logos, panorama or 4:3 format images, stock or news bars or crawls) on the screen. Displaying still pictures continually can cause uneven screen wear, which will affect image quality. To reduce the chance that this effect will occur, please follow the recommendations below:

- Avoid displaying the same TV channel for long periods.
- Always try to display a full screen image.
- Reduce brightness and contrast to help prevent the occurrence of after-images.
- Use all TV features designed to reduce image retention and screen burn-in. Refer to the proper user manual section for details.

Ensuring Proper Ventilation

When you install the TV, maintain the distances shown below between the TV and other objects (walls, cabinet sides, etc.) to ensure proper ventilation.

Failing to do so may result in a fire or problems with the TV caused by an increase in its internal temperature.

- When using a stand or wall-mount, use parts provided by Samsung Electronics only.
 - If you use parts provided by another manufacturer, it may cause a problem with the product or cause the product to fall, leading to serious injury.

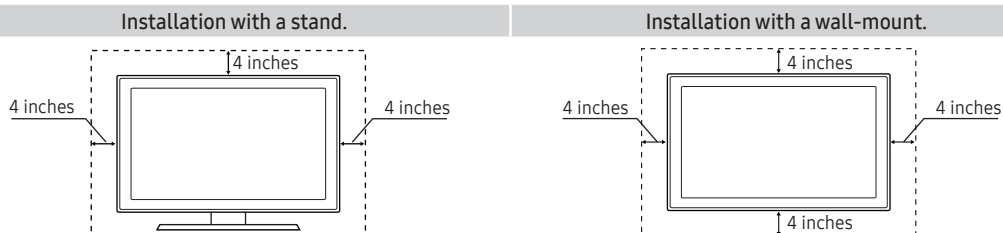

Additional Information

- The appearance of the TV and its accessories may differ from the illustrations in this manual, depending on the TV.
- Be careful when you touch the TV if it is on or has been on for a period of time. Some parts can be hot.

Contents

- Accessories..... 4
- Installing the LED TV Stand 5
- Assembling the Holder Wire Stand..... 9
- Assembling the swivel (32 inch TVs or larger) 10
- Using the TV's Controller 12
- The Connection Panel..... 13
- The Remote Control..... 16
- Using the Samsung Smart Control (sold separately)..... 18
- Connecting to the Network..... 23
- Connecting the TV to an SBB or STB..... 25
- Connecting the Bathroom Speakers 28
- Connecting the RJP (Remote Jack Pack) 29
- Setting the Hotel Option Data 31
- Installing the Wall Mount..... 54
- Anti-theft Kensington Lock..... 56
- Specifications..... 57
- Display Resolution 59
- Dimensions..... 60

Symbols Used in this Manual



TOOLS



Indicates that you can press the TOOLS button on the remote control to use this function.



NOTE



One-Touch Button

Accessories

- ✎ Please make sure the following items are included with your LED TV. If any items are missing, contact your dealer.
- ✎ The items' color and shape may vary, depending on the model.
- ✎ The parts for the stand are listed under Stand Components on the following page.

List of Parts



Remote Control (AA59-00817A) & Batteries (AAA x 2)



Samsung Smart Control (BN59-01181N) (sold separately) (32 inch TVs or larger)



Power Cord



Safety Guide / Quick Setup Guide / Regulatory Guide (Not available in all locations)



Data Cable (depending on the model) (BN39-00865B, BN39-01011E)



Hotel Mount Kit (32 inch TVs or larger)



Holder-Wire stand 1(EA)

Installing the LED TV Stand

Components

When installing the stand, use the provided components and parts.

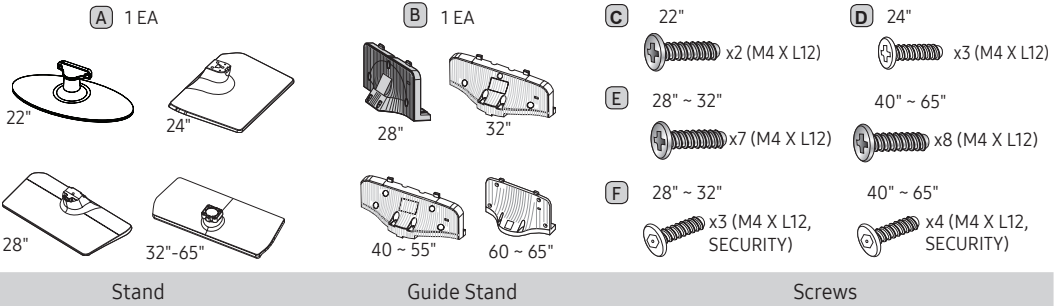

◆ HG22NE690

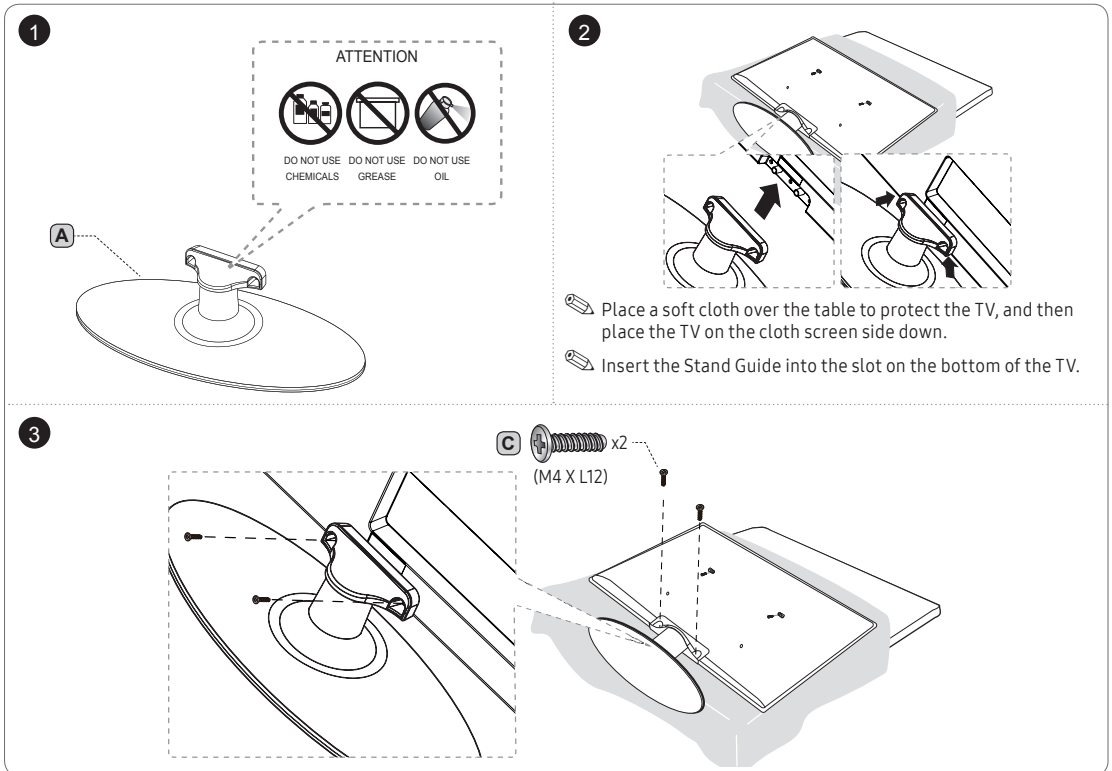

◆ HG24NE690

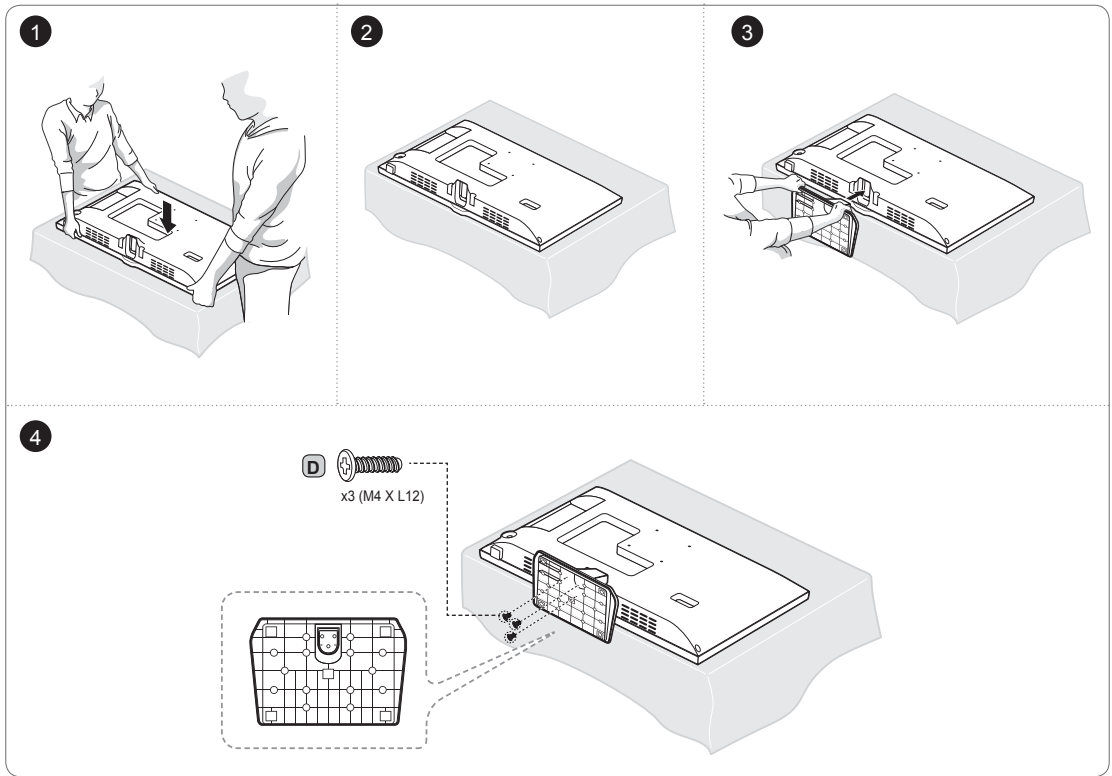

◆ HG28NE690

1

E  x4
(M4 X L12)

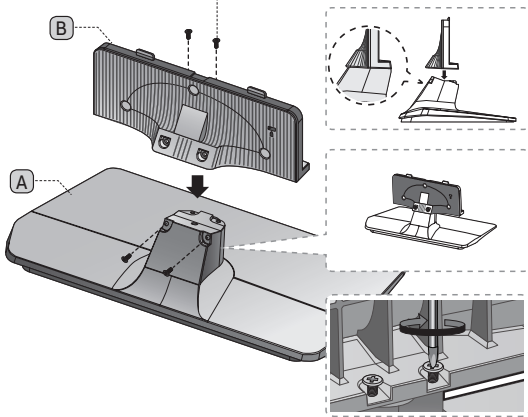

B

A



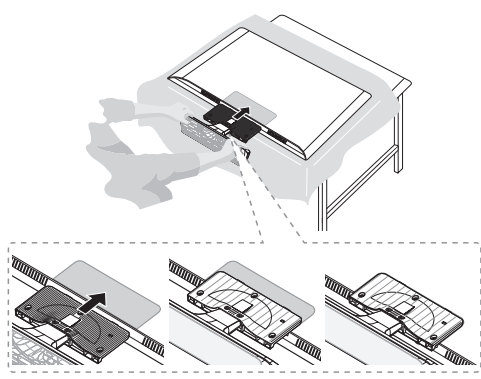

2





-  Place a soft cloth over the table to protect the TV, and then place the TV on the cloth screen-side down.
-  Insert the Stand Guide into the slot on the bottom of the TV.
-  Slide and assemble it to the end line in the direction of arrow.

3 Tight the bottom of the screw first, and stow the upper side of screw last.

E  x3 (M4 X L12)

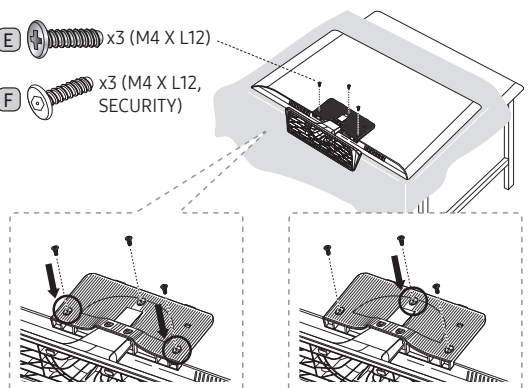
F  x3 (M4 X L12, SECURITY)



-  Progress the assembly of screw in the manual's order.

4 When the declination happened, try reassemble it **2** category.

-  Make sure to assembling stand guide attached on the TV.

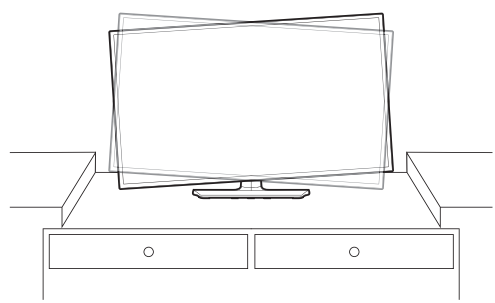

◆ HG32NE690 / HG40NE690 / HG48NE690 / HG50NE690 / HG55NE690

1

40 ~ 55"

E x4
(M4 X L12)

32"

2

32"

40 ~ 55"

- Place a soft cloth over the table to protect the TV, and then place the TV on the cloth screen-side down.
- Insert the Stand Guide into the slot on the bottom of the TV.
- Slide and assemble it to the end line in the direction of arrow.

3 Tight the bottom screw first, and upper screw last.

- Progress the assembly of screw in the manual's order.

E 32": x3 (M4 X L12)
40"-55": x4 (M4 X L12)

F 32": x3 (M4 X L12, SECURITY)
40"-55": x4 (M4 X L12, SECURITY)

32"

40"-55"

4 When the declination happened, try reassemble it **2** category.

- Make sure to assembling stand guide attached on the TV.

NOTE

- Make sure to distinguish between the front and back of each component when assembling them.
- Make sure that at least two persons lift and move the TV.

1

E x4 (M4 X L12)

F x4 (M4 X L12, SECURITY)

3 Tight the bottom screw first, and upper screw last.
 ⚙️ Progress the assembly of screw in the manual's order.

2

⚙️ Place a soft cloth over the table to protect the TV, and then place the TV on the cloth screen-side down.
 ⚙️ Insert the Stand Guide into the slot on the bottom of the TV.
 ⚙️ Slide and assemble it to the end line in the direction of arrow.

4 When the declination happened, try reassemble it **2** category.
 ⚙️ Make sure to assembling stand guide attached on the TV.

🔧 NOTE

- Make sure to distinguish between the front and back of each component when assembling them.
- Make sure that at least two persons lift and move the TV.

Assembling the Holder Wire Stand

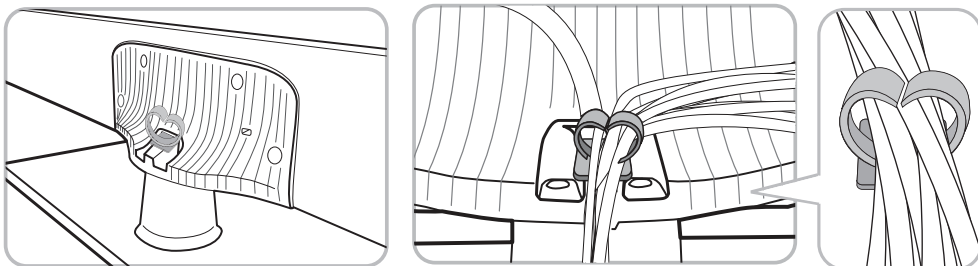

Assembling the swivel (32 inch TVs or larger)

▲ WARNING: If you configure the TV to swivel, you must attach it securely to the floor, a desk, a dresser top, etc. as described in the installation instructions.

The 32" and larger LED TVs have swivel stands. You can configure these stands so that the TVs swivel 20 degrees left and right, 60 degrees left and right, or 90 degrees left and right using the BRACKET HOLDER SWIVEL.

20° swivel

To configure the TV so that it swivels 20° left and right, insert the prong on the bottom of the stand through the curved hole in the Bracket Holder Swivel marked 20°. Then, fix the Bracket Holder Swivel to the stand using the three supplied screws as shown below.

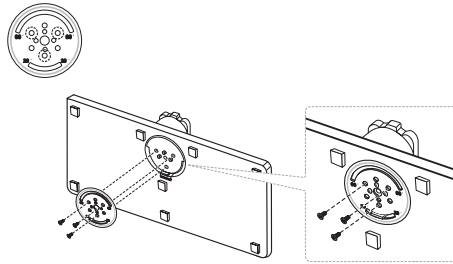

60° swivel

To configure the TV so that it swivels 60° left and right, insert the prong on the bottom of the stand through the curved hole in the Bracket Holder Swivel marked 60°. Then, fix the Bracket Holder Swivel to the stand using the three supplied screws as shown below.

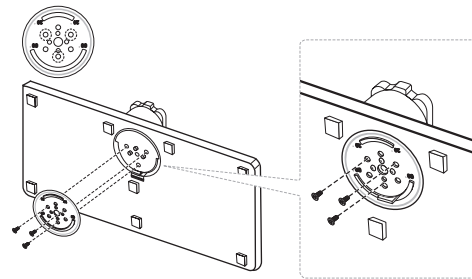

90° swivel

To configure the TV so that it swivels 90° left and right, remove the Bracket Holder Swivel, and then screw the three supplied screws into the stand as shown below.

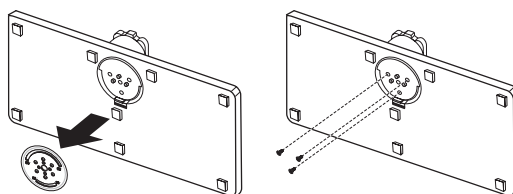

Hotel Mount Kit

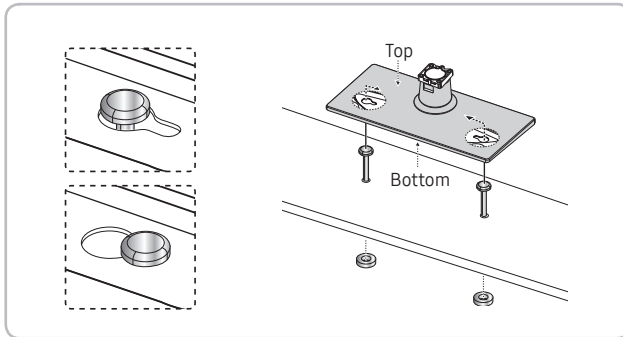
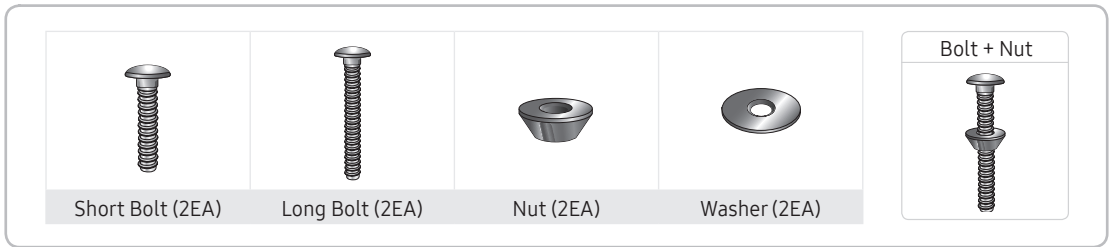

Affix the stand to a flat surface such as a dresser top, desk top, or entertainment center as shown.



WARNING: To prevent injury, you must attach this TV securely to the floor, a table, a dresser top, etc. with the Hotel Mount Kit as described in these instructions.

Using the TV's Controller

- The color and shape of the TV Controller may vary depending on the model.
- The TV's Controller, a small joystick like button on the bottom right side of the TV, lets you control the TV without the remote control.

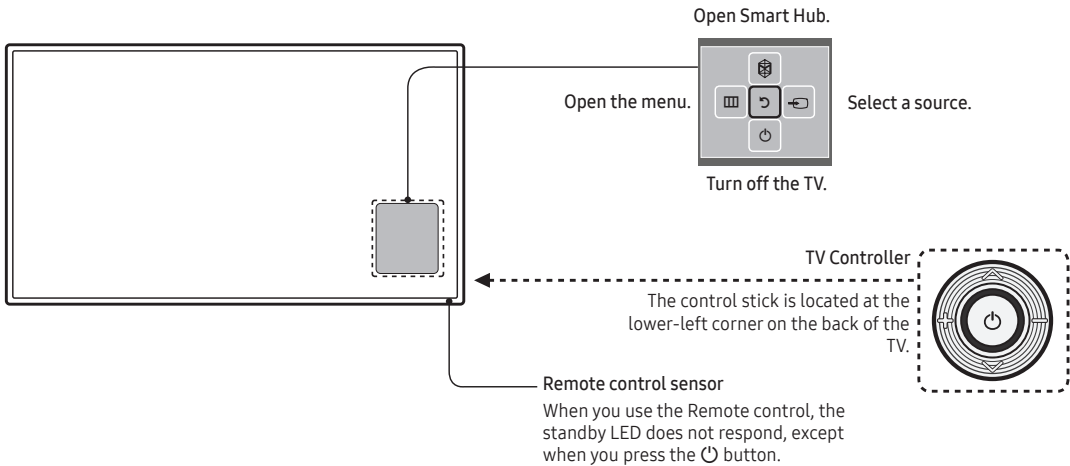

Power on	Turn the TV on by pressing the Controller when the TV is in standby mode.
Adjusting the volume	Adjust the volume by moving the Controller from side to side when the power is on.
Selecting a channel	Select a channel by moving the Controller backwards and forwards when the power is on.
Using the Function menu	To view and use the Function menu, press and release the Controller when the power is on. To close the Function menu, press and release the Controller again.
Selecting the MENU (≡)	With the Function menu visible, select the MENU (≡) by moving the Controller to the left. The OSD (On Screen Display) Menu appears. Select an option by moving the Controller to the right. Move the Controller to the right or left, or backwards and forwards to make additional selections. To change a parameter, select the it, and then press the Controller.
Selecting SMART HUB (⊗)	With the Function menu visible, select SMART HUB (⊗) by moving the Controller upwards. The SMART HUB main screen appears. Select an application by moving the Controller, and then pressing the Controller.
Selecting a Source (☒)	With the Function menu visible, open the Source screen (☒) by pushing the Controller to the right. The Source screen appears. To select a source, move the Controller back and forth. When the source you want is highlighted, press the Controller.
Power Off (⏻)	With the Function menu visible, select Power Off (⏻) by pulling the Controller forwards, and then press the Controller.

- To close the Menu, SMART HUB, or Source, press the Controller for more than 1 second.

Standby mode

Your TV enters Standby mode when you turn it off, and continues to consume a small amount of electric power. To be safe and to decrease power consumption, do not leave your TV in standby mode for long periods of time (when you are away on vacation, for example). It is best to unplug the power cord.

The Connection Panel

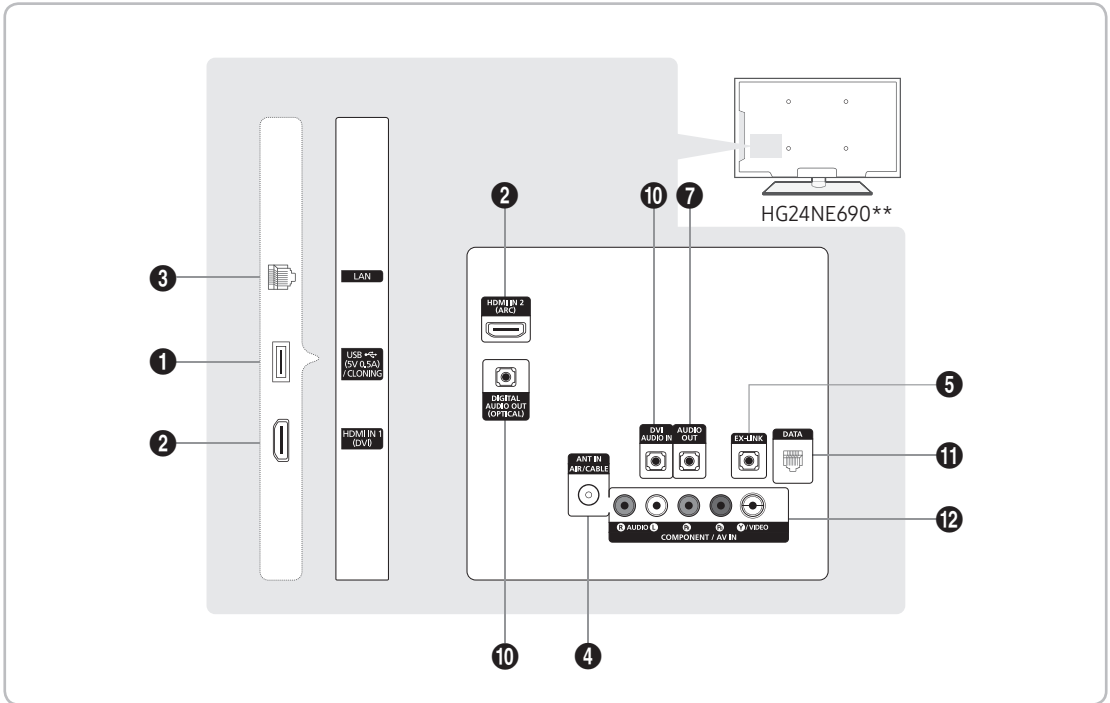
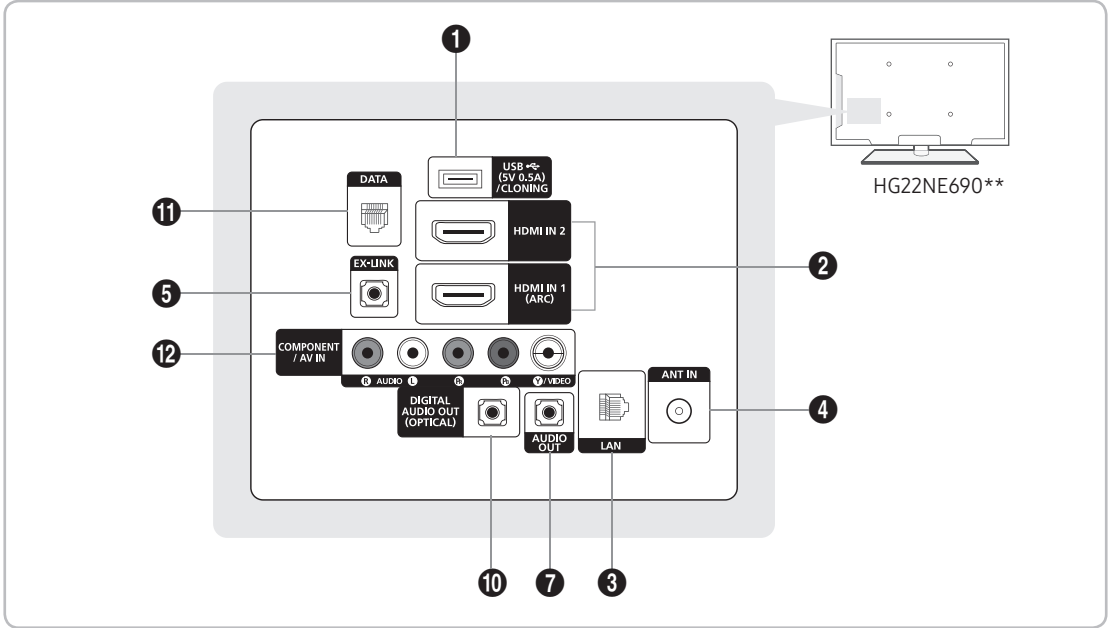

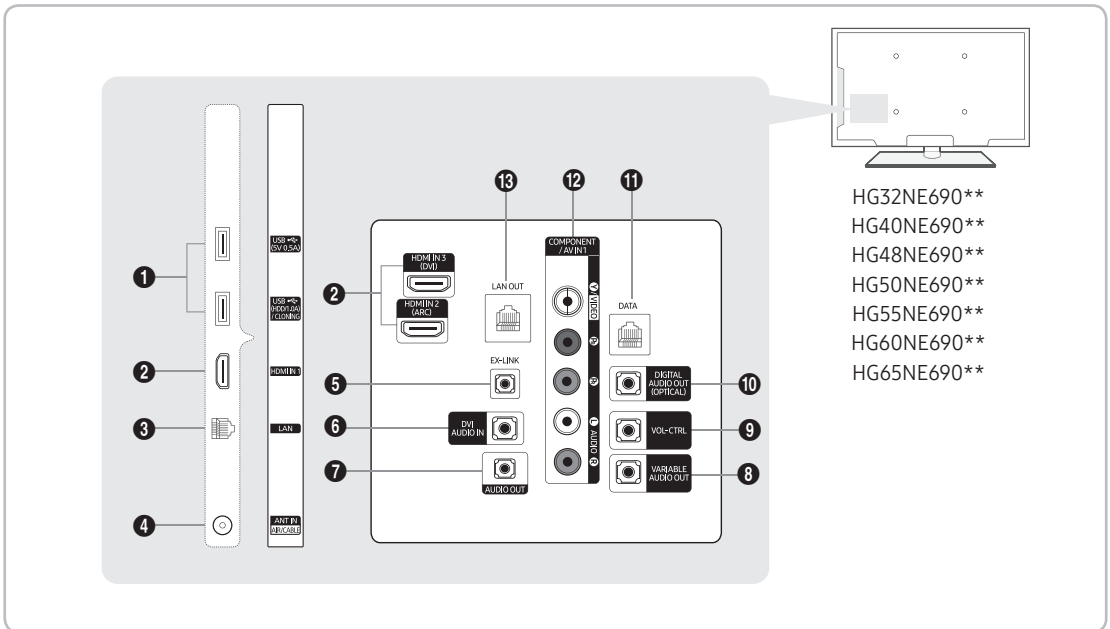
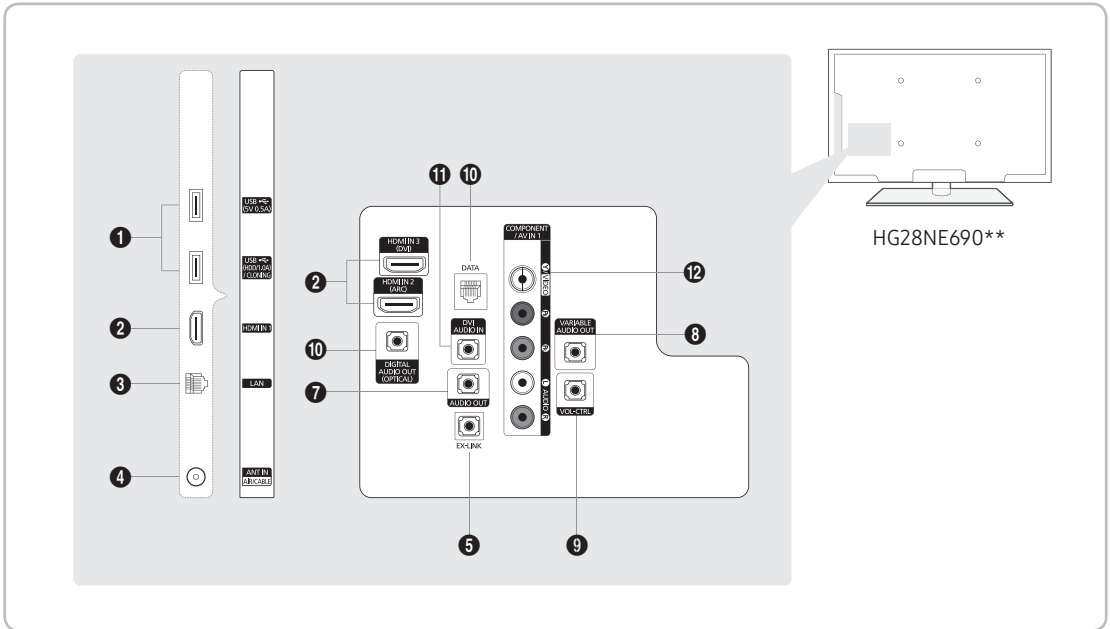

- ⚠ Whenever you connect an external device to your TV, make sure that power on the TV and the device is turned off.
- ⚠ When connecting an external device, match the color of the connection terminal to the cable.

- 1 **USB (5V 0.5A), (HDD/1.0A) / CLONING**
 - Connector for software upgrades and Media Play, etc.
 - Service connection.
- 2 **HDMI IN / HDMI IN (ARC) / HDMI IN (DVI)**

Connects to the HDMI jack of a device with an HDMI output.

 - ✎ The number of connectors and their names and locations may vary depending on the model.
 - ✎ No separate sound connection is needed for an HDMI to HDMI connection. HDMI connections carry both audio and video.
 - ✎ Use the HDMI IN (DVI) jack for a DVI connection to an external device. Use a DVI to HDMI cable or DVI-HDMI adapter (DVI to HDMI) for the video connection and the PC/DVI AUDIO IN jacks for audio. Some DVI or HDMI devices may not or should not need a DVI AUDIO IN connection for audio.
 - ✎ It is recommended that the external device of the HDMI 1.3 or 1.4 version will be used with this TV. If you meet the compatible problem like no sound or the abnormal screen or etc with the device of the HDMI 1.2 version, contact to the Samsung customer care center. Refer to page 59 for the information of the Samsung customer care center.
- 3 **LAN**

Connect to a wired LAN using CAT 7 cable.
- 4 **ANT IN (AIR/CABLE)**
 - To view television channels correctly, the TV must receive a signal from one of the following sources:
 - An outdoor antenna / A cable television system / A satellite receiver
- 5 **EX-LINK**

Connect this jack to the jack on the optional RJP (Remote Jack Pack). This will allow you to connect external devices (Camcorder, PC, DVD players etc.) easily.
- 6 **DVI AUDIO IN**

Connects to the audio out jack of an external DVI device using a 1/8th inch stereo phone jack cable. Some DVI devices may not or should not need this connection audio.
- 7 **AUDIO OUT**

Connects to the audio input jacks on an Amplifier/Home Theater.
- 8 **VARIABLE AUDIO OUT**

Used for the audio output to the Bathroom speaker. Connect the Bathroom Wall Box and the Variable port (RCA).
- 9 **VOL-CTRL**

Used to control the volume of the Bathroom speaker. Connect the Bathroom Wall Box and the VOLCTRL port.
- 10 **DIGITAL AUDIO OUT (OPTICAL)**

Connects to a Digital Audio component.
- 11 **DATA**
 - Used to support data communication between the TV and the SBB or STB.
 - Connects using RJ-12 TV type plugs.
- 12 **COMPONENT IN / AV IN 1**
 - Use to connect to Component video / audio devices such as DVD players and AV (Composite) devices such as VCRs.
 - Connect audio cables to "R-AUDIO-L" on your TV and the other ends to corresponding audio out jacks on A/V or Component devices.
 - The COMPONENT IN jack is also used as the VIDEO 1 jack.
 - Connect component video cables (not supplied) to the component jacks ("PR", "PB", "Y") on the rear of your TV and the other ends to corresponding component video out jacks on a DVD player. Match the colors on the jacks and cables.
 - If you want to connect both a Set-Top Box and a DVD player, you should connect the Set-Top Box to the DVD and connect the DVD to the component jacks ("PR", "PB", "Y") on your TV.
 - The PR, PB and Y jacks on your component devices (DVD) are sometimes labeled Y, B-Y and R-Y or Y, Cb and Cr.
 - For AV devices, connect RCA audio cables (not supplied) to "R - AUDIO - L" on the rear of the TV set and the other ends to corresponding audio out jacks on an external device.
 - When you are connecting a composite (AV) device to AV IN 1 [Y/Video], connect the video cable (Yellow) to the AV IN 1 [Y/VIDEO] jack (Green/Yellow) .
- 13 **LAN OUT**

Wired LAN connection port used to connect an external device LAN such as a laptop to connect to the Internet. (However, the TV must be connected to the Internet via wired LAN.)

The Remote Control

- This remote control has Braille points on the Power, Channel, and Volume buttons and can be used by visually impaired customers.

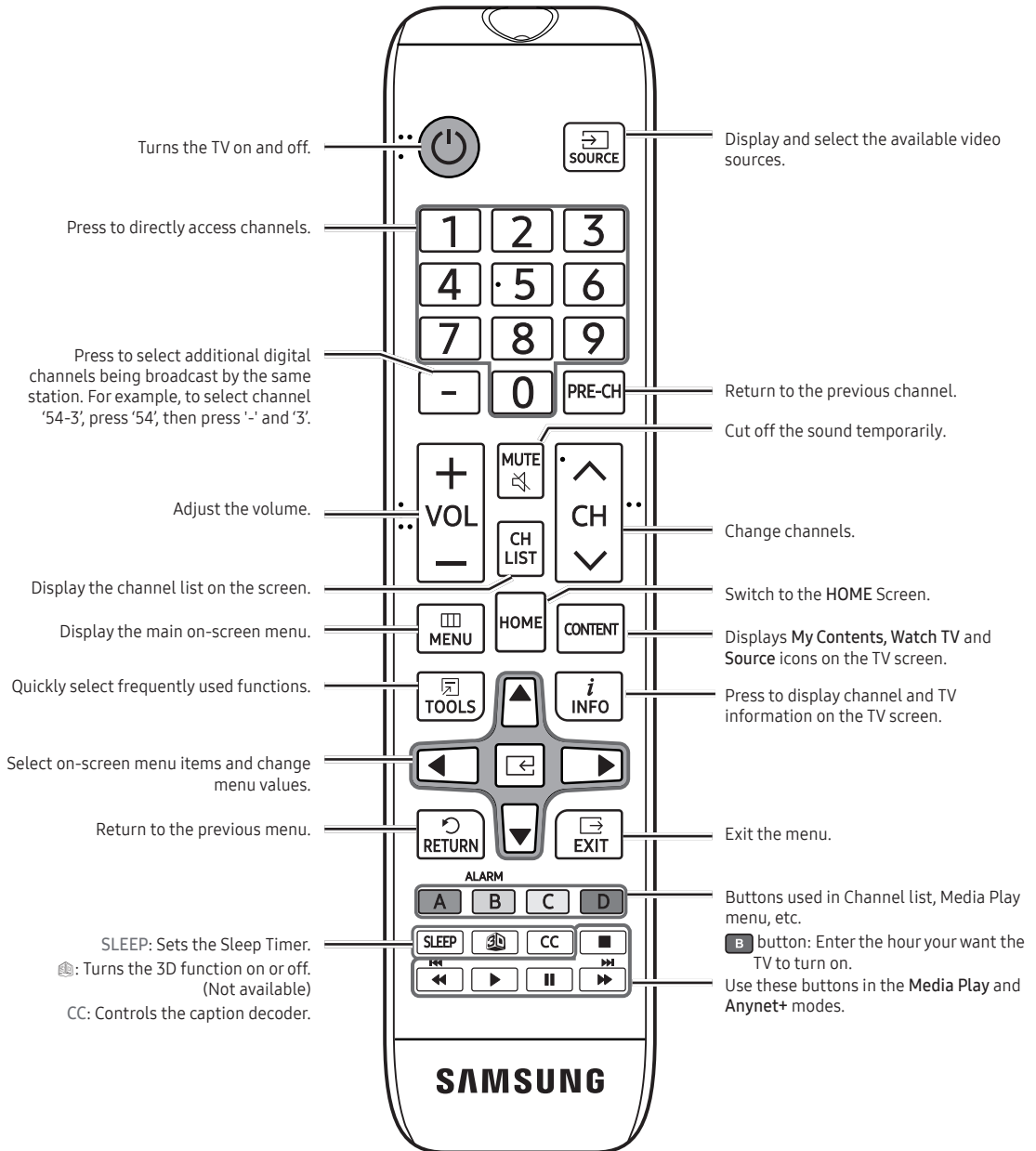

Installing batteries (Battery size: AAA)

Match the polarity of the batteries to the symbols in the battery compartment.

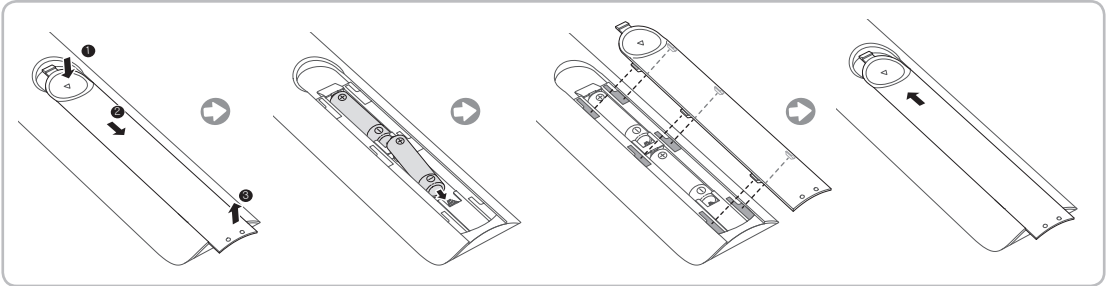

After you have installed the batteries, use a screwdriver to screw in the screw that holds the battery cover closed.

NOTE

- Use the remote control within 23 feet of the TV.
- Bright light may affect the performance of the remote control. Avoid using near fluorescent lights or neon signs.
- The color and shape of the remote may vary depending on the model.

Using the Samsung Smart Control (sold separately)

This function is only available with the HG32NE690 series and higher.

Buttons and Functions

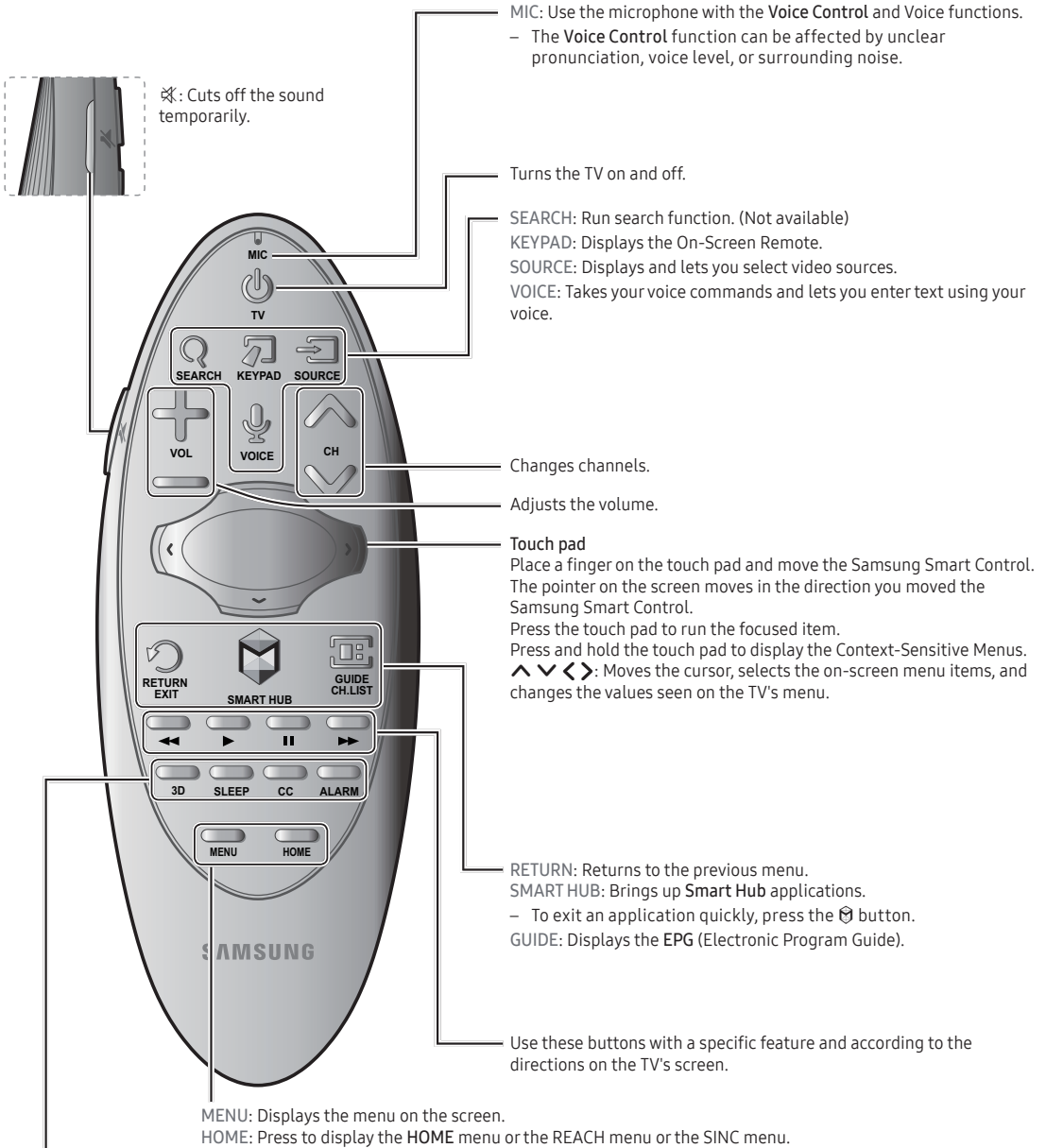

3D: Turns the 3D function on or off. (Not available)
SLEEP: Press to set when TV will be turned off after a preset period of time.
CC: Controls the caption decoder and displays captions on the screen.
ALARM: Press to set when TV will be turned on for the alarm.

Installing Batteries into the Samsung Smart Control

To use the Samsung Smart Control, insert the batteries into the device referring to the figure below.

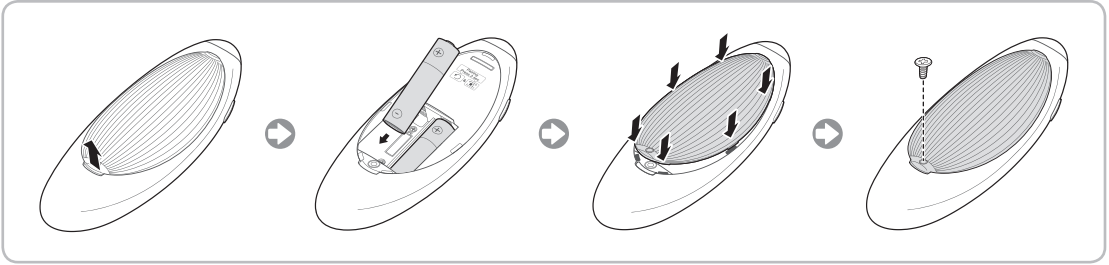

Gently pull on the battery cover's notch and then remove the cover completely once it comes loose. Insert 2 AA alkaline batteries, making sure to align the positive and negative polarities correctly.

Using the Samsung Smart Control Motion Function to Operate the TV

The Samsung Smart Control has a motion sensor (gyro sensor) that lets you control the TV easily by moving the Samsung Smart Control and using it much like a cordless mouse.

Place a finger on the Samsung Smart Control's touch pad, and then move the Samsung Smart Control. A pointer appears on the screen. Move the Samsung Smart Control, and pointer moves on the screen in the direction you moved the Samsung Smart Control and the same distance. Highlight an item on the screen with the pointer, and then press the touch pad to select it.

You can also move the Samsung Smart Control in the same fashion to scroll scrollable screens up and down.

- If you stop using the Motion Function, even momentarily, put your finger on the touch pad, and then move the Samsung Smart Control to re-start the function.

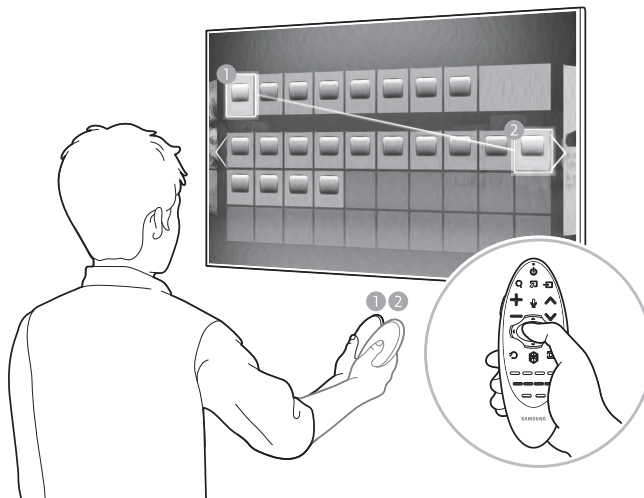

Using the Touch Pad and the Directional Buttons

- In the TV's menu, navigate to **Support > Smart Control Tutorial** to view a tutorial that shows how to use the touch pad.
- If the touch pad's sensitivity is too high or low, navigate to the **System > Smart Control Settings** menu, and then select the **Touch Sensitivity** option to change the touch pad sensitivity.

Moving the Focus or Pointer



Press the directional buttons (up, down, left, and right) to move the focus, pointer, or cursor in the direction you want.

Entering the Menu / Selecting an Item



To enter a menu or select an item, highlight the item or the menu title, or move the pointer over it, and then press the touch pad.

Displaying a Context-sensitive Menus in Smart Hub



In Smart Hub, highlight an item, and then press and hold the touch pad. The context-sensitive menu for the item pops up.

- The context-sensitive menu may vary depending on the item you selected.

Changing the Smart Hub Panel



On a Smart Hub panel, drag left or right on the touch pad. The previous or next Smart Hub panel appears.

Scrolling on the Web Browser



When you are using the web browser, drag up or down on the touch pad to scroll the web screen.

Reconnecting the Samsung Smart Control to the TV

If the Samsung Smart Control stops operating or works abnormally, try replacing the batteries. If the problem persists, pair the Samsung Smart Control and TV again.

1. Move to within a foot of the TV, and then aim the Samsung Smart Control at the TV's remote control receiver.

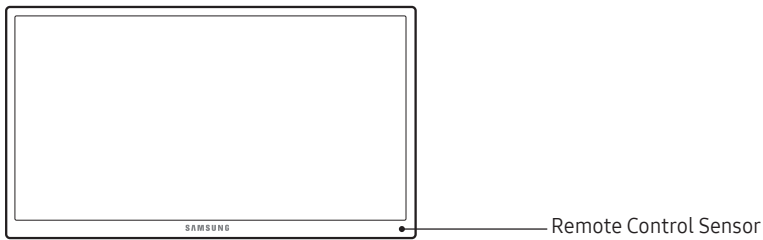

2. Press the RETURN button and GUIDE button simultaneously for 3 seconds.
3. The connection icon appears on the screen. A few moments later, the connected icon appears. The Samsung Smart Control is paired to the TV.



The Low Battery Alarm Window

If the Samsung Smart Control's batteries become low, the Low Battery Alarm appears on the screen. When the Alarm appears, replace the batteries. We recommend using alkaline batteries for longer operating life.





<Low battery Alarm Icon>

Displaying and Using the On-Screen Remote

Press the **KEYPAD** button on the Samsung Smart Control to display the On-Screen Remote on the TV's screen. Use the On-Screen Remote to enter numbers, control content playback, and use the features and functions of the TV, just like a real remote. Use the directional buttons on the Samsung Smart Control to move the cursor on the On-Screen Remote. Press the touch pad on the Samsung Smart Control to select.

– The On-Screen Remote buttons may vary depending on the TV features or functions you are using.

Button	Description
	Lets you switch channels by entering channel numbers directly. Select Pre-CH to return to the previous channel.
	Controls the playback of video, photo, or music files from all sources, and the playback of media content on external devices (for example, a Blu-ray player).
A, B, C, D	Use these colored buttons to access additional options specific to the feature in use.
TOOLS	Press to display the Tools menu while you are watching TV. The Tools menu gives you easy access to frequently used functions. The functions listed are context-sensitive and vary depending on how you are currently using the TV.
INFO	Shows information about the current digital broadcast program or content.
MENU	Displays the TV's menu on the screen.
3D	Lets the 3D source displayed.
PIP	Lets you display video from an external device or computer on the main screen and a TV broadcast in a picture-in-picture window.
CC	Select to turn subtitles on or off.
P.Size	Changes the picture size.
SLEEP	This function automatically shuts off the TV after a preset period of time.
P.Mode	Lets you select the Picture Mode.
Web Browser	Launches the Web Browser.
ALARM	Set the alarm time when TV will automatically be turned on.
	<p>Move To The Right / Move To The Left: Moves the Onscreen Remote on the screen.</p> <p>Large Size / Normal Size: Resizes the Onscreen Remote on the screen. Alternatively, navigate to the System > Smart Control Settings menu and select and set the Onscreen Remote Size option.</p> <p>Touch Sensitivity: Lets you change the touch pad sensitivity. Alternatively, navigate to the System > Smart Control Settings menu and select and set the Touch Sensitivity option.</p> <p>Cancel: Select to close a pop up menu.</p>

Connecting to the Network

You can set up your TV so that it can access the SMART TV applications through your local area network (LAN) using a wired or wireless connection.

- After you have “physically” connected your TV to your network, you must configure the network connection to complete the process. You can configure the connection after the Initial Setup process, through the TV’s menu.

Network Connection - Wireless

Connect the TV to the Internet using a standard wireless router or modem.

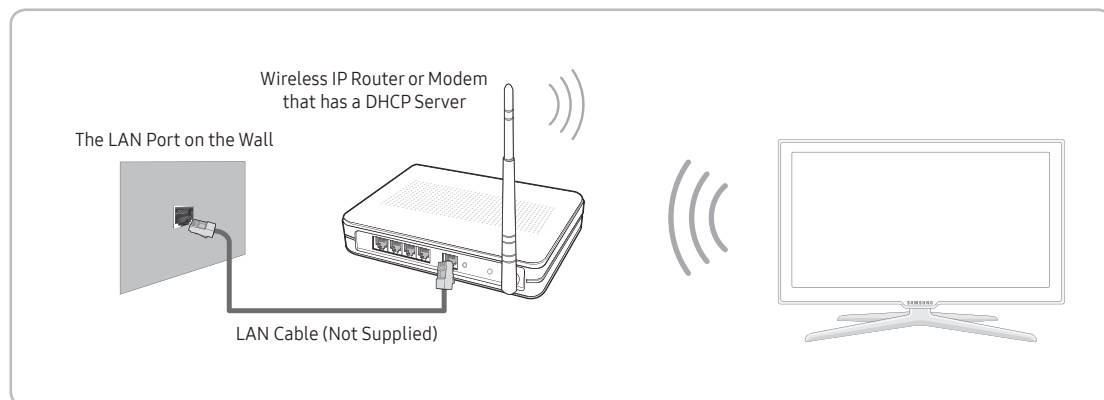

Network Connection - Wireless

- This Smart TV supports the IEEE 802.11a/b/g /n communication protocols. Samsung recommends using IEEE 802.11n. Otherwise, when you play video over a network connection, the video may not play smoothly.
- To use a wireless network, the TV must be connected to a wireless router or modem. If the wireless router supports DHCP, the TV can use a DHCP or static IP address to connect to the wireless network.
- Select a channel that is not currently in use for the wireless router. If the channel set for the wireless router is currently being used by another device, the result is usually interference and/or a communications failure.
- Most wireless networks have an optional security system. To enable a wireless network’s security system, you need to create a security key using characters and numbers, and then enter that key into the router through its menu. You then must enter this security key into any other devices you want to connect to the wireless network.

Network Security Protocols

The TV only supports the following wireless network security protocols:

- Authentication Modes: WEP, WPAPSK, WPA2PSK
- Encryption Types: WEP, TKIP, AES

In compliance with the newest Wi-Fi certification specifications, Samsung TVs do not support WEP or TKIP security encryption in networks running in the 802.11n mode.

If the wireless router supports WPS (Wi-Fi Protected Setup), you can connect the TV to your network using PBC (Push Button Configuration) or a PIN (Personal Identification Number). WPS automatically configures the SSID and WPA key settings.

Your Smart TV cannot connect to uncertified wireless routers.

Network Connection - Wired

There are three main ways to connect your TV to your network using cable, depending on your network setup. They are illustrated below:

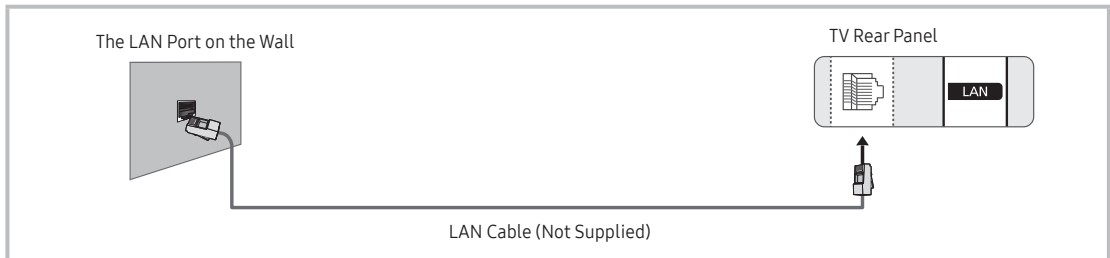
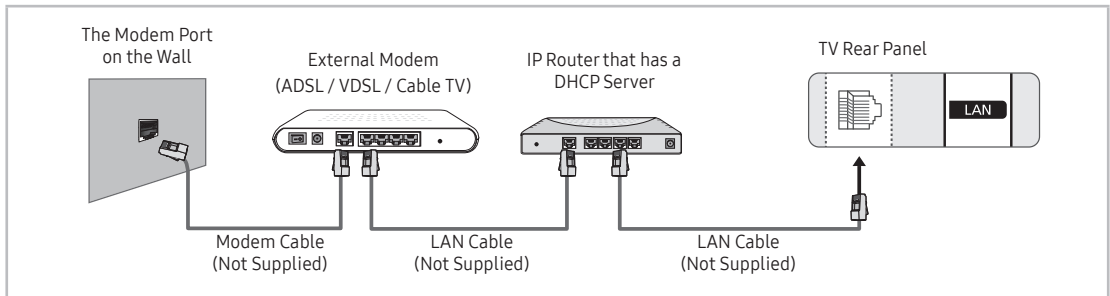
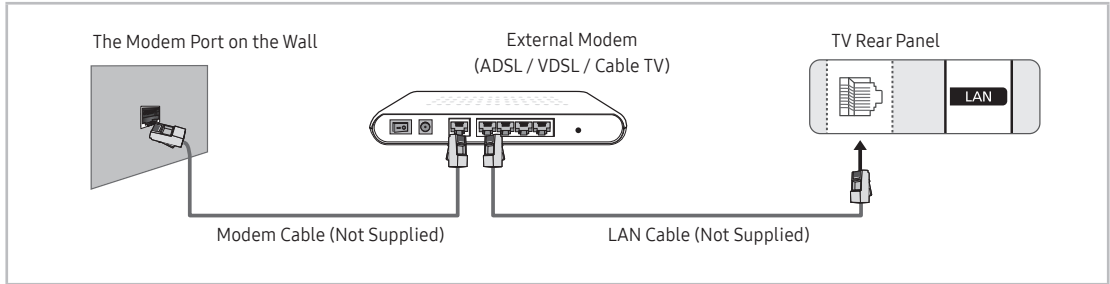

- 🔗 The TV does not support network speeds less than or equal to 10Mbps.
- 🔗 Use Cat 7 cable for the connection.

Connecting the TV to an SBB or STB

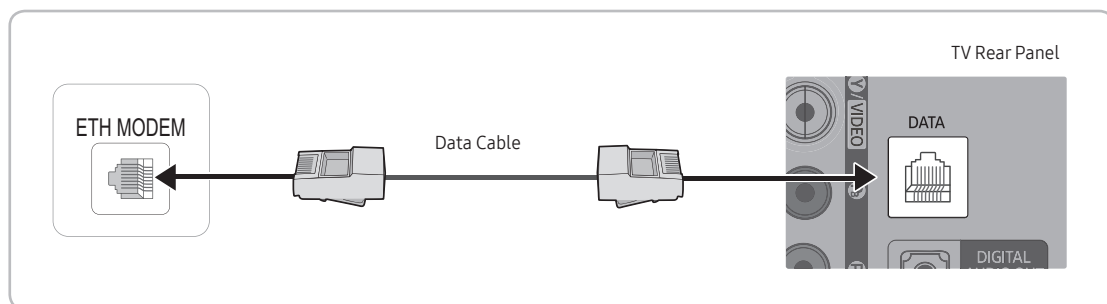

1. Connect the **DATA** jack of the TV to the **ETH MODEM** jack of the STB (SBB) with the Data cable.
 - 📌 The "ETH MODEM" jack name that you connect the Data Cable to may differ depending on the SBB or STB type.

List of Hospitality SI Vendors and Compatible Data Cables Supplied with the TV

- Confirm you are using the correct data cable for your SI vendor. Refer to the code label on the data cables.
- Contact your nearest dealer or your SI Vendor to buy the data cable not included in the TV.

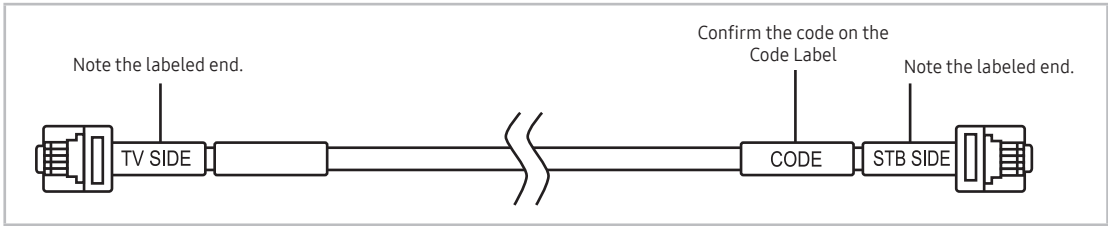

SI Vendor	Cable code	Pin assign	Remark
Samsung OCC Enseo Guest-Tek	BN39-00865B	<p><CON A></p> <p>6: IR 5: GND 4: Tx 3: NC 2: Rx 1: NC</p> <p>CON A CON B</p> <p>6 ••••• 1 5 ••••• 2 4 ••••• 5 3 ••••• 6</p> <p><CON B></p> <p>1: IR 2: GND 3: NC 4: NC 5: Tx 6: Rx</p>	Provided
NXTV	BN39-01011B	<p><CON A></p> <p>6: IR 5: GND 4: Tx 3: NC 2: Rx 1: NC</p> <p>CON A CON B</p> <p>6 ••••• 6 5 ••••• 5 4 ••••• 2 3 ••••• 4</p> <p><CON B></p> <p>1: NC 2: Tx 3: NC 4: Rx 5: GND 6: IR</p>	
nStreams	BN39-01110A	<p><CON A></p> <p>6: IR 5: GND 4: Tx 3: NC 2: Rx 1: NC</p> <p>CON A CON B</p> <p>6 ••••• 3 5 ••••• 4 4 ••••• 1 3 ••••• 5</p> <p><CON B></p> <p>1: Tx 2: NC 3: IR 4: GND 5: Rx 6: NC 7: NC 8: NC</p>	
Sonifi	BN39-01011E	<p><CON A></p> <p>6: IR 5: GND 4: Tx 3: NC 2: Rx 1: CLK</p> <p>CON A CON B</p> <p>6 ••••• 1 5 ••••• 2 4 ••••• 3 3 ••••• 4 2 ••••• 5 1 ••••• 6</p> <p><CON B></p> <p>1: IR 2: GND 3: Rx 4: NC 5: Tx 6: CLK</p>	Provided

📎 Operation Specification of Data Cable(RJ12) : TTL

Connecting the Audio Output to an Audio Amplifier

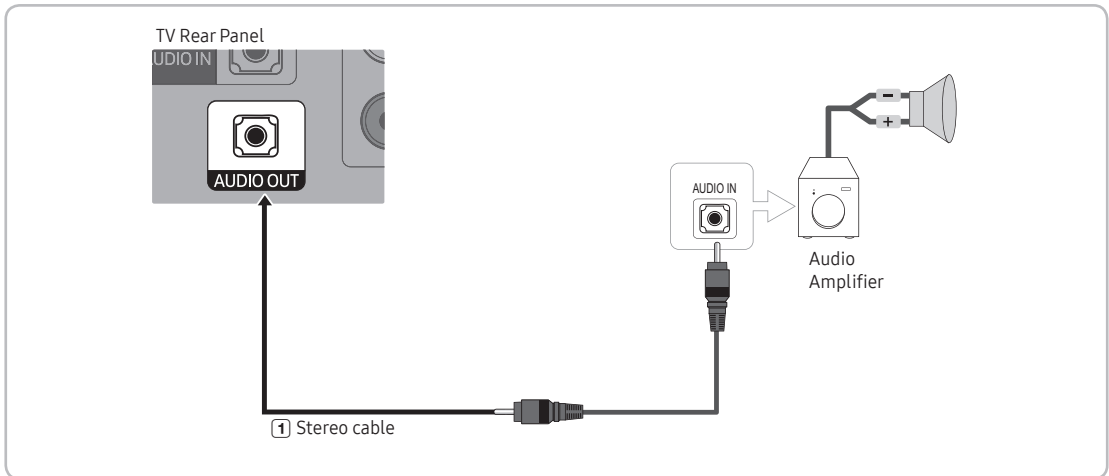

1. Connect the AUDIO OUT port of the TV to the Audio In port of an audio amplifier with a stereo cable.

Connecting the Bathroom Speakers

You can connect the Bathroom Speakers in the following manner.
Available ports may differ depending on the model.

Connecting through the Variable Output (available without an external amplifier)

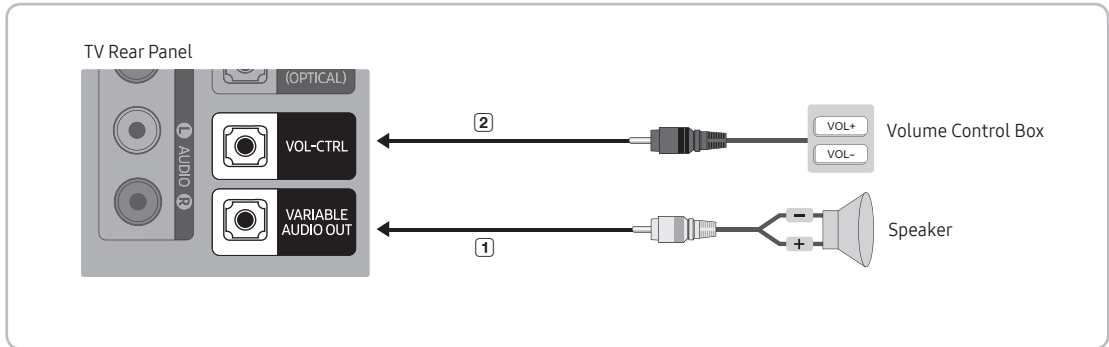

1. Connect the VARIABLE AUDIO OUT port of the TV to the Bathroom Wall Speakers of the hotel.

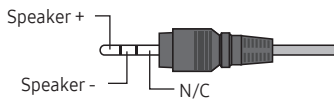

- ✎ The VARIABLE AUDIO OUT port supports MONO sound out only.
- ✎ Speaker Wire: Use speaker cable no more than 82 feet (25m) in length.
- ✎ The maximum speaker output is 4W, 8Ω.

2. Connect the VOL-CTRL jack of the TV to the Volume Control Box Switch port on the Bathroom Wall of the hotel.

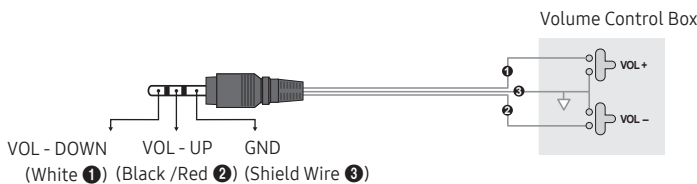

- Installing the Volume Control
 - If you configure the Volume Control Box as shown in the figure above, you can control the volume of the bathroom speakers.
 - The jack that connects the Volume Control Box to the TV is a 3.5mm normal Phone jack.
 - Volume Control Box switch is a Tact switch.
3. Set the Sub AMP Mode
 - 0: Deactivates the sub amplifier that outputs the voice signal of VARIABLE AUDIO OUT. No voice signal is output from VARIABLE AUDIO OUT.
 - 1: Adjusts the voice output of VARIABLE AUDIO OUT according to the volume level of the TV speaker. And all settings for the Hotel mode menus of Power On Volume Num, Min Volume, and Max Volume apply to the TV, speakers, and VARIABLE AUDIO OUT.
 - 2: Determines the volume according to the bathroom control panel setting.

Connecting the RJP (Remote Jack Pack)

Connect the input jacks on the TV to the RJP. The RJP lets guests connect audio and video sources to the TV.

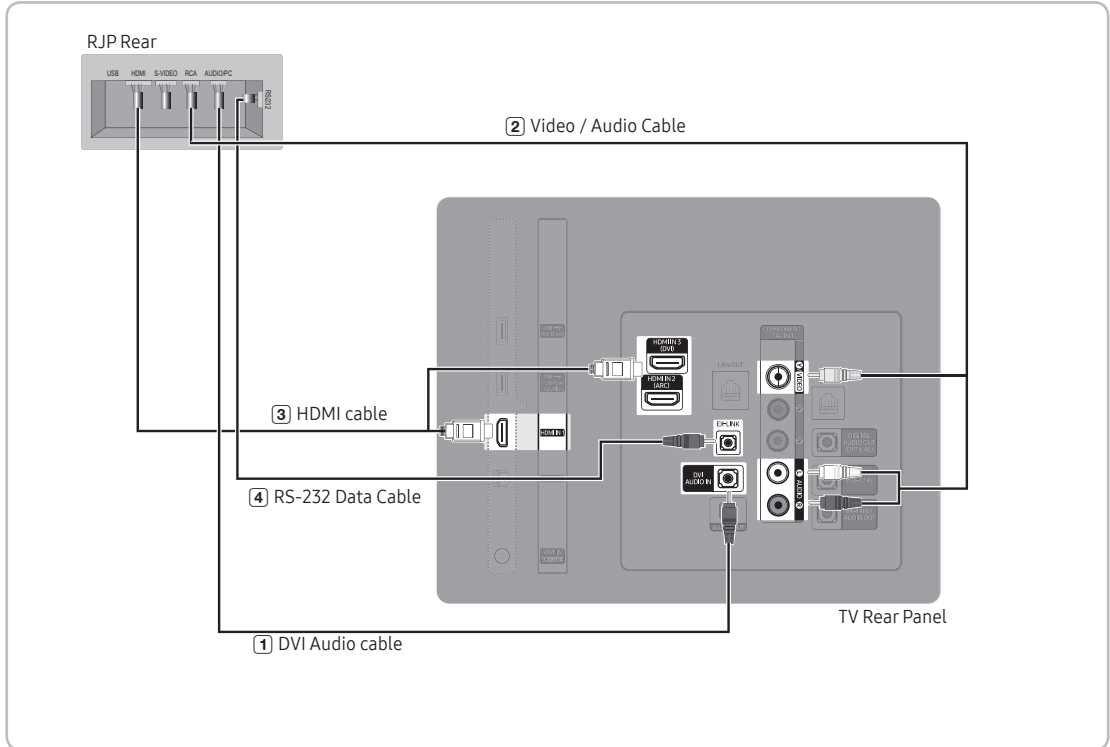

1. Connect the DVI AUDIO IN port of the TV to the PC/AUDIO port of the RJP.
2. Connect the COMPONENT IN [VIDEO] / [R-AUDIO-L] port of the TV to the RCA port of the RJP.
3. Connect the [HDMI] port of the TV to the HDMI port of the RJP.
4. Connect the EX-LINK port of the TV to the RS/232 port of the RJP.
 - 📌 This Samsung TV is compatible with the TeleAdapt TA-7610 RJP only.

- **RJP (Remote Jack Pack):** The RJP is a hardware module that has various Audio and Video inputs (A/V Video, A/V Audio, PC and HDMI) and corresponding outputs. The corresponding outputs are connected from the RJP to the TV. The RJP communicates with the TV via RS232. The RJP communicates with the TV by sending messages regarding Active/Inactive sources.
 - A group of hotel menu items let you assign numbered priorities to the jacks of the RJP. (See page 29). 1 is the highest priority and 3 is the lowest. When a guest connects external sources to the RJP jacks, the TV will automatically switch between sources based on the priority you have assigned them in the Menu. For example, lets say AV is set to 1 and HDMI to 2. If a guest has attached a device to the HDMI jack, and then plugs a device into the AV jack, the TV automatically switches to the device plugged into the AV jack (the jack with the higher priority). Note that a guest can also switch between devices manually by pushing a button on the RJP.
- To reset the RJP to its factory default state, press the AV and HDMI buttons simultaneously for 10 seconds. When all button LEDs blink 5 times, the RJP reset is complete.
- The RJP will automatically turn off any LEDs after 5 minutes to avoid unnecessary light pollution in the hotel room. The LEDs that were turned off will turn on again if the guest touches any of the buttons and the 5 minute timer will restart. If the guest then touches another source button, the TV will change to the selected source and the corresponding LED will be lit.
- After an RJP Reset or a TV Power OFF/ON, it takes approximately 10 seconds to establish communications between the TV and the RJP.
- The following table shows the approximate time in seconds it takes to switch from the TV to an input source, based on assigned or default priorities.

📎 Scenario 1: When no inputs are connected.

Source	To Connect
AV	2 Sec
PC	0.7 Sec
HDMI	3.9 Sec

📎 Scenario 2: When two or more inputs are connected to the RJP and one of the input sources is disconnected and then reconnected.

Source	Disconnect	To Connect	Total
AV	4.5 Sec	2 Sec	6.5 Sec
PC	0.7 Sec	0.7 Sec	1.4 Sec
HDMI	3.9 Sec	3.9 Sec	7.8 Sec

📎 An example: If the RJP has all its live sources (AV, PC, and HDMI) connected, AV has been assigned the highest priority, the RJP is in HDMI mode, and a guest removes and reconnects the AV source, the minimum time required to switch to the AV source is 6.5 seconds.

- To play audio devices (ipods, MP3 devices, etc.) through the RJP, you must turn Music Mode AV in the menu on. (See page 29)
- Music mode in the TA-7610 RJP is supported by the AV jack only. HDMI Music mode is available for the Guestlink RJP only.

Setting the Hotel Option Data

To let you control how the TV functions when in Hotel mode, the TV has two Hotel mode menus, the Stand-alone mode menu and the Interactive mode menu. The menu items that differ between the modes are listed below.

Menu items in the Stand-alone mode only:

- SI Vendor : Smoovie
- REACH Server and its submenus.

Menu items in the Interactive mode only:

- SI Vendor: Samsung and other vendors.

All other items appear in both modes.

To access the menus, press MUTE → 1 → 1 → 9 → ENTER [] on your Samsung remote.

After a menu appears, follow these general directions to navigate and change values:

- Use the Up and Down arrow buttons on the Samsung remote to move from menu item to menu item.
- Press the ENTER [] or Left or Right arrow buttons to select a menu item. The screen displays that menu item only.
- Press the Left or Right arrow button to change a value. The Right arrow button increases numerical values. The Left arrow button decreases numerical values.
- When the screen is displaying one menu item, you can press the Up or Down arrow button to display the next or previous menu item.
- Press the RETURN or MENU button to exit the current menu item and go to a higher menu level or the Main menu.
- To exit a Hotel mode menu, turn off the TV, and then turn it on again. Any changes you made are saved except changes to SI Vendor. For changes to SI Vendor, you must turn the TV off, wait until the Standby light glows steadily, then unplug the TV, wait for the Standby LED to go off, and then plug the TV in again.

Hospitality Mode	Standalone	Widget Solution
SI Vendor	OFF	Virtual Standby
Power On		Security Mode
Channel		DRM
Menu OSD		System
Clock		
Music Mode		
Remote Jack Pack		
External Source		
Bathroom Speaker		
Eco Solution		
Logo/Message		
Cloning		
REACH Solution		
Network		

Above: The Hotel mode menu

To change menus between the interactive mode and the standalone mode, follow the steps below :

1. Highlight the Hospitality Mode menu item in the top left corner of the menu.
2. Press the left or right arrow button on the Samsung remote. Only the Hospitality Mode menu item is displayed.
3. Press the left or right arrow button to change the Hospitality Mode item from Standalone to Interactive or from Interactive to Standalone.
4. Press the Return or Menu button on the remote. The entire menu re-appears with your selection displayed in the Hospitality Mode field.

☞ After you have set the values in one TV, you can clone those values to multiple TVs. See USB Cloning on page 35.

Menu Items

To Enter this menu: Press the MUTE → 1 → 1 → 9 → ENTER buttons in order.

To exit from this menu: Power Off (or Power Off and unplug if you have changed SI Vendor), and then turn on again. Any changes you made are saved.

Hotel TV Function		Description
Category	Item	
Hospitality Mode	Hospitality Mode	Select Hospitality mode. <ul style="list-style-type: none"> Interactive mode: TV works with an SI STB or SBB. Standalone mode: TV works alone, without an SI STB or SBB.
SI Vendor	SI Vendor	<ul style="list-style-type: none"> Interactive mode: Samsung / OCC / MTI / Nstreams / Enseo / Cardinal / Guestek / SeaChange / MDC / Innvue Standalone mode: OFF / Smoovie / SSCP
Power On	Power On Channel	Set the default values that will be applied when the TV is turned. <ul style="list-style-type: none"> User Defined: Lets you set Power On Channel and Channel Type manually. See Power On Channel and Channel Type below. Last Saved: If you select this item, when the TV is turned on, it displays the channel it was displaying when it was turned off.
	Power On Channel Num	When the TV is turned on, it switches automatically to this channel.
	Power On Channel Type	<ul style="list-style-type: none"> Select channel band: AIR (analog air band), DTV (digital air band), CATV (analog cable band), CDTV (digital cable band).
	Power On Volume	<ul style="list-style-type: none"> User Defined: Lets you set the Power On Volume manually. See Power On Volume below. Last Saved: When the TV is turned on, it returns to the volume that had been set when the power had been turned off.
	Power On Volume Num	The TV turns on with this Volume Level in Stand Alone Hospitality mode.
	Min Volume	The minimum Volume Level the user can set in Stand Alone Hospitality mode.
	Max Volume	The maximum Volume Level the user in Stand Alone Hospitality mode.
	Power On Source	Select the input source the TV displays when turns on.
Channel	Power On Option	Determines the TV's state when power returns after a power failure or after you have unplugged the TV and then plugged it in again. <ul style="list-style-type: none"> Last Option: Returns to its last Power state. If it was in Stand-by, it returns to Standby. If it was on, it turns on. Power ON: When the power returns, the TV turns on. Standby: When the power returns, the TV enters the Standby mode.
	Channel Setup	Gives you direct, immediate access to some of the Channel menu functions on the user Channel menu such as Auto Program, Antenna selection, etc.
	Channel Editor	The Channel Editor lets you edit the channels stored in the TV's memory. Using Channel Editor you can: <ul style="list-style-type: none"> Change the channel numbers and names, and sort the channels in your desired channel number order. Apply the video mute to channels you select. The video mute blanks out the video from a channel and outputs only the sound while displaying a speaker icon on the screen. The Channel Editor also lets you view information about each channel easily, without your having to display each channel directly.
	Mixed Channel Map	This Feature enables showing/browsing all antenna type (Air/Cable or Satellite) channels at the same time. <ul style="list-style-type: none"> ON: When ON, guests can access the complete Channel Map irrespective of the selected antenna type. The Channel list will also populate Air as well Cable type channels. OFF: When OFF, guest can access the Channel Map corresponding to the selected antenna type [AIR/CABLE or Satellite] only. The Channel list/Editor will only show the selected antenna type channels.
	Dynamic SI	<ul style="list-style-type: none"> ON: Check the DTV Programme channel number. (the TV channel editor is inaccessible) OFF: Do not check the DTV Programme channel number. (the DTV channel editor is accessible, but additional channel Programme number update is not supported)
Genre Editor	Mychannel	Enable or disable the My Channel feature.
	Genre Editor	Edit the genre for channels. (Available when My Channel is On)

Hotel TV Function		Description
Category	Item	
Menu OSD	Picture Menu Lock	Enable or disable the Picture Menu.
	Menu Display	<ul style="list-style-type: none"> • ON: The Main Menu is displayed. • OFF: The Main Menu is not displayed.
	Tools Display	<ul style="list-style-type: none"> • ON: The Tools Menu is displayed. • OFF: The Tools Menu is not displayed.
	Channel Menu Display	<ul style="list-style-type: none"> • OFF: The Home Menu is not displayed. • ON: The Home Menu is displayed.
	Panel Button Lock	Turning the front panel (local key) operations on/off. <ul style="list-style-type: none"> • Unlock: Unlocks all panel keys. • Lock: Locks all panel keys. • OnlyPower: Locks all panel keys except the Power panel key. • Menu/Source: Locks the Menu and Source panel keys.
	Home Menu Display	<ul style="list-style-type: none"> • OFF: The Home Menu is not displayed. • ON: The Home Menu is displayed.
	Home Menu Editor	Edit Home Menu .
	Home Menu Auto Start	<ul style="list-style-type: none"> • ON: The Home Menu is Auto Start. • OFF: The Home Menu is not Auto Start.
	BT Auto Remove Device List	<ul style="list-style-type: none"> • Delete Device List in when power on or off. • ON: Connection history is removed in BT Music Player. • OFF: Disable this feature.
Clock	Clock Type	<ul style="list-style-type: none"> • OFF: The feature of SW Clock becomes not available. • SW Clock: If this item is selected and a user presses the INFO key of the remote twice consecutively in the standby mode of TV, the clock information is displayed in the screen of TV and then TV is turned off automatically.
	Local Time	Select the way to update the clock data <ul style="list-style-type: none"> • Manual: The clock is set automatically from the DTV channel or manually by the user when the TV is in stand-alone mode. • Time Channel: The clock is set from the selected channel.
	Timer Type	Enable or disable the alarm function. <ul style="list-style-type: none"> • WakeUp : Enable the alarm function to turn on the device at the specified time. • OnOff : Disable the Alarm function.
Music Mode	Music Mode AV	Allows music output from an mp3/audio player connected to an AV Input Source on the TV. When on, you can hear sound from the player through the TV whether there is a video signal or not. Also mutes the video so the TV does not display a picture when a guest is playing music. The TV's backlight, however, remains on.
	Music Mode Comp	Allows music output from an mp3/audio player connected to an Component Input Source on the TV. When on, you can hear sound from the player through the TV whether there is a video signal or not. Also mutes the video so the TV does not display a picture when a guest is playing music. The TV's backlight, however, remains on.
	Music Mode Backlight	When set to Off, the TV's backlight is turned off entirely when a guest uses the Music mode. To save energy, set to Off.
Remote Jack Pack	Priority AV	Lets you set the priority of the 7610 RJP AV jack. You can choose 1, 2, or 3, with 1 being the highest and 3 the lowest. The TV automatically displays the source with the higher priority. For example, lets say AV is set to 1 and HDMI is set to 2. If a guest has attached a device to the HDMI jack, and then plugs a device into the AV jack, the TV will automatically switch to the device plugged into the AV jack (the jack with the higher priority). Note that a guest can also switch devices manually by pushing a button on the 7610 RJP.
	Priority HDMI	Lets you set the priority of the 7610 RJP HDMI jack. You can choose 1, 2, or 3, with 1 being the highest and 3 the lowest. The TV automatically displays the source with the higher priority. See above for a more detailed explanation.
	AV Option	Select which AV source of the TV is connected to the RJP jack.
	HDMI Option	Select which HDMI source of the TV is connected to the RJP jack. (HDMI1/HDMI2/HDMI3)
	HDMI Music Mode	Allows music output from an mp3/audio player connected to an HDMI Input Source. When on, you can hear sound from the player through an HDMI input of the RJP whether there is a video signal or not. (This option is only compatible with the Guest link RJP.)

Hotel TV Function		Description
Category	Item	
External Source	USB Pop-up Screen	When USB is connected to the TV : <ul style="list-style-type: none"> • Default: a popup window appears. • Automatic: This enters the USB content menu automatically. • Disable: Neither the popup window nor the menu appears.
	External Source Banner	If set to On, the TV displays the External Source Banner (information) when you change the TV source to another external input, press the Info key, or turn the TV on. <ul style="list-style-type: none"> • ON: The External Source information is displayed on the TV screen. • OFF: The External Source information is not displayed on the TV screen.
	Auto Source	<ul style="list-style-type: none"> • ON: When an external input source is connected to the TV, the TV identifies the input source, and then automatically switches to that input source. • OFF: Auto Source function is Off.
	Anynet+ Return Source	Select the return TV source after stopping an Anynet+(HDMI-CEC) connection. (This function is especially useful for the Guestlink RJP.)
Bathroom Speaker	Sub Amp Mode	Determines the Bathroom Speaker sound AMP operation mode. <ul style="list-style-type: none"> • 0: Turns the Bathroom Speaker sound AMP function off (PWM off). • 1: The Bathroom Speaker sound volume follows the TV speaker sound volume identically. The Bathroom Speaker sound volume is controlled by the TV remote or panel keys. • 2: The Bathroom Speaker sound volume is controlled by the Bathroom Speaker volume controller.
	Sub Amp Volume	The initial Bathroom Speaker sound volume after TV is turned on.
Eco Solution	Energy Saving	Adjusts the brightness of the TV to reduce power consumption. <ul style="list-style-type: none"> • OFF: Turns off the energy saving function. • Low: Sets the TV to low energy saving mode. • Medium: Sets the TV to medium energy saving mode. • High: Sets the TV to high energy saving mode.
Logo/Message	Welcome Message	Displays a the Welcome Message for 5 seconds when the TV turns On.
	Edit Welcome Message	Edits the Welcome Message.
	Hospitality Logo	Turns the Hospitality logo feature On or Off, If On, when the TV is turned on, the Logo is displayed, before the signal from the initial source, for the amount of time set in "Logo Display Time".
	Hospitality Logo DL	Downloads the Hospitality logo. Hospitality logo file requirements: <ul style="list-style-type: none"> • BMP or AVI files only. • Max file size: BMP - 960 X 540. AVI - 30MB. • The file can only be named <code>samsung.bmp</code> or <code>samsung.avi</code>.
	Logo Display Time	Hospitality Logo Display Time (3/5/7 seconds).
Cloning	Clone TV to USB	Clone the current TV options to a USB memory device.
	Clone USB to TV	Clone the saved TV options on a USB memory device to the TV.
	Setting Auto Initialize	If you set Setting Auto Initialize to On, and the TV's power is turned off and on, TV menu items are restored again to their values cloned initially. See page 39.
REACH Solution	REACH	<ul style="list-style-type: none"> • ON: The feature of REACH in this TV becomes available. • OFF: The feature of REACH in this TV becomes not available.
	REACH IP Mode	If enabled, Reach will work over IP instead of RF.
	Server IP Setting	The URL of the Reach IP server, for example <code>https://192.168.1.2:443</code> .
	REACH Channel	Assign a DTV channel number to carry the update REACH data. This channel number must be the same as the number set on the Reach server.
	REACH Update Time	Lets you set when data such as updated SW, cloning files, and S-LYNC REACH contents is downloaded from the REACH server to the TV : <ul style="list-style-type: none"> • 1hour: Every hour • 2hour: Every 2 hours • 12:00 am: every 12:00 a.m. • 2:00 am: every 2:00 a.m. • 12:00 pm: every 12:00 p.m. • 2:00 pm: every 2:00 p.m.
	REACH Update Immediate	<ul style="list-style-type: none"> • ON: Whenever the TV enters standby mode (the power cord is plugged in and the power is off), the REACH data is updated on the TV. • OFF: The REACH data is only updated on the TV at the REACH server update time.
	Group ID	Select the group ID of the REACH server. (Refer to the REACH server manual for more details)
	Room Number	Set the room number
	IPG Room Type	Selects the IPG room type of the REACH server. (Refer to the REACH server manual for the more information.)
	REACH Config Version	The version of REACH is displayed.

Hotel TV Function		Description
Category	Item	
Network	Network Setup	<p>If this item is entered into, network setup menu is displayed. The network setup menu is used for setting network like access internet.</p> <p>Soft AP: Using this function, you can connect the TV on your mobile devices. Set the options for connection of Wi-Fi device.</p> <ul style="list-style-type: none"> • Soft AP: Turns on or off the Soft AP. When Soft AP is set to On, your mobile devices can find the TV name in Wi-Fi connection list. • Security key: Set a security key that you need to enter on other devices so they can connect to the TV. <ul style="list-style-type: none"> – Input the generated security key into the device you want to connect. – If network does not operate normally, check the security key again. An incorrect security key may cause a malfunction. <p>📎 Soft AP may not be available if it is not supported by the model.</p> <p>📎 Maximum number of devices that can be connected: 4 devices.</p> <p>📎 Bitrate : 10 Mbps/device.</p> <p>📎 The specifications above are based on our in-house testing. Actual performance may vary depending on your wired/wireless network environment.</p>
	SmartHub Model Setting	Set SmartHub Model.
	SmartHub Setting	Set up SmartHub.
	Lan Out	Enable/disable LAN Out. When enabled, the TV can work as a wired router for other network devices.
	VLAN ID	Create separate VLAN groups. A 3-digit number can be entered between 1 and 255 for the VLAN ID.
	Solution VLAN ID	When VLAN is used, set a VLAN ID to be assigned to a Solution (such as SYNC, H.Browser etc.).
	Device VLAN ID	Set a VLAN ID to be assigned to external devices connected to the LAN OUT port.
Widget Solution	Widget Mode	<ul style="list-style-type: none"> • ON: The TV mode is changed to the Widget mode that TV accesses to the hospitality server through IP connection and the guest uses various services and features through Widget of TV • OFF: The TV mode becomes normal the hospitality mode.
	Solution Type	<p>Select the type of the solution server installed in your site for the widget service.</p> <ul style="list-style-type: none"> • Vendor Server: In the case of that the special SI vendor of the server is installed in your site. • SINC Server: In the case of that the Samsung SINC server is installed in your site.
	Server URL Setting	If this item is entered into, URL of the solution server can be inputted.
	License Server IP Setting	If this item is entered into, URL of the license server can be inputted.
	IPTV Mode	<ul style="list-style-type: none"> • ON: The IPTV mode that watches the broadcasting through the IP network is enable. • OFF: The IPTV mode is not disable
	Room Num Setting	Set the room number
Virtual Standby	Virtual Standby Mode	<p>TV can supply the main feature in the standby mode if The TV mode is set to the Virtual Standby mode.</p> <ul style="list-style-type: none"> • ON: The Virtual Standby mode is enable. • OFF: The Virtual Standby mode is disable. <p>When Virtual Standby is On, TV power consumption will be 9.5W to 17.4W (Depending on the size of the TV screen).</p>
	Reboot Time	This Feature can set the Reboot interval of TV after TV enters Virtual standby Mode.
Security Mode	Factory Lock	<p>Delete Device List in when power on or off.</p> <ul style="list-style-type: none"> • ON: The password is needed before entering factory menu. • OFF: disable this feature.
	Password Popup	Enable/disable Password Popup. If this option is set to OFF, the TV will not display the password input popup window when entering the Factory menu. If set to ON, the password input popup window appears.
	Password Input	If this option is enabled, a popup input box appears which asks for an 8-character security password. The admin must enter a password before applying or updating security preferences. After the correct password is entered, options such as Password Setting, Password Reset and Security Mode are available.
	Password Setting	User can change the password.
	Password Reset	Password is reset to "00000000".
	Security Mode	Security Mode provides password protected administrative functionality to enable or disable features of Hospitality TV, such as HDMI, USB and TTX. Use this option to turn security mode on or off. After turning on security mode, options such as "USB," "HDMI" and "TTX Security" are automatically enabled in the security sub-menu. "USB to TV cloning" and "TV Reset" will be disabled in the Hospitality Menu.
	USB	Enable/disable USB access. When disabled, access to USB media is blocked.
	HDMI	Enable/disable HDMI access. If disabled, Anynet, HDMI source, HDMI type External Channels will not be accessible to the user.

Hotel TV Function		Description
Category	Item	
DRM	DRM Mode	Configures DRM support. OFF: Turns off DRM support. LYNK DRM: Select to turn on S-LYNK DRM CAS support only. Pro:Idiom: Select to turn on Pro:Idiom CAS support only. LYNK DRM,PI: Select to have the TV support S-LYNK DRM CAS and Pro:Idiom CAS.
	PI AES Data	Displays the current state of Pro:Idiom AES
	PI AES Log	<ul style="list-style-type: none"> ON: Output of Pro:Idiom AES log is enable. OFF: Output of Pro:Idiom AES log is disable.
	View PI AES Log	If this item is entered into, the Pro:Idiom AES log is displayed.
System	Self Diagnosis for TV	<ul style="list-style-type: none"> Enter Self Diagnosis Menu. Picture Test: Use to check for picture problems. If the problem appears in the test picture, select Yes and follow the directions on the screen. Sound Test: Use the built-in melody sound to check for sound problems. If the problem occurs during the test, select Yes and follow the directions on the screen.
	Self Diagnosis for HTV	Lets you check the state of Pro:Idiom and its communication with the SI STB or SBB. If you have any problems with the Pro:Idiom encryption channel or the communications with the SI STB or SBB, use this diagnosis function. If Pro:Idiom DTV Channel Key Loss appears to have failed and the Pro:Idiom encryption channel has failed to play content, first check the broadcasting systems related to Pro:Idiom encryption. If your broadcasting system does not have a problem, contact Samsung Service. If STB SI Vendor Setting appears to have failed and communication with the SI STB or SBB has failed, first check your SI STB or SBB. If your SI STB or SBB does not have a problem, contact to Samsung Service.
	SW Update	Lets you upgrade the TV SW with a USB memory stick. See Page 42.
	Service Pattern	Lets you check the state of the TV picture by displaying picture test patterns. Press the Menu button to turn off the test patterns and exit.
	ATV Cable AGC Gain	Lets you control the AGC gain of the analog cable channels. Don't change the default value unless problems occur.
	DTV OpenCable AGC Gain	Lets you control the AGC gain of the digital cable channels. Don't change the default value unless problems occur.
	Sound Bar Out	<p>If the Samsung Sound Bar device is connected to this TV, this item lets you to select where the TV sound is outputted when the TV is turned on.</p> <ul style="list-style-type: none"> ON: When the TV is turned on, the TV sound is automatically outputted in the Sound Bar device only. OFF: When the TV is turned on, the TV sound is automatically outputted in the TV speaker device only. <p>See Page 42.</p>
	Contact Samsung	Display the web site of related Samsung service center, software version, and Mac address information.
	Standby LED	<p>When the TV is in standby mode, you can configure the settings of external LED.</p> <ul style="list-style-type: none"> ON: The LED is on. OFF: The LED is off.
TV Reset	Returns all settings on the TV to their factory defaults.	

🔧 REACH (Remote Enhanced Active Control for Hospitality) is a professional, interactive remote controller that lets you deliver TV firmware updates, cloning data, channel mapping changes, REACH contents, and TICKER contents through RF DTV to several hundred hospitality TVs simultaneously. The REACH functions are available only in standalone mode. The REACH Server is sold separately. Refer to the REACH server manual enclosed with the REACH server product for more operating information.

Welcome Message

The Welcome Message feature displays a custom message on the TV every time it is turned on.

- Welcome message settings are in the Hotel Option Menu.
- Set Welcome Message to ON to display the message when the TV is powered on.

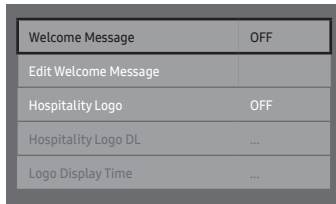

- You can make the Welcome Message up to 25 characters long and edit it in the Hotel Service menu.
- Welcome Message supports the following characters:
 - ✎ Capital Letters from A to Z.
- You can edit the Welcome Message by using the remote's navigation, color, and Enter buttons in the “Edit Welcome Message” OSD (See the illustration below.)

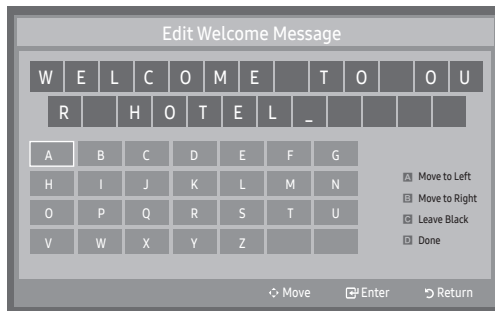

Below are the general directions for navigating and changing letters on the Edit Welcome Message screen:

- Press the **A** button on the remote to move to the left in the message.
- Press the **B** button to move to the right.
- After you have selected a position in the message, use the arrow buttons on your remote to select a letter in the alphabet below the message.
- Press **Enter** to place a letter into the position you selected.
- Press the **C** button to erase a letter in a position or enter a blank.
- Press **Return** or the **D** button to exit.

Hotel Logo

The Hospitality Logo function displays the Hotel's picture image when the TV is powered on.

- Hospitality Logo settings are the Hotel mode menus.
- The Logo Download and Logo Display Menu items are enabled when you turn the Hospitality Logo option on.
- If there is a logo image stored in memory and the Hospitality Logo option is on, the Hospitality logo is displayed when the TV is turned on.
- The Hospitality logo is not displayed when the Hospitality found Logo option is off, even if the logo image has been loaded into the TV.

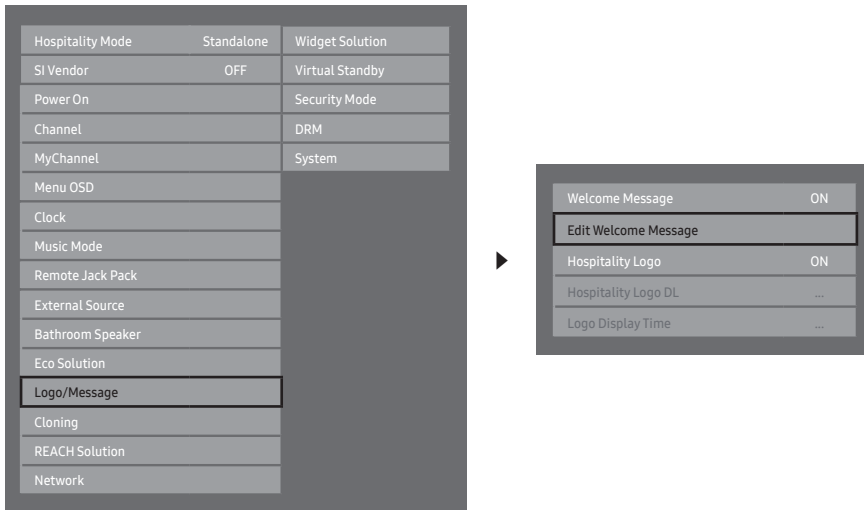

- **Hospitality Logo**
 - This option lets you choose whether the Hospitality Logo image is displayed or not.
 - Initial value is OFF.
 - Can be set to OFF or ON.
 - When set to ON, the Logo Download and Logo Time Display menu items become accessible.
- **Logo Download**
 - This option lets you download the logo image to the TV's memory from a USB device.
 - A wait message appears while the image is being copied to the TV.
 - A "completed" message appears when the copy operation finishes successfully.
 - The word "failed" appears if the copy operation was unsuccessful.
 - **No USB** appears if no USB device is connected.
 - **No File** appears if there is no file to copy on the USB device or the file is in the wrong format (must be a BMP or AVI file). If No File appears and there is a logo file on the USB device, check the file format.
- **Logo File Format**
 - The TV supports only BMP and AVI format.
 - The file name must be samsung.bmp or samsung.avi.
 - The maximum resolution of the BMP format is 960 x 540.
 - The maximum file size for AVI format is 30MB.
 - The TV does not change the size or scale of the image.

USB Cloning

The USB Cloning function lets you download user-configured settings (Picture, Sound, Input, Channel, Setup, and Hotel Setup) from one TV to a USB device, and then upload these settings from the USB device to other TV sets. This lets you create a standard file of settings and distribute that standard file to all the TVs in your facility.

After cloning, certain features are applied when the TV is turned on again.

- **Cloning TV to USB:** Copies stored menu settings from a TV to a USB device.

1. Insert a USB drive into the USB port on the rear of the TV.
2. Enter the hotel option menu by pressing buttons in order.
MUTE → 1 → 1 → 9 → ENTER
3. Press the ▲ or ▼ button to select **Cl one:TV to USB**, and press the ENTER button.
4. When the message **Clone: TV to USB** is displayed. Press the ENTER button.
5. The TV displays one of the following messages:
 - **In Progress:** Copying data to USB.
 - **Completed:** Copy was successful.
 - **Failed:** Copy was not successful.
 - **No USB:** USB is not connected.

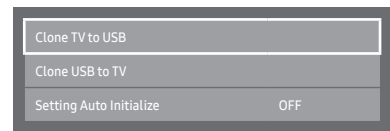
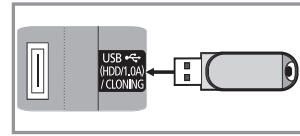

The clone folder will be labeled T-MST14AKUCB.

The cloned values include the values on the Guest side menu (brightness, picture size, contrast, etc.) and the Hotel side menu.

Cloning USB to TV: Copies menu settings in a USB device to a TV.

Shortcut: Turn the TV off, insert the USB device, turn the TV on, and then press the ENTER button for 5 seconds.

To clone data to the TV using the Hotel menu, follow these steps:

1. Turn the TV off.
 2. Insert the USB drive into the USB port on the rear of the TV.
 3. Turn the TV on.
 4. Enter the Interactive menu by pressing these buttons in order.
MUTE → 1 → 1 → 9 → ENTER
 5. Press the ▲ or ▼ button to select “Clone USB to TV”, and then press the ENTER button.
 6. The message **Clone: USB to TV** is displayed. Press the ENTER button.
 7. The TV displays one of the following messages:
 - **In Progress:** Copying data to TV.
 - **Completed:** Copy was successful.
 - **Failed:** Copy was not successful.
 - **No USB:** USB is not connected
 - **No File:** There is no file to copy on the USB device. If you get a No File message, check the folder on your USB device. The folder name should be T-MST14AKUCB.
- Tables that list the settings that are cloned in the Interactive and Standalone Hotel Menus begin on the next page.



Settings Cloned in the Hotel Menu

Menu Item	Cloning Support
Hospitality Mode	Yes
SI Vendor	Yes
Power On Channel	Yes
Power On Channel Num	Yes
Power On Channel Type	Yes
Power On Volume	Yes
Power On Volume Num	Yes
Min Volume	Yes
Max Volume	Yes
Power On Source	Yes
Power On Option	Yes
Channel Setup	N/A
Channel Editor	N/A
Channel Bank Editor	N/A
Channel Bank Service Level	Yes
Mixed Channel Map	Yes
Dynamic SI	Yes
Channel Rescan Message	Yes
Pan Euro MHEG	Yes
Channel Auto Store	N/A
Mychannel	Yes
Genre Editor	N/A
Mute On CC	Yes
Subtitle Auto On	Yes
TTX Widescreen Mode	Yes
Picture Menu Lock	Yes
Menu Display	Yes
Tools Display	Yes
Channel Menu Display	Yes
Panel Button Lock	Yes
Home Menu Display	Yes
Home Menu Editor	N/A
Home Menu Auto Start	Yes
Gallery Mode Editor	N/A
Bluetooth Music Player	Yes
Clock Type	Yes
Local Time	Yes
Time Format	Yes
Clock Test	N/A
Clock Normal Dim.	Yes
Clock Standby Dim.	Yes
Timer Type	Yes
Time Channel Type	Yes
Time Channel Num	Yes
Music Mode AV	Yes

Menu Item	Cloning Support
Music Mode PC	Yes
Music Mode Comp.	Yes
Music Mode Backlight	Yes
Priority AV	Yes
Priority PC	Yes
Priority HDMI	Yes
AV Option	Yes
HDMI Option	Yes
HDMI Music Mode	Yes
Video Out	Yes
USB Pop-up Screen	Yes
External Source Banner	Yes
Auto source	Yes
Anynet+Return Source	Yes
HP Mode	Yes
Default HP Volume	Yes
Main Speaker	Yes
Sub Amp Mode	Yes
Sub Amp Volume	Yes
Pillow Speaker Type	Yes
Speaker Select	Yes
Pillow Volume	Yes
Energy saving	Yes
Energy Saving Timer	Yes
Welcome Message	Yes
Edit Welcome Message	N/A
Hospitality Logo	Yes
Hospitality Logo DL	N/A
Logo Display Time	Yes
Clone TV to USB	N/A
Clone USB to TV	N/A
Setting Auto Initialize	Yes
REACH 3.0	Yes
REACH 2.0	Yes
REACH Channel	Yes
Group ID	N/A
IPG Room Type	Yes
Ticker	Yes
REACH Update Time	Yes
REACH Update Immediate	Yes
Room Number	N/A
REACH 2.0 TV Sound	Yes
REACH Server Version	N/A
Network Setup	N/A
SmartHub Model Setting	N/A
SmartHub Setting	N/A

Menu Item		Cloning Support
Service Discovery		Yes
Lan Out		Yes
VLAN ID		Yes
Solution VLAN ID		N/A
Device VLAN ID		N/A
Widget Mode		Yes
Solution Type		Yes
Server URL Setting		N/A
License Server IP Setting		N/A
IPTV Mode		Yes
Virtual Standby		Yes
Instant On		Yes
Room Num Setting		N/A
Widget Resolution		Yes
PHY Sleep Mode		Yes
MDC ID Settings		Yes
TV Version		Yes
Door Eye Mode		Yes
Door Eye Source		Yes
Prompt OSD		Yes
Source Return Time		Yes
Password Input		N/A
Password Setting		N/A
Password Reset		N/A
Security Mode		Yes
USB		Yes
HDMI		Yes
TTX Security		Yes
DRM Mode		Yes
PI AES Data		N/A
PI AES Log		Yes
View PI AES Log		N/A
Self Diagnosis for TV		Yes
Self Diagnosis for HTV	PI DTV Channel Key Loss	N/A
	STB SI Vendor Setting	N/A
	Bathroom AMP	N/A
	RTC	N/A
SW Update		N/A
Service Pattern		Yes
ATV Cable AGC Gain		Yes
DTV Open Cable AGC Gain		Yes
Sound Bar Out		Yes
Contact Samsung		N/A
Standby LED		Yes
TV reset		N/A

Multi Code Remocon

A Multi Code Remocon is a special remote which is designed to control multiple TVs.

This function is useful where there is more than one TV in a location.

You can control up to 10 TVs with a different ID code of each remote with no conflicts between the TVs. ID numbers are displayed on each TV's OSD.

The Initial ID code for each TV is "0".

- You can set and reset the ID code in Analog TV mode or PC mode. (Not available in DTV mode.)
- You can set the ID code to any digit from 0 to 9.
- To set a TV's ID code, follow these steps:
 1. Aim the remote at the TV, and then press the MUTE button and the RETURN button simultaneously for more than 7 seconds. When you stop pressing the buttons, the TV displays the current ID in the middle of the screen and the words, "Remote control code is set to 0. If you want to change the Remote control code, enter the digit you want to change."
 2. Press the number on the remote you want to assign to the TV. The TV displays the following words: "Remote control code is changed to x."
 - ☞ The TV will display the OSD until you press the EXIT button.

See the example below.

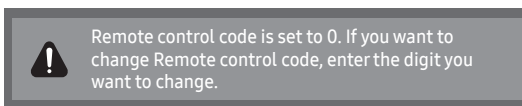

Example: After you see the message above, if you press 1, the TV and Remote will be set to ID code 1. The TV then displays the following message: "Remote control code is changed to 1"

The TV can then only be controlled by a remote which has the same ID code (1).

- To reset the ID code, press the MUTE button and the EXIT button simultaneously for more than 7 seconds. When you stop pressing the buttons, the ID codes of the TV and Remote are reset to "0". "Remote control code is set to 0." appears on the TV

Setting Auto Initialize

When you clone settings from one TV to another, you clone both the guest side menu and hotel side menu settings: Picture, Sound, Input, Channel, Setup, and Hotel Setup. This lets you set nearly all of the menu values on your hospitality TVs to the same, standard settings. If you allow guests access to the guest side menus, for example the Picture menu, they can change the settings in those menus so they are no longer standard. If you set the Setting Auto Initialize function to on the TV automatically restores (initializes) any guest-side menu values to the cloned, standard values when the TV is turned off and then turned on again. Note that Setting Auto Initialize works on cloned guest side menu values only. Settings which have not been cloned are ignored.

The table below lists the settings that are restored to their cloned values when you set the Setting Auto Initialize function to On.

Menu	Menu Item	Menu	Menu Item
Picture	Picture Mode	System	Accessibility
	Back light		Voice Guide
	Contrast		Video Description
	Brightness		Caption
	Sharpness		Menu Transparency
	Color		High Contrast
	Tint (G/R)		Enlarge
	Apply Picture Mode		Menu Language
	Picture Size		Smart Control Settings
	Picture Size		Motion Sensitivity
	Position		Touch Sensitivity
	PIP		Onscreen Remote Size
	Advanced Settings		Voice Control
	Dynamic Contrast		Language
	Black Tone		TV Voice
	Flesh Tone		Voice Gender
	RGB Only Mode		Device Manager
	Color Space		Keyboard Settings
	White Balance		Mouse Settings
	Gamma		Time
	Motion Lighting		Clock
	Picture Options		Sleep Timer
	Color Tone		Wake-up Timer
	Digital Clean View		Eco Solution
	MPEG Noise Filter		Energy Saving
	HDMI Black Level		Eco Sensor
	Film Mode		No Signal Power Off
	Analog Clean View		Auto Power Off
	LED Clear Motion		Smart Security
	Picture Off		Auto Protection Time
Reset Picture	Change PIN		
Sound	Sound Mode	General	
	Sound Effect	Game Mode	
	DTS TruSurround HD	Sound Feedback	
	DTS TruDialog	Boot Logo	
	Equalizer	Anynet+ (HDMI-CEC)	
	Speaker Settings	Anynet+ (HDMI-CEC)	
	Additional Settings	Auto Turn Off	
	HDMI Audio Format	Device search	
	Reset Sound	DivX® Video On Demand	

Hotel Plug & Play

The Hotel Plug & Play function, which automatically performs the Hotel mode selection, Country Setup, Clock Setup, and Picture Mode Setup, runs once, when power is first turned ON. Setup also runs automatically after you have executed a Service Reset.

• UI Scenario

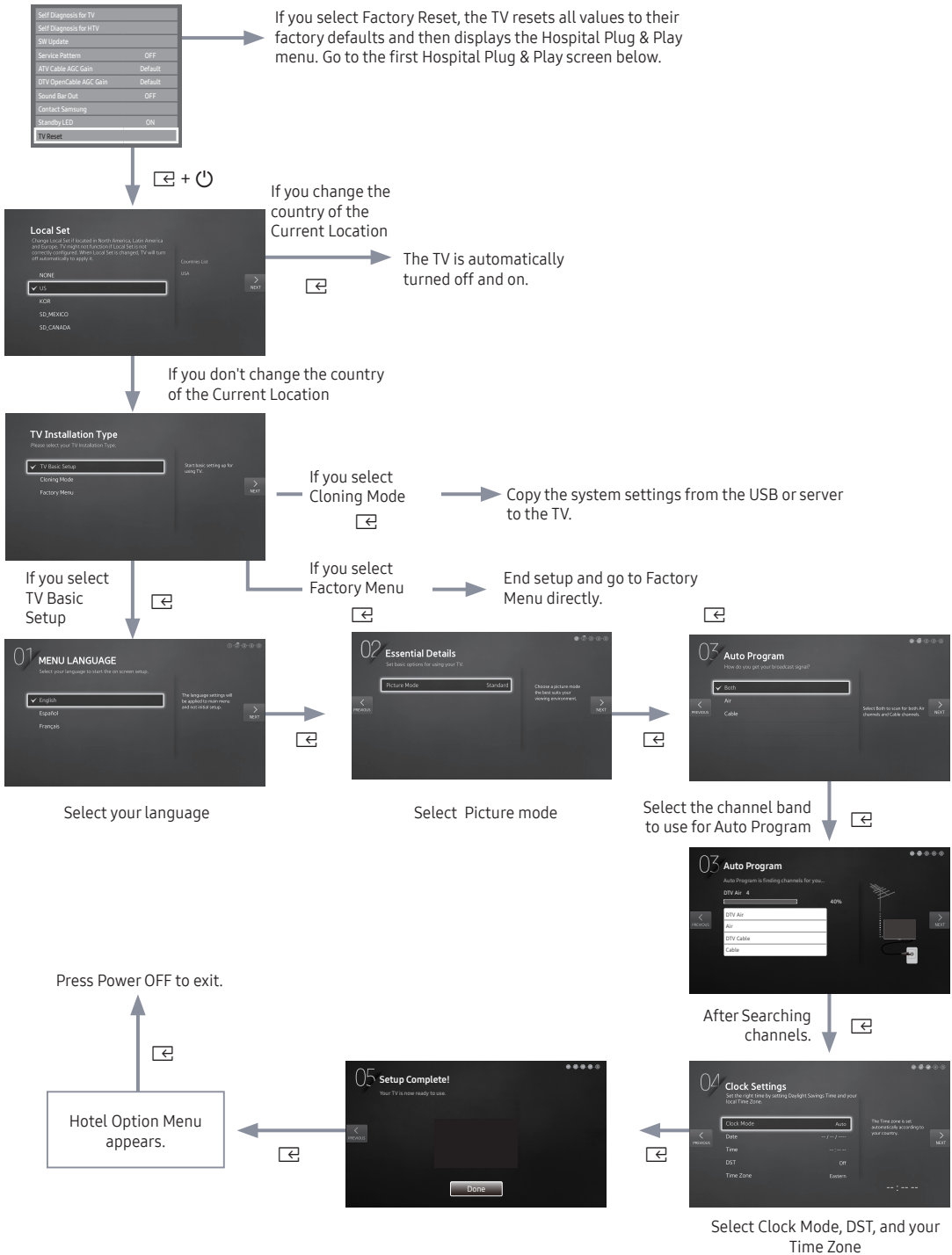

- **LocalSet**
 - Initially highlighted: US
 - If you press the Enter key after selecting Change, you can change the country.
 - If the country is changed, the TV automatically turns off and on.
 - If you select the incorrect country, execute TV Reset again after entering the System section of the Hotel Menu.
- **Menu Language OSD**
 - If you select TV Basic Setup from the "TV Installation Type" OSD, the "Menu Language" OSD appears.
 - Initially highlighted: English
 - If you press the Enter key, the "Picture Mode" OSD appears
- **Picture Mode OSD**
 - Initially highlighted: Standard.
 - The TV displays the Picture Mode OSD where you can choose the Dynamic or a Standard Picture mode.
- **Auto Program OSD**
 - If you press the Enter key, the TV automatically searches for channels.
- **Set Clock Mode, DST(Daylight saving time), and Time Zone OSD**
 - Initially highlighted:
Clock Mode : Auto, DST : Off, Time Zone : Eastern
 - If the TV will be tuned to digital broadcast channels, and these channels transmit date and time information, set the Clock Mode to Auto. The TV will set the date and time automatically.
 - If the TV will not be tuned to digital broadcast channels, set the Clock Mode to Manual, and then set the date and time on the TV manually.
 - Set DST On or Off to apply or not apply daylight saving time to the TV.
 - Select your time zone on the map that appears.

USB Software Upgrade Method

Samsung may offer upgrades to the TV's SW in the future. Please contact the Samsung Hospitality Hot line at 1-866-sam4biz to receive information about downloading upgrades and using a USB drive to update the SW by connecting the USB drive containing the upgrade to the USB port located on the TV.

When the software is upgraded, video and audio settings you have made will return to their default (factory) settings. We recommend you clone the hospital settings so that you can easily reset them after the upgrade.

To upgrade the TV's software, follow these steps:

1. Insert a USB drive containing the SW upgrade into the USB port on the side of the TV.
2. Press the **MENU** button to display the menu.
Press the **▲** or **▼** button to select **Support**, and then press the **ENTER** button.
3. Press the **▲** or **▼** button to select **SW Upgrade**, and then press the **ENTER** button.
The message "Scanning for USB. This may take more than 1min." is displayed.
4. The message "Upgrade version XXXX to version XXXX? The system will be reset after upgrade." is displayed.
Press the **◀** or **▶** to select **OK**, and then press the **ENTER** button.

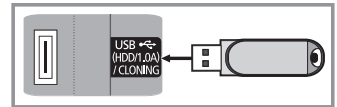

Please be careful to not disconnect the power or remove the USB drive while upgrades are being applied. The TV will turn off and turn on automatically after completing the SW upgrade. Please check the SW version after the upgrades are complete.

Soundbar(AirTrack)

- **Samsung Soundbar(AirTrack) and Hospitality TVs in 2016**
 - Samsung Soundbar(AirTrack) and hospitality TVs support the HDMI ARC feature. If you connect a compatible Samsung Soundbar(AirTrack) to a compatible Samsung hospitality TV using a single HDMI cable, guests can listen to the TV's sound through the Soundbar(AirTrack).
 - The item of Soundbar(AirTrack) Out in Hospitality Option Menu makes you control to where the TV sound is outputted when the TV is turned on.
If Sound bar Out is On, the TV sound is automatically outputted in the Soundbar(AirTrack) device only whenever TV is turned on.
If Sound bar Out is Off, the TV sound is automatically outputted in the TV speaker only whenever TV is turned on.
 - Models supporting the ARC function are listed below:
 - Sound-Bars: HW-H450/H550/H570/H600/H7500
HW-J450/J470/J550
HW-K450/K550
- **Setting the Soundbar(AirTrack) to Hotel Mode.**
 1. Set the following Hotel menu options:
 - Hotel Option > System > Sound Bar Out = On.
 - Hotel option > Power On > Power On Volume = User Defined.
 - Hotel option > Power On > Power On Volume Num > Set greater than 0.
 - Hotel option > Power On > Max Volume > Set greater than 0.
 2. Connect an HDMI cable from the HDMI OUT jack on the back of the Soundbar(AirTrack) to the HDMI2 port (supporting ARC) on the hospitality TV.
 3. After the Soundbar(AirTrack) is connected to the hospitality TV, when the TV turns on, the Soundbar(AirTrack) automatically detects the TV, and then automatically switches to Hotel Mode.

Soundbar(AirTrack) Hotel mode functional characteristics:

- Power On/Off is synchronized with the TV
- HDMI_CEC defaults set to On
- Functions through the "HDMI OUT" port only
- Disables the "Input mode" key on the VFD to prevent unexpected audio-source changes.
- Acquires adjustable Power On and Max Volume settings from the TV's Hotel option menu. Soundbar's Power On Volume and Max Volume values, however, are 1/2 of Power On Volume and Max Volume settings in the TV's Hotel option menu. Example: If the TV's Power On Volume=20 and Max Volume=90, then Soundbar's Power On Volume=10 and Max Volume=45.

Channel Bank Editor (Smovie TV Only)

The Channel Bank Editor in conjunction with the SMOOVIE remote lets you control the channels guests have access to. The Channel Bank Editor provides three Banks of channels and lets you select which channels will be available from each bank. SMOOVIE remotes have installable Bank Cards which correspond to the channel banks in the Channel Bank Editor. The remotes only allow access to channels in the channel bank that correspond to the installed card. Consequently, the channels a guest can access depend on the Bank Card installed in their SMOOVIE remote.

Setting the Channel Bank Editor under Stand-alone Mode

1. Press MUTE → 1 → 1 → 9 → ENTER  on the remote to enter the Hotel Standalone menu.
2. Go to SI vendor, and then select : "Smovie"
3. Find the new menu option, "Channel" → "Channel Bank Editor".
4. Enter the "Channel Bank Editor".

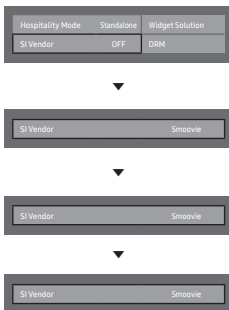

<Depending on model and region, some menu items may not exist.>

5. Edit the Channel Bank. An example is below.

- a. Bank1 (Free channel): Select the channels that will be accessible when a remote doesn't have a card.
- b. Bank2 (Family Card - Green): Select the channels that will be accessible when a remote has a GREEN CARD.
- c. Bank3 (Adult Card - Red): Select the channels that will be accessible when a remote has a RED CARD.

	Bank1 (4)	Bank2 (6)	Bank3 (36)
All	<input type="checkbox"/>	<input type="checkbox"/>	<input checked="" type="checkbox"/>
1 ABC	<input checked="" type="checkbox"/>	<input checked="" type="checkbox"/>	<input checked="" type="checkbox"/>
2 CBS	<input checked="" type="checkbox"/>	<input checked="" type="checkbox"/>	<input checked="" type="checkbox"/>
3 FOX	<input type="checkbox"/>	<input checked="" type="checkbox"/>	<input checked="" type="checkbox"/>
4 NBC	<input type="checkbox"/>	<input checked="" type="checkbox"/>	<input checked="" type="checkbox"/>
5 CNN	<input type="checkbox"/>	<input checked="" type="checkbox"/>	<input checked="" type="checkbox"/>
6 CW	<input type="checkbox"/>	<input checked="" type="checkbox"/>	<input checked="" type="checkbox"/>
7 HBO	<input type="checkbox"/>	<input type="checkbox"/>	<input checked="" type="checkbox"/>
8 TNT	<input type="checkbox"/>	<input type="checkbox"/>	<input checked="" type="checkbox"/>

Information About SMOOVIE Remote Controls

- If you select SMOOVIE as the SI vendor, you should also use SMOOVIE remotes in your facility.
- Guests with remotes that do not have a card can only view channels from Bank 1.
- Guests using the Numeric keys on the remote to change channels can only view channels from Bank 1.
- Guests with remotes that have Green or Red cards must use the channel up/down keys to change channels.
- Guests can only see channels from the Bank1 channel list In the Channel Guide or the Channel List.

Smoovie Set Up Sequence

Step	Smoovie TV Setup (Air/ Cable)	
	Only Air or Cable used	Only Air or Cable used
	If the TV starts with Hotel Plug&Play	If Hotel Plug&Play already done
1	Do a complete P&P (including Air or Cable auto tune)	Enter the Hotel menu
2	After P&P, the TV displays the Hotel menu	Select the channel type - ATV or ADTV for Air - CATV or CDTV for cable
3	Select the channel type - ATV or ADTV for Air - CATV or CDTV for cable	Select Smoovie TV in the Hotel menu
4	Select Smoovie TV in the Hotel menu	Select Channel Setup
5	Select Channel Setup (Can be skipped)	Select "Air" or "Cable" to auto tune
6	Select "Air" or "Cable" to auto tune. (Can be skipped,)	Set up channels in the CH Bank Editor
7	Set up channels in the CH Bank Editor	After power off & on, guests can use the TV
8	After power off & on, guests can use the TV	
9		
10		

Channel Editor

The Channel Editor lets you edit the channels stored in the TV's memory. Using Channel Editor you can:

- Change the channel numbers and names, and sort the channels in your desired channel number order.
- Apply the video mute to channels you select. The video mute blanks out the video from a channel and outputs only the sound while displaying a speaker icon on the screen.

The Channel Editor also lets you view information about each channel easily, without your having to display each channel directly.



<Depending on model and region, some menu items may not exist.>

General Steps for Using the Channel Editor in Stand-alone Mode

Step	Broad Outline
1	Run 'Channel Auto Store' in the Hotel Option Menu.
2	Enter 'Channel Editor' in the Hotel Option Menu.
3	On a piece of paper, compile a list of channels you want to have, arranged in the order you want.
4	Rearrange channels and edit channel names with the TOOLS Button based on the list you compiled.
5	Press the EXIT or RETURN Button to exit.

<For a detailed explanation of how Channel Editor works, see pages 45 through 48.>

The picture below shows a sample Channel Editor screen.

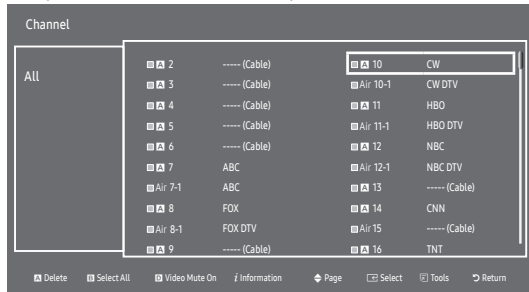

- **A** Indicates an analog channel.
- Channels without an **A** are digital channels.
 - 🖱 If Dynamic SI in the Hospitality Option Menu is On, Channel Editor will display no digital channels. You must set Dynamic SI to Off before you can edit digital channels in Channel Editor.
- The guide at the bottom of the Channel Editor menu displays the remote buttons you need to press to apply Channel Editor functions.
 - 1 Using the remote's up or down arrow key, highlight the channel that you want to edit.
 - To edit more than one channel, move the highlight to a channel, and then press the **ENTER** key. A check will appear in the check box next to the channel. Repeat for each channel you want to edit.
 - 2 To delete the channel or channels you selected from the channel list, press the red button on the remote.
 - To delete two or more channels simultaneously, select multiple channels in Step 1, and then press the red button on the remote.
 - 3 Press the green button on the remote to select all channels.
 - 4 To apply the video mute, press the yellow button on the remote.
 - To apply the video mute to two or more channels simultaneously, select multiple channels in Step 1, and then press the yellow button on the remote.
 - 5 To view information about a channel, including video mute set up, press the **INFO** button on the remote.
 - 6 Press the **TOOLS** button on the remote to rename a channel or change the channel number. See page 47.

Channel Editor Functions and Remote Button

- A** Red (Delete): Deletes a channel from the channel list.
- G** Green (Select All): Selects all channels at once.
- Y** Yellow (Deselect All): Deselects all channels at once.
- B** Blue (Video Mute On/Off): You can set the Video Mute On/Off.
- ↔** (Page): Moves to next or previous page.
- i** (Information): Display details of the selected channel.
- T** (Tools): Displays the option menu.
- ↩** (Return): Returns to the previous step or exits.

When you press the **TOOLS** button, the following menu is available.

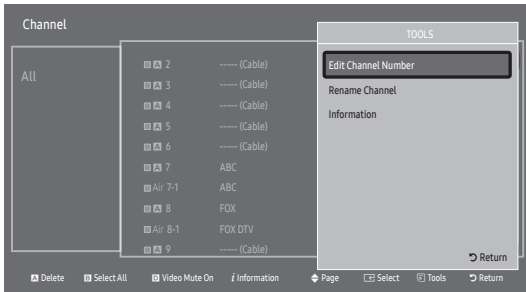

• Edit Channel Number

Use **Edit Channel Number** to change the channel number of a channel you select. To change a channel number, follow these steps:

1. Select a channel on the **Channel Edit** screen.
2. Press the **TOOLS** button on your remote.
3. Select **Edit Channel Number** in the Tools menu.
4. Use the up or down arrow keys to change the channel number.
5. Select **OK** when done, and then press the **ENTER** button.

When you change the channel number, the channel information is not updated automatically.

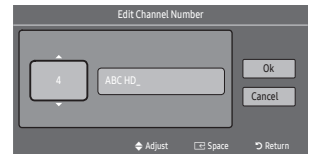

• Rename Channel

Use **Rename Channel** to change the name of a channel you select. To change the name of a channel, follow these steps:

1. Select a channel on the **Channel Edit** screen.
2. Press the **TOOLS** button on your remote.
3. Select **Rename Channel** in the Tools menu.
4. Use the on-screen keyboard that appears to enter the new name for the channel. Use the arrow buttons on your remote to select a letter or number, and then press Enter. Repeat for each letter or number you want to select.
5. When finished, select **Done** on the bottom of the screen, and then press the **ENTER** button.

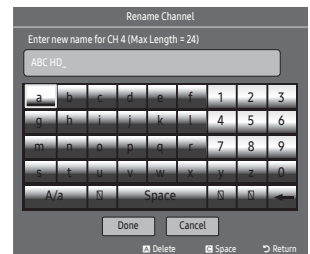

• Information

Use **Information** to view information about a channel you select. To view information about a channel, follow these steps:

1. Select a channel on the **Channel Edit** screen.
2. Press the **TOOLS** button on your remote.
3. Select **Information** in the Tools menu.
4. Select **OK**, and then press the **ENTER** button to close the Information screen.

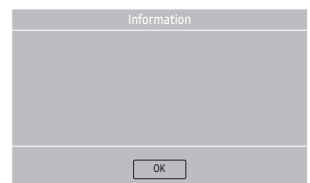

The external sources of this TV are displayed in the last page of the Channel Editor menu as shown in the example below. In the example, there are two external sources connected to the TV, HDMI2 and AV.

- You can assign a new analog channel to an external source by selecting the source on the last page, pressing the TOOLS button, selecting **Edit Channel Number**, and then using the up or down arrow button on the remote to select the channel number of the analog channel.
- If you tune to a channel after assigning the channel to an external source, you can enter the external source without opening the TV source menu.



After assigning channel number 997 to the AV source.

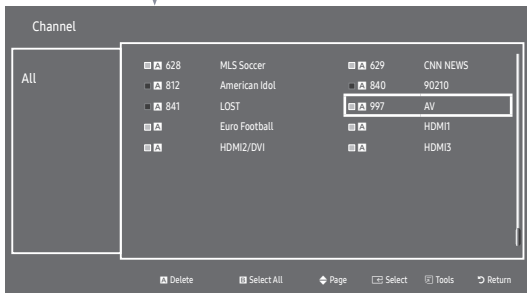

Installing the Wall Mount

Installing the wall mount kit

You can mount the TV on the wall using a wall mount kit (sold separately).

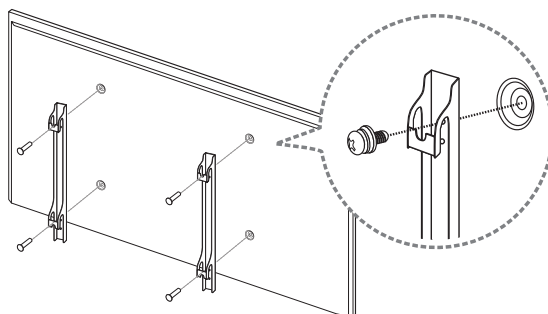

 The Product shape may differ depending on the model.

Installing the Wall Mount Kit

The wall mount kit (sold separately) allows you to mount the TV on a wall.

For detailed information on installing the wall mount, see the instructions provided with the wall mount. Contact a technician for assistance when installing the wall mount bracket. Samsung Electronics is not responsible for any damage to the product or injury to yourself or others if you select to install the TV on your own.





Securing the TV to the Wall



Caution: Pulling, pushing, or climbing on the TV may cause the TV to fall. In particular, ensure your children do not hang on or destabilize the TV. Doing so may cause the TV to tip over, causing serious injuries or death. Follow all safety precautions provided in the Safety Flyer included with your TV. For added stability and safety, you can purchase and install the anti-fall device as described below.

To Prevent the TV from Falling

 TV Holder Kits are sold separately. To purchase a TV Holder Kit, contact Samsung Customer Care.

1. Insert the screws into the wall brackets and firmly fasten them to the wall. Make sure the screws are firmly fixed to the wall.
-  We strongly recommend you drive the screws into a stud.
2. Insert the screws into the wall brackets and firmly fasten the screws to the top VESA screw holes on the back of the TV.
3. Connect the brackets on the TV and the brackets on the wall with a strong string or cable, and then tie the string or cable tightly to the brackets.
-  Verify all connections are properly secured. Periodically check the connections for any sign of fatigue or failure. If you have any doubt about the security of your connections, contact a professional installer.
-  Install the TV close to the wall so that it does not fall.
-  Connect the string or cable so that the brackets on the wall are at the same height or lower than the brackets on the TV. Untie the string or cable before moving the TV.

Wall Mount Kit Specifications (VESA)

The wall mount kit is not supplied, but sold separately.

Install your wall mount on a solid wall perpendicular to the floor. If you are attaching the wall mount to building materials other than plaster board, contact your nearest dealer. If installed on a ceiling or slanted wall, the TV may fall and cause severe personal injury.

NOTE

- Standard dimensions for wall mount kits are shown in the table below.
- Samsung wall mount kits contain a detailed installation manual. All parts necessary for assembly are provided.
- Do not use screws that do not comply with the VESA standard screw specifications.
- Do not use screws that are longer than the standard dimension or do not comply with the VESA standard screw specifications. Screws that are too long may cause damage to the inside of the TV set.
- For wall mounts that do not comply with the VESA standard screw specifications, the length of the screws may differ depending on the wall mount specifications.
- Do not fasten the screws too firmly. This may damage the product or cause the product to fall, leading to personal injury. Samsung is not liable for these kinds of accidents.
- Samsung is not liable for product damage or personal injury when a non-VESA or non-specified wall mount is used or the consumer fails to follow the product installation instructions.
- Do not mount the TV at more than a 15 degree tilt.
- Always have two people mount the TV onto a wall.

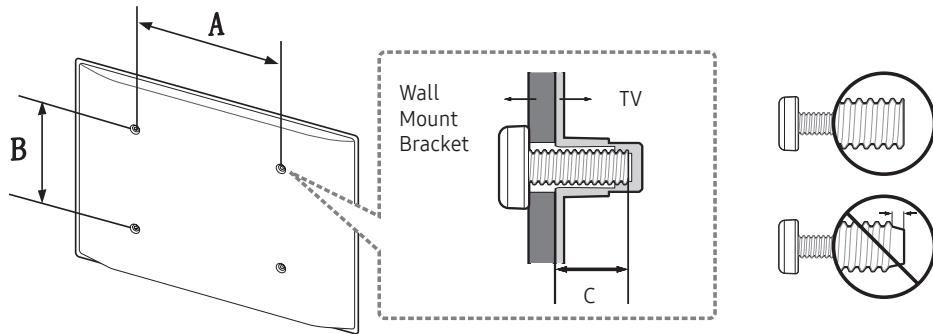

TV size in inches	VESA screw hole specs (A * B) in millimeters	C (mm)	Standard Screw (Length* Pitch in mm)	Quantity
22	75 x 75	14.4	M4	4
24		9.3		
28	100 x 100	19.5	M8	
32	200 x 200	19.2		
40		21.2		
48	400 x 400	21.8		
50		21.5		
55		21.2		
60		21.7		
65		10.4		



Do not install your Wall Mount Kit while your TV is turned on. It may result in personal injury due to electric shock.

Anti-theft Kensington Lock

The Kensington Lock is a device you can use to physically fix a TV to a location when you use it in a public place. The appearance and locking method may differ from the illustration at right, depending on the manufacturer. Refer to the manual provided with the Kensington Lock for additional information on proper use.

The Kensington Lock is not supplied by Samsung.

- ✎ Please find the “K” icon on the rear of the TV. A Kensington slot is beside the “K” icon.

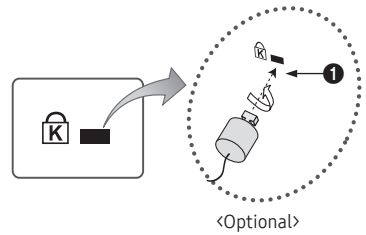

To lock the product, follow these steps:

1. Wrap the Kensington lock cable around a large, stationary object such as desk or chair.
2. Slide the end of the cable with the lock attached through the looped end of the Kensington lock cable.
3. Insert the locking device into the Kensington slot on the product ❶.
4. Lock the lock.

- ✎ These are general instructions. For exact instructions, see the User manual supplied with the locking device.
- ✎ The locking device has to be purchased separately.
- ✎ The location of the Kensington slot may be different depending on the TV model.

Specifications

Environmental Considerations			
Operating Temperature	50°F to 104°F (10°C to 40°C)		
Operating Humidity	10% to 80%, non-condensing		
Storage Temperature	-4°F to 113°F (-20°C to 45°C)		
Storage Humidity	5% to 95%, non-condensing		
Model Name	HG22NE690	HG24NE690	HG28NE690
Display Resolution	1920 x 1080	1366 x 768	
Stand Swivel (Left / Right)	0°		
Sound (Output)	3W x 2	5W x 2	
Screen Size (Diagonal)	22" Class (22.0" measured diagonally)	24" Class (24.0" measured diagonally)	28" Class (27.5" measured diagonally)
Dimensions (W x H x D)			
Body	20.2 X 12.4 X 1.6 inches (513.8 X 315.6 X 39.9 mm)	22.1 x 13.7 x 2.6 inches (561.8 x 349.1 x 65.2 mm)	25.3 x 15.6 x 2.5 inches (643.4 x 396.5 x 62.9 mm)
With stand	20.2 X 13.8 X 4.9 inches (513.8 X 350.0 X 123.4 mm)	22.1 x 15.1 x 6.5 inches (561.8 x 384.2 x 163.8 mm)	25.3 x 17.1 x 6.4 inches (643.4 x 435.0 x 163.4 mm)
Weight			
Without Stand	7.5 lbs (3.4 kg)	8.8 lbs (4.0 kg)	8.2 lbs (3.7 kg)
With Stand	7.7 lbs (3.5 kg)	9.3 lbs (4.2 kg)	9.0 lbs (4.1 kg)
Model Name	HG32NE690		HG40NE690
Display Resolution	1920 x 1080		
Stand Swivel (Left / Right)	20° / 60° / 90°		
Sound (Output)	20W(L:10W, R:10W)		
Screen Size (Diagonal)	32" Class (31.5" measured diagonally)	40" Class (40.0" measured diagonally)	
Dimensions (W x H x D)			
Body	28.4 x 16.9 x 2.6 inches (721.4 x 428.5 x 64.9 mm)	35.7 x 21.0 x 2.6 inches (906.6 x 532.9 x 65.1 mm)	
With stand	28.4 x 18.3 x 7.6 inches (721.4 x 465.6 x 192.6 mm)	35.7 x 22.7 x 8.9 inches (906.6 x 577.6 x 226.5 mm)	
Weight			
Without Stand	11.0 lbs (5.0 kg)	17.2 lbs (7.8 kg)	
With Stand	14.1 lbs (6.4 kg)	23.6 lbs (10.7 kg)	
Model Name	HG48NE690		HG50NE690
Display Resolution	1920 x 1080		
Stand Swivel (Left / Right)	20° / 60° / 90°		
Sound (Output)	20W(L:10W, R:10W)		
Screen Size (Diagonal)	48" Class (47.6" measured diagonally)	50" Class (49.5" measured diagonally)	
Dimensions (W x H x D)			
Body	42.3 x 24.7 x 2.6 inches (1075.1 x 627.6 x 65.5 mm)	44.0 x 25.5 x 2.7 inches (1117.8 x 647.8 x 67.5 mm)	
With stand	42.3 x 26.5 x 8.9 inches (1075.1 x 673.5 x 226.5 mm)	44.0 x 27.4 x 8.9 inches (1117.8 x 696.3 x 226.5 mm)	
Weight			
Without Stand	24.5 lbs (11.1 kg)	27.3 lbs (12.4 kg)	
With Stand	30.9 lbs (14.0 kg)	33.7 lbs (15.3 kg)	

Environmental Considerations		
Operating Temperature	50°F to 104°F (10°C to 40°C)	
Operating Humidity	10% to 80%, non-condensing	
Storage Temperature	-4°F to 113°F (-20°C to 45°C)	
Storage Humidity	5% to 95%, non-condensing	
Model Name	HG55NE690	HG60NE690
Display Resolution	1920 x 1080	
Stand Swivel (Left / Right)	20° / 60° / 90°	
Sound (Output)	20W(L:10W, R:10W)	
Screen Size (Diagonal)	55" Class (54.6" measured diagonally)	60" Class (60.0" measured diagonally)
Dimensions (W x H x D)		
Body	48.5 x 28.3 x 2.5 inches (1230.6 x 718.4 x 64.0 mm)	53.7 x 31.0 x 2.5 inches (1365.0 x 786.4 x 64.4 mm)
With stand	48.5 x 30.0 x 8.9 inches (1230.6 x 762.8 x 226.5 mm)	53.7 x 33.8 x 14.0 inches (1365.0 x 859.3 x 355.1 mm)
Weight		
Without Stand	34.6 lbs (15.7 kg)	46.5 lbs (21.1 kg)
With Stand	41.0 lbs (18.6 kg)	57.5 lbs (26.1 kg)
Model Name	HG65NE690	
Display Resolution	1920 x 1080	
Stand Swivel (Left / Right)	20° / 60° / 90°	
Sound (Output)	20W(L:10W, R:10W)	
Screen Size (Diagonal)	65" Class (64.5" measured diagonally)	
Dimensions (W x H x D)		
Body	57.3 x 32.9 x 2.8 inches (1454.5 x 835.4 x 70.9 mm)	
With stand	57.3 x 35.8 x 14.0 inches (1454.5 x 909.7 x 355.1 mm)	
Weight		
Without Stand	57.1 lbs (25.9 kg)	
With Stand	68.1 lbs (30.9 kg)	

- 🔗 Design and specifications are subject to change without prior notice.
- 🔗 This device is a Class B digital apparatus.
- 🔗 For power supply and power consumption information, refer to the label attached to the product.

Display Resolution

When you use your TV as a computer monitor, you can also select one of the standard resolutions listed in the Resolution column. The TV will automatically adjust to the resolution you choose.

Mode	Resolution	Horizontal Frequency (KHz)	Vertical Frequency (Hz)	Pixel Clock Frequency (MHz)	Sync Polarity (H / V)
IBM	640 x 350	31.469	70.086	25.175	+/-
	720 x 400	31.469	70.087	28.322	-/+
MAC	640 x 480	35.000	66.667	30.240	-/-
	832 x 624	49.726	74.551	57.284	-/-
	1152 x 870	68.681	75.062	100.000	-/-
VESA DMT	640 x 480	31.469	59.940	25.175	-/-
	640 x 480	37.861	72.809	31.500	-/-
	640 x 480	37.500	75.000	31.500	-/-
	800 x 600	37.879	60.317	40.000	+/+
	800 x 600	48.077	72.188	50.000	+/+
	800 x 600	46.875	75.000	49.500	+/+
	1024 x 768	48.363	60.004	65.000	-/-
	1024 x 768	56.476	70.069	75.000	-/-
	1024 x 768	60.023	75.029	78.750	+/+
	1152 x 864	67.500	75.000	108.000	+/+
	1280 x 720	45.000	60.000	74.250	+/+
	1280 x 800	49.702	59.810	83.500	-/+
	1280 x 1024	63.981	60.020	108.000	+/+
	1280 x 1024	79.976	75.025	135.000	+/+
	1366 x 768	47.712	59.790	85.500	+/+
	1440 x 900	55.935	59.887	106.500	-/+
1600 x 900RB	60.000	60.000	108.000	+/+	
1680 x 1050	65.290	59.954	146.250	-/+	
1920 x 1080	67.500	60.000	148.500	+/+	

NOTE

- The interlaced mode is not supported.
- The set might operate abnormally if you select a non-standard video format.
- Separate and Composite modes are supported. SOG (Sync On Green) is not supported.

Dimensions

Front view / Side view

(Unit: inches)

◆ HG22NE690

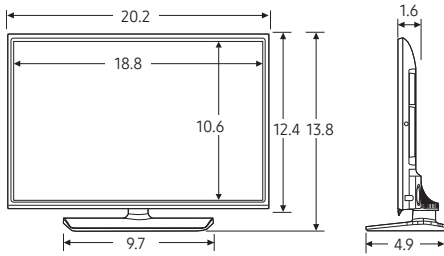

◆ HG24NE690

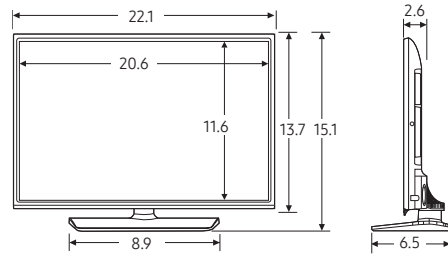

◆ HG28NE690

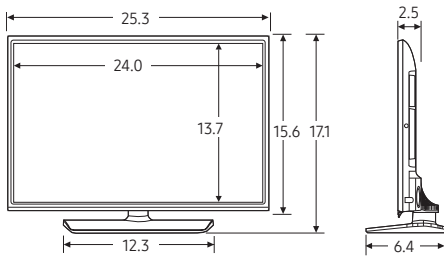

◆ HG32NE690

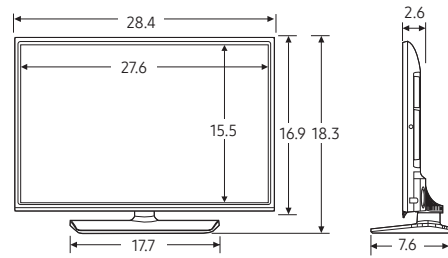

◆ HG40NE690

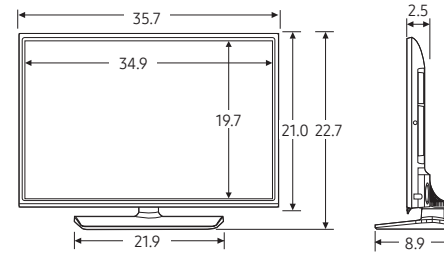

◆ HG48NE690

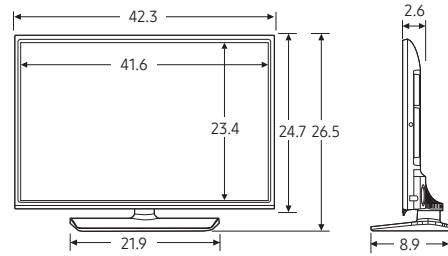

◆ HG50NE690

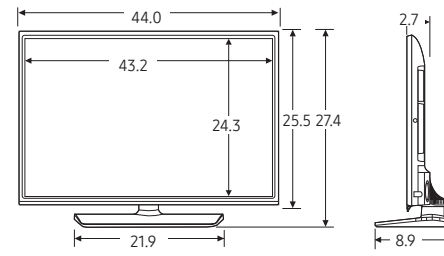

◆ HG55NE690

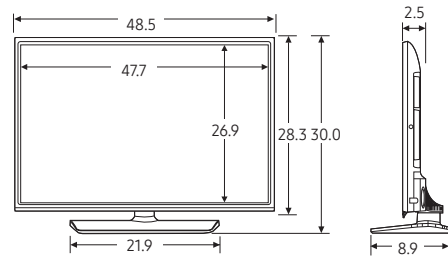

◆ HG60NE690

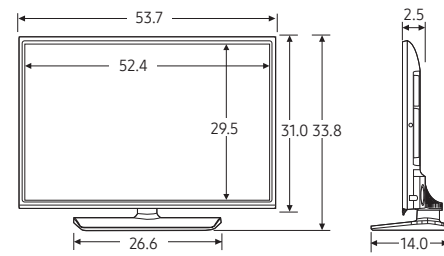

◆ HG65NE690

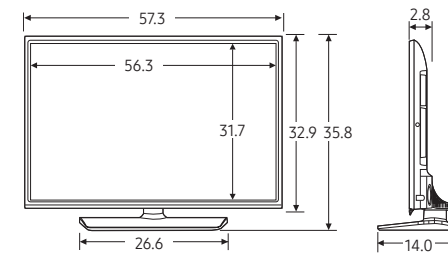

Jack panel detail / Rear view

Detailed dimensions can be checked at Displaysolutions.samsung.com.

Base Stand detail

- HG22NE690

(Unit: inches)

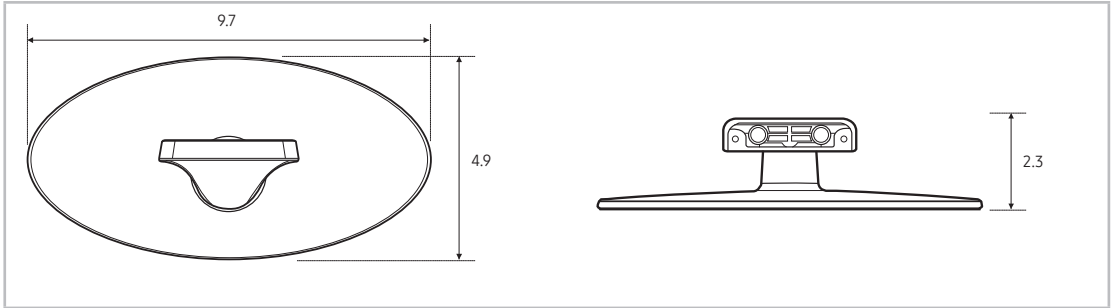

- HG24NE690

(Unit: inches)

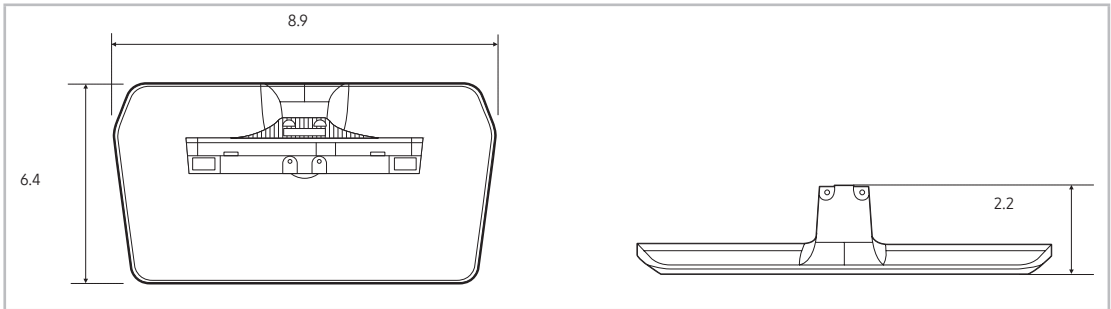

- HG28NE690

(Unit: inches)

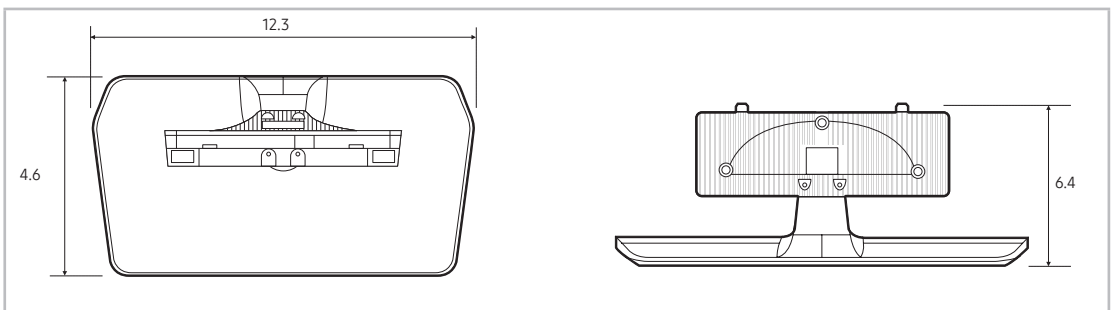

◆ HG32NE690

(Unit: inches)

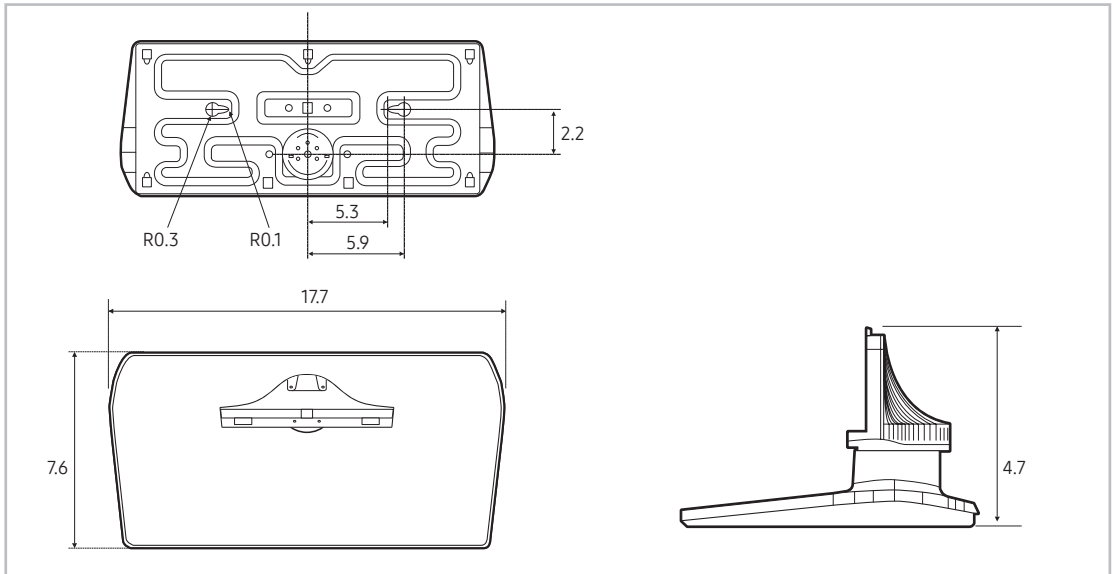

◆ HG40NE690, HG48NE690, HG50NE690, HG55NE690

(Unit: inches)

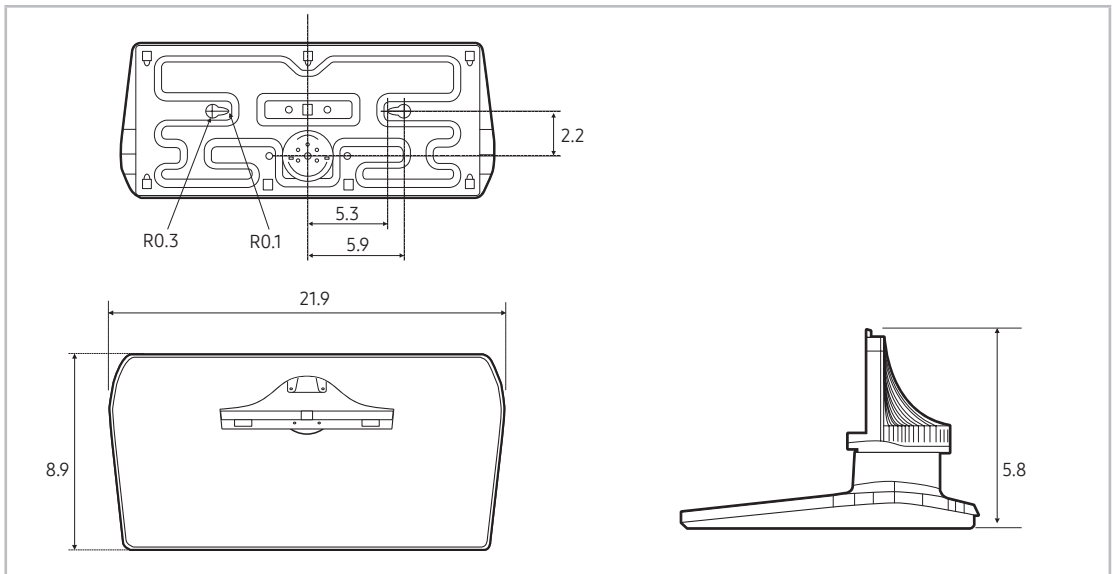

📎 NOTE

All drawings are not necessarily to scale. Some dimensions are subject to change without prior notice. Refer to the dimensions prior to performing installation of your TV. Not responsible for typographical or printed errors.

◆ HG60NE690 / HG65NE690

(Unit: inches)

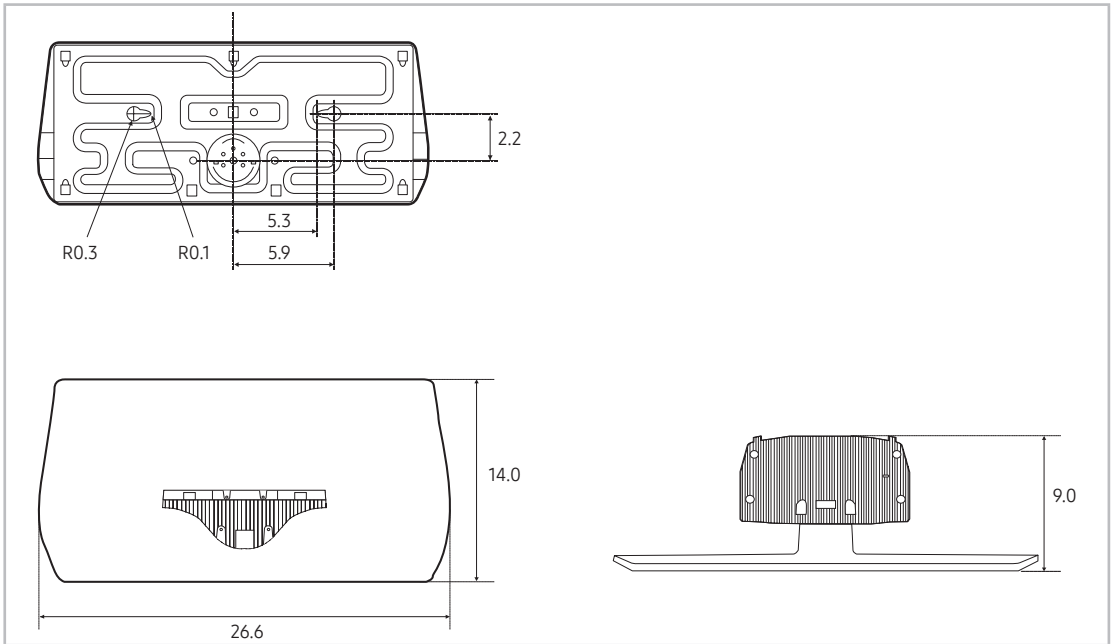

📎 NOTE

All drawings are not necessarily to scale. Some dimensions are subject to change without prior notice. Refer to the dimensions prior to performing installation of your TV. Not responsible for typographical or printed errors.

Important Warranty Information Regarding Television Format Viewing

📄 See the warranty card for more information on warranty terms.

Wide screen format LED Displays (16:9, the aspect ratio of the screen width to height) are primarily designed to view wide screen format full-motion video. The images displayed on them should primarily be in the wide screen 16:9 ratio format, or expanded to fill the screen if your model offers this feature and the images are constantly moving. Displaying stationary graphics and images on screen, such as the dark sidebars on nonexpanded standard format television video and programming, should be limited to no more than 5% of the total television viewing per week.

Additionally, viewing other stationary images and text such as stock market reports, video game displays, station logos, web sites or computer graphics and patterns, should be limited as described above for all televisions. Displaying stationary images that exceed the above guidelines can cause uneven aging of LED Displays that leave subtle, but permanent burned-in ghost images in the LED picture. To avoid this, vary the programming and images, and primarily display full screen moving images, not stationary patterns or dark bars. On LED models that offer picture sizing features, use these controls to view different formats as a full screen picture.

Be careful in the selection and duration of television formats used for viewing. Uneven LED aging as a result of format selection and use, as well as burned-in images, are not covered by your Samsung limited warranty.

• SAMSUNG ELECTRONICS NORTH AMERICAN LIMITED WARRANTY STATEMENT

Subject to the requirements, conditions, exclusions and limitations of the original Limited Warranty supplied with Samsung Electronics (SAMSUNG) products, and the requirements, conditions, exclusions and limitations contained herein, SAMSUNG will additionally provide Warranty Repair Service in the United States on SAMSUNG products purchased in Canada, and in Canada on SAMSUNG products purchased in the United States, for the warranty period originally specified, and to the Original Purchaser only.

The above described warranty repairs must be performed by a SAMSUNG Authorized Service Center. Along with this Statement, the Original Limited Warranty Statement and a dated Bill of Sale as Proof of Purchase must be presented to the Service Center. Transportation to and from the Service Center is the responsibility of the purchaser. Conditions covered are limited only to manufacturing defects in material or workmanship, and only those encountered in normal use of the product.

Excluded, but not limited to, are any originally specified provisions for, in-home or on-site services, minimum or maximum repair times, exchanges or replacements, accessories, options, upgrades, or consumables.

For the location of a SAMSUNG Authorized Service Center, please call toll-free:

- In the United States: 1-866-sam4biz
- In Canada: 1-800-213-8513

License



DOLBY
DIGITAL PLUS

Manufactured under licence from Dolby Laboratories. Dolby and the double-D symbol are trademarks of Dolby Laboratories.



dts
Premium Sound | 5.1

For DTS patents, see <http://patents.dts.com>. Manufactured under license from DTS, Inc. DTS, the Symbol, DTS in combination with the Symbol, DTS Premium Sound|5.1, DTS Digital Surround, DTS Express, and DTS Neo2:5 are registered trademarks or trademarks of DTS, Inc. in the United States and/or other countries.
© DTS, Inc. All Rights Reserved.



dts
Studio Sound

For DTS patents, see <http://patents.dts.com>. Manufactured under license from DTS Licensing Limited. DTS, the Symbol, DTS in combination with the Symbol, and DTS Studio Sound are registered trademarks or trademarks of DTS, Inc. in the United States and/or other countries. © DTS, Inc. All Rights Reserved.

DivX
HD

DivX Certified® to play DivX® video up to HD 1080p, including premium content.

DivX®, DivX Certified® and associated logos are trademarks of DivX, LLC and are used under license.

This DivX Certified® device has passed rigorous testing to ensure it plays DivX® video.

To play purchased DivX movies, first register your device at vod.divx.com. Find your registration code in the DivX VOD section of your device setup menu.

Covered by one or more of the following U.S. patents: 7,295,673; 7,460,668; 7,515,710; 8,656,183; 8,731,369; RE45,052.

HDMI

The terms HDMI and HDMI High-Definition Multimedia Interface, and the HDMI Logo are trademarks or registered trademarks of HDMI Licensing LLC in the United States and other countries.



Open Source License Notice

Open Source used in this product can be found on the following webpage. (<http://opensource.samsung.com>)

Open Source License Notice is written only English.

SAMSUNG

Contact SAMSUNG WORLD WIDE

If you have any questions or comments relating to Samsung products, please contact the SAMSUNG customer care center.

Samsung Hospitality Hotline 1-866-sam4biz (US)
1-800-726-7864 (CANADA)
1-800-726-7864 (MEXICO)

Web site: <http://www.samsung.com/us/business>