

MUVI™ K-SERIES

User Manual

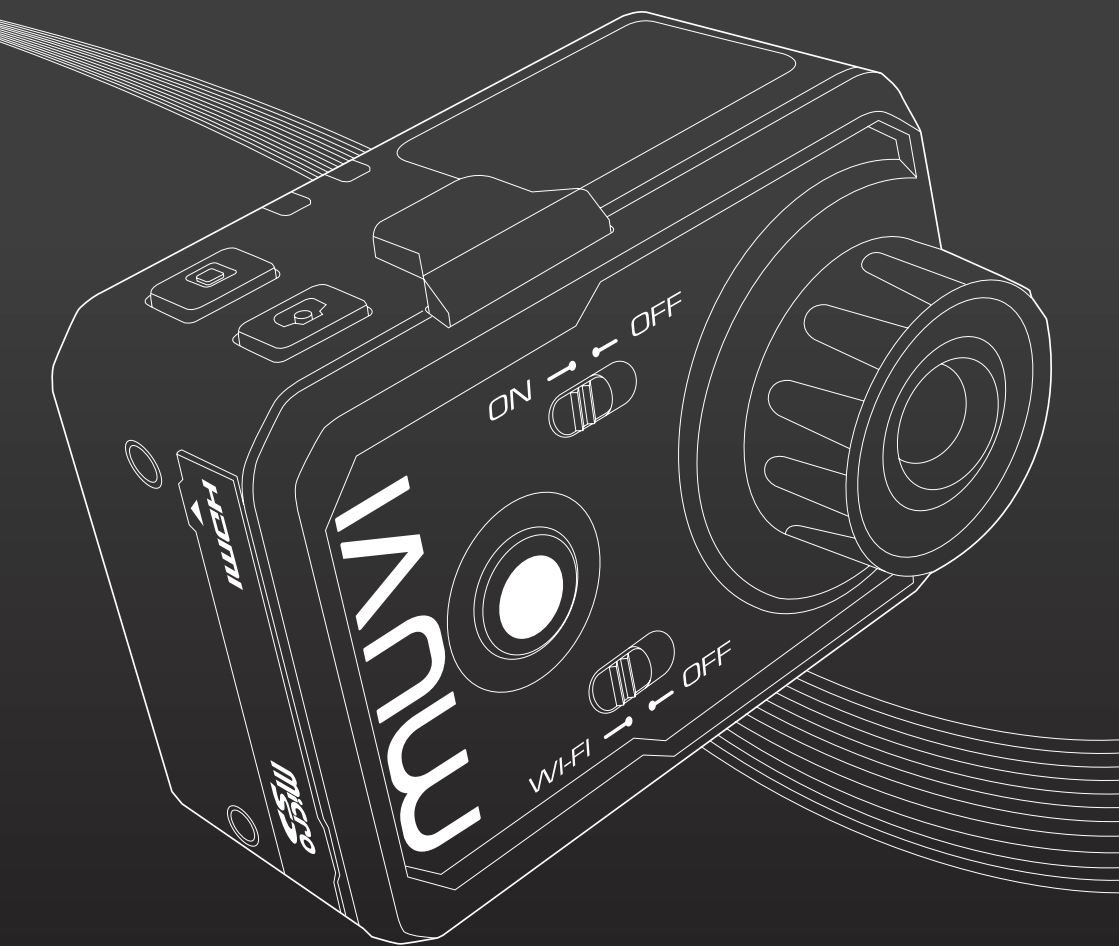

veho®

1. Introduction

Thank you for purchasing the Veho K-Series HD camcorder. Its small size, integrated design and easy to use functions mean that you can record and photograph anytime, anywhere using high-definition and dynamic photography, so that you can share your videos and photos with your family members and friends.

This manual covers detailed instructions on use, operation, installation and technical specifications of the K-Series HD camcorder. Please read this manual carefully before use and retain for future reference.

Index

Introduction.....	2
Precautions.....	3
Tour of your Muvi K-Series.....	4
Description of LED indicators.....	6
Getting Started.....	8
Accessing Muvi K-Series Settings.....	10
General camcorder settings.....	11
Switching between modes.....	13
Video Recording.....	15
G-Sensor.....	17
Photo capture.....	18
K-Series Waterproof Case.....	20
Download and install app.....	22
Turning on the WiFi and connecting to the app.....	23
Guide to using the app.....	26
K-Series Camcorder Specs.....	37

2. Precautions

When using the K-Series HD camcorder please adhere to the following precautions:

1. Do not drop, knock or shake the camcorder.
2. Do not put the camcorder close to an object that generates strong magnetic field, such as a magnet or a motor or close to an object that emits powerful radio waves. A strong magnetic field may cause faults on the camcorder or damage the video/audio recordings.
3. Do not expose the video camera to high temperatures or direct sunshine.
4. Do not put the microSD card close to an object that generates a strong magnetic field, such as a television set or a magnet. Do not put the microSD card in a place where static electricity is easily generated.
5. If the camcorder overheats or you see or smell smoke whilst it is charging, immediately disconnect the power supply to stop charging the battery.
6. Keep the camcorder out of reach of children during charging as the power cable may cause asphyxia or electric shocks.
7. Store the camcorder in a cool, dry and dust-free place.

3. Tour of your Muvi K-Series

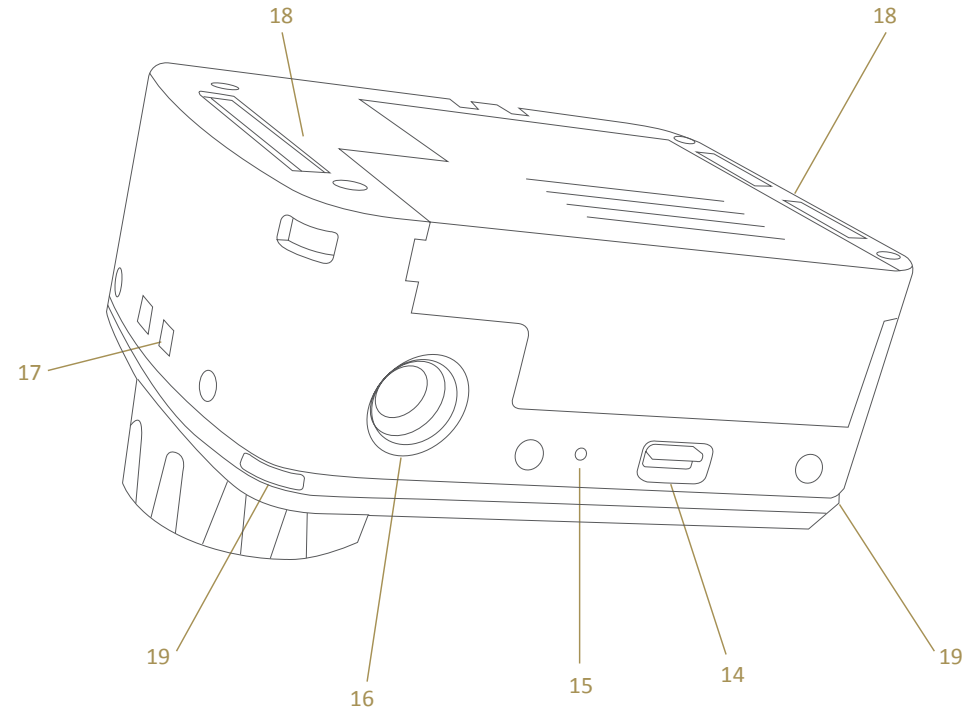
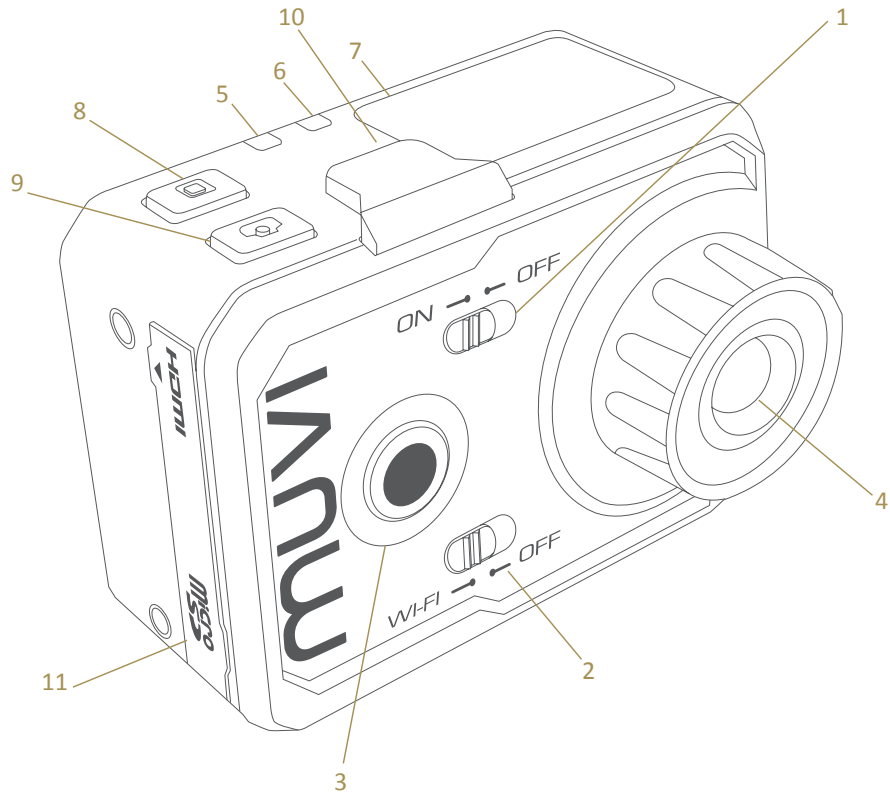

- 1. On/Off Switch
- 2. WiFi On/Off Switch
- 3. Start Record Button
- 4. Lens
- 5. Power Indicator (red)
- 6. Top LED Indicator (blue)
- 7. LCD Display
- 8. Stop Record Button
- 9. Capture Button
- 10. Microphone
- 11. HDMI Port

- 12. Mini USB/AV Out Port
- 13. microSD Slot
- 14. Battery Lock Switch
- 15. Microphone
- 16. Tripod Mount
- 17. Lanyard Hole
- 18. Connections for Optional LCD Screen
- 19. Bottom LED Indicators

4. Description of LED indicators

Status	Power Indicator (Red)	Top LED Indicator (Blue)	Bottom LED Indicators (Blue)	Record Button Indicator
Power On	Solid On			
Recording Video		Flash Slowly		Solid On
Recording Audio		Flash Slowly		Solid On
Capturing Photo		Flash Once		Flash Once
microSD Card Full	Solid On			
Charging	Flash Slowly			
Fully Charged	Solid On			
Low Battery	Flash Fast for 5 seconds and then auto power off			
WiFi On			Flash Slowly	

5. Getting Started

Inserting the battery

Before inserting the battery make sure that the lock switch is in the unlock position. Slide the battery into the camcorder, and then move the lock switch into the lock position to lock the battery into place.

Charging the Muvi K-Series

To charge the camcorder, connect it to a USB port using the supplied USB cable. The red LED will flash whilst charging. It will take approximately 3 hours for the camcorder to fully charge. Once fully charged the red LED will stop flashing and stay on.

Inserting the microSD card

The K-Series camcorder supports microSD and microSDHC cards up to 32GB. Although any class of card can be used with the camcorder it is recommended that a class 6 or higher card is used for the best results.

With the camcorder turned off, remove the port cover on the side of the camcorder and insert the microSD card into the microSD slot. You will hear a click to indicate that the card has been inserted correctly. To remove the microSD card press the card into the camcorder to release it. The card will pop out slightly so that you can remove it.

Turning on the Muvi K-Series

Turn on the camcorder by moving the power switch on the front of the camcorder to the on position. The start-up Muvi logo will appear on the LCD display and the power indicator will turn red. Once the LCD display changes to the information display the camcorder is ready to use. Please note that the camcorder will become warm during use.

LCD information display

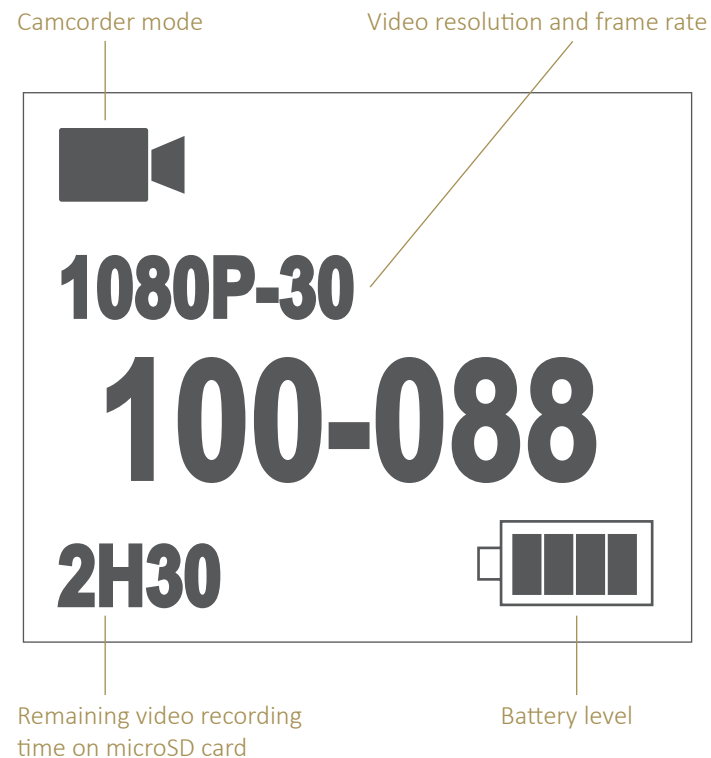

6. Accessing Muvi K-Series Settings

To enter the settings menu press and hold the start record button for three seconds. The camcorder symbol will appear on the LCD display.

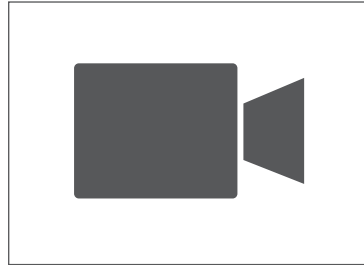



Press the stop record button repeatedly to navigate through the options until you reach the M symbol. Press the start record button to enter the menu.

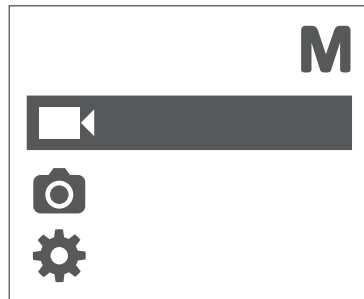

The following menu will appear.



Use the stop record button to move between the options. Press the start record button to select  to enter video settings,  to enter photo settings or  to enter general camcorder settings. Press the camera button to return to the previous mode that you were in.

7. General camcorder settings

Enter the settings menu and then select the general camcorder settings menu. Use the stop record button to move between the options. Press the start record button to select the option you want to change and the camera button to exit the option that you are in.



Set the key tone volume to off, medium or standard.

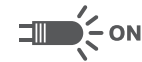

Turn status LEDs on or off.



Turn the on screen display on or off on optional LCD screen.



Set the auto standby function to off, 2, 5 or 10 minutes.



See the TV standard to NTSC or PAL depending on your area. Changing this setting will also affect the frame rate per second that you can record at. See page 16



Turn on the central spot exposure mode to on or off.



Turn the G-Sensor mode on or off. For further information on the G-Sensor function please see page 17.



Set the language for the camcorder menu. Languages available are: Simplified Chinese, Traditional Chinese, English, German, French, Italian, Spanish, Portuguese, Russian or Japanese.



Set the date and time. See below for further information.

8. Switching between modes



Format the microSD card in the camcorder. Note: Formatting will delete all files, including protected ones.



Restore the camcorder to the factory setting default.

Ver:C.E4.10

Shows the version of Muvi K-Series firmware you have

Setting the date/time

Select the date/time option from the setting menu then select the format that you would like the date to appear as between:

Y-M-D H:M M-D-Y H:M D-M-Y H:M

After selecting the format the camcorder will enter the date and time setup. Use the camera and stop record buttons to change the highlighted position. After you have selected the correct number press the start record button to move to the next position.

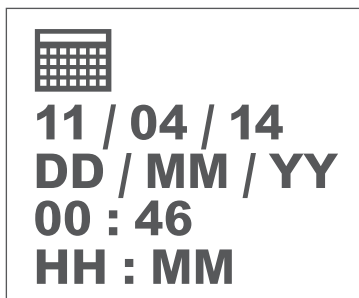





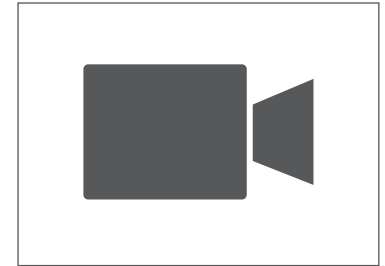

Once you have changed the minute setup press the start record button to return to the format setup, then press the camera button to exit the date and time setup.

To switch between modes press and hold the start record button for three seconds.



Press the stop record button repeatedly to navigate through the options. Press the start record button to select your preferred option. For further information on each option please see below.

Symbol	Mode	Further Information
	Video	Page 15
	Silent	Page 15
	Audio	Page 15
	Time Lapse	Page 15
	Auto Video	Page 15
	Piv	Page 16
	Single Shot	Page 18

9. Video Recording



Fast Shot

Page 18



Cont Capture

Page 18



Timed

Page 18



Settings

Page 10

Switching quickly between video and photo

Whilst in video mode press the capture button once to enter photo mode. Whilst in photo mode press the start record button once to enter video mode.

Make sure that a microSD card is inserted and turn the camcorder on. Select your preferred video mode and press the start record button on the front of the camcorder to start recording. The LEDs around the start record button will turn solid blue, the red status LED will turn off and the top LED indicator will flash blue.

To stop recording press the stop record button on the top of the camcorder. The blue LEDs will turn off and the red status LED will turn back on.

Video Settings

Note: To change the video settings you must be in video mode before you enter the settings menu.

Enter the settings menu and then select the video settings menu. Use the stop record button to move between the options. Press the start record button to select the option you want to change and the camera button to exit the option that you are in.

Choose between



VIDEO

Video

Record video and audio together



Silent

Record video only



Audio

Record audio only



Time Lapse

Record a time lapse video. Set the camcorder to take an image every 1, 2, 5, 10 or 30 seconds. Press the start record button to start taking images and press the stop record button to finish. Camcorder will automatically create a time lapse video using the images.



Auto Video

Video self-timer. After pressing the start record button the camcorder will start recording after 5, 10 or 20 secs.

10. G-Sensor



Piv Set the camcorder to take a photo every 5, 10, 30 or 60 seconds whilst recording video at the same time. Select HM so that you can manually press the capture button at any point during filming to take a photo without having to stop recording.



Choose between

PAL (see page 11, camcorder settings)	NTSC (see page 11, camcorder settings)
1080p at 24fps, 25fps, 48fps or 50fps	1080p at 24fps, 30fps, 48fps or 60fps
960p at 48fps or 50fps	960p at 48fps or 60fps
720p at 50fps or 100fps	720p at 60fps or 120fps



Choose the angle of view for recording between wide (140°), medium (120°), narrow (100°) and small (80°).



Choose the bit rate for recording videos between fine or normal. The fine bit rate is higher so you will get a clearer picture with an increased file size.



Loop Record – Turn on to continually overwrite files when the memory becomes full.



180° photo rollover. Turn this option on to keep your videos upright when using the camcorder upside down.



Turn the date and time stamp on or off.

The G-Sensor mode on the K-Series camcorder is a camera movement activation function. This means that when the G-Sensor mode is turned on it will actively sense a change in gravity, for example if it is knocked, tilted or moved, and will start recording automatically without needing to press the start record button. If the camcorder has not sensed any gravity change for 3 minutes it will stop recording. You can also stop recording by manually pressing the stop record button.

Please note that this is a video function only and if the G-Sensor mode is turned on whilst in camera mode it will automatically revert to video mode and then start recording if it senses a change in gravity.

11. Photo capture

Make sure that a microSD card is inserted and turn the camcorder on. Press the camera button once on the top of the camcorder to enter photo mode. Select your preferred photo mode and then press the camera button on the top of the camcorder to take a photo.

Photo Settings

Note: To change the photo settings you must be in photo mode before you enter the settings menu.

Enter the settings menu and then enter the photo settings menu. Use the stop record button to move between the options. Press the start record button to select the option you want to change and the camera button to exit the option that you are in.



Choose between

Single Shot Capture a single photo



Fast Shot Choose between capturing 3 photos in 1 second, 6 photos in 1 second or 8 photos in 1 second. When you press the camera button the top LED indicator will flash twice quickly to indicate all photos have been taken.



Cont Capture Choose between continually capturing a single photo every 0.5, 1, 2, 3, 5, 10 or 20 seconds. Press the camera button to start taking photos. The top LED indicator will flash blue each time a photo is taken. To stop taking photos press the stop record button.



Timed Photo self-timer. After pressing the camera button the camcorder will take a photo after 3, 5 or 10 seconds. The top LED indicator will flash blue when the photo has been taken.



16MP

Choose between capturing 16, 12 or 8 mega pixel images.



OFF

Turn the date and time stamp on or off.

12. K-Series Waterproof Case

Please ensure that you keep the rubber seal that lines the waterproof case clean. Small particles such as a hair or grain of sand can break the waterproof seal and cause a leak and damage your K-Series camcorder.

If you use the waterproof case in salt water rinse it with fresh water after each use. Failure to do this will cause a build-up of salt and compromise the waterproof seal.

Never dry the waterproof case with a cloth as lint may compromise the waterproof seal, either shake dry or leave to air dry.

Veho cannot be held liable for consequential, incidental and contingent damages to personal property due to misuse or improper installation, or improper care and maintenance of the K-Series waterproof case. Veho will not, under any circumstance, cover the replacement or cost of repair of any electronic device or personal property inside or outside of the case.

Anti-Mist Inserts

To prevent misting when using the waterproof case place two Anti-Mist inserts down the sides of the waterproof case prior to use, ensuring that they do not interfere with the rubber seal on the housing. The insert will soak up any moisture and stop the lens from misting. To reuse dry the insert in an oven at 150°C/300°F for 5 minutes. Each insert can be re-used 4-5 times. Please ensure that you store the inserts in an airtight bag.



13. Download and install app

The free Muvi K-Series app is available for iOS and Android and allows you to connect your K-Series camcorder to your phone using the in-built WiFi.

To install the app on your phone open the App Store (iOS) or Play Store (Android) on your phone and use the search function to search for Muvi K-Series. Select the app and then click on the install button to install the app on your phone.

14. Turning on the WiFi and connecting to the app

Turning on the WiFi

Please note that to use the K-Series camcorder with the app you will need to have a microSD card inserted in the camcorder as all videos and images will be saved to the microSD card and not the the phone itself.

To connect to the Muvi K-Series app you will need to turn on the WiFi on the camcorder. Turn the camcorder on and then, once the LCD information display appears move the WiFi switch on the front of the camcorder to the WiFi position. The blue LEDs on the bottom of the camcorder will flash slowly to indicate that the WiFi is turned on.

Connecting to the app

Turn on the WiFi on your phone and then enter the phone's WiFi settings. Look for Muvi K-Series in the list of available networks and select to connect. You may need to refresh the list or scan for networks for the camcorder to appear. Please enter 00000000 as the password.

Exit the WiFi settings and open the Muvi K-Series app on your phone.



To finish connecting to the app click on the arrows.



Once connected to the app the WiFi icon will appear on the LCD display.

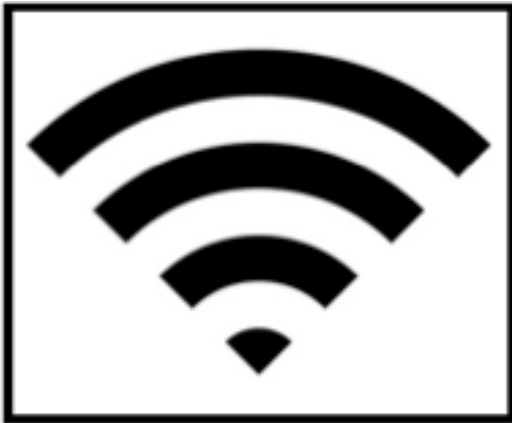

If the WiFi connection has failed the app will ask if there was a failed connection.

For iOS users select yes and the app will automatically start to try and connect again.

If this fails exit the app and go the WiFi settings to connect to the camcorder again.

For Android users select yes and then click on the WiFi icon to return to your phone's WiFi settings so that you can connect again.

To enter the app without connecting the camcorder select no when the app asks if there was a failed connection and then click on the arrows. You can then enter the app to view local files on your phone.

15. Guide to using the app

Video recording

Make sure that you are in video record mode by pressing the Video button. The Video button will turn blue to indicate that it is in video record mode. Start recording by pressing the camcorder icon to the right of the preview screen.

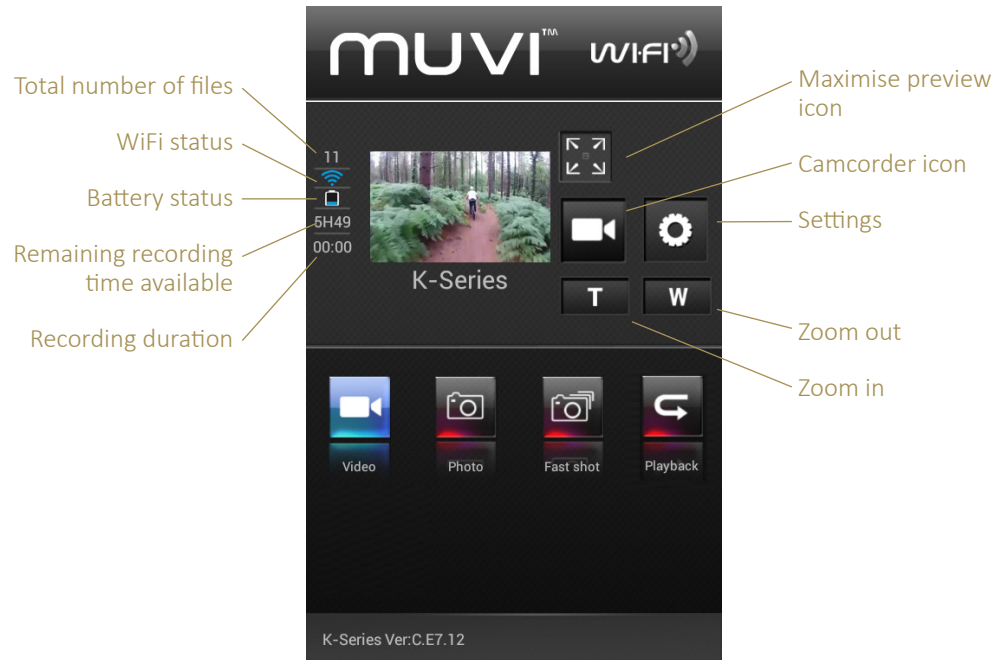

The camcorder icon will turn blue to indicate that it is recording and the blue LEDs around the start record button on the camcorder will turn on.

To stop recording press the camcorder icon again. The icon will turn white to indicate that the camcorder has stopped recording.

Photo capture

Make sure that you are in photo capture mode by pressing the Photo button. The Photo button will turn blue to indicate that it is in photo capture mode. Take a photo by pressing the camera icon to the right of the preview screen. The top LED indicator on the camcorder will flash blue once to indicate that a photo has been captured.



Fast shot photo capture



Make sure that you are in fast shot capture mode by pressing the Fast Shot button. The Fast Shot button will turn blue to indicate that it is in fast shot capture mode. Take several photos in one second by pressing the fast shot camera icon to the right of the preview screen. The top LED indicator on the camcorder will flash blue once to indicate that the photos have been captured.

Maximise the preview screen

You can maximise the preview screen in Video, Photo and Fast Shot mode. To maximise the preview screen press the maximise icon to the right of the preview screen. You can view the maximised preview screen in both portrait and landscape. To record video or capture a photo or fast shot press the camcorder or camera icon (dependant on mode) at the bottom of the screen. To exit the maximised preview screen press the back button at the top in the right hand corner.

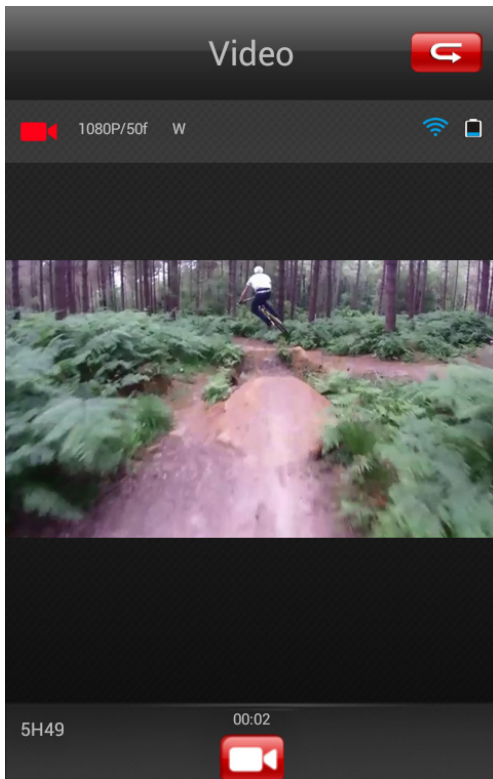

Close the preview screen

You can close the preview screen in both normal and maximised screen modes. To close the preview tap the preview screen. The message Preview closed will appear. To open the preview tap the preview screen again and the preview will reappear.

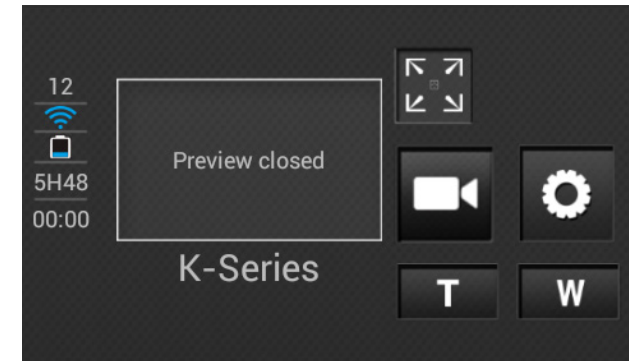

Zooming in and out

To zoom in press the T icon and to zoom out press the W icon. Please note that you cannot zoom in or out whilst in the maximised screen, therefore if you wish to zoom in or out you must first do this in the normal preview screen mode and then press the maximise screen icon.

Settings

To change settings on the camcorder press the settings icon to enter the settings menu. You can only change the size in record settings when you are in video record mode first. Not all of the camcorder's functions are supported by the app but you can change the following settings:

Record Settings

Size	Set the resolution and frame rate for video capture
View	Set the angle of view between broad, medium, narrow and small
Bit Rate	Set the bit rate between normal and high bit rate

Capture Settings

Size	Choose between capturing 8, 12 or 16 mega pixel images
Fast Shot	Choose between capturing 3 photos in 1 second, 6 photos in 1 second or 8 photos in 1 second

Param Settings

Warning Tone	Set the volume of the warning indicator to off, medium or standard
Front Indicator	Turn the status indicator on the camcorder off or on
Video Content Loop	Turn on to continually overwrite files when the memory becomes full
TV Output Format	Set the TV output to PAL or NTSC

Language	Change the language on the camcorder. Note: Does not change the language of the app
Date/Time	Set the date and time on the camcorder to match the date and time on your phone
Format	Select yes to format the microSD card. Note: Formatting will delete all files
Version	Shows the version of Muvi K-Series firmware that you have
Nesignation	Shows the WiFi name of your Muvi K-Series camcorder

Playback

To view your videos and photos press the Playback button. Thumbnails of your video and photos on the microSD card will load in the playback screen.

To view the required video or photo tap the relevant thumbnail and the video or photo will maximise.

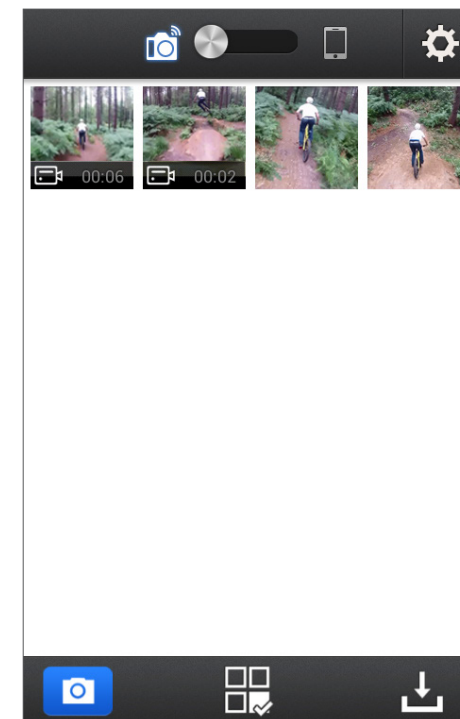



To play the video tap the play button in the centre of the screen.

To move to the next video or photo slide your finger across the screen to the left or to the right. The information and icons displayed around the video or photo will disappear after 4 seconds. To bring them back tap the screen.

 To download the video or photo to your phone tap the download icon.

On iOS the file will be saved in the app, on Android the file will be saved in the Gallery.

 To delete the video or photo press the bin icon.

 Press the back key to return to the thumbnails.



Downloading and deleting multiple files

To edit the download settings press the settings icon in the top right hand corner. Here you can choose between Quick Download Original files and you can also clear the cache data.

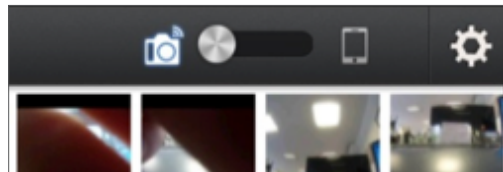

To download multiple files press the download icon in the bottom right hand corner, then tap the files you wish to download or select download all to download all files.



As soon as you tap a thumbnail it will begin to download and an icon will appear in the top right hand corner of the thumbnail:

Icon



Meaning

File waiting to download



File in the process of downloading



File successfully downloaded

To cancel the download press the cancel button.

To delete multiple files press the selection icon  then tap the thumbnails of the files you wish to delete and select delete selected item(s).

Downloaded files

To see the files that you have downloaded to your phone move the slider at the top of the screen from the camera icon to the phone icon.

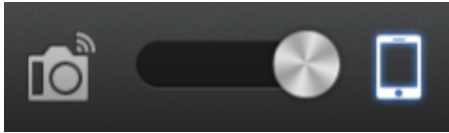

Once downloaded to your phone you can use the app to share your photos and videos through social media and to trim your videos.

To share a video or photo press the selection icon, tap the thumbnails of the files you want to share, then tap share icon in the bottom left of the screen and choose the social media platform that you wish to use.

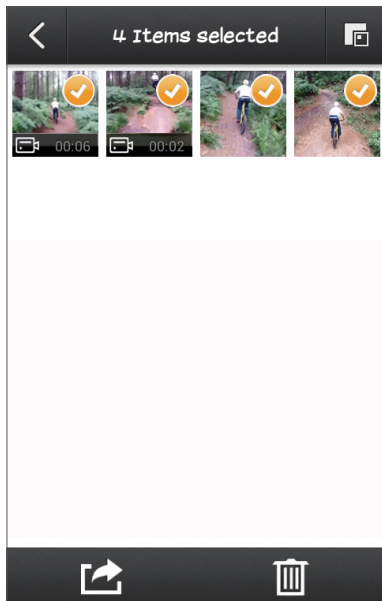

To trim your videos tap the thumbnail of the video you wish to edit and then tap the edit icon

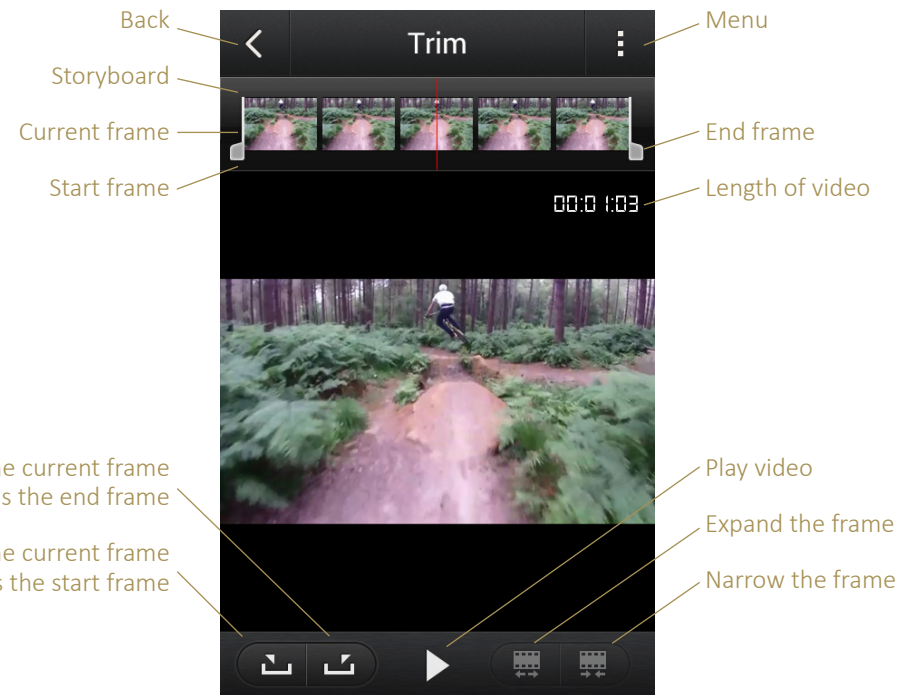

To trim the video drag the start frame and end frame markers inwards on the storyboard or play the video and pause at the moment you want to start/end the film and press the set current frame as the start/end frame button as required.

16. K-Series Camcorder Specs

You can use the expand frame button to stretch the storyboard for more accurate trimming. Use the narrow frame button to reduce the length of the storyboard.

To save your edited file press the menu button in the top right hand corner and select Save. The file will be saved as a new video and will not overwrite the original.

To return to the original file press the back button. To return to the thumbnails press the back button again.

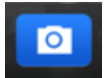

To return to the preview screen press the camera button in the bottom left hand corner

Camera Optics

Minimum focal range	2.5cm
Maximum focal range	Endless
Aperture	f/2.8
Focus	Fixed focus
Angle	140 degrees

Video

Resolution	Full HD 1080p
Frame rate	24, 25, 30, 48, 50, 60, 100 or 120 (dependant on PAL or NTSC setting)
Bit rate	19 mbit/s
Sensor type	CMOS lens
Video recording format	MOV (H.264 codec)

Photo

Photo resolution	16 mega pixels
Photo format	JPG

Power and battery

Battery	1500mAh lithion rechargeable
Battery charge time	Approximately 3 hours
Battery life	Up to 3 hours continuous recording

Other

Audio recording format	WAV
WiFi transmission range	Up to 60 metres
Memory	Up to 32GB microSD/microSDHC card
Connections	Mini USB, HDMI out, AV out
Storage temperature	-10°C ~ 60°C
Operating temperature	-10°C ~ 50°C
Dimensions	L59 x W43 x D35mm
Weight	84g

veho[®]

www.veho-world.com