



RAZER HAMMERHEAD
TRUE WIRELESS X

MASTER GUIDE

Light it up with the **Razer Hammerhead True Wireless X**—high-performance earbuds engineered to illuminate every beat. Packing a 60ms low latency Gaming Mode along with custom-tuned 13mm drivers, brace yourself for audio that rises above the noise.

CONTENTS

1. WHAT'S INSIDE / WHAT'S NEEDED.....	3
2. LET'S GET YOU COVERED.....	5
3. TECHNICAL SPECIFICATIONS.....	6
4. GETTING STARTED.....	7
5. USING YOUR EARBUDS.....	10
6. SAFETY AND MAINTENANCE.....	14
7. LEGALESE.....	15

1. WHAT'S INSIDE / WHAT'S NEEDED

WHAT'S INSIDE

- Razer Hammerhead True Wireless X earbuds

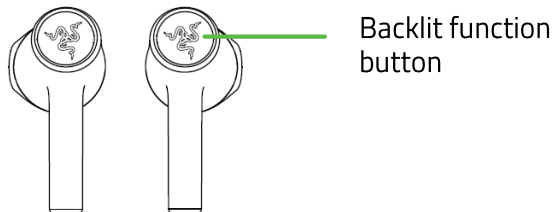

- Charging case

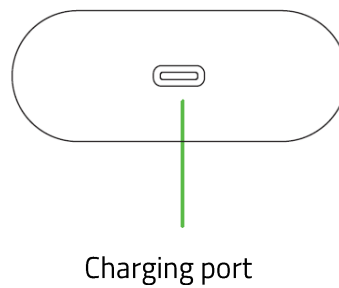
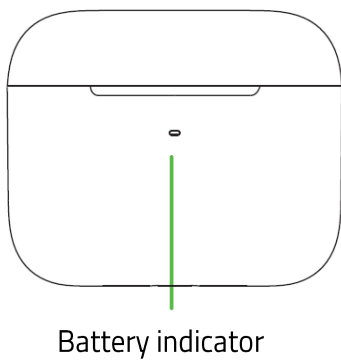

- Charging cable



- Silicone earbud sleeves



- Important Product Information Guide

WHAT'S NEEDED

- Devices with Bluetooth audio capability
- Internet connection for app installation

2. LET'S GET YOU COVERED

You've got a great device in your hands, complete with a 2-year limited warranty coverage. Now maximize its potential and score exclusive Razer benefits by registering at razerid.razer.com

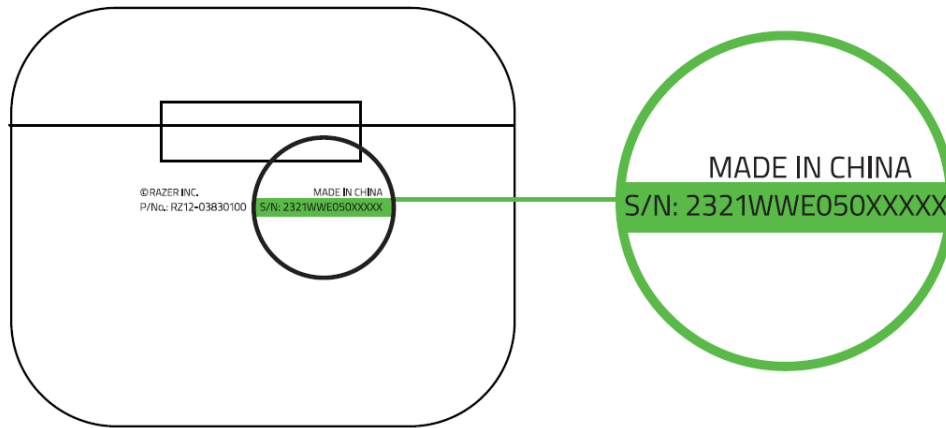

Your product's serial number can be found here.

Got a question? Ask the Razer Support Team at support.razer.com

3. TECHNICAL SPECIFICATIONS

- Headphone frequency response: 20 Hz – 20 kHz
- Headphone impedance: 32 Ω
- Headphone sensitivity: 91 db @ 1 mW / 1 kHz
- Headphone input power: 8 mW (max input)
- Headphone drivers: 13 mm
- Headphone Connector: Bluetooth 5.2
- Microphone pick up pattern: Omnidirectional
- Microphone signal-to-noise ratio: 64 dB
- Microphone sensitivity: -26 dBFS
- Weight:
 - Charging Case: 0.09 lbs / 42 g
 - Earbuds: 0.02 lbs / 10 g each

4. GETTING STARTED

CHARGING YOUR RAZER HAMMERHEAD TRUE WIRELESS X

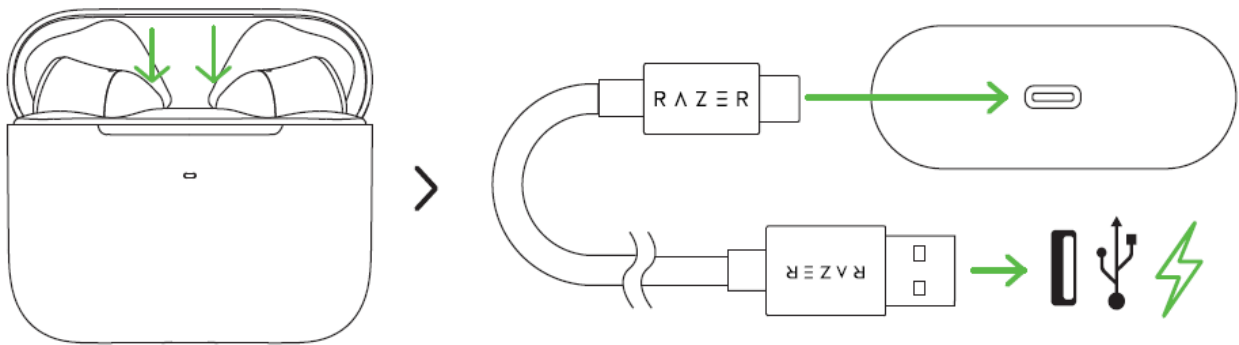

For first time use, connect the charging case to a USB port using the charging cable without removing the earbuds. For subsequent use, the charging case and the earbuds can be charged independently.





Wait until your Razer Hammerhead True Wireless X is fully charged.

BATTERY INDICATOR FOR THE CHARGING CASE

When Plugged In

	Status
Static red 	Charging
Static green 	Fully charged

When Unplugged

	Status
Static green 	Battery full
Static orange 	Battery low
Blinking red 	Battery critical

PAIRING TO A MOBILE DEVICE

When trying to connect your Razer product, remember to keep it within 1 meter of your mobile device.

1. While inside the charging case, simply open the lid to enter pairing mode.



2. Enable Bluetooth on your mobile device and select **Razer Hammerhead TWS X** from the list of devices found.

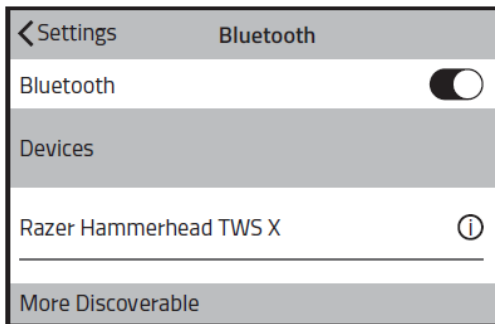

iOS

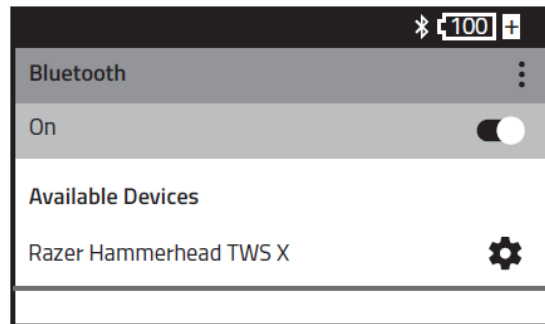

Android

3. Wait for pairing to complete. You will hear an audio prompt when the earbuds have successfully paired and connected to your device.



If the earbuds fail to connect to your audio source, the earbuds will stay in search mode then power off after 3 minutes. If this happens, simply repeat the steps again to pair.



Once the earbuds have been paired, it will automatically try to connect to that paired mobile device every time the charging case's lid is opened, or the earbuds are powered on. Your earbuds can only connect to one mobile device at a time.

5. USING YOUR EARBUDS

GAMING MODE

While connected, triple tap then hold the last tap for at least 2 seconds on any earbud to activate gaming mode. Once enabled, your earbuds will function at a lower latency; giving you real-time audio feedback while gaming. Repeat the same gesture to disable gaming mode.

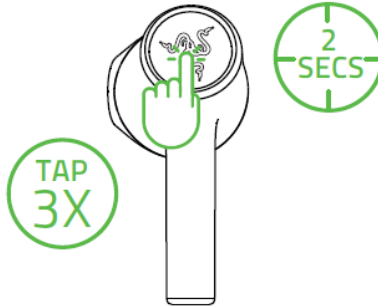

i For best performance, it is recommended to keep your earbuds within a very close distance of the audio source.

USING THE SILICONE EARBUD SLEEVES

The silicone earbud sleeves offer increased comfort, sound isolation, and security. The soft texture feels better against your ear compared to bare plastic. Device audio improves by separating it from surrounding noise. The sleeves also help to keep the earbud secure by providing grip.

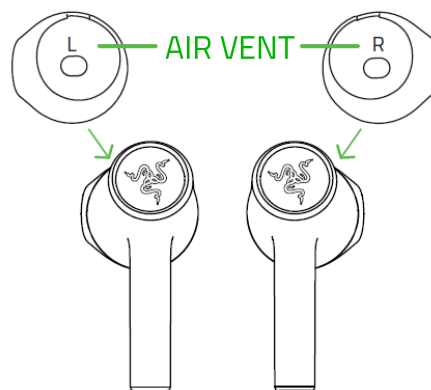

To use them, simply insert the earbud into the corresponding sleeve, and make sure each air vent is properly aligned with the sleeve opening.

POWER ON/OFF

To power off the device, simply place the earbuds back inside the charging case and close the lid. Opening the lid if they are in the charging case will power them on.

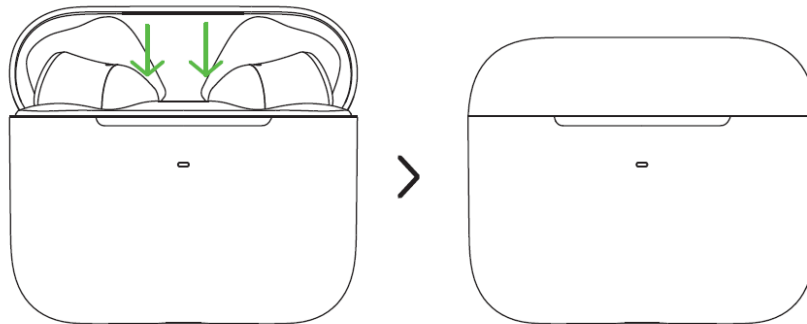

If the earbuds are left idle outside the charging case for a few minutes, you will hear an audio prompt and then the earbuds will power off.



Tap and hold the function button on each earbud for at least 2 seconds to power them on again. You will hear an audio prompt from each earbud once they are powered on.

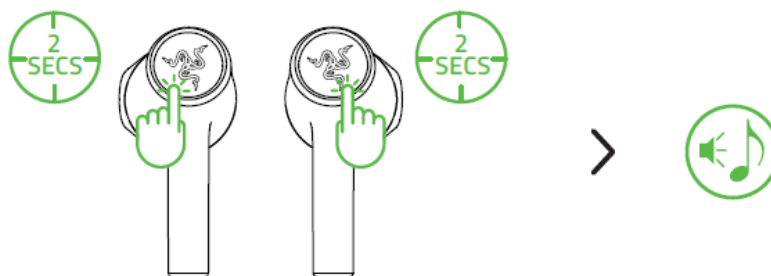

FUNCTION BUTTON QUICK REFERENCE

The following functions are only available when the earbuds are paired to a mobile device.

ACTION	EFFECT	AUDIO PROMPT
Tap	Answer call	Voice
	End call	Tone
	Play/pause media	None
Tap and hold for 2 seconds	Power on the corresponding earbud	Voice
	Reject incoming call	Voice
Tap and hold for 4 seconds	Activate pairing mode for the corresponding earbud	Voice
Double tap	Accept incoming call or switch calls	None
	Skip to the next track when playing media	None
Double tap then hold the last tap for 2 seconds	Decrease volume (on the left earbud)	None
	Increase volume (on the right earbud)	
Triple tap	Return to the previous track when playing media	None
Triple tap then hold the last tap for 2 seconds*	Enable/disable Gaming Mode	Voice
	While in pairing mode, clear paired devices	Voice

RAZER AUDIO APP

Making advanced customization just got a whole lot easier for your Razer Hammerhead True Wireless X earbuds. With the Razer Audio app, learn all its gestures, select from predefined EQs or customize one as needed, remap what each tap or gesture function does and much more—anytime, anywhere.

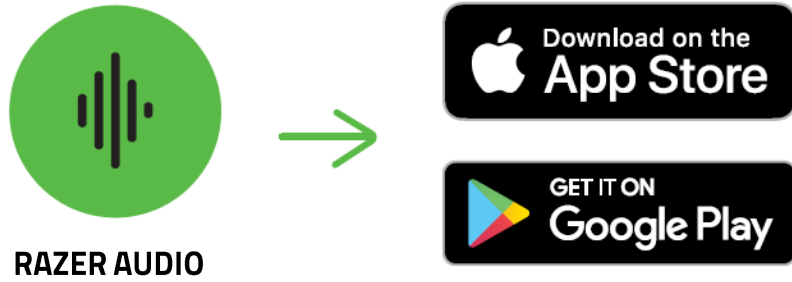

6. SAFETY AND MAINTENANCE

SAFETY GUIDELINES

In order to achieve maximum safety while using your Razer Hammerhead True Wireless X, we suggest that you adopt the following guidelines:

Should you have trouble operating the device properly and troubleshooting does not work, unplug the device and contact the Razer hotline or go to support.razer.com for assistance.

Do not take apart the device (doing so will void your warranty) and do not attempt to operate it under abnormal current loads.

Keep the device away from liquid, humidity or moisture. Operate the device only within the specific temperature range of 0°C (32°F) to 40°C (104°F). Should the temperature exceed this range, unplug and/or switch off the device in order to let the temperature stabilize to an optimal level.

The device isolates external ambient sounds even at low volumes, resulting in lowered awareness of your external surroundings. Please remove the device when engaging in any activities that requires active awareness of your surroundings.

Listening to excessively loud volumes over extended periods of time can damage your hearing. Furthermore, legislation of certain countries permits a maximum sound level of 86db to affect your hearing for 8 hours a day. We therefore recommend that you reduce the volume to a comfortable level when listening for prolonged periods of time. Please, take good care of your hearing.

MAINTENANCE AND USE

The Razer Hammerhead True Wireless X requires minimum maintenance to keep it in optimum condition. Once a month we recommend you clean it using a soft cloth or cotton swab to prevent dirt buildup. Do not use soap or harsh cleaning agents.

7. LEGALESE

COPYRIGHT AND INTELLECTUAL PROPERTY INFORMATION

©2021 Razer Inc. All rights reserved. Razer, the triple-headed snake logo, Razer logo, and “For Gamers. By Gamers.” are trademarks or registered trademarks of Razer Inc. and/or affiliated companies in the United States or other countries. All other trademarks are the property of their respective owners.

©2018 Google LLC All rights reserved. Android, Google, Google Logo, Google Play, and the Google Play logo are registered trademarks of Google LLC.

Apple, the Apple logo, and iPhone are trademarks of Apple Inc., registered in the U.S. and other countries. App Store is a service mark of Apple Inc.

The Bluetooth® word mark and logos are registered trademarks owned by Bluetooth SIG, Inc., and any use of such marks by Razer is under license.

Razer Inc. (“Razer”) may have copyright, trademarks, trade secrets, patents, patent applications, or other intellectual property rights (whether registered or unregistered) concerning the product in this guide. Furnishing of this guide does not give you a license to any such copyright, trademark, patent or other intellectual property right. The Razer Hammerhead True Wireless X (the “Product”) may differ from pictures whether on packaging or otherwise. Razer assumes no responsibility for such differences or for any errors that may appear. Information contained herein is subject to change without notice.

LIMITED PRODUCT WARRANTY

For the latest and current terms of the Limited Product Warranty, please visit [razer.com/warranty](https://www.razer.com/warranty).

LIMITATION OF LIABILITY

Razer shall in no event be liable for any lost profits, loss of information or data, special, incidental, indirect, punitive or consequential or incidental damages, arising in any way out of distribution of, sale of, resale of, use of, or inability to use the Product. In no event shall Razer’s liability exceed the retail purchase price of the Product.

GENERAL

These terms shall be governed by and construed under the laws of the jurisdiction in which the Product was purchased. If any term herein is held to be invalid or unenforceable, then such term (in so far as it is invalid or unenforceable) shall be given no effect and deemed to be excluded without

invalidating any of the remaining terms. Razer reserves the right to amend any term at any time without notice.