



OWNER'S MANUAL LG DRYER



Please read this manual carefully before operating your dryer and retain it for future reference.

RC7066***



MFL67653051

www.lg.com

Features



- **Big Capacity Drum**
The Big Capacity drum on this LG Dryer allows you to dry your washing in larger loads than ever before.

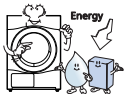

- **Lower Energy Consumption**
LG dryers use less energy than conventional dryers due to the cutting-edge technology we have applied to the drying system and to the heat control mechanism. This LG Dryer has been designed to save you money.



- **Reduced drying times**
Drying times are now shorter due to the efficient air flow mechanism and optimised heater on this LG Dryer.



- **Reduced noise levels**
We have reduced the operating noise of this LG Dryer by using innovative sound-absorbing and noise-screening technologies, making it much quieter than conventional dryers.

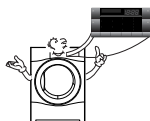

- **Easy of Use**
The wide, electronically controlled LED display on this machine is very easy to use. Simply select the programme you require and your LG Dryer will do the rest.

Contents

○ Safety Instructions3	○ Using SmartDiagnosis™29
○ Installation Instructions6	○ Technical Data30
○ Appearance & Design10	○ Warranty31
○ Operating Your Dryer11	
○ Additional Functions17	
○ Caring for Your Dryer19	
○ Additional Tips for Smart Use22	
○ Troubleshooting Guidelines27	

Safety Instructions

For your safety, the information in this manual must be followed to minimise the risk of fire or explosion, electric shock, or to prevent property damage, personal injury or death.

⚠ WARNING

- Serious injury or death may occur when not observing the following rules.
- It is strictly forbidden to use the product for anything other than the manufacturer authorised usage. LG doesn't take full responsibility for the damage by inaccurate and improper usages.
- Do not repair or replace any part of the dryer or attempt any servicing unless specifically recommended in the user-maintenance instructions or published user-repair instructions that you understand and have the skills to carry out.

⚠ WARNING

- This appliance is not intended for use by persons (including children) with reduced physical, sensory or mental capabilities, or lack of experience and knowledge, unless they have been given supervision or instruction concerning use of the appliance by a person responsible for their safety.
- Children should be supervised to ensure that they do not play with the appliance.

For use in Europe:

- This appliance can be used by children aged from 8 years and above and persons with reduced physical, sensory or mental capabilities or lack of experience and knowledge if they have been given supervision or instruction concerning use of the appliance in a safe way and understand the hazards involved. Children shall not play with the appliance. Cleaning and user maintenance shall not be made by children without supervision.
- Children of less than 3 years should be kept away unless continuously supervised.

⊘ Hazards

- Before plugging in the power cord, make sure cord is earthed and connected to circuit breaker.
No earthing may cause breakdowns or an electric shock.
- Do not plug into an adaptor. Do not use with an extension lead.
Abnormal heating of outlet may cause a fire.
- Do not remove the top plate when installing the dryer.
- Do not modify this product.
May cause breakdown, fire or electric shock.
- Keep the dryer away from cookers, naked flames, or any other inflammable objects.
May cause fire or parts to melt.
- Do not use a damaged power cord or place heavy objects on the cord.
A damaged power cord may cause fire or electric shock.

Safety Instructions

- Do not touch the plug or switch on with wet hands.
May cause electric shock.
- Disconnect the power cord by grasping the plug, not the cord.
May cause damage of cord resulting in fire or electric shock.
- Wipe dirt and stains from the power cord and insert the plug firmly into the socket.
Dirt and poor connections may cause fire.
- Do not use if power cord, plug or socket is damaged.
May cause fire or electric shock.
- Do not install or store the dryer where it will be exposed to the weather.
May cause fire, electric shock or malfunction.
- Do not use an extension cord or an adaptor to connect the power cord.
May cause fire or electric shock.
- Do not splash water on to the dryer.
May cause fire or electric shock.
- Unplug the power cord when cleaning or not using the dryer.
Water or dirt may cause an electric shock.
- Do not allow children or pets to play on or inside the dryer.
- The appliance is not intended for use by young children or infirm people without supervision.
- Keep pets away from the dryer.
Pets may damage the dryer, or may receive an electric shock.
- Do not depress buttons using sharp implements such as knives and screwdrivers.
May damage the dryer or cause electric shock.
- Do not dry articles that have been cleaned in, washed in, soaked in, or spotted with combustible or explosive substances (such as wax, oil, paint, gasoline, degreasers, dry-cleaning solvents, kerosene, etc.).
May cause fire or explosion.
- Do not place flammable items near the dryer.
May cause toxic gases, parts damage, fire or explosion.
- Before the appliance is removed from service or discarded, disassemble the door and cut off the power cord to prevent the future use.
May cause accident and injury.
- The packaging is not a toy. Destroy after opening.
To avoid the possibility of suffocation, keep the packaging away from babies and children.
- If this appliance is supplied from a cord extension set or an electrical connector, the portable outlet device must be positioned so that it is not subject to splashing or moisture.
It may cause an electric shock, a fire, malfunction or deformation.
- Items that have been spotted or soaked with vegetable or cooking oil constitute a fire hazard and should not be placed in a tumble dryer.
- Items that have been soiled with substances such as cooking oil, acetone, alcohol, petrol, kerosene, spot removers, turpentine, waxes and wax removers should be washed in hot water with an extra amount of detergent before being dried in the tumble dryer.
May cause spontaneous combustion leading to explosion and fire.
- Items that have been previously cleaned in, washed in, soaked in or spotted with petrol/gasoline, dry cleaning solvents or other flammable or explosive substances should not be used in a tumble dryer.
May cause spontaneous combustion leading to explosion and fire.

Safety Instructions

- Items made of foam, rubber, plastic, or other heat-sensitive fabrics (such as bathroom rugs, nonslip mats or raincoats) should not be dried in a tumble dryer on a heat setting.
- Items such as foam rubber (latex foam), shower caps, waterproof textiles, rubber backed articles and clothes or pillows fitted with foam rubber pads should not be dried in the tumble dryer.
May cause spontaneous combustion leading to explosion and fire.
- Plastic articles such as shower caps or waterproof nappy covers should not be placed in a tumble dryer.
May cause spontaneous combustion leading to explosion and fire.
- If dryer is installed on a carpet, damage may be caused to it by ventilated air.
May cause spontaneous combustion leading to explosion and fire.
- Fabric softeners, or similar products, should be used as specified by the fabric softener instructions.
- The tumble dryer is not to be used if industrial chemicals have been used for cleaning
- Remove all objects from pockets such as lighters and matches.
- Fabric softeners, or similar products, should be used as specified by the fabric softener instructions.
- To reduce the risk of personal injury, adhere to all industry recommended safety procedures including the use of long sleeved gloves and safety glasses.
Failure to follow all of the safety warnings in this manual could result in property damage, personal injury or death.
- **If the supply cord is damaged, it must be replaced by the manufacturer, its service agent or similarly qualified persons in order to avoid a hazard.**
- The appliance must not be installed behind a lockable door, a sliding door or a door with a hinge on the opposite side to that of the tumble dryer, in such a way that a full opening of the tumble dryer door is restricted.
- Do not dry unwashed items in the tumble dryer.
- Never stop a tumble dryer before the end of the drying cycle unless all items are quickly removed and spread out so that the heat is dissipated.
- The lint trap has to be cleaned frequently, if applicable.
- Lint must not to be allowed to accumulate around the tumble dryer.
- Filter must be cleaned after every cycles are completes.

Installation Instructions

The following instructions will guide you through the initial steps of setting up your dryer. Please note that every section of this manual provides important information regarding the preparation and use of your dryer, and it is important that you review this entire manual before proceeding with any installation or use. Be sure to observe all listed warnings and cautions. These installation instructions are intended for use by qualified installers. Read these installation instructions completely and carefully.

Safety Information

Risk of Injury

The dryer is very heavy so you shouldn't try to lift it alone.

Do not lift the dryer by grasping any of the protruding parts, e.g. the jog dial or the door, they may break off.

Risk of Falling or Tripping Up

Ensure there are no loose hoses or cables.

Check the dryer for damage occurred during transportation.

Do not connect the dryer if it has visible signs of damage.

If you are not confident, contact your local LG agent. Always empty the dryer completely before transporting it.

Your dryer should not be located near to a gas hob, cooker, heater or grill, as flames from the burners could damage your dryer. When the dryer is fitted beneath a work surface, allow 30cm~50cm space at either side of the dryer and at the back of the dryer to allow air to exit the rear grille. This air flow is critical for condensation of water during the drying process.

If you use this dryer near or stacked on top of your washing machine, separate main plugs and sockets must be used for each appliance. Do not use 2-way adaptor or extension lead.

You can stack the dryer on top of your washing machine to save space. A stacking kit is available from your local appliance specialist.

■ Stacking Installation Instructions

Your LG dryer can be placed on top of a front loading washing machine and securely fixed with a stacking kit (see following page for instructions). This installation must be conducted by an experienced installer to ensure it has been installed correctly.

An installer will ensure you have the correct stacking kit for your model of washing machine and will ensure it is firmly fixed. For these reasons, expert fitting is essential.

▲ CAUTION

CAUTION Concerning the power cord

Most appliances recommend they be placed upon a dedicated circuit; that is, a single outlet circuit which powers only that appliance and has no additional outlets or branch circuits. Check the specification page of this owner's manual to be certain.

Do not overload wall outlets. Overloaded wall outlets, loose or damaged wall outlets, extension cords, frayed power cords, or damaged or cracked wire insulations are dangerous. Any of these could result in an electric shock or fire. Periodically examine the cord of your appliance, and if its appearance indicates damage or deterioration, unplug it, discontinue use of the appliance, and have the cord replaced with an exact replacement part by an authorised servicer.

Protect the power cord from physical or mechanical abuse, such as being twisted, kinked, trapped in a door, or walked upon. Pay particular attention to plugs, wall outlets, and the point where the cord exits the appliance.

Installation Instructions

Stacking Kit

In order to stack this dryer on top of an LG washing machine, a stacking kit is required.

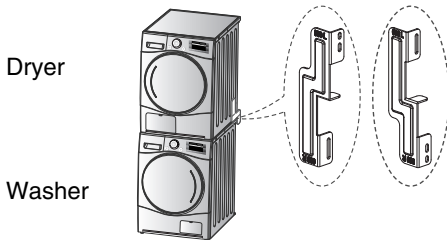

This dryer may only be stacked on top of an LG washer. Do not attempt to stack this dryer on any other washer, as damage, injury or property damage could result.

Shape and assembly direction	Washer Top plate size	
	21.7 inch (550mm)	23.6 inch (600mm)

Installation Procedure

1. Place the LG dryer on the LG washing machine.
2. Remove the two screws from the bottom of the rear cover on each side as illustrated below.

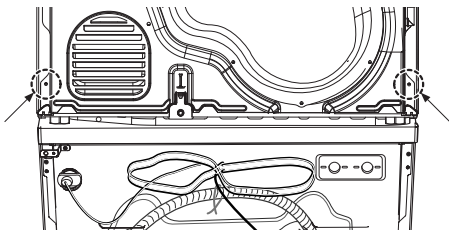

⚠ WARNING

- Incorrect installation can cause serious accidents.
- The weight of the dryer and the height of installation makes the stacking procedure too risky for one person. This procedure should be performed by 2 or more experienced service personnel.
- The dryer is not suitable for a built-in installation. Please do not install as a built-in appliance.
- Do not operate if the dryer is disassembled.

3. Align the stacking kit holes and the rear cover holes.

3-1) 23.6 inch(600mm)

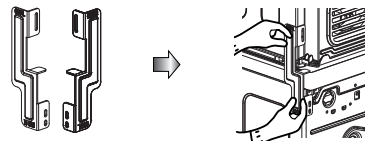

3-2) 21.7 inch(550mm)

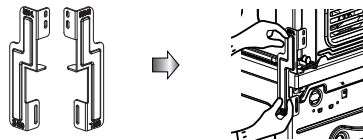

- Fasten the 2 screws that were removed earlier from dryer to stacking kit.
- Use 4 screws in accessory box [0.6inch(16mm)] to assemble washer rear cover and stacking kit.
- The procedure for the opposite side will be the same.

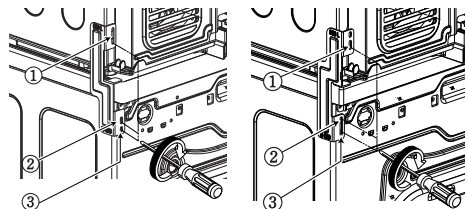

Installation Instructions

Earthing Instructions

This appliance must be earthed. In the event of malfunction or breakdown, earthing will reduce the risk of electric shock by providing a path of least resistance for the electric current.

This appliance is equipped with an earthed cord and an earthing plug. The plug must be plugged into an appropriate outlet that is properly installed and earthed in accordance with local standards.

Additional Grounding Procedure

Some countries may require a separate ground. In such cases, the required accessory ground wire, clamp and screw must be purchased separately.

Condensed Water Drain

This appliance can be plumbed directly into the mains waste with the adaptor supplied. Condensed water will drain away. A plumber will be required.

▲ NOTE

- For better drying performance, please keep the rear of product away from the walls.
- Do not install the dryer where there is a risk of frost or dust.
 - The tumble dryer may not be able to operate properly or may be damaged by freezing of condensed water in the pump and drain hose.

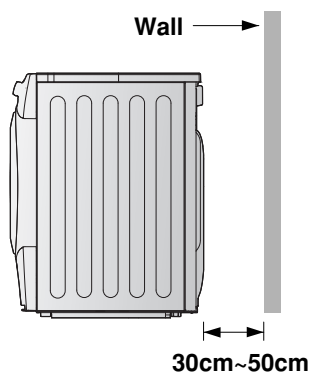

▲ WARNING

The dryer should not be installed next to a refrigeration appliance.

- ▶ Do not install the dryer next to a high-temperature appliance, such as a refrigerator, oven or stove etc, which can affect drying performance and duration.

The dryer works best at a room temperature of 23°C.

▲ WARNING

Avoid installing the product around a heat source.

The warm air venting from the rear side of the dryer must be well ventilated. If not, this can bring on problems.

Installation Instructions

■ Level the Dryer

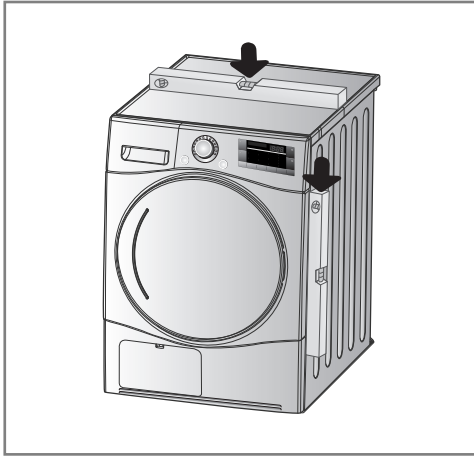

1. Levelling the dryer prevents undesirable noise and vibration. Place your dryer on a solid, level floor.

Place the dryer in an area free from flammable materials, condensation and not liable to freezing.

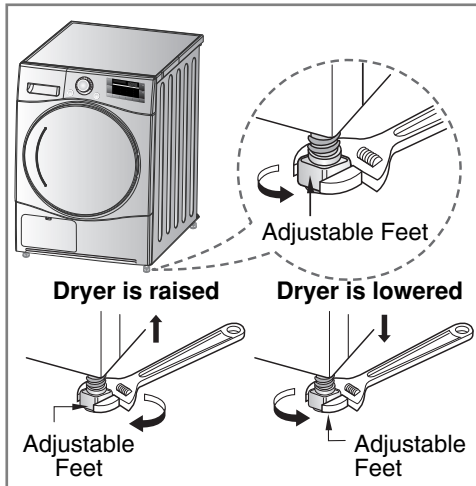

2. If the dryer is not properly level, adjust the front levelling legs as necessary. Turn them clockwise to raise and counter-clockwise to lower until the dryer no longer wobbles, both front-to-back, side-to-side and corner-to-corner.



* *Diagonal Check*

When pushing down the edges of the machine, the machine should not move up and down at all.

(Please check both directions)

If the machine rocks when pushing the machine top plate diagonally, adjust the feet again.

Appearance & Design

■ Product Layout

- RC7066***

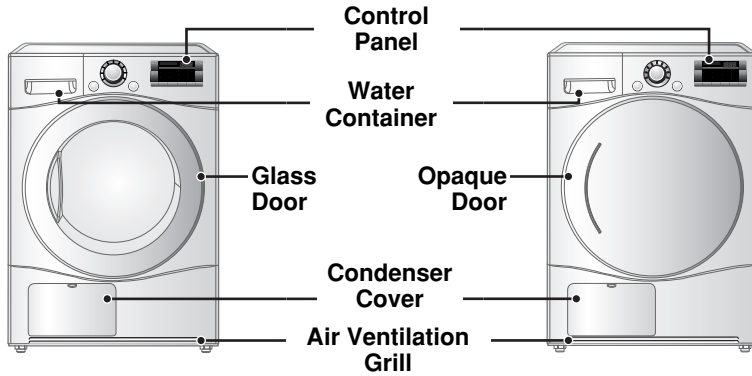

■ Control Panel

SmartDiagnosis™ function is available only for the products with a SmartDiagnosis™ mark.

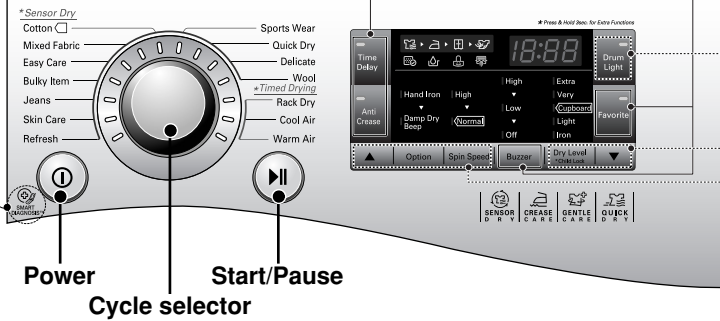

Options

- Time Delay
- Anti Crease
- Favorite
- Buzzer

Additional programme

- ▲
- Option
- Spin Speed
- Dry Level (*Child Lock)
- Drum Light
- ▼

Operating Your Dryer

■ Cycle Selection Table

Sensor Dry Cycle			
Cycle	Laundry Type	Detail	Drying Level
Cotton	Towels, dressing gowns and bed linen	For thick and quilted fabrics	Extra
	Terry towels, tea towels, towels and bed linen	For thick and quilted fabrics that do not need to be ironed	Very
	Bath towels, tea towels, underwear and cotton socks	For fabrics that do not need to be ironed	Cupboard
	Sheets, pillowcase and towels	For fabrics that do not need to be ironed	Light
	Bed linen, table linen, towels, T-shirts and polo shirts	For fabrics that do need to be ironed	Iron
Mixed Fabric	Bed linen, table linen, tracksuits, anorak and blankets	For thick and quilted fabrics that do not need to be ironed	Very
	Shirts and blouses	For fabrics that do not need to be ironed	Cupboard
	Trousers, dresses, skirts and blouses	For fabrics that do need to be ironed	Iron
Easy care	Shirts, T-shirts, trousers, under wear and socks	For polyamide, acrylic, and polyester that do not need to be ironed	Cupboard
	Shirts, T-shirts, under wear, anoraks and socks	For polyamide, acrylic, polyester that do need to be ironed	Iron

Operating Your Dryer

Sensor Dry Cycle			
Cycle	Laundry Type	Detail	Drying Level
Bulky Item	Bed clothes, sheets	For bulky items	-
Quick Dry	Linen and towels, excluding fabrics applied to Delicate, Sports wear, Wool and Bulky Item course.	For small loads of suitable fabrics with short drying times	-
Skin Care	T-shirts, pillowcase and towels	For cotton fabrics which do not need to be ironed	-
Refresh (Refer to the Note)	Shirts and blouses	Odor removal of fabric (For fabrics in need of odor removal)	-
Sports Wear	Soccer kit and training wear	For polyester material	-
Jeans	Jeans and Colour fading	For jeans which do not need to be ironed	-
Delicate	Silk, fine fabrics and lingerie	For fabrics that are heat-sensitive like synthetic.	-
Wool	Wool	For wool fabrics	-
Timed Drying Cycle			
Rack Dry	Silk, wool, delicate lingerie	Refresh clothes without tumble drying	-
Cool Air	All fabrics that need refreshing	Tumbles without heat	-
Warm Air	Bath towels, bath robes, dishcloths and quilted fabrics made of acrylic	Small items & damp clothing Everyday items suitable for heat drying	-

▲ NOTE

When using the “Refresh” course, please spray cold or warm water on the fabric for a fresher outcome. (The recommend amount is 20cc of water per shirt.)

▲ CAUTION

If the load is less than 1kg, please use “Warm Air” Cycle in timed drying Cycle. Wool items should be dried using “Wool” Cycle and heat-sensitive fabrics including silk, underwear and lingerie should be dried using “Delicates” Cycle. Please comply with the recommended laundry load when you select your desired cycle - found on page 22,23. Otherwise, your clothes may be damaged.

Operating Your Dryer

■ Please read before using your LG dryer for the first time

- ※ After removing the packaging, please carry out the following checks to ensure the LG dryer is correctly installed and ready for use. (See installation instructions.)
- 1. Check the dryer is well balanced by using a spirit level. If not, adjust the feet of the LG dryer until the machine is balanced.
- 2. Check the water container, filter, control panel and drum to make sure everything is in place.
- 3. Set the machine to dry for 5 minutes to warm up the drum.
- 4. Open the door between loads the first few times you use the machine to allow any odours from the interior of the LG dryer to disperse.

▲ NOTE

The final part of a tumble dryer cycle occurs without heat (cool down cycle) so that the items are left at a temperature to ensure that the items will not be damaged.

1. Turn the power on.

First, press the “Power” button. The indicator light above the button will become illuminated indicating that the machine is all set to run.

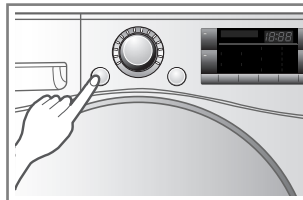

Turn the power on.

2. Open the door.

3. Check the filter and water container are clean.

The filter is inside the door rim or in the back of the door. It needs to be cleaned before and after drying. Open the door and check the filter is clean. If not, please clean it referring to page 19. Also check if the water container need to be emptied for better drying results.

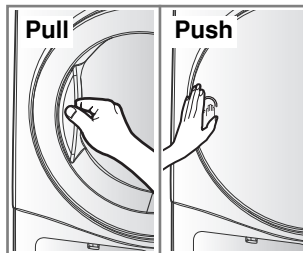

Open the Door.

4. Place laundry into the drum after sorting.

The clothes should be sorted by fabric type and dryness level and all the strings and belts of clothes should be well tied and fixed before being put into the drum. Push the laundry to the back to keep it away from the door seal. If not, the door seal and clothes may be damaged.

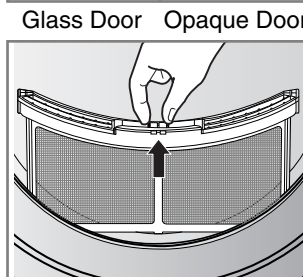

Check the filter.

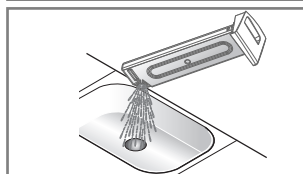

Operating Your Dryer

5. Close the door.

Before you close the door, make sure fabrics are well placed inside and that foreign objects, especially flammable ones, are not caught around door.

⚠ CAUTION

Be careful not to trap laundry between the loading door and rubber seal.

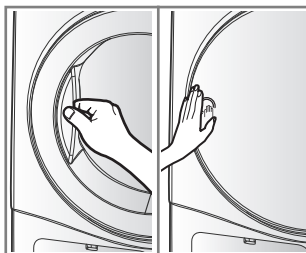

Glass Door Opaque Door

6. Select the drying cycle you want.

You can choose a cycle by turning the cycle selector knob until the required cycle is indicated.

If you press Start/Pause button without choosing a cycle, the dryer will proceed with the Cupboard cycle. Please refer to Cycle Selection table (page 11,12) for detailed information.

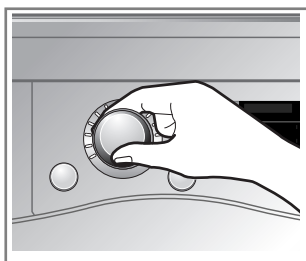

Select the desired cycle.

7. Press the start button.

You will hear the drum rotating.

8. After the cycle has finished, open the door and remove the laundry.

⚠ CAUTION

Be careful! The drum inside could still be hot.

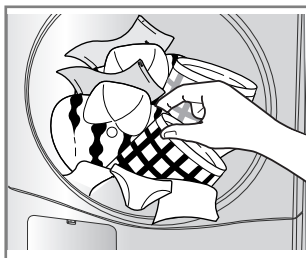

Take out the laundry.

(Operation time varies depending on your cycle selection or options.)

Operating Your Dryer

⚠ NOTE

The final part of a tumble dryer cycle occurs without heat (cool down cycle) to ensure that the items are left at a temperature that will not damage them.

9. Clean the filter and empty the water container.

The filter should be cleaned after each load.

10. Turn off the dryer.

Press the “Power” button.

⚠ CAUTION

- Take care if using a vacuum cleaner to clean the filter, as it is easily damaged and torn. If there is a residue build up on the filter, scrub the filter with a brush to remove.
- If you want to open the door while the dryer is operating, please press the Start/Pause button first, wait until the drum completely stops and then open the door.

⚠ CAUTION

This dryer must not be used for purposes other than those for which it was designed.

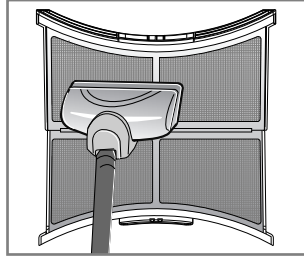

Clean the filter.
(Replace the filter if it is damaged.)

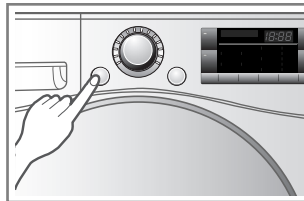
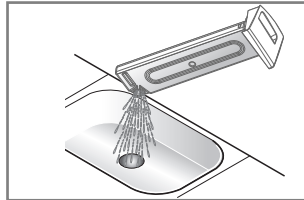

Operating Your Dryer

■ Rack Dry (depending on the model)

The drying rack is placed inside the dryer as seen in the picture below. Remove and discard packing material before use. The Rack Dry is designed for use with items that you do not want to tumble dry including sweaters and delicate fabrics.

To use the Drying Rack :

1. Open the door.
2. Do not remove the filter.
3. Place drying rack over the bottom of the dryer door opening.
Reset the rack on the dryer back lodge.
Push down on the frame front to secure over filter.
4. Place wet items on top of the rack.
Allow space around items for air to circulate.
The rack does not move, but the drum will rotate.
5. Close the door.
6. Turn power on and select Rack Dry.

▲ NOTE

Check the lint filter and remove any lint accumulated from items dried on the rack.

1. Insert wire edge to the drum centre.

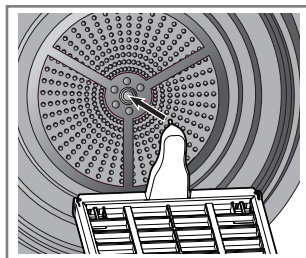

2. Place delicate fabrics or sportshoes.

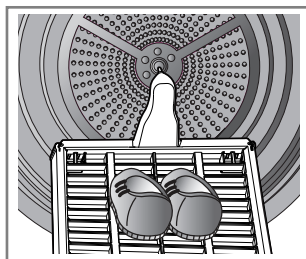

Additional Functions

- RC7066****

Option buttons

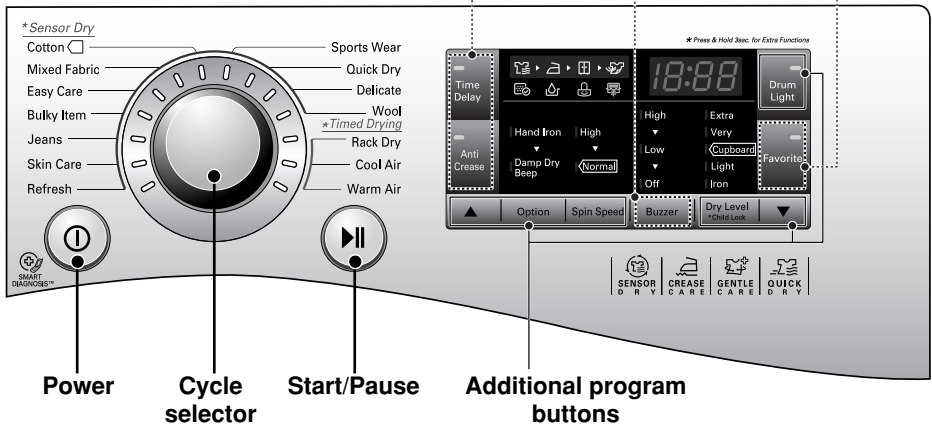

Power

- Press the Power button to turn power on and off.
- To cancel the Time Delay function, the power button should be pressed.

Additional program

- Use these buttons to select the desired options for the selected cycle.

Cycle selector

- Cycles are available according to the laundry type.
- The lamp will light up to indicate selected cycle.

Options

- This allows you to select additional options and will light up when selected.

Start/Pause

- This Start/Pause button is used to start the dry cycle or pause the dry cycle.
- Press the Start/Pause button to stop the cycle temporarily.
- When in Pause, the power is turned off automatically after 4 minutes.

Additional Functions

■ Time Delay

You can use the Time Delay option to delay the finishing time of drying cycle.

Maximum Time Delay is 19 hours.

Minimum Time Delay is 3 hours.

1. Turn the dryer on.
2. Select a cycle.
3. Set time delay hour by pressing the “▲”, “▼” button.
4. Press Start/Pause button.

■ Anti Crease

The Anti Crease option prevents creases that are formed when the laundry is not unloaded promptly at the end of the drying cycle. When Anti Crease is selected, the dryer repeatedly runs and pauses, giving you 2 hours to unload the laundry. If the door is opened during the Anti Crease option, the option is cancelled.

■ Favorite

Favorite option allows you to store a customised dry cycle for future use.

1. Turn the dryer on.
2. Select a cycle.
3. Select the option or additional program. (Anti-Crease, Spin Speed etc.)
4. Press and hold Favorite option button for 3 seconds.

The Favorite option is now stored for future use. To reuse the stored cycle, select Favorite option and press the Start/Pause.

■ Drum Light

Whilst the dryer is running it is possible to see inside the drum if you select the Drum Light function.

- Light on : Door is opened.
- Light off : Door is closed. Off automatically.

■ Spin speed

This additional program is able to control drying time, allowing you to select high or normal. (Default option is normal.)

- High : When washing dehydration proceeds from more than 1,200 rpm.
 - Normal : When washing dehydration proceeds from less than 1,000 rpm.
- ※ Spin RPM is based on the LG Washing Machine.

■ Option

Hand Iron

This function remains more moist than the condition for ironing.

▲ NOTE

Cycle	Dry Level	Option
Cotton	Iron	Hand Iron is available
Mixed Fabric		
Easy Care		

Damp Dry Beep

This function lets you know when the clothes are ready for ironing.

▲ NOTE

Cycle	Dry Level	Option
Cotton	Extra / Very Cupboard / Light	Damp Dry Beep is available
Mixed Fabric	Very / Cupboard	
Easy Care	Cupboard	

■ Child Lock (& [L])

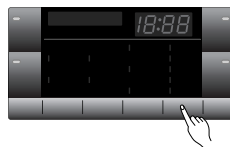

For the safety of children, press Dry Level button for about 3 seconds.

You will see “  ” indication on the LED.

You can see “ [L] ” sign on LED window.

- All controls except Child Lock and Power buttons will be disabled.
- Child Lock continues after the end of cycle.

▲ NOTE

To turn the Child Lock off, press Dry Level button for about 3 seconds.

■ Buzzer

This is an option to enable you to adjust volume of beeper sound.

Caring for Your Dryer

Care and Cleaning is Very Important

It's not difficult to care for your dryer but it is important that you do care for it. Follow the instructions below.

Clean Filter

Clean the filter after each use and check it before each use. It should also be cleaned if the "Clean Filter" light becomes illuminated and the buzzer sounds whilst the dryer is in operation.

Cleaning or emptying the filter will reduce drying times and energy consumption and lengthen the dryer life.

1. Open the door.

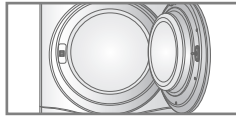

2. Pull the filter out.

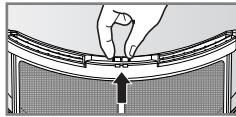

3. Clean the filter by using a vacuum cleaner or rinsing under the tap.

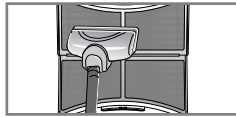

4. Replace the filter.
- Push the filter all the way down to avoid interference with the door.

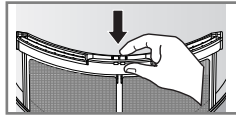

5. Close the door.

CAUTION

- After washing the filter please dry thoroughly.
- Lint must not be left to accumulate in the dryer.

NOTE



If "Clean Filter" symbol is displayed during the operation, clean the filter promptly.

1. Cool the dryer down and follow the above steps.
2. Press the Start/Pause button.

Empty Water Container

Condensed water is collected in the water container.

Empty the water container after every use.

Not doing so will affect the drying performance.

If the water container is full, the "Empty Water" lamp glows and the buzzer sounds while the dryer is operating. If this should occur, the water container needs to be emptied within the next hour.

1. Pull out the water container.

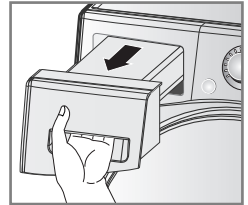

2. Empty water container in the sink.

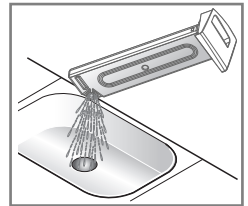

3. Push it back.

4. Press the Start/Pause button.

NOTE

A high atmospheric temperature and a small room may both increase drying time as well as energy consumption.

WARNING

Do not drink the condensed water.

CAUTION

If the laundry is not spun at a high speed during washing, energy consumption and drying time will increase. In some instances, LED window may display " " (Empty water symbol) and the may stop because the water container is full.

Caring for Your Dryer

Condenser

The condenser is also a very important part for efficient drying performance result so it needs special care from you. It is recommended that the condenser be cleaned three or four times a year or when the condenser clean lamp blinks.

1. Push the cap and open the condensing cover

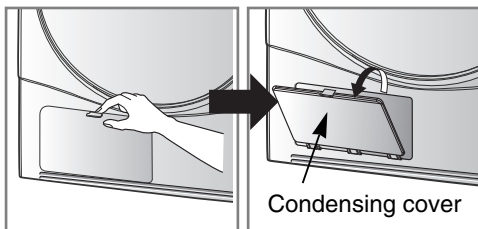

2. Open seal by turning the locking lever

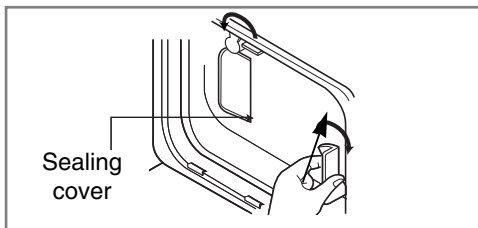

3. Pull the condenser out by inserting a finger into the tab at the front of the condenser. (Don't force the condenser)

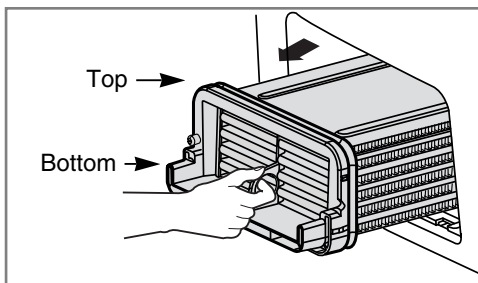

4. Clean the condenser thoroughly under a tap, letting the water flow through

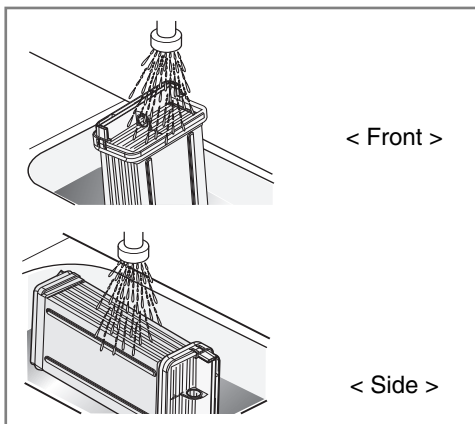

5. Put everything back together by following the instructions in reverse order

CAUTION

The locking lever must be closed after cleaning the condenser as below.

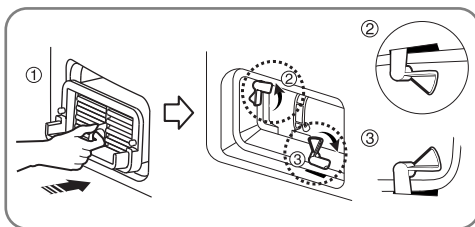

CAUTION

- Operating when the condenser is clogged with lint can damage the dryer. This also increases energy consumption.
- Do not use sharp objects to clean the heat exchanger. This could cause damage and leaking.
- Never operate the dryer without the heat exchanger.

NOTE



If the "Clean Condenser" symbol is displayed, clean the condenser promptly.

Caring for Your Dryer

■ Ventilation Grill and Cool Air Inlet Grill

Vacuum the front ventilation grill 3-4 times a year to make sure there is no build up of lint or dirt that could cause improper air flow.

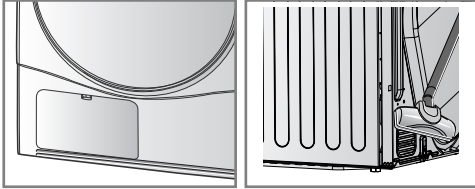

▲ NOTE

- Warm air is exhausted through the ventilation grill.
- Adequate ventilation has to be provided to avoid the back flow of gases into the room from appliances burning other fuels, including open fires.

■ Condensed Water Drain-out

Normally, condensed water is pumped up to the water container where water is collected until manually emptied.

Water can also be drained out directly to a mains drain, especially when the dryer is stacked on top of a washing machine. With a connecting kit for a mains drain hose, simply change the water path and reroute to the drainage facility as below:

1. Take connecting kit out.

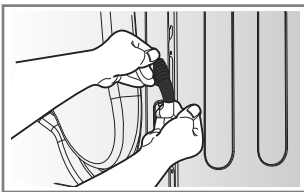

2. Separate water container hose from the kit.

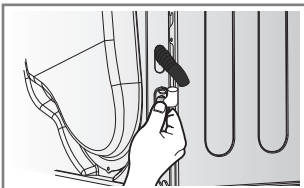

3. Connect drain hose to the kit.

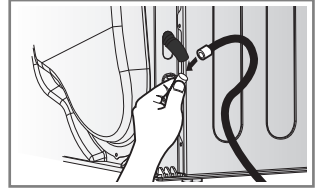

■ Moisture Sensor?

The device senses the moisture level of the laundry during operation, which means it must be cleaned regularly to remove any build up of lime scale on the surface of the sensor. Wipe the sensors inside drum (as illustrated)

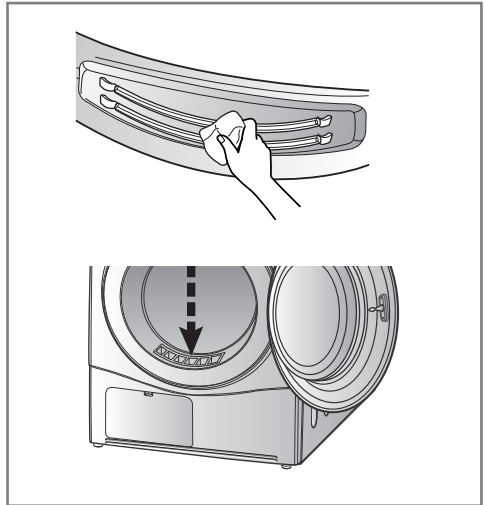

Additional Tips for Smart Use

■ Drying Guide & Energy consumption

CYCLE		Capacity of dryer	Display Drying Time (Including Cooling Time)	
			Normal	High
Cotton	Extra	7 kg	125 min	115 min
	Very	7 kg	120 min	110 min
	Cupboard	7 kg	115 min	105 min
	Light	7 kg	103 min	93 min
	Iron	7 kg	97 min	87 min
Mixed Fabric	Very	3.5 kg	53 min	43 min
	Cupboard	3.5 kg	48 min	38 min
	Iron	3.5 kg	41 min	31 min
Easy Care	Cupboard	3.5 kg	58 min	38 min
	Iron	3.5 kg	51 min	31 min
Bulky Item		2 kg	60 min	-
Jeans		3 kg	36 min	-
Skin Care		4.5 kg	118 min	-
Refresh		1.5 kg	20 min	-
Sports Wear		2 kg	24 min	-
Quick Dry		3 kg	50 min	-
Delicate		1.5 kg	45 min	-
Wool		1 kg	21 min	-

Additional Tips for Smart Use

Woollens

Dry woollens on “wool” cycle. Be sure to follow fabric care label symbols, first. Wool is not completely dried from the program so don't repeat drying. Pull woollens to their original shape and dry them flat.

Woven and Loopknit Materials

Some woven and loopknit materials may shrink, depending on quality.

Permanent Press and Synthetics

Do not overload your dryer. Take out permanent press items as soon as the dryer stops to reduce creases.

Baby Clothes and Night Gowns

Always check the manufacturer's instructions.

Rubber and Plastics

Do not dry any items made from or containing rubber or plastics such as:

- a) Aprons, Bibs and Chair Covers
- b) Curtains and Table Cloths
- c) Bathmats

Fibreglass

Do not dry fibreglass articles in your dryer. Glass particles left in the dryer could be picked up by your clothes the next time you use the dryer and irritate your skin.















Fabric Care Labels

Clothes have their own wash care labels, so drying according to the wash care label is recommended.

Not only that, the laundry must be sorted according to size and fabric type.

For the best drying performance and most efficient energy usage, do not overload the dryer.

Below are fabric care labels.

Symbols	Instructions
	Dry
	Tumble dry
	Permanent Press / Wrinkle resistant
	Gentle / Delicate
	Do not tumble dry
	Do not dry
	High heating
	Medium heating
	Low heating
	No heat / air
	Line Dry / hang to dry
	Drip dry
	Dry flat
	In the shade

Additional Tips for Smart Use

■ Product Specification

LG AUTOMATIC CLOTHES DRYER		
Manufacturer		LG Electronics
Model		RC7066***
Rated Capacity	kg	7kg
Dryer Type		Condenser Household Tumble Dryer
Energy Efficiency Class		B
Annual Energy Consumption (AEc)	kWh/yr	504
Automatic Tumble Dryer		Yes
EU Ecolabel Award		No
Edry	kWh	4.24
Edry1/2	kWh	2.31
Power Consumption at Full Load		
- Off-mode (Po)	W	0.4
- Left-on mode (Pl)	W	0.4
Duration of Left-on mode	min	10
Standard Cotton Program		Cotton Cupboard Normal
Drying Time (Tt)	min	91
- Tdry	min	119
- Tdry1/2	min	71
Condensation Efficiency Class		A
Ct	%	91
- Cdry	%	91
- Cdry1/2	%	91
Sound Power Level	dB	66

Additional Tips for Smart Use

Program/ Dry Level	Spin Speed	Load Content	Capacity	Estimated Performance			
				Energy Efficiency (kWh)	Drying Time (min)	Left-on mode (PI)(W)	Off mode (Po) (W)
Cotton / Cupboard	Normal	Cotton 100%	7kg	4.24	119	0.4	0.4
		Cotton 100%	3.5kg	2.31	71		

▲ NOTE

- Tested in accordance with EN61121 and Directive 932/2012
- Set program at "Cotton Cupboard Normal (Full & Half Load)" for test in accordance in conformity with EN61121 and Directive 932/2012
 - Standard Cotton program : Cotton + Cupboard + Normal (Default)
(This is the most efficient programme in terms of the test conditions proposed by EN61121 and Directive 932/2012)
- Information about the 'standard cotton programme' specifies that it is suitable to dry normal wet cotton laundry and that it is the most efficient programme in terms of energy consumption for drying wet cotton laundry.
- The test results depend on room temperature, type and amount of load, water hardness and water inlet temperature.
- If product is installed as built under, it may cause performance degradation.

Additional Tips for Smart Use

■ Spare Parts

Spare parts that are required under the terms of warranty are provided free of charge. If the warranty has expired then spare parts must be purchased from the service centre.

■ Disposal of the Dryer

It is requested that you dispose of your dryer safely to protect children and others from possible injury.

The door, lid and other protruding parts must be removed and the power cord should be cut off before safe disposal.

■ Service Contact

If there is a problem with your dryer, first consult the Trouble Shooting Guide. If you cannot find the error and you are unable to resolve the problem, please contact the Service centre.

A Customer Service representative will ask you the following questions:

1. Name, address and postcode
2. Phone number
3. Description of problem
4. Model number and serial number of your dryer
5. Date of Purchase

■ Accessory Parts

- Accessories available for this product (depending on the model)

1. Condensing Drain Hose and Hose Holder (Purchased Separately)

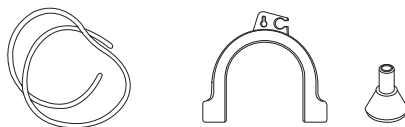

2. Dryer Rack (Purchased Separately)

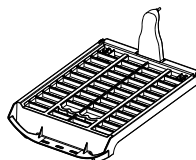

3. Stacking Kit (Purchased Separately)

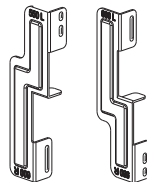

Holder : 2EA, Screw : 4EA

- The stacking kit can be used for washer top plate size 550mm and 600mm for both.

**If stacking is needed, you must stack the dryer upon an LG washing machine.
A stacking kit is sold separately.**

Troubleshooting Guidelines

■ Troubleshooting Tips

To save you time and money, the following page will help answer your questions before a service call.

Issue	What to do
Dryer won't run	<ol style="list-style-type: none"> 1. Check dryer is plugged in. 2. Check "Start" button is pressed. 3. Check door is properly closed. 4. Check room temperature is not below 5°C 5. Check a fuse is not blown or the circuit breaker is tripped and replace them. (Caution : electric dryers generally use two fuses or breakers) After emptying the water container and Cleaning filter during operation, you must press the start button, then the dryer operates again.
It takes a long time to dry	<ol style="list-style-type: none"> 1. Filter should be cleaned after each load. 2. Check water container is emptied. 3. Check cleanliness of condenser. 4. Select correct programme setting for fabric type 5. Check air ventilation grill or rear vents of dryer are not obstructed 6. Check clothes are not excessively wet 7. Check the dryer is not overloaded
	<ol style="list-style-type: none"> 1. Check filter is clean 2. Check condenser unit is not clogged.
Clothes are covered in Fluff	<ol style="list-style-type: none"> 1. Check lint filter is empty 2. Check all the items in the dryer are clean 3. Check all the laundry has been correctly sorted by fabric type 4. Check laundry is not overloaded 5. Check if there is any paper, tissues or other degradable items amongst the laundry and remove.
The drying time is not consistent	<p>The drying time for a load will vary depending on the heat setting, the size of the load, the type of fabrics, the wetness of the clothes and the condition of the lint filter.</p>
Water is leaking	<p>Check if the door or seal cover is dirty or damaged.</p>
The clothes are creased	<p>Check the laundry is not overloaded. Try a shorter drying time and remove items whilst they still retain a slight amount of moisture. Use the anti-crease function</p>
The garments have shrunk	<p>To avoid shrinkage, please follow the care and use instructions for your garment, as some fabrics shrink naturally when washed and other fabrics should not be placed in a dryer.</p>

Troubleshooting Guidelines

■ Error Mode

- **dE** : The door must be closed and the Start/Pause button must be pressed for re-operation. If error message continues to occur, unplug the power cord and call the service centre for advice.

• **LE 1,LE3**

: If error message continues to occur, unplug the power cord and call the service centre for advice.

■ Drum light does not work

- Contact the customer service centre.

Using SmartDiagnosis™

▲ NOTE

SmartDiagnosis™ function is available only for the products with a SmartDiagnosis™ mark. In case of a mobile phone with static option, the smart diagnosis function might not operate.

■ Using SmartDiagnosis™

- Only use this feature when instructed to do so by the call centre. The transmission sounds similar to a fax machine, and so has no meaning except to the call centre.
 - SmartDiagnosis™ cannot be activated if the dryer does not power up. If this happens, then troubleshooting must be done without SmartDiagnosis™. If you experience problems with your dryer, call the Customer information centre. Follow the call centre agent's instructions, and do the following steps when requested:
1. Press the Power button to turn on the dryer. Do not press any other buttons or turn the cycle selector knob.

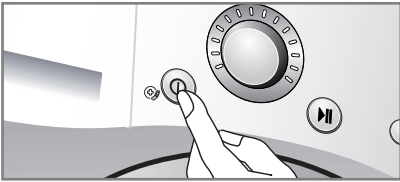

2. When instructed to do so by the call centre, place the mouthpiece of your phone very close to the Power button.

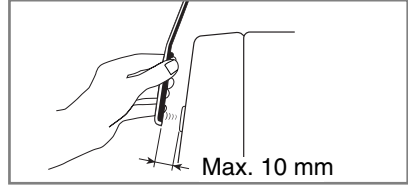
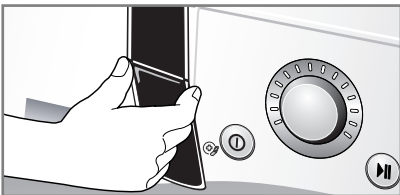

3. Press and hold the "More Time" button for three seconds, while holding the phone mouthpiece to the icon or Power button.
4. Keep the phone in place until the tone transmission has finished. The display will count down the time.
 - For best results, do not move the phone while the tones are being transmitted.
 - If the call centre agent is not able to get an accurate recording of the data, you may be asked to try again.
5. Once the countdown is over and the tones have stopped, resume your conversation with the call centre agent, who will then be able to assist you using the information transmitted for analysis during your call to the Customer information centre.

▲ NOTE

"Smart Diagnosis is a troubleshooting feature designed to assist, not replace, the traditional method of troubleshooting through service calls. The effectiveness of this feature depends upon various factors, including, but not limited to, the reception of the cellular phone being used for transmission, any external noise that may be present during the transmission, and the acoustics of the room where the machine is located. Accordingly, LG does not guarantee that Smart Diagnosis would accurately troubleshoot any given issue."

Technical Data

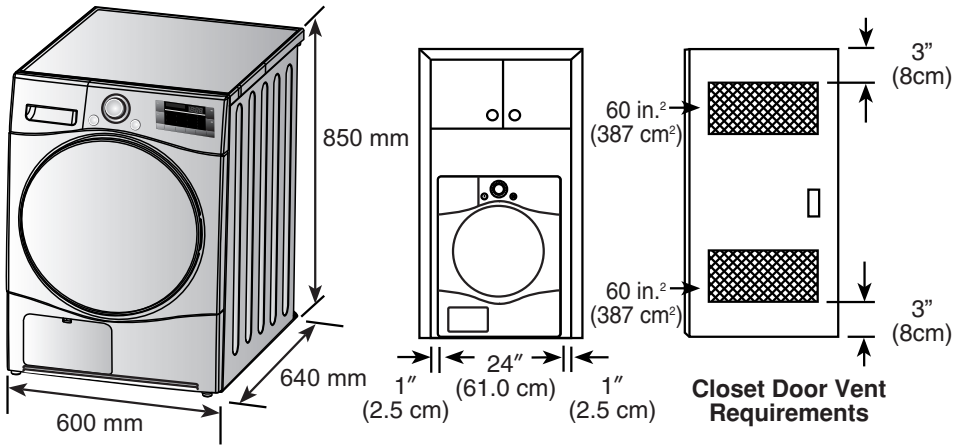

Weight : 43.7kg, Opaque Door
 45.1kg, Glass(Cr) Door

■ Electrical Requirements

Volts	Hertz	Watts
230 V	50 Hz	2450

Ensure you connect the dryer to the correct electricity voltage. The ratings plate on your dryer shows you what the voltage should be.

■ Ventilation Requirement

Alcove or undercounter	Closet
<p>Ensure air flow of 112 cu.ft./min through dryer</p>	<p>Closet door must have 2(louvered) openings, each having a minimum area of 60 sq. inches (387 sq.cm), located 3 inches (8 cm) from bottom and top of door.</p>

Warranty

Disposal of your old appliance

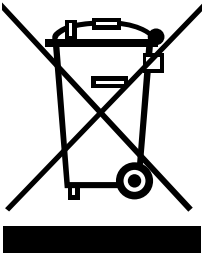

1. All electrical and electronic products should be disposed of separately from the municipal waste stream via designated collection facilities appointed by the government or the local authorities.
2. The correct disposal of your old appliance will help prevent potential negative consequences for the environment and human health.
3. For more detailed information about disposal of your old appliance, please contact your city office, waste disposal service or the shop where you purchased the product.

▲ NOTE

- **When disposing of the appliance, cut off the mains cable, destroy the plug and disassemble the door to prevent anything from being trapped inside.**

■ What is not covered

- Service trips to your home to teach you how to use the product.
- If the product is connected to any voltage other than that shown on the rating plate.
- If the fault is caused by accident, neglect, misuse or Act of God.
- If the fault is caused by factors other than normal domestic use or use in accordance with the owner's manual.
- Provide instruction on use of product or change the set-up of the product.
- If the fault is caused by pests for example, rats or cockroaches, etc.
- Noise or vibration that is considered normal, for example water drain sound, spin sound, or warning beeps.
- Correcting the installation. For example, levelling the product, adjustment of drain.
- Normal maintenance which is recommended by the owner's manual.
- Removal of foreign objects / substances from the machine, including the pump and inlet hose filter, For example, grit, nails, bra wires, buttons etc.
- Replace fuses in or correct house wiring or correct house plumbing.
- Correction of unauthorised repairs.
- Incidental or consequential damage to personal property caused by possible defects with this appliance.
- If this product is used for commercial purpose, it is not under warranty.
(Example : Public places such as public bathroom, lodging house, training centre, dormitory)

If the product is installed outside the normal service area, any cost of transportation involved in the repair of the product, or the replacement of a defective part, shall be borne by the owner.



For U.K. Customer
CUSTOMER SERVICE Tel : +44- (0) 844 847 5454
Fax. : +44- (0) 844 847 1413
LGEUK SERVICE WEB-SITE : http://uk.lge.com