

ViewSonic®



CDE3203

Full HD Professional LED Display

User Guide

IMPORTANT: Please read this User Guide to obtain important information on installing and using your product in a safe manner, as well as registering your product for future service. Warranty information contained in this User Guide will describe your limited coverage from ViewSonic Corporation, which is also found on our web site at <http://www.viewsonic.com> in English, or in specific languages using the Regional selection box in the upper right corner of our website. "Antes de operar su equipo lea cuidadosamente las instrucciones en este manual"

Model No. VS16450

Thank you for choosing ViewSonic

With over 25 years as a world leading provider of visual solutions, ViewSonic is dedicated to exceeding the world's expectations for technological evolution, innovation, and simplicity. At ViewSonic, we believe that our products have the potential to make a positive impact in the world, and we are confident that the ViewSonic product you have chosen will serve you well.

Once again, thank you for choosing ViewSonic !



Contents

Compliance Information

FCC Compliance Statement	i
Industry Canada Statement	i
CE Conformity for European Countries.....	ii
Declaration of RoHS2 Compliance	iii

Copyright Information

Product Registration.....	iv
For Your Records.....	iv
Important Safety Instructions	v

Getting Started

Package Contents.....	1
Installing the Display	2
Installing the Stand	2
Disconnecting the Stand	2
Mounting ViewSonic display to the wall	3
Wall Mount Kit Specifications (VESA).....	4
Front View & Key Pad of the Product.....	5
Rear & Side View of the Product.....	6
Connecting the Display	7
HD Cable Box/HD Satellite Box	7
Personal Computer	9

Using the Display Features

Remote Control and Display Controls.....	11
Inserting Remote Control Batteries	11
Remote Control and Display Controls.....	11
Operation	13

Other Information

Troubleshooting	25
Specifications	27
RS232 Protocol.....	28
1. Introduction	28
2. Description	28
3. Protocol.....	29
Customer Support.....	41

Compliance Information

NOTE: This section addresses all connected requirements and statements regarding regulations. Confirmed corresponding applications shall refer to nameplate labels and relevant markings on unit.

FCC Compliance Statement

This device complies with part 15 of FCC Rules. Operation is subject to the following two conditions: (1) this device may not cause harmful interference, and (2) this device must accept any interference received, including interference that may cause undesired operation.

This equipment has been tested and found to comply with the limits for a Class B digital device, pursuant to part 15 of the FCC Rules. These limits are designed to provide reasonable protection against harmful interference in a residential installation. This equipment generates, uses, and can radiate radio frequency energy, and if not installed and used in accordance with the instructions, may cause harmful interference to radio communications. However, there is no guarantee that interference will not occur in a particular installation. If this equipment does cause harmful interference to radio or television reception, which can be determined by turning the equipment off and on, the user is encouraged to try to correct the interference by one or more of the following measures:

- Reorient or relocate the receiving antenna.
- Increase the separation between the equipment and receiver.
- Connect the equipment into an outlet on a circuit different from that to which the receiver is connected.
- Consult the dealer or an experienced radio/TV technician for help.

Warning: You are cautioned that changes or modifications not expressly approved by the party responsible for compliance could void your authority to operate the equipment.

Industry Canada Statement

CAN ICES-3 (B)/NMB-3(B)

CE Conformity for European Countries



The device complies with the EMC Directive 2004/108/EC and Low Voltage Directive 2006/95/EC.

Following information is only for EU-member states:

The mark shown to the right is in compliance with the Waste Electrical and Electronic Equipment Directive 2012/19/EU (WEEE). The mark indicates the requirement NOT to dispose the equipment as unsorted municipal waste, but use the return and collection systems according to local law.

If the batteries, accumulators and button cells included with this equipment, display the chemical symbol Hg, Cd, or Pb, then it means that the battery has a heavy metal content of more than 0.0005% Mercury or more than, 0.002% Cadmium, or more than 0.004% Lead.

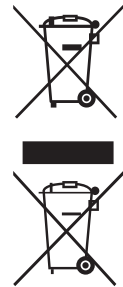

ENERGY STAR Information:

- ENERGY STAR is a set of power-saving guidelines issued by the U.S. Environmental Protection Agency (EPA).

ENERGY STAR is a joint program of the U.S. Environmental Protection Agency and the U.S. Department of Energy helping us all save money and protect the environment through energy efficient products and practices.

The power consumption will be changed, if the TV set up to be another mode except for default as-shipped television configuration and settings.

The power consumption may exceed energy consumption beyond the limits required for ENERGY STAR qualification when the optional function used or the operation mode changed in use.

Declaration of RoHS2 Compliance

This product has been designed and manufactured in compliance with Directive 2011/65/EU of the European Parliament and the Council on restriction of the use of certain hazardous substances in electrical and electronic equipment (RoHS2 Directive) and is deemed to comply with the maximum concentration values issued by the European Technical Adaptation Committee (TAC) as shown below:

Substance	Proposed Maximum Concentration	Actual Concentration
Lead (Pb)	0.1%	< 0.1%
Mercury (Hg)	0.1%	< 0.1%
Cadmium (Cd)	0.01%	< 0.01%
Hexavalent Chromium (Cr ⁶⁺)	0.1%	< 0.1%
Polybrominated biphenyls (PBB)	0.1%	< 0.1%
Polybrominated diphenyl ethers (PBDE)	0.1%	< 0.1%
Bis (2-ethylhexyl) phthalate (DEHP)	0.1%	< 0.1%
Butyl benzyl phthalate (BBP)	0.1%	< 0.1%
Dibutyl phthalate (DBP)	0.1%	< 0.1%
Diisobutyl phthalate (DIBP)	0.1%	< 0.1%

Certain components of products as stated above are exempted under the Annex III of the RoHS2 Directives as noted below:

Examples of exempted components are:

1. Mercury in cold cathode fluorescent lamps and external electrode fluorescent lamps (CCFL and EEFL) for special purposes not exceeding (per lamp):
 - (1) Short length (≤ 500 mm): maximum 3.5 mg per lamp.
 - (2) Medium length (> 500 mm and $\leq 1,500$ mm): maximum 5 mg per lamp.
 - (3) Long length ($> 1,500$ mm): maximum 13 mg per lamp.
2. Lead in glass of cathode ray tubes.
3. Lead in glass of fluorescent tubes not exceeding 0.2% by weight.
4. Lead as an alloying element in aluminium containing up to 0.4% lead by weight.
5. Copper alloy containing up to 4% lead by weight.
6. Lead in high melting temperature type solders (i.e. lead-based alloys containing 85% by weight or more lead).
7. Electrical and electronic components containing lead in a glass or ceramic other than dielectric ceramic in capacitors, e.g. piezoelectronic devices, or in a glass or ceramic matrix compound.

Copyright Information

Copyright © ViewSonic® Corporation, 2016. All rights reserved.

ViewSonic, the three birds logo, OnView, ViewMatch, and ViewMeter are registered trademarks of ViewSonic Corporation.

Disclaimer: ViewSonic Corporation shall not be liable for technical or editorial errors or omissions contained herein; nor for incidental or consequential damages resulting from furnishing this material, or the performance or use of this product.

In the interest of continuing product improvement, ViewSonic Corporation reserves the right to change product specifications without notice. Information in this document may change without notice.

No part of this document may be copied, reproduced, or transmitted by any means, for any purpose without prior written permission from ViewSonic Corporation.

Product Registration

To fulfill possible future product needs, and to receive additional product information as it becomes available, please visit your region section on ViewSonic's website to register your product online.

For Your Records

Product Name:	CDE3203
Brand/Product type:	ViewSonic/LCD Display
Model Number:	VS16450
Document Number:	CDE3203_UG_ENG Rev. 1A 12-22-15
Serial Number:	_____
Purchase Date:	_____

Product disposal at end of product life

ViewSonic respects the environment and is committed to working and living green. Thank you for being part of Smarter, Greener Computing.

Please visit ViewSonic website to learn more.

USA & Canada: <http://www.viewsonic.com/company/green/recycle-program/>

Europe: <http://www.viewsoniceurope.com/uk/support/recycling-information/>

Taiwan: <http://recycle.epa.gov.tw/recycle/index2.aspx>

Important Safety Instructions

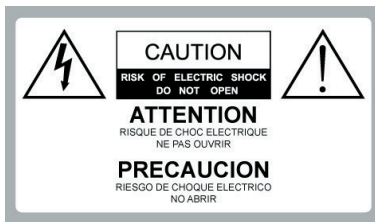

Dangerous Voltage: The lightning flash with arrowhead symbol, within an equilateral triangle, is intended to alert the user to the presence of dangerous voltage within the inside of the product that may be sufficient level to constitute a risk of electric shock to persons.



Instruction: The exclamation point within an equilateral triangle is intended to alert the user to the presence of important operating and servicing instructions in the literature accompanying the appliance.

1. Read these instructions completely before using the equipment.
2. Keep these instructions in a safe place.
3. Heed all warnings.
4. Follow all instructions.
5. Do not use this apparatus near water.
6. Clean with a soft, dry cloth.
7. Do not block any ventilation openings. Install the equipment in accordance with the manufacturer's instructions.
8. Do not install near any heat sources such as radiators, heat registers, stoves, or other devices (including amplifiers) that produce heat.
9. Do not attempt to circumvent the safety provisions of the polarized or grounding-type plug. A polarized plug has two blades with one wider than the other. A grounding type plug has two blades and a third grounding prong. The wide blade and the third prong are provided for your safety. If the provided plug does not fit into your outlet, consult an electrician for replacement of the outlet.
10. Prevent the power cord from being tread upon or pinched, particularly at the plug, convenience receptacles, and the point where they exit from the device. Be sure that the power outlet is located near the equipment so that it is easily accessible.
11. Only use attachments/ accessories specified by the manufacturer.
12. Use only with the cart, stand, tripod, bracket, or table specified by the manufacturer, or sold with the apparatus. When a cart is used, use caution when moving the cart/ apparatus combination to avoid injury from tip-over.
13. Unplug this apparatus when it will be unused for a long period of time.
14. Refer all servicing to qualified service personnel. Servicing is required when the apparatus has been damaged in any way, such as power-supply cord or plug is damaged, liquid has been spilled or objects have fallen into the apparatus, the apparatus has been exposed to rain or moisture, or the unit does not operate normally, or has been dropped.



USE

AC power Cord

Keep the following guidelines to protect the AC power cord from being damaged. If the AC power cord is damaged, it may result in a fire or an electric shock. Stop using it and ask your dealer or ViewSonic service center to exchange it.

- Do not place the display where the power cord is subject to wear or abuse.
- Do not pinch, bend, or twist the cord excessively.
- The core lines may be bared and cut, causing a short-circuit, and resulting in a fire or an electric shock.
- Do not convert or damage the power cord.
- Avoid power cord being rolled over or rested upon.
- When the power cord is plugged in, do not move the display.
- Keep the power cord away from heat sources.
- When you disconnect the AC power cord, disconnect it from the wall outlet first.
- When disconnecting the power cord, grasp the plug instead of pulling the power cord.
- Use only an original ViewSonic AC power cord, not other brands. Do not use the supplied AC power cord on any other equipment.
- The plug of power cord is intended to serve as disconnection device. And the socket-outlet shall be installed close to the shredder for easy Access.



Wall outlet

Insert the plug fully into the outlet. If it is loose, do not use it. Doing so may cause arcing and result in a fire. Contact your electrician to change the outlet.

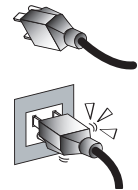

Wiring

For your safety, be sure to unplug the AC power cord when connecting cables. Take care not to trip on the cables. It may cause damage to the display set.

Electric shock

Do not touch the AC power cord or the display with a wet hand. If you plug/unplug the AC power cord from the display with a wet hand, it may cause electric shock.



Lightning storms

During a lightning storm, unplug the display from the wall outlet and disconnect the antenna to prevent damage to the display.

When not in use

If you will not be using the display set for long periods of time, the display set should be disconnected from the AC power outlet to prevent power line surges. The display set is not disconnected from the AC power source when the display set is switched off.

To disconnect the display set completely, unplug from the AC power outlet.

Overloading

This display set is designed to operate on a 120V AC supply only.

If there are too many appliances connected to the same AC power outlet, it could result in a fire or an electric shock.



Optional equipment

If optional equipment is to be installed, leave some space between optional equipment and the display set. Picture distortion and/or noisy sound may occur if the display set is positioned in close proximity to any equipment emitting electromagnetic radiation.

Small accessories

Keep small accessories in a safe place where children are unable to reach.

Magnetic influence

This display contains a strong magnet in the speaker unit that generates a magnetic field. Keep any items susceptible to magnetic fields away from the speaker.

Sound

If you hear snapping or popping sound comes from the display continuously or frequently while the display is operating, unplug the display and consult your dealer or service technician. It is normal for some displays to make occasional snapping or popping sounds, particularly when being turned on or off.



Use in outdoor

This display is not designed for outdoors installation. Do not expose the display to rain, as it may result in a fire or an electric shock. Also, do not expose the display to direct sunlight, as it may heat up and become damaged.

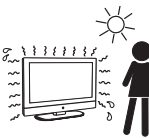

Vehicle, ships and other vessels

Do not install this display in a vehicle. Car accidents may cause the display to fall down and cause injury.

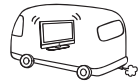

Do not install this display in a ship or vessel. If the display is exposed to seawater, it may cause a fire or damage the display.



Medical institutions

Do not place this display in a place where medical equipment is in use. It may cause the medical equipment to malfunction.

Volume adjustment

- Adjust the volume to avoid disturbing your neighbors. Sound carries easily at night. Therefore, we suggest you close the windows or use headphones.
- When using headphones, adjust the volume to appropriate levels, or hearing damage may result.

ANTENNAS

Outdoor antenna grounding

If an outdoor antenna is installed, follow the precautions below. Do not install the outdoor antenna system near of overhead power lines or other electric light or power circuits, or where it can come in contact with such power lines or circuits.

WHEN INSTALLING AN OUTDOOR ANTENNA SYSTEM, EXTREME CARE SHOULD BE TAKEN TO KEEP FROM CONTACTING SUCH POWER LINES OR CIRCUITS AS CONTACT WITH THEM IS ALMOST INVARIABLY FATAL.

Be sure the antenna system is grounded so that it can provide some protection against voltage surges and built-up static charges.

Section 810 of the National Electrical Code (NEC) in the U.S.A. and Section 54 of the Canadian Electrical Code in Canada provides information with in regard to proper grounding of the mast and supporting structure, grounding of the lead-in wire to an antenna discharge unit, size of grounding conductors, location of antenna discharge unit, connection to grounding electrodes, and requirements for the grounding electrode.

Antenna grounding according to the National Electrical Code, ANS/NFPA70

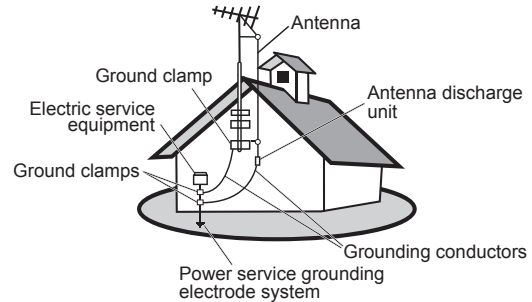

CLEANING

Cleaning the AC power plug

Unplug the AC power plug and clean it regularly. If the plug is covered with dust and gathers moisture, its insulation may deteriorate and result in a fire.

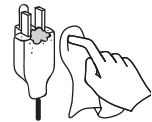

Cleaning the screen surface/ cabinet of the display set

When cleaning this display, unplug the AC power cord. If not, it may result in electric shock. Use a dry soft cloth to clean the cabinet of the display. To remove dust near the screen, wipe it gently with a soft cloth.



Stubborn stains may be removed with a cloth slightly dampened with a solution of mild soap and warm water. Never use strong solvents such as thinner or benzine for cleaning. If using a chemically pretreated cloth, please follow the instruction provided on the package. The ventilation holes can accumulate dust over time. To ensure proper ventilation, we recommend you to remove the dust periodically (once a month) using a vacuum cleaner, while the display is powered off.

Disclaimer

Some chemical cleaners have been reported to damage the screen and/or case of the display. ViewSonic will not be liable for damage resulting from use of these cleaners.

CARRYING THE DISPLAY

Carry the display as instructed

To prevent dropping the display and causing serious injury, you must follow these guidelines:

- Disconnect all cables before carrying the display.
- Carrying the large size display requires at least two or three people.
- When you carry the display, place your hands as illustrated and hold it securely. Do not put stress on the panel and the frame around the screen.
- When carrying the display, do not subject it to shocks, vibration, or excessive force.

- When lifting or moving the display, hold it securely from the bottom. Place your palm directly under the panel.

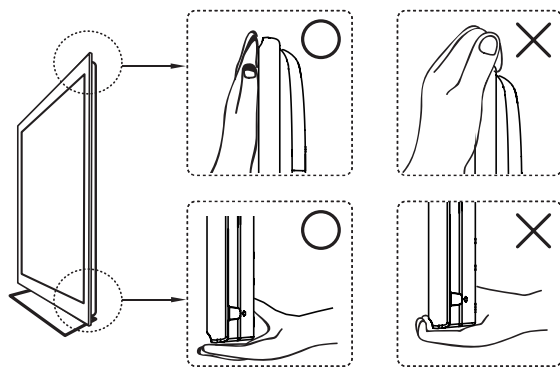

VENTILATION

Slots and openings in display are provided for ventilation. To ensure reliable operation of the display and to protect it from overheating, be sure these openings are not blocked or covered.

The display may accumulate dust and get dirty if proper ventilation is not provided. For proper ventilation, follow the following guidelines:

- Never install the display face up, down or sideways.
- Never install the display turned over or upside down.
- Never cover the slots and openings with a cloth or other materials.
- Never block the slots and openings by placing the display on a bed, sofa, rug or other similar surface.
- Never place the display in a confined space, such as a bookcase or built-in cabinet, unless proper ventilation is provided.



Leave some space around the display set as shown below. Otherwise, air-circulation may be inadequate and cause overheating, which may cause a fire or damage to the display set.

Installed on the wall

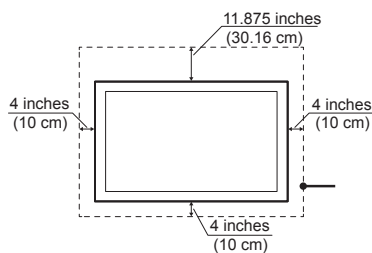

Installed with stand

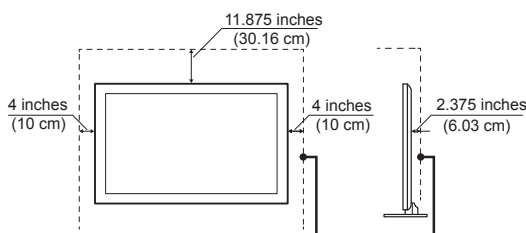

Leave at least this space around the set.

Do not install the display set as follows:

Air circulation is blocked. Air circulation is blocked.

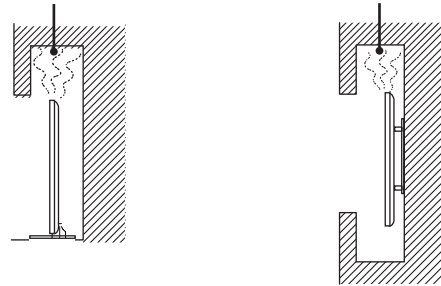

Objects and ventilation holes

Never push any objects into the slots on the display cabinet as they may touch dangerous voltage points or short out parts that could result in a fire or an electric shock. Do not place any objects on the display.

MOISTURE

Moisture and flammable objects

- Keep the product away from moisture. Do not expose this appliance to rain or moisture. Do not place objects filled with liquids, such as vases, on the display.
- Do not use power-line operated display sets near water, such as in places like a bathtub, washbowl, kitchen sink, laundry tub, a wet basement, or near a swimming pool, etc. It may cause fire or electric shock.
- Do not let this display get wet. Never spill liquid of any kind on the display. If water penetrates into the product, unplug the power cord and contact ViewSonic.
- Do not operate the display when wet. It may result in electric shock or damage to the display.
- To prevent fire, keep flammable objects or open flame (e.g. candles) away from the display.

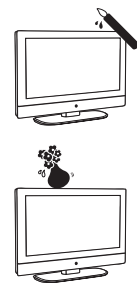

INSTALLATION

Optional wall mount

To do Wall mount installation, you need a Wall-Mount Bracket. When installing or removing the display using the Wall-Mount Bracket, be sure to use qualified contractors. If not properly secured during installation or removal from the Wall-Mount Bracket, the display may fall and cause serious injury.

- When installing the display using a Wall-Mount Bracket, make sure you follow the operating instructions supplied with the Wall-Mount Bracket.
- Attach the brackets supplied with the Wall-Mount Bracket.
- The display is not designed for hanging from the ceiling. It may fall and cause serious injury.

Placement

The display should be installed near an easily accessible AC power outlet.

Observe the following to prevent the display from falling from the stand or wall mount.

- Place the display on a stable, level surface.
- Do not hang anything on the display. Do not allow children to climb on the display. Do not install the display in places subject to extreme temperature, such as in direct sunlight, near a radiator, or heating vent. If the display is exposed to extreme temperature, the display may overheat and cause deformation of the enclosure or cause malfunction.



- Do not install the display in a place exposed to direct air conditioning.
- If the display is installed in such a location, moisture may condense inside and may cause a malfunction.
- Do not place the display in hot, oily, humid or excessively dusty places.
- Do not install the display where insects may enter.
- Do not install the display where it may be exposed to mechanical vibration.
- Do not install the display in a location where it may spear up, such as on or behind a pillar, or where you might bump your head on it. It may cause injury.



Preventing the display from toppling over

To prevent the display from toppling over, secure the display to a wall or stand.

Placement for watching

We suggest you to watch the display at a distance of 3-7 times that of the screen height, and not in excessive brightness. It is easy to cause eye fatigue if you watch display for too long or in a dark room. To obtain clear picture, do not expose the screen to direct illumination or sunlight. Use spot lighting directed down from the ceiling if you can.

SCREEN

- Although the screen is made with high precision technology and has effective pixels of 99.99% or more, black dots or bright points or light (red, blue, or green) may appear constantly on the screen. This is a structural property of the panel and is not a malfunction.
- The screen is made with high-precision technology. To achieve a high level of performance and picture quality, this display's backlight setting is set to maximize the brightness of the display. However, uneven brightness may be observed when the display is viewed in a dark environment without an input source or a blank screen. This is a normal condition, not a malfunction of the display. To improve this condition, change the Picture mode, Backlight setting, enable the Light Sensor, or turn on the Power management.
- Avoid exposing the screen surface to direct sunlight. It is likely to damage the panel.
- Do not push or scratch the screen, or place objects on top of the display. The image may be uneven or the panel may be damaged.
- If the display is used in a cold place, a smear may occur in the picture or the picture may become dark. It is not caused by a failure. This condition will improve as the temperature rises.
- When still pictures are displayed continuously, ghosting may occur. It should disappear after a short period of time.
- The screen and cabinet get warm when the display is in use. This is a normal condition.
- Spraying insect repellent with volatile material on the screen will cause damage.
- Do not make prolonged contact with rubber or plastic material.

Broken pieces

Do not throw anything at the display. Doing so may break the screen glass and cause serious injury.

If the surface of the display cracks, unplug the AC power cord before touching the display. Otherwise electric shock may result.



Handling of broken glass and liquid crystal leakage

If the panel gets damaged, crystalline liquid leakage may occur, or scattered broken glass may result. Do not touch broken glass or crystalline liquid which is toxic, with bare hands as cuts, poisoning or skin irritation may occur. Also do not glass fragments or leaked crystalline liquid get into your eyes or mouth. Should either contacted your eyes or mouth, rinse the contacted area thoroughly with water and consult your doctor.

SERVICING

Do not attempt to repair the display yourself, since opening the cabinet may expose you to dangerous voltage or other hazards. Ask qualified service personnel to do the servicing for your display.



Replacement parts

When replacement parts are required, be sure the service technician certifies in writing that he/she has used replacement parts specified by the manufacturer that have the same characteristics as the original parts. Unauthorized substitutions may cause a fire, an electric shock or other hazards.

Safety check

Upon completion of repairs to the display, ask the service technician to perform routine safety checks (as specified by the manufacturer) to determine that the display is safe for operating, and to so certify.

Ask a qualified service technician to dispose of the display.

Getting Started

Package Contents

Please make sure the following items are included with your display. If any items are missing, please contact your dealer.

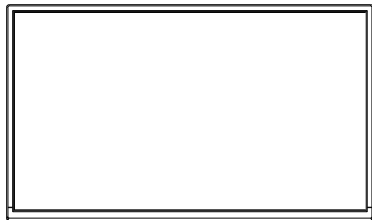

Display



Remote Control with batteries

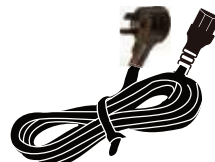

Power Cord
(For US model)



Power Cord
(Only for EU+UK model)



Disc
(User Guide)



Quick Start Guide

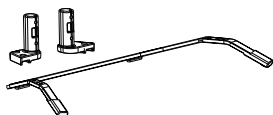

Stand STND-043



The photos of the accessories are for reference only. The color of the remote control, and the type of power cord are variable based on the actual models. User can use the optional stand assembled into a complete unit as following detail drawing.

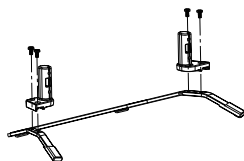

Screw: M4 X L10 x4

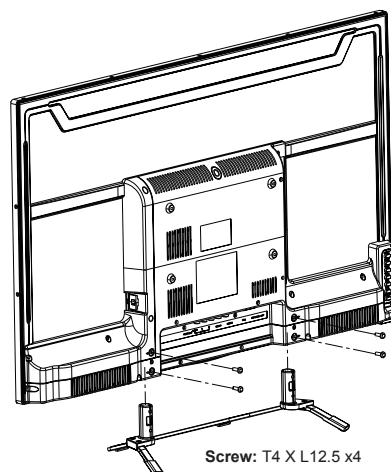

Screw: T4 X L12.5 x4

Installing the Display

Installing the Stand

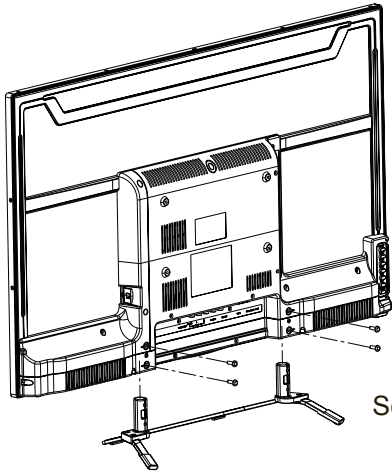

Screw: T4 x L12.5 x4

Place the display face down on a protective surface. Then insert the neck onto the bottom stand and secure the parts by inserting the screws and tightening them with the screwdriver.

Note: Attaching the stand requires two people.

Disconnecting the Stand

To remove the stand, loosen the screws in the circled area and the neck will come off.

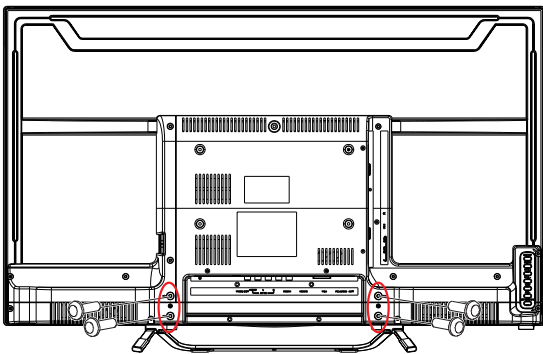

Screw: T4xL12.5 x4

Mounting ViewSonic display to the wall

The display can be used in a free standing position or wall-mounted. Before installing the product to the wall, please consider the following guidelines:

- Read the Important Safety Instructions, at the start of this manual.
- Do **not** install in a moist or wet environment. This equipment is intended for **indoor use**.
- Do **not** install near heat source, or strong magnetic fields.
- Use only **ViewSonic approved** wall-mounting brackets to support the display weight.
- Before attaching the wall mount plate to the back cover, ensure the product is working.
- If your display is already set up for free-standing operation, you need to first remove the stand before mounting the device to the wall.

To attach the wall-mount bracket to display safely, please use the following guidelines:

- Disconnect the power and any other cables that might hinder moving the display.
- Set the display on a table or work surface, placing the screen face down on a towel or woolen blanket to protect the screen surface from damage while installing plate.
- Before installing the display on the wall, ensure you have recorded the product serial number on page (i) of the User Guide, as you will need the serial number to request service where there be a service need.
- Install the wall mount plate to the display using screws **NO LONGER than 10mm**, as longer screws found in universal (non-ViewSonic) wall mount kits may damage the power supply causing the unit to fail.
The wall-mount screw type is M4 x L7.

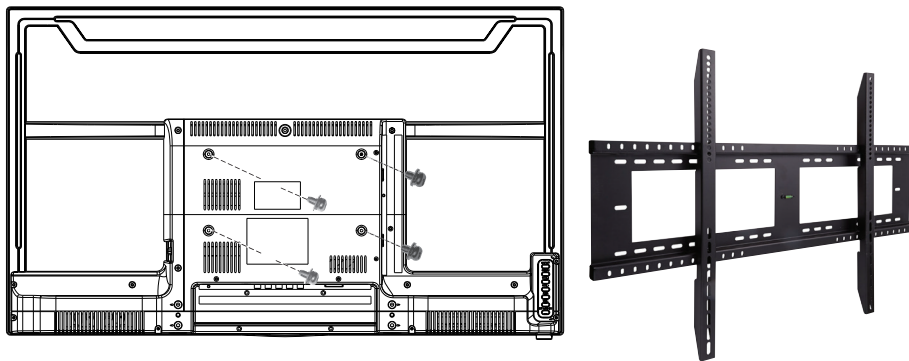

- Mount the wall mount bracket to the wall, ensuring use of proper screws to support the installation. Ensure there is at least 2.5cm/ 1" of space surrounding any air-vents of your display to allow adequate cooling during operation.
- Hang the display wall mount plate to the wall mount bracket, completing installation.

Enjoy your ViewSonic display!

Wall Mount Kit Specifications (VESA)

When attaching to other building materials, please contact your nearest dealer.

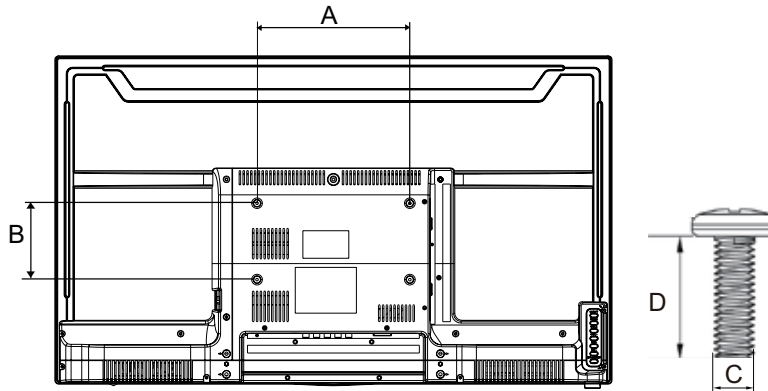

Product Family	inch	VESA Spec. (A x B)	Standard Screw (C x D)	Quantity
CDE	32	200 x 100 mm	M4 x L7	4

- ViewSonic provides the standard dimensions for wall mount kits as shown in the table above.
- To find the perfect mount, please browse www.viewsonic.com or call our service team: United States 1-800-688-6688, Canada 1-866-463-4775, Europe +44 (0) 207 382 8250.
- When purchasing our wall mount kit, a detailed install manual and all parts necessary for assembly are provided.
- The screw length correlative to the thickness of wall mount holder. Do not use the screws that longer than the standard dimension, as they may cause damage to the inside of the display set.

Front View & Key Pad of the Product

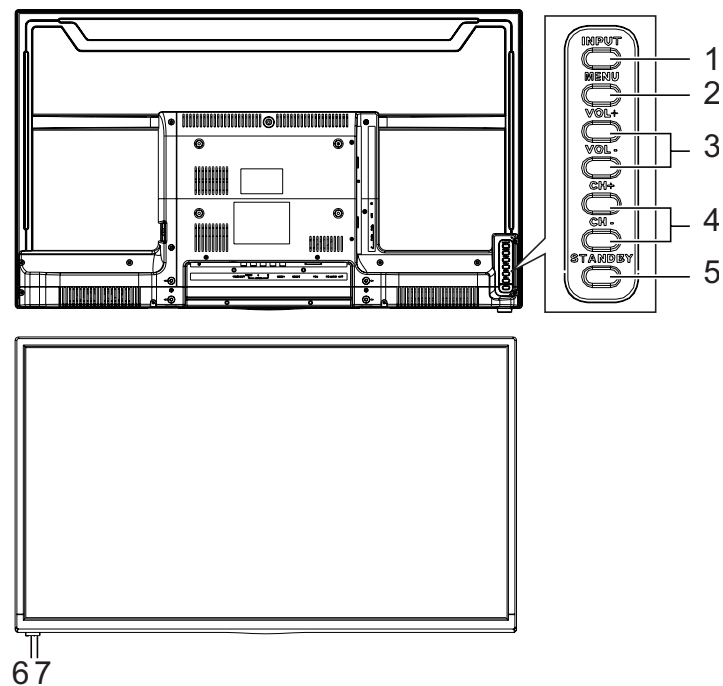

Item	Icon	Description
1 Input	INPUT	Select the input source. Enter the submenu.
2 Menu	MENU	Turn the on-screen display (OSD) menu on / off.
3 Volume	VOL +	Increase the volume. Move to the right or adjust the setting on the OSD menu.
	VOL -	Decrease the volume. Move to the left or adjust the setting on the OSD menu.
4 Up & Down	CH +	Move upward to scroll through menu options.
	CH -	Move downward to scroll through menu options.
5 Power	STANDBY	Turn the power on from standby mode. Touch it again to return to standby mode.
6 Remote Control Receiver		Receive IR signals from the remote control.
7 LED Indicator		Green indicates power on. Red indicates standby mode.

Rear & Side View of the Product

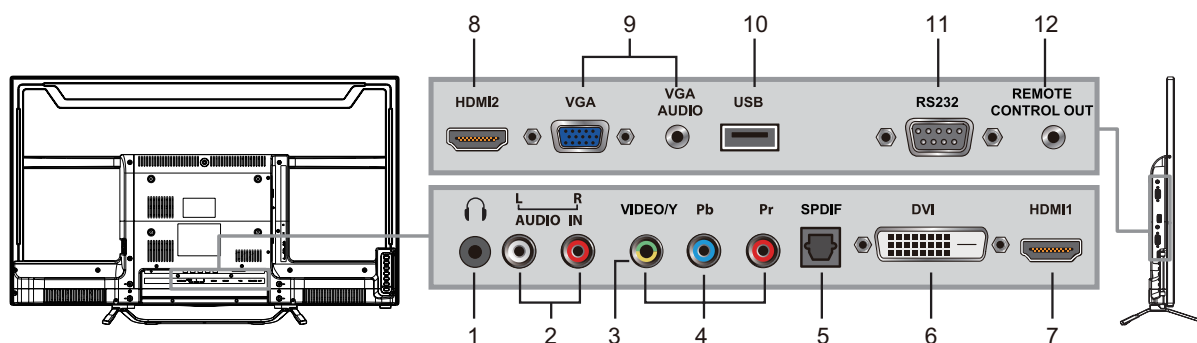

Item	Description
1 Earphone Jack	Connect to earphones. By connecting the earphones, you can listen to the sound from the display through the earphones. If you connect the earphones, the display speakers will be muted.
2 Audio input (left/ right)	Connect to the corresponding audio connectors on your A/V device.
3 CVBS input	Connect to the CVBS input of A/V devices.
4 YPbPr signal input	Connect to the YPbPr output of YPbPr device.
5 SPDIF Optical output	Connect to the SPDIF input of Audio amplifier.
6 DVI-D	Connect to the DVI-D of PC.
7 HDMI 1 input (with MHL)	Connect to the HDMI output of A/V devices. The HDMI 1 has MHL function to support mobile device.
8 HDMI 2 input	
9 PC/VGA in & PC Audio in	Connect to a PC VGA port and a PC line / audio port.
10 USB	Connect to USB devices, such as USB flash drive.
11 RS232 signal input	Reserved for the service technician's use. See RS232 protocol section.
12 IR Out	Connect to an IR emitter. This will enable the remote control of external equipment.

Connecting the Display

HD Cable Box/HD Satellite Box

You can also enjoy high-definition programming by subscribing to a high-definition cable service or a highdefinition satellite service. For the optimum picture quality, be sure to connect this device to your display via the HDMI or component video (with audio) input on the rear side of your display.

HDMI Connection

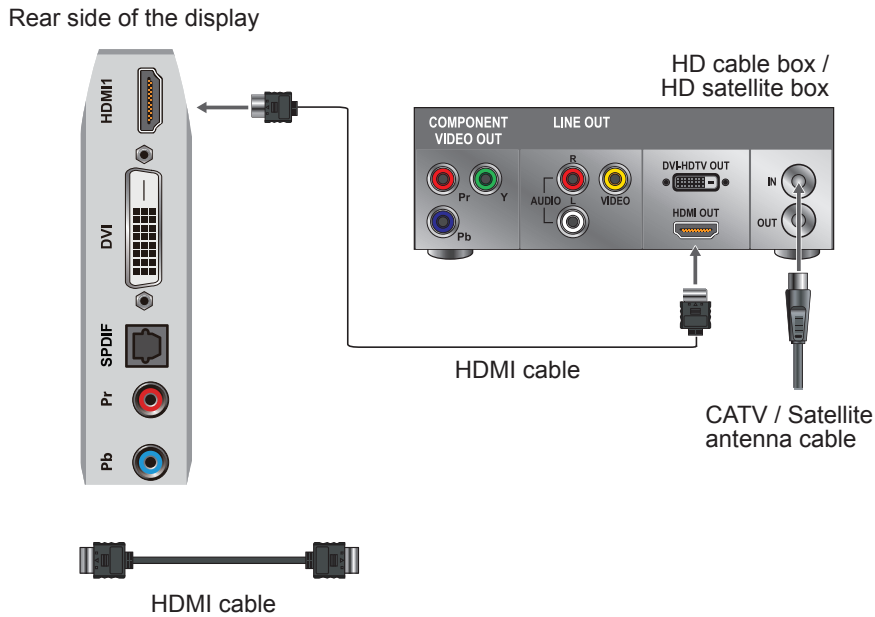

DVI Connection

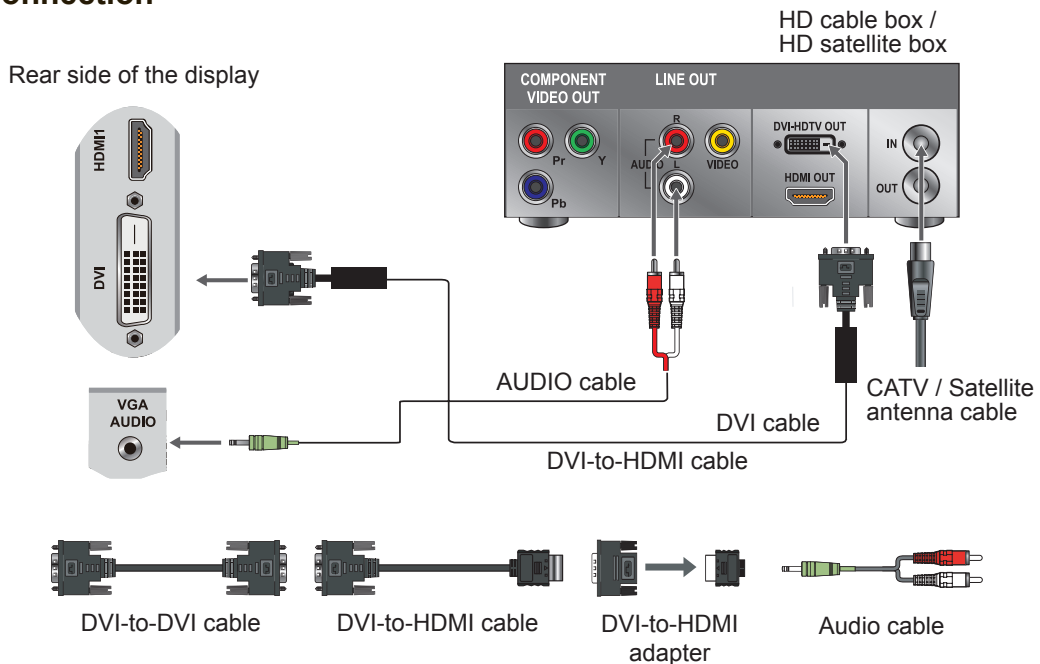

Note:

For alternative DVI connection, connect the HDMI jack (with DVI-to-HDMI cable, or DVI-to-HDMI adapter), and connect the audio jack to the AUDIO IN jacks of PC Audio input.

HDMI Timing Reference Chart

No.	Mode	HDMI	DVI
1	VGA60 (640x480)	Yes	Yes
2	SVGA60 (800x600)	Yes	Yes
3	XGA60 (1024x768)	Yes	Yes
4	SXGA60 (1280x1024)	Yes	Yes
5	WXGA60 (1360x768)	NA	NA
6	1280 x 800	NA	NA
7	1440 x 900	Yes	Yes
8	1680 x 1050	Yes	Yes
9	1920 x 1080	Yes	Yes
10	480i60	Yes	Yes
11	576i50	Yes	Yes
12	480P60	Yes	Yes
13	576P50	Yes	Yes
14	720P50	Yes	Yes
15	720P60	Yes	Yes
16	1080I50	Yes	Yes
17	1080I60	Yes	Yes
18	1080P50	Yes	Yes
19	1080P60	Yes	Yes
20	1080P24	Yes	NA
21	1080P30	NA	NA

YPbPr or Component Connection

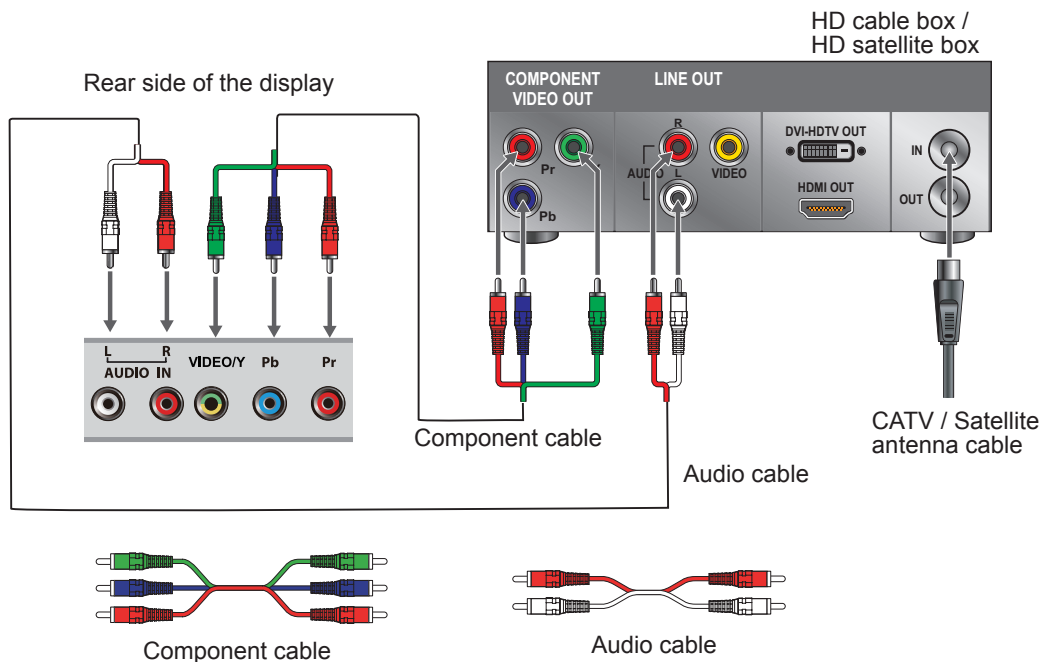

Note:

YPbPr provides better quality than the AV connection.

AV Connection

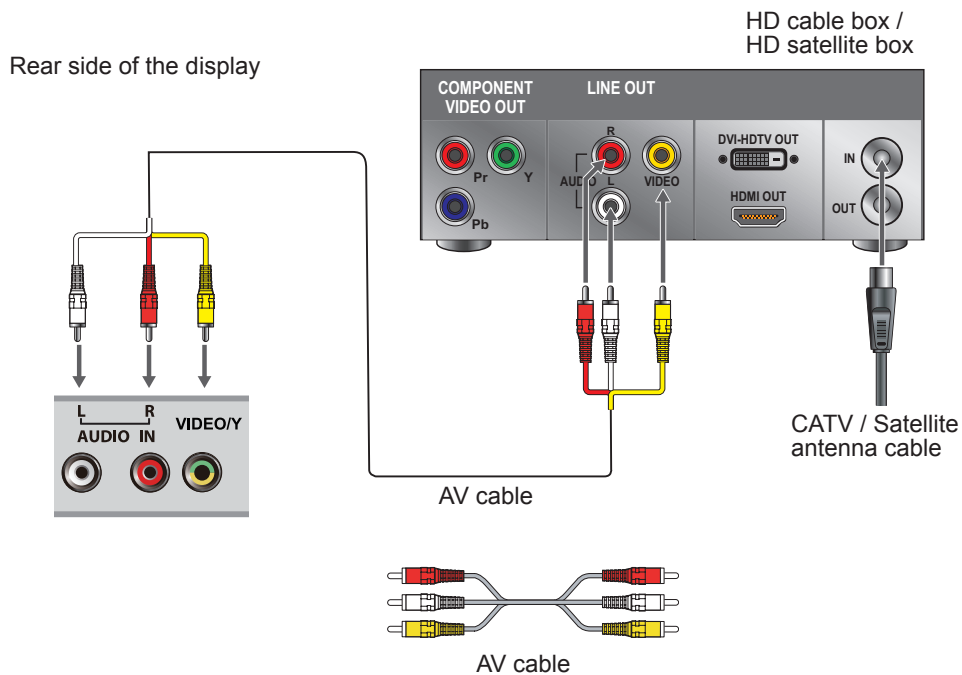

Programming your Cable or Satellite Box remote

Refer to the user manual from your service provider to determine the setting.

If it requires:

- 3 digits, please try “566”, “565”, “556”, or “688”. It usually works with DISHNetwork.
- 4 digits, please try “0054”. It usually works with Cox.
- 5 digits, please try “11454”, “11054”, or “10690”. It usually works with DIRECTV.

Personal Computer

Use the display as the monitor of your computer.

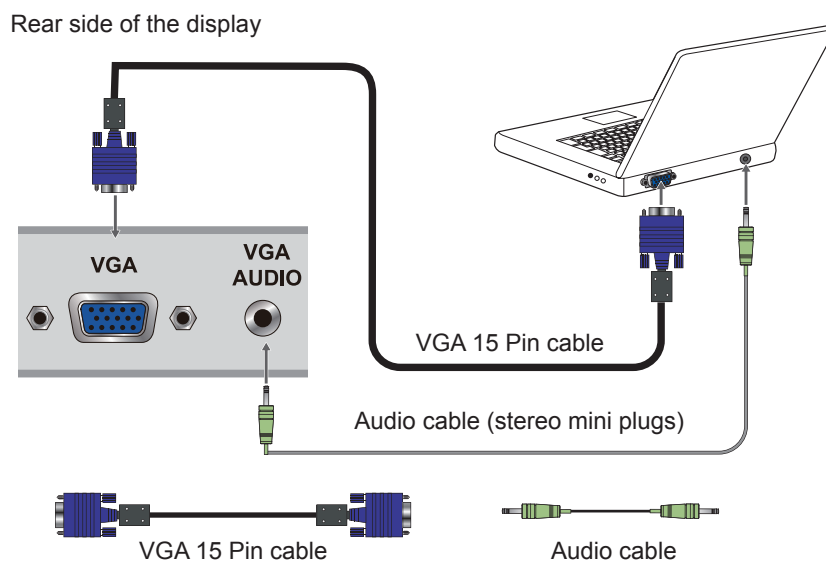

PC Timing Reference Chart

No.	VGA Timing		Panel FullHD (1920 x 1080) Support				
	Mode	Resolution	H sync (kHz)	V sync (Hz)	Pixel clock (MHz)	Polarity	Support
1	IBM VGA	720 x 400	31.47	70.09	28.32	N/P	Yes
2	VESA DMT	640 x 480	31.5	59.94	25.175	N/N	Yes
3	VESA DMT	800 x 600	37.88	60.32	40	P/P	Yes
4	VESA DMT	1024 x 768	48.36	60	65	N/N	Yes
5	VESA DMT	1280 x 768	47.77	59.8	79.5	N/P	Yes
6	VESA DMT	1280 x 800	49.7	59.81	83.5	N/P	NA
7	VESA DMT	1280 x 1024	63.98	60.02	108	P/P	Yes
8	VESA DMT	1360 x 768	47.71	60.01	85.5	P/P	NA
9	VESA DMT	1440 x 900	55.94	59.89	106.5	N/P	Yes
10	VESA DMT	1680 x 1050	65.29	59.95	146.25	N/P	Yes
11	CEA	1920 x 1080	67.5	60	148.5	P/P	Yes

Note:

This VGA input does not support interlaced signals.

Using the Display Features

Remote Control and Display Controls

Inserting Remote Control Batteries

1. Remove the battery cover by pulling then lifting the knob on the cover.
2. Insert the batteries, corresponding to the (+) and (-) markings on the battery compartment.
3. Reattach the battery cover.

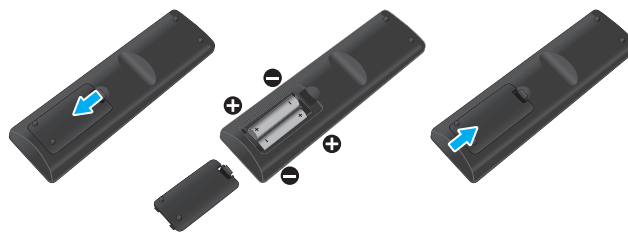

CAUTION

- Only use the specified AAA batteries.
- Do not mix new and old batteries. This may result in creaking or leakage, which may pose a risk of fire or lead to personal injury.
- Insert batteries according to (+) and (-) markings. Inserting the batteries incorrectly may result in leakage, which may pose a risk of fire or lead to personal injury.
- Dispose of the battery in accordance with local laws and regulations.
- Keep the batteries away from children or pets.
- When the remote control will not be used for an extended period, remove the batteries.

Remote Control and Display Controls

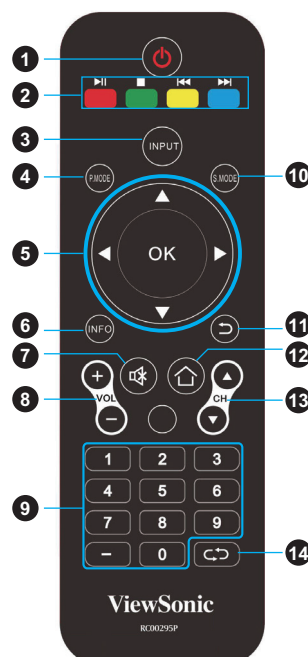

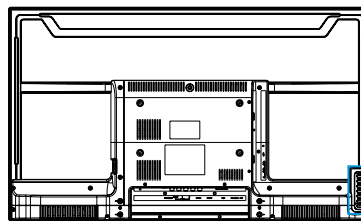

Touch keys located at the rear side of the display operate the same as these buttons on the remote control.

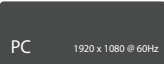

Button	Description
1 POWER	Press this button to turn the power on from standby mode. Press it again to return to standby mode.
2	<p> Play or pause the playback in MEDIA mode.</p> <p> Stop in MEDIA mode.</p> <p> Jump to previous and next track in MEDIA mode.</p>
3 INPUT	<p>Press to display the Source Select list and select the source with / .</p> <p>To confirm the selection, press OK.</p> 
4 P. MODE	To set the desired picture mode
5 / OK buttons	<p>Press these buttons to navigate the OSD menus.</p> <ul style="list-style-type: none"> • - move upward/downward to select menu options. • - move to the right/left to select the main menu or adjust the settings. You can also use to enter the corresponding submenu. • OK: Confirm the selection or enter the corresponding submenu.
6 INFO	Press to display the current state of the display. 
7 MUTE	Press to turn off the sound. To restore the sound, press this button again, or press the VOL+/- button.
8 + VOL -	Press to adjust the volume.
9 0~9, - number buttons	Press the respective button to input a character or number.
10 S. MODE	To set the desired sound mode
11 EXIT	Press to exit OSD setting from menu screen.
12 MENU	Press to turn the OSD (On-Screen Display) menu on.
13 + CH -	This function is not available for this model. (Only for TV)
14 RECALL	To return to previous channel (Only for TV)

Operation

Turning the Display On and Off

Press  on the remote control.
You can also use the  key on the front side of the panel.

* If there is no input signal within 10 minutes, the display will be turned off automatically.

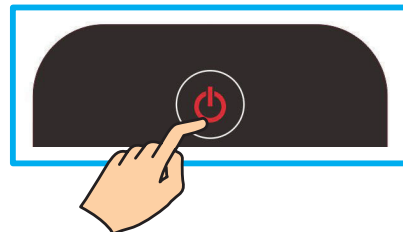

Adjusting the Volume

Press **VOL +/-** to adjust volume.
To turn off the volume, press **MUTE**.
To restore volume, press **MUTE** again, or press **VOL +/-** directly.

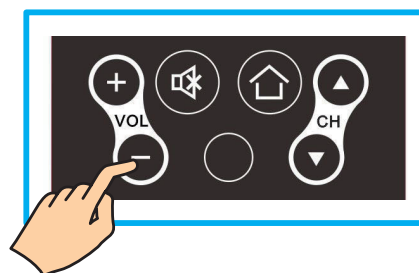

Viewing the Displayed Information

To display the current information of the display:
Press **INFO**, and the current state will be displayed on the screen. (It shows all or some of the information about Input, Resolution, etc., depending on the input source)

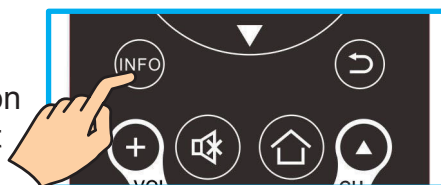

* The illustration shows an example of the INFO screen in an HDMI source.

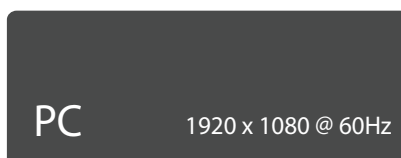

Selecting the Input Source

To select the input sources connected to the display:

1. Press **INPUT** on the remote control.
2. Press **▲** or **▼** to select the desired input source.
3. To confirm the selection, press **OK**.

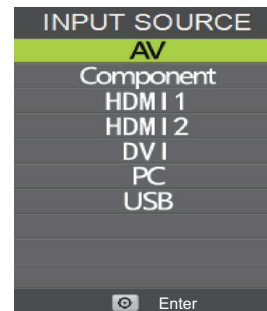

Using the Lock Control

With LOCK CONTROL, you can block input source.

Password is required to access the LOCK CONTROL menu. The default is "0000".

Changing Password

To change a new password:

1. Press **MENU** to display the OSD main menu.
2. Press **◀** or **▶** to select **LOCK** menu, then press **OK** to enter the menu.
3. Enter the password.
4. Press **▲** or **▼** to select **Change Password**, then press **▶** to enter its submenu.
5. Enter the old password.
6. Enter your new password.
7. Enter your new password again to **Confirm**.
The screen will return to the LOCK CONTROL menu. This indicates the password has been changed.
8. Press **EXIT** to exit the menu.

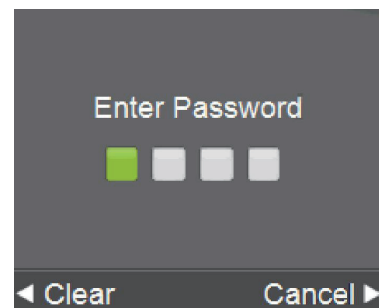
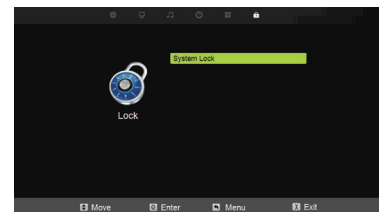

Picture Menu

Customizing the PICTURE Settings

1. Press **MENU** to enter the main menu, Press ◀/▶ button to select.
2. Press **OK** or ▼ button to enter specific submenu.
3. Press **MENU** again to exit or back to parent menu.

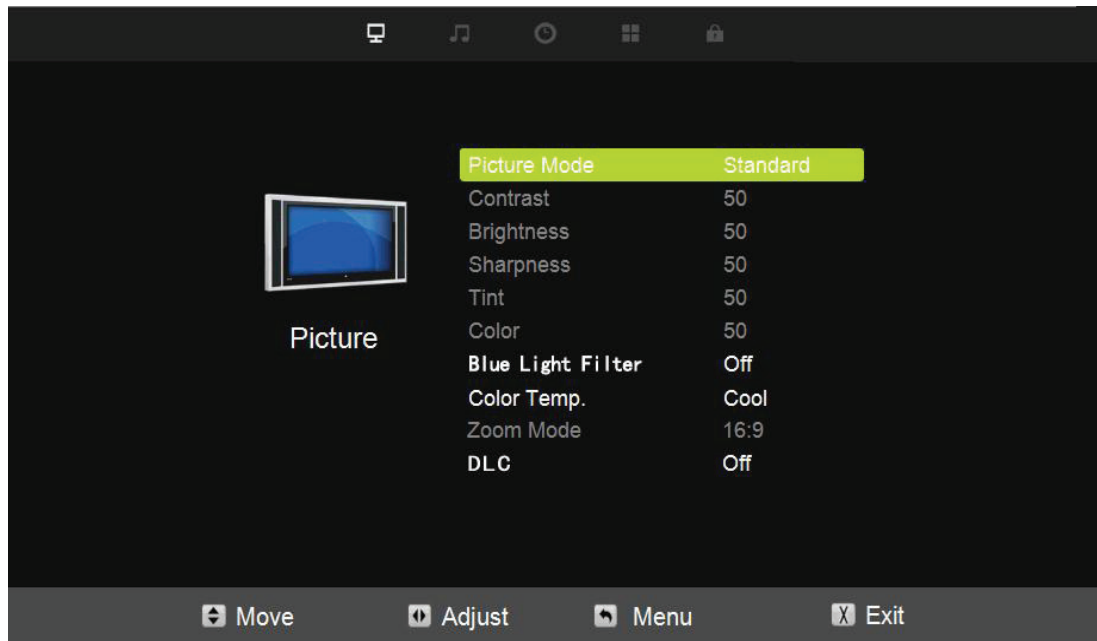

4. Press ▲ / ▼ button to select among Picture Mode / Contrast / Brightness / Sharpness / Tint / Color / Blue Light Filter / Color Temperature / Zoom Mode / DLC.
5. Press **OK** or ▶ button to enter.
6. Press ◀ / ▶ button to adjust.
7. Press **MENU** again back to parent menu.

The **PICTURE** menu includes the following options:

Picture Mode	Cycles among display types: Standard, Dynamic, Theater, Power Saving, and Personal. Personal: Allows to store your preferred settings. If you select the Personal mode, you can individually set the items shown.
Contrast	Controls the difference between the brightest and darkest regions of the picture.
Brightness	Controls the overall brightness of the picture.
Sharpness	Increase this setting to see crisp edges in the picture; decrease it for soft edges.
Tint	Controls the difference between the blue / red and green regions of the picture. (Only for NTSC)
Color	Controls the color intensity.
Blue Light Filter	Reduces the blue ray by filter
Color Temp	Adjusts color components independently to achieve a Normal, Warm, Cool, or Personal effect.
Zoom Mode	Adjust how the picture fills the screen.
DLC	Set options to set dynamic backlight.

Audio Menu

Customizing the Audio Settings

1. Press **MENU** to enter the main menu, Press ◀ / ▶ button to select.
2. Press **OK** or ▼ button to enter specific submenu.
3. Press **MENU** again to exit or back to parent menu.

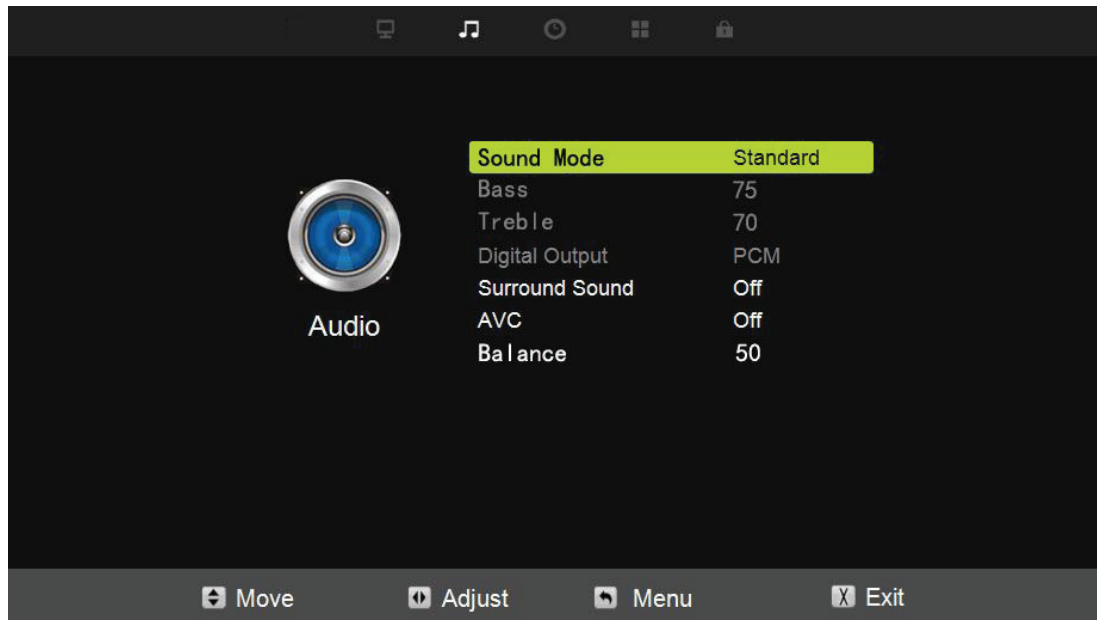

4. Press ▲ / ▼ button to select among Sound Mode / Bass / Treble / Digital Output / Surround Sound / AVC / Balance.
5. Press **OK** or ▶ button to enter.
6. Press ◀ / ▶ button to adjust.
7. Press **MENU** again back to parent menu.

The **Audio** menu includes the following options:

Sound Mode	Standard, Music, Movie, Sports, and Personal. Select a sound mode to achieve ideal sound.
Digital Output	Send digital audio to external audio system.
Surround Sound	Surround Sound Effect.
AVC	Set the auto volume control.
Balance	Adjust the left/right audio output effect.

Note: The Bass and Treble are only available in Personal mode, you can adjust as you like.

TIME Menu

Customizing the TIME Settings

1. Press **MENU** to enter the main menu, Press ◀ / ▶ button to select.
2. Press **OK** or ▼ button to enter specific submenu.
3. Press **MENU** again to exit or back to parent menu.

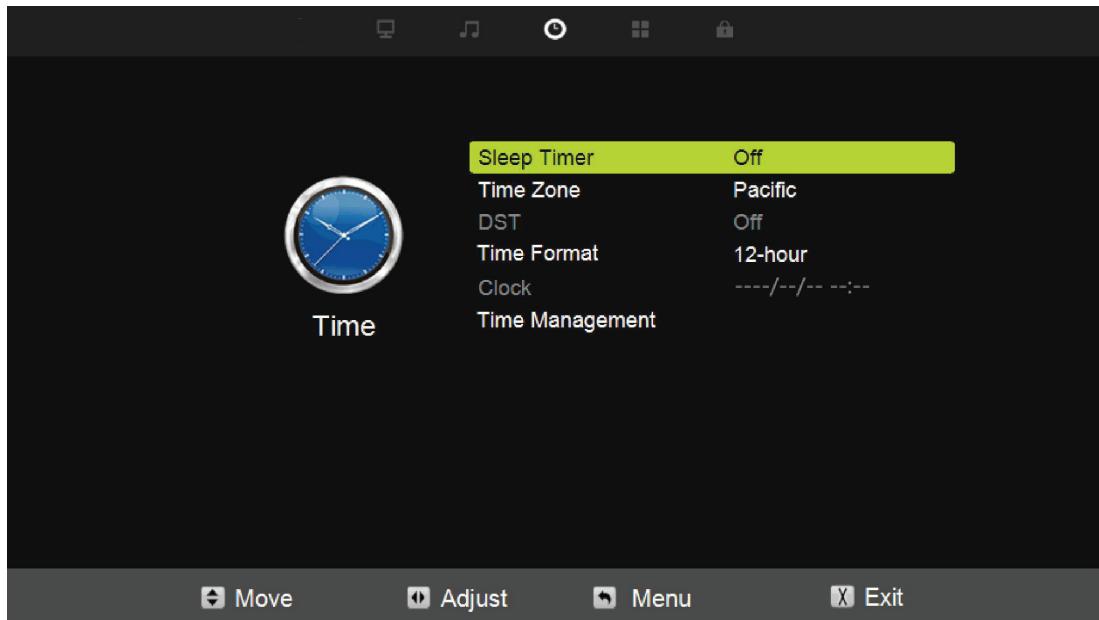

4. Press ▲ / ▼ button to select Sleep Timer / Time Zone / DST / Time Format / Clock / TimeManagement.
5. Press **OK** or ▶ button to enter.
6. Press ◀ / ▶ button to adjust.
7. Press **MENU** again back to parent menu.

The **TIME** menu includes the following options:

Sleep Timer	Set a timer for the display to turn off automatically.
Time Zone	Select your time zone.
DST	Set the daylight saving time for your area.
Time Format	Select your time format.
Clock	Set the date and time.
Time Management	Set the Wake up/Power off time.

SETUP Menu

Customizing the SETUP Settings

1. Press **MENU** to enter the main menu, Press ◀ / ▶ button to select.
2. Press **OK** or ▼ button to enter specific submenu.
3. Press **MENU** again to exit or back to parent menu.

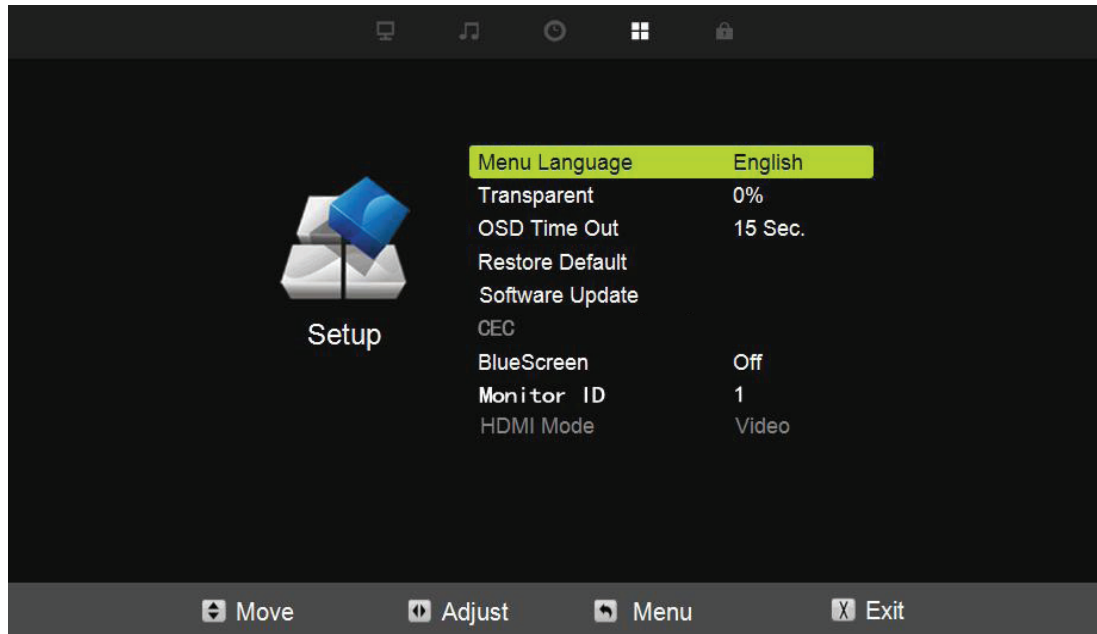

4. Press ▲ / ▼ button to select Menu Language / Transparent / OSD Time Out / Restore Default / Software Update / CEC / Blue Screen / Monitor ID / HDMI Mode.
5. Press **OK** or ▶ button to enter.
6. Press ◀ / ▶ button to adjust.
7. Press **MENU** again back to parent menu.

The **SETUP** menu includes the following options:

Menu Language	Select an OSD menu language can be displayed. Default English is selected as menu language.
Transparent	Adjust the transparency of the OSD (on screen display) menu.
OSD Time Out	Adjust the duration of the OSD (on screen display) menu.
Restore Default	Change power on options or reset Monitor to factory default.
Software Update (USB)	Set to upgrade the software via the USB.
CEC	Set to adjust CEC function.
Blue Screen	To select the transition type required while changing from one channel to another.
Monitor ID	Adjust Monitor ID for RS232 Setting.
HDMI Mode	Select a suitable HDMI mode depending on still or moving content. Only available in HDMI input.

Lock Menu

Customizing the Lock Settings

1. Press **MENU** to enter the main menu, Press ◀ / ▶ button to select.
2. Press **OK** or ▼ button to enter specific submenu.
3. Press **MENU** again to exit or back to parent menu.

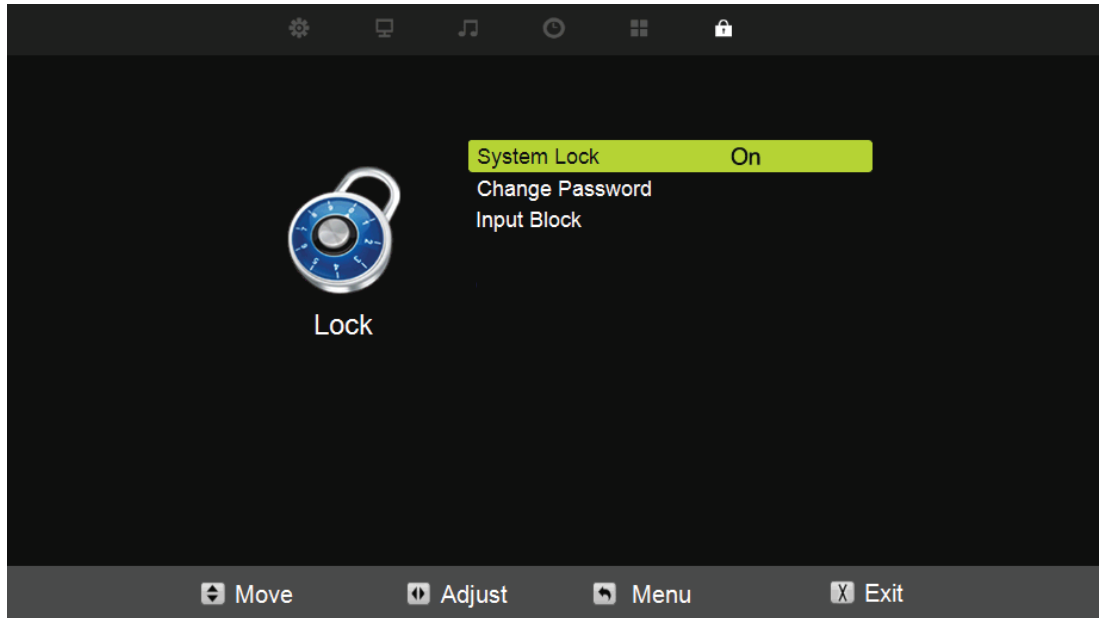

4. Press ▲ / ▼ button to select among System Lock / Change Password / Input Block.
5. Press **OK** or ▶ button to enter.
6. Press ◀ / ▶ button to adjust.
7. Press **MENU** again back to parent menu.

The **Lock** menu includes the following options:

System Lock	Enable or disable the lock function
Change Password	Enter a new 4-digital password then re-enter it to confirm.
Input Block	Block or unblock the input sources.

PC Menu

Customizing the Lock Settings

1. Press **INPUT** to select PC source.
2. Press **MENU** to enter the main menu.
3. Press ◀ / ▶ button to select Picture menu.

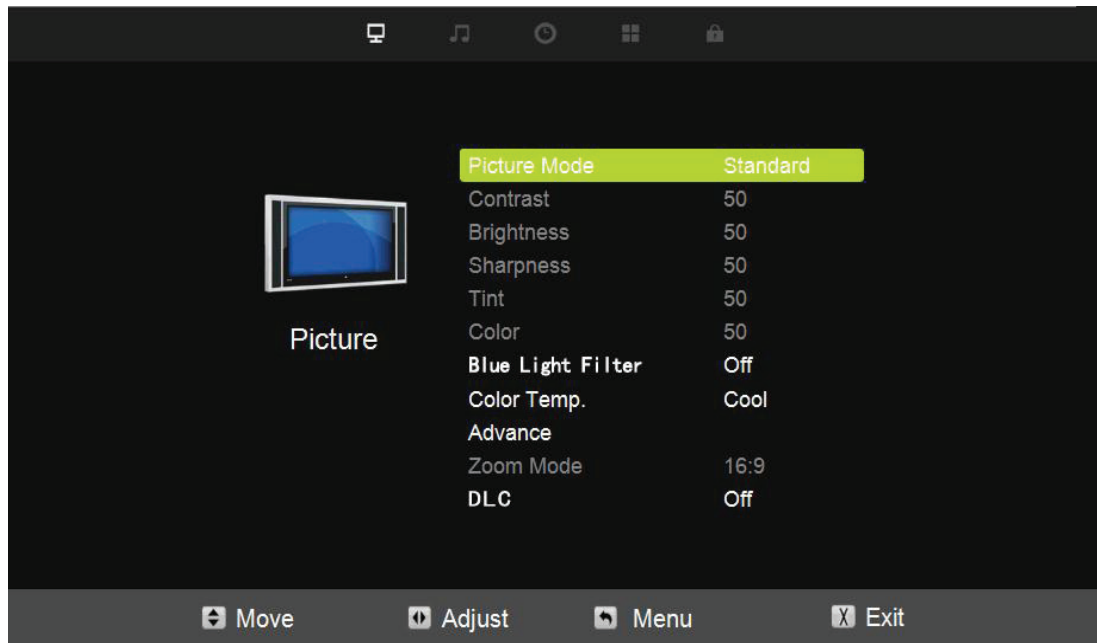

4. Press **OK** or ▶ button to select Advance.
5. Press **OK** or ▶ button to enter.
6. Press ▲ / ▼ button to select among H-Pos / V-Pos / Clock / Phase / Auto.
7. Press ◀ / ▶ button to adjust.
8. Press **MENU** again back to parent menu.

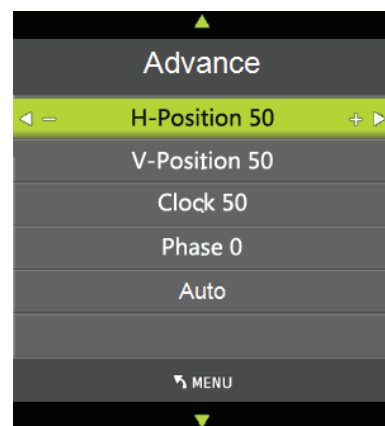

The **PC** menu includes the following options:

H-POS	Adjust the horizontal position of the picture.
V-POS	Adjust the vertical position of the picture.
Clock	Adjust the frequency timing.
Phase	Adjust the horizontal interfering lines.
Auto	Adjust the screen automatically to the optimal position of the picture.

Using the MEDIA OPERATION

1. Plug in USB device, then press **INPUT** button to set the Input Source to Media. Press **▲ / ▼** button to select **USB** in the source menu, then press **OK** button to enter.

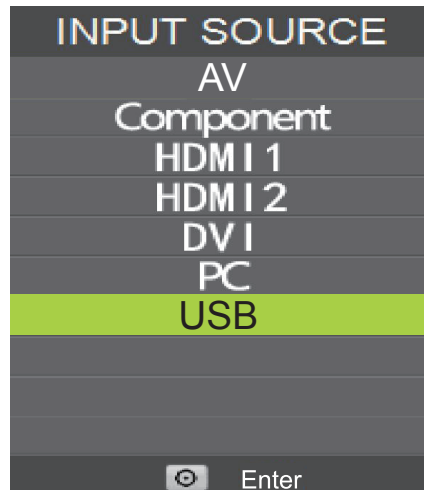

2. Press **◀ / ▶** button to select the option you want to adjust in the main Media menu, then press **OK** button to enter.

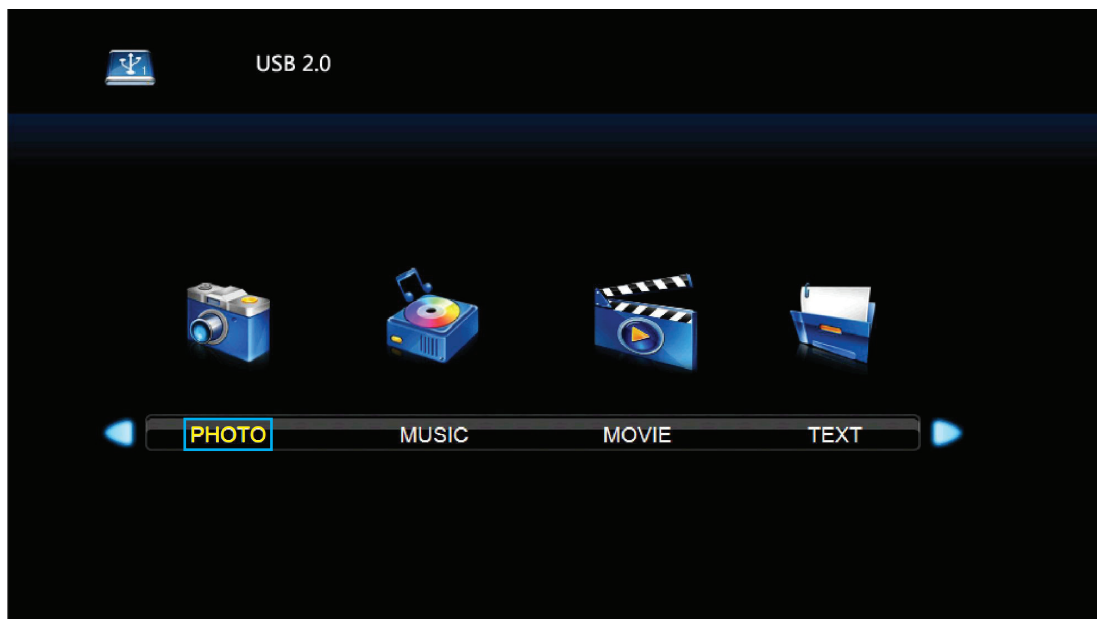

3. Enter the storage. Press ▲ / ▼ / ◀ / ▶ then **OK** to pick the files to play.

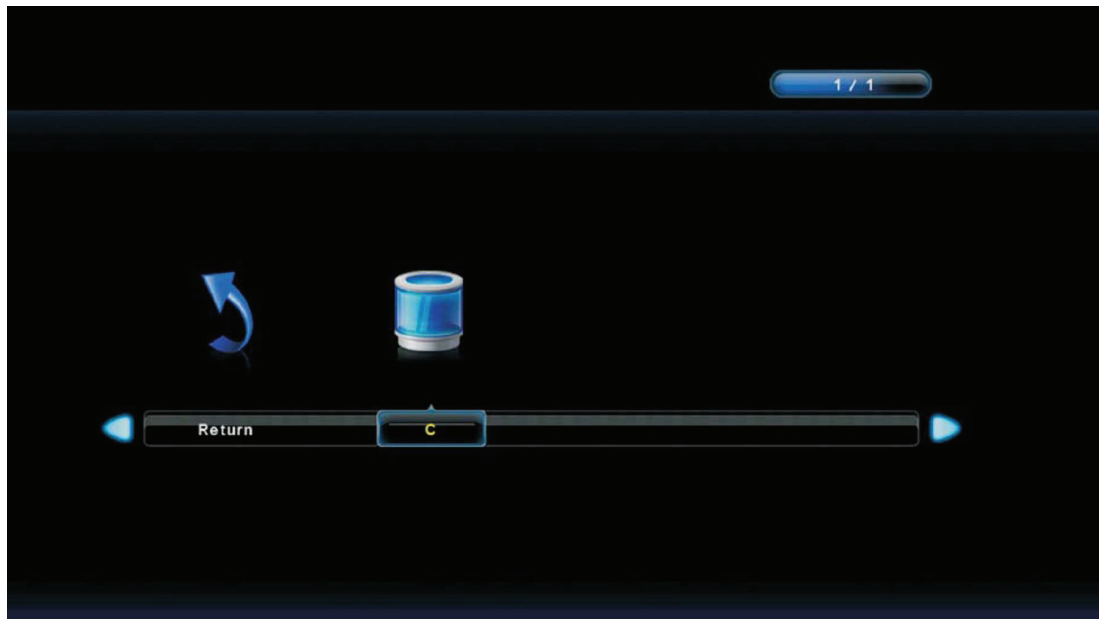

4. Press ► button to start playback. The tool bar will pop up then.
5. For cycling playback, set the Repeat Mode on tool bar to be ALL (R_ALL). Press EXIT to close the tool bar.
6. Press || to pause or ■ to stop the playback. Press ◀◀ button to play the previous file. Press ▶▶ button to play the next file.

Hospitality Menu

User can turn on the menu to lock the setting to prevent adjusting. The fixed setting can also be stored and copied to another same display.

1. Press **MENU** and **9, 9, 3** button on the remote controller to display the Hospitality menu.
2. Press **▲** or **▼**, then **▶** to turn On/Off the Hospitality mode. Go next to Hospitality Function, then press **▶** for detail setting. When selecting a menu item with a submenu (> >), press **▶** or **OK** to enter its submenu.
3. Press **MENU** to return to the previous menu or press **EXIT** to exit the menu.

Hospitality Menu		Menu item	Description
EEPROM Init	DO	EEPROM Init	Clean up the setting to its initial value.
Save Config To USB	>>	Save Config To USB	Save the hospitality configuration into USB drive.
Load Config From USB	>>	Load Config From USB	Load the hospitality configuration from USB drive.
Hospitality	On	Hospitality	Turn on or off the Hospitality function.
Hospitality Function	>>	Hospitality Function	Enter the hospitality sub-menu.
Power On Mode	Off	Power ON Mode	Decide how to turn on the display from AC power outage.

Hospitality Menu		Menu item	Description
Remote Control Code	0	Remote Customer Code	Select the specific remote ID (0, 1, or 2). (For specific model only)
Menu Key	Enable	Menu Key	Enable or disable the MENU key.
Remote Control	Enable	Remote Control	Enable, disable remote or set as IR pass through
Power On Volume	30	Power On Volume	Set the default volume for each power-on
Max Volume	100	Max Volume	Set the limitation of maximum volume
AV	Enable	AV	Enable or disable the input source.
Compoent	Enable	Compoent	
HDMI1	Enable	HDMI1/2	
HDMI2	Enable	DVI	
DVI	Enable	PC	
PC	Enable	USB	
USB	Enable	Power Input	Default input source for each power on.
Power Input	AV		

Other Information

Troubleshooting

Please contact ViewSonic service team directly if you have questions, service needs, or require technical assistance related on the use of your display.

Contact ViewSonic Service Team at:

<http://www.ViewSonic.com>

Or call our service team:

United States 1-800-688-6688

Canada 1-866-463-4775

Europe +44 (0) 207 382 8250

Problem	Possible Solution
No power	<ul style="list-style-type: none">• Make sure the AC power cord is properly connected to the wall outlet.• Plug another electrical device (like a radio) to the power outlet to verify that the outlet is supplying the proper voltage.
No picture	<ul style="list-style-type: none">• Make sure that the cable connection to other components are properly installed.• Make sure that setup has been done correctly after connections.• Make sure the correct input is selected and the input signal is compatible.
Strange color, light color, or color misalignment	<ul style="list-style-type: none">• Ensure that the video cable is securely connected.• The picture may appear dim in a brightly lit room.• Adjust the display settings.• Check the input signal setting.
No sound	<ul style="list-style-type: none">• Check your audio connections to other components are properly installed.• The MUTE button may have been pressed, try pressing this button again.• Check your audio settings, your display audio may be set to minimum.• Press VOL + on the remote control.
Remote control unit does not operate	<ul style="list-style-type: none">• Make sure the batteries are inserted correctly.• Batteries could be weak or dead. Replace with new batteries.• Check if there is a fluorescent light illuminated near the remote control sensor.• The path of the remote control beam may be blocked. Make sure the path is clear and that the remote control is aimed at the remote control sensor on the display.• Press  on the remote control to see if you can turn on the display.• Press MENU on the remote control to see if there is an OSD menu shown on the screen.• Press only one button at a time and it is the correct one for the operation you want to perform.

Problem	Possible Solution
Unit cannot be operated	<ul style="list-style-type: none"> • External influences such as lightning or static electricity may cause improper operation. In this case, operate the unit after first turning on the power of the display and the AV System, or unplug the AC cord for 1 to 2 minutes, then replug again.
Power is cut off suddenly	<ul style="list-style-type: none"> • Make sure the sleep timer is turned off. • Make sure the PC or video signal cable is connected properly. • The internal temperature of the unit has increased. Remove any objects blocking the vent or clean as necessary.
Picture is cut off/with sidebar screen	<ul style="list-style-type: none"> • Make sure the video signal cable is connected properly. • Adjust the Screen Size setting on the Picture menu. • Press ASPECT repeatedly on the remote control to switch to the display mode you prefer.

Specifications

Model		CDE3202
(LED Backlight)	Screen Size	31.5" (80.01 cm) FHD 60Hz
	Aspect Ratio	16:9
Input signal	RGB	1 RGB analog (0.7/1.0 Vp-p, 75 ohms) Separate Sync, fh: 31.47-63.98 kHz, fv:59.8-70.09 Hz
	DVI-D	1 DVI-D 30PIN terminal white color
	Video	1 composite RCA (shared with Y), 1 YPbPr component, 2 HDMI (one has MHL function)
	Audio	1 mini-stereo (for PC/VGA audio in), 1 pair of RCA (L/R) stereo
	USB	JPG / BMP / PNG / MPG / MPEG / MP4 / MKV / TS / TP / TRP / VOB/ AVI / RM / RMVB / MOV / DAT / FLV / WMA / WMV / MP3 / WAV / M4A Format
Compatibility	PC	Up to 1920 x 1080 (CEA mode)
Speaker Output		10W x 2 @ THD=10% (max)
Audio Output		1 Earphone jack, 1 SPDIF (optical)
RS232 Output		RS232 communication
Remote Control Out		Remote control out (RC5 38KHz)
Power	Voltage	AC 100~240V (50/60Hz)
Operating conditions	Temperature	0°C to + 40°C
	Humidity	20% to 90% (no condensation)
Storage condition	Temperature	-20°C to + 60°C
	Humidity	20% to 90% (no condensation)
Dimensions	Physical (L) x (W) x (H)	With stand 729.2 x 465.7 x 164.3 mm (28.71 x 18.33 x 6.47 inches)
		Without stand 729.2 x 429.7 x 48.5 mm (28.71 x 16.92 x 1.91 inches)
Weight(Net)	With stand	5.4Kg (11.88 lb)
	Without stand	5.3Kg (11.66 lb)
Regulations		cTUVus, FCC-B w/ ICES003, DOE Energy Star, NOM or cTUVus-MX-CoC, Mexico Energy, CB of TUV
Power consumption	On	41 W (typ) / 68W (max)
	Stand by	< 0.5W
Warning: Do not set the graphics card in your computer to exceed these refresh rates; doing so may result in permanent damage to the display.		

Note:

Product Specifications are subject to change without notice.

RS232 Protocol

1. Introduction

This document describes the hardware interface spec and software protocols of RS232 interface communication between ViewSonic Commercial TV / Digital Signage and PC or other control unit with RS232 protocol.

The protocol contains three sections command:

- Set-Function
- Get-Function
- Remote control pass-through mode

※ In the document below, “PC” represents all the control units that can send or receive the RS232 protocol command.

2. Description

2.1 Hardware specification

Viewsonic TV communication port on the rear side

(1) Connector type: DSUB 9-Pin Male

(2) Pin Assignment

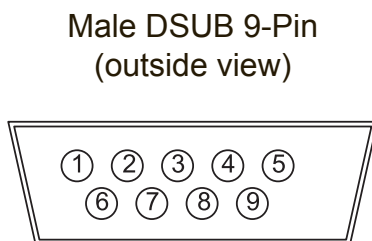

Pin #	Signal	Remark
1	NC	
2	RXD	Input to Commercial TV or DS
3	TXD	Output from Commercial TV or DS
4	NC	
5	GND	
6	NC	
7	NC	
8	NC	
9	NC	
frame	GND	

* Use of crossover (null modem) cable required for use with PC.

2.2 Communication Setting

- Baud Rate Select: 9600bps (fixed)
- Data bits: 8bits (fixed)
- Parity: None (fixed)
- Stop Bits: 1 (fixed)

2.3 Command Message Reference

PC sends to Monitor command packet followed by “CR”. Every time PC sends control command to the Monitor, the Monitor shall respond as follows:

1. If the message is received correctly it will send “+” (02Bh) followed by “CR” (00Dh)
2. If the message is received incorrectly it will send “-” (02Dh) followed by “CR” (00Dh)

3. Protocol

3.1 Set-Function Listing

The PC can control the TV/DS for specific actions. The Set-Function command allows you to control the TV/DS behavior in a remote site through the RS232 port. The Set-Function packet format consists of 9 bytes.

Set-Function description:

- Length:** Total Byte of Message excluding "CR"
- TV/DS ID:** Identification for each of TV/DS (01~98; default is 01)
ID "99" means to apply the set command for all connected displays.
Under such circumstances, only ID#1 display has to reply.
The TV/DS ID can be set via the OSD menu for each TV/DS set.
- Command Type:** Identify command type,
"s" (0x73h) : Set Command
"+" (0x2Bh) : Valid command Reply
"-" (0x2Dh) : Invalid command Reply
- Command:** Function command code: One byte ASCII code
- Value[1~3]:** Three bytes ASCII that defines the value
- CR:** 0x0D

Set-Function format:

Send: (Command Type= "s")

Name	Length	ID	Command Type	Command	Value1	Value2	Value3	CR
Byte Count	1 Byte	2 Byte	1 Byte	1 Byte	1 Byte	1 Byte	1 Byte	1 Byte
Bytes order	1	2~3	4	5	6	7	8	9

Reply: (Command Type= "+" or "-")

Name	Length	ID	Command Type	CR
Byte Count	1 Byte	2 Byte	1 Byte	1 Byte
Bytes order	1	2~3	4	5

[NOTE]

1. The reply for "Power on" command is the exception for VT2405LED-1 and VT3205LED. It's 0x322B0D (2+<CR>).
2. When PC applies command to all displays (ID=99), only the #1 set needs to reply by the name of ID=1.

Example1: Set Brightness as 76 for TV-02 and this command is valid

Send (Hex Format)

Name	Length	ID	Command Type	Command	Value1	Value2	Value3	CR
Hex	<u>0x38</u>	<u>0x30</u> <u>0x32</u>	<u>0x73</u>	<u>0x24</u>	<u>0x30</u>	<u>0x37</u>	<u>0x36</u>	<u>0x0D</u>

Reply (Hex Format)

Name	Length	ID	Command Type	CR
Hex	<u>0x34</u>	<u>0x30</u> <u>0x32</u>	<u>0x2B</u>	<u>0x0D</u>

**Example2: Set Brightness as 176 for TV-02 and this command is NOT valid.
Send (Hex Format)**

Name	Length	ID	Command Type	Command	Value1	Value2	Value3	CR
Hex	0x38	0x30 0x32	0x73	0x24	0x31	0x37	0x36	0x0D

Reply (Hex Format)

Name	Length	ID	Command Type	CR
Hex	0x34	0x30 0x32	0x2D	0x0D

Set-function table

Set Function	Length	ID	Command			Value Range (Three ASCII bytes)	Comments
			Type (ASCII)	Code (ASCII)	Code (Hex)		
Power on/off (standby)	8		s	!	21	000: STBY 001: ON	Exclude VT2405-1, and VT3205
Input Select	8		s	"	22	000 : TV 001 : AV 002 : S-Video 003 : YPbPr 004 : HDMI 014: HDMI2 024: HDMI3 034: HDMI4 005 : DVI 006 : VGA1 016: VGA2 026: VGA3 007: OPS/PC 017: Android 008: Internal memory 009: DP	1. No need for USB 2. For the case of two more same sources, the 2nd digital is used to indicate the extension. 3. Exclude VT2405-1, and VT3205.
Contrast	8		s	#	23	000 ~ 100	
Brightness	8		s	\$	24	000 ~ 100	
Sharpness	8		s	%	25	000 ~ 100	
Color	8		s	&	26	000 ~ 100	
Tint	8		s	'	27	000 ~ 100	
Color mode	8		s)	29	000: Normal 001: Warm 002: Cold 003: Personal	
Sound	8		s	-	2D	000: SRS Off 001: SRS On	(for TV)
Bass	8		s	.	2E	000 ~ 100	(for TV)
Treble	8		s	/	2F	000 ~ 100	(for TV)
Balance	8		s	0	30	000 ~ 100	(for TV) Sets Balance position
Picture Size	8		s	1	31	000 : FULL 001 : NORMAL 002 : CUSTOM 003 : DYNAMIC 004 : REAL	(for DS)

OSD language	8		s	2	32	000: English 001: French 002: Spanish	Extend the value for more supported languages
Power lock	8		s	4	34	000 : Unlock 001 : Lock	
Volume	8		s	5	35	000 ~ 100 900:Volume down (-1) 901:Volume up (+1)	
Mute	8		s	6	36	000: OFF 001: ON (mute)	
Button lock	8		s	8	38	000: Unlock 001: Lock	
PIP-Mode	8		s	9	39	000 : OFF 001: PIP 002: PBP	(for DS)
PIP-Sound select	8		s	:	3A	000: Main 001: PIP	(for DS)
PIP-Position	8		s	;	3B	000: Up 001: Down 002: Left 003: Right	(for DS)
PIP-Input	8		s	7	37	000 : TV 001 : AV 002 : S-Video 003 : YPbPr 004 : HDMI 014: HDMI2 024: HDMI3 005 : DVI 006 : VGA 007: OPS/ PC	(for DS) For the case of two more same sources, the 2nd digital is used to indicate the extension.
TV channel (DTV)	8		s	<	3C	For -0: 001~999 A00~F99 (1000~1599) For -k: 1 st and 2 nd char are same as -0 3 th char is CHAR [ASC (3 th digi) + k x 10]	(for TV) 1. Channel OSD number but not frequency number 2. For VT3255, and VT4236 only
TV channel (ATV)	8		s	=	3D	001~999	(for TV)
Menu lock	8		s	>	3E	000: Unlock 001: Lock	
Number	8		s	@	40	000~009	(for TV)
Key Pad	8		s	A	41	000: UP 001: DOWN 002: LEFT 003: RIGHT 004: ENTER 005: INPUT 006: MENU/EXIT	

Remote Control	8		s	B	42	000: Disable 001: Enable 002: Pass through	Disable: RCU has no effect on HDTV. Enabled: RCU controls the HDTV. This is the power up default on the HDTV. Pass through: RCU has no effect on HDTV and all RCU command codes are transmitted to FC via the RS232 port.
Setup wizard	8		s	C	43	000: Disable 001: Enable	(for TV) Disable: to skip the initial setup wizard
Tiling-Mode	8		s	P	50	000: OFF 001: ON	(for DS)
Tiling-Compensation	8		s	Q	51	000: OFF 001: ON	(for DS) Bezel width compensation
Tiling-H by V Monitors	8		s	R	52	01x~09x: H 0x1~0x9: V	(for DS) 1. 2 nd digital for H monitors 2. 3 rd digital for V monitors
Tiling-Position	8		s	S	53	001~025	(for DS) Copy the screen of Position# to identified display
Date	8		s	V	56	0xx: Year 1xx: Month+Day (See example in Note)	For specific models only
Time	8		s	W	57	0xx: Hour+Min 10x: Sec (See example in Note)	For specific models only
Restore default	8		s	~	7E	000	Resets HDTV to factory setting

Note:

1. Behavior at lock modes

Lock Mode	Behavior
Button Lock	<ol style="list-style-type: none"> 1. Lock all buttons of front panel and RCU, except for "Power" 2. All the SET functions should be workable via RS32, even the ones with according hot key in RCU like Mute,...etc.
MENU Lock	<ol style="list-style-type: none"> 1. Lock "MENU" key of front panel and RCU 2. The Factory and Hospitality modes should not be blocked for the model using MENU-combined key to enter these two modes. Alternative approach will be indicated separately if any limitation by model.
POWER Lock	<ol style="list-style-type: none"> 1. Lock "POWER" key of front and RCU. 2. The SET_POWER on/off should be workable via RS232, but does not mean the POWER lock will be released under this case. 3. Can not be un-locked by reset in OSD setting 4. Will auto AC power-on in power-lock 5. Under power-lock, the set will not enter power saving when no PC signal and neither not turn off when no other video signals after 15min.
Remote control disable	Lock the keys on RCU, but keep the buttons of front panel workable.

2. Example for value setting of SET_TV channel DTV

012-0: 0x 30 31 32

012-1: 0x 30 31 42

1012-2: 0x 41 31 52

1512-3: 0x 46 31 62

3. Tiling definition of H Monitors/ V Monitors/ and Position

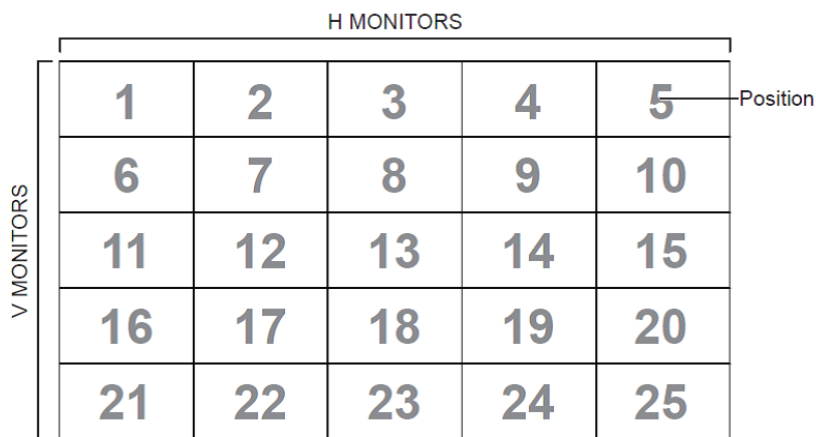

4. Date & Time format definition

	Value 1	Value 2	Value 3
Date	0: Year	Year code of the first 2 digis	Year code of the last 2 digis
	1: Month+Day	Month code	Day code
Time	0:Hour(24-hr format)+Min	Hour code	Minute code
	1: Sec	0	Second code

Hex code (in hex) = Original data (in dec) + 20

Date & Time	Code (ASCII)	Code (Hex)	Date & Time	Code (ASCII)	Code (Hex)	Date & Time	Code (ASCII)	Code (Hex)	Date & Time	Code (ASCII)	Code (Hex)
0	space	20	16	6	36	32	R	52	48	h	68
1	!	21	17	7	37	33	S	53	49	i	69
2	“	22	18	8	38	34	T	54	50	p	70
3	#	23	19	9	39	35	U	55	51	q	71
4	\$	24	20	@	40	36	V	56	52	r	72
5	%	25	21	A	41	37	W	57	53	s	73
6	&	26	22	B	42	38	X	58	54	t	74
7	'	27	23	C	43	39	Y	59	55	u	75
8	(28	24	D	44	40	`	60	56	v	76
9)	29	25	E	45	41	a	61	57	w	77
10	0	30	26	F	46	42	b	62	58	x	78
11	1	31	27	G	47	43	c	63	59	y	79
12	2	32	28	H	48	44	d	64			
13	3	33	29	I	49	45	e	65			
14	4	34	30	P	50	46	f	66			
15	5	35	31	Q	51	47	g	67			

Month: 1~12

Day: 1~31

Hour: 00~23

Min: 00~59

Sec: 00~59

5. Set Date & Time example

Date: 2015-1/31

Time: 16:27:59

Send: 0x 38 30 31 73 56 30 40 35 0D (Year “20” “15”)

Send: 0x 38 30 31 73 56 31 21 51 0D (Month “1”, Day “31”)

Send: 0x 38 30 31 73 57 30 36 47 0D (Hour “16”, Min “27”)

Send: 0x 38 30 31 73 57 31 30 79 0D (“0”, Sec “59”)

3.2 Get-Function Listing

The PC can interrogate the TV/DS for specific information. The Get-Function packet format consists of 9 bytes which is similar to the Set-Function packet structure. Note that the “Value” byte is always = 000.

Get-Function description:

- Length:** Total Byte of Message excluding “CR”
TV/DS ID: Identification for each of TV/DS (01~98; default is 01)
Command Type: Identify command type,
 “g” (0x67h) : Get Command
 “r” (0x72h) : Valid command Reply
 “-” (0x2Dh) : Invalid command Reply
Command: Function command code: One byte ASCII code
Value[1~3]: Three bytes ASCII that defines the value
CR: 0x0D

Get-Function format:

Send: (Command Type= “g”)

Name	Length	ID	Command Type	Command	Value1	Value2	Value3	CR
Byte Count	1 Byte	2 Byte	1 Byte	1 Byte	1 Byte	1 Byte	1 Byte	1 Byte
Bytes order	1	2~3	4	5	6	7	8	9

[NOTE] Get “Power STBY status” is the exception for VT2405LED-1 and VT3205LED.

Reply: (Command Type= “r” or “-”)

If the Command is valid, Command Type = “r”

Name	Length	ID	Command Type	Command	Value1	Value2	Value3	CR
Byte Count	1 Byte	2 Byte	1 Byte	1 Byte	1 Byte	1 Byte	1 Byte	1 Byte
Bytes order	1	2~3	4	5	6	7	8	9

[NOTE] The reply for “Power STBY status” command is the exception for VT2405LED-1 and V3205LED. It’s 0x36 72 6C 30 30 30 0D (6rl000<CR>).

If the Command is Not valid, Command Type= “-”

Name	Length	ID	Command Type	CR
Byte Count	1 Byte	2 Byte	1 Byte	1 Byte
Bytes order	1	2~3	4	5

**Example1: Get Brightness from TV-05 and this command is valid.
 The Brightness value is 67.**

Send (Hex Format)

Name	Length	ID	Command Type	Command	Value1	Value2	Value3	CR
Hex	<u>0x38</u>	<u>0x30</u> <u>0x35</u>	<u>0x67</u>	<u>0x62</u>	<u>0x30</u>	<u>0x30</u>	<u>0x30</u>	<u>0x0D</u>

Reply (Hex Format)

Name	Length	ID	Command Type	Command	Value1	Value2	Value3	CR
Hex	<u>0x38</u>	<u>0x30</u> <u>0x35</u>	<u>0x72</u>	<u>0x62</u>	<u>0x30</u>	<u>0x36</u>	<u>0x37</u>	<u>0x0D</u>

Example2: Get Brightness from TV-05 , but the Brightness command ID is error and it is NOT in the command table.

Send (Hex Format)

Name	Length	ID	Command Type	Command	Value1	Value2	Value3	CR
Hex	<u>0x38</u>	<u>0x30</u> <u>0x35</u>	<u>0x67</u>	<u>0XD3</u>	<u>0x30</u>	<u>0x30</u>	<u>0x30</u>	<u>0x0D</u>

Reply (Hex Format)

Name	Length	ID	Command Type	CR
Hex	<u>0x34</u>	<u>0x30</u> <u>0x35</u>	<u>0x2D</u>	<u>0x0D</u>

Get-function table

Set Function	Length	ID	Command Type	Command		Value Range (Three ASCII bytes)	Comments
				Code (ASCII)	Code (Hex)		
Get-Contrast	8		g	a	61	000 ~ 100	
Get-Brightness	8		g	b	62	000 ~ 100	
Get-Sharpness	8		g	c	63	000 ~ 100	
Get-Color	8		g	d	64	000 ~ 100	
Get-Tint	8		g	e	65	000 ~ 100	
Get-Volume	8		g	f	66	000 ~ 100	
Get-Mute	8		g	g	67	000: Off 001: On (muted)	
Get-Input select	8		g	j	6A	000~	See Set-function table
Get-Power status: ON/STBY	8		g	l	6C	001: ON 000: STBY	Exclude VT2405-1, and VT3205
Get-Remote control	8		g	n	6E	000: Disable 001: Enable 002: Pass through	Gets RCU mode status
Get-Power lock	8		g	o	6F	000: Unlock 001: Lock	
Get-Button lock	8		g	p	70	000: Unlock 001: Lock	
Get-Menu lock	8		g	q	71	000: Unlock 001: Lock	
Get-Setup wizard	8		g	s	73	000: Disable 001: Enable	(for TV)
Get-PIP mode	8		g	t	74	000 : OFF 001: PIP 002: PBP	(for DS)

Get-PIP input	8		g	u	75	000 ~	(for DS) See Set-function table
Get-Tiling Mode	8		g	v	76	000: OFF 001: ON	(for DS)
Get-Tiling Compensation	8		g	w	77	000: OFF 001: ON	(for DS) Bezel width compensation
Get-Tiling H by V monitors	8		g	x	78	01x~09x: H monitors 0x1~0x9: V monitors	(for DS) 1. 2 nd digital for H monitors 2. 3 rd digital for V monitors
Get-Tiling position	8		g	y	79	000: OFF 001~025	(for DS) Copy the screen of Position# to identified display
Get-ACK	8		g	z	7A	000	This command is used to test the communication link.
Get-Thermal	8		g	0	30	000~100: 0~+100 deg C -01~-99: -1~-99 deg C	For specific models only
Get-Power on/off log	8		g	1	31	000 (See below note)	For specific models only
Get-Date	8		g	2	32	000 (See the Set-Date command)	For specific models only
Get- Time	8		g	3	33	000 (See the Set-Time command)	For specific models only

[NOTE]

1. Power on/off log data is replied as 6 sequential strings in following order.

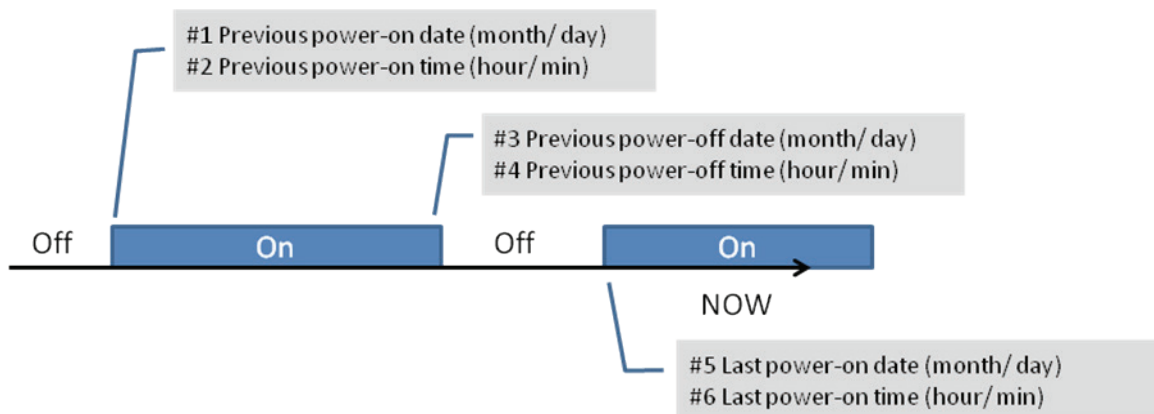

2. Time log data definition

Value 1	Value 2	Value 3
On/ Off indicator 0: Off 1: On	Month code	Day code
	Hour code	Minute code

Hex code (in hex) = Original data (in dec) + 20

Date & Time	Code (ASCII)	Code (Hex)	Date & Time	Code (ASCII)	Code (Hex)	Date & Time	Code (ASCII)	Code (Hex)	Date & Time	Code (ASCII)	Code (Hex)
0	space	20	16	6	36	32	R	52	48	h	68
1	!	21	17	7	37	33	S	53	49	i	69
2	"	22	18	8	38	34	T	54	50	p	70
3	#	23	19	9	39	35	U	55	51	q	71
4	\$	24	20	@	40	36	V	56	52	r	72
5	%	25	21	A	41	37	W	57	53	s	73
6	&	26	22	B	42	38	X	58	54	t	74
7	'	27	23	C	43	39	Y	59	55	u	75
8	(28	24	D	44	40	`	60	56	v	76
9)	29	25	E	45	41	a	61	57	w	77
10	0	30	26	F	46	42	b	62	58	x	78
11	1	31	27	G	47	43	c	63	59	y	79
12	2	32	28	H	48	44	d	64			
13	3	33	29	I	49	45	e	65			
14	4	34	30	P	50	46	f	66			
15	5	35	31	Q	51	47	g	67			

Month: 1~12

Day: 1~31

Hour: 00~23

Min: 00~59

3. Get Time log data example

Assumed the power-on/off record of display#01 as below

2014-8/31 08:00 On

2014-8/31 22:00 Off

2014-9/1 10:30 On

2014-9/1 11:00 To send "GET-Time log" command

Send: 0x 38 30 31 67 31 30 30 30 0D

Reply:

#1 0x 38 30 31 72 31 31 28 51 0D (On 8/31)

#2 0x 38 30 31 72 31 31 28 20 0D (On 08:00)

#3 0x 38 30 31 72 31 30 28 51 0D (Off 8/31)

#4 0x 38 30 31 72 31 30 42 20 0D (Off 22:00)

#5 0x 38 30 31 72 31 31 29 21 0D (On 9/1)

#6 0x 38 30 31 72 31 31 30 50 0D (On 10:30)

4. Get Date & Time example

Assumed the current date/time of display#01 as below

Date: 2015-1/31

Time: 16:27:59

Send: 0x 38 30 31 67 32 30 30 30 0D (Get Date)

Reply:

#1 0x 38 30 31 72 32 30 40 35 0D (Year "20" "15")

#2 0x 38 30 31 72 32 31 21 51 0D (Month "1", Day "31")

Send: 0x 38 30 31 67 33 30 30 30 0D (Get Time)

Reply:

#1 0x 38 30 31 72 33 30 36 47 0D (Hour "16", Min "27")

#2 0x 38 30 31 72 33 31 30 79 0D ("0", Sec "59")

3.3 Remote Control Pass-through mode

When PC sets the TV/DS to Remote Control Pass through mode, the TV/DS shall send a 7-byte packet (followed by "CR") in response to RCU button activation. Note, that in this mode the RCU shall have no effect on the TV/DS function. For example: "Volume+" will not change the volume in the LCD but only sends "Volume+" code to PC over the RS232 port.

IR Pass Through-Function format

Reply: (Command Type= "p")

Name	Length	ID	Command Type	RCU Code1 (MSB)	RCU Code2 (LSB)	CR
Byte Count	1 Byte	2 Byte	1 Byte	1 Byte	1 Byte	1 Byte
Bytes order	1	2~3	4	5	6	7

Example1: Remote Control pass-through when "VOL+" key is pressed for TV-05 Send (Hex Format)

Name	Length	ID	Command Type	RCU Code1 (MSB)	RCU Code2 (LSB)	CR
Hex	<u>0x36</u>	<u>0x30</u> <u>0x35</u>	<u>0x70</u>	<u>0x31</u>	<u>0x30</u>	<u>0x0D</u>

Key	Code (HEX)
1	01
2	02
3	03
4	04
5	05
6	06
7	07
8	08
9	09
0	0A
-	0B
RECALL (LAST)	0C
INFO (DISPLAY)	0D
	0E

ASPECT (ZOOM, SIZE)	0F
VOLUME UP (+)	10
VOLUME DOWN (-)	11
MUTE	12
CHANNEL/PAGE UP (+)/ BRIGHTNESS+	13
CHANNEL/PAGE DOWN (-)/ BRIGHTNESS-	14
POWER	15
SOURCES (INPUTS)	16
	17
	18
SLEEP	19
MENU	1A
UP	1B
DOWN	1C
LEFT (-)	1D
RIGHT (+)	1E
OK (ENTER, SET)	1F
EXIT	20
	21
	22
	23
	24
	25
	26
	27
	28
	29
	2A
	2B
RED ■ (F1)	2C
GREEN ■ (F2)	2D
YELLOW ■ (F3)	2E
BLUE ■ (F4)	2F

Note:

1. This IR-pass-through code is different with RCU key code.
2. Special control sequence for POWER key under IR-pass through mode.
 - 2-1. When display is OFF and receives the POWER code: The display will turn on itself, then forward the POWER code to the host via RS232.
 - 2-2. When display is ON and receives the POWER code: The display will forward the POWER code to the host via RS232, then turns off itself.
3. The code of VOLUME UP and VOLUME DOWN will repeatedly output when press and hold the keys.

Customer Support

For technical support or product service, see the table below or contact your reseller.
NOTE: You will need the product serial number.

Use with other Wall-Mount kit may cause instability and possibly result in injury.
 To find the perfect mount for CDE3202, please browse
www.viewsonic.com or call our service team: United States 1-800-688-6688,
 Canada 1-866-463-4775, Europe +44 (0) 207 382 8250.

Country/Region	Website	T= Telephone C = CHAT ONLINE	Email
United States	www.viewsonic.com	T (Toll-Free)= 1-800-688-6688 T (Toll)= 1-424-233-2530	service.us@viewsonic.com
Canada	www.viewsonic.com	T (Toll-Free)= 1-866-463-4775 T (Toll)= 1-424-233-2533	service.ca@viewsonic.com
Europe	www.viewsoniceurope.com	www.viewsoniceurope.com/uk/support/call-desk/	
Latin America (Argentina)	www.viewsonic.com/la/	C= http://www.viewsonic.com/la/soporte/servicio-tecnico	soporte@viewsonic.com
Latin America (Chile)	www.viewsonic.com/la/	C= http://www.viewsonic.com/la/soporte/servicio-tecnico	soporte@viewsonic.com
Latin America (Columbia)	www.viewsonic.com/la/	C= http://www.viewsonic.com/la/soporte/servicio-tecnico	soporte@viewsonic.com
Latin America (Mexico)	www.viewsonic.com/la/	C= http://www.viewsonic.com/la/soporte/servicio-tecnico	soporte@viewsonic.com
Nexus Hightech Solutions, Cincinnati #40 Desp. 1 Col. De los Deportes Mexico D.F. Tel: 55) 6547-6454 55)6547-6484 Other places please refer to http://www.viewsonic.com/la/soporte/servicio-tecnico#mexico			
Latin America (Peru)	www.viewsonic.com/la/	C= http://www.viewsonic.com/la/soporte/servicio-tecnico	soporte@viewsonic.com



ViewSonic®