



ENGLISH

Easy Setup Guide

Please read this manual carefully before operating your set and retain it for future reference.

ESPAÑOL

Guía Rápida de Configuración

Lea atentamente este manual antes de poner en marcha el equipo y consérvelo para futuras consultas.

FRANÇAIS

Guide de configuration rapide

Avant d'utiliser l'appareil, veuillez lire attentivement ce manuel et le conserver pour pouvoir vous y reporter ultérieurement.

LED TV

32LV340H

40LV340H

43LV340H

49LV340H

55LV340H

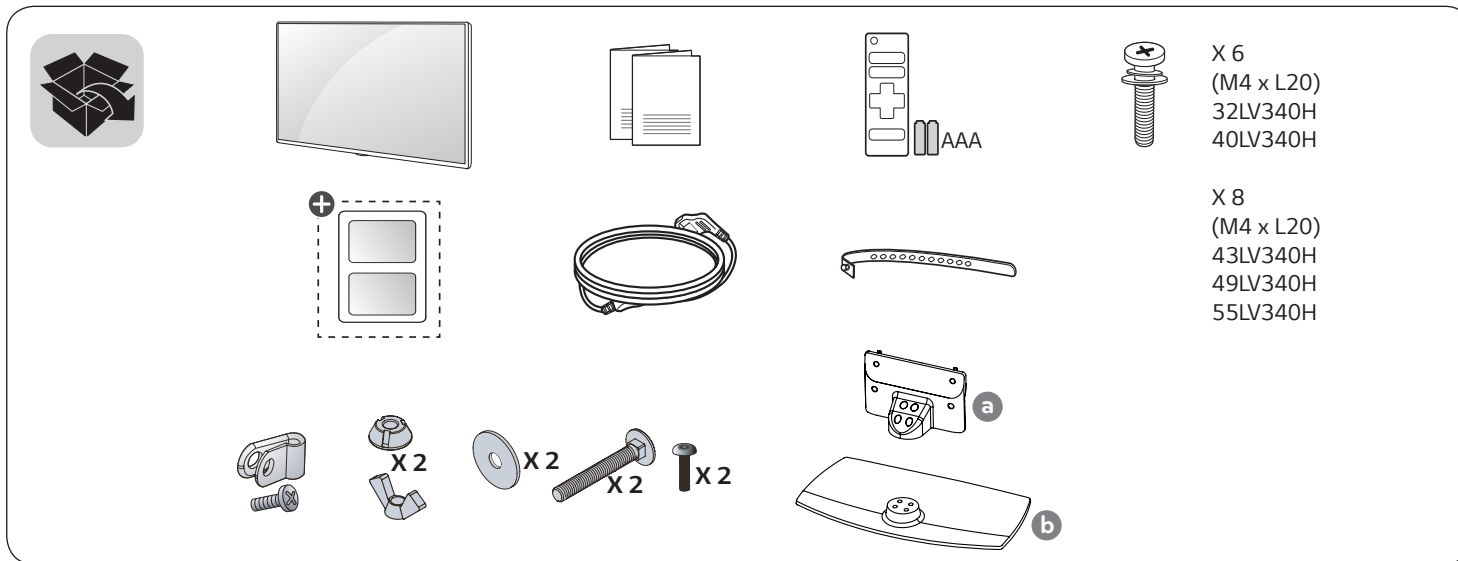

⊕ : Depending upon model / Según el modelo / Selon le modèle



www.lg.com

P/No: MFL69843827 (1703-REV00)



ENGLISH Read **Safety & Reference**.

ESPAÑOL Leer **Seguridad y Consultas**.

FRANÇAIS Lisez **Sécurité et références**.

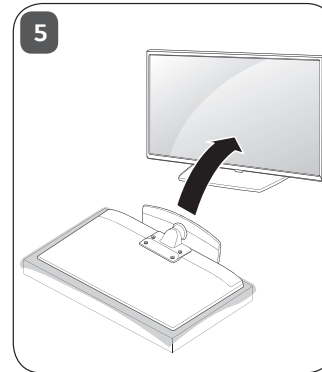
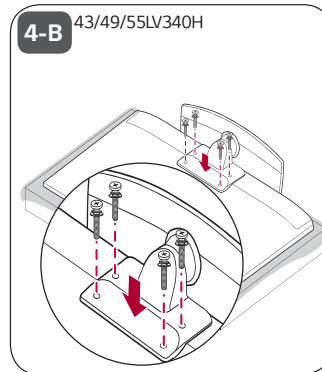
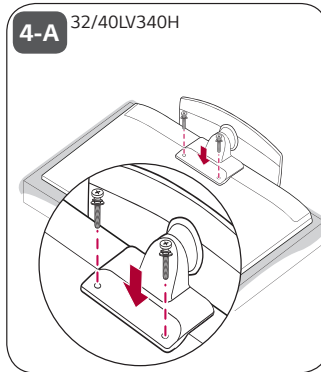
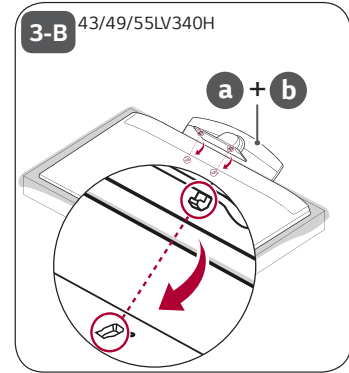
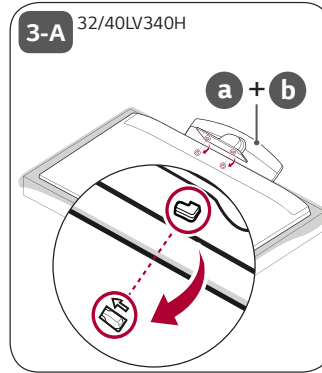
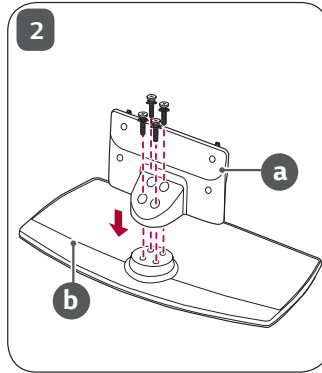
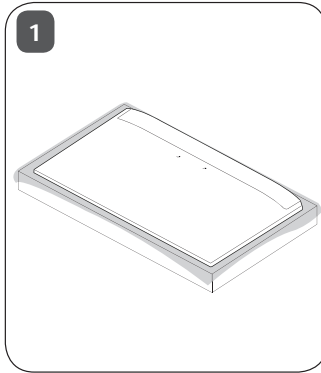

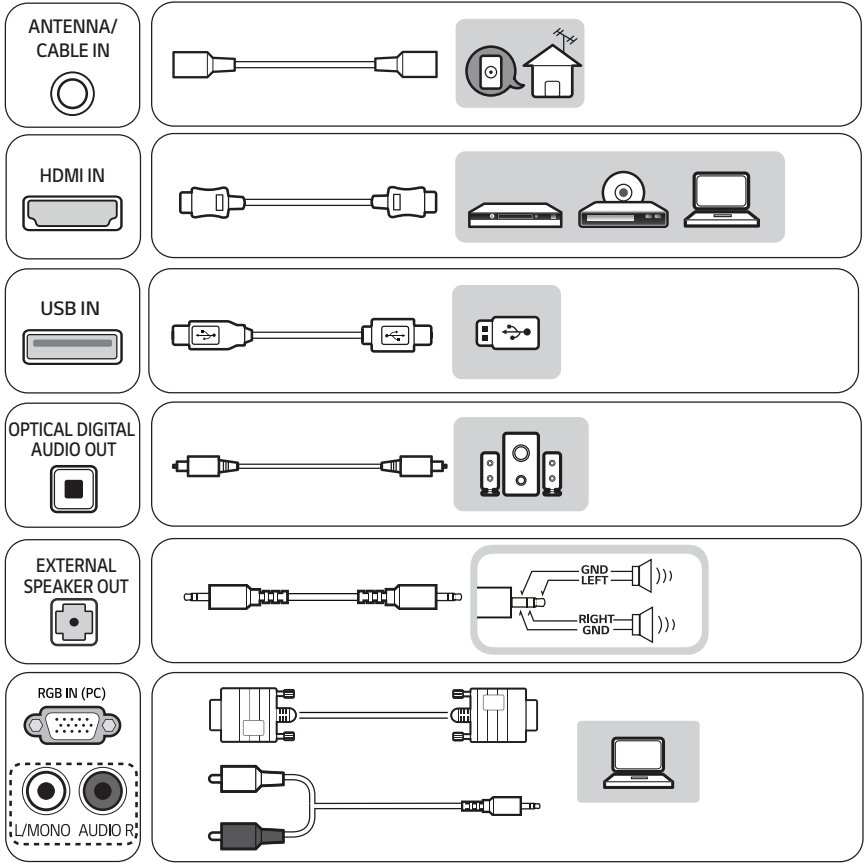
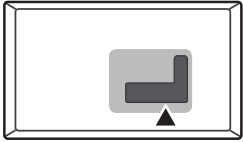

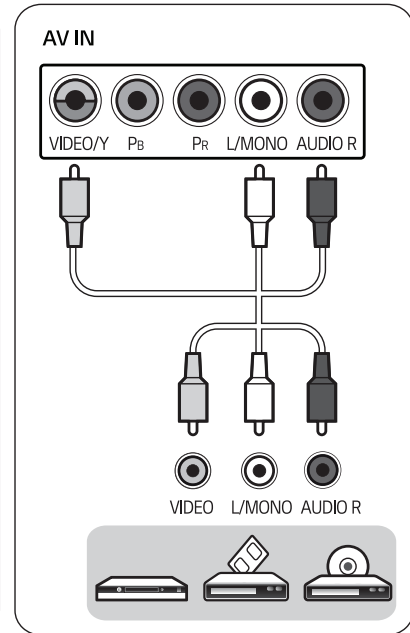
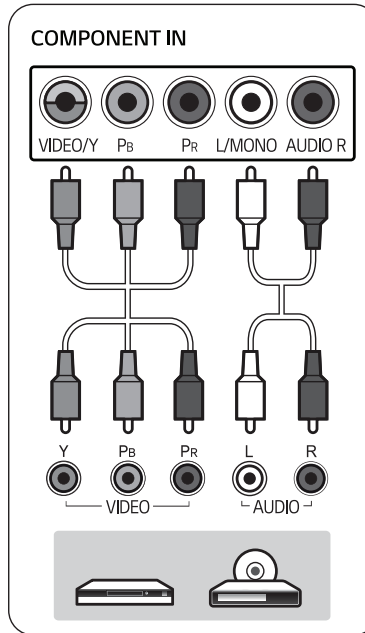
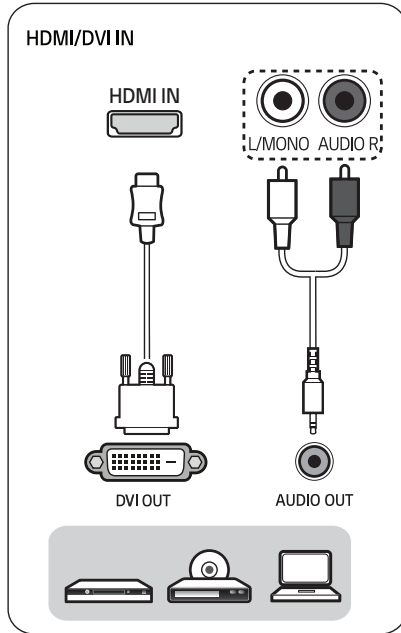
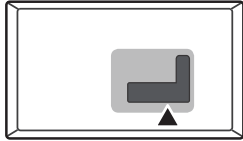

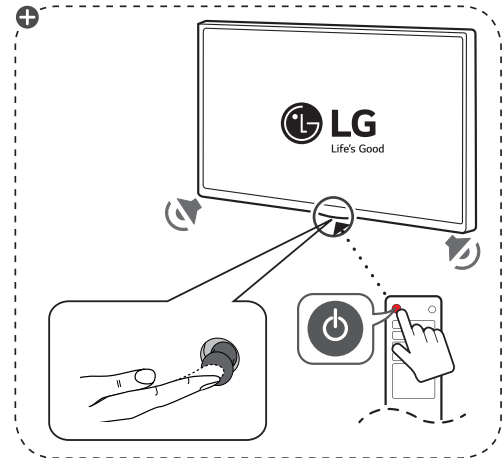
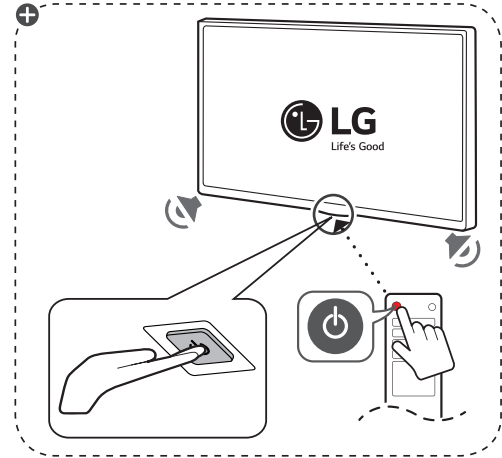
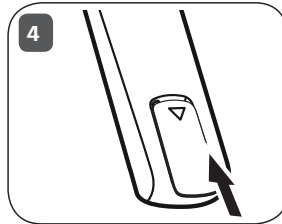
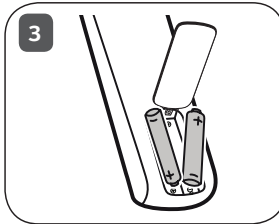
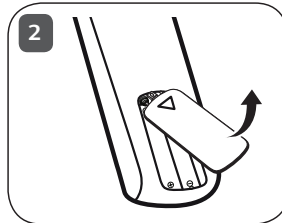
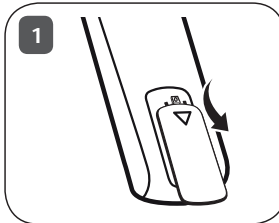
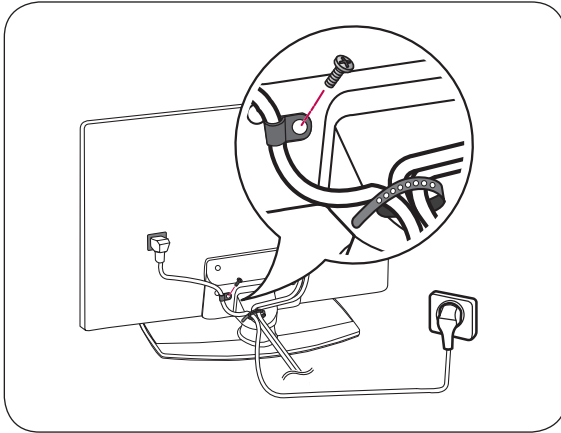

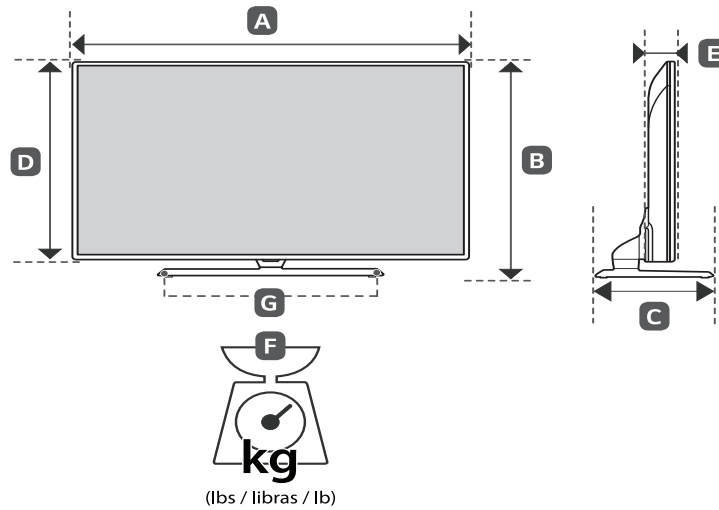

A, B, C, D, E : mm (inches/pulgadas/ po)
F, G : kg (lbs/libras/lb)

MODELS MODELOS MODÈLES	A		B		C		D		E		F		F - G		Current value / Power consumption	
															Corriente de consumo / Consumo de potencia	
															Valeur courante / Consommation électrique	
32LV340H-UA	739 (29)	739 (29)	495 (19,4)	495 (19,4)	241 (9,4)	241 (9,4)	441 (17,3)	441 (17,3)	84 (3,3)	84 (3,3)	6,05 (13,3)	6,05 (13,3)	4,85 (10,6)	4,85 (10,6)	1,0 A / 60 W	1,0 A / 60 W
40LV340H-UA	911 (35,8)	911 (35,8)	576 (22,6)	576 (22,6)	241 (9,4)	241 (9,4)	528 (20,7)	528 (20,7)	55,3 (2,1)	55,3 (2,1)	8,7 (19,1)	8,7 (19,1)	7,5 (16,5)	7,5 (16,5)	0,9 A / 90 W	0,9 A / 90 W
43LV340H-UA	974 (38,3)	974 (38,3)	625 (24,6)	625 (24,6)	303 (11,9)	303 (11,9)	571 (22,4)	571 (22,4)	79,4 (3,1)	79,4 (3,1)	12,45 (27,4)	12,45 (27,4)	9,2 (20,2)	9,2 (20,2)	0,9 A / 90 W	0,9 A / 90 W
49LV340H-UA	1,107 (43,5)	1 107 (43,5)	702 (27,6)	702 (27,6)	303 (11,9)	303 (11,9)	645 (25,3)	645 (25,3)	79,4 (3,1)	79,4 (3,1)	14,55 (32,0)	14,55 (32,0)	11,3 (24,9)	11,3 (24,9)	1,0 A / 100 W	1,0 A / 100 W
55LV340H-UA	1,241 (48,8)	1 241 (48,8)	770 (30,3)	770 (30,3)	303 (11,9)	303 (11,9)	720 (28,3)	720 (28,3)	63 (2,4)	63 (2,4)	19,5 (42,9)	19,5 (42,9)	16,3 (35,9)	16,3 (35,9)	1,25 A / 125 W	1,25 A / 125 W
Power requirement / Alimentación requerida / Alimentation									AC 100 - 240 V - 50 / 60 Hz							



(For USA and Canada only)
(Para Estados Unidos y Canadá)



This product qualifies for ENERGY STAR® in the factory default (Home configuration) setting. Changing the factory default settings or enabling other features may increase power consumption that could exceed the limits necessary to qualify for ENERGY STAR®. Refer to ENERGYSTAR.gov for more information on the ENERGY STAR® program.

(Pour les États-Unis et le Canada)



Ce produit est conforme aux normes ENERGY STAR® lorsque le « réglage d'usine par défaut (Résidentiel) » est sélectionné. Modifier les réglages d'usine par défaut ou activer d'autres fonctionnalités augmente la consommation d'énergie qui pourrait alors dépasser les limites de la qualification ENERGY STAR®. Consultez le site ENERGYSTAR.gov pour en savoir plus au sujet du programme ENERGY STAR®.



OWNER'S MANUAL

Safety and Reference

LED TV*
* LG LED TVs are LCD TVs with LED backlighting.

Please read this manual carefully before operating your TV and retain it for future reference.

32LV340H	32LV340C
40LV340H	43LV340C
43LV340H	49LV340C
49LV340H	55LV340C
55LV340H	



www.lg.com

P/NO : MFL69885512 (1702-REV00)

Warning! Important Safety instructions

Read these instructions. Keep these instructions. Heed all warnings. Follow all instructions.



CAUTION : TO REDUCE THE RISK OF ELECTRIC SHOCK DO NOT REMOVE COVER (OR BACK). NO USER SERVICEABLE PARTS INSIDE. REFER TO QUALIFIED SERVICE PERSONNEL.

 The symbol is intended to alert the user to the presence of uninsulated "dangerous voltage" within the product's enclosure that may be of sufficient magnitude to constitute a risk of electric shock to persons.

 The symbol is intended to alert the user to the presence of important operating and maintenance (servicing) instructions in the literature accompanying the device.

WARNING : TO REDUCE THE RISK OF FIRE AND ELECTRIC SHOCK, DO NOT EXPOSE THIS PRODUCT TO RAIN OR MOISTURE.

- Do not use this apparatus near water.
- Clean only with dry cloth.
- Do not block any ventilation openings. Install in accordance with the manufacturer's instructions.
- Do not install near any heat sources such as radiators, heat registers, stoves, or other apparatus (including amplifiers) that produce heat.
- Do not defeat the safety purpose of the polarized or grounding-type plug. A polarized plug has two blades with one wider than the other. A grounding type plug has two blades and a third grounding prong. The wide blade or the third prong are provided for your safety. If the provided plug does not fit into your outlet, consult an electrician for replacement of the obsolete outlet.
- Protect the power cord from being walked on or pinched particularly at plugs, convenience receptacles, and the point where they exit from the apparatus.
- Only use attachments/accessories specified by the manufacturer.

WARNING: This product contains chemicals known to the State of California to cause cancer and birth defects or other reproductive harm.

Wash hands after handling.

- Use only with the cart, stand, tripod, bracket, or table specified by the manufacturer, or sold with the apparatus. When a cart is used, use caution when moving the cart/apparatus combination to avoid injury from tip-over.



- Unplug this apparatus during lightning storms or when unused for long periods of time.
- Refer all servicing to qualified service personnel. Servicing is required when the apparatus has been damaged in any way, such as power-supply cord or plug is damaged, liquid has been spilled or objects have fallen into the apparatus, the apparatus has been exposed to rain or moisture, does not operate normally, or has been dropped.
- Do not press strongly upon the panel with a hand or a sharp object such as a nail, pencil, or pen, or make a scratch on it.
- Do not stick metal objects or any other conductive material into the power cord. Do not touch the end of the power cord while it is plugged in.
- Keep the packing anti-moisture material or vinyl packing out of the reach of children. Anti-moisture material is harmful if swallowed. If swallowed, induce vomiting and go to the nearest hospital. Additionally, vinyl packing can cause suffocation. Keep it out of the reach of children.
- Concerning the Power Cord (Can differ by country): Check the specification page of this owner's manual to be certain concerning current requirements. Do not connect too many devices to the same AC power outlet as this could result in fire or electric shock. Do not overload wall outlets. Overloaded wall outlets, loose or damaged wall outlets, extension cords, frayed power cords, or damaged or cracked wire insulation are dangerous. Any of these conditions could result in electric shock or fire. Periodically examine the cord of your device, and if its appearance indicates damage or deterioration, unplug it, discontinue use of the device, and have the cord replaced with an exact replacement part by an authorized servicer.

- Protect the power cord from physical or mechanical abuse, such as being twisted, kinked, pinched, closed in a door, or walked upon. Pay particular attention to plugs, wall outlets, and the point where the cord exits the device. Do not move the TV with the power cord plugged in. Do not use a damaged or loose power cord. Be sure to grasp the plug when unplugging the power cord. Do not pull on the power cord to unplug the TV.
- To reduce the risk of fire or electrical shock, do not expose this product to rain, moisture or other liquids. Do not touch the TV with wet hands. Do not install this product near flammable objects such as gasoline or candles, or expose the TV to direct air conditioning.
- Do not use high voltage electrical equipment near the TV (e.g., a bug zapper). This may result in product malfunction.
- Do not expose to dripping or splashing and do not place objects filled with liquids, such as vases, cups, etc. on or over the apparatus (e.g., on shelves above the unit).
- **Grounding**
(Except for devices which are not grounded.) Ensure that you connect the earth ground wire to prevent possible electric shock (i.e., a TV with a three-prong grounded AC plug must be connected to a three-prong grounded AC outlet). If grounding methods are not possible, have a qualified electrician install a separate circuit breaker. Do not try to ground the unit by connecting it to telephone wires, lightning rods, or gas pipes.
- As long as this unit is connected to the AC wall outlet, it is not disconnected from the AC power source even if the unit is turned off.
- Do not attempt to modify this product in any way without written authorization from LG Electronics. Unauthorized modification could void the user's authority to operate this product.
- **Outdoor Antenna Grounding**
(Can differ by country):
If an outdoor antenna is installed, follow the precautions below. An outdoor antenna system should not be located in the vicinity of overhead power lines or other electric light or power circuits, or where it can come in contact with such power lines or circuits as death or serious injury can occur. Be sure the antenna system is grounded to provide some protection against voltage surges and built-up static charges. Section 810 of the National Electrical Code (NEC) in the U.S.A. provides information with respect to proper grounding of the mast and supporting structure, grounding of the lead-in wire to an antenna discharge unit, size of grounding conductors, location of antenna discharge unit, connection to grounding electrodes and requirements for the grounding electrode.
Antenna grounding according to the National Electrical Code, ANSI/NFPA 70
- **Moving**
Make sure the product is turned off, unplugged, and all cables have been removed. It may take 2 or more people to carry larger TVs. Do not press or put stress on the front panel of the TV.
- **Ventilation**
Install your TV where there is proper ventilation. Do not install in a confined space such as a bookcase. Do not cover the product with cloth or other materials while plugged. Do not install in excessively dusty places.
- Take care not to touch the ventilation openings. When watching the TV for a long period, the ventilation openings may become hot. This does not affect the performance of the product or cause defects in the product.
- If you smell smoke or other odors coming from the TV, unplug the power cord and contact an authorized service center.
- If water or another substance enters the product (like an AC adapter, power cord, or TV), disconnect the power cord and contact the service center immediately. Otherwise, this may result in fire or electric shock.

- Do not install this product on a wall if it could be exposed to oil or oil mist. This may damage the product and cause it to fall.
- Use only an authorized AC adapter and power cord approved by LG Electronics. Otherwise, this may result in fire, electric shock, malfunction, or product deformation.
- Never disassemble the AC adapter or power cord. This may result in fire or electric shock.
- Handle the adapter carefully to avoid dropping or striking it. An impact could damage the adapter.
- Keep the product away from direct sunlight.
- Never touch this apparatus or antenna during a lightning storm.
- When mounting a TV on the wall, make sure not to install the TV by hanging the power and signal cables on the back of the TV.
- Do not allow an impact shock, any objects to fall into the product, and do not drop anything onto the screen.

• DISCONNECTING THE DEVICE FROM THE MAIN POWER

The power plug is the disconnecting device. In case of an emergency, the power plug must remain readily accessible.

- Make sure the power cord is connected securely to the power plug on the TV.
- **Batteries**
Store the accessories (battery, etc.) in a safe location out of the reach of children.
- This apparatus uses batteries. In your community there might be regulations that require you to dispose of these batteries properly due to environmental considerations. Please contact your local authorities for disposal or recycling information.
- Do not dispose of batteries in a fire.
- Do not short circuit, disassemble, or allow the batteries to overheat.
- **Cleaning**
When cleaning, unplug the power cord and wipe gently with a soft cloth to prevent scratching. Do not spray water or other liquids directly on the TV as electric shock may occur. Do not clean with chemicals such as alcohol, thinners, or benzene.

Preparing

- Image shown may differ from your TV.
- Your TV's OSD (On Screen Display) may differ slightly from that shown in this manual.
- The available menus and options may differ from the input source or product model that you are using.
- New features may be added to this TV in the future.
- The items supplied with your product may vary depending upon the model.
- Product specifications or contents of this manual may be changed without prior notice due to upgrade of product functions.
- For an optimal connection, HDMI cables and USB devices should have bezels less than 10 mm (0.39 inches) thick and 18 mm (0.7 inches) width.
- Use an extension cable that supports USB 2.0 if the USB cable or USB flash drive does not fit into your TV's USB port.
- Use a certified cable with the HDMI logo attached. If you do not use a certified HDMI cable, the screen may not display or a connection error may occur.
- Recommended HDMI cable types
 - High-Speed HDMI®/™ cable
 - High-Speed HDMI®/™ cable with Ethernet

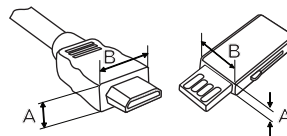

*A ≤ 10 mm (0.39 inches)

*B ≤ 18 mm (0.7 inches)

- Do not use any unapproved items to ensure the safety and lifespan of the product.
- Any damages or injuries by using unapproved items are not covered by the warranty.
- Some models appear to have a thin film on the screen. It is actually part of the screen; do not remove it.
- When attaching the stand to the TV set, place the screen facing down on a cushioned table or flat surface to protect the screen from scratches.
- Make sure that the screws are fastened tightly. (If they are not fastened securely enough, the TV may tilt forward after being installed.)
- Do not fasten the screws with excessive force otherwise they may be worn out and become loose.

Warning when using USB storage devices

- USB storage devices with a built-in auto recognition program or its own driver may not work.
- Some USB storage devices may not work or may work improperly.
- Use only those USB storage devices formatted with FAT32 or NTFS File System provided by Windows.
- For external USB HDD, use devices with less than 5V-rated voltages and 500 mA-rated current.
- It is recommended to use USB flash drive with 32 GB or less and USB HDD with 2 TB or less.
- If a USB HDD with power-saving function does not work properly, turn the power off and on. For more information, refer to the user manual of USB HDD.
- Data in the USB storage device can be damaged so back up important files in other devices. Data maintenance is the user's responsibility. The manufacturer is not responsible for data loss.

Lifting and Moving the TV

When moving or lifting the TV, read the following to prevent the TV from being scratched or damaged and for safe transportation regardless of its type and size.

- It is recommended to move the TV in the box or packing material that the TV originally came in.
- Before moving or lifting the TV, disconnect the power cord and all cables.

- When holding the TV, the screen should face away from you to avoid damage.



- Hold the top and bottom of the TV frame firmly. Make sure not to hold the transparent part, speaker, or speaker grille area.

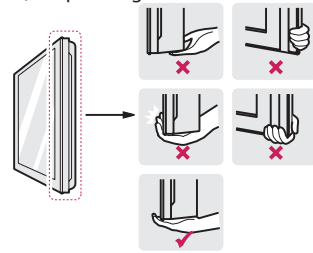

- Use at least two people to move a large TV.
- When transporting the TV by hand, hold the TV as shown in the following illustration.

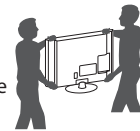

- When transporting the TV, do not expose the TV to jolts or excessive vibration.
- When transporting the TV, keep the TV upright; never turn the TV on its side or tilt towards the left or right.
- When handling the TV, be careful not to damage the protruding buttons.



- Avoid touching the screen at all times, as this may result in damage to the screen.
- Do not place the product on the floor with its front facing down without padding. Failure to do so may result in damage to the screen.
- Do not move the TV by holding the cable holders, as the cable holders may break, and injuries and damage to the TV may occur. (Depending upon model)

Using the Button

(Depending upon model)

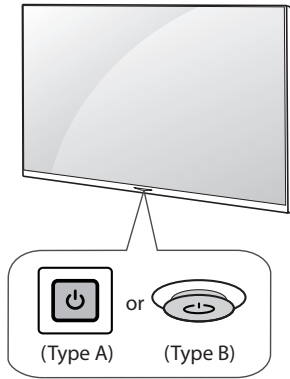

Basic Functions

(Type A)

	Power On (Press) Power Off (Press and Hold)
--	--

(Type B)

	Power On (Press) Power Off (Press and Hold)
	Volume Control
	Channels Control

Adjusting the Menu

When the TV is turned on, press the button one time. You can adjust the menu items pressing or moving the buttons. (Depending upon model)

	Turns the power off.
	Accesses the setting menu.
	Clears on-screen displays and returns to TV viewing.
	Changes the input source.

Mounting on a Table

(Depending upon model)

- 1 Lift and tilt the TV into its upright position on a table.
 - Leave a 10 cm (4 inches) (minimum) space from the wall for proper ventilation.

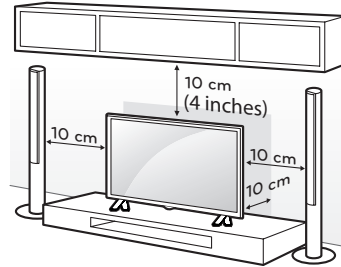

- 2 Connect the power cord to a wall outlet.



- Do not place the TV near or on sources of heat, as this may result in fire or other damage.
- Do not apply foreign substances (oils, lubricants, etc.) to the screw parts when assembling the product. (Doing so may damage the product.)

Attaching the TV to a desk (If mounting the TV on a table, make sure it is installed according to the method outlined in 'Attaching the TV to a desk'.)

(Depending upon model)
The TV should be attached to a desk so it cannot be pulled in a forward/backward direction, potentially causing injury or damaging the product.

[TYPE 1-1]

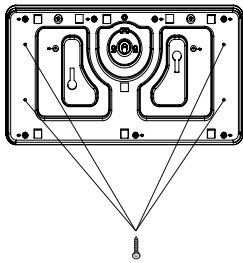

4-Screws
(Not provided as parts of the product.)

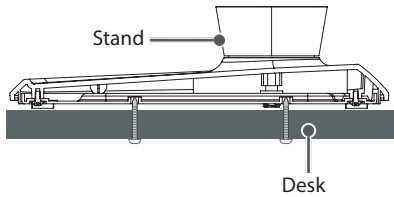

[TYPE 1-2]

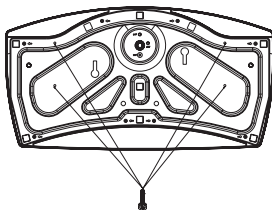

4-Screws
(Not provided as parts of the product.)

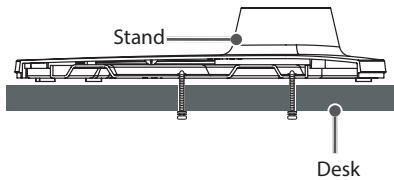

[TYPE 1-3]

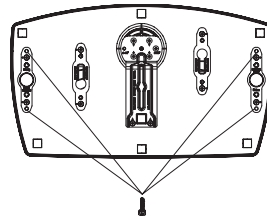

4-Screws
(Not provided as parts of the product.)

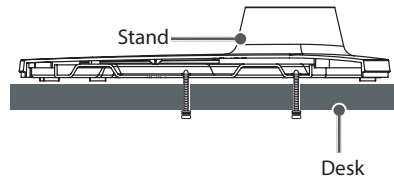

NOTE

- Screw: M5 x L (*L: Table depth + 8~10 mm)
ex) Table depth: 15 mm, Screw: M5 x L25

[TYPE 2-1]

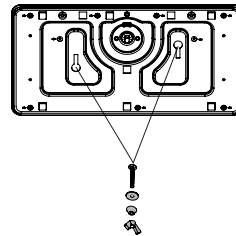

2-Screws, 2-Washers, 2-Nuts
(provided as parts of the product.)

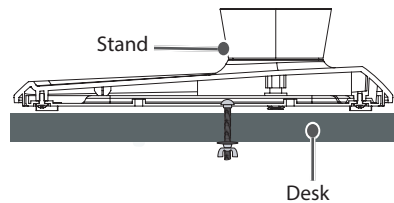

[TYPE 2-2]

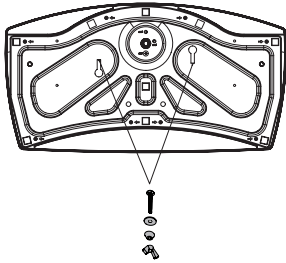

2-Screws, 2-Washers, 2-Nuts
(provided as parts of the product.)

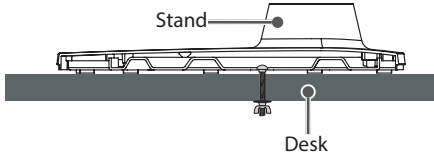

[TYPE 2-3]

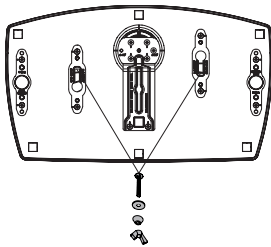

2-Screws, 2-Washers, 2-Nuts
(provided as parts of the product.)

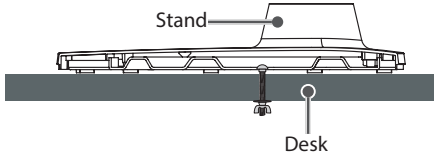

Using the Kensington Security System (optional)

(Depending upon model)

The Kensington security system connector is located at the rear of the TV. For more information of installation and using, refer to the manual provided with the Kensington security system or visit <http://www.kensington.com>. Connect the Kensington security system cable between the TV and a table.

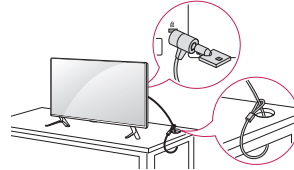

- The Kensington security system is optional. You can obtain additional accessories from your local dealer.

Securing the TV to a Wall (optional)

(Depending upon model)

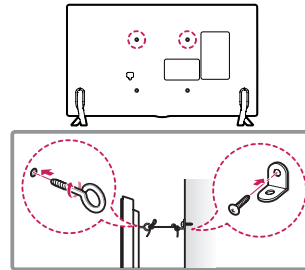

- 1 Insert and tighten the eye-bolts or TV brackets and bolts on the back of the TV.
 - If there are bolts inserted at the eye-bolts position, remove the bolts first.
- 2 Mount the wall brackets with the bolts to the wall. Match the location of the wall bracket and the eye-bolts on the rear of the TV.
- 3 Connect the eye-bolts and wall brackets tightly with a sturdy rope or cable. Make sure to keep the rope parallel to the flat surface.



- Make sure that children do not climb on or hang on the TV.
- Use a platform or cabinet that is strong and large enough to support the TV securely.
- Brackets, bolts, and ropes are optional. You can obtain additional accessories from your local dealer.

Mounting on a Wall

An optional wall mount can be used with your LG Television. Consult with your local dealer for a wall mount that supports the VESA standard used by your TV model. Carefully attach the wall mount bracket at the rear of the TV. Install the wall mount bracket on a solid wall perpendicular to the floor. If you are attaching the TV to other building materials, please contact qualified personnel to install the wall mount. Detailed instructions will be included with the wall mount. We recommend that you use an LG brand wall mount. The LG wall mount is easy to adjust or to connect the cables. When you do not use LG's wall mount bracket, use a wall mount bracket where the device is adequately secured to the wall with enough space to allow connectivity to external devices. If you are using a non-adjustable mount, attach the mount to the wall. Attach the cables to the TV first, then attach the TV to the mount.

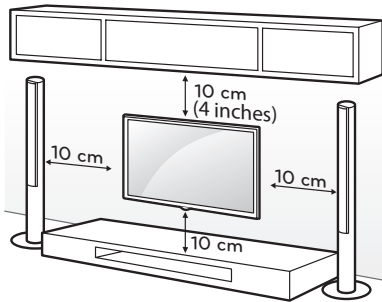

Make sure to use screws and wall mounts that meet the VESA standard. Standard dimensions for the wall mount kits are described in the following table.

Model	32LV340H 40LV340H 43LV340H	49LV340H 55LV340H
	32LV340C 43LV340C	49LV340C 55LV340C
VESA (A x B)	200 x 200	300 x 300
Standard screw	M6	M6
Number of screws	4	4
Wall mount bracket (optional)	LSW240B MSW240	LSW350B MSW240

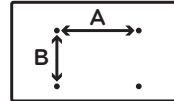

- ⚠ Remove the stand before installing the TV on a wall mount by performing the stand attachment in reverse.
- When using the wall mount, it is recommended that you apply a piece of tape over the Stand holes to prevent dust and bugs from entering the holes. (Depending on model)

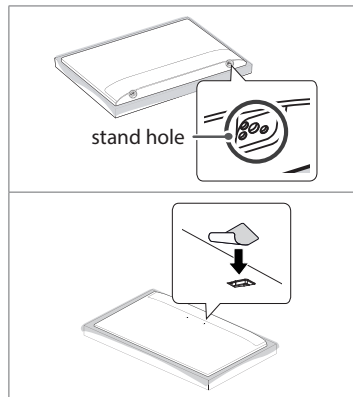

Connections (Notifications)

You can connect various external devices to the TV. Supported external devices are: HD receivers, DVD players, VCRs, audio systems, USB storage devices, PC, gaming devices, and other external devices. For more information on external device's connection, refer to the manual provided with each device.

- If you record a TV program on a DVD recorder or VCR, make sure to connect the TV signal input cable to the TV through a DVD recorder or VCR. For more information about recording, refer to the manual provided with the connected device.
- The external device connections shown may differ slightly from illustrations in a manual.
- Connect external devices to the TV regardless about the order of the TV port.
- If you connect a gaming device to the TV, use the cable supplied with the gaming device.
- Refer to the external equipment's manual for operating instructions.
- The TV may be capable of operating without a set-top-box from a multichannel video programming distributor (MVPD).

Connecting to an Antenna or Cable

Connect an antenna, cable, or cable box to watch TV while referring to the following. The illustrations may differ from the actual items and an RF cable is optional.

- Make sure not to bend the copper wire of the RF cable.

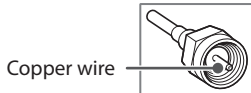

- Complete all connections between devices, and then connect the power cord to the power outlet to prevent damage to your TV.
- Use a signal splitter to use 2 TVs or more.
- DTV Audio Supported Codec: MPEG, Dolby Digital.

Other Connections

Connect your TV to external devices. For the best picture and audio quality, connect the external device and the TV with the HDMI cable.

- Use only with the 3-pole 3.5 mm Stereo Jack.
- Do not connect your headphones or earphones to the port for connecting an external speaker.

Remote Control

(Some buttons and services may not be provided depending on models or regions.)

The descriptions in this manual are based on the buttons on the remote control. Please read this manual carefully and use the TV correctly. To install batteries, open the battery cover, replace batteries (1.5 V AAA) matching the ⊕ and ⊖ ends to the label inside the compartment, and close the battery cover. Failure to match the correct polarities of the batteries may cause the battery to burst or leak, resulting in fire, personal injury, or ambient pollution. To remove the batteries, perform the installation actions in reverse. This remote uses infrared light. When in use, it should be pointed in the direction of the TV's remote sensor.

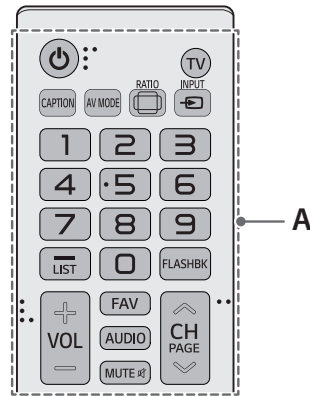

A

Power Turns the TV on or off.

TV Returns to the last TV channel.

CAPTION Activates or deactivates the subtitles.

AV MODE Selects an AV mode.

RATIO Resizes an image.

INPUT Changes the input source.

Number button Enters numbers.

(Dash) Inserts a dash between numbers such as 2-1 and 2-2.

LIST Accesses the saved channel list.

FLASHBK Alternates between the two last channels selected (pressing repeatedly).

+ VOL - Adjusts the volume level.

FAV Accesses your favorite channel list.

AUDIO Digital signal: Changes the audio language.
Analog signal: Changes the MTS sound.

MUTE Mutes all sounds.

CH Scrolls through the saved channels.

PAGE Moves to the previous or next screen

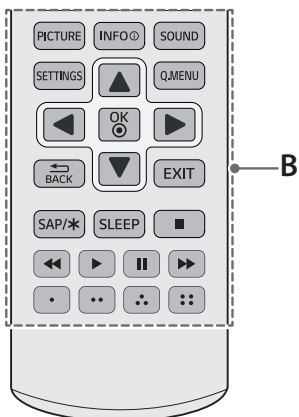

B

PICTURE Changes the picture mode.

INFO Shows information on the current program.

SOUND Changes the sound mode.

SETTINGS Accesses the setting menu.

Q.MENU Accesses the quick menu.

Navigation button (up / down / left / right)
Scrolls through menus or options.

OK Selects menus or options and confirms your input.

BACK Returns to the previous screen.

EXIT Clears all on-screen displays and returns to TV viewing.

SAP/* Enables SAP (Secondary Audio Program) Feature.

SLEEP Sets the length of time until the TV to turns off.

Media buttons Control buttons for media contents

Special function buttons These access special functions in some menus.

To select Picture Mode

SETTINGS ➔ **PICTURE** ➔ **Picture Mode**

Select the picture mode optimized for the viewing environment or the program.

- **Vivid** Heightens contrast, brightness, and sharpness to display vivid images.
- **Standard** Displays images in standard levels of contrast, brightness and sharpness.
- **APS** APS (Auto power saving) mode reduces power consumption by dimming control.
- **Cinema / Sport / Game** Displays the optimum picture for movie, sport, or game.
- **Expert** Menu for adjusting picture quality that allows experts and amateurs to enjoy the best TV viewing. This menu for adjustment is provided for ISF-certified picture tuning professionals. (ISF logo can be used only on ISF-certified TVs.)
ISFccc : Imaging Science Foundation Certified Calibration Control (Depending upon model)
- Depending upon the input signal, the available range of picture modes may differ.
- **Expert** mode is for picture tuning professionals to control and fine-tune using a specific image. For normal images, the effects may not be drastic.

To Use Energy Saving Feature

[Depending upon model]

SETTINGS ➔ **PICTURE** ➔ **Energy Saving**

- **Auto** The TV sensor detects the ambient lighting and automatically adjusts the screen brightness.
- Reduces power consumption by adjusting peak screen brightness.
- **Off** Turns off the Energy Saving.
- **Minimum / Medium / Maximum** Applies the pre-set Energy Saving.
- **Screen Off** Screen is turned off and only sound is played. Press any button on the remote control to turn the screen back on.

To set Motion Eye Care

[Depending upon model]

SETTINGS ➔ **PICTURE** ➔ **Picture Mode** ➔ **Picture Option**

- **Motion Eye Care** Automatically adjusts brightness and reduces image blur based on image data to reduce eyestrain.

Licenses

Supported licenses may differ by model.
For more information about licenses,
visit www.lg.com.



Manufactured under license from Dolby Laboratories. Dolby, Dolby Vision, Dolby Audio, and the double-D symbol are trademarks of Dolby Laboratories.



The terms HDMI and HDMI High-Definition Multimedia Interface, and the HDMI logo are trademarks or registered trademarks of HDMI Licensing LLC in the United States and other countries.

ENGLISH



This DivX Certified® device has passed rigorous testing to ensure it plays DivX® video.

To play purchased DivX movies, first register your device at vod.divx.com. Find your registration code in the DivX VOD section of your device setup menu.

DivX Certified® to play DivX® video up to HD 1080p, including premium content.

DivX®, DivX Certified® and associated logos are trademarks of DivX, LLC and are used under license.

Covered by DivX Patents 7,295,673; 7,515,710; RE45,052; and others available at [www.divx.com/patents]



(Depending upon model)

Open Source Software Notice Information

To obtain the source code under GPL, LGPL, MPL, and other open source licenses, that is contained in this product, please visit <http://opensource.lge.com>. In addition to the source code, all referred license terms, warranty disclaimers and copyright notices are available for download.

LG Electronics will also provide open source code to you on CD-ROM for a charge covering the cost of performing such distribution (such as the cost of media, shipping, and handling) upon email request to opensource@lge.com. This offer is valid for three (3) years from the date on which you purchased the product.

Troubleshooting

- Cannot control the TV with the remote control.
 - Check if anything such as tape has been placed over the receiver.
 - Check if there is any obstacle between the product and the remote control.
 - Replace the batteries with new fresh ones.
- No image display and no sound is produced.
 - Check if the product is turned on.
 - Check if the power cord is connected to a wall outlet.
 - Check if there is a problem in the wall outlet by connecting other products.
- The TV turns off suddenly.
 - Check the power control settings.
The power supply may be interrupted.
 - Check if the **Off Time / Sleep Timer** feature is activated in the **TIME** settings.
 - If there is no signal while the TV is on, the TV will turn off automatically after 15 minutes of inactivity.
- **Abnormal Display**
 - If the TV feels cold to the touch, there may be a small flicker when it is turned on. This is normal; there is nothing wrong with TV. Some minute dot defects may be visible on the screen, appearing as tiny red, green, or blue spots. However, they have no adverse effect on the TV's performance. Avoid touching the LCD screen or holding your finger(s) against it for long periods of time. Doing so may produce some temporary distortion effects on the screen.
 - This panel is an advanced product that contains millions of pixels. In a very few cases, you could see fine dots on the screen while you're viewing the TV. Those dots are deactivated pixels and do not affect the performance and reliability of the TV.
 - Displaying a still image for a prolonged period of time may cause an image sticking. Avoid displaying a fixed image on the TV screen for an extended length of time.
- **Generated Sound**
 - **Cracking noise** A cracking noise that occurs when watching or turning off the TV is generated by plastic thermal contraction due to temperature and humidity. This noise is common for products where thermal deformation is required.
 - **Electrical circuit humming/panel buzzing** A low level noise is generated from a high-speed switching circuit, which supplies a large amount of current to operate a product. It varies depending upon the product. This generated sound does not affect the performance and reliability of the product.

Specifications

Product specifications may be changed without prior notice due to upgrade of product functions.

Television System

ATSC, NTSC-M, 64 & 256 QAM

Program Coverage

VHF 2-13, UHF 14-69, DTV 2-69, CATV 1-135, CADTV 1-135

External Antenna Impedance

75 Ω

Environment condition

- **Operating Temperature**
0 °C to 40 °C (32 °F to 104 °F)
- **Operating Humidity**
Less than 80 %
- **Storage Temperature**
-20 °C to 60 °C (-4 °F to 140 °F)
- **Storage Humidity**
Less than 85 %

RGB(PC), HDMI (PC) supported mode

(Use HDMI IN 1 for PC mode)

Resolution	Horizontal Frequency (kHz)	Vertical Frequency (Hz)
640 x 350	31.46	70.09
720 x 400	31.46	70.08
640 x 480	31.46	59.94
800 x 600	37.87	60.31
1024 x 768	48.36	60.00
1360 x 768	47.71	60.01
1152 x 864	54.34	60.05
1280 x 1024	63.98	60.02
1920 x 1080	67.50	60.00

- For 40/43/49/55LV340H, 43/49/55LV340C

HDMI (DTV) supported mode

Resolution	Horizontal Frequency (kHz)	Vertical Frequency (Hz)
640 x 480p	31.46	59.94
	31.50	60.00
720 x 480p	31.47	59.94
	31.50	60.00
1280 x 720p	44.96	59.94
	45.00	60.00
1920 x 1080i	33.72	59.94
	33.75	60.00
1920 x 1080p	26.97	23.97
	27.00	24.00
	33.71	29.97
	33.75	30.00
	67.43	59.94
	67.50	60.00

Component port connecting information

Component ports on the TV	Y	P _B	P _R
---------------------------	---	----------------	----------------

Video output ports on DVD player	Y	P _B	P _R
	Y	B-Y	R-Y
	Y	Cb	Cr
	Y	Pb	Pr

Component supported mode

Resolution	Horizontal Frequency (kHz)	Vertical Frequency (Hz)
720 x 480i	15.73	59.94
	15.73	60.00
720 x 480p	31.47	59.94
	31.50	60.00
1280 x 720p	44.96	59.94
	45.00	60.00
1920 x 1080i	33.72	59.94
	33.75	60.00
1920 x 1080p	26.97	23.976
	27.00	24.00
	33.71	29.97
	33.75	30.00
	67.432	59.94
	67.50	60.00

Supported Video Formats

- Maximum: 1920 x 1080 @ 30p (only Motion JPEG 640 x 480 @ 30p)
- .asf, .wmv
[Video] MPEG-2, MPEG-4 Part2, XViD, H.264/AVC, VC1(WMV3, WVC1), MP4
[Audio] WMA Standard, WMA9(Pro), MP3, AAC, AC3
- .divx, .avi
[Video] MPEG-2, MPEG-4 Part2, DivX3.11, DivX4, DivX5, DivX6, XViD, H.264/AVC
[Audio] HE-AAC, LPCM, ADPCM, MPEG-1 Layer I, MPEG-1 Layer II, Dolby Digital, MPEG-1 Layer III (MP3), *DTS
- .ts, .trp, .tp, .mts, .m2ts
[Video] H.264/AVC, MPEG-2, AVS, VC1
[Audio] MPEG-1 Layer I, MPEG-1 Layer II, MPEG-1 Layer III (MP3), Dolby Digital, Dolby Digital Plus, AAC, HE-AAC, *DTS
- .vob
[Video] MPEG-1, MPEG-2
[Audio] Dolby Digital, MPEG-1 Layer I, MPEG-1 Layer II, DVD-LPCM
- .mp4, .m4v, .mov
[Video] MPEG-2, MPEG-4 Part2, DivX3.11, DivX4, DivX5, DivX6, XViD, H.264/AVC
[Audio] AAC, MPEG-1 Layer III (MP3), *DTS
- .mkv
[Video] MPEG-2, MPEG-4 Part2, XViD, H.264/AVC
[Audio] HE-AAC, Dolby Digital, MPEG-1 Layer III (MP3), *DTS, LPCM
- motion JPEG
[Video] MJPEG
[Audio] LPCM, ADPCM
- .mpg, .mpeg, .mpe
[Video] MPEG-1, MPEG-2
[Audio] MPEG-1 Layer I, MPEG-1 Layer II, Dolby Digital, LPCM
- .dat
[Video] MPEG-1, MPEG-2
[Audio] MP2
- .flv
[Video] Sorenson H.263, H.264/AVC
[Audio] MP3, AAC, HE-AAC
- .3gp, .3gp2
[Video] H.264/AVC, MPEG-4 Part2
[Audio] AAC, AMR(NB/WB)

*DTS: Depending upon model

Supported Audio Formats

- File type : mp3
[Bit rate] 32 Kbps - 320 Kbps
[Sample freq.] 16 kHz - 48 kHz
[Support] MPEG1, MPEG2, Layer2, Layer3
- File Type : AAC
[Bit rate] Free Format
[Sample freq.] 8 kHz ~ 48 kHz
- File Type : M4A
[Bit rate] Free Format
[Sample freq.] 8 kHz ~ 48 kHz
[Support] MPEG-4
- File Type : WMA
[Bit rate] 128 Kbps ~ 320 Kbps
[Sample freq.] 8 kHz ~ 48 kHz
[Support] WMA7, WMA8, WMA9 Standard
- File Type : WMA 10 Pro
[Bit rate] ~ 768 Kbps
[Channel / Sample freq.]
M0 : up to 2 Channel @ 48 kHz
(Except LBR mode),
M1 : up to 5.1 Channel @ 48 kHz,
M2 : up to 5.1 Channel @ 96 kHz
[Support] WMA 10 Pro
- File Type : OGG
[Bit rate] Free Format
[Sample freq.] ~ 48 kHz
[Support] OGG Vorbis

Supported Photo Formats

- Category : 2D (jpeg, jpg, jpe)
[Available file type]
SOF0 : Baseline
SOF1 : Extend Sequential
SOF2 : Progressive
[Photo size]
Minimum : 64 x 64
Maximum : Normal Type : 15,360 (W) x 8,640 (H),
Progressive Type : 1,920 (W) x 1,440 (H)
- Category : BMP
[Photo size]
Minimum : 64 x 64
Maximum : 9,600 x 6,400
- Category : PNG
[Available file type] Interlace, Non-Interlace
[Photo size]
- Minimum : 64 x 64
- Maximum : Interlace : 1,200 x 800,
Non-Interlace : 9,600 x 6,400
- BMP and PNG format files may be slower to display than JPEG.
- Non-standard photo/image file may not be displayed.

Regulatory

FCC NOTICE

(For USA)

This equipment has been tested and found to comply with the limits for a Class B digital device, pursuant to Part 15 of the FCC Rules. These limits are designed to provide reasonable protection against harmful interference in a residential installation. This equipment generates, uses and can radiate radio frequency energy and, if not installed and used in accordance with the instructions, may cause harmful interference to radio communications. However, there is no guarantee that interference will not occur in a particular installation. If this equipment does cause harmful interference to radio or television reception, which can be determined by turning the equipment off and on, the user is encouraged to try to correct the interference by one or more of the following measures:

- Reorient or relocate the receiving antenna.
- Increase the separation between the equipment and the receiver.
- Connect the equipment to an outlet on a circuit different from that to which the receiver is connected.
- Consult the dealer or an experienced radio/TV technician for help.

This device complies with part 15 of the FCC Rules. Operation is subject to the following two conditions: (1) this device may not cause harmful interference and (2) this device must accept any interference received, including interference that may cause undesired operation of the device. Any changes or modifications in construction of this device which are not expressly approved by the party responsible for compliance could void the user's authority to operate the equipment.

FCC Radio Frequency Interference Requirements (for UNII devices)

High power radars are allocated as primary users of the 5.25 to 5.35 GHz and 5.65 to 5.85 GHz bands. These radar stations can cause interference with and/or damage this device. This device cannot be co-located with any other transmitter.

FCC RF Radiation Exposure Statement

[For having wireless function (WLAN, Bluetooth,...)]

This equipment complies with FCC radiation exposure limits set forth for an uncontrolled environment. This transmitter must not be colocated or operating in conjunction with any other antenna or transmitter. This equipment should be installed and operated with minimum distance 20 cm (7.8 inches) between the radiator and your body. Users must follow the specific operating instructions for satisfying RF exposure compliance.

Industry Canada Statement

(For Canada)

[For having wireless function (WLAN, Bluetooth,...)]

This device complies with Industry Canada's applicable licence-exempt RSSs. Operation is subject to the following two conditions:

- (1) This device may not cause interference; and
- (2) This device must accept any interference, including interference that may cause undesired operation of the device.

IC Radiation Exposure Statement

(For Canada)

[For having wireless function (WLAN, Bluetooth,...)]

This equipment complies with IC radiation exposure limits set forth for an uncontrolled environment. This equipment should be installed and operated with minimum distance 20 cm (7.8 inches) between the antenna & your body.

NOTE: THE MANUFACTURER IS NOT RESPONSIBLE FOR ANY RADIO OR TV INTERFERENCE CAUSED BY UNAUTHORIZED MODIFICATIONS TO THIS EQUIPMENT. SUCH MODIFICATIONS COULD VOID THE USER'S AUTHORITY TO OPERATE THE EQUIPMENT.

(For Canada)

[For product having the wireless function using 5 GHz frequency bands]

- The device for operation in the band 5150–5250 MHz is only for indoor use to reduce the potential for harmful interference to co-channel mobile satellite systems;
- For devices with detachable antenna(s), the maximum antenna gain permitted for devices in the bands 5250-5350 MHz and 5470-5725 MHz shall be such that the equipment still complies with the e.i.r.p. limit;
- For devices with detachable antenna(s), the maximum antenna gain permitted for devices in the band 5725-5850 MHz shall be such that the equipment still complies with the e.i.r.p. limits specified for point-to-point and non-point-to-point operation as appropriate; and
- The worst-case tilt angle(s) necessary to remain compliant with the e.i.r.p. elevation mask requirement set forth in Section 6.2.2(3) shall be clearly indicated. (devices operating in the band 5250-5350 MHz with a maximum e.i.r.p. greater than 200 mW)
- High-power radars are allocated as primary users (i.e. priority users) of the bands 5250–5350 MHz and 5650–5850 MHz and that these radars could cause interference and/or damage to LE-LAN devices.

NOTE TO CABLE/TV INSTALLER

(For USA and Canada)

This reminder is provided to call the CATV system installer's attention to Article 820-40 of the National Electric Code (U.S.A.). The code provides guidelines for proper grounding and, in particular, specifies that the cable ground shall be connected to the grounding system of the building, as close to the point of the cable entry as practical.

LG Recycling Policy

(For USA)

LG Electronics offers a customized e-waste take-back and recycling service that meets local needs and requirements in the countries where e-waste regulations are in place, and also provides product and packaging take-back and recycling service voluntarily in some countries. LG Electronics evaluates products' recyclability at the design step using LG's recyclability evaluation tool, with the goal of improving recyclability where practicable. Through these activities, LG seeks to contribute to conserving natural resources and protecting the environment. For more information about the LG Recycling Policy, please visit our global site at <http://www.lg.com/global/sustainability/environment/take-back-recycling>







WARNING!

Never place a television set in an unstable location. A television set may fall, causing serious personal injury or death. Many injuries, particularly to children, can be avoided by taking simple precautions such as:

- Using cabinets or stands recommended by the manufacturer of the television set.
- Only using furniture that can safely support the television set.
- Ensuring the television set is not overhanging the edge of the supporting furniture.
- Not placing the television set on tall furniture (for example, cupboards or bookcases) without anchoring both the furniture and the television set to a suitable support.
- Not placing the television set on cloth or other materials that may be located between the television set and supporting furniture.
- Educating children about the dangers of climbing on furniture to reach the television set or its controls.

If your existing television set is being retained and relocated, the same considerations as above should be applied.

Symbols

	Refers to alternating current(AC).
	Refers to direct current(DC).
	Refers to class II equipment.
	Refers to stand-by.
	Refers to "ON" (power).
	Refers to dangerous voltage.

Key Codes

- This feature is not available for all models.

Code (Hexa)	Function	Note	Code (Hexa)	Function	Note
00	CH PAGE	R/C Button	52	SOUND	R/C Button
01	CH PAGE	R/C Button	61		R/C Button
02	VOL +	R/C Button	63		R/C Button
03	VOL -	R/C Button	71		R/C Button
06		R/C Button	72		R/C Button
07		R/C Button	79	RATIO	R/C Button
08	(Power)	R/C Button	4C	LIST	R/C Button
09	MUTE	R/C Button	5B	EXIT	R/C Button
0B	INPUT	R/C Button	0A	AUDIO	R/C Button
1A	FLASHBK	R/C Button	8E		R/C Button
0F	TV	R/C Button	8F		R/C Button
10 - 19	Number Key 0 - 9	R/C Button	0E	SLEEP	R/C Button
45	Q.MENU	R/C Button	AA	INFO	R/C Button
28	BACK	R/C Button	B0		R/C Button
30	AV MODE	R/C Button	B1		R/C Button
39	CAPTION	R/C Button	BA		R/C Button
40		R/C Button	1E	FAV	R/C Button
41		R/C Button	4D	PICTURE	R/C Button
43	SETTINGS	R/C Button	91	SAP/*	R/C Button
44	OK	R/C Button			

• Key code 4C (0x4C) is available on ATSC / ISDB models which use major / minor channel.
(For South Korea, Japan, North America, Latin America except Colombia models)

EXTERNAL CONTROL DEVICE SETUP

- Image shown may differ from your TV.

Connect the USB to Serial converter/RS-232C input jack to an external control device (such as a computer or an A/V control system) to control the product's functions externally.

Note: The type of control port on the TV can be different between model series.

- * Please be advised that not all models support this type of connectivity.
- * Cable is not provided.

USB to Serial converter with USB Cable

USB Type

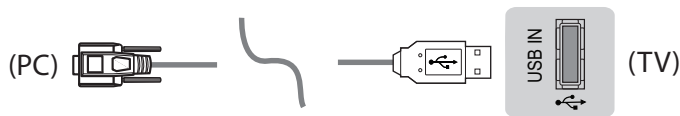

- LGTV supports PL2303 chip-based (Vendor ID: 0x0557, Product ID: 0x2008) USB to serial converter which is not made nor provided by LG.
- It can be purchased from computer stores that carry accessories for IT support professionals.

RS-232C with RS-232C Cable

DE9 (D-Sub 9 pin) Type

- You need to purchase the RS-232C (DE9, D-Sub 9 pin female-to-female type) to RS-232C cable required for the connection between the PC and the TV, which is specified in the manual.
- The connection interface may differ from your TV.



Phone jack Type

- You need to purchase the phone-jack to RS-232 cable required for the connection between the PC and the TV, which is specified in the manual.
- * For other models, connect to the USB port.
- * The connection interface may differ from your TV.

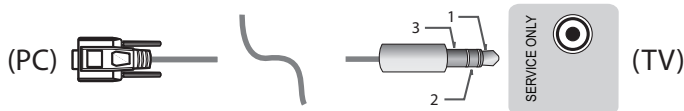

or

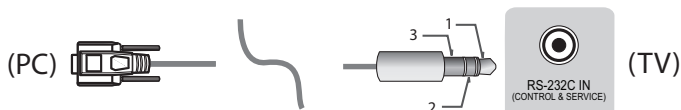

Customer Computer

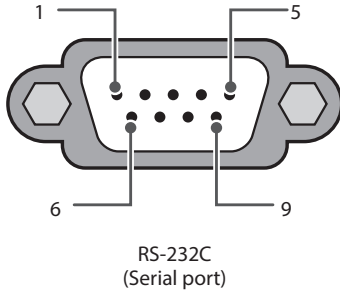

RS-232C Configurations

7-Wire Configurations
(Standard RS-232C cable)

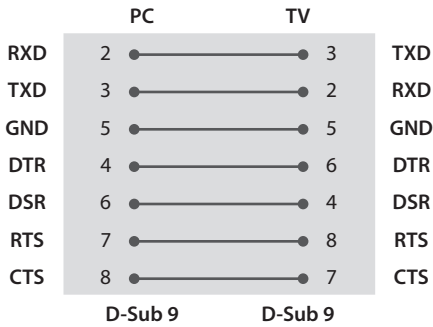

3-Wire Configurations
(Not standard)

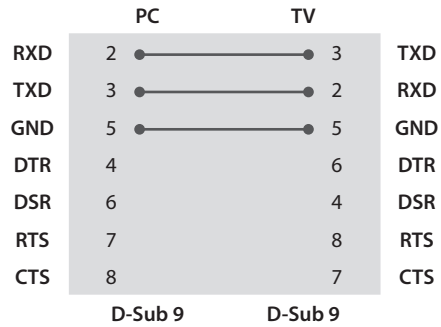

ENGLISH

Set ID

For Set ID number, see "Real Data Mapping"

- 1 Press **SETTINGS** to access the main menus.
- 2 Press the Navigation buttons to scroll to **OPTION** and press **OK**.
- 3 Press the Navigation buttons to scroll to **SET ID** and press **OK**.
- 4 Scroll left or right to select a set ID number and select **CLOSE**. The adjustment range is 1-99.
- 5 When you are finished, press **EXIT**.
* (Depending upon model)

Communication Parameters

Baud rate: 9600 bps (UART)

Data length: 8 bits

Parity: None

Stop bit: 1 bit

Communication code: ASCII code

Use a crossed (reverse) cable.

Command reference list

(Depending upon model)

	COMMAND1	COMMAND2	DATA (Hexadecimal)		COMMAND1	COMMAND2	DATA (Hexadecimal)
01. Power*	k	a	00 to 01	15. Balance	k	t	00 to 64
02. Aspect Ratio	k	c	(page 23)	16. Color (Colour) Temperature	x	u	00 to 64
03. Screen Mute	k	d	(page 23)	17. ISM Method (Only Plasma TV)	j	p	(page 25)
04. Volume Mute	k	e	00 to 01	18. Equalizer	j	v	(page 25)
05. Volume Control	k	f	00 to 64	19. Energy Saving	j	q	00 to 05
06. Contrast	k	g	00 to 64	20. Tune Command	m	a	(page 25)
07. Brightness	k	h	00 to 64	21. Channel (Programme) Add/Del(Skip)	m	b	00 to 01
08. Color/ Colour	k	i	00 to 64	22. Key	m	c	Key Codes
09. Tint	k	j	00 to 64	23. Control Backlight, Control Panel Light	m	g	00 to 64
10. Sharpness	k	k	00 to 32	24. Input select (Main)	x	b	(page 27)
11. OSD Select	k	l	00 to 01	25. 3D (Only 3D models)	x	t	(page 28)
12. Remote Control Lock Mode	k	m	00 to 01	26. Extended 3D (Only 3D models)	x	v	(page 28)
13. Treble	k	r	00 to 64	27. Auto Configure	j	u	(page 29)
14. Bass	k	s	00 to 64				

* Note: During playing or recording media, all commands except Power (ka) and Key (mc) are not executed and treated as NG. With RS-232C cable, TV can communicate "ka command" in power-on or power-off status. But with USB-to-Serial converter cable, the command works only if TV is on.

Transmission / Receiving Protocol

Transmission

[Command1][Command2][][Set ID][][Data][Cr]

[Command 1]	:	First command to control the TV. (j, k, m or x)
[Command 2]	:	Second command to control the TV.
[Set ID]	:	You can adjust the [Set ID] to choose desired monitor ID number in option menu. Adjustment range in TV is 1 to 99. If [Set ID] value is selected to '0', every connected set can be controlled. * [Set ID] is indicated as decimal (1 to 99) on menu and as Hexadecimal (0x00 to 0x63) on transmission/receiving protocol.
[DATA]	:	To transmit command data (hexadecimal). Transmit 'FF' data to read status of command.
[Cr]	:	Carriage Return - ASCII code '0x0D'
[]	:	Space - ASCII code '0x20'

OK Acknowledgement

[Command2][][Set ID][][OK][Data][x]

The set transmits ACK (acknowledgement) based on this format when receiving normal data. At this time, if the data is data read mode, it indicates present status data. If the data is data write mode, it returns the data of the PC computer.

Error Acknowledgement

[Command2][][Set ID][][NG][Data][x]

The set transmits ACK (acknowledgement) based on this format when receiving abnormal data from non-viable functions or communication errors.

Data 00: Illegal Code

Real data mapping (Hexadecimal : Decimal)

- When you enter the [data] in hexadecimal, refer to following conversion table.
- Channel Tune (ma) Command uses two-byte hexadecimal value([data]) to select channel number.

00: Step 0	32: Step 50 (Set ID 50)	FE: Step 254
01: Step 1 (Set ID 1)	33: Step 51 (Set ID 51)	FF: Step 255
...
0A: Step 10 (Set ID 10)	63: Step 99 (Set ID 99)	01 00: Step 256
...
0F: Step 15 (Set ID 15)	C7: Step 199	27 0E: Step 9998
10: Step 16 (Set ID 16)	C8: Step 200	27 0F: Step 9999
...

01. Power (Command: k a)

- To control Power *On or Off of the set.

Transmission [k][a][][Set ID][][Data][Cr]

Data 00: Power Off 01: *Power On

Ack [a][][Set ID][][OK/NG][Data][x]

- To Show TV is Power On or *Off

Transmission [k][a][][Set ID][][FF][Cr]

Ack [a][][Set ID][][OK][Data][x]

* Similarly, if other functions transmit 'FF' data based on this format, Acknowledgement feedback presents status about each function.

02. Aspect Ratio (Command: k c)
(Main Picture Size)

- To adjust the screen format. (Main picture format) You can also adjust the screen format using the **Aspect Ratio** in the **Q.MENU** or **PICTURE** menu.

Transmission [k][c][][Set ID][][Data][Cr]

Data 01: Normal screen (4:3)	07: 14:9 (Europe, Colombia, Mid-East, Asia except South Korea and Japan)
02: Wide screen(16:9)	09: * Just Scan
04: Zoom	0B: Full Wide (Europe, Colombia, Mid-East, Asia except South Korea and Japan)
05: Zoom 2 (Latin America except Colombia Only)	10 to 1F: Cinema Zoom 1 to 16
06: Set by Program/ Original	0c : 21:9 (Depending on model)

Ack [c][][Set ID][][OK/NG][Data][x]

* Using the PC input, you select either 16:9 or 4:3 screen aspect ratio.

* In DTV/HDMI/Component mode (high-definition), Just Scan is available.

* Full wide mode may work differently based on model and is supported for DTV fully, and ATV, AV partially.

03. Screen Mute (Command: k d)

- To select screen mute on/off.

Transmission [k][d][][Set ID][][Data][Cr]

Data 00: Screen mute off (Picture on)
Video mute off

01: Screen mute on (Picture off)

10: Video mute on

Ack [d][][Set ID][][OK/NG][Data][x]

* In case of video mute on only, TV will display On Screen Display(OSD). But, in case of Screen mute on, TV will not display OSD.

04. Volume Mute (Command: k e)

- To control volume mute on/off. You can also adjust mute using the MUTE button on remote control.

Transmission [k][e][][Set ID][][Data][Cr]

Data 00: Volume mute on (Volume off)

01: Volume mute off (Volume on)

Ack [e][][Set ID][][OK/NG][Data][x]

05. Volume Control (Command: k f)

- To adjust volume. You can also adjust volume with the volume buttons on remote control.

Transmission [k][f][][Set ID][][Data][Cr]

Data Min: 00 to Max: 64

Ack [f][][Set ID][][OK/NG][Data][x]

06. Contrast (Command: k g)

- To adjust screen contrast. You can also adjust contrast in the **PICTURE** menu.

Transmission [k][g][][Set ID][][Data][Cr]

Data Min: 00 to Max: 64

Ack [g][][Set ID][][OK/NG][Data][x]

07. Brightness (Command: k h)

- To adjust screen brightness. You can also adjust brightness in the **PICTURE** menu.

Transmission [k][h][][Set ID][][Data][Cr]

Data Min: 00 to Max: 64

Ack [h][][Set ID][][OK/NG][Data][x]

08. Color/Colour (Command: k i)

- To adjust the screen Color(Colour). You can also adjust colour in the **PICTURE** menu.

Transmission [k][i][][Set ID][][Data][Cr]

Data Min: 00 to Max: 64

Ack [i][][Set ID][][OK/NG][Data][x]

09. Tint (Command: k j)

- To adjust the screen tint. You can also adjust tint in the **PICTURE** menu.

Transmission [k][j][][Set ID][][Data][Cr]

Data Red: 00 to Green: 64

Ack [j][][Set ID][][OK/NG][Data][x]

10. Sharpness (Command: k k)

- To adjust the screen sharpness. You can also adjust sharpness in the **PICTURE** menu.

Transmission [k][k][][Set ID][][Data][Cr]

Data Min: 00 to Max: 32

Ack [k][][Set ID][][OK/NG][Data][x]

11. OSD Select (Command: k l)

- To select OSD (On Screen Display) on/off when controlling remotely.

Transmission [k][l][][Set ID][][Data][Cr]

Data 00: OSD off 01: OSD on

Ack [l][][Set ID][][OK/NG][Data][x]

12. Remote control lock mode (Command: k m)

- To lock the front panel controls on the monitor and remote control.

Transmission [k][m][][Set ID][][Data][Cr]

Data 00: Lock off 01: Lock on

Ack [m][][Set ID][][OK/NG][Data][x]

- * If you are not using the remote control, use this mode. When main power is off & on (plug-off and plug-in, after 20 - 30 seconds), external control lock is released.

- * In the standby mode (DC off by off timer or 'ka', 'mc' command), and if key lock is on, TV will not turn on by power on key of IR & Local Key.

13. Treble (Command: k r)

- To adjust treble. You can also adjust in the **AUDIO** menu.

Transmission [k][r][][Set ID][][Data][Cr]

Data Min: 00 to Max: 64

Ack [r][][Set ID][][OK/NG][Data][x]

- * (Depending upon model)

14. Bass (Command: k s)

- To adjust Bass. You can also adjust in the **AUDIO** menu.

Transmission [k][s][][Set ID][][Data][Cr]

Data Min: 00 to Max: 64

Ack [s][][Set ID][][OK/NG][Data][x]

- * (Depending upon model)

15. Balance (Command: k t)

- To adjust balance. You can also adjust balance in the **AUDIO** menu.

Transmission [k][t][][Set ID][][Data][Cr]

Data Min: 00 to Max: 64

Ack [t][][Set ID][][OK/NG][Data][x]

16. Color (Colour) Temperature (Command: x u)

- To adjust colour temperature. You can also adjust Color (Colour) Temperature in the **PICTURE** menu.

Transmission [x][u][][Set ID][][Data][Cr]

Data Min: 00 to Max: 64

Ack [u][][Set ID][][OK/NG][Data][x]

17. ISM Method (Command: j p) (Only Plasma TV)

- To control the ISM method. You can also adjust ISM Method in **OPTION** menu.

Transmission [j][p][][Set ID][][Data][Cr]

Data Min: 02: Orbiter
08: Normal
20: Color(Colour) Wash

Ack [p][][Set ID][][OK/NG][Data][x]

18. Equalizer (Command: j v)

- Adjust EQ of the set.

Transmission [j][v][][Set ID][][Data][Cr]

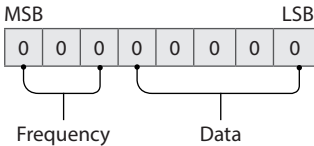

7	6	5	Frequency	4	3	2	1	0	Step
0	0	0	1st Band	0	0	0	0	0	0(decimal)
0	0	1	2nd Band	0	0	0	0	1	1(decimal)
0	1	0	3rd Band
0	1	1	4th Band	1	0	0	1	1	19(decimal)
1	0	0	5th Band	1	0	1	0	0	20(decimal)

Ack [v][][Set ID][][OK/NG][Data][x]

- It depends upon model, and can adjust when sound mode is EQ adjustable value.

19. Energy Saving (Command: j q)

- To reduce the power consumption of the TV. You can also adjust Energy Saving in **PICTURE** menu.

Transmission [j][q][][Set ID][][Data][Cr]

Data 00: Off
01: Minimum
02: Medium
03: Maximum
04: Auto (For LCD TV / LED TV) / Intelligent sensor (For PDP TV)
05: Screen off

* (Depending upon model)

Ack [q][][Set ID][][OK/NG][Data][x]

20. Tune Command (Command: m a)

- This command may work differently depending upon model and signal.

* For Europe, Mid-East, Colombia, Asia except South Korea and Japan Model

- Select channel to following physical number.

Transmission [m][a][][Set ID][][Data 00][]

[Data 01][][Data 02][Cr]

* Analog Antenna/Cable

[Data 00][Data 01] Channel Data

Data 00: High byte channel data

Data 01: Low byte channel data

- 00 00 ~ 00 C7 (Decimal: 0 ~ 199)

Data 02: Input Source (Analog)

- 00: Antenna TV (ATV)

- 80: Cable TV (CATV)

* Digital Antenna/Cable/Satellite

[Data 00][Data 01]: Channel Data

Data 00 : High Channel data

Data 01 : Low Channel data

- 00 00 ~ 27 0F (Decimal: 0 ~ 9999)

Data 02 : Input Source (Digital)

- 10: Antenna TV (DTV)

- 20: Antenna Radio (Radio)

- 40: Satellite TV (SDTV)

- 50: Satellite Radio (S-Radio)

- 90: Cable TV (CADTV)

- a0: Cable Radio (CA-Radio)

* Tune Command Examples:

1. Tune to the Analog antenna (PAL) Channel 10.
Set ID = All = 00
Data 00 & 01 = Channel Data is 10 = 00 0a
Data 02 = Analog Antenna TV = 00
Result = **ma 00 00 0a 00**
2. Tune to the digital antenna (DVB-T) Channel 01.
Set ID = All = 00
Data 00 & 01 = Channel Data is 1 = 00 01
Data 02 = Digital Antenna TV = 10
Result = **ma 00 00 01 10**
3. Tune to the satellite (DVB-S) Channel 1000.
Set ID = All = 00
Data 00 & 01 = Channel Data is 1000 = 03 E8
Data 02 = Digital Satellite TV = 40
Result = **ma 00 03 E8 40**

Ack [a][][Set ID][][OK][Data 00][Data 01]

[Data 02][x][a][][Set ID][][NG][Data 00][x]

* For South Korea, North/Latin America except Colombia Model

* To tune channel to following physical/major/minor number.

Transmission [m][a][][0][][Data00][][Data01]

[][Data02][][Data03][][Data04][][Data05][Cr]

* Digital channels have a Physical, Major, and Minor channel number. The Physical number is the actual digital channel number, the Major is the number that the channel should be mapped to, and the Minor is the sub-channel. Since the ATSC tuner automatically maps the channel from the Major / Minor number, the Physical number is not required when sending a command in Digital.

* Analog Antenna/Cable

- Data 00: Physical Channel Number
- Antenna (ATV): 02~45 (Decimal: 2 ~ 69)
 - Cable (CATV): 01, 0E~7D (Decimal: 1, 14~125)
- [Data 01 ~ 04]: Major/Minor Channel Number
- Data 01 & 02: xx (Don't care)
- Data 03 & 04: xx (Don't care)
- Data 05: Input Source (Analog)
- 00: Antenna TV (ATV)
 - 01: Cable TV (CATV)

* Digital Antenna/Cable

- Data 00 : xx (Don't care)
- [Data 01][Data 02]: Major Channel Number
- Data 01 : High byte Channel Data
- Data 02 : Low byte Channel Data
- 00 01 ~ 27 0F (Decimal: 1 ~ 9999)
- [Data 03][Data 04]: Minor Channel Number
- Data 03 : High byte Channel Data
- Data 04 : Low byte Channel Data
- Data 05 : Input Source (Digital)
- 02: Antenna TV (DTV) – Use Physical Channel Number
 - 06: Cable TV (CADTV) – Use Physical Channel Number
 - 22: Antenna TV (DTV) – Don't Use Physical Channel Number
 - 26: Cable TV (CADTV) - Don't Use Physical Channel Number
 - 46: Cable TV (CADTV) – Use Physical/Major Channel Number Only (One Part Channel)
 - 66: Cable TV (CADTV) – Use Major Channel Number Only (One Part Channel)

* Two bytes are available for each major and minor channel data, but usually the low byte is used alone (high byte is 0).

* Tune Command Examples:

1. Tune to the Analog cable (NTSC) channel 35.
Set ID = All = 00
Data 00 = Channel Data is 35 = 23
Data 01 & 02 = No Major = 00 00
Data 03 & 04 = No Minor = 00 00
Data 05 = Analog Cable TV = 01
Total = **ma 00 23 00 00 00 01**
2. Tune to the digital antenna (ATSC) channel 30-3.
Set ID = All = 00
Data 00 = Don't know Physical = 00
Data 01 & 02 = Major is 30 = 00 1E
Data 03 & 04 = Minor is 3 = 00 03
Data 05 = Digital Antenna TV = 22
Total = **ma 00 00 00 1E 00 03 22**

Ack [a][][Set ID][][OK][Data 00][Data 01]

[Data 02][Data 03][Data 04][Data 05]

[x][a][][Set ID][][NG][Data 00][x]

* For Japan Model

• To tune channel to following physical/major/minor number.

Transmission [m][a][][0][][Data00][][Data01]

[][Data02][][Data03][][Data04][][Data05][Cr]

* Digital Antenna/Satellite

- Data 00 : xx (Don't care)
 [Data 01][Data 02]: Major Channel Number
 Data 01 : High byte Channel Data
 Data 02 : Low byte Channel Data
 - 00 01 ~ 27 0F (Decimal: 1 ~ 9999)
 [Data 03] : Minor/Branch Channel Number
 [Data 04] : (Don't care in Satellite)
 Data 03 : High byte Channel Data
 Data 04 : Low byte Channel Data
 Data 05 : Input Source (Digital/Satellite for Japan)
 - 02: Antenna TV (DTV)
 - 07: BS (Broadcasting Satellite)
 - 08: CS1 (Communication Satellite 1)
 - 09: CS2 (Communication Satellite 2)

* Tune Command Examples:

- 1 Tune to the digital antenna (ISDB-T) channel 17-1.
 Set ID = All = 00
 Data 00 = Don't know Physical = 00
 Data 01 & 02 = Major is 17 = 00 11
 Data 03 & 04 = Minor/Branch is 1 = 00 01
 Data 05 = Digital Antenna TV = 02
 Total = **ma 00 00 00 11 00 01 02**
- 2 Tune to the BS (ISDB-BS) channel 30.
 Set ID = All = 00
 Data 00 = Don't know Physical = 00
 Data 01 & 02 = Major is 30 = 00 1E
 Data 03 & 04 = Don't Care = 00 00
 Data 05 = Digital BS TV = 07
 Total = **ma 00 00 00 1E 00 00 07**

* This feature is varied based on the model.

Ack [a][][Set ID][][OK][Data 00][Data 01]
 [Data 02][Data 03][Data 04][Data 05]
 [x][a][][Set ID][][NG][Data 00][x]

21. Channel(Programme) Add/Del(Skip) (Command: m b)

- To skip current channel(programme) for next time.

Transmission [m][b][][Set ID][][Data][Cr]

Data 00: Del(ATSC,ISDB)/Skip(DVB) 01: Add

Ack [b][][Set ID][][OK/NG][Data][x]

- Set the saved channel status to del(ATSC, ISDB)/skip(DVB) or add.

22. Key (Command: m c)

- To send IR remote key code.

Transmission [m][c][][Set ID][][Data][Cr]

Data Key code - page 18.

Ack [c][][Set ID][][OK/NG][Data][x]

23. Control Backlight, Control Panel Light (Command: m g)

- * For LCD TV / LED TV

- To control the backlight.

Transmission [m][g][][Set ID][][Data][Cr]

Data Min: 00 to Max: 64

Ack [g][][Set ID][][OK/NG][Data][x]

- * For Plasma TV

- To control the panel light.

Transmission [m][g][][Set ID][][Data][Cr]

Data Min: 00 to Max: 64

Ack [g][][Set ID][][OK/NG][Data][x]

24. Input select (Command: x b) (Main Picture Input)

- To select input source for main picture.

Transmission [x][b][][Set ID][][Data][Cr]

Data 00: DTV	01: CADTV
02: Satellite DTV	10: ATV
ISDB-BS (Japan)	
03: ISDB-CS1 (Japan)	
04: ISDB-CS2 (Japan)	
11: CATV	
20: AV or AV1	21: AV2
40: Component1	41: Component2
60: RGB	
90: HDMI1	91: HDMI2
92: HDMI3	93: HDMI4

Ack [b][][Set ID][][OK/NG][Data][x]

- * This function depends on model and signal.

25. 3D (Command: x t) (only 3D models)
(Depending upon model)

- To change 3D mode for TV.

Transmission [x][t][][Set ID][][Data 00][][Data 01][][Data 02][][Data 03][Cr]

* (Depending upon model)

Data	Structure
[Data 00]	00: 3D On 01: 3D Off 02: 3D to 2D 03: 2D to 3D
[Data 01]	00: Top and Bottom 01: Side by Side 02: Check Board 03: Frame Sequential 04: Column interleaving 05: Row interleaving
[Data 02]	00: Right to Left 01: Left to Right
[Data 03]	3D Effect(3D Depth): Min: 00 - Max: 14 (*transmit by Hexadecimal code)

- * If [Data 00] is 00 (3D On), [Data 03] has no meaning.
- * If [Data 00] is 01 (3D off) or 02 (3D to 2D), [Data 01], [Data 02] and [Data 03] have no meaning.
- * If [Data 00] is 03 (2D to 3D), [Data 01] and [Data 02] have no meaning.
- * If [Data 00] is 00 (3D On) or 03 (2D to 3D), [Data 03] works when 3D Mode (Genre) is manual only.
- * All 3D pattern options ([Data 01]) may not be available according to broadcasting/video signal.

[Data 00]	[Data 01]	[Data 02]	[Data 03]
00	O	O	O
01	X	X	X
02	X	X	X
03	X	O	O

X: don't care

Ack [t][][Set ID][][OK][Data00][Data01][Data02][Data03][x][t][][Set ID][][NG][Data00][x]

26. Extended 3D(Command: x v) (only 3D models)
(Depending upon model)

- To change 3D option for TV.

Transmission [x][v][][Set ID][][Data 00][][Data 01][Cr]

[Data 00]	3D option 00: 3D Picture Correction 01: 3D Depth (3D Mode is Manual Only) 02: 3D Viewpoint 06: 3D Color Correction 07: 3D Sound Zooming 08: Normal Image View 09: 3D Mode (Genre)
[Data 01]	It has own range for each 3D option determined by [Data 00]. 1) When [Data 00] is 00 00: Right to Left 01: Left to Right 2) When [Data 00] is 01, 02 Data Min: 0 - Max: 14 (*transmit by Hexadecimal code)

Data value range(0 - 20) converts Viewpoint range (-10 - +10) automatically (Depending upon model)

- * This option works when 3D Mode (Genre) is manual only.

3) When [Data 00] is 06, 07	00: Off 01: On
4) When [Data 00] is 08	00: Revert to 3D video from 3D-to-2D converted 2D video 01: Change 3D video to 2D video, except 2D-to-3D video

- * If conversion condition doesn't meet, command is treated as NG.

5) When [Data 00] is 09	00: Standard 02: Cinema 04: Manual	01: Sport 03: Extreme 05: Auto
-------------------------	--	--------------------------------------

Ack [v][][Set ID][][OK][Data00][Data01][x][v][][Set ID][][NG][Data00][x]

27. Auto Configure (Command: j u)
(Depending upon model)

- To adjust picture position and minimize image shaking automatically. It works only in RGB (PC) mode.

Transmission [j][u][][Set ID][][Data][Cr]

Data 01: To set

Ack [u][][Set ID][][OK/NG][Data][x]

IR OUT Using Guide

(Depending upon model)

Suitable / Not Recommend remote-controller data format

Item	Data format code	Note
Suitable Data Format	NEC, Toshiba Full Repeat Code Format	Single : Enable Repeat : Enable
	Philips RC5, RC6 Code Format	
	Zenith Code Format	
Not Recommend Data Format	Matsushita, RCA Code Format	Single : Enable Repeat : Disable
	Sony 12/15/20 bit, Mitsubishi Code Format	
	Sharp, JVC, R-step, Philips RCMM, RECS-80, XMP Code Format	Single : Disable Repeat : Disable

IR Receiver specifications

Carrier frequency	37.9 KHz
Peak Wavelength	940 nm
Minimum burst length	Min. 300 us
Minimum gap time is required of	Min. 350 us
Data word length	Max. 100 ms
Minimum gap time in the data stream is needed of	Min. 50 ms

Parameter		Symbol	Conditions	Min	Typ	Max	Unit
High Level Out Pulse Width	(※1)	T _{WH}	Burst Wave = 600 μs	400	-	800	μs
Low Level Out Pulse Width	(※1)	T _{WL}	Period = 1.2 ms	400	-	800	μs



If not use the remote-controller with data formats recommended, IR output signals will be suppressed automatically by IR receiver. In this case, LG does not guarantee IR working function. To make sure of this matter, here are two methods as below.

- Use the remote-controller with suitable data formats.
- Use the IR dongle receiver of the set-top box.

CHILD SAFETY:

PROPER TELEVISION PLACEMENT MATTERS



THE CONSUMER ELECTRONICS INDUSTRY CARES

- Manufacturers, retailers and the rest of the consumer electronics industry are committed to making home entertainment safe and enjoyable.
- As you enjoy your television, please note that all televisions – new and old- must be supported on proper stands or installed according to the manufacturer's recommendations. Televisions that are inappropriately situated on dressers, bookcases, shelves, desks, speakers, chests, carts, etc., may fall over, resulting in injury.



TUNE IN TO SAFETY

- **ALWAYS** follow the manufacturer's recommendations for the safe installation of your television.
- **ALWAYS** read and follow all instructions for proper use of your television.
- **NEVER** allow children to climb on or play on the television or the furniture on which the television is placed.
- **NEVER** place the television on furniture that can easily be used as steps, such as a chest of drawers.
- **ALWAYS** install the television where it cannot be pushed, pulled over or knocked down.
- **ALWAYS** route cords and cables connected to the television so that they cannot be tripped over, pulled or grabbed.



WALL OR CEILING MOUNT YOUR TELEVISION

- **ALWAYS** contact your retailer about professional installation if you have any doubts about your ability to safely mount your television.
- **ALWAYS** use a mount that has been recommended by the television manufacturer and has a safety certification by an independent laboratory (such as UL, CSA, ETL).
- **ALWAYS** follow all instructions supplied by the television and mount manufacturers.
- **ALWAYS** make sure that the wall or ceiling where you are mounting the television is appropriate. Some mounts are not designed to be mounted to walls and ceilings with steel studs or cinder block construction. If you are unsure, contact a professional installer.
- Televisions can be heavy. A minimum of two people is required for a wall or ceiling mount installation.



MOVING AN OLDER TELEVISION TO A NEW PLACE IN YOUR HOME

- Many new television buyers move their older CRT televisions into a secondary room after the purchase of a flat-panel television. Special care should be made in the placement of older CRT televisions.
- **ALWAYS** place your older CRT television on furniture that is sturdy and appropriate for its size and weight.
- **NEVER** place your older CRT television on a dresser where children may be tempted to use the drawers to climb.
- **ALWAYS** make sure your older CRT television does not hang over the edge of your furniture.



Declaration of Conformity	
Trade Name	LG
Model	32LV340H-UA 32LV340C-UB 40LV340H-UA 43LV340C-UB 43LV340H-UA 49LV340C-UB 49LV340H-UA 55LV340C-UB 55LV340H-UA
Responsible Party	LG Electronics Inc.
Address	1000 Sylvan Ave. Englewood Cliffs NJ 07632 U.S.A
TEL	201-266-2534

The model and serial numbers of the TV are located on the back and on one side of the TV. Record them below should you ever need service.

MODEL _____
SERIAL _____

LG Customer Information Center	
For inquires or comments, visit www.lg.com or call;	
1-888-865-3026	USA, Commercial User
1-855-286-2456	CANADA