

# QUICK SWITCH BLUETOOTH KEYBOARD FOR THREE DEVICES

## User's Guide



For Three Devices - Mac, iPad, iPhone, PC, Smartphones & Tablets



**MACALLY**

## Table of Contents

<b>Introduction</b>	<b>1</b>
<b>Package Contents</b>	<b>1</b>
<b>System Requirements / Technical Support</b>	<b>1</b>
<b>Macally Product Information</b>	<b>1</b>
<b>Hardware Basics</b>	<b>3</b>
<b>Fn Key, Fn Lock Mode and Shortcuts</b>	<b>4</b>
<b>Pairing the keyboard with Mac</b>	<b>6</b>
<b>Pairing the keyboard with Windows PC</b>	<b>10</b>
<b>Pairing the keyboard with iPhone/iPad</b>	<b>12</b>
<b>Pairing the keyboard with Android Smartphones and Tablets</b>	<b>14</b>

## Introduction

Thank you for purchasing the Macally Bluetooth Keyboard for Mac, iPhone, iPad, PC, Android Smartphones and Tablets. This patented keyboard supports up to three Bluetooth devices. One-touch quick switching allows you to type and switch from devices seamlessly. Whether it is doing work with a computer, sending messages on a smartphone, or enjoying videos on a tablet, it is truly the only keyboard that you need for all your applications. This product utilizes thin keycaps with a sensitive and responsive touch which provides a more comfortable and faster typing experience. It is designed with many features and flexibility to help improve your productivity. This keyboard even has built-in Lithium-Ion rechargeable battery so it saves you hassles and money in changing batteries.

Before you begin using this product, be sure to read this user's guide in its entirety.

## Package Contents

- ACEBTKEY Bluetooth Keyboard
- User's Guide

## System Requirements

- Any Mac or PC computer with a Bluetooth host
- Mac OS X v10.6 to Mac OS X v10.12 and above
- Windows 7/8/10
- iPhone, iPad/Pro and iPad mini
- Most Android devices (Smartphones and Tablets)
- iOS 5.0 and above; Android OS 3.0 and above

## Macally Product Information

### Technical Support

Please E-mail us at [techsupport@macally.com](mailto:techsupport@macally.com), or call us at 1-909-230-6888 Monday to Friday, 8:30AM to 5:30PM, Pacific Standard Time

## Macally Product Information

This manual is furnished under license and may be used or copied only in accordance with the terms of such license.

Except as permitted by such license, no part of this publication may be reproduced, stored in a retrieval system, or transmitted, in any form or any means, electronic, mechanical, recording, or otherwise, including translation to another language or format, without the prior written permission of Macally Peripherals.

The content of this manual is furnished for informational use only, is subject to change without notice, and should not be construed as a commitment by Macally Peripherals. Macally Peripherals assumes no responsibility or liability for any errors or inaccuracies that may appear in this book.

Macally is a trademark of the Mace Group, Inc. All other product names, trademarks and registered trademarks in this document are the property of their respective holder.

Copyright® 2017 by Macally Peripherals

### **FCC Information**

This device complies with part 15 of the FCC Rules. Operation is subject to the following two conditions: (1) this device may not cause harmful interference and (2) this device must accept any interference received, including interference that may cause undesired operation.

### **Warranty**

Macally peripherals warrants that this product will be free from defects in title, materials and manufacturing workmanship for two years from the date of purchase. If the product is found to be defective then, as your sole remedy and as the manufacturer's only obligation, Macally will repair or replace the product. This warranty shall not apply to products that have been subject to abuse, misuse, abnormal electrical or environmental conditions, or any condition other than what can be considered as normal use.

### **Warranty Disclaimers**

Macally Peripherals makes no other warranties, express, implied or otherwise, regarding the BTkey, and specifically disclaims any warranty for merchantability or fitness for a particular purpose. The exclusion of implied warranties is not permitted in some states and the exclusions specified herein may not apply to you. This warranty provides you with specific legal rights. There may be other rights that you have which vary from state to state.

### **Limitation of Liability**

The liability of Macally Peripherals arising from this warranty and sale shall be limited to a refund of the purchase price. In no event shall Macally Peripherals be liable for costs of procurement of substitute products or services, or for any lost profits, or for any consequential, incidental, direct or indirect damages, however caused and on any theory of liability, arising from this warranty and sale. These limitations shall apply notwithstanding any failure of essential purpose of any limited remedy. V1.1.

## Hardware Basics

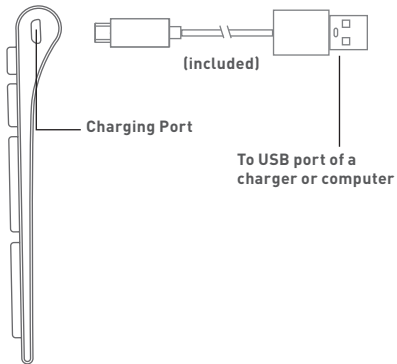
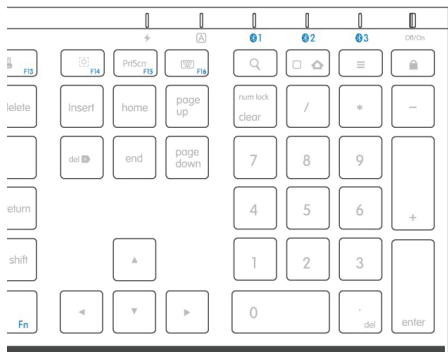
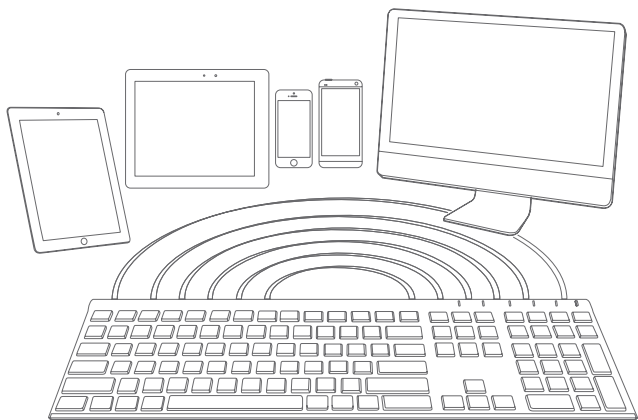

## Fn Key, Fn Lock Mode and Shortcuts

- 1 On/Off switch
- 2 Device 3 Indicator
- 3 Device 2 Indicator
- 4 Device 1 Indicator
- 5 Caps Lock Indicator
- 6 Charging Indicator (Red: charging; Green: full)
- 7 Pairing Keys: Press Fn and P simultaneously

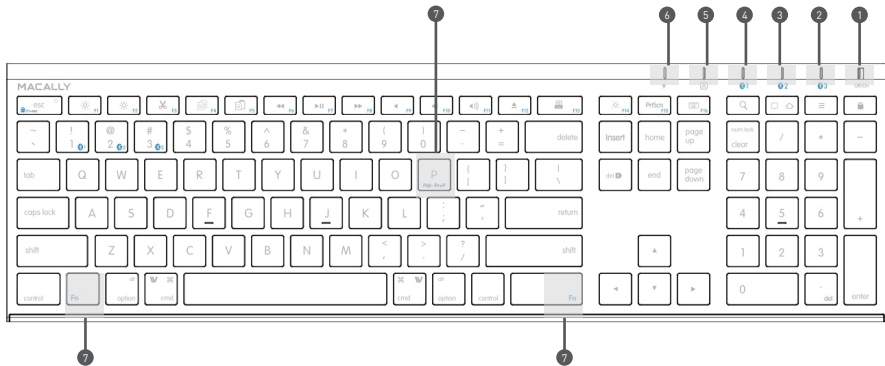

### Use of Fn key: Select Bluetooth device, Pair a device and use blue color keys

1. Press Fn with one of Bluetooth device keys, **F1**, **F2** and **F3** to select a Bluetooth device to use the keyboard
2. The first time using with a Bluetooth device, pairing is needed. After selecting a device, press Fn and P keys simultaneously, the device LED will blink quickly indicating the keyboard is in pairing mode.













### Fn Lock Mode

Press Fn and esc keys simultaneously to lock in Fn mode, so blue colored Function keys are default when pressed, Fn LED is turned on to indicate the Fn Lock mode.



## Shortcut Mode and Keys

List of shortcut keys and what systems are supported. ✓ means “supported”, blank means “not supported”

short cuts	Function	Mac OSX	Windows 7/8/10	iOS	Android	short cuts	Function	Mac OSX	Windows 7/8/10	iOS	Android
esc ⇐	esc/return	✓	✓		✓		Volume Up	✓	✓	✓	✓
	screen brightness down or up	✓		✓			Media Eject	✓		✓	
	Cut	✓		✓			Printer	✓			
	Copy	✓		✓	✓		Area Capture	✓		✓	
	Paste	✓		✓	✓	PrtScn	PrintScreen		✓		
⏪	Previous Track	✓	✓	✓	✓		On-screen keyboard			✓	
⏩	Play/ Pause	✓	✓	✓	✓		Search	✓		✓	
▶	Next Track	✓	✓	✓	✓		Home button			✓	✓
⏭	Mute	✓	✓	✓	✓		Menu		✓		✓
⏮	Volume Down	✓	✓	✓	✓		Lock			✓	✓

Please note, these shortcuts are not universal. Certain shortcuts such as Search, and Home may not work on MacOSX or Windows PCs because they are meant to be used on tablets. On the other hand, some shortcuts may act completely different on different devices so you should try them out first.

### More about mode

In either Shortcut mode or Fn Lock mode, one can also press Fn key with one of top row key simultaneously to perform the secondary function without switching mode.

### Important Note:

1. The keyboard has a built-in energy saving feature. It goes into sleep mode when not in use for a period of time. Press any key [such as “space” key] on your keyboard to wake up again.
2. Please wait for ACEBTKEY to be connected before entering your user’s password during computer boot up.
3. Pairing light needs to be on and flashing during pairing process. If it’s not flashing quickly, press Fn and P again and start all over to pair ACEBTKEY with your device.

## Pairing the keyboard with Mac

1. After a Bluetooth device(for Mac) is selected, for the first time use, pairing is required. Press Fn and P keys simultaneously to set keyboard in pairing mode, the device LED flashes blue quickly.



2. Please click the Bluetooth icon in your computer's menu bar located in upper right corner of your screen.

Make sure Bluetooth is turned to On then select "Open Bluetooth Preferences ..." in the drop down menu.



3: Bluetooth window displays a found Macally Bluetooth keyboard, please click on the “Pair” button next to it.

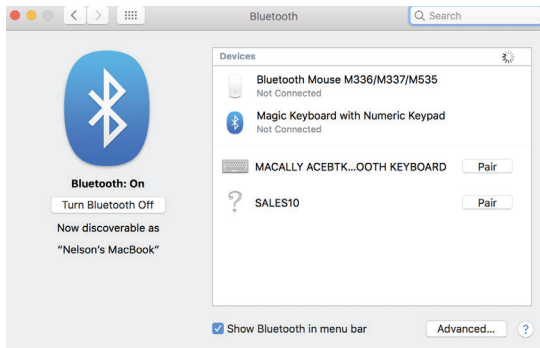

4: Once pairing is finished, the Bluetooth keyboard shows “Connected” status.

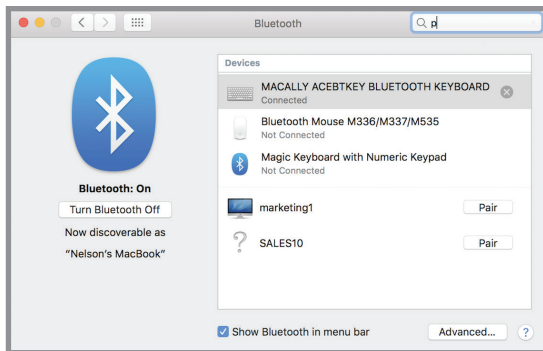

5. When Mac prompts you a message, "The keyboard can not be identified..." please follow Keyboard Setup Assistant guide to identify keyboard as shown below.

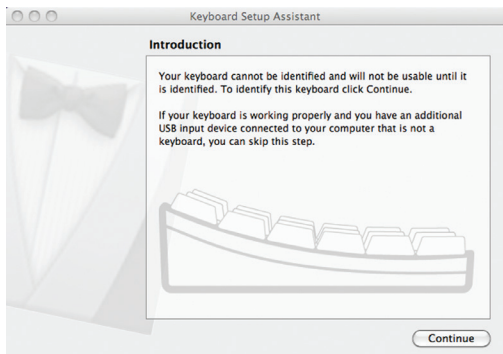

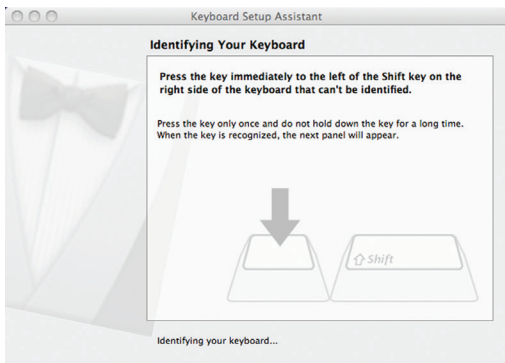

6. Select ANSI option, and click on Done button.

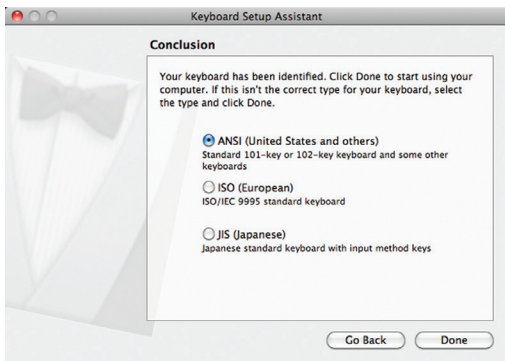

Please note that if you are using a different Apple OSX version, your screen may differ from the above diagrams.

## Pairing the keyboard with your Windows PC

1. After a Bluetooth device(for Windows PC) is selected, for the first time use, pairing is required. Press Fn and P keys simultaneously to set keyboard in pairing mode, the device LED flashes blue quickly.
2. In Windows PC, go to Devices and Printers and select Bluetooth Devices.
3. Click “Add a device” at the top left corner like shown in the picture.

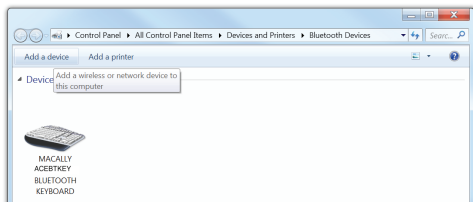

4. Once you see the Macally Bluetooth Keyboard appear, select it and press “Next”

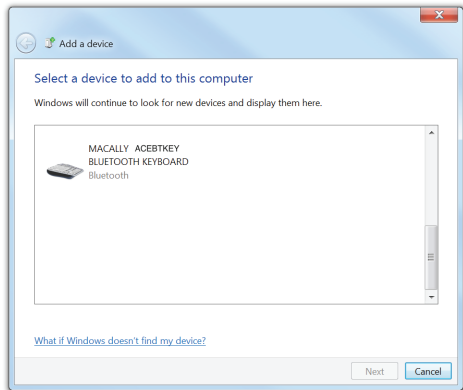

5. After a short period, Windows will show the following screen indicating that the keyboard is now paired with the computer.

Any necessary drivers will install automatically.

Please note that the driver installation may take a few minutes. Windows will notify you when the keyboard is ready to use.

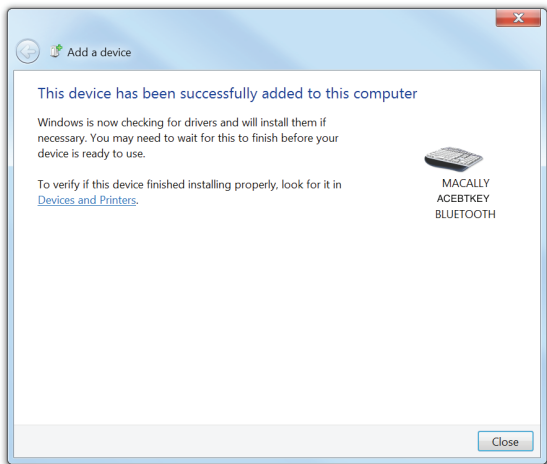

Please note that if you are using a different Windows OS version, your screen may differ from the above diagrams.

## Pairing the keyboard with iPad/iPhone

1. After a Bluetooth device(for iPad or iPhone) is selected, for the first time use, pairing is required. Press Fn and P keys simultaneously to set keyboard in pairing mode, the device LED flashes blue quickly.
2. Bring your iPad or iPhone near by the keyboard. Open up “setting” then Bluetooth”.

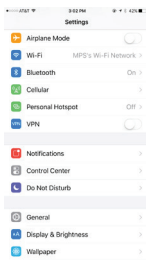

3. Turn on Bluetooth, under the “Bluetooth” menu, it will auto search for the new Bluetooth devices....

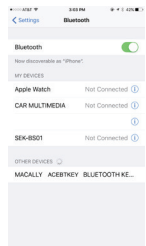



- Once it finds and displays MacallyBluetoothKeyboard or similar name, select it to pair with Macally Bluetooth Keyboard.
- After pairing is successfully completed, it will show "Macally Bluetooth Keyboard.... connected". It is ready to be used with your iPad or iPhone.

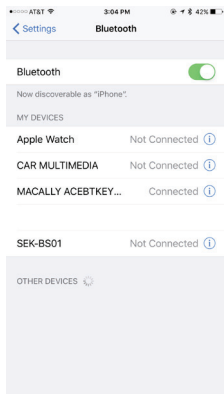

Please note that if you are using a different iOS version, your screen may differ from the above diagrams.

## Pairing the keyboard with your Android Smartphones and Tablets

1. After a Bluetooth device(for Android) is selected, for the first time use, pairing is required. Press Fn and P keys simultaneously to set keyboard in pairing mode, the device LED flashes blue quickly.
2. In Android device, under "Settings" select Bluetooth. Make sure it is configured to "On" as shown in the picture.
3. Once you see Macally Bluetooth Keyboard appear, select it and it will automatically pair to your device.

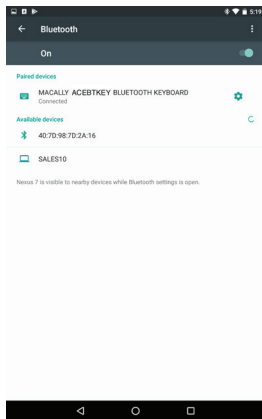
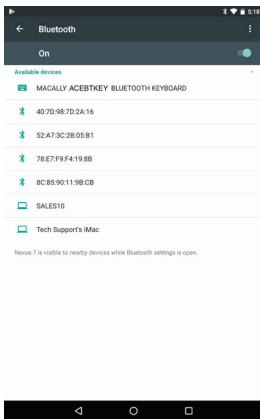

Please note that if you are using a different Android smartphone or Tablet version, your screen may differ from the above diagrams.

[www.macally.com](http://www.macally.com)