

Dell Latitude E5530 Owner's Manual

Regulatory Model: P28G
Regulatory Type: P28G001



Contents

Notes, Cautions, and Warnings.....	0
1 Working on Your Computer.....	5
Before Working Inside Your Computer.....	5
Turning Off Your Computer.....	6
After Working Inside Your Computer.....	6
2 Removing and Installing Components.....	7
Recommended Tools.....	7
Removing the SD Memory Card.....	7
Installing the SD Memory Card.....	7
Removing the Battery.....	7
Installing the Battery.....	8
Removing the Subscriber Identity Module (SIM) Card.....	8
Installing the Subscriber Identity Module (SIM) Card.....	8
Removing the Display Bezel.....	9
Installing the Display Bezel.....	9
Removing the Camera.....	9
Installing the Camera.....	10
Removing the Display Panel.....	10
Installing the Display Panel.....	12
Removing the Keyboard Trim.....	12
Installing the Keyboard Trim.....	14
Removing the Keyboard.....	14
Installing the Keyboard.....	17
Removing the Access Panel.....	17
Installing the Access Panel.....	18
Removing the Optical Drive.....	18
Installing the Optical Drive.....	20
Removing The Hard Drive.....	20
Installing the Hard Drive.....	22
Removing the Wireless Local Area Network (WLAN) Card.....	23
Installing the Wireless Local Area Network (WLAN) Card.....	23
Removing the Memory Module.....	23
Installing the Memory Module.....	23
Removing the Right Base Panel.....	24

Installing the Right Base Panel.....	24
Removing the Thermal Module.....	25
Installing the Thermal Module.....	25
Removing the Processor.....	26
Installing the Processor.....	26
Removing the Palmrest.....	26
Installing the Palmrest.....	28
Removing the ExpressCard Reader Cage.....	29
Installing the ExpressCard Reader Cage.....	29
Removing the Bluetooth Module.....	30
Installing the Bluetooth module.....	30
Removing the Audio Board.....	30
Installing the Audio Board.....	31
Removing the Display Assembly.....	31
Installing the Display Assembly.....	34
Removing the Right Support Frame.....	34
Installing the Right Support Frame.....	35
Removing the Modem Card.....	35
Installing the Modem Card.....	36
Removing the Left Support Frame.....	36
Installing the Left Support Frame.....	37
Removing the System Board.....	37
Installing the System Board.....	40
Removing the Coin-Cell Battery.....	40
Installing the Coin-Cell Battery.....	41
Removing the Input/Output (I/O) Board.....	41
Installing the Input/Output (I/O) Board.....	42
Removing the Power Connector.....	43
Installing the Power Connector.....	44
Removing the System Fan.....	44
Installing the System Fan.....	46
Removing the Network Connector.....	46
Installing the Network Connector Jack.....	47
Removing the Speakers.....	47
Installing the Speakers.....	48
3 Docking Port Information.....	51
4 Specifications.....	53
Specifications.....	53
5 System Setup.....	59

Overview	59
Entering System Setup.....	59
System Setup Options.....	59
6 Diagnostics.....	69
Diagnostics.....	69
7 Contacting Dell.....	71
Contacting Dell.....	71

Working on Your Computer

Before Working Inside Your Computer

Use the following safety guidelines to help protect your computer from potential damage and to help to ensure your personal safety. Unless otherwise noted, each procedure included in this document assumes that the following conditions exist:

- You have read the safety information that shipped with your computer.
- A component can be replaced or--if purchased separately--installed by performing the removal procedure in reverse order.

 **WARNING:** Before working inside your computer, read the safety information that shipped with your computer. For additional safety best practices information, see the Regulatory Compliance Homepage at www.dell.com/regulatory_compliance

 **CAUTION:** Many repairs may only be done by a certified service technician. You should only perform troubleshooting and simple repairs as authorized in your product documentation, or as directed by the online or telephone service and support team. Damage due to servicing that is not authorized by Dell is not covered by your warranty. Read and follow the safety instructions that came with the product.

 **CAUTION:** To avoid electrostatic discharge, ground yourself by using a wrist grounding strap or by periodically touching an unpainted metal surface, such as a connector on the back of the computer.

 **CAUTION:** Handle components and cards with care. Do not touch the components or contacts on a card. Hold a card by its edges or by its metal mounting bracket. Hold a component such as a processor by its edges, not by its pins.

 **CAUTION:** When you disconnect a cable, pull on its connector or on its pull-tab, not on the cable itself. Some cables have connectors with locking tabs; if you are disconnecting this type of cable, press in on the locking tabs before you disconnect the cable. As you pull connectors apart, keep them evenly aligned to avoid bending any connector pins. Also, before you connect a cable, ensure that both connectors are correctly oriented and aligned.

 **NOTE:** The color of your computer and certain components may appear differently than shown in this document.

To avoid damaging your computer, perform the following steps before you begin working inside the computer.

1. Ensure that your work surface is flat and clean to prevent the computer cover from being scratched.
2. Turn off your computer (see Turning Off Your Computer).

 **CAUTION:** To disconnect a network cable, first unplug the cable from your computer and then unplug the cable from the network device.

3. Disconnect all network cables from the computer.
4. Disconnect your computer and all attached devices from their electrical outlets.
5. Press and hold the power button while the computer is unplugged to ground the system board.
6. Remove the cover.

 **CAUTION:** Before touching anything inside your computer, ground yourself by touching an unpainted metal surface, such as the metal at the back of the computer. While you work, periodically touch an unpainted metal surface to dissipate static electricity, which could harm internal components.

Turning Off Your Computer

 **CAUTION:** To avoid losing data, save and close all open files and exit all open programs before you turn off your computer.

1. Shut down the operating system:

– In Windows 7:

Click **Start** , then click **Shut Down**.

– In Windows Vista:

Click **Start** , then click the arrow in the lower-right corner of the **Start** menu as shown below, and then click **Shut Down**.



– In Windows XP:

Click **Start** → **Turn Off Computer** → **Turn Off**. The computer turns off after the operating system shutdown process is complete.

2. Ensure that the computer and all attached devices are turned off. If your computer and attached devices did not automatically turn off when you shut down your operating system, press and hold the power button for about 6 seconds to turn them off.

After Working Inside Your Computer

After you complete any replacement procedure, ensure you connect any external devices, cards, and cables before turning on your computer.

1. Replace the cover.

 **CAUTION:** To connect a network cable, first plug the cable into the network device and then plug it into the computer.

2. Connect any telephone or network cables to your computer.

3. Connect your computer and all attached devices to their electrical outlets.

4. Turn on your computer.

5. If required, verify that the computer works correctly by running the Dell Diagnostics.

Removing and Installing Components

This section provides detailed information on how to remove or install the components from your computer.

Recommended Tools

The procedures in this document may require the following tools:

- Small flat-blade screwdriver
- Phillips screwdriver
- Small plastic scribe

Removing the SD Memory Card

1. Follow the procedures in *Before Working Inside Your Computer*.
2. Press in on the SD memory card to release it from the computer.
3. Slide the SD memory card out of the computer.



Installing the SD Memory Card

1. Push the memory card into the compartment until it clicks into place.
2. Follow the procedures in *After Working Inside Your Computer*.

Removing the Battery

1. Follow the procedures in *Before Working Inside Your Computer*.
2. Slide the battery release latches into the unlock position.



3. Remove the battery from the computer.



Installing the Battery

1. Slide the battery into its slot until it clicks into place.
2. Follow the procedures in *After Working Inside Your Computer*.

Removing the Subscriber Identity Module (SIM) Card

1. Follow the procedures in *Before Working Inside Your Computer*.
2. Remove the battery.
3. Press and release the SIM card located on the battery wall.
4. Slide the SIM card from the computer.



Installing the Subscriber Identity Module (SIM) Card

1. Insert the subscriber identity module (SIM) card into the slot.
2. Install the battery.

3. Follow the procedures in *After Working Inside Your Computer*.

Removing the Display Bezel

1. Follow the procedures in *Before Working Inside Your Computer*.
2. Remove the battery.
3. Pry up the bottom edge of the display bezel.
4. Work your way around the sides and top edge .

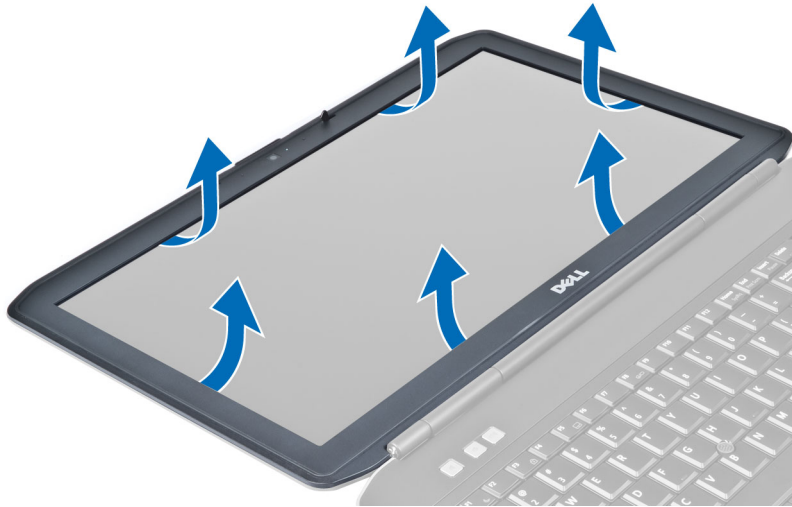

5. Remove the display bezel from the computer .

Installing the Display Bezel

1. Place the display bezel onto the display assembly.
2. Starting from the top corner, press on the display bezel and work around the entire bezel until it snaps onto the display assembly.
3. Install the battery.
4. Follow the procedures in *After Working Inside Your Computer*.

Removing the Camera

1. Follow the procedures in *Before Working Inside Your Computer*.
2. Remove:
 - a) battery
 - b) display bezel
3. Disconnect the camera cable.
4. Remove the screw that secures the camera and microphone module.
5. Lift and remove the camera and microphone module.

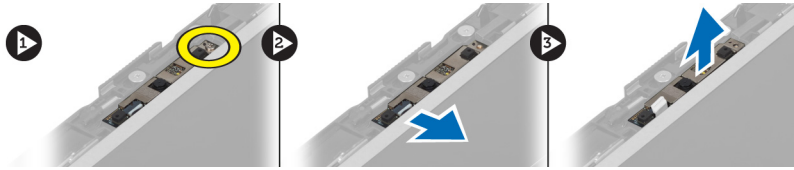

Installing the Camera

1. Place the camera and microphone module in position on the display bezel.
2. Tighten the screw that secures the camera and microphone module.
3. Connect the camera cable.
4. Install:
 - a) display bezel
 - b) battery
5. Follow the procedures in *After Working Inside Your Computer*.

Removing the Display Panel

1. Follow the procedures in *Before Working Inside Your Computer*.
2. Remove:
 - a) battery
 - b) display bezel
3. Remove the screws that secure the display panel.

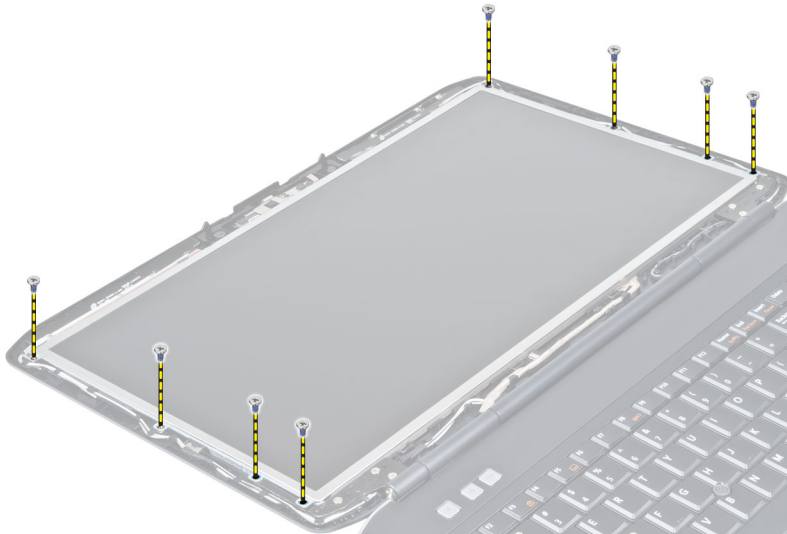

4. Flip the display panel over.



5. Lift the Mylar tape and disconnect the LVDS cable from the back of the display panel.

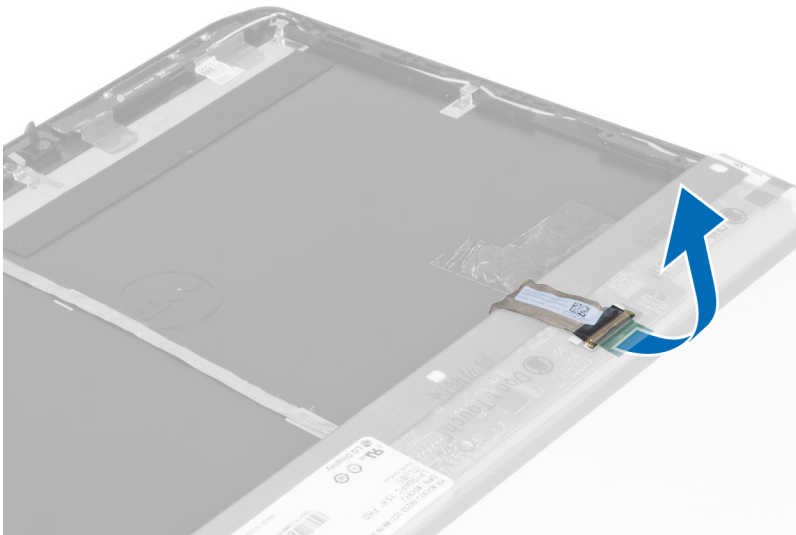

6. Remove the display panel from the display assembly.

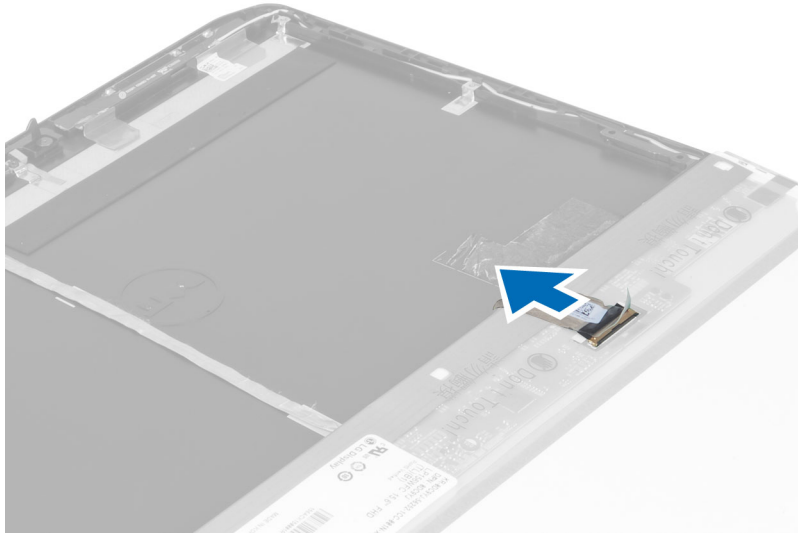

Installing the Display Panel

1. Install the screws that secure the display brackets to the display panel.
2. Attach the display panel to the display assembly.
3. Align the display panel in its original position in the computer.
4. Connect the low-voltage differential signaling (LVDS) cable to the display panel and attach the tape.
5. Flip the display panel over and install the screws that secure the display panel.
6. Install:
 - a) display bezel
 - b) battery
7. Follow the procedures in *After Working Inside Your Computer*.

Removing the Keyboard Trim

1. Follow the procedures in *Before Working Inside Your Computer*.
2. Remove the battery.
3. Remove the screws at the back of the computer.

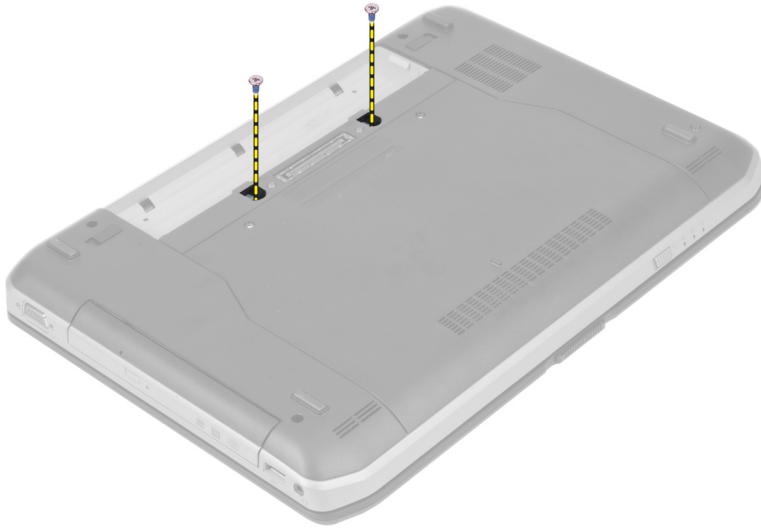

4. Pry up the keyboard trim starting from the bottom edge.

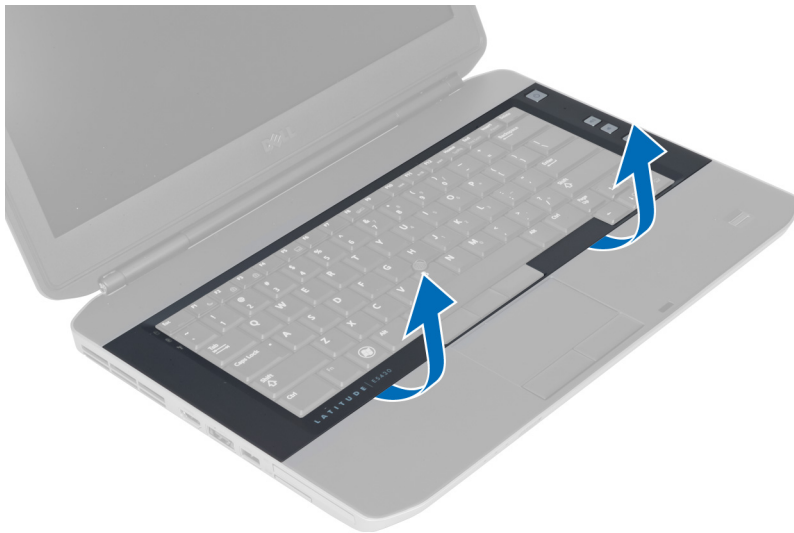

5. Work your way around the sides and the top edge of the keyboard trim.
6. Lift upwards and remove the keyboard trim from the computer.

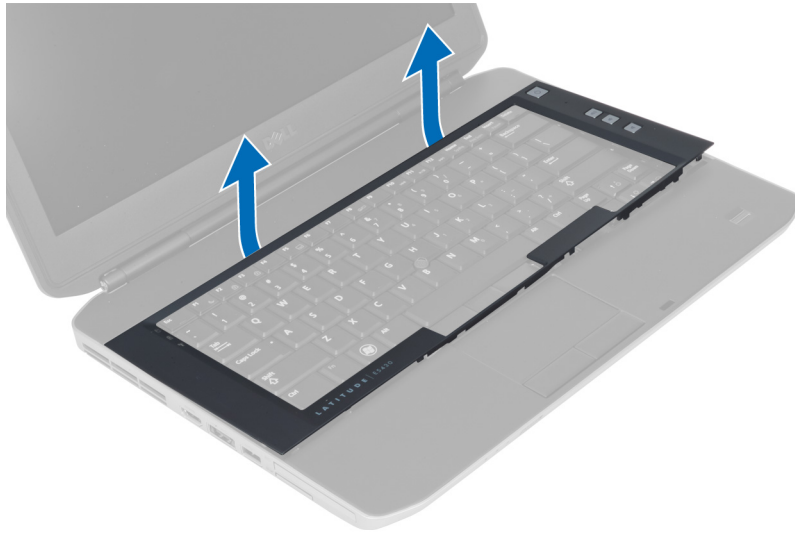

Installing the Keyboard Trim

1. Align the keyboard trim to its compartment.
2. Press along the sides of the keyboard trim until it snaps in place.
3. Install the battery.
4. Follow the procedures in *After Working Inside Your Computer*.

Removing the Keyboard

1. Follow the procedures in *Before Working Inside Your Computer*.
2. Remove:
 - a) battery
 - b) keyboard trim
3. Remove the screw at the back of the computer.

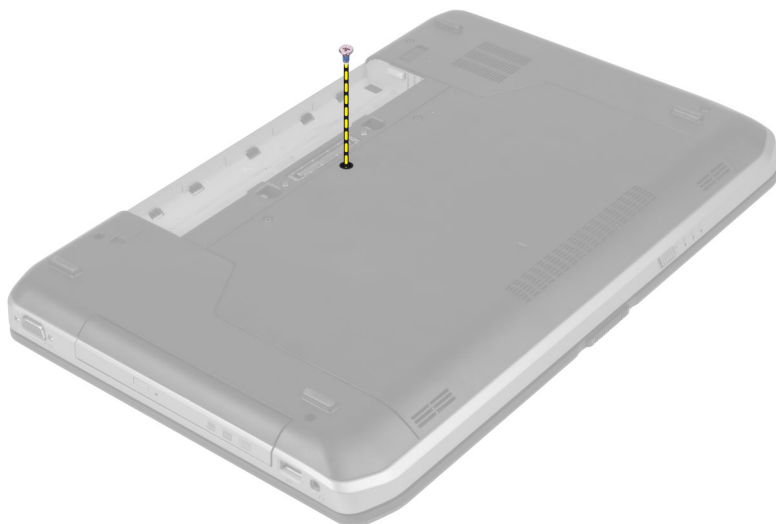

4. Lift the clip to release the keyboard trim from the computer .

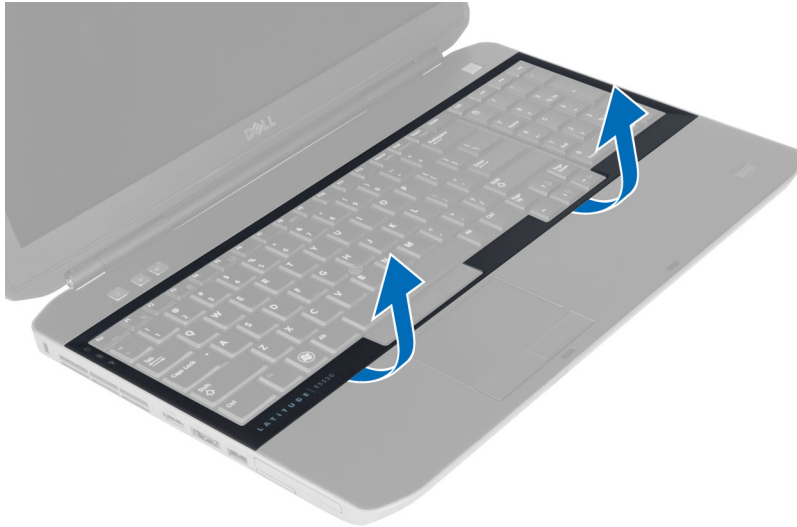

5. Remove the keyboard trim from the computer .



6. Remove the screws that secure the keyboard in place.



7. Flip the keyboard over.



8. Peel off the adhesive tape securing the keyboard flat flex cable to the back of the keyboard.
9. Disconnect the keyboard flat flex cable.
10. Peel away the keyboard flat flex cable from the keyboard and remove it from the computer.

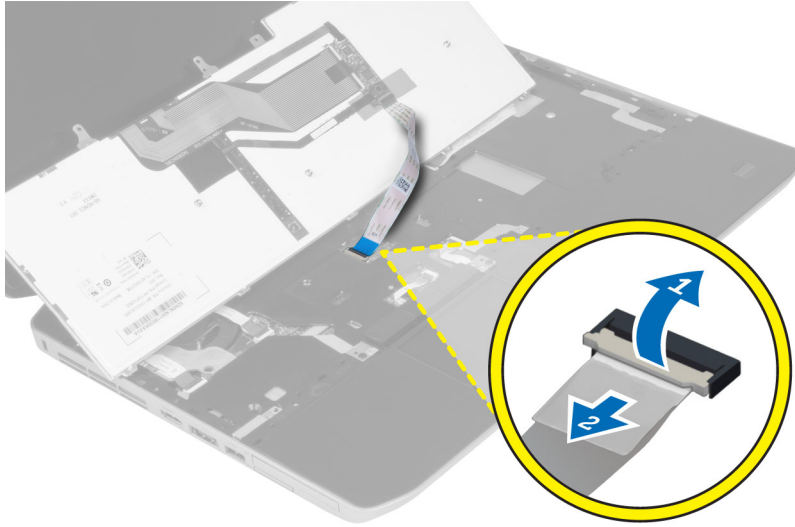

Installing the Keyboard

1. Attach the keyboard flat flex cable to the keyboard.
2. Affix the adhesive tape securing the keyboard flat flex cable to the keyboard.
3. Slide the keyboard into its compartment until all the metal tabs fit into their positions.
4. Fasten the keyboard cable clip.
5. Press down on the keyboard to the left and right side ensuring that all the snaps are fully engaged with the computer.
6. Install the screws that secure the keyboard to the palm rest.
7. Install the screw at the back of the computer.
8. Install :
 - a) keyboard trim
 - b) battery
9. Follow the procedures in *After Working Inside Your Computer*.

Removing the Access Panel

1. Follow the procedures in *Before Working Inside Your Computer*.
2. Remove the battery.
3. Remove the screws that secure the access panel.



4. Slide and then lift the access panel upwards and remove it from the computer.

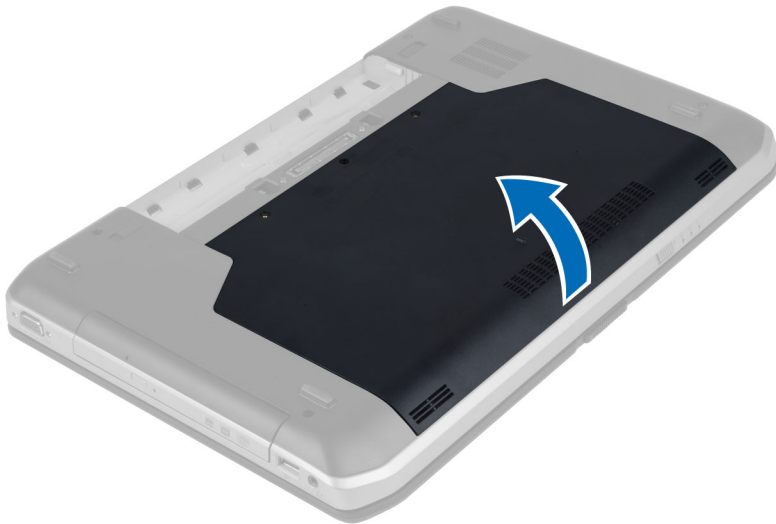

Installing the Access Panel

1. Slide the access panel into its slot until it clicks into place.
2. Install the screws that secure the access panel to the computer.
3. Install the battery.
4. Follow the procedures in *After Working Inside Your Computer*.

Removing the Optical Drive

1. Follow the procedures in *Before Working Inside Your Computer*.
2. Remove:
 - a) battery
 - b) access panel

3. Remove the screw that secures the optical drive.

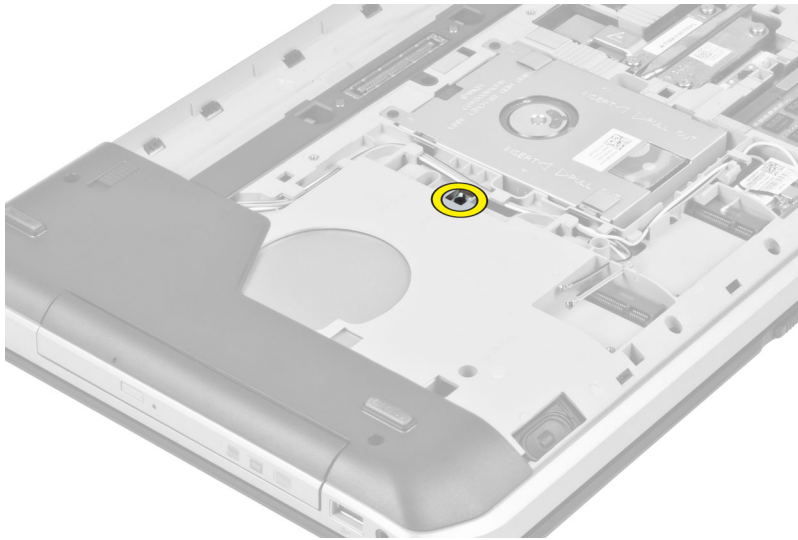

4. Push the screw tab away from the computer to release the optical drive from the drive bay.

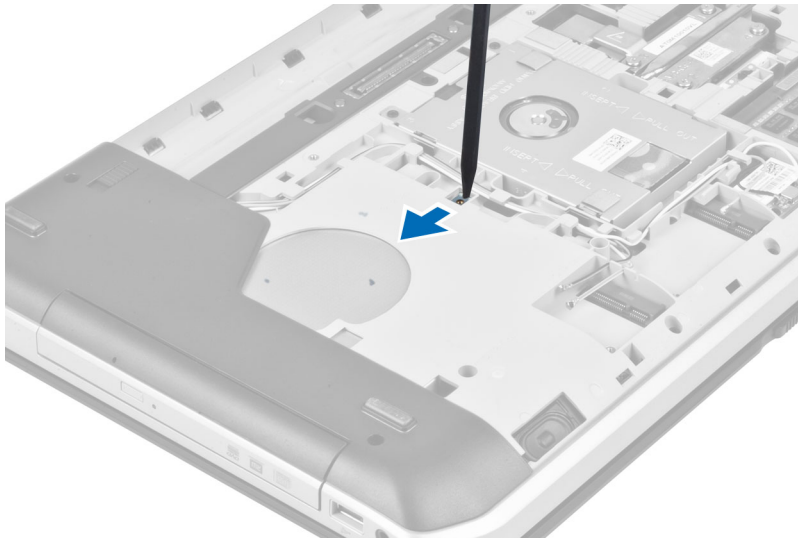

5. Remove the optical drive from the computer.

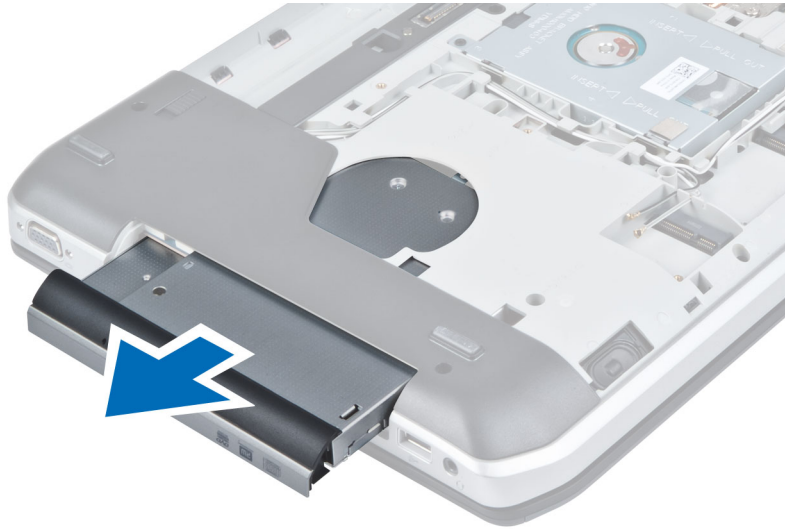

6. Remove the screws that secure the optical drive bracket.
7. Remove the optical drive bracket.

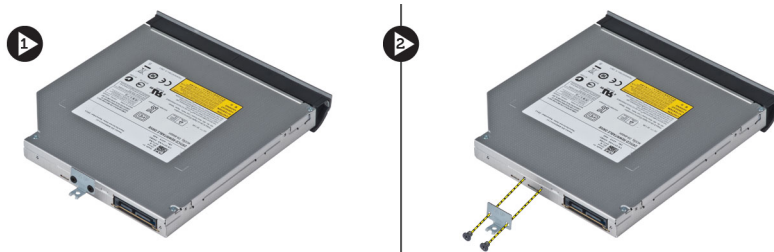

8. Disengage the optical drive bezel tabs to separate the optical drive bezel from the optical drive.
9. Remove the optical drive bezel.

Installing the Optical Drive

1. Engage the optical drive bezel tabs to attach the optical drive bezel to the optical drive.
2. Install the optical drive bracket.
3. Install the screws that secure the optical drive bracket.
4. Insert the optical drive into the computer.
5. Install the screw that secures the optical drive in place.
6. Install :
 - a) access panel
 - b) battery
7. Follow the procedures in *After Working Inside Your Computer*.

Removing The Hard Drive

1. Follow the procedures in *Before Working Inside Your Computer*.
2. Remove:
 - a) battery
 - b) access panel

3. Remove the screws that secure the hard drive bracket in place.

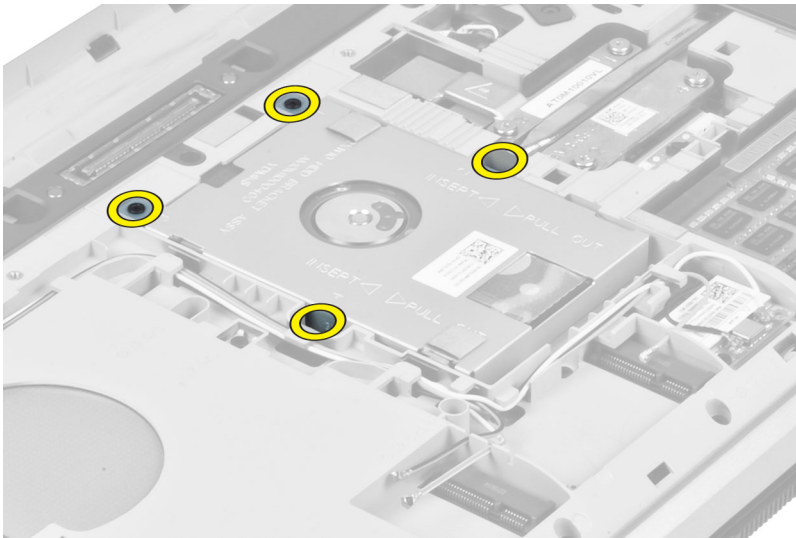

4. Use the tab to pull the hard drive bracket and release the hard drive from its connector.

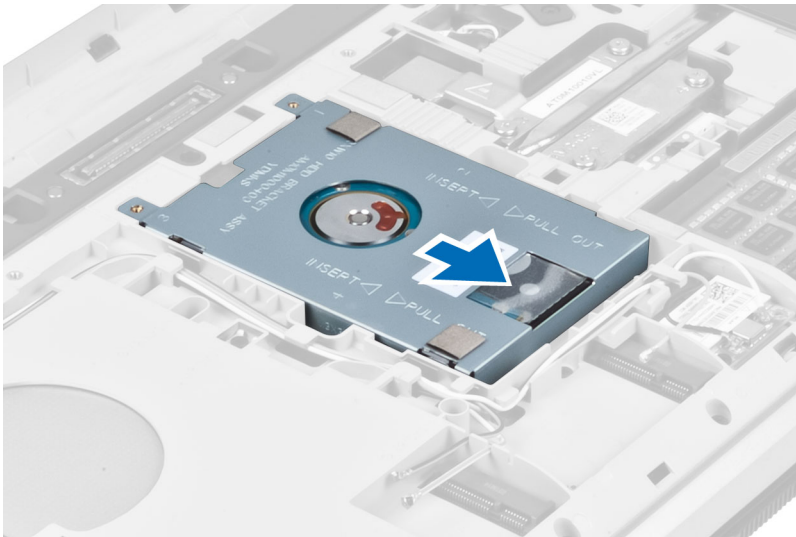

5. Remove the hard drive from the computer.

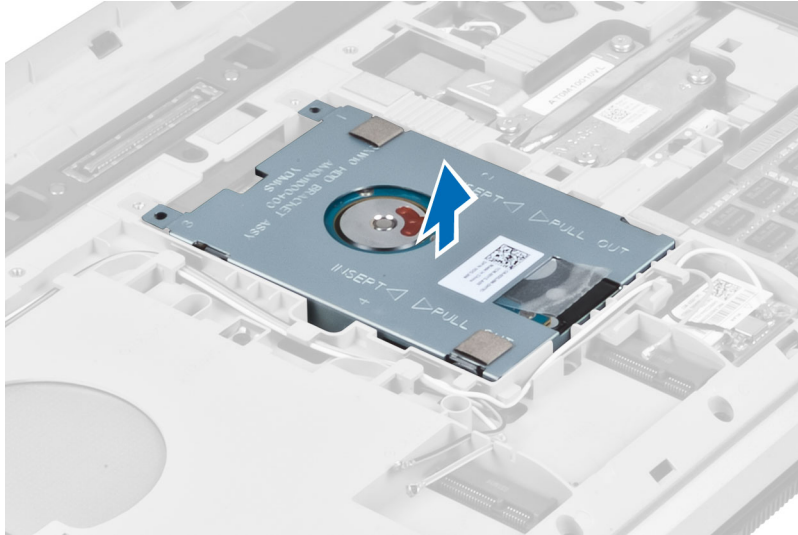

6. Remove the screws that secure the hard drive bracket.

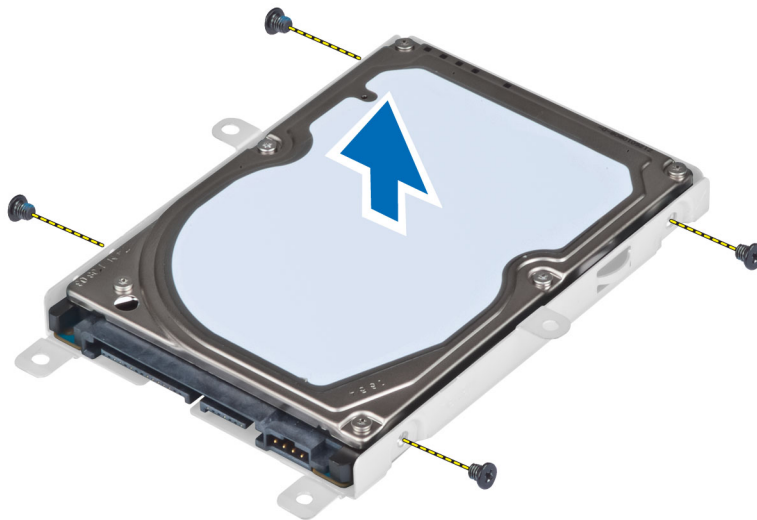

7. Remove the hard drive bracket from the hard drive.

Installing the Hard Drive

1. Engage the hard drive bracket to the hard drive.
2. Install the screws that secure the hard drive bracket.
3. Install the hard drive into the computer.
4. Install the screw that secures the hard drive bracket in place.
5. Install:
 - a) base panel
 - b) battery
6. Follow the procedures in *After Working Inside Your Computer*.

Removing the Wireless Local Area Network (WLAN) Card

1. Follow the procedures in *Before Working Inside Your Computer*.
2. Remove:
 - a) battery
 - b) access panel
3. Disconnect the antennae cables from the WLAN card.
4. Remove the screw that secures the WLAN card to the computer.
5. Remove the WLAN card from its slot on the system board.

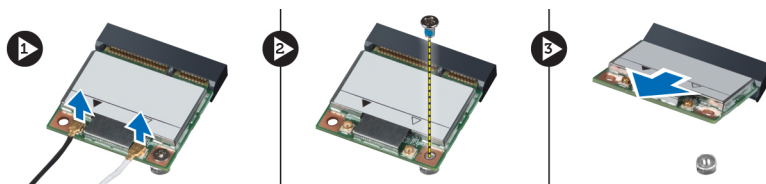

Installing the Wireless Local Area Network (WLAN) Card

1. Insert the WLAN card into its connector at a 45-degree angle into its slot.
2. Connect the antenna cables to their respective connectors marked on the WLAN card.
3. Replace and tighten the screw to secure the WLAN card to the computer.
4. Install:
 - a) access panel
 - b) battery
5. Follow the procedures in *After Working Inside Your Computer*.

Removing the Memory Module

1. Follow the procedures in *Before Working Inside Your Computer*.
2. Remove:
 - a) battery
 - b) access panel
3. Pry the retention clips away from the memory module until it pops up.
4. Lift up the memory module and remove it from the computer.

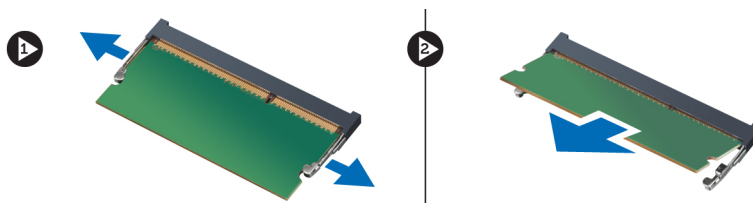

Installing the Memory Module

1. Insert the memory into the memory socket.
2. Press the clips to secure the memory module to the system board.

3. Install:
 - a) access panel
 - b) battery
4. Follow the procedures in *After Working Inside Your Computer*.

Removing the Right Base Panel

1. Follow the procedures in *Before Working Inside Your Computer*.
2. Remove:
 - a) battery
 - b) access panel
3. Remove the screws that secure the right base panel in place.

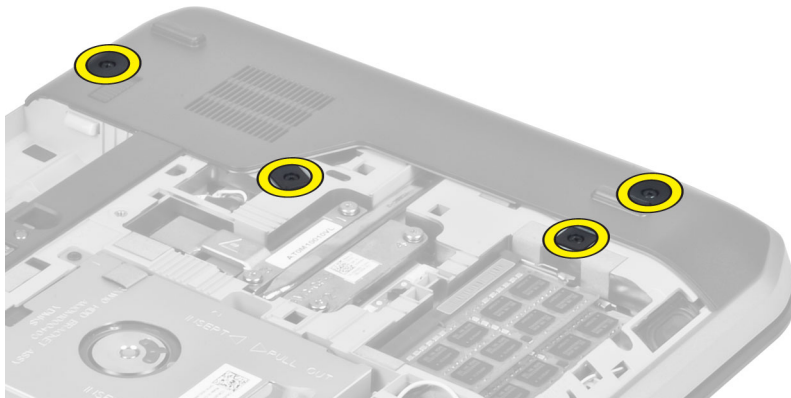

4. Remove the right base panel from the computer.

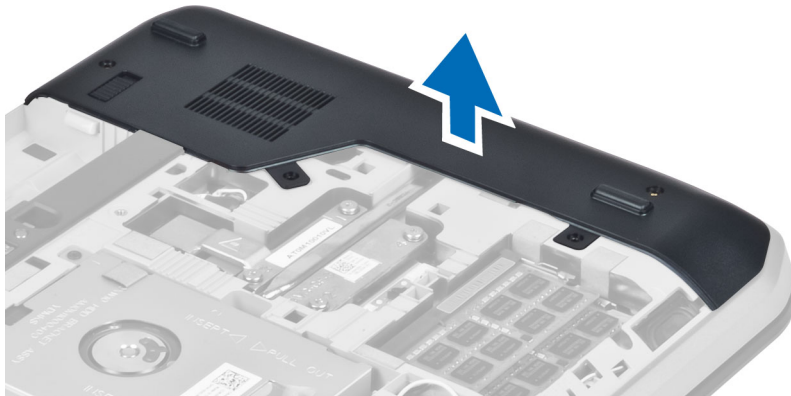

Installing the Right Base Panel

1. Place the right base panel in its location at the bottom of the computer.
2. Install the screws that secure the right base panel to the bottom of the computer.
3. Install :
 - a) access panel
 - b) battery
4. Follow the procedures in *After Working Inside Your Computer*.

Removing the Thermal Module

1. Follow the procedures in *Before Working Inside Your Computer*.
2. Remove:
 - a) SD memory card
 - b) battery
 - c) access panel
 - d) right base panel
3. Remove the screws that secure the thermal module in place.

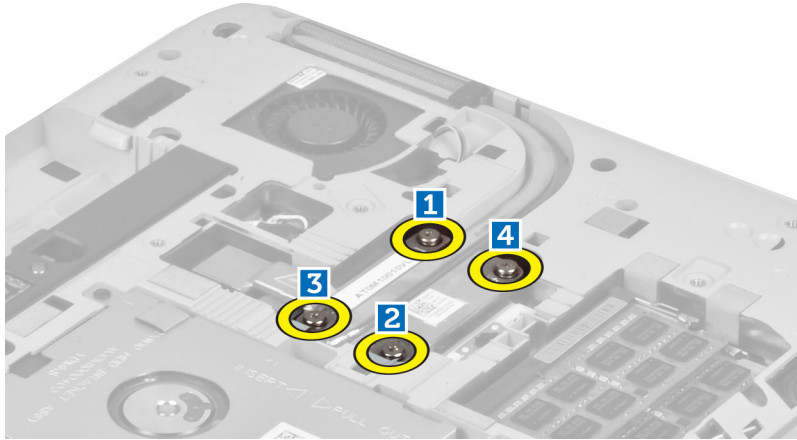

4. Lift up the thermal module and remove it from the computer.

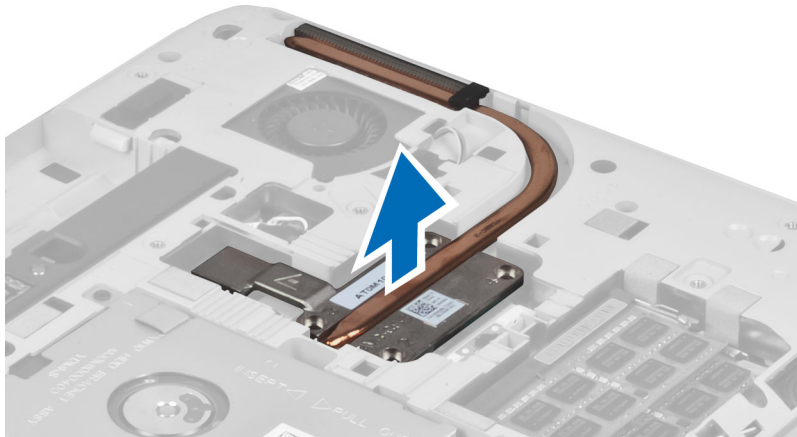

Installing the Thermal Module

1. Place the thermal module in its compartment.
2. Install the screws that secure the thermal module to the computer.
3. Install :
 - a) right base panel
 - b) access panel
 - c) battery

d) SD memory card

4. Follow the procedures in *After Working Inside Your Computer*.

Removing the Processor

1. Follow the procedures in *Before Working Inside Your Computer*.

2. Remove:

- a) SD memory card
- b) battery
- c) access panel
- d) right base panel
- e) thermal module

3. Rotate the processor cam lock in a counter clockwise direction to the unlock position. Lift up the processor and remove it from the computer.

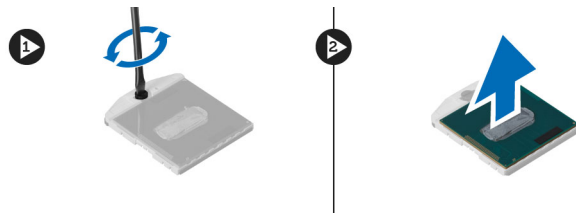

Installing the Processor

1. Place the processor in its socket on the computer.

2. Rotate the processor cam lock in a clockwise direction to secure the processor.

3. Install:

- a) thermal module
- b) access panel
- c) right base panel
- d) battery
- e) SD memory card

4. Follow the procedures in *After Working Inside Your Computer*.

Removing the Palmrest

1. Follow the procedures in *Before Working Inside Your Computer*.

2. Remove:

- a) SD memory card
- b) battery
- c) access panel
- d) keyboard trim
- e) keyboard
- f) optical drive
- g) right base panel
- h) hard drive

3. Remove the screws that secure the bottom of the computer.

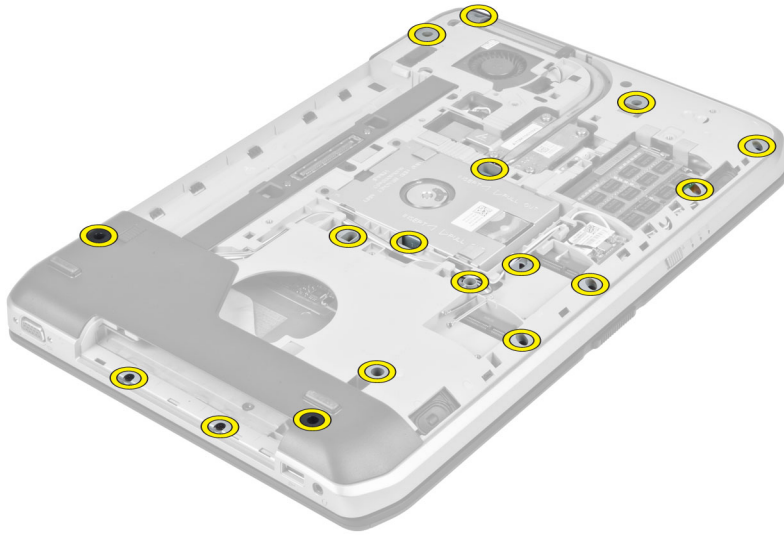

4. Disconnect the :
- a) LED board flat flex cable
 - b) media button flat flex cable
 - c) touchpad flat flex cable
 - d) fingerprint scanner flat flex cable
 - e) power button flat flex cable

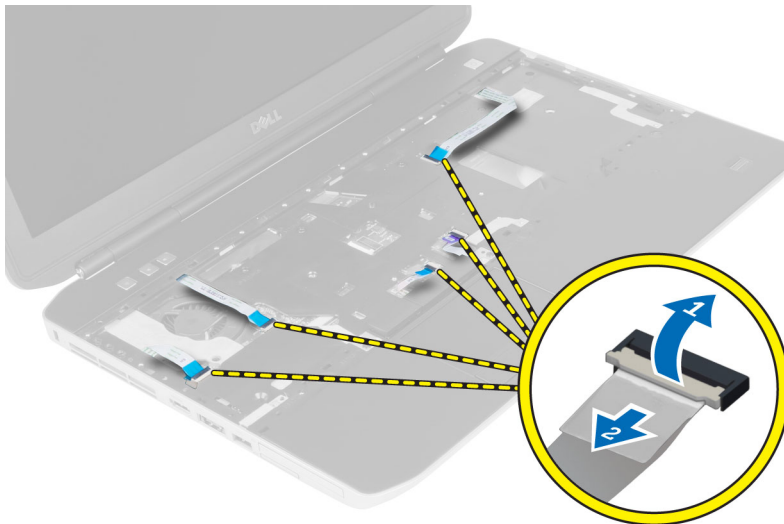

5. Remove the screws that secure the palmrest on the computer.



6. Lift up the right edge of palmrest assembly.
7. Release the tabs on the left edge of the palmrest assembly and remove the palmrest from the computer.



Installing the Palmrest

1. Align the palmrest assembly to its original position in the computer and snap it into place.
2. Connect the following cables to the system board:
 - a) power button flat flex cable.
 - b) fingerprint scanner flat flex cable
 - c) touchpad flat flex cable
 - d) media button flat flex cable
 - e) LED board flat flex cable
3. Install the screws on the palmrest.
4. Install the screws at the bottom of the computer.
5. Install :

- a) right base panel
- b) optical drive
- c) keyboard
- d) keyboard trim
- e) access panel
- f) battery
- g) SD memory card

6. Follow the procedures in *After Working Inside Your Computer*.

Removing the ExpressCard Reader Cage

1. Follow the procedures in *Before Working Inside Your Computer*.
2. Remove:
 - a) SD memory card
 - b) battery
 - c) access panel
 - d) keyboard trim
 - e) keyboard
 - f) optical drive
 - g) right base panel
 - h) palmrest
3. Remove the screws that secure the ExpressCard reader cage in place.
4. Remove the ExpressCard reader cage from the computer.

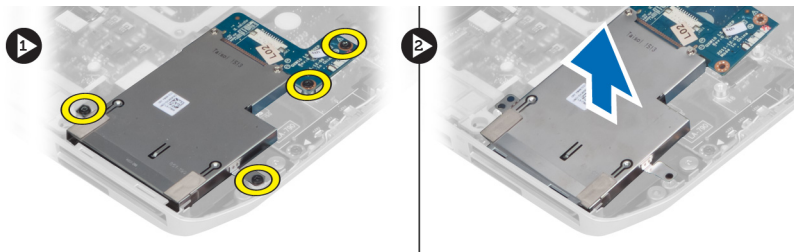

Installing the ExpressCard Reader Cage

1. Align the ExpressCard reader cage to its original position in the computer and snap it into place.
2. Install the screws that secure the ExpressCard reader cage.
3. Install:
 - a) palmrest
 - b) right base panel
 - c) optical drive
 - d) keyboard
 - e) keyboard trim
 - f) access panel
 - g) battery
 - h) SD memory card
4. Follow the procedures in *After Working Inside Your Computer*.

Removing the Bluetooth Module

1. Follow the procedures in *Before Working Inside Your Computer*.
2. Remove:
 - a) SD memory card
 - b) battery
 - c) access panel
 - d) keyboard trim
 - e) keyboard
 - f) optical drive
 - g) right base panel
 - h) palm rest
3. Disconnect the Bluetooth cable from the system board and remove the screw that secures the Bluetooth module in place.

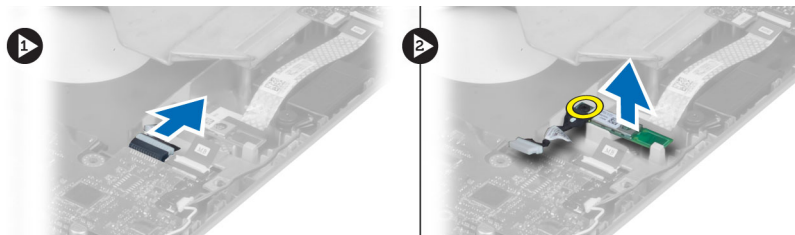

4. Remove the Bluetooth module from the computer.
5. Disconnect the Bluetooth cable from the Bluetooth module.

Installing the Bluetooth module

1. Connect the Bluetooth cable to the Bluetooth module.
2. Place the Bluetooth module into its compartment on the computer.
3. Install the screw that secures the Bluetooth module.
4. Connect the Bluetooth cable to the system board.
5. Install :
 - a) palm rest
 - b) right base panel
 - c) optical drive
 - d) keyboard
 - e) keyboard trim
 - f) access panel
 - g) battery
 - h) SD memory card
6. Follow the procedures in *After Working Inside Your Computer*.

Removing the Audio Board

1. Follow the procedures in *Before Working Inside Your Computer*.
2. Remove:
 - a) SD memory card

- b) battery
 - c) access panel
 - d) keyboard trim
 - e) keyboard
 - f) optical drive
 - g) right base panel
 - h) palmrest
 - i) bluetooth module
3. Disconnect the audio board flat flex cable from the system board and remove the screw that secures the audio board in place.

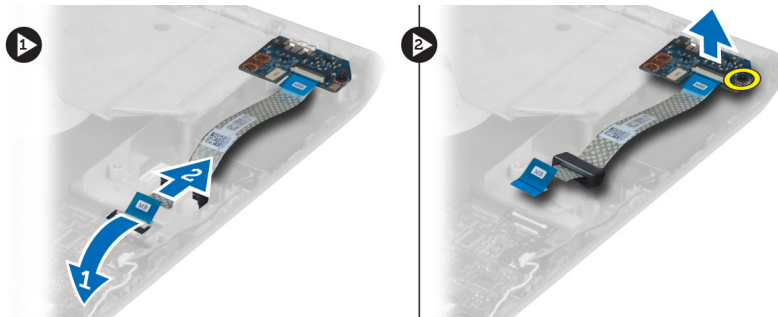

4. Remove the audio board from the computer.

Installing the Audio Board

1. Place the audio board in the computer.
2. Tighten the screw to secure the audio board to the computer.
3. Connect the audio board cable to the system board.
4. Install:
 - a) Bluetooth module
 - b) palmrest
 - c) right base panel
 - d) optical drive
 - e) keyboard
 - f) keyboard trim
 - g) access panel
 - h) battery
 - i) SD memory card
5. Follow the procedures in *After Working Inside Your Computer*.

Removing the Display Assembly

1. Follow the procedures in *Before Working Inside Your Computer*.
2. Remove:
 - a) SD memory card
 - b) battery
 - c) access panel
 - d) keyboard trim
 - e) keyboard

- f) optical drive
- g) hard drive
- h) right base panel
- i) palmrest

3. Disconnect and remove any antennas from the routing channels.

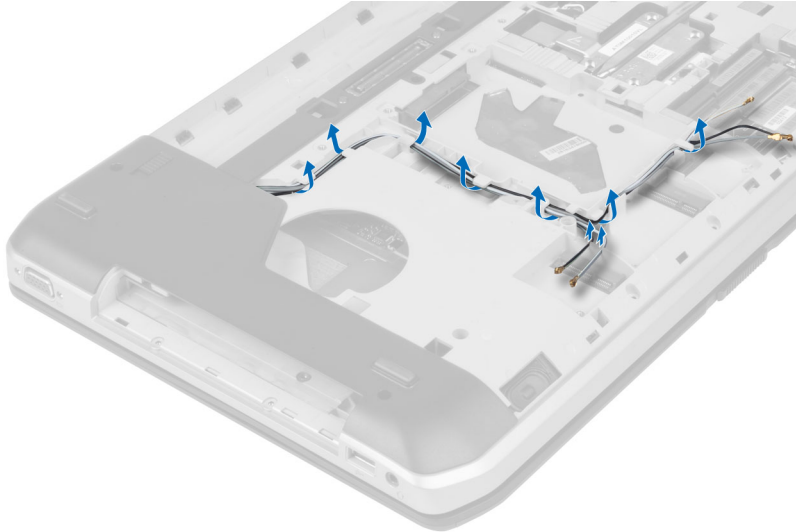

4. Disconnect the low-voltage differential signaling (LVDS) cable.

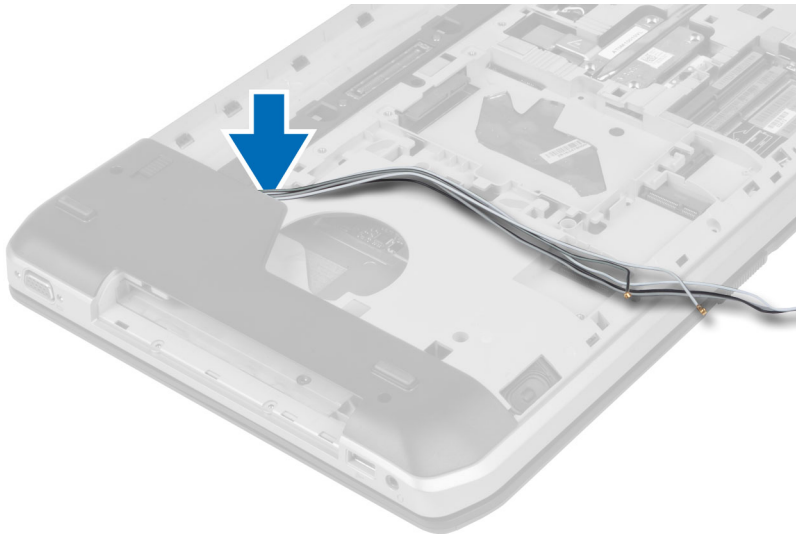

5. Pull the antennas through the opening to the top of the computer.



6. Lift up the connector indicated on the system board.



7. Remove the screws that secure the display assembly in place.



8. Remove the display assembly from the computer.

Installing the Display Assembly

1. Install the screws that secure the display assembly in place.
2. Insert the low-voltage differential signaling (LVDS) cable and wireless antenna cables through the holes on the chassis.
3. Route the LVDS cable along its compartment and connect the connector to the system board.
4. Connect the antenna cables to their connectors.
5. Install :
 - a) palmrest
 - b) right access panel
 - c) optical drive
 - d) keyboard
 - e) keyboard trim
 - f) access panel
 - g) battery
 - h) SD memory card
6. Follow the procedures in *After Working Inside Your Computer*.

Removing the Right Support Frame

1. Follow the procedures in *Before Working Inside Your Computer*.
2. Remove:
 - a) SD memory card
 - b) battery
 - c) access panel
 - d) keyboard trim
 - e) optical drive
 - f) hard drive
 - g) right base panel
 - h) palmrest
 - i) display assembly
3. Remove the screws that secure the right support frame to the computer.
4. Lift the right support frame away from the computer.

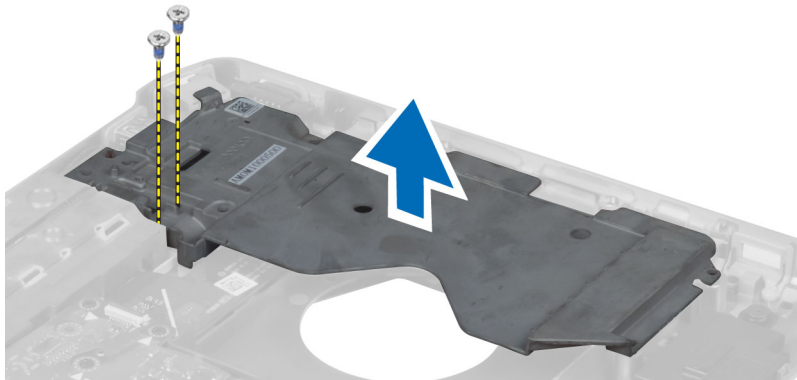

Installing the Right Support Frame

1. Place the right support frame on the computer.
2. Tighten the screws to secure the right support frame to the computer.
3. Install:
 - a) display assembly
 - b) palmrest
 - c) right base panel
 - d) hard drive
 - e) optical drive
 - f) keyboard
 - g) keyboard trim
 - h) access panel
 - i) battery
 - j) SD memory card
4. Follow the procedures in *After Working Inside Your Computer*.

Removing the Modem Card

1. Follow the procedures in *Before Working Inside Your Computer*.
2. Remove:
 - a) SD memory card
 - b) battery
 - c) access panel
 - d) keyboard trim
 - e) keyboard
 - f) optical drive
 - g) hard drive
 - h) right base panel
 - i) palmrest
 - j) display assembly
 - k) right support frame
3. Remove the screw that secures the modem card to the computer.
4. Lift the modem card to disengage from the connector on the back of the card.
5. Disconnect the network connector cable from the modem card.
6. Lift the modem card from the computer.

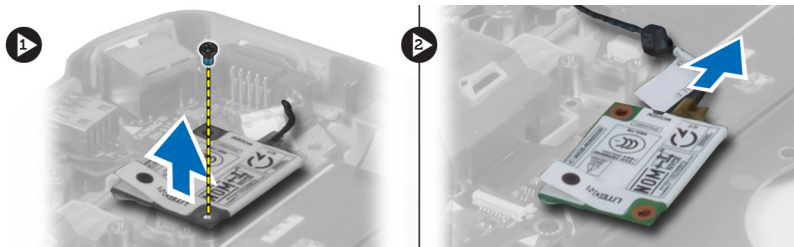

Installing the Modem Card

1. Place the modem card on the Input/Output (I/O) board in the computer.
2. Connect the network connector cable to the modem card.
3. Engage the modem card to the connector located at the back of the computer.
4. Tighten the screw to secure the modem card to the computer.
5. Install:
 - a) right support frame
 - b) display assembly
 - c) palmrest
 - d) right base panel
 - e) hard drive
 - f) optical drive
 - g) keyboard
 - h) keyboard trim
 - i) access panel
 - j) battery
 - k) SD memory card
6. Follow the procedures in *After Working Inside Your Computer*.

Removing the Left Support Frame

1. Follow the procedures in *Before Working Inside Your Computer*.
2. Remove:
 - a) SD memory card
 - b) battery
 - c) access panel
 - d) keyboard trim
 - e) keyboard
 - f) optical drive
 - g) hard drive
 - h) right base panel
 - i) palmrest
 - j) display assembly
3. Remove the screws that secure the left support frame to the computer.
4. Lift the left support frame away from the computer.

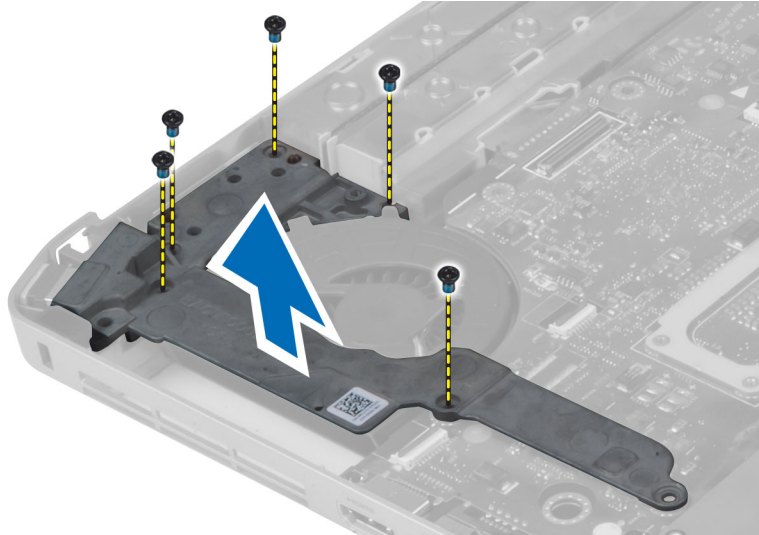

Installing the Left Support Frame

1. Place the left support frame on the computer.
2. Tighten the screws to secure the left support frame to the computer.
3. Install:
 - a) display assembly
 - b) palmrest
 - c) right base panel
 - d) hard drive
 - e) optical drive
 - f) keyboard
 - g) keyboard trim
 - h) access panel
 - i) battery
 - j) SD memory card
4. Follow the procedures in *After Working Inside Your Computer*.

Removing the System Board

1. Follow the procedures in *Before Working Inside Your Computer*.
2. Remove:
 - a) SD memory card
 - b) battery
 - c) access panel
 - d) keyboard trim
 - e) keyboard
 - f) optical drive
 - g) hard drive
 - h) WLAN card
 - i) right base panel
 - j) thermal module

- k) palmrest
- l) ExpressCard reader cage
- m) display assembly
- n) left support frame
- o) thermal fan cable

3. Disconnect:

- a) thermal fan cable
- b) DC-in cable
- c) Bluetooth cable

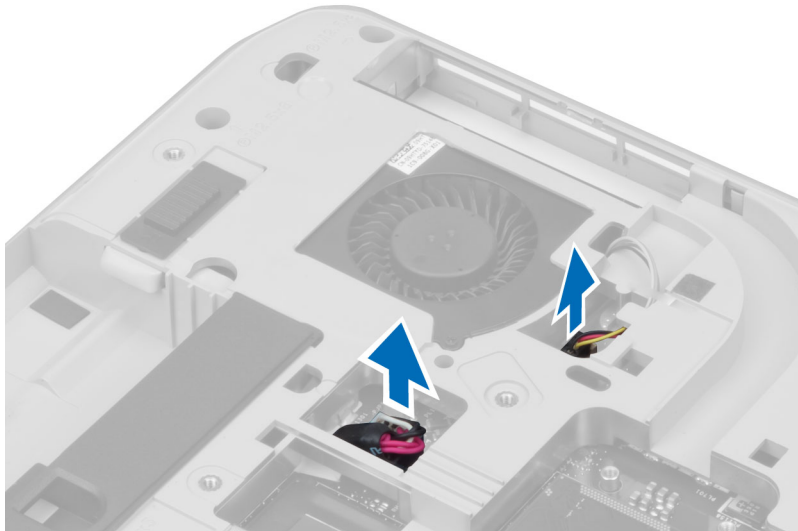

4. Disconnect the speaker cable and the audio board flex cable from the system board.

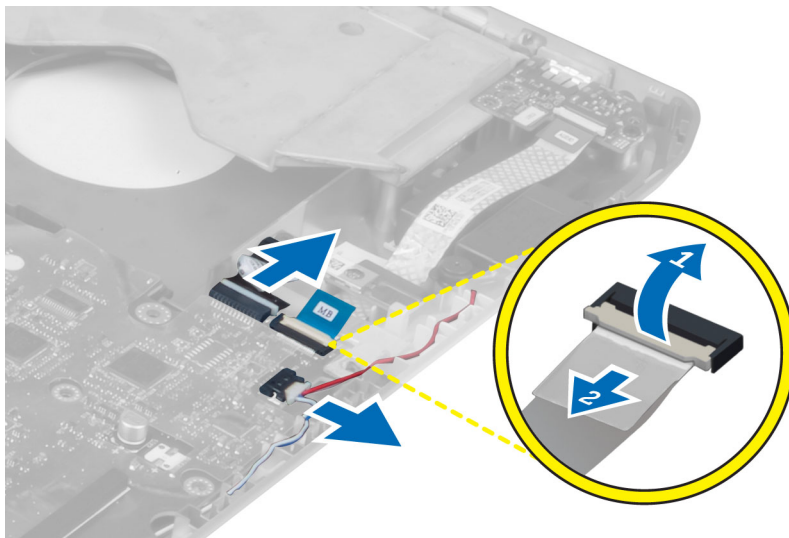

5. Remove the screws that secure the system board.

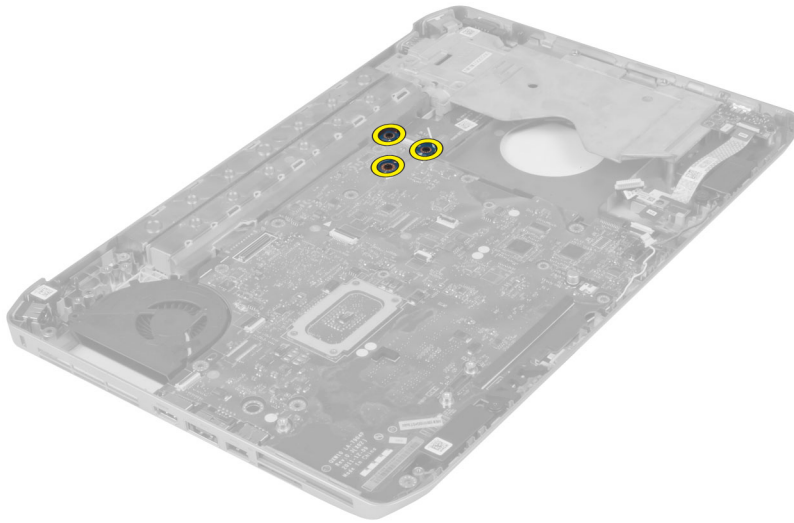

6. Lift the right edge of the system board assembly and raise it to a 45-degree angle.

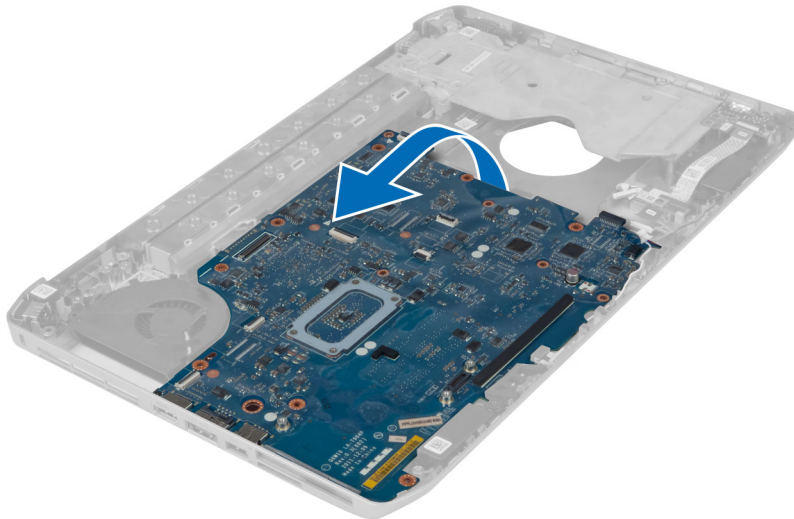

7. Release the system board from the port connectors on the left and remove the system board.

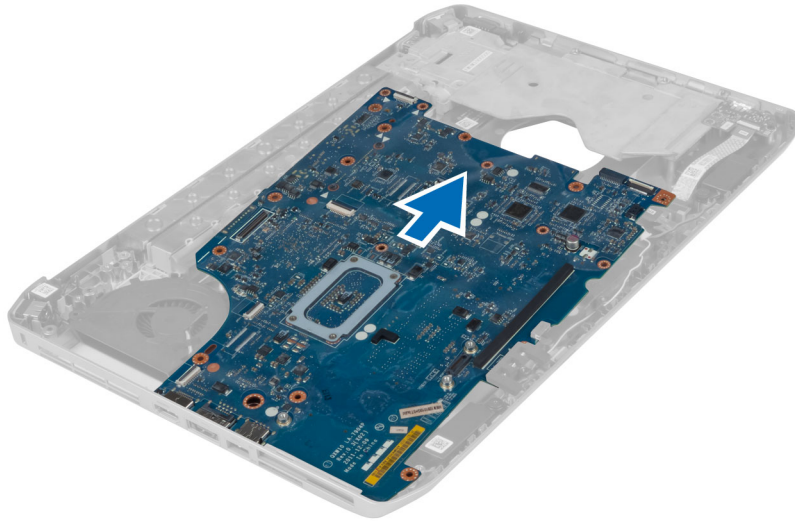

Installing the System Board

1. Align the system board into its original position on the computer.
2. Replace and tighten the screws to secure the system board to the computer.
3. Route and connect the following cables the system board:
 - a) audio board flat flex cable
 - b) Bluetooth cable
 - c) speaker cable
 - d) DC-in cable
 - e) thermal fan cable
4. Install :
 - a) left support frame
 - b) display assembly
 - c) ExpressCard reader cage
 - d) palm rest
 - e) thermal module
 - f) right base panel
 - g) hard drive
 - h) optical drive
 - i) keyboard
 - j) keyboard trim
 - k) access panel
 - l) battery
 - m) SD memory card
5. Follow the procedures in *After Working Inside Your Computer*.

Removing the Coin-Cell Battery

1. Follow the procedures in *Before Working Inside Your Computer*.
2. Remove:
 - a) SD memory card

- b) ExpressCard
 - c) battery
 - d) access panel
 - e) keyboard trim
 - f) optical drive
 - g) hard drive
 - h) WLAN card
 - i) right base panel
 - j) thermal module
 - k) palmrest
 - l) ExpressCard reader cage
 - m) display assembly
 - n) left support frame
 - o) system board
3. Disconnect the coin-cell battery from the system board.
 4. Pry the coin-cell battery from the adhesive and remove it.



Installing the Coin-Cell Battery

1. Place the coin-cell battery on the system board with adhesive side downwards.
2. Connect the coin-cell battery cable to the system board.
3. Install:
 - a) system board
 - b) left support frame
 - c) display assembly
 - d) ExpressCard reader cage
 - e) palmrest
 - f) thermal module
 - g) right base panel
 - h) WLAN card
 - i) hard drive
 - j) optical drive
 - k) keyboard
 - l) keyboard trim
 - m) access panel
 - n) battery
 - o) ExpressCard
 - p) SD memory card
4. Follow the procedures in *After Working Inside Your Computer*.

Removing the Input/Output (I/O) Board

1. Follow the procedures in *Before Working Inside Your Computer*.
2. Remove:

- a) SD memory card
 - b) battery
 - c) access panel
 - d) keyboard trim
 - e) keyboard
 - f) optical drive
 - g) hard drive
 - h) WLAN card
 - i) right base panel
 - j) thermal module
 - k) palmrest
 - l) ExpressCard reader cage
 - m) display assembly
 - n) right support frame
 - o) left support frame
 - p) system board
3. Remove the screws that secure the Input/Output (I/O) board in the computer.
 4. Lift the Input/Output (IO) board out of the computer.

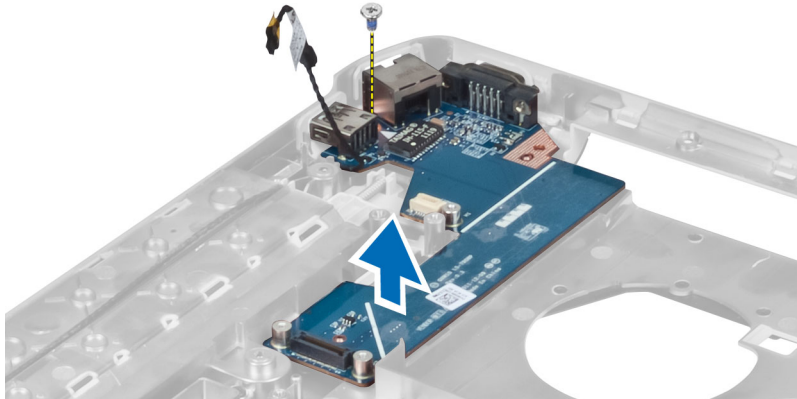

Installing the Input/Output (I/O) Board

1. Place the Input/Output (I/O) board in the computer.
2. Tighten the screw to secure the Input/Output (I/O) board to the computer.
3. Install:
 - a) system board
 - b) left support frame
 - c) right support frame
 - d) display assembly
 - e) ExpressCard reader cage
 - f) palmrest
 - g) thermal module
 - h) right base panel
 - i) WLAN card
 - j) hard drive
 - k) optical drive
 - l) keyboard

- m) keyboard trim
 - n) access panel
 - o) battery
 - p) SD memory card
4. Follow the procedures in *After Working Inside Your Computer*.

Removing the Power Connector

1. Follow the procedures in *Before Working Inside Your Computer*.
2. Remove:
 - a) SD memory card
 - b) battery
 - c) access panel
 - d) keyboard trim
 - e) keyboard
 - f) optical drive
 - g) hard drive
 - h) WLAN card
 - i) right base panel
 - j) thermal module
 - k) palmrest
 - l) ExpressCard reader cage
 - m) display assembly
 - n) left support bracket
 - o) system board
3. Remove the power connector cable from the routing channels.

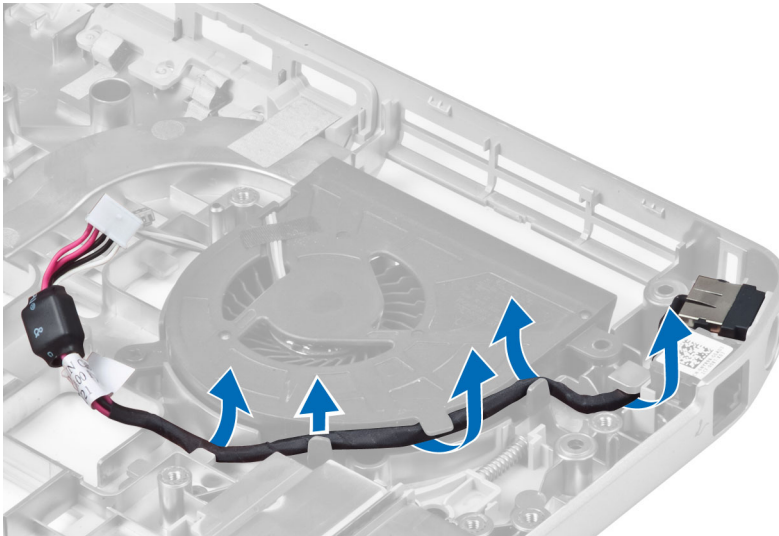

4. Remove the power connector.

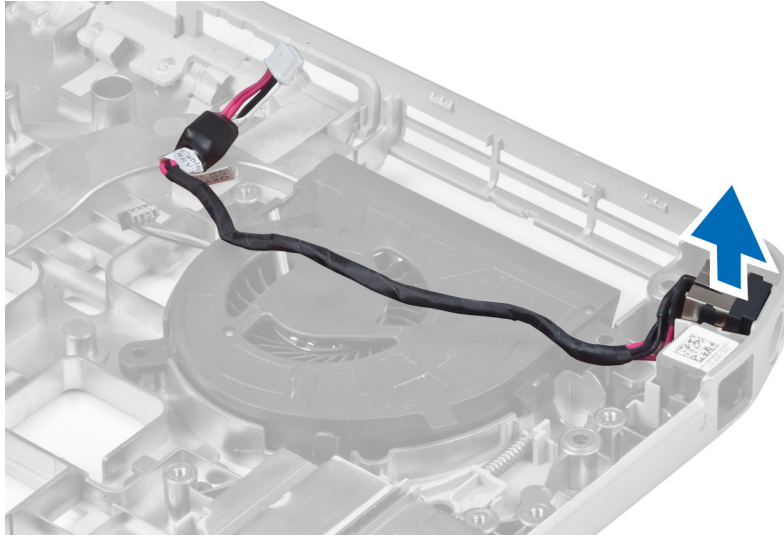

Installing the Power Connector

1. Install the power connector in the computer.
2. Thread the power connector cable in the routing channel.
3. Install:
 - a) system board
 - b) left support bracket
 - c) display assembly
 - d) ExpressCard reader cage
 - e) palmrest
 - f) thermal module
 - g) right base panel
 - h) WLAN card
 - i) hard drive
 - j) optical drive
 - k) keyboard
 - l) keyboard trim
 - m) access panel
 - n) battery
 - o) SD memory card
4. Follow the procedures in *After Working Inside Your Computer*.

Removing the System Fan

1. Follow the procedures in *Before Working Inside Your Computer*.
2. Remove:
 - a) SD memory card
 - b) battery
 - c) access panel
 - d) keyboard trim
 - e) keyboard

- f) optical drive
- g) hard drive
- h) WLAN card
- i) right base panel
- j) thermal module
- k) palmrest
- l) ExpressCard reader cage
- m) display assembly
- n) right support frame
- o) left support frame
- p) modem card
- q) network connector
- r) system board
- s) power connector

3. Remove the system fan cable from the routing channel.

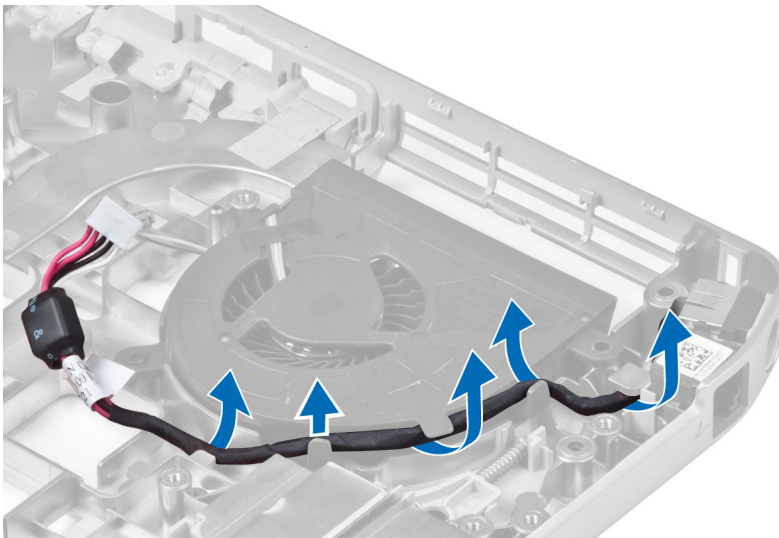

4. Remove the screw that secures the system fan and lift it to remove from the computer.

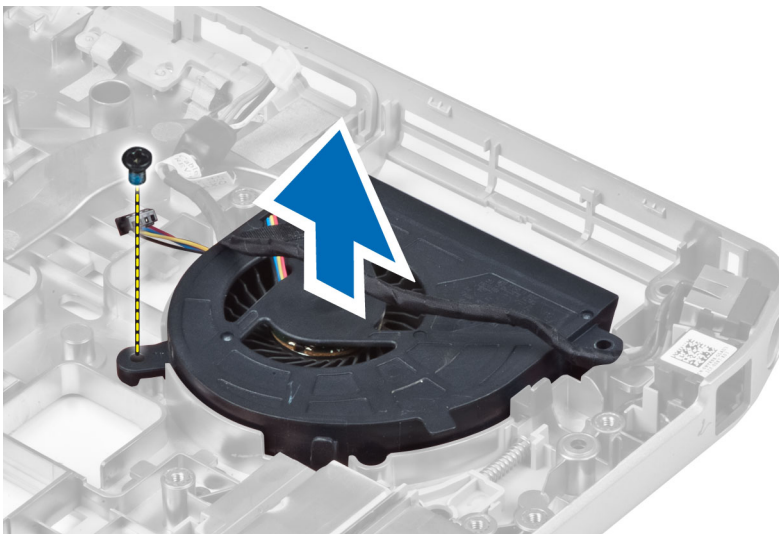

Installing the System Fan

1. Place the system fan in the computer.
2. Tighten the screws to secure the fan to the computer.
3. Install:
 - a) power connector
 - b) system board
 - c) network connector
 - d) modem card
 - e) left support frame
 - f) right support frame
 - g) display assembly
 - h) ExpressCard reader cage
 - i) palmrest
 - j) thermal module
 - k) right base panel
 - l) WLAN card
 - m) hard drive
 - n) optical drive
 - o) keyboard
 - p) keyboard trim
 - q) access panel
 - r) battery
 - s) SD memory card
4. Follow the procedures in *After Working Inside Your Computer*.

Removing the Network Connector

1. Follow the procedures in *Before Working Inside Your Computer*.
2. Remove:
 - a) SD memory card
 - b) battery
 - c) access panel
 - d) keyboard trim
 - e) keyboard
 - f) optical drive
 - g) hard drive
 - h) right base panel
 - i) palmrest
 - j) display assembly
 - k) right support frame
 - l) left support frame
 - m) modem card
3. Remove the network connector cables from the routing channels.
4. Remove the network connector jack.

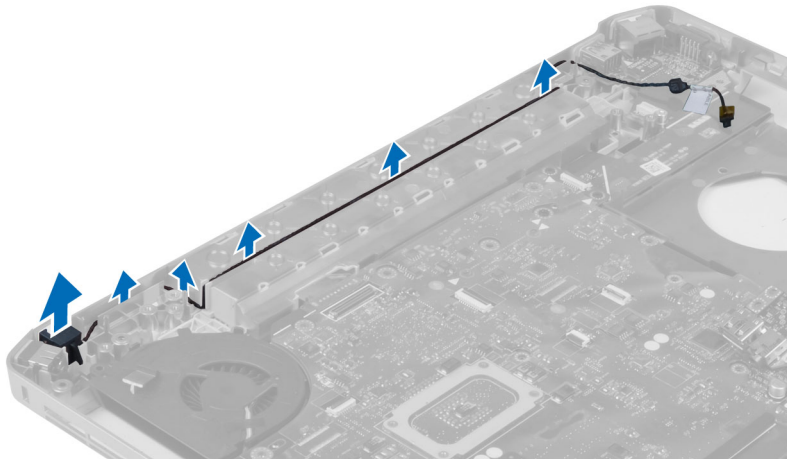

Installing the Network Connector Jack

1. Install the network connector jack in the computer.
2. Thread the network connector cable in the routing channel.
3. Install:
 - a) modem card
 - b) left support frame
 - c) right support frame
 - d) display assembly
 - e) palmrest
 - f) right base panel
 - g) hard drive
 - h) optical drive
 - i) keyboard
 - j) keyboard trim
 - k) access panel
 - l) battery
 - m) SD memory card
4. Follow the procedures in *After Working Inside Your Computer*.

Removing the Speakers

1. Follow the procedures in *Before Working Inside Your Computer*.
2. Remove:
 - a) SD memory card
 - b) battery
 - c) access panel
 - d) keyboard trim
 - e) keyboard
 - f) optical drive
 - g) hard drive
 - h) WLAN card
 - i) right base panel

- j) thermal module
- k) palmrest
- l) ExpressCard reader cage
- m) Bluetooth module
- n) audio board
- o) display assembly
- p) left support frame
- q) system board

3. Remove the screws that secure the speakers.

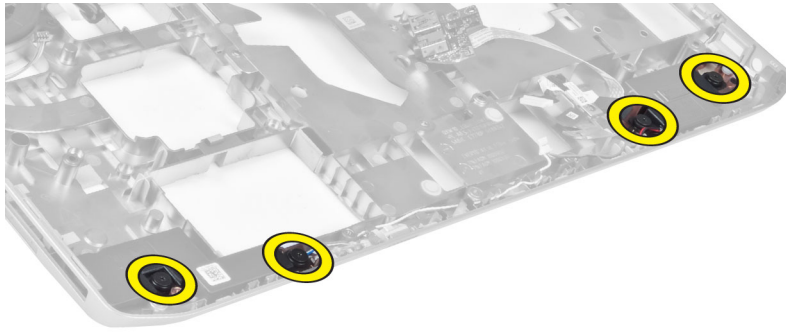

4. Remove the speaker cables from the routing channels.

5. Lift the speaker out from the computer.

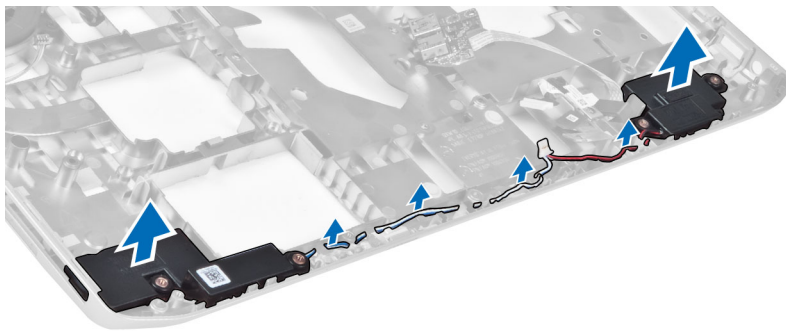

Installing the Speakers

1. Place the speakers in the computer.
2. Tighten the screws to secure the speakers to the computer.
3. Connect the speaker cables and secure it in the routing channels.
4. Install:
 - a) system board
 - b) left support frame
 - c) display assembly
 - d) audio board
 - e) Bluetooth module
 - f) ExpressCard reader cage
 - g) palmrest
 - h) thermal module
 - i) right base panel

- j) WLAN card
 - k) hard drive
 - l) optical drive
 - m) keyboard
 - n) keyboard trim
 - o) access panel
 - p) battery
 - q) SD memory card
5. Follow the procedures in *After Working Inside Your Computer*.

Docking Port Information

The docking port is used for connecting the laptop to a docking station (optional).

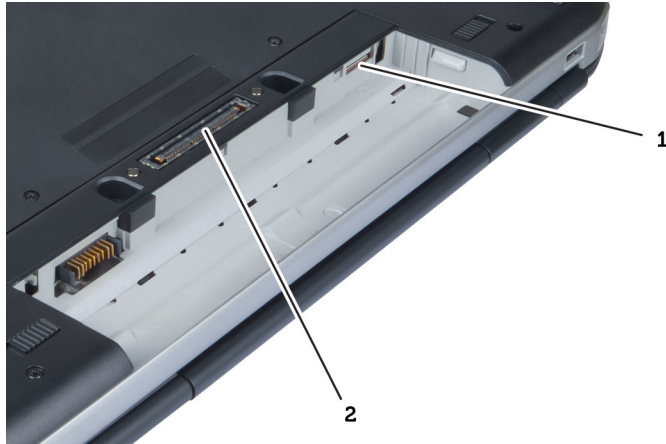

- 1. SIM card slot
- 2. Docking Port

Specifications

Specifications



 **NOTE:** Offerings may vary by region. For more information regarding the configuration of your computer, click Start  (Start icon) → **Help and Support**, and then select the option to view information about your computer.

Table 1. System Information

Feature	Specification
Chipset	Intel HM77/QM77 Express Chipset
DRAM bus width	64-bit
Flash EPROM	SPI 32 Mbits
PCIe Gen1 bus	100 MHz
External Bus Frequency	DMI (5GT/s)

Table 2. Processor

Feature	Specification
Types	<ul style="list-style-type: none">• Intel Celeron• Intel Core i3 series• Intel Core i5 series• Intel Core i7 series
L3 cache	up to 8MB

Table 3. Memory

Feature	Specification
Memory connector	two SoDIMM slots
Memory capacity	2 GB, 4 GB, or 8 GB
Memory type	DDR3 SDRAM 1600
Minimum memory	2 GB
Maximum memory	8 GB

Table 4. Audio

Feature	Specification
Type	four-channel high definition audio
Controller	IDT92HD93
Stereo conversion	24-bit (analog-to-digital and digital-to-analog)

Feature	Specification
Interface:	
Internal	high definition audio
External	microphone-in/stereo headphones/external speakers connector
Speakers	two
Internal speaker amplifier	1W (RMS) per channel
Volume controls	keyboard function keys, program menus

Table 5. Video

Feature	Specification
Type	integrated on system board
Controller	Intel HD Graphics

Table 6. Communications

Feature	Specification
Network adapter	10/100/1000 Mb/s Ethernet (RJ-45)
Wireless	internal wireless local area network (WLAN) and wireless wide area network (WWAN)

Table 7. Ports and Connectors

Feature	Specification
Audio (optional)	one microphone/stereo headphone/speakers connector
Video	<ul style="list-style-type: none"> • one 15-pin VGA connector • 19-pin HDMI connector
Network adapter	one RJ-45 connector
USB 2.0	<ul style="list-style-type: none"> • two 4-pin USB 2.0-compliant connector
USB 3.0	<ul style="list-style-type: none"> • one USB 3.0-compliant connector • one eSATA/USB 3.0-compliant connector
Memory card reader	one 8-in-1 memory card reader
Docking port	one
Subscriber Identity Module (SIM) port	one

Table 8. Display

Feature	Specification
Type	
Latitude E5430	<ul style="list-style-type: none"> • HD(1366x768), WLED • HD+(1600 x 900)
Latitude E5530	<ul style="list-style-type: none"> • HD(1366x768), WLED • FHD (1920 x 1080)
Size	
Latitude E5430	14.0"
Latitude E5530	15.6"
Dimensions:	
Latitude E5430:	
Height	192.5 mm (7.57 inches)
Width	324 mm (12.75 inches)
Diagonal	355.60 mm (14.00 inches)
Active ares (X/Y)	309.40 mm x 173.95 mm
Maximum resolution	<ul style="list-style-type: none"> • 1366 x 768 pixels • 1600 x 900 pixels
Maximum Brightness	200 nits
Latitude E5530:	
Height	210 mm (8.26 inches)
Width	360 mm (14.17 inches)
Diagonal	394.24 mm (15.60 inches)
Active area (X/Y)	344.23 mm x 193.54 mm
Maximum resolution	<ul style="list-style-type: none"> • 1366 x 768 pixels • 1920 x 1080 pixels
Maximum Brightness	220 nits for HD, 300 nits for FHD
Operating angle	0° (closed) to 135°
Refresh rate	60 Hz
Minimum Viewing angles:	
Horizontal	<ul style="list-style-type: none"> • +/- 40° for HD • +/- 60° for FHD

Feature	Specification
Vertical	<ul style="list-style-type: none"> +10°/-30° for HD +/-50° for FHD
Pixel pitch:	
Latitude E5430	0.2265 mm x 0.2265 mm
Latitude E5530	<ul style="list-style-type: none"> 0.2520 mm x 0.2520 mm for HD 0.1790 x 0.1790 for FHD

Table 9. Keyboard

Feature	Specification
Number of keys	United States: 86 keys, United Kingdom: 87 keys, Brazil: 87 keys, and Japan: 90 keys
Layout	QWERTY/AZERTY/Kanji

Table 10. Touchpad

Feature	Specification
Active Area:	
X-axis	80.00 mm
Y-axis	45.00 mm

Table 11. Battery

Feature	Specification
Type	4, 6 or 9-cell "smart" lithium ion
Dimensions:	
Height	
4-, 6-, and 9-cell	20.00 mm (0.79 inch)
Width	
4- and 6-cell	208.00 mm (8.18 inches)
9-cell	214.00 mm (8.43 inches)
Depth	
4- and 6-cell	48.08 mm (1.89 inches)
9-cell	71.79 mm (2.83 inches)
Weight	
4-cell	240.00 g (0.53 lb)
6-cell	344.73 g (0.76 lb)



Feature	Specification
9-cell	508.20 g (1.12 lb)
Voltage	
4-cell	14.8 VDC
6- and 9-cell	11.1 VDC
Temperature range:	
Operating	0 °C to 50 °C (32 °F to 122 °F)
Non-Operating	-40 °C to 85 °C (-40 °F to 185 °F)
	 NOTE: The battery pack is capable of safely withstanding the above storage temperatures with 100% charge.
	 NOTE: The battery pack is also capable of withstanding storage temperatures from -20 °C to +60 °C with no degradation in its performance.
Coin-cell battery	3 V CR2032 lithium coin cell

Table 12. AC Adapter

Feature	Latitude E5430	Latitude E5530
Type	65 W	90 W adapter
Input voltage	100 VAC to 240 VAC	100 VAC to 240 VAC
Input current (maximum)	1.7 A	1.5 A
Input frequency	50 Hz to 60 Hz	50 Hz to 60 Hz
Output power	65 W	90 W
Output current	3.34 A (continuous)	4.62 A (continuous)
Rated output voltage	19.5 +/- 1.0 VDC	19.5 +/- 1.0 VDC
Temperature range:		
Operating	0 °C to 40 °C (32 °F to 104 °F)	0 °C to 40 °C (32 °F to 104 °F)
Non-Operating	-40 °C to 70 °C (-40 °F to 158 °F)	-40 °C to 70 °C (-40 °F to 158 °F)

Table 13. Physical

Physical	Latitude E5430	Latitude E5530
Height	29.9 mm to 32.5 mm (1.17 inches to 1.27 inches)	30.20 mm to 33.2 mm (1.18 inches to 1.30 inches)
Width	350.00 mm (13.70 inches)	388.00 mm (15.27 inches)
Depth	240.00 mm (9.44 inches)	251.00 mm (9.88 inches)
Weight	2.04 kg (4.50 lb)	2.38 kg (5.25 lb)

Table 14. Environmental

Feature	Specification
Temperature:	
Operating	0 °C to 35 °C (32 °F to 95 °F)
Storage	-40 °C to 65 °C (-40 °F to 149 °F)
Relative humidity (maximum):	
Operating	10 % to 90 % (non condensing)
Storage	5 % to 95 % (non condensing)
Altitude (maximum):	
Operating	-15.24 m to 3048 m (-50 ft to 10,000 ft)
Non-Operating	-15.24 m to 10,668 m (-50 ft to 35,000 ft)
Airborne contaminant level	G1 as defined by ISA-71.04-1985

System Setup

Overview

System Setup allows you to:

- change the system configuration information after you add, change, or remove any hardware in your computer.
- set or change a user-selectable option such as the user password.
- read the current amount of memory or set the type of hard drive installed.

 **CAUTION:** Unless you are an expert computer user, do not change the settings for this program. Certain changes can cause your computer to work incorrectly.

Entering System Setup

1. Turn on (or restart) your computer.
2. When the blue DELL logo is displayed, you must watch for the F2 prompt to appear.
3. Once the F2 prompt appears, press <F2> immediately.

 **NOTE:** The F2 prompt indicates that the keyboard has initialized. This prompt can appear very quickly, so you must watch for it to display, and then press <F2> . If you press <F2> before you are prompted, this keystroke will be lost.

4. If you wait too long and the operating system logo appears, continue to wait until you see the Microsoft Windows desktop. Then, shut down your computer and try again.

System Setup Options

 **NOTE:** Depending on the computer and its installed devices, the items listed in this section may or may not appear.

Table 15. General

Option	Description
System Information	This section lists the primary hardware features of your computer. <ul style="list-style-type: none">• System Information: Displays BIOS Version, Service Tag, Asset Tag, Ownership Tag, Ownership Date, Manufacture Date, and the Express Service Code.• Memory Information: Displays Memory Installed, Memory Available, Memory Speed, Memory Channels Mode, Memory Technology, DIMM A Size, DIMM B Size,• Processor Information: Displays Processor Type, Core Count, Processor ID, Current Clock Speed, Minimum Clock Speed, Maximum Clock Speed, Processor L2 Cache, Processor L3 Cache, HT Capable, and 64-Bit Technology.• Device Information: Displays Primary Hard Drive, Fixed bay Device, System eSATA Device, Dock eSATA Device, LOM MAC Address, Video Controller, Video BIOS Version, Video Memory, Panel Type, Native Resolution, Audio Controller, Modem Controller, Wi-Fi Device, Cellular Device, Bluetooth Device.
Battery Information	Displays the battery status and the type of AC adapter connected to the computer

Option	Description
Boot Sequence	Allows you to change the order in which the computer attempts to find an operating system. <ul style="list-style-type: none"> • Diskette Drive • Internal HDD • USB Storage Device • CD/DVD/CD-RW Drive • Onboard NIC
Boot List Option	Allows you to change the boot list option. <ul style="list-style-type: none"> • Legacy • UEFI
Date/Time	Allows you to change the date and time.

Table 16. System Configuration

Option	Description
Integrated NIC	Allows you to configure the integrated network controller. The options are: <ul style="list-style-type: none"> • Disabled • Enabled • Enabled w/PXE: This option is enabled by default.
System Management	Allows you to control the system management mechanism. The options are: <ul style="list-style-type: none"> • Disabled : This option is enabled by default • ASF 2.0 • Alert only <p> NOTE: This item is for non-Vpro system only.</p>
Parallel Port	Allows you to configure the parallel port on the docking station. The options are: <ul style="list-style-type: none"> • Disabled • AT: This option is enabled by default. • PS2 • ECP
Serial Port	Allows you to configure the integrated serial port. The options are: <ul style="list-style-type: none"> • Disabled • COM1: This option is enabled by default. • COM2 • COM3 • COM4
SATA Operation	Allows you to configure the internal SATA hard-drive controller. The options are: <ul style="list-style-type: none"> • Disabled

Option	Description
Drives	<ul style="list-style-type: none"> • ATA • AHCI • RAID On: This option is enabled by default. <p>Allows you to configure the SATA drives on board. All drives are enabled by default. The options are:</p> <ul style="list-style-type: none"> • SATA-0 • SATA-1 • SATA-4 • SATA-5
SMART Reporting	<p>This field controls whether hard drive errors for integrated drives are reported during system startup. This technology is part of the SMART (Self Monitoring Analysis and Reporting Technology) specification. This option is disabled by default.</p> <ul style="list-style-type: none"> • Enable SMART Reporting
USB Controller	<p>This field configures the integrated USB controller. If Boot Support is enabled, the system is allowed to boot any type of USB Mass Storage Devices (HDD, memory key, floppy).</p> <p>If USB port is enabled, device attached to this port is enabled and available for OS. If USB port is disabled, the OS cannot see any device attached to this port.</p> <ul style="list-style-type: none"> • Enable Boot Support • Enable External USB Port
Keyboard Illumination	<p> NOTE: USB keyboard and mouse always work in the BIOS setup irrespective of these settings.</p> <p>This field lets you choose the operating mode of the keyboard illumination feature. The keyboard brightness level can be set from 25% to 100%</p> <ul style="list-style-type: none"> • Disabled: This option is enabled by default. • Level is 25% • Level is 50% • Level is 75% • Level is 100%
Miscellaneous Devices	<p>Allows you to enable or disable the following devices:</p> <ul style="list-style-type: none"> • Enable Internal Modem • Enable Microphone • Enable eSATA Ports • Enable Hard Drive Free Fall Protection • Enable Fixed Bay • Enable Express card • Enable Camera

Option	Description
	 NOTE: All devices are enabled by default. You can also enable or disable Media Card.

Table 17. Video

Option	Description
LCD Brightness	Allows you to set the display brightness depending up on the power source (On Battery and On AC).







 **NOTE:** The Video setting will only be visible when a video card is installed into the system.

Table 18. Security

Option	Description
Admin Password	Allows you to set, change, or delete the administrator (admin) password.  NOTE: You must set the admin password before you set the system or hard drive password. Deleting the admin password automatically deletes the system password and the hard drive password.  NOTE: Successful password changes take effect immediately. Default Setting: Not set
System Password	Allows you to set, change or delete the system password.  NOTE: Successful password changes take effect immediately. Default Setting: Not set
Internal HDD-0 Password	Allows you to set or change the system's internal hard-disk drive.  NOTE: Successful password changes take effect immediately. Default Setting: Not set
Strong Password	Allows you to enforce the option to always set strong passwords. Default Setting: Enable Strong Password is not selected.  NOTE: If Strong Password is enabled, Admin and System passwords must contain at least one uppercase character, one lowercase character and be at least 8 characters long.
Password Configuration	Allows you to determine the minimum and maximum length of Administrator and System passwords.
Password Bypass	Allows you to enable or disable the permission to bypass the System and the Internal HDD password, when they are set. The options are: <ul style="list-style-type: none"> • Disabled • Reboot bypass Default Setting: Disabled



Option	Description
Password Change	Allows you to enable the disable permission to the System and Hard Drive passwords when the admin password is set. Default Setting: Allow Non-Admin Password Changes is selected
Non-Admin Setup Changes	Allows you to determine whether changes to the setup options are allowed when an Administrator Password is set. If disabled the setup options are locked by the admin password.
TPM Security	Allows you to enable the Trusted Platform Module (TPM) during POST. Default Setting: The option is disabled.
Computrace	Allows you to activate or disable the optional Computrace software The options are: <ul style="list-style-type: none"> • Deactivate • Disable • Activate <p> NOTE: The Activate and Disable options will permanently activate or disable the feature and no further changes will be allowed</p> Default Setting: Deactivate
CPU XD Support	Allows you to enable the Execute Disable mode of the processor. Default Setting: Enable CPU XD Support
OROM Keyboard Access	Allows you to set an option to enter the Option ROM Configuration screens using hotkeys during boot. The options are: <ul style="list-style-type: none"> • Enable • One Time Enable • Disable Default Setting: Enable
Admin Setup Lockout	Allows you to prevent users from entering Setup when an Administrator password is set. Default Setting: Enable Admin Setup Lockout is not selected.

Table 19. Performance

Option	Description
Multi Core Support	This field specifies whether the process will have one or all cores enabled. The performance of some applications will improve with the additional cores. This option is enabled by default. Allows you to enable or disable multi-core support for the processor. The options are: <ul style="list-style-type: none"> • All • 1 • 2 Default Setting: All
Intel® SpeedStep™	Allows you to enable or disable the Intel SpeedStep feature.

Option	Description
C States Control	Default Setting: Enable Intel SpeedStep Allows you to enable or disable the additional processor sleep states. Default Setting: The option C states is enabled.
Intel® TurboBoost™	Allows you to enable or disable the Intel TurboBoost mode of the processor. Default Setting: Enable Intel TurboBoost
Hyper-Thread Control	Allows you to enable or disable the HyperThreading in the processor. Default Setting: Enabled

Table 20. Power Management

Option	Description
AC Behavior	Allows you to enable or disable the computer from turning on automatically when an AC adapter is connected. Default Setting: Wake on AC is not selected.
Auto On Time	Allows you to set the time at which the computer must turn on automatically. The options are: <ul style="list-style-type: none"> • Disabled • Every Day • Weekdays • Select Days Default Setting: Disabled
USB Wake Support	Allows you to enable USB devices to wake the system from Standby. <p> NOTE: This feature is only functional when the AC power adapter is connected. If the AC power adapter is removed during Standby, the system setup will remove power from all of the USB ports to conserve battery power.</p> <ul style="list-style-type: none"> • Enable USB Wake Support • Default Setting: Enable USB Wake Support is not selected
Wireless Radio Control	Allows you to enable or disable the feature that automatically switches from wired or wireless networks without depending on the physical connection. <ul style="list-style-type: none"> • Control WLAN Radio • Control WWAN Radio • Default Setting: Control WLAN radio or Control WWAN radio is not selected
Wake on LAN/WLAN	Allows you to enable or disable the feature that powers on the computer from the Off state when triggered by a LAN signal. <ul style="list-style-type: none"> • Disabled: This option is enabled by default • LAN Only • WLAN Only • LAN or WLAN



Option	Description
Block Sleep	This option lets you block entering to sleep (S3 state) in Operating System environment. Block Sleep (S3 state) - This option is disabled by default. POST
Primary Battery Configuration	Allows you to select the charging mode for the battery. The options are: <ul style="list-style-type: none"> • Standard Charge • Express Charge • Predominately AC use • Auto Charge: This option is enabled by default. • Custom Charge <p>If Custom Charge is selected, you can also configure Custom Charge Start and Custom Charge Stop.</p> <p> NOTE: All charging mode may not be available for all the batteries.</p>
Battery Slice Configuration	Allows you to select the type of charge for the battery. The options are: <ul style="list-style-type: none"> • Standard Charge • Express Charge : This option is enabled by default. <p> NOTE: Express charge may not be available for all the batteries.</p>

Table 21. POST Behavior

Option	Description
Adapter Warnings	Allows you to enable or disable the system setup (BIOS) warning messages when you use certain power adapters. Default Setting: Enable Adapter Warnings
Keypad	Allows you to choose one of two methods to enable the keypad that is embedded in the internal keyboard. <ul style="list-style-type: none"> • Fn Key Only: This option is enabled by default. • By Numlock
Mouse/Touchpad	Allows you to define how the system handles mouse and touch pad input. The options are: <ul style="list-style-type: none"> • Serial Mouse • PS2 Mouse • Touchpad/PS-2 Mouse: This option is enabled by default.
Numlock Enable	Allows you to enable the Numlock option when the computer boots. Default Setting: Enable Network
Fn Key Emulation	Allows you to set the option where the <Scroll Lock> key is used to simulate the <Fn> key feature. Default Setting: Enable Fn Key Emulation

Option	Description
POST HotKeys	Allows you enable the sign-on screen message display indicating the keystroke sequence to access the System Setup option menu. Default Setting: Enable F12 Boot Option Menu

Table 22. Virtualization Support

Option	Description
Virtualization	Allows you to enable or disable the Intel Virtualization Technology. Default Setting: Enable Intel Virtualization Technology
VT for Direct I/O	Enables or disables the Virtual Machine Monitor (VMM) from utilizing the additional hardware capabilities provided by Intel® Virtualization technology for direct I/O. Enable VT for Direct I/O — This option is enabled by default.
Trusted Execution	This option specifies whether a Measured Virtual Machine Monitor (MVMM) can utilize the additional hardware capabilities provided by Intel Trusted Execution Technology, the TPM virtualization Technology, and Virtualization technology for direct I/O must be enabled to use this feature. Trusted Execution — disabled by default.

Table 23. Wireless

Option	Description
Wireless Switch	Allows to set the wireless devices that can be controlled by the wireless switch. The options are: <ul style="list-style-type: none"> • WWAN • WLAN • Bluetooth All the options are enabled by default.
Wireless Device Enable	Allows you to enable or disable the internal wireless devices. <ul style="list-style-type: none"> • WWAN • WLAN • Bluetooth All the options are enabled by default.

Table 24. Maintenance

Option	Description
Service Tag	Displays the Service Tag of your computer.
Asset Tag	Allows you to create a system asset tag if an asset tag is not already set. This option is not set by default.





Table 25. System Logs

Option	Description
BIOS Events	Allows you to view and clear the System Setup (BIOS) POST events.

Diagnostics

Diagnostics

Table 26. Device Status Lights

	Turns on when you turn on the computer and blinks when the computer is in a power management mode.
	Turns on when the computer reads or writes data.
	Turns on steadily or blinks to indicate battery charge status.
	Turns on when wireless networking is enabled.



If the computer is connected to an electrical outlet, the battery light operates as follows:

Table 27. Battery Status Lights

Alternately blinking amber light and blue light	An unauthenticated or unsupported non-Dell AC adapter is attached to your laptop.
Alternately blinking amber light with steady blue light	Temporary battery failure with AC adapter present.
Constantly blinking amber light	Fatal battery failure with AC adapter present.
Light off	Battery in full charge mode with AC adapter present.
Solid white light on	Battery in charge mode with AC adapter present.

The lights located above the keyboard indicate the following:

Table 28. Keyboard Status Lights

	Turns on when the numeric keypad is enabled.
	Turns on when the Caps Lock function is enabled.
	Turns on when the Scroll Lock function is enabled.

Contacting Dell

Contacting Dell

 **NOTE:** If you do not have an active Internet connection, you can find contact information on your purchase invoice, packing slip, bill, or Dell product catalog.

Dell provides several online and telephone-based support and service options. Availability varies by country and product, and some services may not be available in your area. To contact Dell for sales, technical support, or customer service issues:

1. Visit **support.dell.com**.
2. Select your support category.
3. If you are not a U.S. customer, select your country code at the bottom of the **support.dell.com** page, or select **All** to see more choices.
4. Select the appropriate service or support link based on your need.