

# SMART kapp

## USER'S GUIDE

FOR MODELS KAPP42 AND KAPP84

## Product registration

If you register your SMART product, we'll notify you of new features and software upgrades.

Register online at [smarttech.com/registration](http://smarttech.com/registration).

Keep the following information available in case you need to contact SMART Support.

Serial number:

---

Date of purchase:

---

### Trademark notice

DViT, kapp, smarttech, the SMART logo and all SMART taglines are trademarks or registered trademarks of SMART Technologies ULC in the U.S. and/or other countries. Apple, App Store, iPhone and iPad are trademarks of Apple Inc., registered in the U.S. and other countries. Android and Google Play are trademarks of Google Inc. The Android robot is reproduced or modified from work created and shared by Google and used according to terms described in the Creative Commons 3.0 Attribution License. The Bluetooth word mark is owned by the Bluetooth SIG, Inc. and any use of such marks by SMART Technologies ULC is under license. All other third-party product and company names may be trademarks of their respective owners.

### Copyright notice

© 2015 SMART Technologies ULC. All rights reserved. No part of this publication may be reproduced, transmitted, transcribed, stored in a retrieval system or translated into any language in any form by any means without the prior written consent of SMART Technologies ULC. Information in this manual is subject to change without notice and does not represent a commitment on the part of SMART.

This product and/or use thereof is covered by one or more of the following U.S. patents:

[www.smarttech.com/patents](http://www.smarttech.com/patents)

06/2015

# Important information



## WARNING

- The capture board includes instructions for installation on metal and wood stud walls and certain masonry wall types only. A SMART hardware kit is available for these types of installation. In the event that you need to install the capture board on reinforced concrete walls, walls with plaster lath finishing or other types of walls, refer to your local building authority for instructions, recommendations and safe work practices.
- Do not open or disassemble the capture board. You risk electrical shock from the high voltage inside the casing. Opening the casing also voids the warranty.
- Ensure that any cables that cross the floor to the capture board are properly bundled and marked to avoid a trip hazard.
- Ensure your installation complies with local building and electrical codes.
- Failure to follow the installation instructions shipped with the capture board could result in injury and product damage which may not be covered by the warranty.
- To reduce the risk of fire or electric shock, do not expose the capture board to rain or moisture.
- Use SMART supplied mounting hardware or hardware that is designed to properly support the weight of the capture board.
- Use the power cable provided with the capture board. If a power cable is not supplied with the capture board, please contact your supplier. Use only power cables that match the AC voltage of the power outlet and that comply with your country's safety standards.
- Do not place any heavy objects on the power cable. Damage to the cable could cause shock, fire or product damage which may not be covered by the warranty.

## Federal Communication Commission interference statement

This device complies with Part 15 of the FCC Rules. Operation is subject to the following two conditions: (1) This device may not cause harmful interference, and (2) this device must accept any interference received, including interference that may cause undesired operation.

## IMPORTANT INFORMATION

This equipment has been tested and found to comply with the limits for a Class A digital device, pursuant to Part 15 of the FCC Rules. These limits are designed to provide reasonable protection against harmful interference in a residential installation. This equipment generates, uses and can radiate radio frequency energy and, if not installed and used in accordance with the instructions, may cause harmful interference to radio communications. However, there is no guarantee that interference will not occur in a particular installation. If this equipment does cause harmful interference to radio or television reception, which can be determined by turning the equipment off and on, the user is encouraged to try to correct the interference by one of the following measures:

- Reorient or relocate the receiving antenna.
- Increase the separation between the equipment and receiver.
- Connect the equipment into an outlet on a circuit different from that to which the receiver is connected.
- Consult the dealer or an experienced radio/TV technician for help.

FCC Caution: Any changes or modifications not expressly approved by the party responsible for compliance could void the user's authority to operate this equipment.

This transmitter must not be co-located or operating in conjunction with any other antenna or transmitter.

5.15–5.25 GHz frequency band operation is restricted to indoor use only. Outdoor operations in the 5150~5250 MHz are prohibited.

## Radiation exposure statement

This equipment complies with FCC radiation exposure limits set forth for an uncontrolled environment. This equipment should be installed and operated with minimum distance 20 cm between the radiator and your body.

Note: The country code selection is for the non-U.S. model only and is not available to all U.S. models. Per FCC regulations, all Wi-Fi products marketed in U.S. must be fixed to U.S. operation channels only.

## Industry Canada statement

This device complies with RSS-210 of the Industry Canada Rules. Operation is subject to the following two conditions: (1) This device may not cause harmful interference, and (2) this device must accept any interference received, including interference that may cause undesired operation.

Ce dispositif est conforme à la norme CNR-210 d'Industrie Canada applicable aux appareils radio exempts de licence. Son fonctionnement est sujet aux deux conditions suivantes: (1) le dispositif ne doit pas produire de brouillage préjudiciable, et (2) ce dispositif doit accepter tout brouillage reçu, y compris un brouillage susceptible de provoquer un fonctionnement indésirable.

## Caution

(i) the device for operation in the band 5150-5250 MHz is only for indoor use to reduce the potential for harmful interference to co-channel mobile satellite systems;

(ii) the maximum antenna gain permitted for devices in the bands 5250-5350 MHz and 5470-5725 MHz shall comply with the e.i.r.p. limit; and

(iii) the maximum antenna gain permitted for devices in the band 5725-5825 MHz shall comply with the e.i.r.p. limits specified for point-to-point and non point-to-point operation as appropriate.

(iv) Users should also be advised that high-power radars are allocated as primary users (i.e., priority users) of the bands 5250-5350 MHz and 5650-5850 MHz and that these radars could cause interference and/or damage to LE-LAN devices.

## Avertissement

Le guide d'utilisation des dispositifs pour réseaux locaux doit inclure des instructions précises sur les restrictions susmentionnées, notamment :

(i) les dispositifs fonctionnant dans la bande 5 150-5 250 MHz sont réservés uniquement pour une utilisation à l'intérieur afin de réduire les risques de brouillage préjudiciable aux systèmes de satellites mobiles utilisant les mêmes canaux;

(ii) le gain maximal d'antenne permis pour les dispositifs utilisant les bandes 5 250-5 350 MHz et 5 470-5 725 MHz doit se conformer à la limite de p.i.r.e.;

## IMPORTANT INFORMATION

(iii) le gain maximal d'antenne permis (pour les dispositifs utilisant la bande 5 725-5 825 MHz) doit se conformer à la limite de p.i.r.e. spécifiée pour l'exploitation point à point et non point à point, selon le cas.

(iv) De plus, les utilisateurs devraient aussi être avisés que les utilisateurs de radars de haute puissance sont désignés utilisateurs principaux (c.-à-d., qu'ils ont la priorité) pour les bandes 5 250-5 350 MHz et 5 650-5 850 MHz et que ces radars pourraient causer du brouillage et/ou des dommages aux dispositifs LAN-EL.

## Radiation exposure statement

This equipment complies with IC radiation exposure limits set forth for an uncontrolled environment. This equipment should be installed and operated with minimum distance 20 cm between the radiator and your body.

## Déclaration d'exposition aux radiations

Cet équipement est conforme aux limites d'exposition aux rayonnements IC établies pour un environnement non contrôlé. Cet équipement doit être installé et utilisé avec un minimum de 20 cm de distance entre la source de rayonnement et votre corps.



# Contents

<b>Important information</b> .....	<b>i</b>
Federal Communication Commission interference statement .....	i
Industry Canada statement .....	ii
<b>Chapter 1: Welcome</b> .....	<b>1</b>
About this guide .....	1
About the SMART kapp 42" capture board .....	2
About the SMART kapp 84" capture board .....	3
About the SMART kapp app .....	4
Other documentation and resources .....	5
<b>Chapter 2: Using the capture board</b> .....	<b>7</b>
Connecting your mobile device to the capture board .....	7
Writing and erasing notes .....	13
Viewing notes .....	13
Sharing notes .....	14
Saving snapshots of notes using the app .....	15
Saving snapshots of notes to a USB drive .....	19
Disconnecting the app .....	20
Connecting to another session .....	20
<b>Chapter 3: Upgrading to a plus subscription</b> .....	<b>23</b>
Upgrading to a plus subscription .....	23
Setting default preferences .....	24
Changing preferences for an individual session .....	25
<b>Chapter 4: Maintaining the capture board</b> .....	<b>27</b>
Cleaning the capture board .....	27
Transporting the capture board .....	29
Replacing the markers and eraser .....	29
<b>Chapter 5: Troubleshooting</b> .....	<b>31</b>
What the indicator lights mean .....	31
Troubleshooting .....	34
<b>Appendix A: Hardware environmental compliance</b> .....	<b>35</b>
Waste Electrical and Electronic Equipment (WEEE) .....	35
More information .....	35





## Chapter 1

# Welcome

About this guide .....	1
About the SMART kapp 42" capture board .....	2
Capture board .....	2
Dry erase markers and eraser .....	2
Mounting bracket and hardware .....	3
About the SMART kapp 84" capture board .....	3
Capture board .....	4
Dry erase markers and eraser .....	4
Mounting bracket and hardware .....	4
About the SMART kapp app .....	4
Other documentation and resources .....	5
Specifications .....	5
Installation instructions .....	5
Tutorial and Help .....	5
Training .....	5
Frequently asked questions .....	5
Security information .....	5
Support center and knowledge base .....	6

---

This chapter introduces you to your SMART kapp® capture board and this guide.

## About this guide

This guide explains how to use your capture board. It includes the following information:

- How to use your capture board and the SMART kapp app
- How to maintain your capture board for years of use
- How to troubleshoot issues with your capture board

This guide is intended for individuals who use and maintain capture boards. Other documentation and resources are available for individuals who install capture boards.

## About the SMART kapp 42" capture board

You can use the SMART kapp 42" capture board to collaborate with others in a simple but powerful way. Write and draw on the capture board as you would on a regular dry erase board. You can then connect a Bluetooth®-enabled mobile device to the capture board by scanning a Quick Response (QR) code or by tapping the Near Field Communication (NFC) tag. When you connect your mobile device for the first time, you're directed to the Apple App Store<sup>SM</sup> or Google Play<sup>TM</sup> store to download the SMART kapp app. After you download and install the app, you can use it to connect to the capture board and share content with others.

The SMART kapp 42" capture board product consists of the following components:

- Capture board
- Dry erase markers and eraser
- Mounting bracket and hardware

### Capture board

The capture board features SMART's proprietary DVIT<sup>®</sup> (Digital Vision Touch) technology on a 42" (107 cm) writing surface. DVIT technology captures the notes you make on the capture board using the dry erase markers and eraser. The capture board's Bluetooth 4.0 wireless technology (for Apple mobile devices) or Bluetooth 2.1 + EDR wireless technology (for Android<sup>™</sup> mobile devices) then transfers your notes as a digital image to a connected mobile device. Alternatively, you can save your notes to a FAT-formatted USB drive by connecting it to the capture board's USB 2.0 Type-A receptacle. You can also use the capture board's standard 500 mA USB 2.0 Type-A receptacle to charge your smart phone.

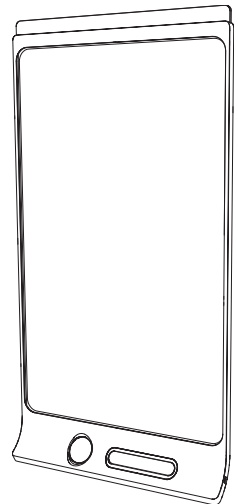

### Dry erase markers and eraser

The capture board comes with three dry erase markers and an eraser specially designed to work with the capture board.

The capture board includes holders for one marker and the eraser as well as a storage area (on the back of the capture board) for the other two markers.

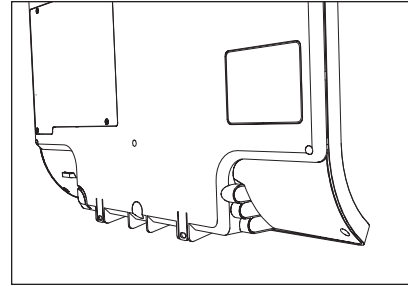
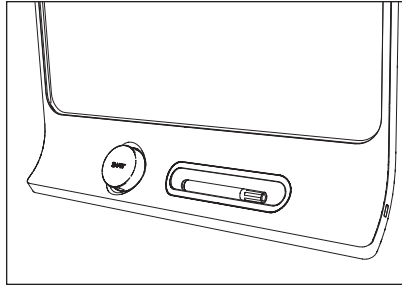

## Mounting bracket and hardware

You can use the supplied mounting bracket and hardware to mount the capture board on a wall. Alternatively, you can mount the capture board using a standard VESA® 400 mm × 400 mm mounting bracket.

## About the SMART kapp 84" capture board

You can use the SMART kapp 84" capture board to collaborate with others in a simple but powerful way. Write and draw on the capture board as you would on a regular dry erase board. Two people can draw at the same time. You can then connect a Bluetooth-enabled mobile device to the capture board by scanning a Quick Response (QR) code or by tapping the Near Field Communication (NFC) tag. When you connect your mobile device for the first time, you're directed to the Apple App Store or Google Play store to download the SMART kapp app. After you download and install the app, you can use it to connect to the capture board and share content with others.

The SMART kapp 84" capture board product consists of the following components:

- Capture board
- Dry erase markers and eraser
- Mounting bracket and hardware

## Capture board

The capture board features SMART's proprietary DViT technology on a 84" (213 cm) writing surface. DViT technology captures the notes you make on the capture board using the dry erase markers and eraser. The capture board's Bluetooth 4.0 wireless technology (for Apple mobile devices) or Bluetooth 2.1 + EDR wireless technology (for Android mobile devices) then transfers your notes as a digital image to a connected mobile device. Alternatively, you can save your notes to a FAT-formatted USB drive by connecting it to the capture board's USB 2.0 Type-A receptacle. You can also use the capture board's standard 500 mA USB 2.0 Type-A receptacle to charge your smart phone.

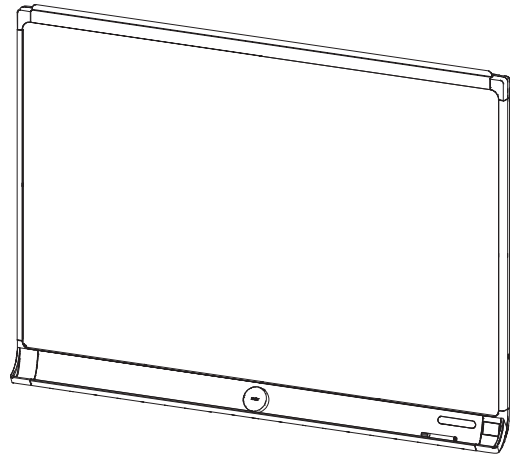

## Dry erase markers and eraser

The capture board comes with six dry erase markers and an eraser specially designed to work with the capture board.

## Mounting bracket and hardware

You can use the supplied mounting bracket and hardware to mount the capture board on a wall. Alternatively, you can mount the capture board using a standard VESA 600 mm × 400 mm mounting bracket.

## About the SMART kapp app

The SMART kapp app enables you to connect your mobile device to the capture board and then do the following:

- View notes you write on the capture board on your mobile device
- Share your notes with others
- Save your notes

## Other documentation and resources

SMART provides an extensive library of documentation and resources for the capture board.

### Specifications

The specifications include the capture board's dimensions, weight, recommended operating and storage temperatures, power specifications and other important information:

Model	Specifications
SMART kapp 42" capture board	<a href="http://smarttech.com/kb/170770">smarttech.com/kb/170770</a>
SMART kapp 84" capture board	<a href="http://smarttech.com/kb/170868">smarttech.com/kb/170868</a>

### Installation instructions

The capture board comes with installation instructions that explain how to mount the capture board using the supplied mounting bracket and hardware.

If you misplaced the installation instructions, you can download them:

Model	Installation instructions
SMART kapp 42" capture board	<a href="http://smarttech.com/kb/170768">smarttech.com/kb/170768</a>
SMART kapp 84" capture board	<a href="http://smarttech.com/kb/170870">smarttech.com/kb/170870</a>

### Tutorial and Help

When you first start the SMART kapp app on your mobile device, a tutorial opens. This tutorial explains how to connect your mobile device to the capture board and share and save your notes (see *Installing the app and starting it for the first time* on page 9).

### Training

The SMART training website ([smarttech.com/trainingforbusiness](http://smarttech.com/trainingforbusiness)) includes an extensive library of training resources you can refer to when learning how to use the capture board.

### Frequently asked questions

For answers to common questions about the capture board, see *SMART kapp capture board frequently asked questions* ([smarttech.com/kb/170793](http://smarttech.com/kb/170793)).

### Security information

For information about the SMART kapp security features, see *SMART kapp security information* ([smarttech.com/kb/170892](http://smarttech.com/kb/170892)).

## Support center and knowledge base

The Support center ([smartkapp.com/support](https://smartkapp.com/support)) includes documentation and a knowledge base that you can refer to when performing maintenance on the capture board or troubleshooting issues with the capture board.

## Chapter 2

# Using the capture board

Connecting your mobile device to the capture board .....	7
About QR codes and NFC .....	9
Installing the app and starting it for the first time .....	9
Starting a session .....	11
Writing and erasing notes .....	13
Viewing notes .....	13
Sharing notes .....	14
Saving snapshots of notes using the app .....	15
Saving snapshots .....	15
Viewing snapshots .....	15
Changing the order of snapshots .....	16
Exporting snapshots .....	17
Deleting snapshots .....	18
Saving snapshots of notes to a USB drive .....	19
Disconnecting the app .....	20
Connecting to another session .....	20

---

This chapter explains how to use the capture board.

## Connecting your mobile device to the capture board

Before you can share the notes you have written on your capture board with others, you need to connect your mobile device to the capture board.

You can connect the following types of mobile devices to your capture board:

Device type	Requirements	Connection options
Apple	<ul style="list-style-type: none"><li>• iOS 7.1 or later operating system software</li><li>• 50 MB of storage</li><li>• iPhone 4S or later</li><li>• Third generation iPad or later</li><li>• First generation iPad mini or later</li><li>• Fifth generation iPod touch or later</li></ul>	<ul style="list-style-type: none"><li>• Scan the capture board's unique QR code</li><li>• Enter the capture board's ID</li></ul>
Android	<ul style="list-style-type: none"><li>• Android 4.4.4 (KitKat) or later operating system</li><li>• 50 MB of storage (internal or SD card)</li><li>• 1024 MB of RAM</li><li>• 720p or better screen resolution</li><li>• Bluetooth 2.1 + EDR</li><li>• NFC (recommended)</li><li>• 3 megapixel or better rear-facing camera (recommended)</li></ul>	<ul style="list-style-type: none"><li>• Scan the capture board's unique QR code</li><li>• Tap the capture board's NFC tag</li><li>• Enter the capture board's ID</li></ul>

When you first connect a mobile device, you're prompted to install an app. You can then use the app to share notes you have written on your capture board with others.

 **NOTE**

Most of the SMART kapp app's features are identical across iOS operating system software and Android operating systems. However, some features are available for only one of these operating systems. Features specific to an operating system are highlighted with the following icons:



*iOS operating system software*



*Android operating systems*



## About QR codes and NFC

As noted in the previous section, you can connect your mobile device to your capture board by scanning the capture board's QR code or by tapping the capture board's NFC tag.



- A QR code is a type of bar code. If your mobile device has a rear-facing camera and a QR code scanning app, you can scan QR codes like the one on the capture board. Your mobile device then executes the QR codes' commands. Typically, QR codes' commands display messages or open web pages.
- NFC is a wireless technology that enables you to connect your mobile device and another device, such as the capture board, by holding your mobile device a short distance from (or "tapping") the other device.



### NOTE

Currently, you are unable to connect the capture board to an iPhone 6 using the mobile device's NFC support.



### TIP

Refer to your mobile device's documentation for the location of its NFC radio. When connecting your mobile device to the capture board, you might need to move the mobile device back and forth until its NFC radio detects the capture board's NFC tag.

## Installing the app and starting it for the first time

The SMART kapp app enables you to connect your mobile device to your capture board, view notes you write on your capture board on your mobile device and share and save your notes. You can install the app on your mobile device by scanning your capture board's QR code or by tapping its NFC tag.

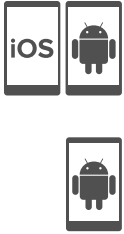

### To install the app

1. Do one of the following:
  - a. Start the QR code scanning app on your mobile device, and then hold your mobile device's rear-facing camera over your capture board's QR code to scan it.
  - b. Enable NFC in your mobile device's settings (if it isn't already enabled), and then hold your mobile device near your capture board's NFC tag .

The Apple App Store or Google Play opens.

2. Download and install the app.

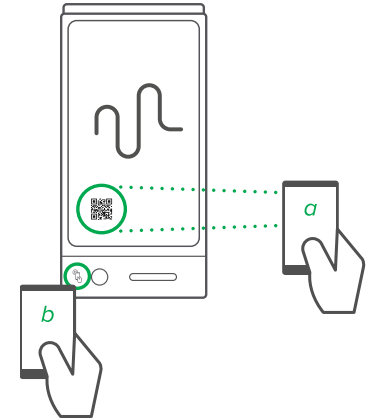

### To start the app for the first time

1. Start the SMART kapp app on your mobile device.  
The app tutorial appears.
2. Use the swipe gestures to progress through the screens of the tutorial.

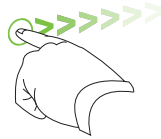

*Previous screen*

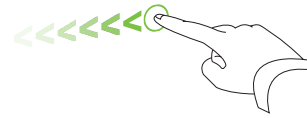



*Next screen*

3. Press **Close** when you have completed the tutorial.

The app home screen appears.

#### TIP

If you want to view the tutorial again, do the following:

- On an Apple mobile device, press **Settings**  on the app home screen and then press **Tutorial**.
- On an Android mobile device, press **Menu** , press **Settings**, and then press **Tutorial**.

## Starting a session

Start a session by connecting your mobile device to the SMART kapp capture board. You can do this by one of the following means:

- QR code
- NFC
- Board ID

### NOTE

Some Android mobile devices require you to accept a pairing request to connect to the capture board. Swipe down on the screen to access the notification drawer and accept the pairing request.

### To connect to the capture board by QR code

1. Start the SMART kapp app on your mobile device.
2. Hold your mobile device's rear-facing camera still over the capture board's QR code so that the QR code appears in the center of the app screen.

The app connects your mobile device to the capture board.

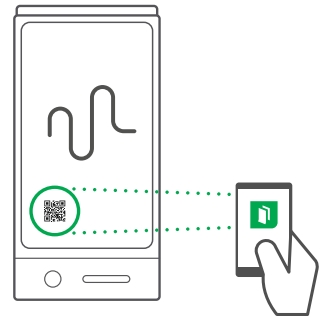

### NOTE

If the app doesn't connect your mobile device to the capture board, move your mobile device closer to or farther away from the capture board so that the app can capture the QR code.

### **To connect to the capture board by NFC**

1. Enable NFC in your mobile device's settings (if it isn't already enabled).
2. Hold your mobile device near the capture board's NFC tag .

The SMART kapp app starts and connects your mobile device to the capture board.

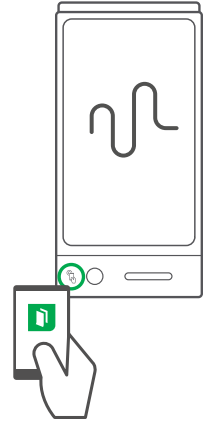

### **To connect to the capture board by Board ID**

1. Locate the capture board's 10-character ID.



#### **TIP**

The Board ID is located by the QR code.

2. Start the SMART kapp app on your mobile device.
3. On an Apple mobile device, press **Settings** .

OR

On an Android mobile device, press **Menu** , and then press **Settings**.

4. Press **Advanced**, and then press **Connect Manually**.

The *Connect Manually* screen appears.

5. Type the Board ID in the *Enter ID* box.
6. Press **Connect**.

The app connects your mobile device to the capture board.

## Writing and erasing notes

You can write and erase notes on the capture board just like you do on a traditional dry erase board. To get the best performance out of the capture board, follow these best practices:

- Wait for the icons on the capture board to stop flashing before you begin writing.
- Write and draw using the markers provided with your capture board or a third-party marker recommended by SMART. For a list of recommended third-party markers see *Replacing the markers and eraser* on page 29.
- Hold the pen away from the tip and at a right (90°) angle to the board's surface.
- Ensure your palm, hand, arm and any loose clothing doesn't touch the board while you're writing.
- Write clearly with large text and spaced out ink strokes.
- Avoid writing too close to the edges and corners of the capture board.
- If two people are writing on an SMART kapp 84" capture board, ensure there is at least 8" (3 cm) between the two pens, or the pen and eraser you are using.
- While connected with the app, use only the eraser provided with the capture board.
- While erasing, hold the eraser flat against the board.
- Clean the eraser and capture board periodically following the instructions provided in this guide (see *Cleaning the capture board* on page 27).

## Viewing notes

During a session, you can view the notes you've written on the capture board on your mobile device. As you write or erase notes, the changes appear on your mobile device automatically.

By default, your mobile device displays the capture board's entire writing surface. You can use gestures to zoom in, zoom out and pan:

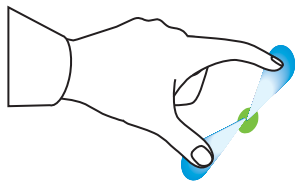

*Zoom in*

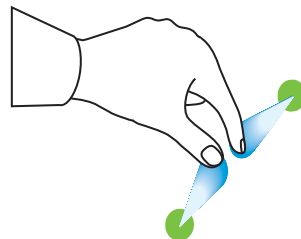

*Zoom out*

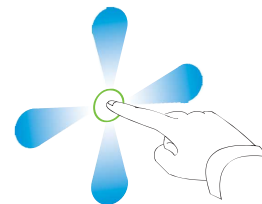

*Pan*

 **NOTE**

As you zoom in or out, grid lines appear on the writing surface to indicate the level of magnification.

## Sharing notes

During a session, you can use the SMART kapp app to invite up to five others to view your notes on their devices.

When others receive your invitation, they press or click a link to view your session in their Internet browsers; they don't need to install additional software or otherwise configure their devices. Alternatively, others can choose to install the SMART kapp app on their mobile devices and use it to connect to your session.

As you make changes to your notes, others see these changes in real time. They can also zoom in or out, and save, view and export snapshots.

 **NOTE**

- The SMART kapp viewer supports the following browsers:

**Android mobile devices**

- Google Chrome™ for Android 39.0.2171.93 or later

**Apple mobile devices**

- Safari 8 or later

**Computers**

- Internet Explorer® 10 or later
- Google Chrome 39.0.2171.95 or later
- Safari 8.0 or later
- Mozilla® Firefox® 34.0.5 or later

- You can share notes only as long as the SMART kapp app is running on your mobile device and your mobile device is connected to a capture board.
- You can export saved snapshots of notes without connecting your mobile device to a capture board (see *Exporting snapshots* on page 17).

 **To share your notes**

1. Connect your mobile device to the capture board (see *Starting a session* on page 11).
2. Press **Invite** , and then press **Send Link**.

3. Select the app you want to use to send the invitation.
4. Use the selected app to send the invitation.

## Saving snapshots of notes using the app

As you write notes on the capture board, you might want to save snapshots of your notes from time to time during the session.

After you save snapshots, you can do the following:

- View the snapshots
- Change the order of the snapshots (Apple mobile devices only)
- Share the snapshots as JPEG or PDF files
- Delete the snapshots

### Saving snapshots

#### To save a snapshot

1. Start or connect to a session (see *Starting a session* on page 11 or *Connecting to another session* on page 20).
2. Press **Capture**  on the capture board.

OR

Press **Capture**  in the app.

The app saves a snapshot of your notes.

#### NOTE

The *Library*  button in the bottom-right corner of the screen indicates how many snapshots have been saved in the current session.

## Viewing snapshots

### To view snapshots in the current session

1. Save one or more snapshots in the current session (see *Saving snapshots* above).
2. Press **Library** .

The session's snapshot library appears.

3. Press a snapshot's thumbnail image to view it.



#### TIP

You can use the zoom in, zoom out and pan gestures when viewing the snapshot (see *Viewing notes* on page 13).

### To view snapshots in previous sessions

1. If you're currently in a session, disconnect (see *Disconnecting the app* on page 20).
2. On an Apple mobile device, press **Library** .

OR

On an Android mobile device, press **Library** .

The *Library* screen appears.

3. Press a session's row to view the snapshots saved for that session.

The session's snapshot library appears.

4. Press a snapshot's thumbnail image to view it.



#### TIP

You can use the zoom in, zoom out and pan gestures when viewing the snapshot (see *Viewing notes* on page 13).



## Changing the order of snapshots



### To change the order of snapshots in previous sessions

1. If you're currently in a session, disconnect (see *Disconnecting the app* on page 20).
2. Press **Library** .  

The *Library* screen appears.
3. Press a session's row to view the snapshots saved for that session.  

The session's snapshot gallery appears.
4. Press **Select**.
5. Drag a snapshot's thumbnail to change its order.
6. Press **Done**.

## Exporting snapshots

### To export a snapshot

1. View the snapshot you want to export (see *Viewing snapshots* on page 15).
2. On an Apple mobile device, press **Export** , and then select **Save to Camera Roll** or **Share as PDF**.  

OR

On an Android mobile device, press **Menu** , and then select **Share as Image** or **Share as PDF**.
3. If you selected **Share as Image** or **Share as PDF**, select the app you want to use to share the snapshot.
4. Use the selected app to share the snapshot.

### To export all snapshots saved in the current session

1. Save one or more snapshots in the current session (see *Saving snapshots* on page 15).
2. Press **Library** .  

The *Library* screen appears.

3. On an Apple mobile device, press **Export** .

OR

On an Android mobile device, press **Menu** , and then select **Share as Image** or **Share as PDF**.

4. Select the app you want to use to export the snapshots.
5. Use the selected app to export the snapshots.

### To export all snapshots saved in a previous session

1. If you're currently in a session, disconnect (see *Disconnecting the app* on page 20).
2. On an Apple mobile device, press **Library** .

OR

On an Android mobile device, press **Library** .

The *Library* screen appears.

3. Press a session's row to view the snapshots saved for that session.

The session's snapshot gallery appears.

4. On an Apple mobile device, press **Export** .

OR

On an Android mobile device, press **Menu** , and then select **Share as PDF**.

5. Select the app you want to use to export the snapshots.
6. Use the selected app to export the snapshots.

## Deleting snapshots

### To delete a snapshot from a previous session

1. If you're currently in a session, disconnect (see *Disconnecting the app* on page 20).
2. On an Apple mobile device, press **Library** .

OR

On an Android mobile device, press **Library** .

The *Library* screen appears.

3. Press the session that contains the snapshot you want to delete.  
The session's snapshot gallery appears.
4. Press the snapshot you want to delete.
5. Press **Delete** , and then press **Delete**.



#### To delete a previous session on an Apple mobile device

1. If you're currently in a session, disconnect (see *Disconnecting the app* on the next page).
2. Press **Library** .

The *Library* screen appears.



3. Press **Edit**.
4. Press the session's **Delete**  button, and then press **Delete**.
5. Press **Done**.



#### To delete a previous session on an Android mobile device

1. If you're currently in a session, disconnect (see *Disconnecting the app* on the next page).
2. Press **Library** .



The *Library* screen appears.

3. Press **Menu** , and then select **Select**.
4. Select the session.
5. Press **Delete** , and then press **Delete**.

## Saving snapshots of notes to a USB drive

If you don't have access to a mobile device or would prefer to save snapshots of your notes using another means, you can save PDF snapshots to a FAT-formatted USB drive.

#### To save a snapshot

1. Connect the USB drive to the USB 2.0 Type-A receptacle on the side of the capture board.
2. Press **Capture**  or **USB**  on the capture board.  
The capture board saves a snapshot of your notes to the USB drive.
3. Disconnect the USB drive from the capture board when you're done saving snapshots.

## Disconnecting the app

The app disconnects from the current session in the following situations:

- You close the app.
- The app closes automatically after a period of non-use.
- The app is connected to a capture board, and the capture board is outside of your mobile device's Bluetooth communication range, which is approximately 33' (10 m).



### NOTE

When you connect an Android mobile device to the capture board, an icon appears in the notification area. This icon indicates when the mobile device is connected to the capture board:



*Connected*



*Disconnected*

### To disconnect the app manually

Press **Disconnect** in the top left corner of the SMART kapp app screen, and then press **Disconnect**.

OR

Hold **Bluetooth**  on the capture board until it turns solid red.

## Connecting to another session

If another person shares his or her session with you, you can connect to that session using the SMART kapp app on your mobile device. Once connected, you can do everything in the other person's session that you can do in your own sessions:

- View notes
- Share notes
- Save snapshots of notes

 **To connect to another session**

1. Open the email you received from the other person on your mobile device.
2. Press the link in the email.

The SMART kapp app opens, displaying the notes the other person is sharing.



**NOTE**

If the SMART kapp app isn't installed on your mobile device, follow the on-screen instructions to install it.



## Chapter 3

# Upgrading to a plus subscription

Upgrading to a plus subscription .....	23
Setting default preferences .....	24
Changing preferences for an individual session .....	25

---

You can upgrade the SMART kapp app to a plus subscription to take advantage of additional features.

## Upgrading to a plus subscription

When you upgrade to a plus subscription, you can:

- Share your session with up to 250 viewers
- Protect your sharing session with a password
- Assign a static link to your session and share the static link before a meeting starts
- Share snapshots as watermark-free PDFs and images

### To upgrade to a plus subscription

1. On an Apple mobile device, press **Settings** .

OR

On an Android mobile device, press **Menu** , and then press **Settings**.

2. Press **Go Premium**.

The *Go Premium* screen appears.

3. Press the **per month** button or the **per year** button.



#### NOTE

Prices vary by region.

4. On an Apple mobile device, type your password for the App Store.

OR

On an Android mobile device, type your password for Google Play.

After subscribing successfully, you receive an email receipt with details of your purchase.

## Setting default preferences

After you upgrade to a plus subscription, you can set the following preferences:

- A password for protecting sessions
- A static or dynamic link for sessions:
  - A static link provides a permanent link to sessions. You can send the link before meetings start to simplify meeting startup.
  - A dynamic link provides a new link for each sharing session.



### NOTE

If you choose to use a static link, an option to send the static link appears in the preferences.

### To use a password

1. On an Apple mobile device, press **Settings** .

OR

On an Android mobile device, press **Menu** , and then press **Settings**.

2. Press **Sharing**, and then press **Password**.

The *Enter Password* screen appears.

3. Select **Require a Password**.
4. Type up to 32 characters for a password.
5. Press **OK**.

### To remove the password

1. On an Apple mobile device, press **Settings** .

OR

On an Android mobile device, press **Menu** , and then press **Settings**.



2. Press **Sharing**, and then press **Password**.

The *Enter Password* screen appears.

3. Deselect **Require a Password**.
4. Press **Done**.

### To use a static link

1. On an Apple mobile device, press **Settings** .

OR

On an Android mobile device, press **Menu** , and then press **Settings**.

2. Press **Sharing**, and then select **Static Link**.
3. Optionally, press **Send Link**, and then select a method to send the static link to others.

## Changing preferences for an individual session

You can change preferences from their default values for an individual session.

### To change preferences for an individual session

1. Press **Invite** , and then press **Options**.

The *Options* screen appears.

2. Select the preferences you want to use for your current session.
3. If you want to make these new preferences your default preferences, select **Save as Default Options**.
4. Press **Send Link**.



## Chapter 4

# Maintaining the capture board

Cleaning the capture board .....	27
Cleaning the capture board .....	28
Cleaning the reflective bezels and corner sensors .....	28
Cleaning the eraser .....	29
Transporting the capture board .....	29
Replacing the markers and eraser .....	29

---

This chapter explains how to maintain the capture board for years of use.

## Cleaning the capture board

With proper care, the capture board will provide years of trouble-free service. Follow these tips to keep the capture board clean:

### CAUTION

- Disconnect the capture board from power before cleaning it.
- Do not spray cleaner directly onto the capture board's writing surface, reflective frame or corner sensors.
- SMART recommends that you clean the capture board monthly to ensure optimal performance.
- Do not allow excess cleaner to flow onto the frame's reflective surfaces.
- Remove any dry erase ink residue from the frame's reflective surfaces.
- Do not use compressed air to clean the camera windows or bezels.
- The digital cameras located in the frame are protected from dust and dirt by windows. In extremely dusty environments, spray a household, alcohol-free glass cleaner, such as Windex® cleaner, on a cotton swab and rub it gently on the windows. Do not use compressed air to clean the cameras, and do not apply too much pressure because doing so could damage the reflective surfaces or the cameras.

## Cleaning the capture board

### CAUTION

- Disconnect the capture board from power before cleaning it.
- Do not spray cleaner directly onto the capture board's writing surface, perimeter reflective tape or sensors.

Ink left on the capture board's writing surface for a long period of time might be harder to clean off. To remove dry erase ink residue, follow the instructions below.

### To clean the capture board

1. Spray a small amount of water or cleaner onto a clean lint-free cloth or paper towel.

### IMPORTANT

Acceptable cleaners include water, dry eraser cleaners, Windex glass cleaner and isopropyl alcohol.

2. Clean the capture board's surface.

## Cleaning the reflective bezels and corner sensors

### CAUTION

Disconnect the capture board from power before cleaning it.

### TIP

SMART recommends cleaning the corner sensors last in case the previous cleaning instructions leave debris on the sensors.

The capture board uses digital sensors and reflective tape on the perimeter of the writing surface to digitally capture your writing. Excessive buildup of dust or dry erase residue on the reflective tape surface and sensors can impair performance. The bottom reflective frame and corner sensors are most likely to collect excessive dust and dry erase ink residue over time.

### To clean the reflective bezels and corner sensors—Method 1

Carefully vacuum the areas where you notice a buildup of excessive dust and dry erase residue.

### To clean the reflective bezels and corner sensors—Method 2

1. Spray a small amount of water or cleaner onto a clean lint-free cloth or paper towel.



#### IMPORTANT

- Acceptable cleaners include water, Windex glass cleaner and isopropyl alcohol.
- Starting at the corners, wipe inwards to avoid wiping dry erase residue and dust onto the corner sensors

2. Using a clean, moistened lint-free cloth, gently wipe the corner sensors at the bottom of the capture board. Ensure the frame and corner sensors are free of dust and residue.

## Cleaning the eraser

The eraser can be used to erase ink from the capture board surface. Over time, the eraser felt collects dry erase ink residue and becomes less effective at erasing.

### To clean the eraser felt

1. Rinse the eraser felt under cold running tap water.
2. While wearing gloves, apply a mild soap or detergent and rub the eraser felt with your fingers.
3. Rinse the eraser felt thoroughly under cold running tap water
4. Remove excess water by pressing the felt against a towel or paper towel.
5. Allow the eraser felt to air dry completely.

## Transporting the capture board

Save the original packaging to repack the capture board if needed. This packaging was designed with optimal shock and vibration protection. If the original packaging isn't available, you can purchase the same packaging directly from your authorized SMART reseller.



#### CAUTION

Transport the capture board only in original or replaced packaging. Transporting the capture board without correct packaging voids the warranty and could lead to product damage.

## Replacing the markers and eraser

The SMART kapp 42" capture board comes with three dry erase markers and one eraser.

The SMART kapp 84" capture board comes with six dry erase markers and one eraser.

If you misplace the markers or if they run dry, you can replace them with third-party dry erase markers. The barrel of third-party dry erase markers can be any length and diameter, but the tip and nib must be within the following dimensions:

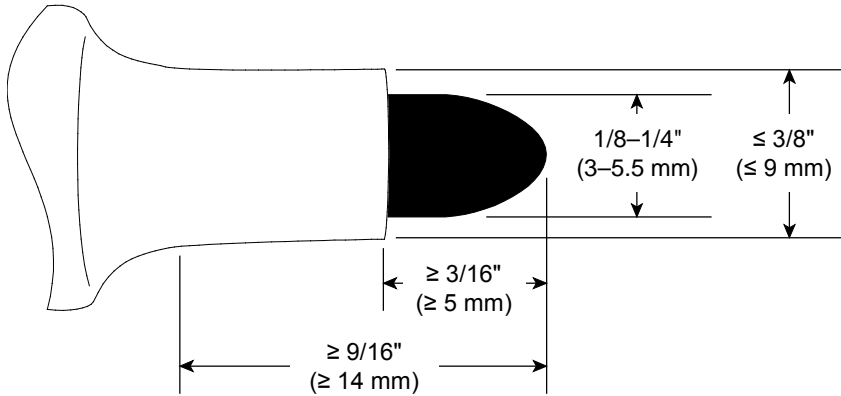

For best results, SMART recommends these third-party replacement markers:

- BIC® Magic Marker® dry erase liquid markers, fine tip
- Expo® low odor fine tip dry erase markers
- Staples® Remarx™ dry erase markers, bullet tip
- Melissa & Doug® dry erase markers

 **CAUTION**

The following pens are not recommended for use with the capture board.

- BIC Great Erase Grip® dry erase markers
- Board Dudes®
- Liqui-Mark®
- Quartet®

If you misplace the eraser, you can purchase a replacement from the Store for SMART Parts (see [smarttech.com/Support/PartsStore](https://smarttech.com/Support/PartsStore)).

## Chapter 5

# Troubleshooting

What the indicator lights mean .....	31
Startup .....	31
After startup .....	31
Status .....	32
Bluetooth .....	32
USB .....	33
Capture .....	33
Troubleshooting .....	34

---

This chapter explains how to troubleshoot common issues with the capture board and the SMART kapp app.

## What the indicator lights mean

SMART kapp capture boards include four indicator lights. The indicator lights are in the bottom-right corner of SMART kapp 42" capture boards and on the pen ledge of SMART kapp 84" capture boards.

### Startup

When you first connect the capture board to a power source, the indicator lights turn on and off in the following order until the capture board is ready for use:

- Status
- Bluetooth
- USB
- Capture

### After startup

When the capture board is ready for use, you can refer to the indicator lights to see the capture board's status and to diagnose common issues.

○ **Status**

**Off**

What it means:

The capture board isn't receiving power.

What to do:

- Ensure the capture board is connected to a power supply and is receiving power.
- If the Status light is still off, contact SMART Support for assistance.

**On**

What it means:

The capture board is receiving power and is working properly.

**Flashing (after startup)**

What it means:

The capture board is receiving power but isn't working properly.

What to do:

- Write on the capture board using only compatible markers.
- Ensure there are no obstructions (including markers) in the frame.
- Clean the writing surface and frame.
- If the Status light continues to flash, contact SMART Support for assistance.

✶ **Bluetooth**

**Off**

What it means:

- The capture board isn't connected to a mobile device.
- The capture board was previously connected to a mobile device but the SMART kapp app on the mobile device isn't running or the device has moved out of the capture board's Bluetooth communication range.

What to do:

If you previously connected the mobile device, ensure the SMART kapp app is running and the device is within the capture board's Bluetooth communication range.

**Flashing**

What it means:

The capture board is connecting to a mobile device.

**On**

What it means:

The capture board is connected to a mobile device.



**Flashing red**

What it means:

The capture board is disconnecting from the mobile device.

**Solid red**

What it means:

The capture board has disconnected from the mobile device.

 **USB**

**Off**

What it means:

- The capture board isn't connected to a USB drive.
- The capture board doesn't recognize the connected device as a USB drive.

What to do:

Connect only USB drives to the USB receptacle.

**Flashing**

What it means:

- The capture board is connecting to a USB drive.
- The capture board is saving a snapshot of your notes to the connected USB drive.

**On**

What it means:

The capture board is connected to a USB drive.

**Flashing red**

What it means:

The capture board is unable to save snapshots of your notes to the connected USB drive because the USB drive is full, is not FAT formatted or there's another problem with it.

What to do:

Disconnect the USB drive, and then connect a different USB drive.

 **Capture**

**Off**

What it means:

The capture board isn't connected to a USB drive or a mobile device.

**Flashing**

What it means:

The capture board is saving a snapshot of your notes to the connected mobile device.

**On**

What it means:

The capture board is connected to a USB drive or a mobile device.

# Troubleshooting

The following are issues that you might encounter while using the SMART kapp app.

**Your mobile device doesn't connect to the capture board.**

Make sure no other mobile devices are connected to the capture board. (The capture board can connect to only one mobile device at a time.)

**Your mobile device doesn't connect when you use the QR code.**

- Make sure your device's rear-facing camera is working and Bluetooth is enabled.
- Ensure the QR code is clean and fully visible.
- Position your mobile device so that your capture board's QR code appears in the center of the SMART kapp app screen.

**Your mobile device doesn't connect when you use NFC.**

- Ensure your mobile device supports NFC.
- Ensure NFC and Bluetooth are enabled in your mobile device's settings.
- Position your mobile device as close as possible to the NFC tag on your capture board when connecting.

**When you write on the capture board, your writing doesn't appear in the SMART kapp app, or extra lines or other visual noise appear in the SMART kapp app.**

- Ensure the capture board's cameras and frame are clean.
- Check for and remove any objects in the frame.
- Ensure your hands, arms or loose clothing aren't touching the capture board as you write.
- Write on the capture board using only compatible markers.
- Keep your capture board away from bright light sources, such as direct sunlight and incandescent lighting.

**The SMART kapp app displays the "Object blocking frame" message**

- The SMART kapp app displays this message when dirt on the capture board's frame obscures the sensors. To fix this, clean the capture board's cameras and frame.

## Appendix A

# Hardware environmental compliance

SMART Technologies supports global efforts to ensure that electronic equipment is manufactured, sold and disposed of in a safe and environmentally friendly manner.

## Waste Electrical and Electronic Equipment (WEEE)

Electrical and electronic equipment contain substances that can be harmful to the environment and to human health. The crossed-out wheeled bin symbol indicates that products should be disposed of in the appropriate recycling stream and not as regular waste.



## More information

See [smarttech.com/compliance](https://smarttech.com/compliance) for more information.





**SMART TECHNOLOGIES**

[smarkapp.com](http://smarkapp.com)

[smarkapp.com/support](http://smarkapp.com/support)

[smarttech.com/kb/170769](http://smarttech.com/kb/170769)