

RS232

RS232 Daisy Chain Cable



IR Sensor Cable

HDMI Cable

Dipole Antenna x2



M3

M2

* Differences according to regions.

Display design and accessories may differ from those illustrated above.

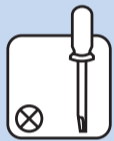

1

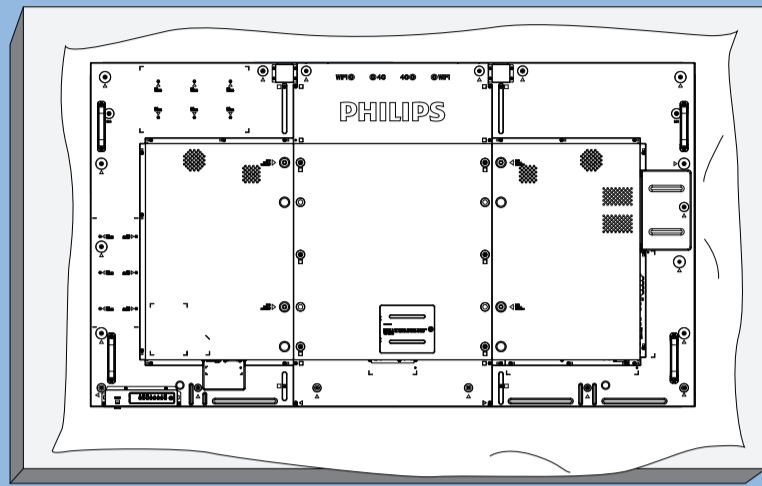

2

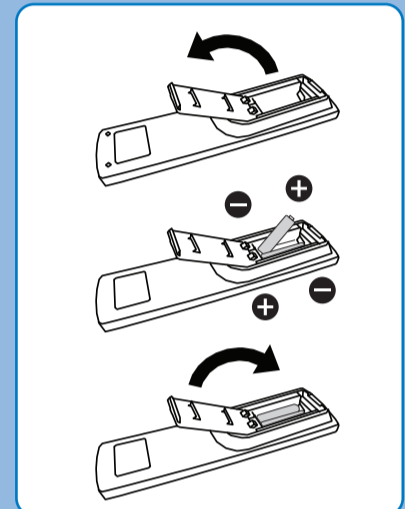
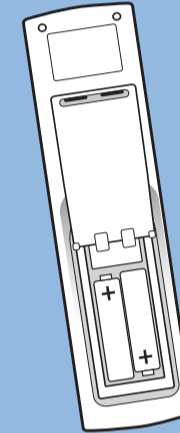
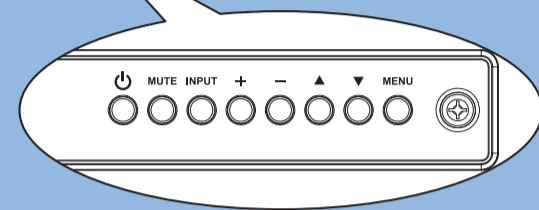
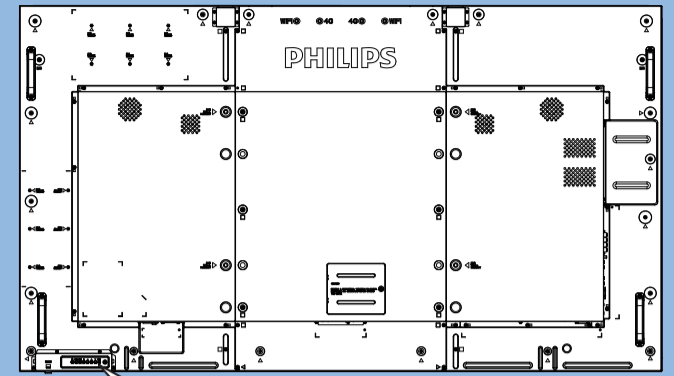

3

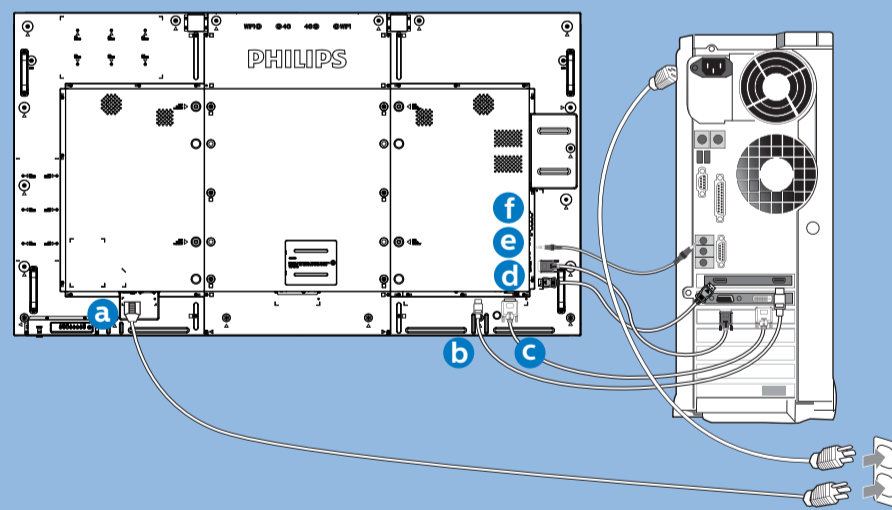
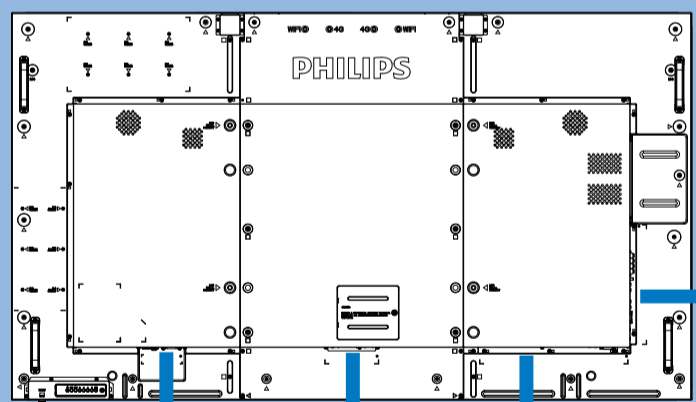

AC IN



HDMI



DVI



DP

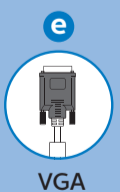

VGA



AUDIO

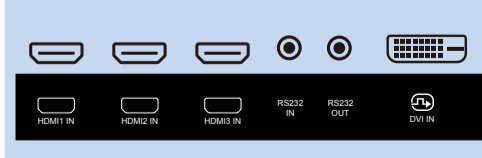
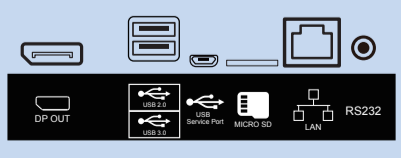

4

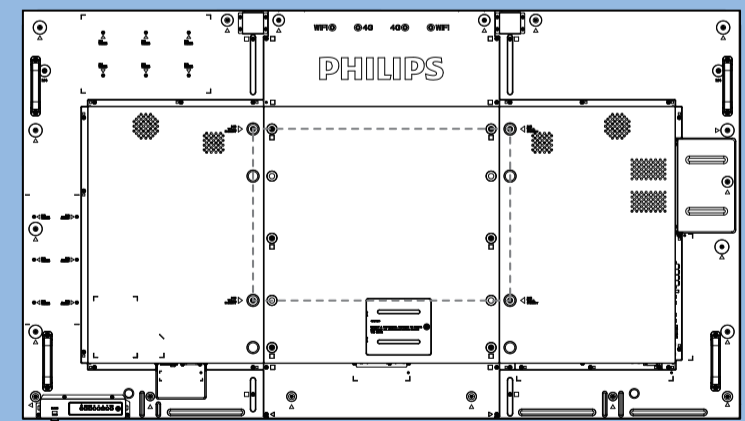

M8 * (15+X) mm
(X=Thickness of Wall mount BKT)

75BDL4150D: 600mmx400mm

5

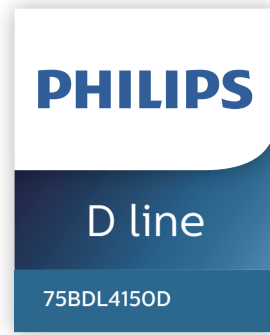
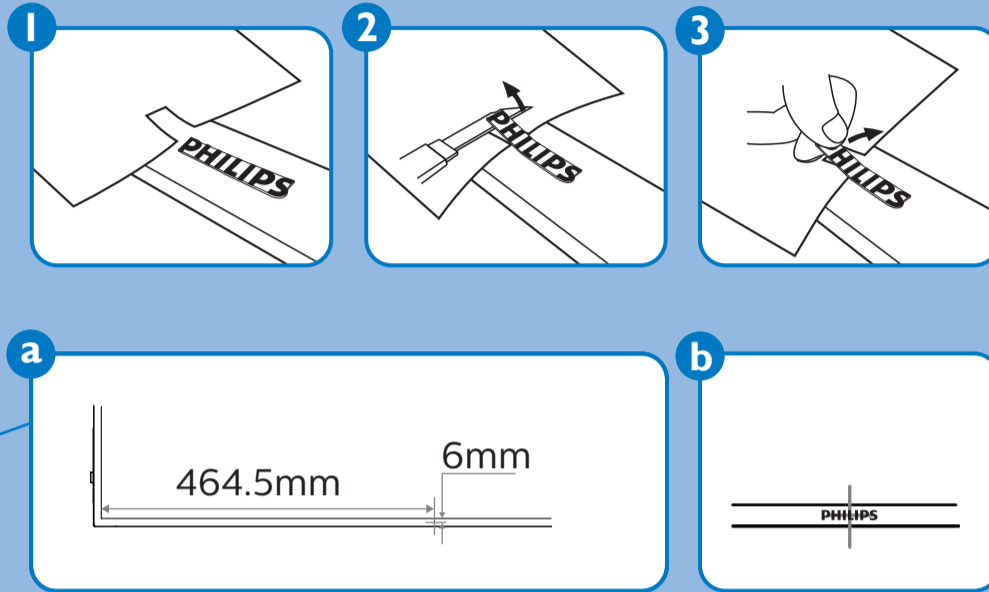
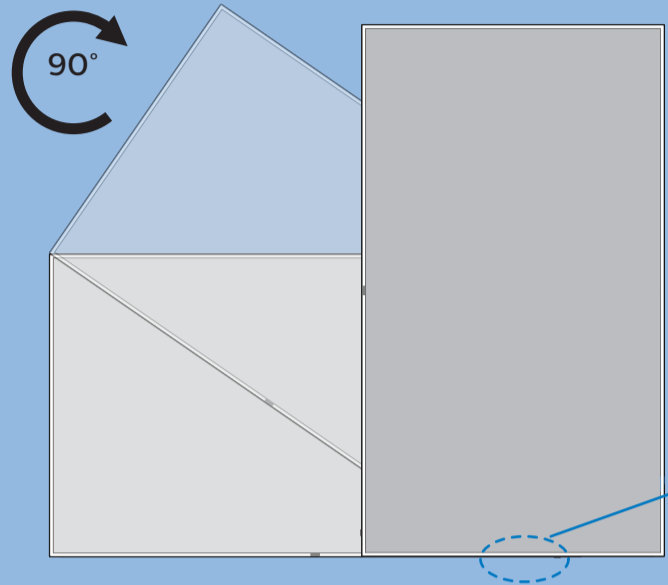

Quick Start



Please check out the website below for more product information.
www.philips.com/signagesolutions-support



Envision Peripherals Inc.
 47409 Seabridge Drive
 Fremont, CA 94538
 Tel. 510-770-9988

© 2018 Koninklijke Philips N.V. All rights reserved.
 Philips and the Philips Shield Emblem are registered trademarks of Koninklijke Philips N.V. and are used under license from Koninklijke Philips N.V.

Specifications are subject to change without notice.
 Version: V1.10 2018-08-28



Q41G75M181307B