

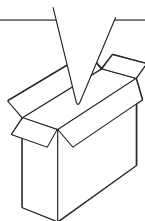

LED TV
LF51**

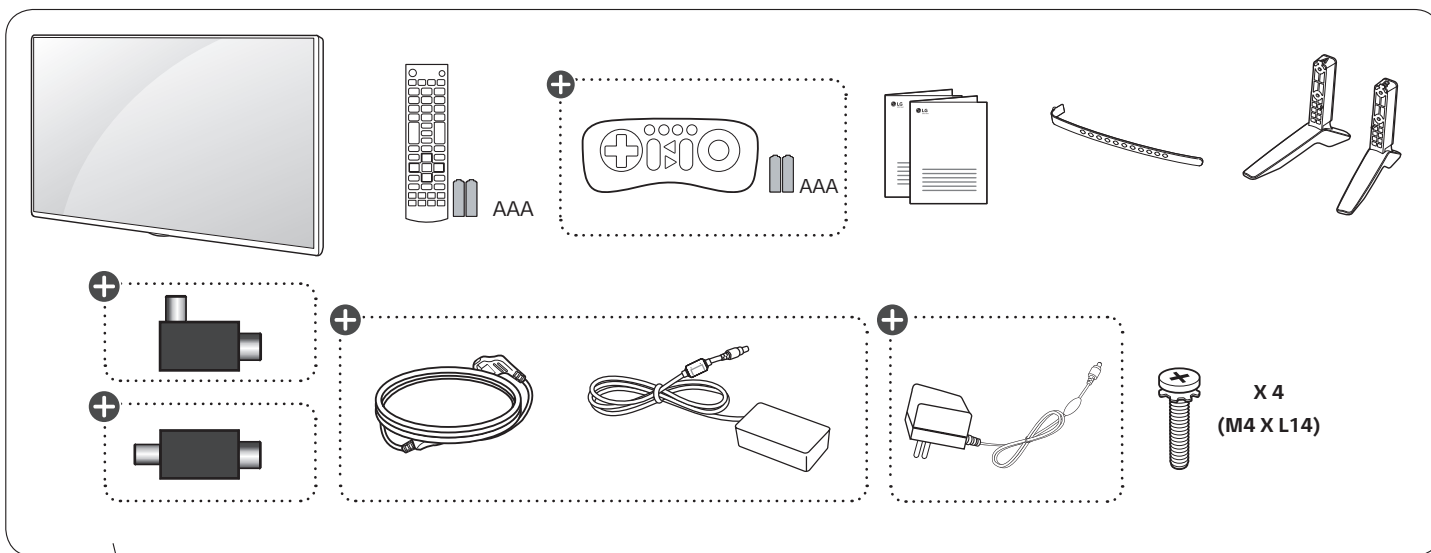

www.lg.com



⊕ : Depending on model / Selon le modèle / Dependendo do modelo / حسب الطراز

P/No: MFL68744898 (1509-REV03)
Printed in Korea



English

- Read **Safety and Reference**.
- For the power supply and power consumption, refer to the label attached to the product.

Français

- Lire le document **Sécurité et référence**.
- Reportez-vous à l'étiquette apposée sur le téléviseur pour connaître l'alimentation et la consommation électriques.

Português

- Consulte o manual **Segurança e referência**.
- No que respeita à fonte de alimentação e ao consumo de energia, consulte a etiqueta mostrada no produto.

- قراءة الأمان والمرجع .
- لمعرفة المزيد حول مصدر الإمداد بالطاقة المطلوب ومعايير استهلاك الطاقة، راجع الملصق الموجود على المنتج .

العربية

1

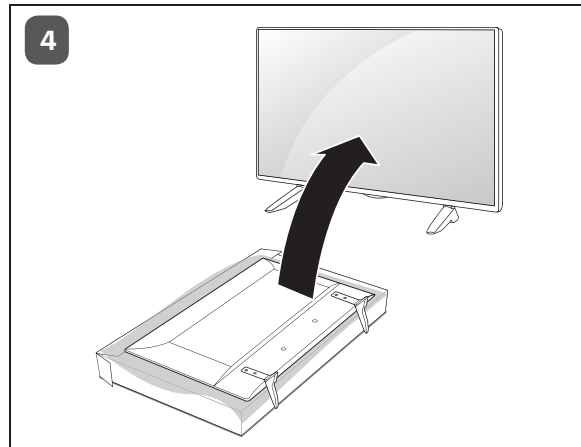
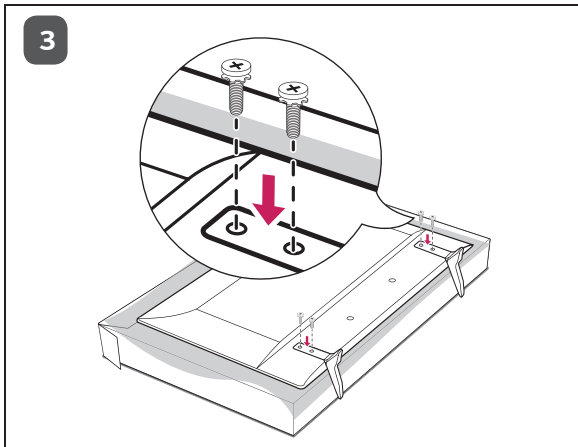
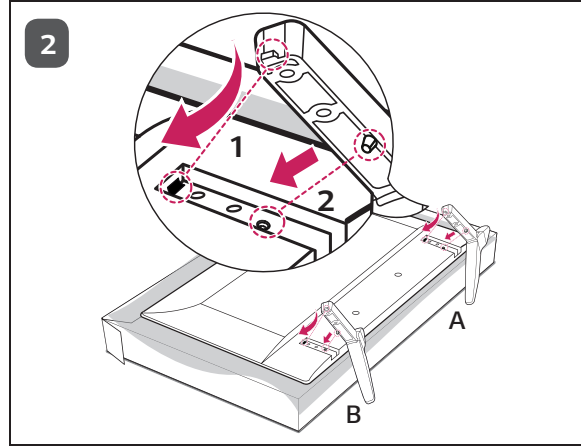
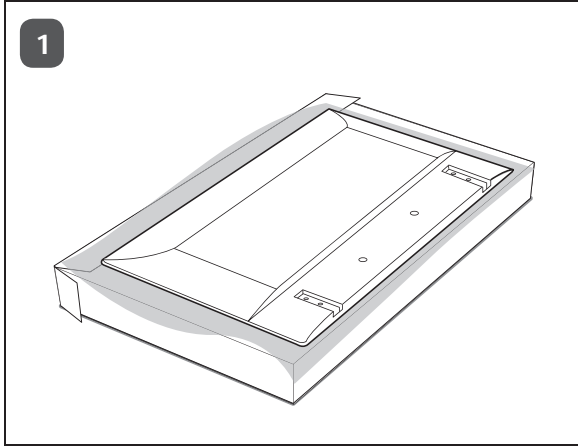

2

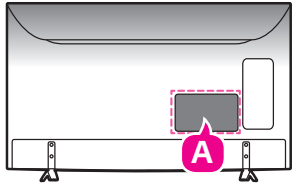

A

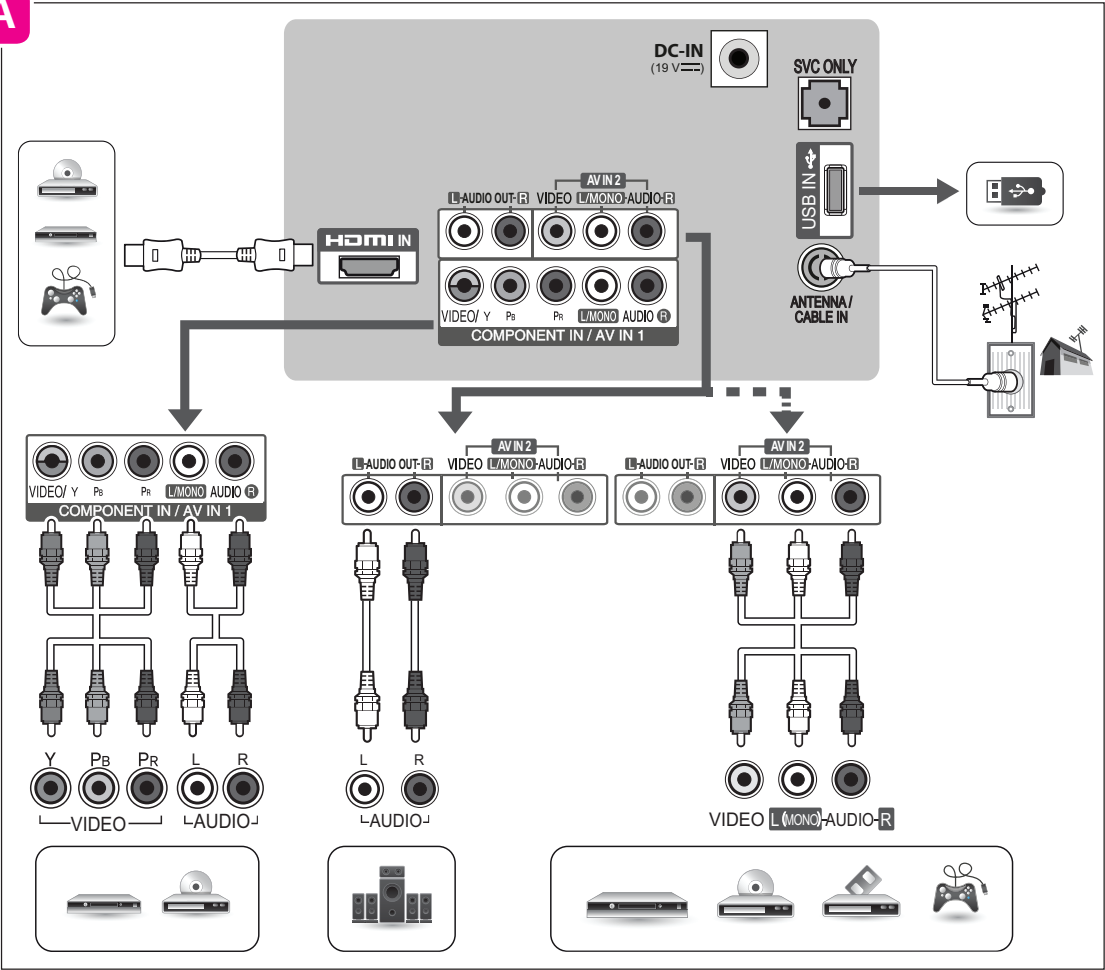

3

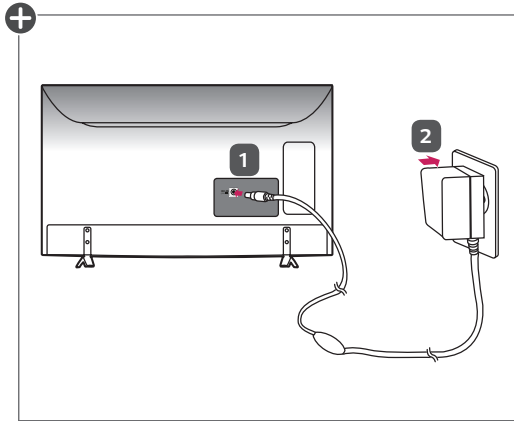
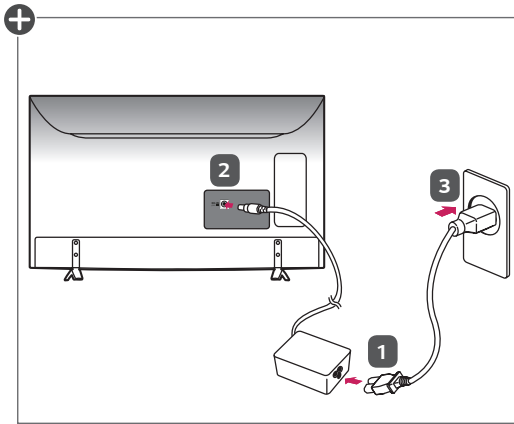

4

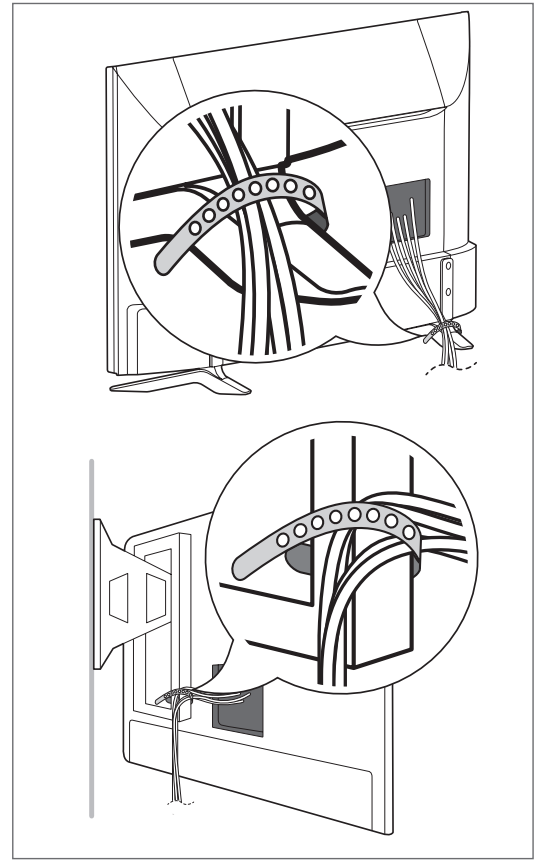

+ : Depending on model / Selon le modèle / Dependendo do modelo / حسب الطراز

5

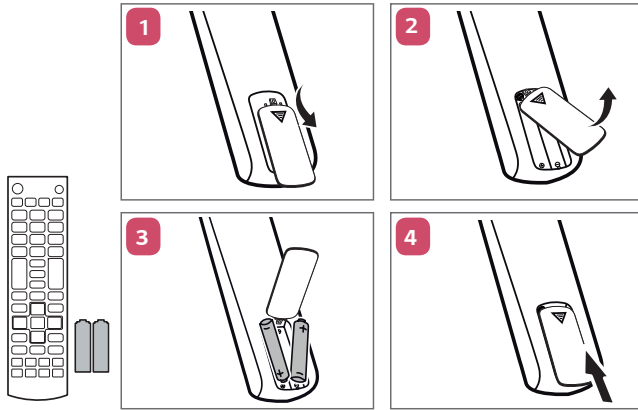

+

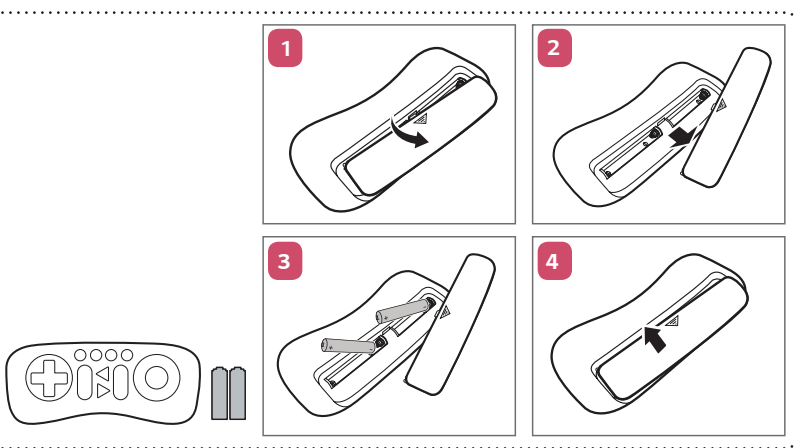

6

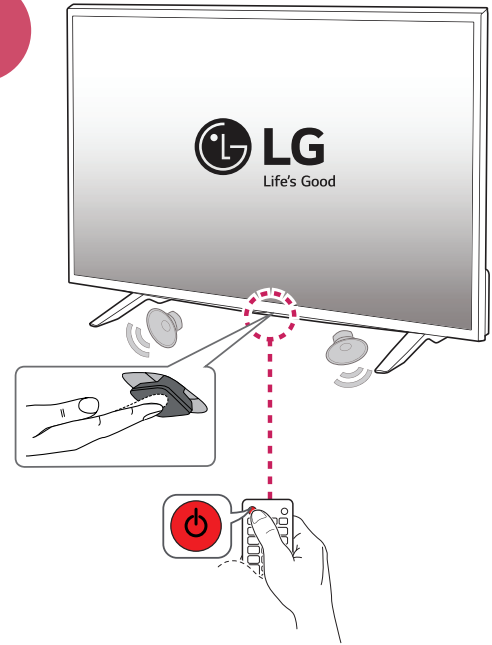

+ : Depending on model / Selon le modèle / Dependendo do modelo / حسب الطراز

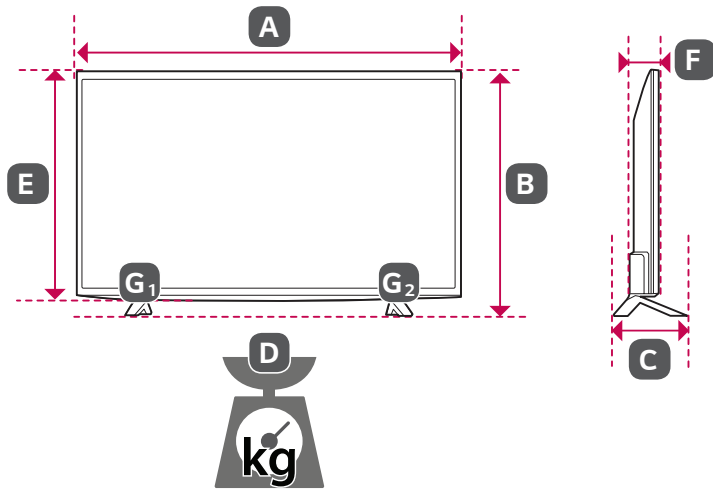

	32LF510A-TA 32LF513A-TA 32LF510A-TC 32LF513A-TC	43LF510A-TA 43LF513A-TA 43LF510A-TC 43LF513A-TC	49LF510A-TA 49LF513A-TA 49LF510A-TC 49LF513A-TC
A x B x C (mm)	734 x 474 x 172	976 x 621 x 208.7	1108 x 696 x 208.7
A x E x F (mm)	734 x 438 x 71	976 x 583 x 81.5	1108 x 657 x 81.5
D (kg)	4.7	8.5	10.9
D - (G ₁ + G ₂) (kg)	4.5	8.2	10.6
Power requirement / Alimentation / Requisito de alimentação / متطلبات الطاقة	19 V --- 1.6 A 19 فولت --- 1.6 أمبير	19 V --- 2.5 A 19 فولت --- 2.5 أمبير	19 V --- 3.2 A 19 فولت --- 3.2 أمبير

* M F L 6 8 7 4 4 8 9 8 *





OWNER'S MANUAL

Safety and Reference

LED TV*

* LG LED TV applies LCD screen with LED backlights.

Please read this manual carefully before operating your set and retain it for future reference.



www.lg.com

P/NO : MFL68662403 (1511-REV03)
Printed in Korea

Safety instructions

ENGLISH

Please read these safety precautions carefully before using the product.

⚠ WARNING



Do not place the TV and/or remote control in the following environments:

- A location exposed to direct sunlight
- An area with high humidity such as a bathroom
- Near any heat source such as stoves and other devices that produce heat
- Near kitchen counters or humidifiers where they can easily be exposed to steam or oil
- An area exposed to rain or wind
- Near containers of water such as vases

Otherwise, this may result in fire, electric shock, malfunction or product deformation.



Do not place the product where it might be exposed to dust. This may cause a fire hazard.

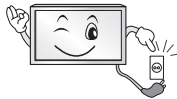

Mains Plug is the TV connecting/disconnecting device to AC mains electric supply. This plug must remain readily attached and operable when TV is in use.



Do not touch the power plug with wet hands. Additionally, if the cord pin is wet or covered with dust, dry the power plug completely or wipe dust off. You may be electrocuted due to excess moisture.



Make sure to connect Mains cable to compliant AC mains socket with Grounded earth pin. (Except for devices which are not grounded on earth.) Otherwise possibility you may be electrocuted or injured.



Insert power cable plug completely into wall socket otherwise if not secured completely into socket, fire ignition may break out.



Ensure the power cord does not come into contact with hot objects such as a heater. This may cause a fire or an electric shock hazard.



Do not place a heavy object, or the product itself, on power cables. Otherwise, this may result in fire or electric shock.



Bend antenna cable between inside and outside building to prevent rain from flowing in. This may cause water damaged inside the Product and could give an electric shock.

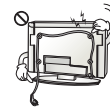

When mounting TV onto wall make sure to neatly install and isolate cabling from rear of TV as to not create possibility of electric shock / fire hazard.

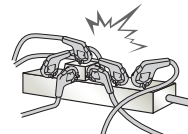

Do not plug too many electrical devices into a single multiple electrical outlet. Otherwise, this may result in fire due to over-heating.



Do not drop the product or let it fall over when connecting external devices. Otherwise, this may result in injury or damage to the product.



Keep the anti-moisture packing material or vinyl packing out of the reach of children. Anti-moisture material is harmful if swallowed. If swallowed by mistake, force the patient to vomit and visit the nearest hospital. Additionally, vinyl packing can cause suffocation. Keep it out of the reach of children.



Do not let your children climb or cling onto the TV. Otherwise, the TV may fall over, which may cause serious injury.



Dispose of used batteries carefully to ensure that a small child does not consume them. Please seek Doctor- Medical Attention immediately if child consumes batteries.



Do not insert any metal objects/conductors (like a metal chopstick/cutlery/screwdriver) between power cable plug and input Wall Socket while it is connected to the input terminal on the wall. Additionally, do not touch the power cable right after plugging into the wall input terminal. You may be electrocuted. (Depending on model)



Do not put or store inflammable substances near the product. There is a danger of combustion/explosion or fire due to careless handling of the inflammable substances.



Do not drop metallic objects such as coins, hair pins, chopsticks or wire into the product, or inflammable objects such as paper and matches. Children must pay particular attention. Electrical shock, fire or injury can occur. If a foreign object is dropped into the product, unplug the power cord and contact the service centre.



Do not spray water on the product or scrub with an inflammable substance (thinner or benzene). Fire or electric shock accident can occur.



Do not allow any impact, shock or any objects to fall into the unit, and do not drop anything onto the screen. You may be injured or the product can be damaged.



Never touch this product or antenna during a thunder or lightning storm. You may be electrocuted.



Never touch the wall outlet when there is leakage of gas, open the windows and ventilate. It may cause a fire or a burn by a spark.



Do not disassemble, repair or modify the product at your own discretion. Fire or electric shock accident can occur. Contact the service centre for check, calibration or repair.



If any of the following occur, unplug the product immediately and contact your local service centre.

- The product has been impacted by shock
- The product has been damaged
- Foreign objects have entered the product
- The product produced smoke or a strange smell

This may result in fire or electric shock.



Unplug the TV from AC mains wall socket if you do not intend to use the TV for a long period of time. Accumulated dust can cause fire hazard and insulation deterioration can cause electric leakage/shock/fire.



Apparatus shall not be exposed to dripping or splashing and no objects filled with liquids, such as vases, shall be placed on the apparatus.

Do not install this product on a wall if it could be exposed to oil or oil mist. This may damage the product and cause it to fall.



If water enters or comes into contact with TV, AC adapter or power cord please disconnect the power cord and contact service centre immediately. Otherwise, this may result in electric shock or fire.



Only use an authorized AC adapter and power cord approved by LG Electronics. Otherwise, this may result in fire, electric shock, malfunction or product deformation.



Never Disassemble the AC adapter or power cord. This may result in fire or electric shock.



Be careful in handling the adapter to prevent any external shocks to it. An external shock may cause damage to the adapter.

CAUTION



Install the product where no radio wave occurs.



There should be enough distance between an outside antenna and power lines to keep the former from touching the latter even when the antenna falls. This may cause an electric shock.



Do not install the product on places such as unstable shelves or inclined surfaces. Also avoid places where there is vibration or where the product cannot be fully supported. Otherwise, the product may fall or flip over, which may cause injury or damage to the product.

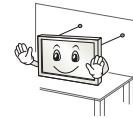

If you install the TV on a stand, you need to take actions to prevent the product from overturning. Otherwise, the product may fall over, which may cause injury.

If you intend to mount the product to a wall, attach VESA standard mounting interface (optional parts) to the back of the product. When you install the set to use the wall mounting bracket (optional parts), fix it carefully so as not to drop.

Only use the attachments / accessories specified by the manufacturer.



When installing the antenna, consult with a qualified service technician. If not installed by a qualified technician, this may create a fire hazard or an electric shock hazard.

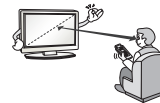

We recommend that you maintain a distance of at least 2 to 7 times the diagonal screen size when watching TV. If you watch TV for a long period of time, this may cause blurred vision.

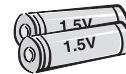

Only use the specified type of battery. This could cause damage to the remote control.

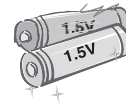

Do not mix new batteries with old batteries. This may cause the batteries to overheat and leak.

Batteries should not be exposed to excessive heat. For example, keep away from direct Sunlight , open fireplace and electric heaters.

Do not place non-rechargeable batteries in charging device.



Make sure there are no objects between the remote control and its sensor.



Signal from Remote Control can be interrupted due to external/internal lighting eg Sunlight, fluorescent lighting. If this occurs turn off lighting or darken viewing area.



When connecting external devices such as video game consoles, make sure the connecting cables are long enough. Otherwise, the product may fall over, which may cause injury or damage the product.



Do not turn the product On/Off by plugging-in or unplugging the power plug to the wall outlet. (Do not use the power plug for switch.) It may cause mechanical failure or could give an electric shock.



Please follow the installation instructions below to prevent the product from overheating.

- The distance between the product and the wall should be more than 10 cm.
- Do not install the product in a place with no ventilation (e.g., on a bookshelf or in a cupboard).
- Do not install the product on a carpet or cushion.
- Make sure the air vent is not blocked by a tablecloth or curtain.

Otherwise, this may result in fire.



Take care not to touch the ventilation openings when watching the TV for long periods as the ventilation openings may become hot. This does not affect the operation or performance of the product.

Periodically examine the cord of your appliance, and if its appearance indicates damage or deterioration, unplug it, discontinue use of the appliance, and have the cord replaced with an exact replacement part by an authorized servicer.

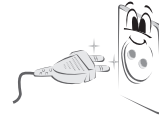

Prevent dust collecting on the power plug pins or outlet. This may cause a fire hazard.



Protect the power cord from physical or mechanical abuse, such as being twisted, kinked, pinched, closed in a door, or walked upon. Pay particular attention to plugs, wall outlets, and the point where the cord exits the appliance.



Do not press strongly upon the panel with a hand or sharp object such as nail, pencil or pen, or make a scratch on it, as it may cause damage to screen.



Avoid touching the screen or holding your finger(s) against it for long periods of time. Doing so may produce some temporary or permanent distortion/damage to screen.



When cleaning the product and its components, unplug the power first and wipe it with a soft cloth. Applying excessive force may cause scratches or discolouration. Do not spray with water or wipe with a wet cloth. Never use glass cleaner, car or industrial shiner, abrasives or wax, benzene, alcohol etc., which can damage the product and its panel. Otherwise, this may result in fire, electric shock or product damage (deformation, corrosion or breakage).

As long as this unit is connected to the AC wall outlet, it is not disconnected from the AC power source even if you turn off this unit by SWITCH.



When unplugging the cable, grab the plug and unplug it, by pulling at the plug.

Don't pull at the cord to unplug the power cord from the power board, as this could be hazardous.



When moving the product, make sure you turn the power off first. Then, unplug the power cables, antenna cables and all connecting cables. The TV set or power cord may be damaged, which may create a fire hazard or cause electric shock.



When moving or unpacking the product, work in pairs because the product is heavy. Otherwise, this may result in injury.



Contact the service centre once a year to clean the internal parts of the product.

Accumulated dust can cause mechanical failure.



Refer all servicing to qualified service personnel. Servicing is required when the apparatus has been damaged in any way, such as power supply cord or plug is damaged, liquid has been spilled or objects have fallen into the apparatus, the apparatus has been exposed to rain or moisture, does not operate normally, or has been dropped.



If the product feels cold to the touch, there may be a small "flicker" when it is turned on. This is normal, there is nothing wrong with product.



The panel is a high technology display product with resolution of two million to six million pixels. You may see tiny black dots and/or brightly coloured dots (red, blue or green) at a size of 1 ppm on the panel. This does not indicate a malfunction and does not affect the performance and reliability of the product.

This phenomenon also occurs in third-party products and is not subject to exchange or refund.



You may find different brightness and color of the panel depending on your viewing position(left/right/top/down).

This phenomenon occurs due to the characteristic of the panel. It is not related with the product performance, and it is not malfunction.

Displaying a still image for a prolonged period of time may cause image sticking. Avoid displaying a fixed image on the TV screen for a long period of time.

Generated sound

"Cracking" noise: A cracking noise that occurs when watching or turning off the TV is generated by plastic thermal contraction due to temperature and humidity. This noise is common for products where thermal deformation is required. Electrical circuit humming/panel buzzing: A low level noise is generated from a high-speed switching circuit, which supplies a large amount of current to operate a product. It varies depending on the product.

This generated sound does not affect the performance and reliability of the product.

Do not use high voltage electrical goods near the TV (e.g. electric mosquito-swatter). This may result in product malfunction.

Preparing

NOTE

- Image shown may differ from your TV.
- Your TV's OSD (On Screen Display) may differ slightly from that shown in this manual.
- The available menus and options may differ from the input source or product model that you are using.
- New features may be added to this TV in the future.
- The TV can be placed in standby mode in order to reduce the power consumption. And the TV should be turned off if it will not be watched for some time, as this will reduce energy consumption.
- The energy consumed during use can be significantly reduced if the level of brightness of the picture is reduced, and this will reduce the overall running cost.
- The items supplied with your product may vary depending on the model.
- Product specifications or contents of this manual may be changed without prior notice due to upgrade of product functions.
- For an optimal connection, HDMI cables and USB devices should have bezels less than 10 mm thick and 18 mm width. Use an extension cable that supports USB 2.0 if the USB cable or USB memory stick does not fit into your TV's USB port.

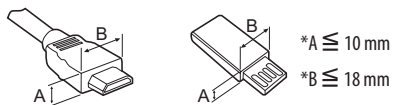

- Use a certified cable with the HDMI logo attached.
- If you do not use a certified HDMI cable, the screen may not display or a connection error may occur. (Recommended HDMI cable types)
 - High-Speed HDMI®/™ cable (3 m or less)
 - High-Speed HDMI®/™ cable with Ethernet (3 m or less)

CAUTION

- Do not use any unapproved items to ensure the safety and product life span.
- Any damage or injuries caused by using unapproved items are not covered by the manufacturer's warranty.
- Some models have a thin film attached on to the screen and this must not be removed.
- When attaching the stand to the TV set, place the screen facing down on a cushioned table or flat surface to protect the screen from scratches.
- Make sure that the screws are inserted correctly and fastened securely. (If they are not fastened securely enough, the TV may tilt forward after being installed.) Do not use too much force and over tighten the screws; otherwise screw may be damaged and not tighten correctly.

Antenna isolator installation guide

(Depending on model)

Use this to install TV in a place where there is a voltage difference between TV Set and GND of antenna signal.

- If there is a voltage difference between TV Set and GND of antenna signal, the antenna contact might be heated and excessive heat might cause an accident.

You can improve the safety when watching TV by efficiently removing power voltage from TV antenna. It is recommended to mount the isolator to the wall. If it cannot be mounted to the wall, mount it on the TV. Avoid disconnecting the antenna Isolator after installation. Before starting, be sure that the TV antenna is connected.

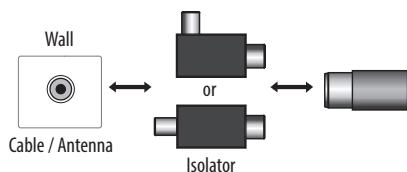

Connect one end of the isolator to cable/antenna jack and the other to TV set or set-top box.

"Equipment connected to the protective earthing of the building installation through the mains connection or through other equipment with a connection to protective earthing - and to a cable distribution system using coaxial cable, may in some circumstances create a fire hazard. Connection to a cable distribution system has therefore to be provided through a device providing electrical isolation below a certain frequency range (galvanic isolator, see EN 60728-11)"

When applying the RF Isolator, a slight loss of signal sensitivity can occur.

Maintenance

Cleaning your TV

Clean your TV regularly to keep the best performance and to extend the product lifespan.

- Make sure to turn the power off and disconnect the power cord and all other cables first.
- When the TV is left unattended and unused for a long time, disconnect the power cord from the wall outlet to prevent possible damage from lightning or power surges.

Screen, frame, cabinet and stand

To remove dust or light dirt, wipe the surface with a dry, clean, and soft cloth.

To remove major dirt, wipe the surface with a soft cloth dampened in clean water or a diluted mild detergent. Then wipe immediately with a dry cloth.

- Avoid touching the screen at all times, as this may result in damage to the screen.
- Do not push, rub, or hit the screen surface with your fingernail or a sharp object, as this may result in scratches and image distortions.
- Do not use any chemicals as this may damage the product.
- Do not spray liquid onto the surface. If water enters the TV, it may result in fire, electric shock, or malfunction.

Power cord

Remove the accumulated dust or dirt on the power cord regularly.

Lifting and moving the TV

Please note the following advice to prevent the TV from being scratched or damaged and for safe transportation regardless of its type and size.

- It is recommended to move the TV in the box or packing material that the TV originally came in.
- Before moving or lifting the TV, disconnect the power cord and all cables.
- When holding the TV, the screen should face away from you to avoid damage.



- Hold the top and bottom of the TV frame firmly. Make sure not to hold the transparent part, speaker, or speaker grill area.

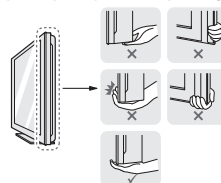

- When transporting a large TV, there should be at least 2 people.
- When transporting the TV by hand, hold the TV as shown in the following illustration.

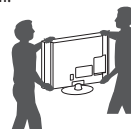

- When transporting the TV, do not expose the TV to jolts or excessive vibration.
- When transporting the TV, keep the TV upright, never turn the TV on its side or tilt towards the left or right.
- Do not apply excessive pressure to cause flexing /bending of frame chassis as it may damage screen.
- When handling the TV, be careful not to damage the protruding joystick button.

⚠ CAUTION

- Avoid touching the screen at all times, as this may result in damage to the screen.
- Do not move the TV by holding the cable holders, as the cable holders may break, and injuries and damage to the TV may occur.

Using the joystick button

(Image shown may differ from your TV.)

You can simply operate the TV functions, pressing or moving the joystick button up, down, left or right.

NOTE

- LF51 series does not have a Joystick button but has only a power On/Off button.

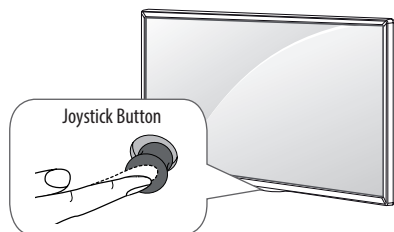

Basic Functions

	Power On	When the TV is turned off, place your finger on the joystick button and press it once and release it.
	Power Off	When the TV is turned on, place your finger on the joystick button and press it once for a few seconds and release it. (However, if the Menu button is on the screen, pressing and holding the joystick button will let you exit the Menu.)
	Volume Control	If you place your finger over the joystick button and move it left or right, you can adjust the volume level you want.
	Programmes Control	If you place your finger over the joystick button and move it up or down, you can scrolls through the saved programmes you want.

Adjusting the Menu

When the TV is turned on, press the joystick button one time. You can adjust the Menu items moving the joystick button up, down, left or right.

	Turns the power off.
	Clears on-screen displays and returns to TV viewing.
	Changes the input source.
	Accesses the main menu.

NOTE

- When your finger over the joystick button and push it to the up, down, left or right, be careful not to press the joystick button. If you press the joystick button first, you may not be able to adjust the volume level and saved programmes.

Mounting on a table

(Image shown may differ from your TV.)

1 Lift and tilt the TV into its upright position on a table.

- Leave a 10 cm (minimum) space from the wall for proper ventilation.

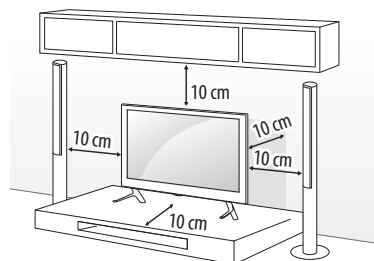

2 Connect the power cord to a wall outlet.

CAUTION

- Do not place the TV near or on sources of heat, as this may result in fire or other damage.

WARNING

If a television is not positioned in a sufficiently stable location, it can be potentially hazardous due to falling. Many injuries, particularly to children, can be avoided by taking simple precautions such as:

- Using cabinets or stands recommended by the manufacturer of the television.
- Only using furniture that can safely support the television.
- Ensuring the television is not overhanging the edge of the supporting furniture.
- Not placing the television on tall furniture (for example, cupboards or bookcases) without anchoring both the furniture and the television to a suitable support.
- Not standing the televisions on cloth or other materials placed between the television and supporting furniture.
- Educating children about the dangers of climbing on furniture to reach the television or its controls.

Using the kensington security system

(This feature is not available for all models.)

- Image shown may differ from your TV.

The Kensington security system connector is located at the rear of the TV. For more information of installation and using, refer to the manual provided with the Kensington security system or visit <http://www.kensington.com>. Connect the Kensington security system cable between the TV and a table.

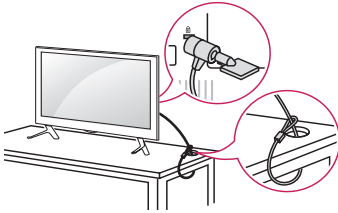

Securing the TV to a wall

(This feature is not available for all models.)

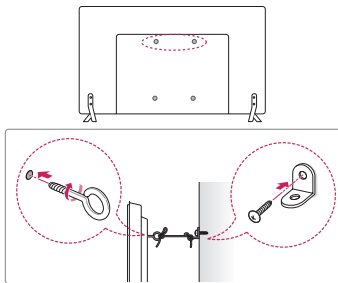

- 1 Insert and tighten the eye-bolts, or TV brackets and bolts on the back of the TV.
 - If there are bolts inserted at the eye-bolts position, remove the bolts first.
- 2 Mount the wall brackets with the bolts to the wall. Match the location of the wall bracket and the eye-bolts on the rear of the TV.
- 3 Connect the eye-bolts and wall brackets tightly with a sturdy rope. Make sure to keep the rope horizontal with the flat surface.

CAUTION

- Make sure that children do not climb on or hang on the TV.

NOTE

- Use a platform or cabinet that is strong and large enough to support the TV securely.
- Brackets, bolts and ropes are not provided. You can obtain additional accessories from your local dealer.

Mounting on a wall

Attach an optional wall mount bracket at the rear of the TV carefully and install the wall mount bracket on a solid wall perpendicular to the floor. When you attach the TV to other building materials, please contact qualified personnel. LG recommends that wall mounting be performed by a qualified professional installer. We recommend the use of LG's wall mount bracket. LG Branded wall mount is easy to move with cables connected. When you do not use LG's wall mount bracket, please use a wall mount bracket where the device is adequately secured to the wall with enough space to allow connectivity to external devices. It is advised to connect all the cables before installing fixed wall mounts.

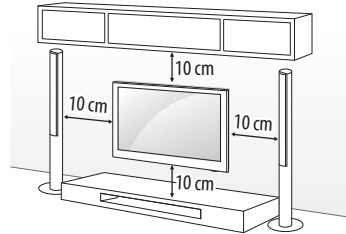

Make sure to use screws and wall mount bracket that meet the VESA standard. Standard dimensions for the wall mount kits are described in the following table.

Separate purchase (Wall mounting bracket)

Model	43LF54** 32LF55** 32/43LF51** 32LF50**	42LF55**
VESA (mm) (A x B)	200 x 200	400 x 400
Standard screw	M6	M6
Number of screws	4	4
Wall mount bracket	LSW240B MSW240	LSW440B MSW240
Model	49LF51** 49LF54**	
VESA (mm) (A x B)	300 x 300	
Standard screw	M6	
Number of screws	4	
Wall mount bracket	LSW350B MSW240	

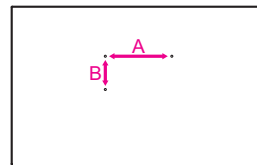

⚠ CAUTION

- Disconnect the power first, and then move or install the TV. Otherwise electric shock may occur.
- Remove the stand before installing the TV on a wall mount by performing the stand attachment in reverse.
- If you install the TV on a ceiling or slanted wall, it may fall and result in severe injury. Use an authorised LG wall mount and contact the local dealer or qualified personnel.
- Do not over tighten the screws as this may cause damage to the TV and void your warranty.
- Use the screws and wall mounts that meet the VESA standard. Any damages or injuries by misuse or using an improper accessory are not covered by the manufacturer's warranty.

! NOTE

- Use the screws that are listed on the VESA standard screw specifications.
- The wall mount kit includes an installation manual and necessary parts.
- The wall mount bracket is not provided. You can obtain additional accessories from your local dealer.
- The length of screws may differ depending on the wall mount. Make sure to use the proper length.
- For more information, refer to the manual supplied with the wall mount.
- When installing the wall mounting bracket, use the adhesive label provided. The adhesive label will protect the opening from accumulating dust and dirt. (Only when the label is provided)

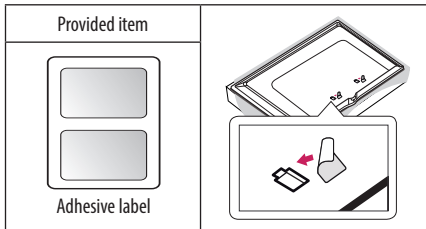

- When attaching a wall mounting bracket to the TV, insert the wall mount spacers into the TV wall mount holes to adjust the vertical angle of the TV. (Only when the item of the following form is provided)

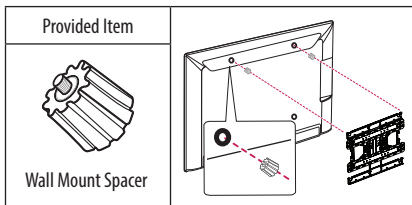

Attaching the shelf stand

(Only LF515*)

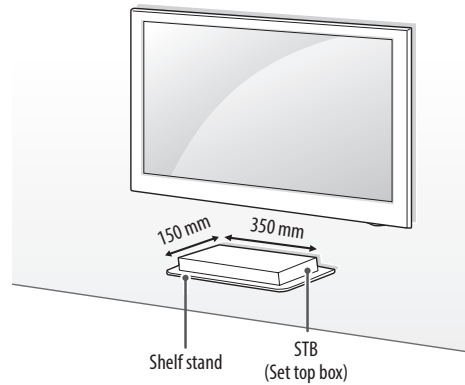

Shelf stand conditions of use

STB Dimensions (W x D)	350 mm x 150 mm
STB Weight	2.5 kg
Maximum supported weight	3.5 kg

How to attach to masonry walls

(Only LF515*)

Use the anchors for wall material of concrete, light concrete, strong natural stone, soft natural stone masonry brick and hollow block that do not crack.

Please follow the below direction

(Only LF515*)

- Check the material of the wall and the thickness of the finishing.
- When installing the product on wall material not designated, install the product so that each fixated location can withstand the pull out load of 70 kgf (686 N) and shear load of 100 kgf (980 N) or above.
- Use the Ø8 mm drill bit for concrete and hammer (Impact) drill.

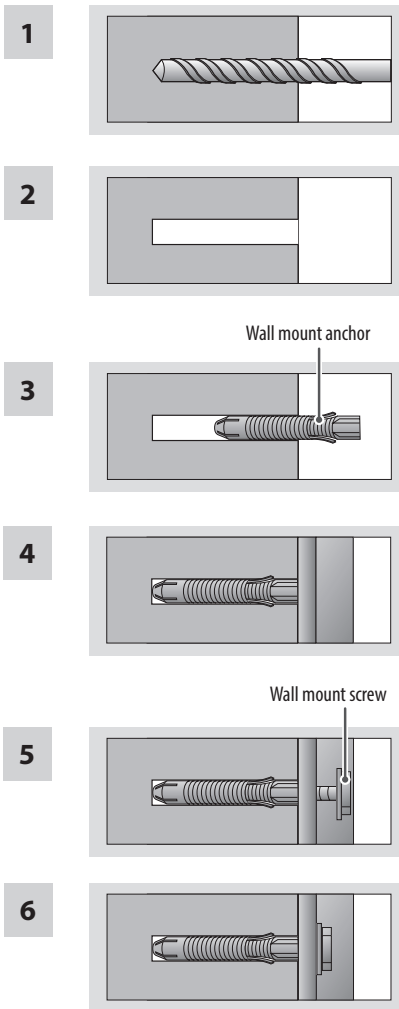

- 1 Use a drill bit $\varnothing 8$ mm to drill a hole for the anchor location within a depth of 80 mm - 100 mm.
- 2 Clean the drilled hole.
- 3 Insert the sealed anchor to the hole. (When inserting the anchor, use a hammer.)
- 4 Set the wall mount on the wall by aligning to the location of the hole. And set the angle adjusting part to face upward.
- 5 Align the wall mount screw to the hole and tighten it. Then, fasten the screws at torque of 45 kgf/cm - 60 kgf/cm.

Connections (notifications)

Connect various external devices to the TV and switch input modes to select an external device. For more information of external device's connection, refer to the manual provided with each device.

Available external devices are: HD receivers, DVD players, VCRs, audio systems, USB storage devices, PC, gaming devices, and other external devices.

NOTE

- The external device connection may differ from the model.
- Connect external devices to the TV regardless of the order of the TV port.
- If you record a TV program on a DVD recorder or VCR, make sure to connect the TV signal input cable to the TV through a DVD recorder or VCR. For more information of recording, refer to the manual provided with the connected device.
- Refer to the external equipment's manual for operating instructions.
- If you connect a gaming device to the TV, use the cable supplied with the gaming device.

Antenna connection

Connect the TV to a wall antenna socket with an RF cable (75 Ω).

- Use a signal splitter to use more than 2 TVs.
- If the image quality is poor, install a signal amplifier properly to improve the image quality.
- If the image quality is poor with an antenna connected, try to realign the antenna in the correct direction.
- An antenna cable and converter are not supplied.

Adapter connection

(Depending on model)

CAUTION

- Please be sure to connect the TV to the AC-DC power adapter before connecting the TV's power plug to a wall power outlet.

Other connections

Connect your TV to external devices. For the best picture and audio quality, connect the external device and the TV with the HDMI cable. Some separate cable is not provided.

Remote control

(Depending on model)

The descriptions in this manual are based on the buttons on the remote control. Please read this manual carefully and use the TV correctly.

To replace batteries, open the battery cover, replace batteries (1.5 V AAA) matching the ⊕ and ⊖ ends to the label inside the compartment, and close the battery cover. To remove the batteries, perform the installation actions in reverse.

⚠ CAUTION

- Do not mix old and new batteries, as this may damage the remote control.
- In Analogue TV and some countries, some remote control buttons may not work.
- The remote control will not be included for all sales market.

Make sure to point the remote control toward the remote control sensor on the TV.

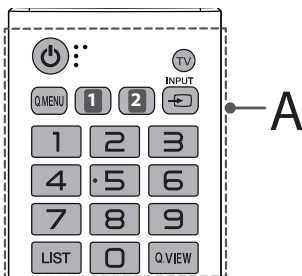

A

- ⏻ (POWER)** Turns the TV on or off.
- TV** Returns to the TV viewing from any mode.
- Q.MENU** Accesses the Quick menus.
- 1 PICTURE** Changes the image mode. (Depending on model)
- 1 AV MODE** Selects an AV mode. (Depending on model)
- 2 AV MODE** Selects an AV mode. (Depending on model)
- 2 BOLLYWOOD** Switches the BOLLYWOOD sound mode. (Depending on model)
- INPUT** Changes the input source.
- Number buttons** Enters numbers.
- LIST** Accesses the saved programme list.
- Q.VIEW** Returns to the previously viewed programme.

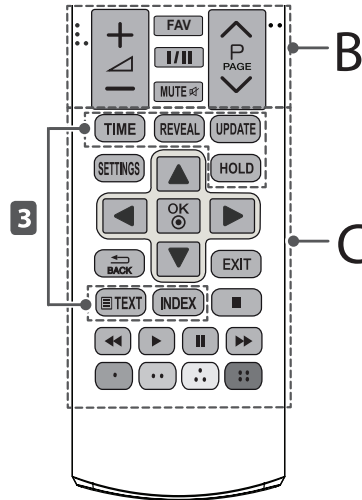

B

- + / -** Adjusts the volume level.
- FAV** Accesses your favourite programme list.
- I/II** Selects the sound output.
- MUTE** Mutes all sounds.
- ^ P v** Scrolls through the saved programmes.
- ^ PAGE v** Moves to the previous or next screen.

C

- 3 Teletext buttons** These buttons are used for teletext.
- SETTINGS** Accesses the main menus.
- Navigation buttons (up/down/left/right)** Scrolls through menus or options.
- OK** Selects menus or options and confirms your input.
- BACK** Returns to the previous level.
- EXIT** Clears on-screen displays and returns to TV viewing.
- Control buttons (■, ▶, II, ◀, ►)** Controls the ENTERTAINMENT menus.
- Coloured buttons** These access special functions in some menus. (●: Red, ●: Green, ●: Yellow, ●: Blue)

Licenses

Supported licenses may differ by model. For more information about licenses, visit www.lg.com.



Manufactured under license from Dolby Laboratories. Dolby and the double-D symbol are trademarks of Dolby Laboratories.



The terms HDMI and HDMI High-Definition Multimedia Interface, and the HDMI logo are trademarks or registered trademarks of HDMI Licensing LLC in the United States and other countries.



This DivX Certified® device has passed rigorous testing to ensure it plays DivX® video. To play purchased DivX movies, first register your device at vod.divx.com. Find your registration code in the DivX VOD section of your device setup menu.

DivX Certified® to play DivX® video up to HD 1080p, including premium content.

DivX®, DivX Certified® and associated logos are trademarks of DivX, LLC and are used under license.

Covered by one or more of the following U.S. patents: 7,295,673; 7,460,668; 7,515,710; 7,519,274.

Open source software notice information

To obtain the source code under GPL, LGPL, MPL, and other open source licenses, that is contained in this product, please visit <http://opensource.lge.com>.

In addition to the source code, all referred license terms, warranty disclaimers and copyright notices are available for download.

LG Electronics will also provide open source code to you on CD-ROM for a charge covering the cost of performing such distribution (such as the cost of media, shipping, and handling) upon email request to opensource@lge.com. This offer is valid for three (3) years from the date on which you purchased the product.

Watching TV

Turning the TV on for the first time

When you turn the TV on for the first time, the Initial setting screen appears. Select a language and customize the basic settings.

- 1 Connect the power cord to a power outlet. The Power indicator turns red and the TV switches to Standby mode.
- 2 In Standby mode, press the power button on the remote control or local key to turn the TV on. The Initial setting screen appears if you turn the TV on for the first time.

! NOTE

- You can also access **Factory Reset** by accessing **OPTION** in the main menu.

- 3 Follow the on-screen instructions to customize your TV settings according to your preferences.

Menu Language Selects a language to display.



Mode Setting Selects **Home Use** for the home environment.



Time Setting Sets the time.



Auto Tuning Scans and saves available programmes automatically.

NOTE

- To display images in the best quality for your home environment, select **Home Use**.
- **Store Demo** is suitable for the retail environment.
- If you select **Store Demo**, any customized settings will switch back to the default settings of **Store Demo** in 5 minutes.

4 When the basic settings are complete, press the **OK**.

NOTE

- If you do not complete the Initial setting, it will appear whenever the TV turns on.
- Disconnect the power cord from the power outlet when you do not use the TV for a long period of time.

5 To turn the TV off, press the power button on the remote control.

Watching TV

- 1 In Standby mode, press **(POWER)** to turn the TV on.
- 2 Press **INPUT** and select **TV**.
- 3 To turn the TV off, press **(POWER)**. The TV switches to Standby mode.

Managing programmes

Automatically setting up programme

Use this to automatically find and store all available programmes.

- 1 Press **SETTINGS** and the Navigation buttons to scroll to **SETUP** and press **OK**.
- 2 Press the Navigation buttons to scroll to **Auto Tuning** and press **OK**.
- 3 Press the Navigation buttons to scroll to **Start** and select **Start** to begin auto tuning. The TV scans and saves available programmes automatically.
- 4 When you return to the previous menu, press **BACK**.

Manually setting up programme

Manual Tuning lets you manually tune and arrange the stations in whatever order you desire.

- 1 Press **SETTINGS** and the Navigation buttons to scroll to **SETUP**.
- 2 Press the Navigation buttons to scroll to **Manual Tuning**.
- 3 Press the Navigation buttons to scroll to **Storage**.
- 4 Press the Navigation buttons or Number buttons to select the desired programme number.
- 5 Press the Navigation buttons to scroll to **System**.

- 6 Press the Navigation buttons to scroll to **TV System**.
- 7 Press the Navigation buttons to scroll to **Band**.
- 8 Press the Navigation buttons to scroll to **V/UHF** or **Cable**.
- 9 Press the Navigation buttons to scroll to **Channel**.
- 10 Press the Navigation buttons and then select the desired Channel number with the Navigation buttons or Number buttons.
- 11 Press the Navigation buttons to scroll to **Search**.
- 12 Press the Navigation buttons to scroll and start Searching.
- 13 Press the **OK** to store it.
- 14 When you return to the previous menu, press **BACK**.

NOTE

- To store another programme, repeat steps 3 to 13.

Assigning a station name

You can assign a station name with five characters to each programme number.

- 1 Press **SETTINGS** and the Navigation buttons to scroll to **SETUP**.
- 2 Press the Navigation buttons to scroll to **Manual Tuning**.
- 3 Press the Navigation buttons to scroll to **Name**.
- 4 Press the Navigation buttons to scroll to select the position and make your choice of the second character, and so on. You can use the alphabet A to Z, the number 0 to 9, +/ -, and blank and press **OK**.
- 5 Press the **OK** to store it.
- 6 When you return to the previous menu, press **BACK**.

Fine Tuning

Normally fine tuning is only necessary if reception is poor.

- 1 Press **SETTINGS** and the Navigation buttons to scroll to **SETUP**.
- 2 Press the Navigation buttons to scroll to **Manual Tuning**.
- 3 Press the Navigation buttons to scroll to **Fine**.
- 4 Press the Navigation buttons to fine tune for the best picture and sound.
- 5 Press the **OK** to store it.
- 6 When you return to the previous menu, press **BACK**.

Editing your programme list

When a programme number is skipped, it means that you will be unable to select it using **^ P v** button during TV viewing.

If you wish to select the skipped programme, directly enter the programme number with the **NUMBER** buttons or select it in the Programme edit menu.

This function enables you to skip the stored programmes.

- 1 Press **SETTINGS** and the Navigation buttons to scroll to **SETUP**.
- 2 Press the Navigation buttons to scroll to **Programme Edit**.
- 3 Edit programmes using the following buttons.

Button	Description
Red button	Deletes a programme. Press the Red button twice. The selected programme is deleted, all the following programmes are shifted up one position.
Yellow button	Moves a programme. Press the Yellow button again to release this function.
Blue button	Selects a programme number to be skipped. Press the Blue button again to release the skipped programme.

- 4 When you return to the previous menu, press **↩ BACK**.

Selecting a programme on the programme list

- 1 Press **LIST** to access the programme list.
- 2 Press the Navigation buttons to select to desired programme and press **OK**.
- 3 When you return to the previous menu, press **LIST**.

! NOTE

- You may find some blue programmes. They have been set up to be skipped by auto programming or in the programme edit mode.
- Some programmes with the programme number shown in the programme list indicate there is no station name assigned.

Using additional options

Adjusting aspect ratio

Resize an image to view at its optimal size by pressing **Q.MENU** or accessing Aspect Ratio in the **PICTURE** menu.

! NOTE

- The available ratio varies depending on the input source.
- **16:9** : Resizes images to fit the screen width.



- **Just Scan** : Displays video images in the original size without removing parts of the edge of the image. (This function works in Component/HDMI (720p / 1080i / 1080p) Mode.)



! NOTE

- If you select **Just Scan**, you may see image noises at the edge of the original signal.
- **Original** : When your TV receives a wide screen signal it will automatically change to the picture format broadcasted.

(4:3 → 4:3)

(16:9 → 16:9)



- **4:3** : Resizes images to the previous standard 4:3.



- **14:9** : You can view a picture format of 14:9 or a general TV programme in the 14:9 mode. The 14:9 screen is viewed in the same way as in 4:3, but is moved to the up and down.

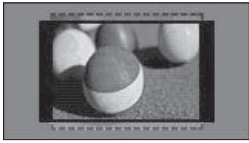

- **Zoom** : Formats an image to fit the screen width. The top and bottom of the image may not appear.

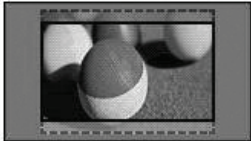

- **Cinema Zoom 1** : Formats an image to the cinemascope ratio, 2.35:1. To change the ratio of the cinema zoom, press < or > and its range is from 1 to 16.



! NOTE

- If you enlarge or reduce an image, the image may be distorted. Using the input list.

Changing AV modes

Each **AV MODE** has optimized image and sound settings. Press **AV MODE** repeatedly to select an appropriate mode.

Mode	Description
Off	Changes to the previously customized settings.
Cinema	Uses the optimized image and sound settings for a cinematic look.
Game	Uses the optimized image and sound settings for fast gaming. When playing a video game using PlayStation or Xbox, it is recommended to use the Game mode. When in Game mode, functions related to picture quality will be optimized for playing games.

Using the input list

Selecting an input source

- 1 Press **INPUT** to access the input sources.
 - The connected device displays on each input source.
- 2 Press the Navigation buttons or input button to scroll to one of the input sources and press **OK**.

* Image shown may differ from your TV.

A Type)

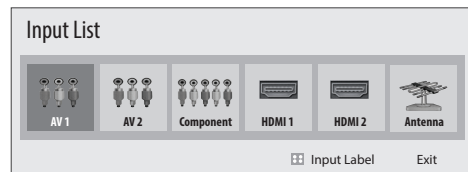

B Type)

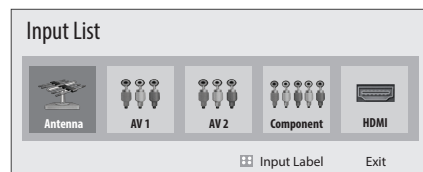

Input source	Description
TV	Watch TV over the air and cable broadcast.
AV 1/2	Watch video from a VCR or other external devices.
Component	Select it when using the DVD or the Digital set-top box depends on connector.
HDMI 1/2 HDMI	Watch video from a HTS or other high definition devices.

ENTERTAINMENT

(Depending on model)

* Image shown may differ from your TV.

Connecting USB storage devices

Connect USB storage devices (USB memory) to the TV and use multimedia features (See "Browsing files" on page 19).

Connect a USB flash memory or USB memory card reader to the TV as shown on the following illustration.

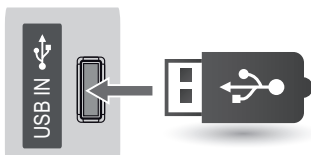

To disconnect a USB storage device, make sure to end the connection properly to prevent damages to the TV or files.

- 1 Press **Q.MENU** to access the quick menus.
- 2 Press the Navigation buttons to scroll to **Eject** and press **OK**.
- 3 Disconnect the USB storage device only when the message says that it is safe to remove.

CAUTION

- Do not turn the TV off or remove a USB storage device while the USB storage device is connected to the TV, as this could result in loss of files or damage to the USB storage device.
- Back up your files saved on a USB storage device frequently, as you may lose or damage the files and this may be not covered by the manufacturer's warranty.

Tips for using USB storage devices

- Only a USB storage device is recognizable.
- If the USB storage device is connected through a USB hub, the device is not recognizable.
- A USB storage device using an automatic recognition programme may not be recognized.
- A USB storage device which uses its own driver may not be recognized.
- The recognition speed of a USB storage device may depend on each device.
- Please do not turn off the TV or unplug the USB device when the connected USB storage device is working. When such device is suddenly separated or unplugged, the stored files or the USB storage device may be damaged.
- Please do not connect the USB storage device which was artificially manoeuvred on the PC. The device may cause the product to malfunction or fail to be played. Never forget to use only a USB storage device which has normal music files, image files or movie files.
- Please use only a USB storage device which was formatted as a FAT16, FAT32, NTFS file system.
- Please connect a USB storage device with the cable offered by the device maker.
- Some USB storage devices may not be supported or operated smoothly.
- Be sure to back up important files since data stored in a USB memory device may be damaged. We will not be responsible for any data loss.
- If a USB memory device is connected to a USB multi-card reader, its volume data may not be detected.
- If the USB memory device does not work properly, disconnect and reconnect it.
- How fast a USB memory device is detected differs from device to device.
- The recommended capacity is 1 TB or less for a USB external hard disk and 32 GB or less for USB memory.
- Any device with more than the recommended capacity may not work properly.
- USB storage devices below USB 2.0 are supported as well. But they may not work properly in the movie list.
- Maximum of 999 folders or files can be recognized under one folder.
- If there are a lot of folders or files all within one folder, the device may not be able to access these properly.
- For external USB HDDs, it is recommended that you use devices with a rated voltage of less than 5 V and a rated current of less than 0.5A.

Browsing files

Access the photo, music, or movie lists and browse files.

- 1 Connect a USB storage device.
- 2 Press **SETTINGS** to access the main menus.
- 3 Press the Navigation buttons to scroll to **ENTERTAINMENT** and press **OK**.
- 4 Press Navigation buttons to scroll to **PHOTO LIST**, **MUSIC LIST** or **MOVIE LIST** and press **OK**.

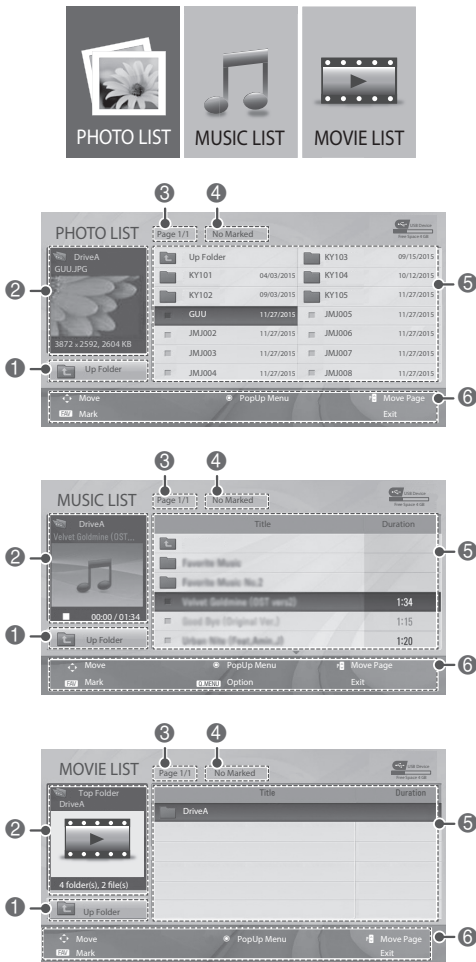

No.	Description
1	Moves to the upper level folder.
2	Preview : Displays the thumbnail/folder name of the file in the selected folder.
3	Current page/Total pages.
4	Total number of marked files.
5	Contents under the folder focused on 1.
6	Available buttons on the remote control.

Supported file format

Type	Supported file format
Photo	<p>JPEG</p> <p>Available size</p> <p>Baseline : 64 pixel (W) x 64 pixel (H) - 15360 pixel (W) x 8640 pixel (H)</p> <p>Progressive : 64 x 64 to 1024 x 768</p> <ul style="list-style-type: none"> You can play JPEG files only. Non-supported files are displayed in the form of predefined icon.
Music	<p>MP3</p> <p>Bit rate 32 kbps to 320 kbps</p> <ul style="list-style-type: none"> Sampling rate MPEG1 Layer3 : 32 kHz, 44.1 kHz, 48 kHz Sampling rate MPEG2 Layer3 : 16 kHz, 22.05 kHz, 24 kHz Sampling rate MPEG2.5 Layer3 : 8 kHz, 11.025 kHz, 12 kHz

Movie	DAT,MPG,MPEG,VOB,AVI,DivX,MP4,MKV,TS,TRP,TPA,SF,WMV,FLV,RM,RMVB Movie /*.mpg/*.*mpeg/*.*dat/*.*ts/*.*trp/*.*tp/*.*vob/*.*mp4/*.*mov/*.*mkv/*.*divx/*.*avi/*.*asf/*.*wmv/*.*flv/*.*avi(motion-jpeg)/*.*mp4(motion-jpeg)/*.*mkv(motion-jpeg)/*.*rm/*.*rmvb) supporting file Video format : DivX 3.11, DivX 4, DivX 5, DivX 6, Xvid1.00, Xvid1.01, Xvid1.02, Xvid1.03, Xvid1.10 beta-1/beta-2, Mpeg-1, Mpeg-2, Mpeg-4, H.264/AVC, VC1, JPEG, Sorenson H.263 Audio format : Dolby Digital, AAC, Mpeg, MP3, LPCM, ADPCM, WMA Bit rate : within 32 kbps to 320 kbps(MP3) External Subtitle format : *.smi/*.*srt/*.*sub(MicroDVD, Subviewer1.0/2.0)/*.*ass/*.*ssa/*.*txt(TMPLayer)/*.*psb(PowerDivX) Internal Subtitle format : Only XSUB (It is the subtitle format used in DivX6 files)
--------------	---

Viewing photos

View image files saved in a USB storage device. The displays on the screen may differ from the model.

- 1 Press **SETTINGS** to access the main menus.
- 2 Press the Navigation buttons to scroll to **ENTERTAINMENT** and press **OK**.
- 3 Press the Navigation buttons to scroll to **PHOTO LIST** and press **OK**.
- 4 Press the Navigation buttons to scroll to a folder/file you want and press **OK**.
- 5 View photos by using the following menus buttons.

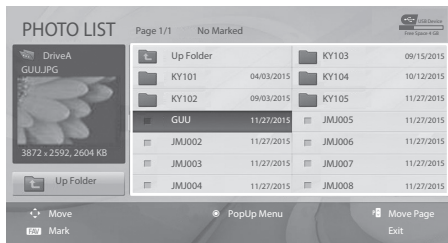

Button	Description
Navigation button	Scrolls through the files.
OK (OK icon)	Views the highlighted file or enters the mark mode.
^ P ^	Moves to the previous or next page.
FAV	Enters the mark mode.
Menu	Description
View	Views the selected photo.
Mark All	Selects all files.
Close	Exits the Mark Mode.

NOTE

- Non-supported files are displayed the preview image by icon only (Warning icon).
- Abnormal files are displayed in the form of bitmap (Close icon).

6 The following options are available while viewing photos.



Option	Description
Slideshow	Starts or stops a slideshow with selected photos. If there are no selected photos, all photos saved in the current folder display during a slideshow. To set a slideshow speed, select Option .
BGM	Turns the background music on or off. To set the background music folder, select Option .
(Rotate) (Rotate icon)	Rotates photos clockwise (90°, 180°, 270°, 360°). NOTE • The supported photo size is limited. You cannot rotate a photo if the resolution of the rotated width is larger than the supported resolution size.
Hide	Hides the option window. To display the options, press OK .

Q.MENU options for photo list

- 1 Press **Q.MENU**.
A pop-up window will appear.
- 2 Press the Navigation buttons to scroll to **Set photo view**, and press **OK**.
- 3 Press the Navigation buttons to scroll to one of the following options and press **OK**.

Set photo view.

Option	Description
Slide Speed	Selects a slideshow speed (Fast, Normal, Slow).
Music Folder	Selects a music folder for the background music.

Set video.

Allows you to change Video presets. (See p. 25)

Set audio.

Allows you to change Audio presets. (See p. 27)

Listening to music

- 1 Press **SETTINGS** to access the main menus.
- 2 Press the Navigation buttons to scroll to **ENTERTAINMENT** and press **OK**.
- 3 Press the Navigation buttons to scroll to **MUSIC LIST** and press **OK**.
- 4 Press the Navigation buttons to scroll to a folder/file you want and press **OK**.
- 5 Play music by using the following menus/buttons.

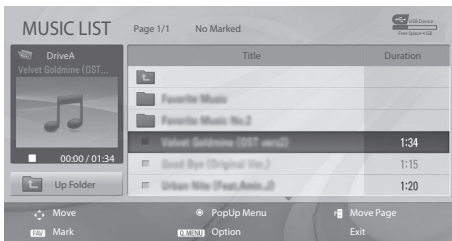

Button	Description
Navigation button	Scrolls through the files.
OK	Views the highlighted file or enters the mark mode.
^ P v	Moves to the previous or next page.
FAV	Enters the mark mode.
Menu	Description
Play	Plays the selected music file.
Play with Photo	Displays photos during playback.
Mark All	Selects all files.
Close	Exits the Mark Mode.

6 Control playback by using the following buttons.

Button	Description
■	Stops playback.
▶	Plays a music file.
 	Pauses or resumes playback.
▶▶	Skips to the next file.
◀◀	Skips to the previous file.
◀◀ or ▶▶	When playing, When you press the ◀◀ button, the previous music file will be played. When you press the ▶▶ button, the next music file will be played.
EXIT	When you press the EXIT button, only the music will be stopped and the player will go to TV viewing.
▲ or ▼	When using the ▲ or ▼ button during playback a cursor indicating the position can be played.

Q.MENU options for music list

- 1 Press **Q.MENU**.
A pop-up window will appear.

Set audio.

Allows you to change Audio presets. (See p. 27)

NOTE

- The TV will not play copy protected files.
- If the TV is not in use for some time during playback, the information box as a screensaver will appear to prevent image burn. To return to the Music list screen, press **OK** or **BACK**.

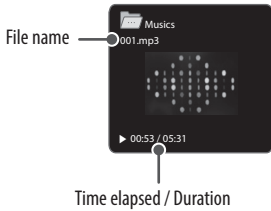

Viewing movies

- 1 Press **SETTINGS** to access the main menus.
- 2 Press the Navigation buttons to scroll to **ENTERTAINMENT** and press **OK**.
- 3 Press the Navigation buttons to scroll to **MOVIE LIST** and press **OK**.
- 4 Press the Navigation buttons to scroll to a folder/file you want and press **OK**.
- 5 Play movie by using the following menus/buttons.

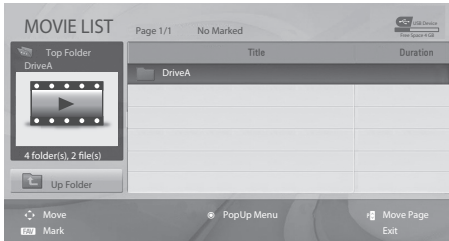

Button	Description
Navigation button	Scrolls through the files.
OK	Views the highlighted file or enters the mark mode.
^ P v	Moves to the previous or next page.
FAV	Enters the mark mode.
Menu	Description
Play	Plays the selected movie file. Once a movie file finishes playing, the next selected one will be played automatically.
Mark All	Marks all movie files on the screen.
Close	Exits the Mark Mode.

6 Control playback by using the following buttons.



Button	Description
■	Stops the playback.
▶	Plays a video.
⏸	Pauses or resumes the playback.
⏮	Scans backward in a file.
⏭	Scans forward in a file.
Q.MENU	Shows the Option menu.
BACK	Hides the menu on the full-sized screen.
EXIT	Returns to normal TV viewing.
◀ or ▶	Skips to specific points in a file during playback. The time of a specific point will appear on the status bar. In some files, this function may not work properly.

Tips for using playing video files

- Some user-created subtitles may not work properly.
- Some special characters are not supported in subtitles.
- HTML tags are not supported in subtitles.
- Subtitles in languages other than the supported languages are not available.
- Changing font and colour in subtitles is not supported.
- Subtitles in languages other than one specified are not supported.
- Video files with subtitle files of 1 MB or larger may not be played properly.
- The screen may suffer temporary interruptions (image stoppage, faster playback, etc.) when the audio language is changed.
- A damaged movie file may not be played correctly, or some player functions may not be usable.
- Movie files produced with some encoders may not be played correctly.
- If the video and audio structure of recorded file is not interleaved, either video or audio is outputted.
- HD videos with a maximum of 1920 x 1080 @ 25/30P or 1280 x 720 @ 50/60P are supported, depending on the frame.
- Videos with resolutions higher than 1920 X 1080 @ 25/30P or 1280 x 720 @ 50/60P may not work properly depending on the frame.
- Movie files other than the specified types and formats may not work properly.
- Max bit rate of playable movie file is 20 Mbps. (only, Motion JPEG : 10 Mbps)
- We do not guarantee smooth playback of profiles encoded level 4.1 or higher in H.264/AVC.
- DTS Audio codec is not supported.
- A movie file more than 30 GB in file size is not supported for playback. The file size limit is dependent on the encoding environment.
- A DivX movie file and its subtitle file must be located in the same folder.
- A video file name and its subtitle file name must be identical for it to be displayed.
- Playing a video via a USB connection that doesn't support high speed may not work properly.
- Files encoded with GMC(Global Motion Compensation) and Qpel (Quarterpel Motion Estimation) may not be played.
- Trick Mode does not support other functions than if video files do not have index information.
- Video file names that contain special characters may not be playable.

Video options

- 1 Press **Q.MENU** to access the Pop-Up menus.
- 2 Press the Navigation buttons to scroll to **Set video play., Set video.** or **Set audio.** and press **OK** .

When you select the **Set video play.**

- 1 Press the Navigation buttons to scroll to show the **Picture Size, Audio Language, Subtitle.**
- 2 Press the Navigation buttons to scroll to make appropriate adjustments.

Menu	Description
Picture Size	Selects your desired picture format during movie play.
Audio Language	Changes the Language Group of the audio during movie play. Files with a single audio track cannot be selected.
Subtitle	Turns on/off the subtitle.
Language	Activated for SMI subtitle and can select the language within the subtitle.
Code Page	Selects the font for subtitle. When set to default, same font as general menu will be used.
Sync	Adjusts the time synchronisation of the subtitle from -10 secs to +10 secs by steps of 0.5 secs during movie play.

Code Page	Support Language
Latin1	English, French, Spanish, Portuguese, Bahasa Malaysia, Bahasa Indonesia
Cyrillic	Russian
Thai	Thai
Hebrew	Hebrew
Arabic	Arabic, Persian, Kurdish
Vietnam	Vietnamese

NOTE

- Only 10,000 of sync blocks can be supported within the subtitle file.
- When playing a video, you can adjust the Picture Size by pressing **Q.MENU** or accessing Aspect Ratio in the **PICTURE** menu.

When you select the **Set video**.

- 1 Press the Navigation buttons to scroll to make appropriate adjustments. (See p. 25)

When you select the **Set audio**.

- 1 Press the Navigation buttons to scroll to show the **Sound Mode, Auto Volume, Balance**.
- 2 Press the Navigation buttons to scroll to make appropriate adjustments. (See p. 27)

DivX® VOD Guide

DivX® VOD Registration

In order to play purchased or rented DivX® VOD contents, you should register your device with 10 digit DivX registration code from your device at www.divx.com/vod.

- 1 Press **SETTINGS** to access the main menus.
- 2 Press the Navigation buttons to scroll to **ENTERTAINMENT** and press **OK**.
- 3 Press the Navigation buttons to scroll to **DivX(R) VOD** and press **OK**.
- 4 Press the Navigation buttons to scroll to **Registration** and press **OK**.
- 5 View the registration code of your TV.

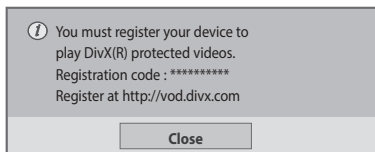

- 6 When you are finished, press **EXIT**. When you return to the previous menu, press **BACK**.

NOTE

- Movie files are supported as follows
- **Resolution** : Under 1920 x 1080 (W x H) pixels
- **Frame Rate** : Under 30 frames/sec
- **Video Codec** : MPEG 1, MPEG 2, MPEG 4, H.264/AVC, DivX 3.11, DivX 4, DivX 5, DivX 6, Xvid 1.00, Xvid 1.01, Xvid 1.02, Xvid 1.03, Xvid 1.10-beta1, Xvid 1.10-beta2, JPEG, VC1, Sorenson H.263/H.264.

DivX® VOD Deregistration

You should deregister your device with 8 digit DivX deregistration code from your device at www.divx.com/vod.

NOTE

- Once the deregistration is executed, you must register your device again to see DivX® VOD contents.

- 1 Press **SETTINGS** to access the main menus.
- 2 Press the Navigation buttons to scroll to **ENTERTAINMENT** and press **OK**.
- 3 Press the Navigation buttons to scroll to **DivX(R) VOD** and press **OK**.
- 4 Press the Navigation buttons to scroll to **Deregistration** and press **OK**.
- 5 Press the Navigation buttons to select **Yes** to confirm.

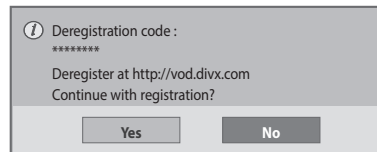









- 6 When you are finished, press **EXIT**. When you return to the previous menu, press **BACK**.

Customizing TV setting

* Image shown may differ from your TV.

Accessing main menus

- 1 Press **SETTINGS** to access the main menus.
- 2 Press the Navigation buttons to scroll to one of the following menus and press **OK**.
- 3 Press Navigation buttons to scroll to the setting or option you want and press **OK**.
- 4 When you are finished, press **EXIT**.

Menu	Description
 SETUP	Sets up and edit programmes.
 PICTURE	Adjusts the image size, quality, or effect.
 AUDIO	Adjusts the sound quality, effect, or volume level.
 TIME	Sets the time, date, or timer feature.
 OPTION	Customizes the general settings.
 LOCK	Locks or unlocks programmes.
 INPUT	Views the input sources with their labels.
 ENTERTAINMENT	Displays photo and play music, movie, game (Depending on model) contents.

Customizing settings

SETUP settings

- 1 Press **SETTINGS** and the Navigation buttons to scroll to **SETUP**.
- 2 Press the Navigation buttons to scroll to the setting or option you want and press **OK**.
- 3 When you return to the previous menu, press **BACK**.
* Image shown may differ from your TV.

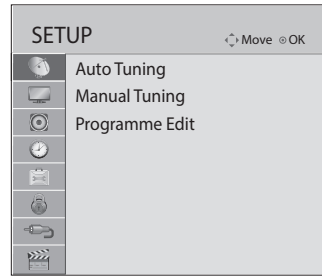

The available programme settings are described in the following:

Setting	Description
Auto Tuning	Tunes and stores all available programmes through antennas inputs. (See p. 15)
Manual Tuning	Tunes and stores the programmes you want manually. (See p. 15)
Programme Edit	Edits programmes. (See p. 16)

PICTURE settings

- 1 Press **SETTINGS** and the Navigation buttons to scroll to **PICTURE**.
- 2 Press the Navigation buttons to scroll to the setting or option you want and press **OK**.
- 3 When you return to the previous menu, press **BACK**.
* Image shown may differ from your TV.

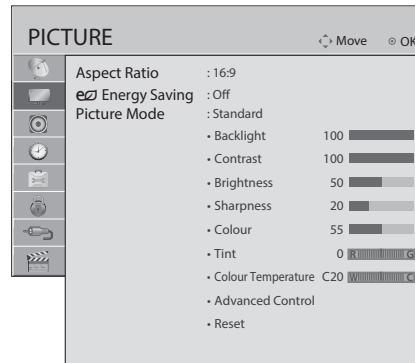

The available picture settings are described in the following.

Setting	Description	
Aspect Ratio	Changes the image size to view images at its optimal size. (See p. 16)	
Energy Saving	Reduces the power consumption by adjusting the screen brightness.	
	Option	
	Off	The Energy Saving is off
	Minimum/ Medium/ Maximum	Selects the brightness level.
	Screen off	The screen turns off in 3 seconds.
	<p>NOTE</p> <ul style="list-style-type: none"> When you select Screen Off, the screen will be turned off in 3 seconds and Screen Off will start. If you adjust "Energy Saving- Maximum", Backlight feature will not work. 	
Picture Mode	Selects one of the preset image or customizes options in each mode for the best TV screen performance. You are also able to customize advanced options of each mode.	
	Mode	
	Vivid	Adjusts the video image for the retail environment by enhancing the contrast, brightness, colour, and sharpness.
	Standard	Adjusts the image for the normal environment.
	Cinema	Optimizes the video images for a cinematic look to enjoy movies as if you are in a movie theatre.
	Soccer	Optimizes the video image for high and dynamic actions by emphasizing primary colours such as white, grass, or sky blue.
	Game	Optimizes the video image for a fast gaming screen such as PCs or games.

Basic image options

Setting	Description
Backlight	Adjusts the brightness of the screen by controlling the LCD backlight. If you decrease the brightness level, the screen becomes darker and the power consumption will be reduced without any video signal loss.
Contrast	Increases or decreases the gradient of the video signal. You may use Contrast when the bright part of the picture is saturated.
Brightness	Adjusts the base level of the signal in the picture.
Sharpness	Adjusts the level of crispness in the edges between the light and dark areas of the picture. The lower the level, the softer the image.
Colour	Adjusts intensity of all colours.
Tint	Adjusts the balance between red and green levels.
Colour Temperature	Adjusts the overall tone of the screen as desired. Set to warm to enhance hotter colours such as red, or set to cool to see less intense colours with more blue.
Advanced Control	Customizes the advanced options.
Reset	Restores the options of each mode to the factory default.

Advanced image options (Depending on model)

Setting	Description
Dynamic Contrast	Adjusts the contrast to keep it at the best level according to the brightness of the screen. The picture is improved by making bright parts brighter and dark parts darker.
Dynamic Colour	Adjusts screen colours so that they look livelier, richer and clearer. This feature enhances hue, saturation and luminance so that red, blue and green white look more vivid.
Noise Reduction	Reduces screen noise without compromising video quality.
Gamma	You can adjust brightness of dark area and middle gray level area of the picture. <ul style="list-style-type: none"> • Low: Make the dark and middle gray level areas brighter. • Medium: Express the original picture level. • High: Make the dark and middle gray level area darker.
Black Level	Sets black level of the screen to proper level. This function is available in the following modes: RF, AV or HDMI. <ul style="list-style-type: none"> • Low: The reflection of the screen gets darker. • High: The reflection of the screen gets brighter.
Motion Eye Care	Adjusts screen brightness to prevent eye glare.
Film Mode	Makes video clips recorded in film look more natural. This feature operates only in 480i / 576i / 1080i Resolution.
Colour Gamut	Advanced control Maximizes the utilization of colour to increase colour quality. <ul style="list-style-type: none"> • Standard: Displays standard set of colours. • Wide: Increase number of colours used.
Edge Enhancer	Shows clearer and distinctive yet natural edges of the video.

NOTE

- Depending on input signal or other picture settings, the range of detailed items for adjustment may differ.

AUDIO settings

- 1 Press **SETTINGS** and the Navigation buttons to scroll to **AUDIO**.
- 2 Press the Navigation buttons to scroll to the setting or option you want and press **OK**.
- 3 When you return to the previous menu, press **BACK**.

* Image shown may differ from your TV.

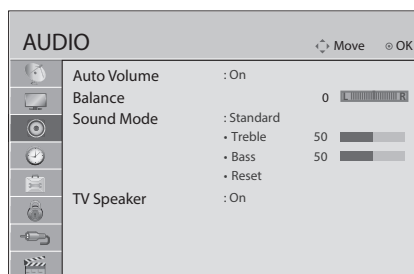

The available audio settings are described in the following.

Setting	Description
Auto Volume	Activates the Auto Volume feature to keep the volume level consistent whenever you change programmes. The volume level may not be consistent due to different signal conditions of broadcasting stations.
Balance	Adjust balance between the left and right speakers according to your room environment.

Setting	Description	
Sound Mode	Selects one of the preset sound modes or customizes options in each mode.	
	Mode	
	Standard	Select when you want standard-quality sound.
	Music/ Bollywood (Depending on model)	Select when you listen to music. (Bollywood is india special music mode)
	Cinema	Select when you watch movies.
	Soccer	Select when you watch sports events.
	Game	Select when you play games.
	Option	
	Treble	Controls the dominant sounds in the output. When you turn up the treble, it will increase the output to the higher frequency range.
	Bass	Controls the softer sounds in the output. When you turn up the bass, it will increase the output to the lower frequency range.
Reset	Resets the sound mode to the default setting.	
TV Speaker	Turns off the internal speaker of the TV when using an external Hi-Fi system.	

This feature may not be applied based on country broadcasting circumstance.

Stereo/Dual Reception

When a programme is selected, the sound information for the station appears with the programme number and station name.

Press **I/II** button to select the **Multi Audio** menu.

Broadcast	On Screen Display
Mono	MONO
Stereo	STEREO
Dual	DUAL I , DUAL II , DUAL I + II
NICAM	NICAM

• Mono sound selection

If the stereo signal is weak in stereo reception, you can switch to mono. In mono reception, the clarity of sound is improved.

• Language selection for dual language broadcast

If a programme can be received in two languages (dual language), you can switch to DUAL I, DUAL II or DUAL I+II.

- DUAL I** Sends the primary broadcast language to the loudspeakers.
- DUAL II** Sends the secondary broadcast language to the loudspeakers.
- DUAL I+II** Sends a separate language to each loudspeaker.

Nicam Reception

If the TV is equipped with a receiver for NICAM reception, high quality NICAM (Near Instantaneous Companding Audio Multiplex) digital sound can be received.

Sound output can be selected according to the type of broadcast received.

- When **NICAM** mono is received, you can select **NICAM MONO** or **FM MONO**.
- When **NICAM** stereo is received, you can select **NICAM STEREO** or **FM MONO**.
If the stereo signal is weak, switch to **FM MONO**.
- When **NICAM** dual is received, you can select **NICAM DUAL I**, **NICAM DUAL II** or **NICAM DUAL I+II** or **FM MONO**.

Speaker Sound Output Selection

In AV, Component, HDMI mode, you can select output sound for the left and right loudspeakers.

Select the sound output.

- L+R:** Audio signal from audio L input is sent to the left loudspeaker and audio signal from audio R input is sent to the right loudspeaker.
- L+L:** Audio signal from audio L input is sent to left and right loudspeakers.
- R+R:** Audio signal from audio R input is sent to left and right loudspeakers.

TIME settings

- 1 Press **SETTINGS** and the Navigation buttons to scroll to **TIME**.
- 2 Press the Navigation buttons to scroll to the setting or option you want and press **OK**.
- 3 When you return to the previous menu, press **BACK**.
* Image shown may differ from your TV.

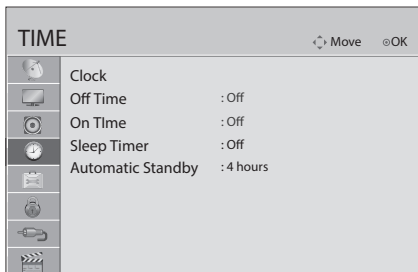

The available time settings are described in the following.

Setting	Description
Clock	Sets the time.
Off Time / On Time	<p>Sets the time to turn on or off the TV automatically. To use this function, you should set the current time and date in advance.</p> <p>NOTE</p> <ul style="list-style-type: none"> • If you do not press any button within 2 hours after the TV turns on by the On Time feature, the TV enters the Standby mode automatically. • If you set both Off Time and On Time features to the same time, the Off Time feature overrides the On Time feature.
Sleep Timer	Sets the length of time until the TV to turns off. When you turn the TV off and turn it on again, the Sleep Timer feature will be set to off.
Automatic Standby (Depending on model)	If you do not press any button on the TV or remote control for a certain period, the TV will automatically switch to standby mode.

OPTION settings

- 1 Press **SETTINGS** and the Navigation buttons to scroll to **OPTION**.
- 2 Press the Navigation buttons to scroll to the setting or option you want and press **OK**.
- 3 When you return to the previous menu, press **BACK**.
* Image shown may differ from your TV.

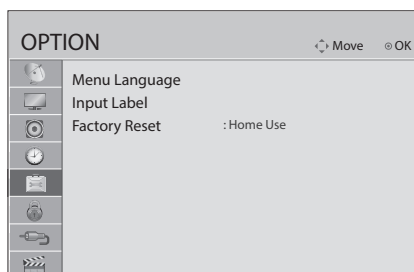

The available option settings are described in the following.

Setting	Description			
Menu Language	Selects a desired language.			
Input Label	Indicates which device is connected to which input port.			
Factory Reset	Customizes the TV settings to suit your preference. The initial setup screen will appear when you turn on the TV for the first time.			
	<table border="1"> <tr> <td>Home Use</td> <td>Selects it for the Home environment.</td> </tr> <tr> <td>Store Demo</td> <td>Selects it for the retail environment.</td> </tr> </table>	Home Use	Selects it for the Home environment.	Store Demo
Home Use	Selects it for the Home environment.			
Store Demo	Selects it for the retail environment.			

LOCK settings

- 1 Press **SETTINGS** and the Navigation buttons to scroll to **LOCK**.
- 2 Press the Navigation buttons to scroll to the setting or option you want and press **OK**.
- 3 When you return to the previous menu, press **BACK**.

* Image shown may differ from your TV.

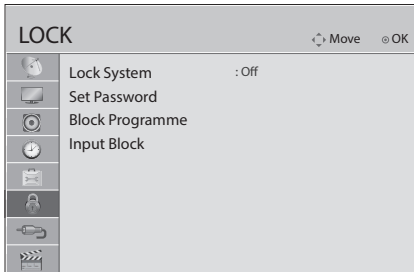

The available lock settings are described in the following.

Setting	Description
Lock System	Activates or deactivates the lock system.
Set Password	Changes the 4-digit password. The default PIN is "0 0 0 0".
Block Programme	Blocks the programmes that contain inappropriate contents for children by pressing the Blue button. The Lock icon appears in front of the blocked programmes. The programmes can be selected but the screen blank and the audio is muted.
Input Block	Blocks the input sources.

ENTERTAINMENT settings

- 1 Press **SETTINGS** and the Navigation buttons to scroll to **ENTERTAINMENT**.
- 2 Press the Navigation buttons to scroll to the setting or option you want and press **OK**.
- 3 When you return to the previous menu, press **BACK**.

* Image shown may differ from your TV.

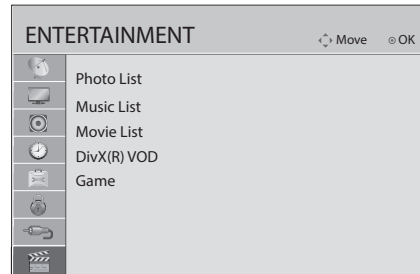

The available entertainment settings are described in the following.

Setting	Description
Photo List	Views image files (photos) on TV which are stored on USB device. (See p. 20)
Music List	Plays back music files on TV which are stored on USB device. (See p. 21)
Movie List	Plays movie files on TV which are stored on usb device. (See p. 22)
DivX(R) VOD	Views the registration code of your TV. (See p. 24)
Game (Depending on model)	Plays game contents on your TV.

Teletext

* This feature is not available in all countries.

Teletext is a free service broadcast by most TV stations which gives up-to-the minute information on news, weather, television programmes, share prices and many other topics.

The teletext decoder of this TV can support the SIMPLE and FASTEXT systems. SIMPLE (standard teletext) consists of a number of pages which are selected by directly entering the corresponding page number. FASTEXT are more modern methods allowing quick and easy selection of teletext information.

Switch On/Off

Press the TEXT button to switch to teletext. The initial page or last page viewed appears on the screen.

Two page numbers, TV station name, date and time are displayed on the screen headline. The first page number indicates your selection, while the second shows the current page displayed.

Press the TEXT button to switch off teletext. The previous mode reappears.

Simple text

Page selection

- 1 Enter the desired page number as a three digit number with the Number buttons. If during selection you press a wrong number, you must complete the three digit number and then re-enter the correct page number.
- 2 The **^P^** button can be used to select the preceding or following page.

Fastext

The teletext pages are colour coded along the bottom of the screen and are selected by pressing the corresponding coloured button.

Page selection

- 1 Press the **INDEX** button to select the index page.
- 2 You can select the pages which are colour coded along the bottom line with corresponding coloured buttons.
- 3 As with SIMPLE teletext mode, you can select a page by entering its three digit page number with the Number buttons in FASTEXT mode.
- 4 The **^P^** button can be used to select the preceding or following page.

Special teletext function

Index

Select the each index page.

Time

When viewing a TV programme, select this menu to display the time at the top right hand corner of the screen.

In the teletext mode, press this button to select a sub page number. The sub page number is displayed at the bottom of the screen. To hold or change the sub page, press the Red/Green, **◀▶** or Number buttons.

Hold

Stops the automatic page change which will occur if a teletext page consists of 2 or more sub pages.

The number of sub pages and the sub page displayed is, usually, shown on the screen below the time. When this menu is selected the stop symbol is displayed at the top left-hand corner of the screen and the automatic page change is inactive.

Reveal

Select this menu to display concealed information, such as solutions to riddles or puzzles.

Update

Displays the TV picture on the screen while waiting for a new teletext page. The display will appear at the top left hand corner of the screen. When the updated page is available then display will change to the page number. Select this menu again to view the updated teletext page.

Troubleshooting

Cannot control the TV with the remote control.

- Check the remote control sensor on the product and try again.
- Check if there is any obstacle between the product and the remote control.
- Check if the batteries are still working and properly installed (⊕ to ⊕, ⊖ to ⊖).

No image display and no sound is produced.

- Check if the product is turned on.
- Check if the power cord is connected to a wall outlet.
- Check if there is a problem in the wall outlet by connecting other products.

The TV turns off suddenly.

- Check the power control settings. The power supply may be interrupted.
- Check if the **Automatic Standby** (Depending on model) / **Sleep Timer / Off Time** is activated in the **TIME** settings.
- If there is no signal while the TV is on, the TV will turn off automatically after 15 minutes of inactivity.

When connecting to the PC (HDMI), 'No signal' or 'Invalid Format' is displayed.

- Turn the TV off/on using the remote control.
- Reconnect the HDMI cable.
- Restart the PC with the TV on.

Specifications

Environment condition	Operating Temperature	0 °C to 40 °C
	Operating Humidity	Less than 80 %
	Storage Temperature	-20 °C to 60 °C
	Storage Humidity	Less than 85 %

	Analogue TV (Depending on Country)
Television system	PAL/SECAM-B/G/D/K, PAL-I, NTSC-M, PAL B/B
Programme coverage	VHF, UHF, CATV
Maximum number of storable programmes	200
External antenna impedance	75 Ω

HDMI-DTV supported mode

Resolution	Horizontal Frequency (kHz)	Vertical Frequency (Hz)
720 x 480	31.469	59.94
	31.5	60.00
720 x 576	31.25	50.00
1280 x 720	44.96	59.94
	45	60.00
	37.5	50.00
1920 x 1080	28.125	50.00
	33.72	59.94
	33.75	60.00
	56.25	50.00
	67.43	59.94
	67.5	60.00
	27	24.00
	33.75	30.00
	26.97	23.97
	33.716	29.976

Component port connecting information

Component ports on the TV	Y	P _B	P _R
Video output ports on DVD player	Y	P _B	P _R
	Y	B-Y	R-Y
	Y	Cb	Cr
	Y	Pb	Pr

Signal	Component
480i / 576i	○
480p / 576p	○
720p / 1080i	○
1080p	○ (Only 50 Hz / 60 Hz)

AC/DC Adapter

32LF510*, 32LF513*
Manufacturer : Honor Model : ADS-45EI-19 19040GPI, ADS-45FSN-19 19040GPG, ADS-45FSN-19 19040GPCU, ADS-40LSI-19-2 19040G, ADS-45SN-19-2 19040G Manufacturer : APD Model : WA-40D19FI Manufacturer : Lien Chang Model : LCAP16B-E, LCAP16B-A, LCAP25B
Input : AC 100-240 V~ 50/60 Hz Output : 19 V --- 2.1 A
43/49LF510*, 43/49LF513*
Manufacturer : Lien Chang Model : LCAP40 Manufacturer : APD Model : DA-65F19
Input : AC 100-240 V~ 50/60 Hz Output : 19 V --- 3.42 A

(Only Jordan)

WEEE

ENGLISH



Disposal of your appliance

The symbol indicating separate collection for electrical and electronic equipment consists of the crossed-out wheeled bin.







Record the model number and serial number of the TV.

Refer to the label on the back cover and quote this information to your dealer when requiring any service.

MODEL _____

SERIAL _____

For any Suggestion, Opinion,
Complaints, Please Call

800 54 in UAE

0800 545454 in South Africa

080 100 54 54 in Morocco

19960 in Egypt

021 36 54 54 in Algeria

Other countries, Please contact our
local dealer or log into

<http://www.lg.com>