

Always there to help you

Register your product and get support at
www.philips.com/welcome



AZ105



User Manual

PHILIPS

Contents

1	Important	3
	Mains fuse	3

2	Your CD Soundmachine	4
	Introduction	4
	What's in the box	4
	Overview of the main unit	5

3	Get started	6
	Connect power	6
	Turn on	7

4	Play	8
	Play disc	8
	Listen to FM radio	8
	Play from an external device	8

5	Product information	9
	Specifications	9
	Maintenance	9

6	Troubleshooting	10
----------	------------------------	-----------

7	Notice	10
----------	---------------	-----------

1 Important

- Read these instructions.
- Follow all instructions.
- Do not block any ventilation openings. Install in accordance with the manufacturer's instructions.
- Do not install near any heat sources such as radiators, heat registers, stoves, or other apparatus (including amplifiers) that produce heat.
- Protect the power cord from being walked on or pinched, particularly at plugs, convenience receptacles, and the point where they exit from the unit.
- Only use attachments/accessories specified by the manufacturer.
- Unplug this unit during lightning storms or when unused for long periods of time.
- Refer all servicing to qualified service personnel. Servicing is required when the unit has been damaged in any way, such as power-supply cord or plug is damaged, liquid has been spilled or objects have fallen into the apparatus, the unit has been exposed to rain or moisture, does not operate normally, or has been dropped.
- Battery usage CAUTION – To prevent battery leakage which may result in bodily injury, property damage, or damage to the unit:
 - Install all batteries correctly, + and - as marked on the unit.
 - Do not mix batteries (old and new or carbon and alkaline, etc.).
 - Remove batteries when the unit is not used for a long time.
- Batteries (battery pack or batteries installed) shall not be exposed to excessive heat such as sunshine, fire or the like.
- The unit shall not be exposed to dripping or splashing.
- Do not place any sources of danger on the unit (e.g. liquid filled objects, lighted candles).

- Where the MAINS plug or an appliance coupler is used as the disconnect device, the disconnect device shall remain readily operable.



Warning

- Never remove the casing of this apparatus.
- Never place this apparatus on other electrical equipment.
- Never look into the laser beam inside this apparatus.

Mains fuse

This information applies only to products with a UK mains plug.

This product is fitted with an approved molded plug. If you replace the fuse, use one with:

- the ratings shown on the plug,
- a BS 1362 approval, and
- the ASTA approval mark.

Contact your dealer if you are not sure about what type of fuse to use.

Caution: To conform with the EMC directive (2004/108/EC), do not detach the plug from the power cord.



Caution

- Use of controls or adjustments or performance of procedures other than herein may result in hazardous radiation exposure or other unsafe operation.

2 Your CD Soundmachine

Introduction

With this CD Soundmachine, you can:

- listen to FM radio;
- enjoy audio from discs, and other external audio devices;
- program the play sequence of tracks.

The unit offers you Dynamic Bass Boost (DBB) to enrich sound.

What's in the box

Check and identify the contents of the package:

- Main unit
- AC power cord
- Quick start guide

Overview of the main unit

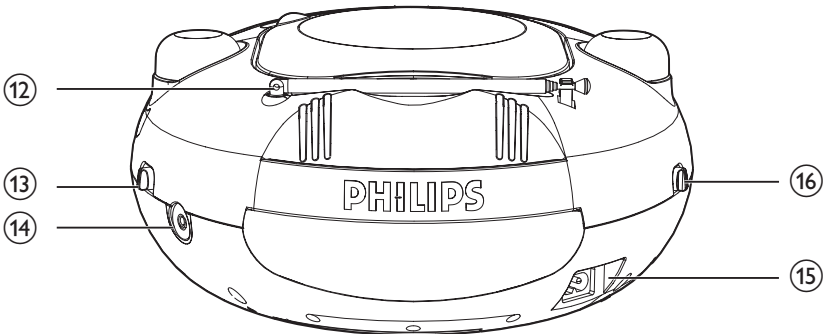
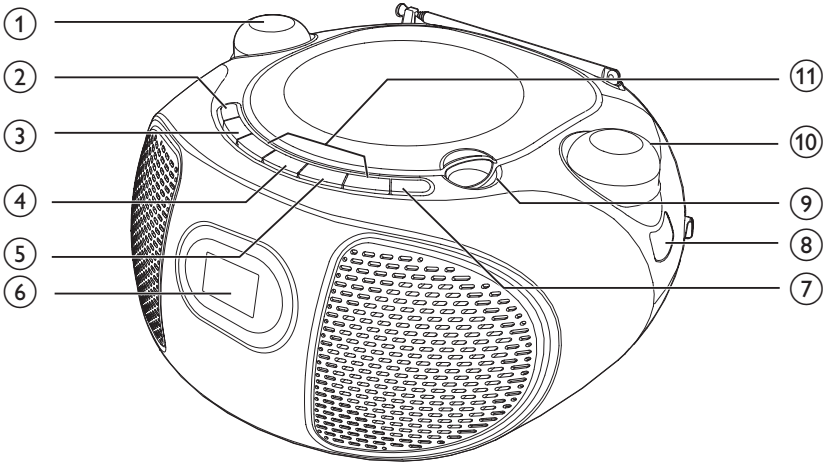

- ① **- VOLUME +**
 - Adjust volume.
- ② **SHUFFLE**
 - In CD mode, play tracks randomly.
- ③ **REPEAT**
 - In CD mode, play a track or all tracks repeatedly.
- ④ **▶||**
 - Start or pause play.
- ⑤ **■**
 - Stop play.
 - Erase a program.
- ⑥ **Display panel**
- ⑦ **PROG**
 - In CD mode, program the play sequence of tracks.
- ⑧ **FM frequency indicator**
- ⑨ **LIFT TO OPEN**
 - Open or close the disc compartment.
- ⑩ **- TUNING +**
 - Tune to FM radio stations.
- ⑪ **◀◀ / ▶▶**
 - Skip to the previous or next track.
 - Search within a track.

- ⑫ **FM antenna**
 - Improve FM reception.
- ⑬ **Source selector**
 - Select a source: **FM**, **Audio-in**, or **CD**.
 - Turn the unit off.
- ⑭ **Audio-in**
 - Connect an external audio device.
- ⑮ **AC~ MAINS**
 - Connect power.
- ⑯ **DBBswitch**
 - **ON/OFF**: turn dynamic bass boost on or off.

3 Get started

Caution

- Use of controls or adjustments or performance of procedures other than herein may result in hazardous radiation exposure or other unsafe operation.

Always follow the instructions in this chapter in sequence.

If you contact Philips, you will be asked for the model and serial number of this apparatus. The model number and serial number are on the bottom of the apparatus. Write the numbers here:

Model No. _____

Serial No. _____

Connect power

The unit can be powered by either AC power or batteries.

Option 1: AC power

Warning

- Risk of product damage! Make sure that the power supply voltage corresponds to the voltage printed on the back or the underside of the unit.
- Risk of electric shock! When you disconnect the AC power, always pull the plug from the socket. Never pull the cord.

Connect the AC power cord to:

- the **AC~ MAINS** socket on the unit.
- the wall socket.

Note

- To switch the unit off completely, disconnect the power cord from the power supply socket.

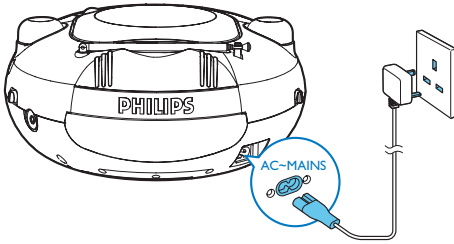

Turn on

Switch the source selector to **FM, Audio-in, or CD**.

Turn off

Switch the source selector to **OFF**.

Option 2: Battery power



Caution

- Risk of explosion! Keep batteries away from heat, sunshine or fire. Never discard batteries in fire.
- Batteries contain chemical substances, so they should be disposed of properly.



Note

- Batteries are not supplied with the accessories.

- 1 Open the battery compartment.
- 2 Insert 6 batteries (type: R14/ UM2/ C CELL) with correct polarity (+/-) as indicated.
- 3 Close the battery compartment.

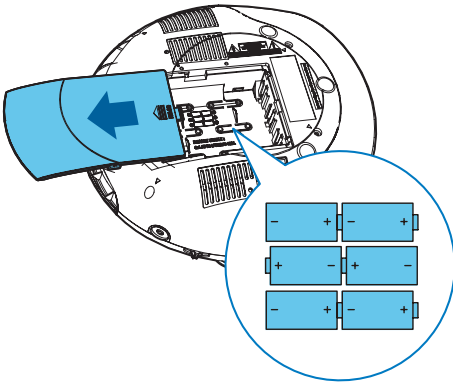







4 Play

Play disc

- 1 Switch the source selector to **CD**.
- 2 Lift to open the disc compartment.
- 3 Insert a disc with the printed side facing up, then close the disc compartment.
↳ Play starts automatically.

Control play

	Select an audio file; Press and hold to fast-forward or fast-reverse the track during playback, then release to resume play.
	Pause or resume play.
	Stop play.
REPEAT	[]: Play the current track repeatedly. []: Play all tracks repeatedly.
SHUFFLE	[]: Play tracks randomly.
-VOLUME +	Adjust volume.



Enhance bass

To turn dynamic bass boost on or off, slide **DBB** switch to **ON** or **OFF**.

Program tracks

You can program a maximum of 20 tracks.

- 1 Press  to stop playback.
- 2 Press **PROG** to activate the program mode.
↳ [**PROG**] (program) begin to blink.
- 3 Press  to select a track number, and then press **PROG** to confirm.

- 4 Repeat steps 3 to program more tracks.
- 5 Press  to play the programmed tracks.
↳ During play, [**PROG**] (program) and the preset number are displayed.
 - To erase the program, press  twice.

Listen to FM radio

Note

- Position the antenna as far as possible from TV,VCR or other radiation source.
- For optimal reception, fully extend and adjust the position of the antenna.

- 1 Switch the source selector to **FM**.
- 2 Rotate **-TUNING +** to tune to an FM radio station.

Play from an external device

You can also listen to an external audio device through this unit.

- 1 Switch the source selector to **Audio-in**.
- 2 Connect an audio cable (3.5mm, not supplied) to:
 - the **Audio-in** socket on the unit.
 - the headphone socket on an external device.
- 3 Play the external device (see the device's user manual).

Note

- The **Audio-in** socket is not for headphones.

5 Product information

Note

- Product information is subject to change without prior notice.

Specifications

Amplifier

Rated Output Power	2 x 1 W RMS
Frequency Response	63 -14000 Hz, -3 dB
Signal to Noise Ratio	>57 dBA
Total Harmonic Distortion	<1 %
Audio-in Input	650 mV RMS

Disc

Laser Type	Semiconductor
Disc Diameter	12cm/8cm
Support Disc	CD-DA, CD-R, CD-RW
Total Harmonic Distortion	<1%
Frequency Response	63 -14000 Hz, -3 dB
Signal to Noise Ratio	>57 dBA

Tuner

Tuning Range	FM: 87.5 - 108MHz
Total Harmonic Distortion	<3 %
Signal to Noise Ratio	>50 dBA

General

Power supply	
- AC Power	220 - 240V, 50/60 Hz
- Battery	9V, 6 x 1.5 V R14/UM2
Operation Power Consumption	15 W
Standby Power Consumption	< 0.5 W
Dimensions - Main Unit (W x H x D)	261 x 123 x 245 mm
Weight - Main Unit	1.1 kg

Maintenance

Clean the cabinet

- Use a soft cloth slightly moistened with a mild detergent solution. Do not use a solution containing alcohol, spirits, ammonia or abrasives.

Clean discs

- When a disc becomes dirty, clean it with a cleaning cloth. Wipe the disc from the centre out.



- Do not use solvents such as benzene, thinner, commercially available cleaners, or antistatic spray intended for analogue records.

Clean the disc lens

- After prolonged use, dirt or dust may accumulate at the disc lens. To ensure good play quality, clean the disc lens with Philips CD lens cleaner or any commercially available cleaner. Follow the instructions supplied with cleaner.

6 Troubleshooting

Warning

- Never remove the casing of this device.

To keep the warranty valid, never try to repair the system yourself.

If you encounter problems when using this device, check the following points before requesting service. If the problem remains unsolved, go to the Philips Web page (www.philips.com/support). When you contact Philips, make sure that the device is nearby and the model number and serial number are available.

No power

- Ensure that the AC power plug of the unit is connected properly.
- Ensure that there is power at the AC outlet.
- Insert the batteries with their polarities (+/- signs) aligned as indicated.
- Replace the battery.

No sound

- Adjust the volume.

No response from the unit

- Take out the batteries and turn on the unit again.
- Disconnect and reconnect the AC power plug, then turn on the unit again.

No disc detected

- Insert a disc.
- Check if the disc is inserted upside down.
- Wait until the moisture condensation at the lens has cleared.
- Replace or clean the disc.
- Use a finalized CD or correct format disc.

Poor radio reception

- Increase the distance between the unit and your TV or VCR.
- Fully extend the FM antenna.

7 Notice



This product complies with the radio interference requirements of the European Community.

Any changes or modifications made to this device that are not expressly approved by Philips Consumer Lifestyle may void the user's authority to operate the equipment.



Your product is designed and manufactured with high quality materials and components, which can be recycled and reused.



When this crossed-out wheeled bin symbol is attached to a product it means that the product is covered by the European Directive 2002/96/EC.

Please inform yourself about the local separate collection system for electrical and electronic products.

Please act according to your local rules and do not dispose of your old products with your normal household waste. Correct disposal of your old product helps to prevent potential negative consequences for the environment and human health.



Your product contains batteries covered by the European Directive 2006/66/EC, which cannot be disposed with normal household waste. Please inform yourself about the local rules on separate collection of batteries

because correct disposal helps to prevent negative consequences for the environmental and human health.

Environmental information

All unnecessary packaging has been omitted. We have tried to make the packaging easy to separate into three materials: cardboard (box), paper pulp (buffer) and polyethylene (bags, protective foam sheet.)

Your system consists of materials which can be recycled and reused if disassembled by a specialized company. Please observe the local regulations regarding the disposal of packaging materials, exhausted batteries and old equipment.

This apparatus includes these labels:



Class II equipment symbol



This symbol indicates that the apparatus has a double insulation system.



Specifications are subject to change without notice
© 2012 Koninklijke Philips Electronics N.V.
All rights reserved.

AZ105_05_UM_V1.0

