

FUJITSU LIFEBOOK U9311



Congratulations on your purchase of an innovative product from Fujitsu.

The latest information about our products, tips, updates etc. can be found on the Internet at: ["http://www.fujitsu.com/fts/"](http://www.fujitsu.com/fts/)

You can find driver updates at: ["http://support.ts.fujitsu.com/download"](http://support.ts.fujitsu.com/download)

Should you have any technical questions, please contact:

- our Hotline/Service Desk (["http://support.ts.fujitsu.com/contact/service desk"](http://support.ts.fujitsu.com/contact/service desk))
- Your sales partner
- Your sales office

We hope you enjoy working with your new Fujitsu system!



Issued by / EU importer

Fujitsu Technology Solutions GmbH

Mies-van-der-Rohe-Straße 8

80807 Munich, Germany

["http://www.fujitsu.com/fts/"](http://www.fujitsu.com/fts/)

Copyright

© Fujitsu Client Computing Limited 2021. All rights reserved.

Publication Date

03/2021

Edition 1

FUJITSU LIFEBOOK U9311

Operating Manual

Innovative technology	7
Ports and controls	9
Important notes	12
First-time setup of your device	16
Working with the notebook	19
Security functions	46
Connecting external devices	53
Removing and installing components during servicing	59
Settings in BIOS Setup Utility	60
Troubleshooting and tips	65
Technical data	73
Manufacturer's notes	75
Index	76

Remarks

Information on the product description meets the design specifications of Fujitsu and is provided for comparison purposes. Several factors may cause the actual results to differ. Technical data is subject to change without prior notification. Fujitsu rejects any responsibility with regard to technical or editorial mistakes or omissions.

Trademarks

Fujitsu, the Fujitsu logo and LIFEBOOK are registered trademarks of Fujitsu Limited or its subsidiaries in the USA and other countries.

Microsoft and Windows are trademarks or registered trademarks of Microsoft Corporation in the USA and/or other countries.



The terms HDMI and HDMI High-Definition Multimedia Interface and the HDMI logo are trademarks or registered trademarks of HDMI Licensing Administrator, Inc. in the United States and other countries.

Bluetooth® and the Bluetooth logo are registered trademarks of Bluetooth SIG, Inc.

Adobe Reader is a trademark of Adobe Systems Incorporated.

USB Type-C™ and USB-C™ are trademarks of the USB Implementers Forum in the USA and other countries.

All other trademarks specified here are the property of their respective owners.

Copyright

No part of this publication may be copied, reproduced or translated without the prior written consent of Fujitsu.

No part of this publication may be saved or transferred by any electronic means without the written approval of Fujitsu.

Contents

Innovative technology	7
Further information	7
Notational conventions	8
Ports and controls	9
Important notes	12
Safety notes	12
Additional safety notes for devices with radio components	13
Energy saving	13
Energy saving under Windows	13
Travelling with your notebook	14
Before you travel	14
Notebook: transporting	14
Cleaning the notebook	15
First-time setup of your device	16
Unpacking and checking the device	16
Selecting a location	17
Mains adapter connecting	17
Switching on the device for the first time	18
Working with the notebook	19
Status indicators	19
Switching on the notebook	21
Notebook: switching off	21
Keyboard	22
Virtual numeric keypad	24
Function keys and key combinations	25
F-Lock setting	27
Keyboard with backlight	27
Country and keyboard settings	27
Touchpad and touchpad buttons	28
Moving the pointer	28
Selecting an item	28
Executing commands	28
Dragging items	29
Touchscreen/LCD screen without touch function (device-dependent)	29
Using fingers	30
WebCam and Infrared Camera	31
Rechargeable battery	32
Charging, caring for and maintaining the battery	32
Switch the battery off and on	32
Using the power-management features	33
Adjusting system performance in Microsoft Windows	33
Adjusting fan control	34
Memory cards	35
Supported formats	35
Inserting the memory card	35
Removing the memory card	35
Loudspeakers and microphones	36
SIM card (configuration dependent)	37

Inserting the SIM card	37
Removing a SIM card	38
Wireless components: wireless LAN / Bluetooth / LTE / 5G (optional)	39
Switching the wireless components on and off	39
Setting up WLAN access	39
Access via LTE / 5G (optional)	39
Ethernet and LAN	40
Your USB Thunderbolt™ Port replicator (optional)	41
Ports on the Thunderbolt™ Port Replicator	42
Charge level indicator on the Thunderbolt™ Port Replicator	42
Setting up the port replicator	43
Connecting the power adapter to the Thunderbolt™ Port Replicator	43
Connecting the notebook to the Thunderbolt™ Port Replicator	44
Switching on the notebook via the Thunderbolt™ port replicator	45
Disconnecting the notebook from the Thunderbolt™ Port Replicator	45
Security functions	46
Configuring the fingerprint sensor	46
Configuring the palm vein sensor	47
Using the Security Lock	47
Configuring password protection in BIOS Setup Utility	48
Protecting BIOS Setup Utility (supervisor and user password)	48
Password protection for booting of the operating system	50
Password protection for the hard disk	50
Trusted Platform Module (TPM) (device-dependent)	51
Enabling TPM	51
Disabling TPM	51
SmartCard reader (optional)	52
Inserting the SmartCard	52
Connecting external devices	53
HDMI port	53
Connecting an external monitor to the port replicator	54
Connecting USB devices	55
USB port Intel® Thunderbolt™ 4 with charging function and display port (USB Type-C)	56
USB port with charging function (Anytime USB charge)	57
How to remove USB devices correctly	57
Headset port	58
Removing and installing components during servicing	59
Settings in BIOS Setup Utility	60
Starting the BIOS Setup Utility	60
Operating the BIOS Setup Utility	61
Exiting BIOS Setup Utility	62
Exit Saving Changes - save changes and exit BIOS Setup Utility	62
Exit Discarding Changes – Discard changes and exit BIOS Setup Utility	62
Load Setup Defaults – Copy Standard Entries	62
Discard Changes – Discard changes without exiting the BIOS Setup Utility	62
Save Changes - save changes without exiting the BIOS Setup Utility	62
Save Changes and Power Off	62
Erase Disk	63
Troubleshooting and tips	65

Help if problems occur	65
Reset by switching off the battery	66
Restore contents of the hard disk from Recovery CD/DVD	66
Restoring the system under Windows 10	67
The notebook's date or time is incorrect	67
When certain characters are entered on the keyboard, only numerals are written	67
The notebook's LCD screen remains blank	67
The LCD screen is difficult to read	67
The external monitor remains blank	68
The external monitor is blank or the image is unstable	68
The notebook cannot be started	69
The notebook stops working	69
The printer does not print	69
The wireless connection to a network does not work	70
SmartCard reader is not recognised.	70
SmartCard PIN forgotten	70
SmartCard lost	70
Error messages on the screen	71
Technical data	73
LIFEBOOK	73
Rechargeable battery	73
Mains adapter (notebook computer)	74
Mains adaptor (Thunderbolt™ port replicator, optional)	74
Manufacturer's notes	75
Disposal and recycling	75
TCO Certified	75
SAR limit value (Specific Absorption Rate)	75
Certification markings	75
Index	76

Innovative technology

... and ergonomic design make your device a reliable and convenient companion.

The device boots very quickly, is ready for immediate use and offers a particularly long operating time because of its high capacity battery.

With the user-friendly "BIOS Setup Utility" you can control your notebook's hardware and better protect your system against unauthorised access by using the powerful password properties.



Information on the connections and user components of your notebook can be found in ["Ports and controls", Page 9.](#)

Further information







The Windows drivers for your device can be found on our Internet site. The factory installation of your device does not support any other operating system. Fujitsu Technology Solutions accepts no liability whatsoever if any other operating system is used.

Software oriented components of these instructions refer to Microsoft products, if they come within the scope of the delivery.

If you install other software products, pay attention to the operating instructions of the manufacturer.

Notational conventions

	<p>Pay particular attention to text marked with this symbol. Failure to observe these warnings could pose a risk to health, damage the device or lead to loss of data. The warranty will be invalidated if the device becomes defective through failure to observe these warnings.</p>
	<p>Indicates important information for the proper use of the device.</p>
	<p>Indicates an activity that must be performed</p>
	<p>Indicates a result</p>
<p>This font</p>	<p>indicates data entered using the keyboard in a program dialogue or at the command line, e.g. your password (Name123) or a command used to start a program (start.exe)</p>
<p>This font</p>	<p>indicates information that is displayed on the screen by a program, e.g.: Installation is complete.</p>
<p><i>This font</i></p>	<p>indicates</p> <ul style="list-style-type: none"> • terms and texts used in a software interface, e.g.: Click on <i>Save</i> • names of programs or files, e.g. <i>Windows</i> or <i>setup.exe</i>.
<p>"This font"</p>	<p>indicates</p> <ul style="list-style-type: none"> • cross-references to another section, e.g. "Safety information" • cross-references to an external source, e.g. a web address: For more information, go to "http://www.fujitsu.com/fts/" • Names of CDs, DVDs and titles or designations for other materials, e.g.: "CD/DVD Drivers & Utilities" or "Safety/Regulations" manual
<p>Key</p>	<p>indicates a key on the keyboard, e.g: F10</p>
<p>This font</p>	<p>indicates terms and texts that are emphasised or highlighted, e.g.: Do not switch off the device</p>

Ports and controls

This chapter presents the individual hardware components of your device. It gives an overview of the indicators and ports of the device. Please familiarise yourself with these components before you start to work with the device.

Front

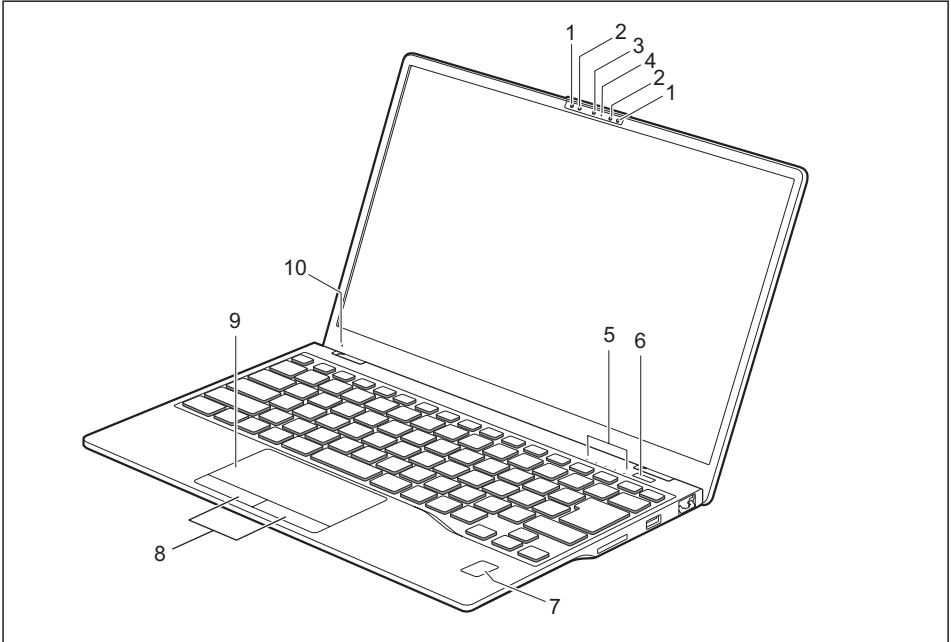

- 1 = Infrared camera sensors (optional)
- 2 = Microphone (optional)
- 3 = WebCam (optional) with webcam shutter
- 4 = WebCam LED (optional)
- 5 = Status indicators
- 6 = ON/OFF button

- 7 = Fingerprint sensor (optional) or palm sensor (optional)
- 8 = Touchpad buttons
- 9 = Touchpad
- 10 = Ambient light sensor (optional)

Left side

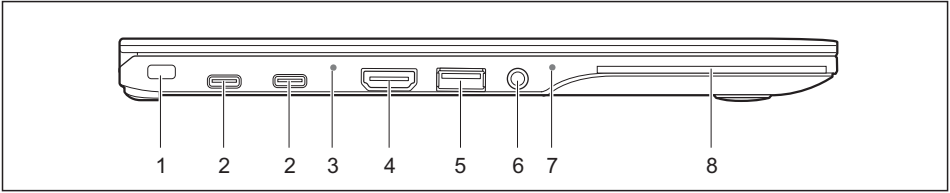

- | | |
|--|---|
| 1 = Security lock device | 5 = USB 3.2 Gen1 port with charging function (USB Type-A, Anytime USB charge) |
| 2 = USB ports Intel® Thunderbolt™ 4 with charging function and display port (USB Type-C) | 6 = Headset jack |
| 3 = Battery status indicator/mains connection | 7 = Power-on indicator / Standby |
| 4 = HDMI port | 8 = SmartCard reader (optional) |

Right side

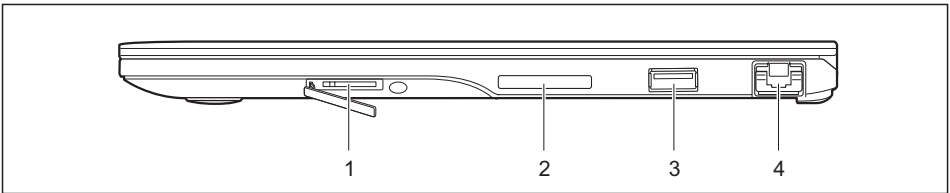

- | | |
|-----------------------------------|------------------------------------|
| 1 = Slot for SIM cards (optional) | 3 = USB port 3.2 Gen1 (USB Type-A) |
| 2 = Slot for memory cards | 4 = LAN port |

Bottom

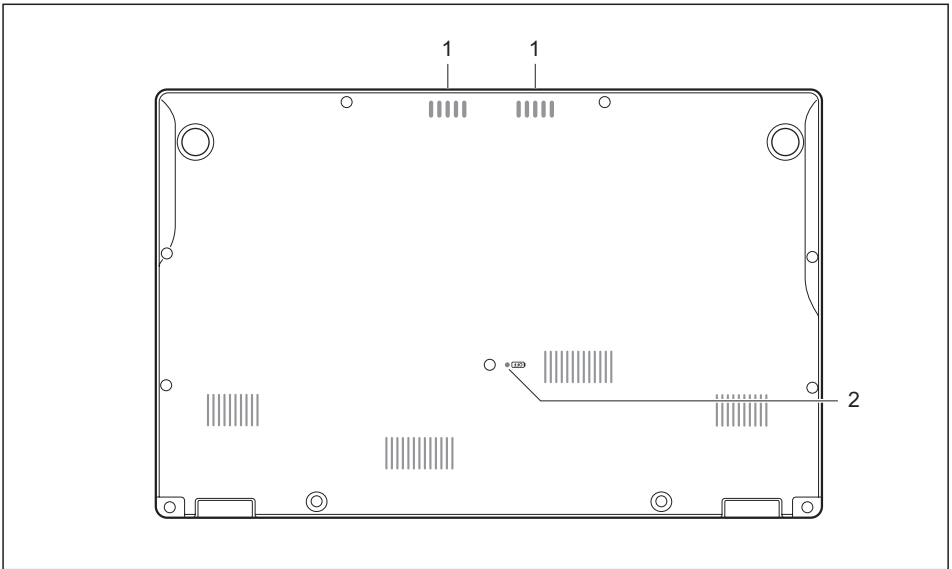

1 = Loudspeaker

2 = Off button for the battery (recessed)

Important notes



This chapter contains essential safety information which must be followed when working with your notebook. Other notes also provide useful information which will help you with your notebook.

Safety notes



Please follow the safety notes provided in the "Safety/Regulations" manual as well as the safety notes given below.

Please pay special attention to the sections in the manual marked with the symbol on the left.

When connecting and disconnecting cables, observe the relevant notes in this operating manual.

In order to prevent burn injury or the device from overheating, do not lay the device directly on your lap and make sure that the ventilation openings are not obstructed.

Read the information on the ambient conditions in the "[Technical data](#)", [Page 73](#) and "[First-time setup of your device](#)", [Page 16](#) before preparing your notebook for use and switching it on for the first time.

When cleaning the device, please observe the relevant notes in the section "[Cleaning the notebook](#)", [Page 15](#).

Pay attention to the additional safety notes for devices with wireless components provided in the "Safety/Regulations" manual.

Please refer to the notes in the chapter "[Removing and installing components during servicing](#)", [Page 59](#).

This notebook complies with the relevant safety regulations for data processing equipment. If you have questions about using your notebook in a particular area, please contact your sales outlet or our Hotline/Service Desk.

Opening angle of the LCD screen

Please open the LCD screen carefully until you feel resistance. Do not try to open it further with force!

Additional safety notes for devices with radio components

If a radio component (Wireless LAN, Bluetooth, LTE) is integrated in your notebook, you must be sure to observe the following safety notes when using your notebook:

- Switch off the radio components when you are in an aircraft or driving in a car.
- Switch off the radio components when you are in a hospital, an operating room or near a medical electronics system. The transmitted radio waves can impair the operation of medical devices.
- Switch off the radio components when you let the device get near flammable gases or into hazardous environments (e.g. petrol station, paintshops), as the transmitted radio waves can cause an explosion or a fire.



For information on how to switch radio components on and off, see chapter ["Switching the wireless components on and off", Page 39](#).

Energy saving

Switch the notebook off when it is not in use. Switch off external, connected devices if you are not using them. If you use the energy saving functions, the notebook uses less energy. You will then be able to work for longer before having to recharge the battery.



Energy efficiency is increased and the environmental impact is reduced. You save money while protecting the environment.

Energy saving under Windows

- ▶ Make use of the power management features (see ["Using the power-management features", Page 33](#)).

Travelling with your notebook

Please observe the points listed below when travelling with your notebook.

Before you travel

- ▶ Back up important data stored on your hard disk.
- ▶ Switch off the wireless component for data security reasons. With data traffic via a wireless connection, it is also possible for unauthorised third parties to receive data.



Information on activating data encryption is provided in the documentation for your wireless component.

- ▶ If you wish to use your notebook during a flight, first check with the flight attendants if it is OK to do so.

When travelling in other countries

- ▶ If you are travelling abroad, check that the mains adapter can be operated with the local mains voltage. If this is not the case, obtain the appropriate mains adapter for your notebook. Do not use any other voltage converter!
- ▶ Check whether the local mains voltage and the power cable are compatible. If this is not the case, buy a power cable that matches the local conditions.
- ▶ Contact the relevant authorities of the country you will be travelling in as to whether you may operate the radio component integrated into your notebook computer. Please observe the additional safety instructions for devices with radio components, found in the handbook "Safety/formalities".

Notebook: transporting



Protect the notebook from severe shocks and extreme temperatures (e.g. direct sunlight in a car).

- ▶ Switch the notebook off.
- ▶ Unplug the mains adapter and all external devices from the power socket.
- ▶ Disconnect the mains adapter cable and the data cables for all external devices.
- ▶ Close the LCD screen.
- ▶ To protect against damaging jolts and bumps, use a notebook carrying case to transport your notebook.

Cleaning the notebook



Do not clean any interior parts yourself; leave this job to a service technician.

Only use cleaning products designed for computers. Normal household cleaners and polishes can damage the markings on the keyboard and the device, the paintwork or the notebook itself.

Ensure that no liquid enters the notebook.

The LCD screen very sensitive to scratches. Only clean the display surface with a very soft, slightly damp cloth.

- ▶ Switch the notebook off.
- ▶ To prevent accidental activation of the device, remove the power plug of the mains adapter from the power socket.
- ↳ The surface may be cleaned with a dry cloth. If particularly dirty, use a damp cloth that has been dipped in water mixed with mild domestic detergent and then carefully wrung out. To clean the keyboard and the Touchpad, if available, you can use disinfectant wipes. Ensure that no liquid enters the device.

First-time setup of your device



Please read the chapter ["Important notes", Page 12.](#)

If your device is equipped with a Windows operating system, the necessary hardware drivers and supplied software are already pre-installed.

Before you switch on the device for the first time, connect it to the mains voltage using the mains adapter, see ["Mains adapter connecting", Page 17.](#) The mains adapter must be connected during the entire installation process.

A system test is performed when your device is first switched on. Various messages can appear. The display may remain dark for a short time or may flicker.

Please follow the instructions on the screen.

NEVER switch off your device during the first-time setup process.

The battery must be charged if you want to operate your device using the battery.

When used on the move, the built-in battery provides the device with the necessary power. You can increase the operating time by using the available energy-saving functions.

For instructions on how to connect external devices (e.g. mouse, printer) to your device, please refer to the operating manual for your device.

Unpacking and checking the device



Should you discover any damage that occurred during transportation, notify your local sales outlet immediately!

- ▶ Unpack all the individual parts.
- ▶ Check your device for any visible damage which may have occurred during transportation.



You may need the packaging in the future, if you need to transport your device.

Selecting a location



Select a suitable location for the device before setting it up. Follow the instructions below when doing so:

- Never place the device or the mains adapter on a heat-sensitive surface. The surface could be damaged as a result.
- Never place the device on a soft surface (e.g. carpeting, upholstered furniture, bed). This can block the air vents and cause overheating and damage.
- The underside of the device heats up during normal operation. Prolonged contact with the skin may become unpleasant or even result in burns.
- Place the device on a stable, flat, non-slippery surface. Please note that the rubber feet of the device may mark certain types of delicate surfaces.
- Keep other objects at least 100 mm / 3.94 inches away from the device and its mains adapter to ensure adequate ventilation.
- Never cover the ventilation slots of the device.
- Do not expose the device to extreme environmental conditions. Protect the device from dust, humidity, and heat.

Mains adapter connecting



Observe the safety notes in the enclosed "Safety/Regulations" manual.

The supplied power cable conforms to the requirements of the country in which you purchased your device. Make sure that the power cable is approved for use in the country in which you intend to use it.

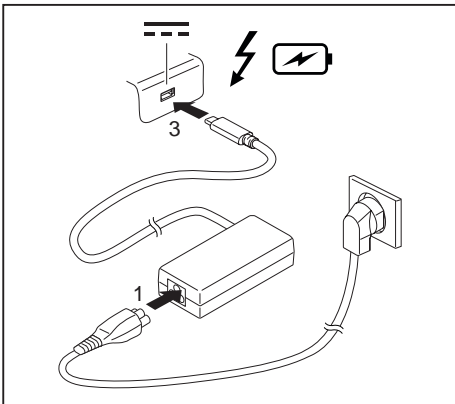

- ▶ Connect the power cable (1) to the power adapter provided for the device, see chapter "[Technical data](#)", Page 73.
- ▶ Plug the mains cable (2) into a mains outlet.
- ▶ Connect the USB Type-C cable (3) of the power adapter to the Intel® Thunderbolt™ 4 USB power port of the device.

Switching on the device for the first time



When you switch on the device for the first time, the supplied software is installed and configured. Because this procedure must not be interrupted, you should set aside enough time for it to be fully completed and connect the device to the mains using the mains adapter.

During the installation process, DO NOT restart the device unless you are requested to do so!

To make it easier to use your device for the first time, the operating system is pre-installed on the hard disk.

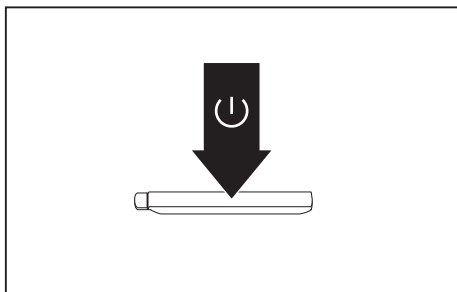

► Switch on your device.

► During installation, follow the instructions on screen.



If a Windows operating system is installed on your device, you will find more information on the system and drivers, help programmes, updates, manuals etc. on the device or on the Internet under "<http://www.fujitsu.com/fts/support>".

You can find information and help on the Windows operating system functions on the Internet at "<http://windows.microsoft.com>".

Working with the notebook

This chapter describes the basics for operating your notebook. Please read the chapter entitled ["Connecting external devices", Page 53](#) for instructions on how to connect devices such as a mouse and a printer to the notebook.









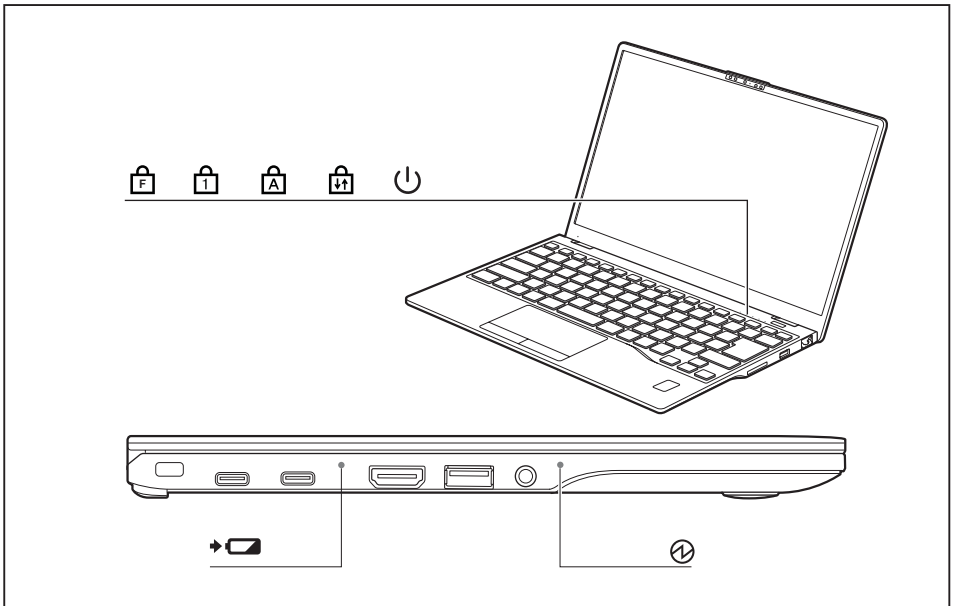



Please refer to the notes in ["Important notes", Page 12](#).

Status indicators

The status indicators provide information about the status of the power supply, the hard disk and the keyboard functions.



Indicator	Description
	<p>Power-on indicator / Standby</p> <ul style="list-style-type: none"> Indicator is illuminated: The notebook is switched on. Indicator flashes: The notebook is in standby mode. Indicator is off: The notebook is switched off.
	<p>Battery status indicator/mains connection The state of charge of the battery is shown by the battery indicator.</p> <ol style="list-style-type: none"> With AC adapter connected: <ul style="list-style-type: none"> The indicator lights up orange: The battery is charging. The indicator is off: Charging is completed. The indicator flashes orange: The battery cannot be charged as the battery is too hot or cold for charging. The charging process is continued as soon as the battery reaches a permissible temperature again. Running on battery (without AC adapter): <ul style="list-style-type: none"> The indicator is off: Battery level is 100-21%. The indicator lights up red: Battery level is 20-0%. Battery abnormality/error: The indicator flashes red.
	<p>F Lock indicator</p> <p>The indicator lights up: The key combination  +  has been pressed. Instead of the imprinted standard functions of the function keys, the Fn functions can be executed by pressing the keys directly (see chapter "Function keys and key combinations", Page 25).</p>
	<p>Num Lock indicator</p> <p>Indicator is illuminated: The  key has been pressed. The virtual numerical keypad is activated. You can output the characters indicated on the upper right of the keys.</p>
	<p>Caps Lock indicator</p> <p>Indicator is illuminated: The Caps Lock key has been pressed. All the characters you type will appear in upper case. In the case of overlay keys, the character printed on the upper left of the key will appear when that key is pressed.</p>
	<p>Scroll Lock indicator</p> <p>Indicator is illuminated: the key combination  +  has been pressed. The effect that this key has varies between applications.</p>

Switching on the notebook

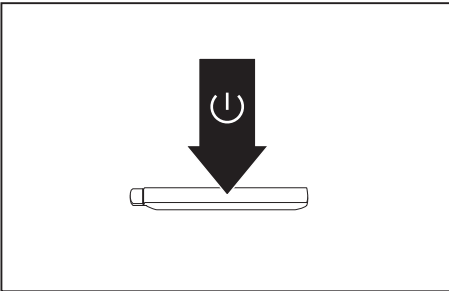

↳ The power-on indicator is lit.

- ▶ Open the LCD screen.
- ▶ Press the ON/OFF button for about 1 second to switch the notebook on.

Notebook: switching off



Back up your data and close all applications before you switch off your device. Otherwise data might be lost.

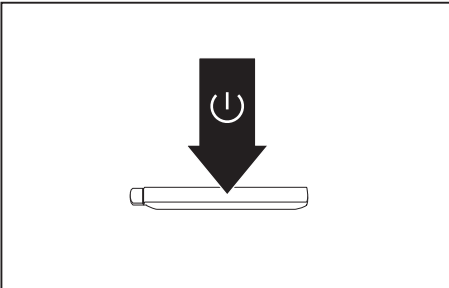

- ▶ Shut down the operating system correctly.
- ▶ If the notebook does not switch itself off automatically, press the ON/OFF button for about 5-10 seconds.
- ▶ Close the LCD screen.

Keyboard



The keyboard of your notebook is subject to continuous wear through normal use. The key markings are especially prone to wear. The key markings are liable to wear away over the life of the notebook.

The keyboard has been designed to provide all the functions of an enhanced keyboard. Some enhanced keyboard functions are mapped with key combinations.







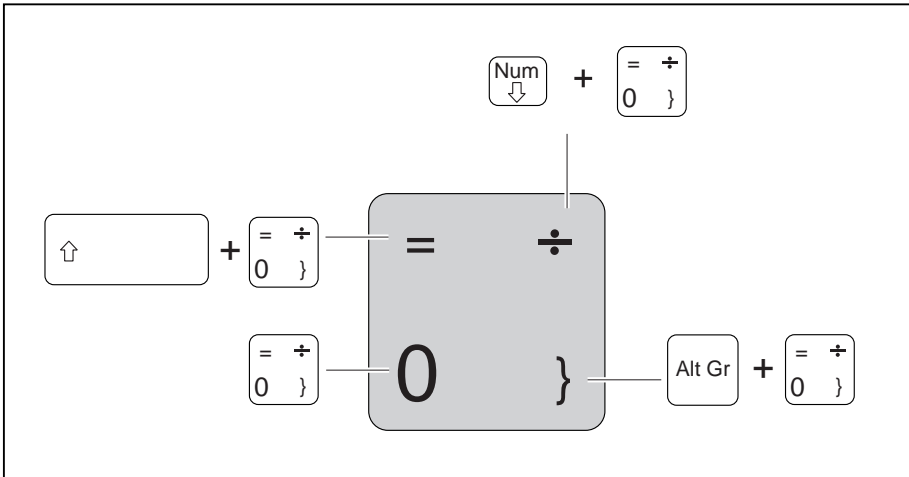

The following description of keys refers to Windows. Additional functions supported by the keys are described in the relevant manuals supplied with your application programs.

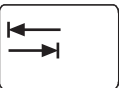
The figure below shows how to access the different characters on keys with overlaid functions. The example applies when the Caps Lock key has not been activated.

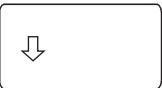

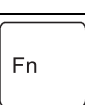
The illustrations shown below may differ from your actual device.

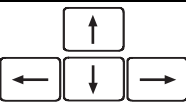

Key	Description
	Backspace key The Backspace key deletes the character to the left of the cursor.
	Tab key The Tab key moves the cursor to the next tab stop.
	Enter key (return) The Enter key terminates a command line. The command you have entered is executed when you press this key.
	Caps Lock key The Caps Lock key activates the Caps Lock mode, and the corresponding icon is displayed in the Windows information area. In Caps Lock mode, all of the characters you type appear in upper case. In the case of overlay keys, the character printed on the upper left of the key will appear when that key is pressed. To cancel the Caps Lock function, simply press the Caps Lock key again.
	Shift key The Shift key causes uppercase characters to appear. In the case of overlay keys, the character printed on the upper left of the key appears when that key is pressed.
	Fn key The  key activates the Fn function of an overlay key (see chapter "Function keys and key combinations", Page 25).
	Cursor keys The cursor keys move the cursor in the direction of the arrow, i.e. up, down, left, or right.
	Windows key The Windows key switches between the start screen and the last used application.
	Menu key The Menu key opens the menu for the active application.

Virtual numeric keypad

To provide the convenience of a numeric keypad, your keyboard is equipped with a virtual numeric keypad. The special keys of the virtual numeric keypad are recognisable by the numbers and symbols printed in the upper right corner of each key. If you have switched on the virtual numeric keypad, you can output the characters shown on the upper right of the keys.



The keyboard layout shown below may differ from your actual device.

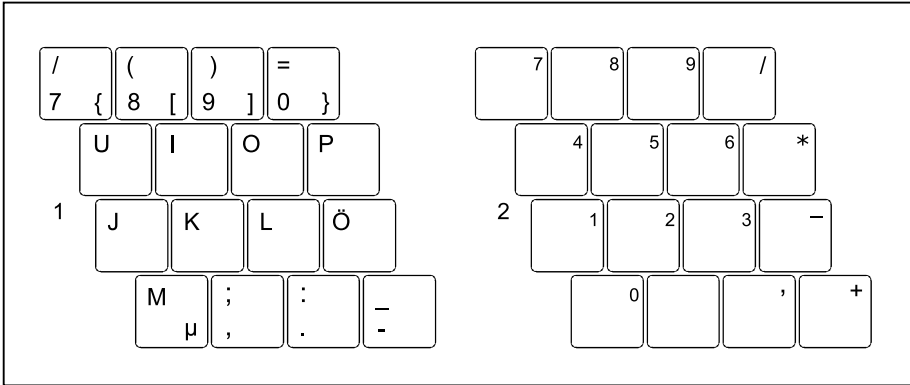

1 = Valid characters when the **Num** key is not activated

2 = Valid characters when the **Num** key is activated

Further information about the status indicators can be found in chapter ["Status indicators", Page 19](#).

Default settings

With default settings, each button must be pressed in combination with **Fn** in order to enter the characters of the virtual numeric keypad.

In the BIOS setup utility, you can enable the function that allows you to enter the characters of the virtual numeric keypad directly without **Fn**.

- ▶ To do so, in the *Advanced-Keyboard Features* menu select *On* or *Off* instead of *On/Padlock Off*.



With Windows, the Num Lock function can still be switched on and off using the *Num* key regardless of whether *On* or **Off** is set in the BIOS.

Function keys and key combinations



The following description of the function keys and key combinations applies to Windows operating systems. Some of the functions described below may not work in other operating systems and with some device drivers.







Other key combinations are described in the relevant manuals supplied with your application programs.

Key combinations are entered as follows:

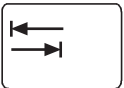
- ▶ Press the first key in the combination and keep it pressed.
- ▶ While holding the first key down, press the other key or keys in the combination.

Function key	Description
F1	Switch microphone on/off This function key switches the microphone off and on.
F2	Switching the loudspeakers on and off This function key switches the speaker of the notebook off and on.
F3	Decrease volume This function key reduces the volume of the built-in loudspeakers.
F4	Increase volume This function key increases the volume of the built-in loudspeakers.
F5	Switching the wireless components on / off This function key switches the wireless components off or on.
F6	Switching the touchpad and touchpad buttons on/off This function key switches the touchpad and the touchpad buttons off or on.
F7	Decrease screen brightness This function key decreases the brightness of the screen.
F8	Increase screen brightness This function key increases the brightness of the screen.
F9	Power management functions Use this function key to activate the energy saving functions (see chapter " Using the power-management features ", Page 33).







Function key	Description
	<p>Toggle output screen If an external monitor is connected, the screen on which the output is to be displayed can be selected with this function key.</p> <p>Screen output is possible:</p> <ul style="list-style-type: none"> only on the notebook's LCD screen on the LCD screen of the notebook and the external monitor at the same time only on the external monitor <p>This setting is useful if you would like a high resolution and a high refresh rate on an external monitor.</p>
	<p>Prt Scrn This function key takes a screenshot of the current screen display and saves it to the clipboard.</p>
	<p>Num Lock This function key activates the virtual number block. The characters found on the upper right of the keys are then output.</p>

Combination	Description
 + 	<p>Switch between open applications Use this key combination to switch between several open applications.</p>
 +  + 	<p>Windows security/Task-Manager This key combination opens the Windows security/Task-Manager window.</p>
 + 	<p>Back tab This key combination moves the cursor back to the previous tab stop.</p>



Key combinations using the Windows keys are detailed in the manual for your operating system.

In addition, the following non-labelled key combinations are supported:

-  +  = Pause
-  +  = Break
-  +  = SysRq

F-Lock setting

The F-Lock setting can be used to set either the hot keys or the function keys as the primary function for the upper row of keys.

The F-Lock function is deactivated by default as delivered.

▶ F-Lock is turned on and off by pressing **[Fn]** + **[Esc]**.

↳ When F-Lock is turned on, it remains activated like the **[Caps Lock]** key.

Changing the F-Lock setting changes the primary and secondary key functions as follows:

Status	Hot Key	Function key
F-Lock is deactivated (F-Lock symbol is not illuminated)	The hot key functions are the primary behaviour: ▶ They are used by simply pressing the corresponding hot key.	The function keys become the secondary behaviour: ▶ They are used by pressing [Fn] + the function key.
F-Lock is activated (F-Lock symbol is illuminated)	The hot key functions are the secondary behaviour: ▶ They are used by pressing [Fn] + the hot key.	The function keys become the primary behaviour: ▶ They are used by simply pressing the corresponding function key.

i

The F-Lock toggle function can be deactivated in the BIOS setup utility.

If the F-Lock toggle function is deactivated, the F-Lock symbol is continuously on and the function keys become the primary function.

▶ To do so, in the *Advanced - Keyboard Features - F-Lock* menu select *disabled* instead of *enabled*.

Keyboard with backlight

i

On this version of the keyboard, repeated pressing of the key combination **[Fn]** + **[space bar]** allows the background lighting to be switched on and off and also a choice to be made between two levels of brightness.

In battery mode, it is recommended to turn on the backlight only when needed and to use the lower brightness level to maximize battery life.

Country and keyboard settings

▶ Change the country and keyboard settings as described in the documentation for your operating system.

Touchpad and touchpad buttons



Keep the touchpad clean. Protect it from dirt, liquids and grease.

Never use the touchpad if your fingers are dirty.

Do not rest heavy objects (e.g. books) on the touchpad or the touchpad buttons.

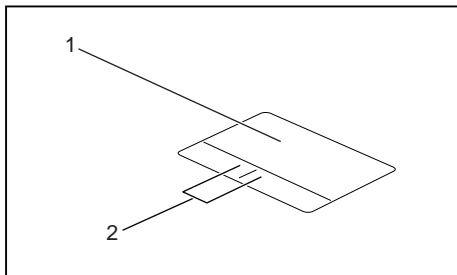

1 = Touchpad

2 = Touchpad buttons

You can move the cursor using the touchpad.

The touchpad buttons allow you to select and execute commands. They correspond to the buttons on a conventional mouse.



You can also deactivate the touchpad with the **F6** key, so that you cannot unintentionally move the pointer on the screen (see chapter ["Function keys and key combinations"](#), Page 25).

Moving the pointer

- ▶ Move your finger on the touchpad.
- ↳ The pointer will move.

Selecting an item

- ▶ Move the pointer to the item you wish to select.
- ▶ Tap the touchpad once or press the left button once.
- ↳ The item is selected.

Executing commands

- ▶ Move the pointer to the field you wish to select.
- ▶ Tap the touchpad twice or press the left button twice.
- ↳ The command is executed.

Dragging items

- ▶ Select the desired item.
- ▶ Press and hold the left button and, with your finger on the touchpad, drag the item to the desired position.
- ↳ The item will be moved.

Touchscreen/LCD screen without touch function (device-dependent)

High-quality LCD screens (TFT) are installed in Fujitsu notebooks. For technical reasons, these screens are manufactured for a certain resolution. An optimum and sharp image can only be ensured with the resolution intended for the particular screen. A screen resolution which differs from the specification can result in an unclear picture.

The resolution of your notebook's screen is optimally set at the factory.

With the present standards of production technology, absolutely flawless screen images cannot be guaranteed. There may be a few constantly light or dark pixels (picture elements) on the screen. The maximum permitted number of such faulty pixels is specified in the international standard ISO 9241-307 (Class II).

Example:

A screen with an HD resolution of 1366 x 768 has $1366 \times 768 = 1049088$ pixels. Each pixel consists of three subpixels (red, green and blue), making a total of about 3 million subpixels. According to ISO 9241-307 (class II), a maximum of 2 light and 2 dark pixels and in addition 5 light or 10 dark subpixels or an equivalent mix (1 light subpixel counts as 2 dark subpixels) are allowed to be defective.

Pixel	A pixel consists of 3 subpixels, normally red, green and blue. A pixel is the smallest element that can be generated by complete functionality of the display.
Subpixel	A subpixel is a separately addressable internal structure within a pixel that enhances the pixel function.
Cluster	A cluster contains two or more defective pixels or subpixels in a 5 x 5 pixel block.

Background lighting

LCD screens are operated with background lighting. The luminosity of the background lighting can decrease during the period of use of the notebook. However, you can set the brightness of your screen individually.

Synchronising the display on the LCD screen and an external monitor

For more information, please refer to the chapter "[Function keys and key combinations](#)", [Page 25](#) under "Display output, switch between".

Using fingers

You can use your finger on the touch screen of your device to execute commands and start applications.

Action	Description
Tapping	<ul style="list-style-type: none">▶ Tap on a symbol, menu, button or folder to select this option or to activate it.
Type, hold, release	<ul style="list-style-type: none">▶ Type and hold a symbol and release it again. The selected action is performed.
Dragging	<ul style="list-style-type: none">▶ Tap and hold a symbol and drag it to another place. You can for instance drag apps or widgets onto the home page in this way.
Double-tap	<ul style="list-style-type: none">▶ To enlarge a view, quickly tap twice on a web page, map or another screen. When you double-tap on an image in a web browser, it will be enlarged and another double-tap will make it smaller again.
Zoom in/Zoom out	<ul style="list-style-type: none">▶ With some apps, you can enlarge the display size by moving two fingers apart on the touchscreen, and reduce it by moving your fingers together.
Input fields	<p>Data must be entered for some apps, for instance an Internet page or your name and password.</p> <ul style="list-style-type: none">▶ Tap on the input field. An on-screen keyboard opens, with which you can enter your data.

WebCam and Infrared Camera



Depending on the device version, your device may have an integral Webcam with microphone.

Depending on the variant, the device contains an infrared camera instead of the webcam, enabling authentication with Microsoft Windows Hello.

Depending on the software used, you can use your Webcam to take pictures, record video clips or take part in web chats.

The WebCam has its own status indicator. The indicator lights up when the WebCam is switched on.

The webcam has a sliding shutter with which the camera can be covered.

- The picture quality depends on the lighting conditions and the software being used.
- You can only operate the webcam with a particular application (e.g. an Internet telephony program or a video conferencing program which supports a webcam).
- When using the webcam the notebook support must not wobble.
- The webcam automatically adjusts itself to the current light level. For this reason the LCD screen may flicker while the light level is adjusted.



Further information on using the webcam and on the additional settings which are possible for your webcam can be found in the help function of the program which uses the webcam.

Rechargeable battery

When not plugged into a mains socket, the notebook runs on its built-in battery. You can increase the life of the battery by caring for the battery properly. The average battery life is around 500 charge/discharge cycles.

You can extend the battery life by taking advantage of the available energy saving functions.

Charging, caring for and maintaining the battery

The notebook's rechargeable battery can only be charged when the ambient temperature is between 5 °C / 41 °F and max. 35 °C / 95 °F.

You can charge the battery by connecting the notebook to the mains adapter (see "[Mains adapter connecting](#)", [Page 17](#)).

Please note that the rechargeable battery will not be charged if its state of charge is between 90 % and 100 %. If the state of charge of the rechargeable battery is less than 90 % and the mains adapter is connected, the battery will be charged to 100 %.

When the battery state of charge is low, a message from the operating system appears. If you do not connect the mains adapter within about 5 minutes of the message appearing, your notebook will automatically switch off.

monitoring the battery charging level

Windows also has a "Battery status meter" in the taskbar for monitoring the battery capacity. When you place the mouse pointer on the battery symbol, the system displays the battery status.

Switch the battery off and on

Switch off the battery



You need the mains adapter to switch the battery on.

- ▶ Disconnect the device from the mains adapter and if applicable, from the Port Replicator as well.
 - ▶ Use a pencil or a wire (e.g. a paperclip) to press firmly into the opening of the off button for the battery, this will switch off the system.
- ↳ The device is currentless.

Switch on the battery

- ▶ Connect the device to the mains adapter of the notebook or to the Port Replicator.
- ▶ Switch the device on again.

Using the power-management features

The notebook uses less power when the available power-management features are used. You will then be able to work longer when using the battery before having to recharge it.



Power efficiency is increased and environmental pollution reduced. By choosing the best power options, you can make significant savings and at the same time help protect the environment.

When you close the LCD screen, depending on the setting in Windows, the notebook automatically enters a power saving mode.

- ▶ Select the power management functions in your Control Panel.



If you need further information about an option, you can get help about most settings by pressing the key combination **[Fn] + [F1]** to show the Microsoft help.

When the notebook is in power-saving mode, the following must be remembered:



During power saving mode, open files are held in the main memory or in a swap file on the hard disk.

Never turn off your notebook while it is in a power saving mode. If the built-in battery is nearly empty, close the open files and do not go into power saving mode.

If you do not intend to use your notebook for a long period of time:

- ▶ Exit power saving mode if necessary via the mouse or keyboard or by switching on the notebook.
- ▶ Close all opened programs and completely shut down the notebook.

Adjusting system performance in Microsoft Windows

Your system is supplied with an optimally adjusted balance between system performance, fan noise and battery life. If required, you can change the system performance in mains operation or in battery operation separately by selecting the battery icon in the *Windows taskbar* with the *Windows Performance Power Slider*.

- Maximum system performance increases fan noise and reduces battery life.
- Maximum battery life limits system performance.

Adjusting fan control

You can adjust the fan control in the BIOS Setup Utility. The following settings are available:

- Normal: The system is cooled to ensure that the maximum system performance is always available and to keep the housing temperature as low as possible.
- Silent: The fan rotation speed, and therefore the noise created by the fan, is reduced.
- ▶ Call up the *BIOS Setup Utility*.
- ▶ In the menu *Advanced - Miscellaneous Configurations* select the *Fan Control* function.
- ▶ Choose the setting *Normal* or *Silent*.



Instructions for how to call up and operate the *BIOS-Setup-Utility* can be found in chapter ["Settings in BIOS Setup Utility", Page 60](#).



With the Fujitsu Utility *Function Manager* you can also switch between these two settings with Windows. In the *Function Manager*, select the *Fan* menu item with the options *Quiet Mode* (corresponds to *Silent*) and *Normal Mode*.

Memory cards

Your notebook is equipped with an integrated memory card reader.



Observe the manufacturer's instructions when handling the memory cards.

Supported formats

Your notebook supports the following format:

- Secure Digital (SD™ card)

Inserting the memory card

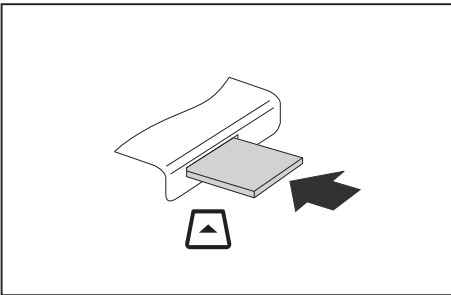

- ▶ Carefully push the memory card into the slot until you feel it click into place. The label area must be facing upward. Do not apply any force, otherwise the delicate contact surfaces could be damaged.
- ↳ Depending on the particular type used, the memory card may protrude slightly from the slot.

Removing the memory card



In order to protect your data, always follow the correct procedure for removing the card (see the documentation for your operating system).

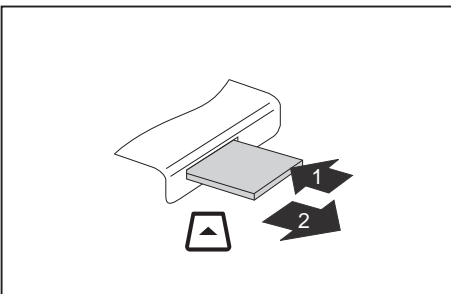

- ▶ Press on the memory card (1).
- ↳ The memory card is released and can now be removed.
- ▶ Pull the memory card out of the slot (2).

Loudspeakers and microphones

You will find information about the exact position of loudspeakers and microphones in chapter ["Ports and controls", Page 9](#).

Please refer to chapter ["Function keys and key combinations", Page 25](#) for information on setting the volume and also enabling/disabling the loudspeakers using key combinations.



When you connect headphones or external speakers, the built-in speakers are disabled.

Information on connecting headphones and a microphone can be found in ["Connecting external devices", Page 53](#).

SIM card (configuration dependent)



Your device supports cards in Nano-SIM format.

A SIM Card (Subscriber Identity Module) is a chip card which is inserted in a mobile telephone or notebook and, together with an integrated LTE module, enables access to a mobile radio network.



Follow the instructions supplied by the provider of the SIM card.

Inserting the SIM card

- ▶ Switch off the battery so that the device is currentless (see ["Switch the battery off and on", Page 32](#))

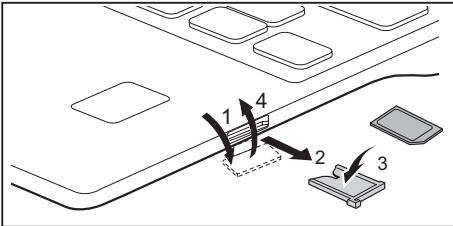

- ▶ Open the cover of the SIM card slot (1) and pull the SIM card holder out (2).
- ▶ Place the SIM card in the carrier (3) and slide the SIM card fully home into the slot as shown.
- ↳ The contacts point upwards. The SIM card does not latch into place.
- ▶ Close the cover of the SIM card slot (4).

- ▶ Switch the battery on again (see ["Switch the battery off and on", Page 32](#))

Removing a SIM card

- ▶ Switch off the battery so that the device is currentless (see chapter ["Switch the battery off and on", Page 32](#))

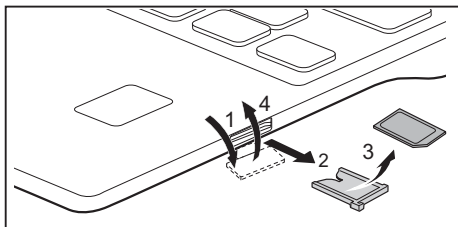

- ▶ Open the cover of the SIM card slot (1).
- ▶ Pull the SIM card holder (2) out of the slot in the direction of the arrow and remove the SIM card (3).
- ▶ Push the SIM card holder into the SIM card slot and close the cover of the SIM card slot (4).

- ▶ Switch the battery on again (see chapter ["Switch the battery off and on", Page 32](#))

Wireless components: wireless LAN / Bluetooth / LTE / 5G (optional)



The installation of radio components not approved by Fujitsu will invalidate the certifications issued for this device.

Switching the wireless components on and off

- ▶ Press the key with the radio symbol () to switch the wireless components on and off (flight mode).



If you switch off the radio components, the wireless LAN antenna and the Bluetooth and LTE module will also be switched off.

Pay attention to the additional safety notes for devices with wireless components provided in the "Safety/Regulations" manual.

You can obtain more information on LTE from your service provider.

Setting up WLAN access

- Requirement: A WLAN must be available and you must have the corresponding access information.



Information on configuring the WLAN access can be found in the documentation for your operating system.

Access via LTE / 5G (optional)



You can purchase the accessories for LTE reception from your retailer or your Fujitsu Technology Solutions dealer.

If you have ordered an LTE or 5G module, your device is already pre-set on delivery.

For information about connecting with the LTE or 5G network, please see the documentation for the hardware that you will be using.

Your device can connect with the Internet via the LTE module. To do this, use one of the following types of connection:

- USB dongle
 - a USB stick with your mobile phone provider's SIM card
- a mobile end-device (e.g. mobile phone) with Bluetooth connection
- a mobile end-device (e.g. mobile phone) with data cable

Ethernet and LAN

The internal network module of your notebook supports Ethernet LAN. You can use it to establish a connection to a local network (LAN = Local Area Network).

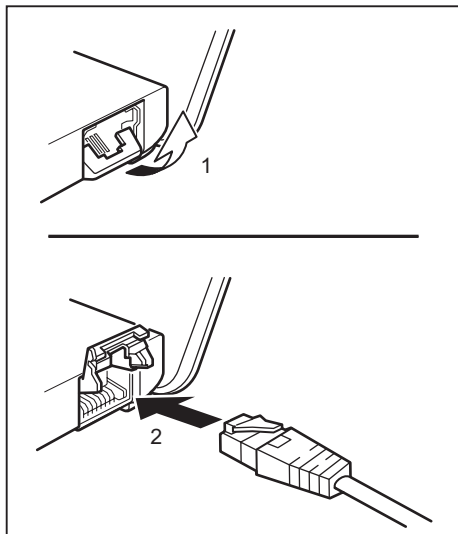

- ▶ Open the holder for the LAN connector (1).
- ▶ Connect the network cable to the LAN adapter (2).
- ▶ Connect the network cable to your network port.



Your network administrator can help you to configure and use the LAN connections.

The network cable is not included in the delivery scope. This type of cable can be obtained from a specialist dealer.

Use a shielded network cable (CAT 5e).

Your USB Thunderbolt™ Port replicator (optional)

Your Port Replicator is a device that helps you to quickly connect your notebook to your peripheral devices, such as a monitor, printer, etc.

The features offered by the Port Replicator include standard ports for monitor, audio and other USB devices, such as mouse and keyboard.

You need only connect the notebook to the Port Replicator in order to work with your peripheral devices.



In addition to the Thunderbolt™ 3 or Thunderbolt™ 4 port replicator described here, this system also supports a USB type-C port replicator, which is also connected to the system via the USB type-C connector.

Ports on the Thunderbolt™ Port Replicator

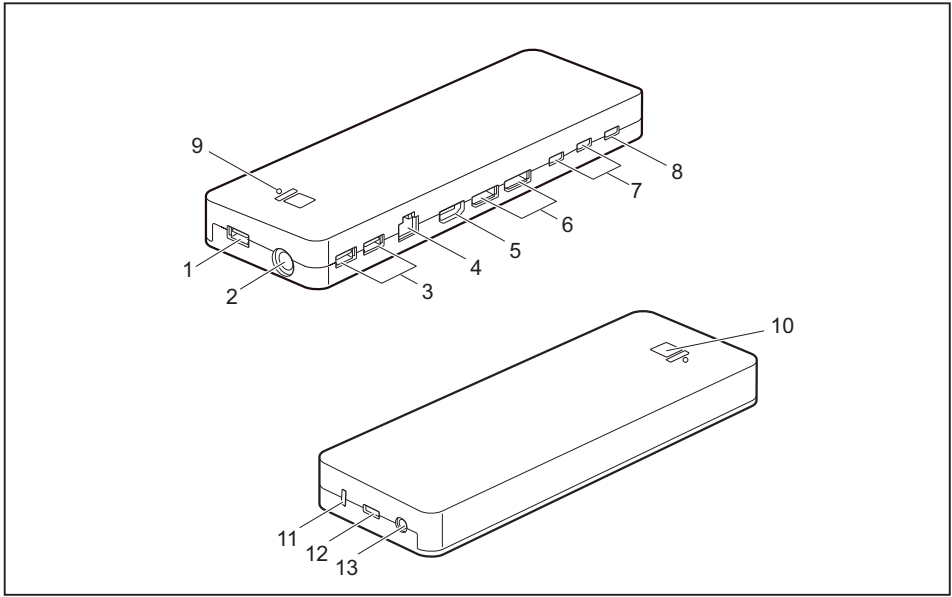

- 1 = USB port 3.2 Gen 1 with charging function (USB Type-A)
- 2 = DC input connector (DC IN)
- 3 = USB port 3.2 Gen 1 with charging function (USB Type-A)
- 4 = LAN port
- 5 = HDMI port
- 6 = DisplayPort
- 7 = USB port 3.2 Gen 2 with charging function (USB Type-C)

- 8 = USB port Intel® Thunderbolt™ with charging function and Displayport for external devices (USB Type-C Gen4)
- 9 = Charge level indicator
- 10 = ON/OFF switch with power-on indicator
- 11 = Security Lock Device
- 12 = USB Intel® Thunderbolt™ port for data connection and power supply for the notebook (USB Type-C Gen4)
- 13 = Combined headphones/microphone port

Charge level indicator on the Thunderbolt™ Port Replicator

Power indicator	Status
lit	Connected notebook is switched ON.
flashing	Connected notebook is switched ON in <i>sleep</i> mode.
does not light up	Notebook is not connected or is switched OFF.

Charge level indicator	Status
lit	Charging function is activated for a connected notebook and connected external devices.
does not light up	There is no charging function, notebook or external devices connected.

Setting up the port replicator



Select a suitable location for the Port Replicator before setting it up. Follow the instructions below when doing so:

- Never place the port replicator on a soft surface (e.g. carpeting, upholstered furniture, bed). This can block the air vents of the notebook and cause overheating and damage.
- Place the port replicator on a stable, flat and non-slip surface. Please note that the port replicator's rubber feet may mark certain types of surface.
- Never place the port replicator and the mains adapter on a heat-sensitive surface.
- Do not expose the port replicator to extreme environmental conditions.
Protect the port replicator from dust, humidity and heat.

Connecting the power adapter to the Thunderbolt™ Port Replicator

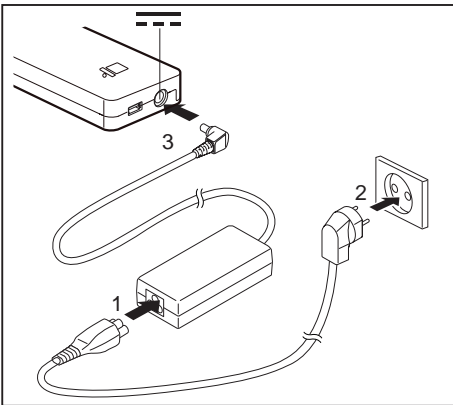

- ▶ Connect the power cable (1) to the power adapter provided for the device, see chapter ["Technical data", Page 73](#).
- ▶ Plug the power cable into the mains socket (2).
- ▶ Connect the mains adapter cable to the DC jack (DC IN) of the Port Replicator (3).

Connecting the notebook to the Thunderbolt™ Port Replicator

- ▶ Disconnect the mains adapter cable from the DC socket (DC IN) of the notebook.

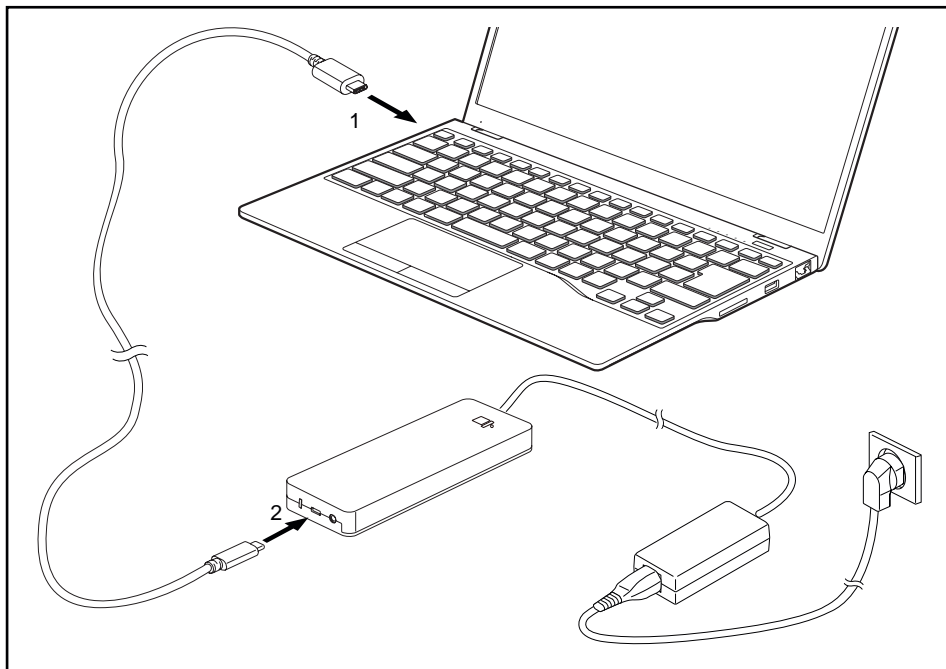

- ▶ Connect one end of the supplied Thunderbolt cable (USB Type-C) to the Thunderbolt port on the notebook (1).
- ▶ Connect the other end of the Thunderbolt cable (USB Type-C) to the Thunderbolt port for data connection and power supply (USB Type-C) on the port replicator (2).



Use only the Thunderbolt cable supplied with your Thunderbolt™ Port Replicator for the connection from the notebook to the Thunderbolt™ Port Replicator in order to ensure an error-free connection.



When the notebook is connected to a Port Replicator, the operating system creates a hardware profile for the "Docked" mode. In this profile, for example, the setting is saved as to which monitor was last used for output. This profile will be loaded, as soon as the notebook is connected to a Port Replicator of the same type.

Switching on the notebook via the Thunderbolt™ port replicator

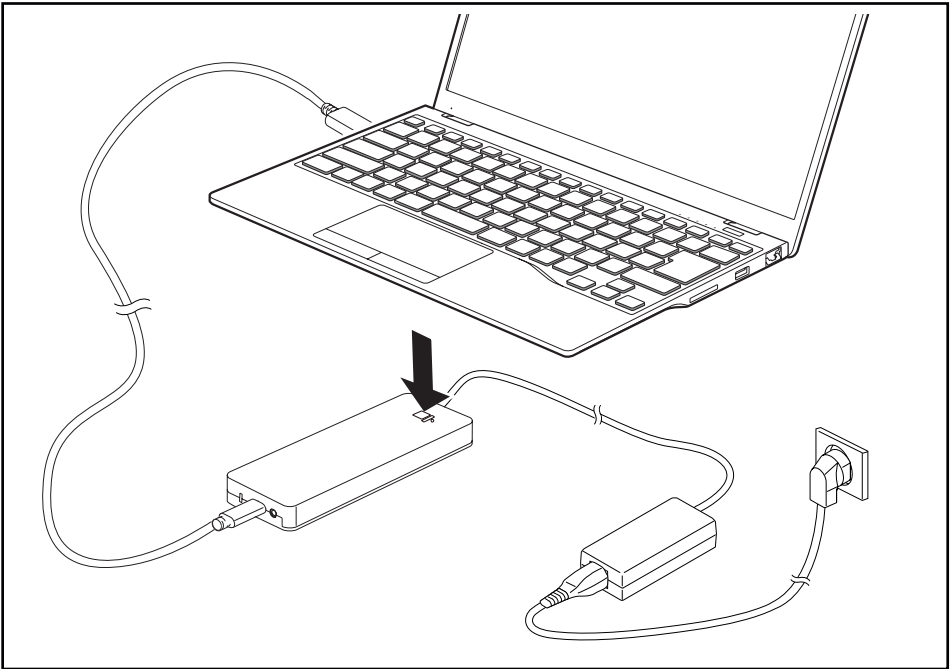

- ▶ Press the ON/OFF button on the port replicator to switch the notebook on.

Disconnecting the notebook from the Thunderbolt™ Port Replicator

- ▶ Disconnect the supplied Thunderbolt cable (USB Type-C) from the Thunderbolt port (USB Type-C) on the notebook.

Security functions

Your notebook has several security features that you can use to secure your system from unauthorised access.

This chapter explains how to use each function, and what the benefits are.



Please remember that in some cases, for example, forgetting your password, you may be locked out and unable to access your data. Therefore, please note the following information:

- Make regular backups to external data carriers such as external hard drives, CDs, DVDs or Blu-ray Discs.
- Some security functions need you to choose passwords. Make a note of the passwords and keep them in a safe place.

If you forget your passwords you will need to contact the our Service Desk. Deletion or resetting of passwords is not covered by your warranty and a charge will be made for assistance.



If you change the *Password Severity* setting from *Strong* to *Stringent* in the *Security BIOS Setup Utility* menu, the Fujitsu Service Desk can no longer reset the password. In this case, the system can remain permanently unusable.

Therefore, Fujitsu recommends to generally set up a supervisor password with the setting *Password Severity* = *Strong*.

Configuring the fingerprint sensor



Whether or not your device has a fingerprint sensor depends on the device configuration you have ordered.

The fingerprint sensor can record an image of a fingerprint. With additional fingerprint software, this image can be processed and used instead of a password.

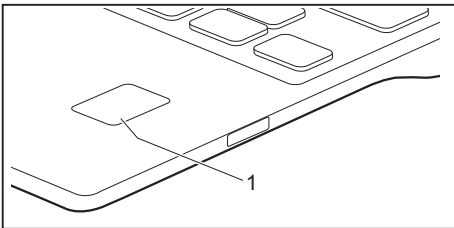

- ▶ You must install the fingerprint software in order to be able to use the fingerprint sensor (1).



The current *AuthConductor Client Basic* software for hand vein and fingerprint sensor is available on the Internet at ["https://support.ts.fujitsu.com/"](https://support.ts.fujitsu.com/)

After selecting the product and the operating system, you will find the software under *Downloads, Applications, Tools and Utilities*.

Configuring the palm vein sensor

i

Whether your device has a palm vein sensor depends on the device configuration you have ordered.

The palm vein sensor can record the image of the pattern of the veins of the hand. This image is evaluated by additional software and can be used instead of a password.

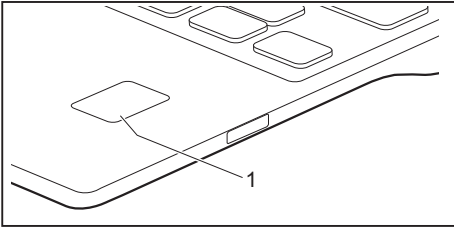

- ▶ To be able to use the palm vein sensor (1), you must install the software.

i

The current *AuthConductor Client Basic* software for hand vein and fingerprint sensor is available on the Internet at "<https://support.ts.fujitsu.com/>"

After selecting the product and the operating system, you will find the software under *Downloads, Applications, Tools and Utilities*.

Using the Security Lock

Your device comes with a Security Lock mechanism for the Kensington Lock Cable. You can use the Kensington Lock Cable, a sturdy steel cable, to help protect your notebook from theft. The Kensington Lock Cable is available as an accessory.

i

Fujitsu recommends the use of a combination lock.

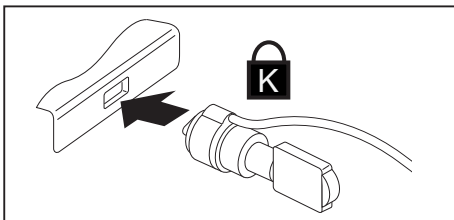

- ▶ Fit the Kensington Lock Cable to the mechanism on your notebook.

Configuring password protection in BIOS Setup Utility



Before using the various options for password protection in the *BIOS Setup utility* to increase data security, please observe the following:

Make a note of the passwords and keep them in a safe place. If you forget your supervisor password you will not be able to access your notebook. Deletion of the password is not covered by your warranty and a charge will be made for assistance.



Your password can be up to 32 characters long and can contain letters, numbers and special characters.

When using special characters, you must remember that these are dependent on the country variants of the keyboard used.



If you change the *Password Severity* setting from *Strong* to *Stringent* in the *Security BIOS Setup Utility* menu, the Fujitsu Service Desk can no longer reset the password. In this case, the system can remain permanently unusable.

Therefore, Fujitsu recommends to generally set up a supervisor password with the setting *Password Severity = Strong*.

Protecting BIOS Setup Utility (supervisor and user password)



If you have opened these operating instructions on the screen, we recommend that you print them out. You cannot call the instructions onto the screen while you are setting up the password.

The supervisor password and the user password both prevent unauthorised use of the *BIOS Setup Utility*. With the aid of the supervisor password you can access all of the functions of the *BIOS Setup Utility*, while the user password will only give you access to some of the functions. You can only set up a user password if a supervisor password has already been assigned.



Please refer to section ["Settings in BIOS Setup Utility", Page 60](#) for a description of how to call up and operate the *BIOS-Setup-Utility*.

Assigning the supervisor and user passwords

- ▶ Start the *BIOS Setup Utility* and go to the *Security* menu.
- ▶ Select the *Set Supervisor Password* field and press the Enter key.
 - ↳ With *Enter new Password*: you are asked to enter a password.
- ▶ Enter the password and press the Enter key.
 - ↳ *Confirm new Password* requires you to confirm the password.
- ▶ Enter the password again and press the Enter key.
 - ↳ *Changes have been saved* is a confirmation that the new password has been saved.
- ▶ To set the user password, select *Set User Password* and proceed exactly as when configuring the supervisor password.
 - ↳ If you do not want to change any other settings, you can exit *BIOS Setup Utility*.
- ▶ In the *Exit* menu, select the option *Save Changes & Exit*.
- ▶ Select *Yes* and press the Enter key.
 - ↳ The notebook is then rebooted and the new password comes into effect. It will now be necessary to first enter your supervisor or user password in order to open the *BIOS Setup Utility*. Please note that the user password only provides access to a few of the BIOS settings.

Changing the supervisor or user password

You can only change the supervisor password when you have logged into the *BIOS Setup Utility* with the supervisor password.

- ▶ Call the *BIOS Setup Utility* and go to the *Security* menu.
- ▶ When changing the password, proceed exactly as for password assignment.

Removing passwords

To remove a password (without setting a new password) perform the following steps:

- ▶ Start the *BIOS Setup Utility* and go to the *Security* menu.
- ▶ Highlight the *Set Supervisor Password* or *Set User Password* field and press the Enter key.
 - ↳ You will be requested to enter the current password by the *Enter Current Password* prompt. You will be requested to enter a new password by the *Enter New Password* prompt.
- ▶ Press the Enter key twice.
- ▶ In the *Exit* menu, select the option *Save Changes & Exit*.
- ▶ Select *Yes* and press the Enter key.
 - ↳ The notebook will now reboot with the password removed. Removing the supervisor password simultaneously deactivates the user password.

Password protection for booting of the operating system



With the supervisor password you have set in the *BIOS Setup Utility* (see section "[Assigning the supervisor and user passwords](#)", Page 49), you can also prevent starting of the operating system.

Activating system protection

- ▶ Start the *BIOS Setup Utility* and go to the *Security* menu.
- ▶ Select the *Password on Boot* option and press the Enter key.
- ▶ Select the desired option (*Disabled*, *First Boot* or *Every Boot*) and press the Enter key
- ▶ Select the *Save Changes & Exit* option under *Exit*.
- ↳ The notebook reboots. You will be prompted to enter your password (the supervisor password).

Deactivating system protection

- ▶ Start the *BIOS Setup Utility* and go to the *Security* menu.
- ▶ Select the *Password on Boot* option and press the Enter key.
- ▶ Select the *Disabled* option and press the Enter key.
- ↳ If you do not want to change any other settings, you can exit *BIOS Setup Utility*.
- ▶ Select the *Save Changes & Exit* option under *Exit*.
- ↳ The notebook will reboot. The system is no longer password-protected.

Password protection for the hard disk

If a supervisor password has been assigned, a password for the hard disk can also be set in the *Hard Disk Security* menu.

The hard disk is protected by this password. Data on this hard disk can only be read into another system if the correct password has been entered.

Trusted Platform Module (TPM) (device-dependent)

To use the TPM, you must activate the TPM in the **BIOS Setup** *before the software is installed*. The condition for this is that you have assigned at least the supervisor password (see ["Security functions", Page 46](#)).

Instructions for how to call up and use the *BIOS Setup Utility* can be found in section ["Settings in BIOS Setup Utility", Page 60](#).

Enabling TPM

- Requirement: You have set a supervisor password, see ["Security functions", Page 46](#).
- ▶ Call up the BIOS Setup and select the *Security* menu.
- ▶ Mark the *TPM (Security Chip) Setting* field and press the Enter key
- ▶ Select the "*Security Chip*" "*Enabled*" entry to activate the TPM
- ↳ Once you have activated the TPM through a reboot, the *Clear Security Chip* menu option appears. With *Clear Security Chip*, you can delete the owner in the TPM, if the TPM has already been used. With *Enabled*, all secret keys generated by applications (e.g. SRK - Storage Root Keys, AIK - Attestation Identity Keys, etc.) are deleted.

Please note that you will then no longer be able to access the data you have encrypted with the keys based on that holder.
- ▶ Select the *Exit Saving Changes* option in the Exit menu.
- ▶ Press the Enter key and select *Yes*.
- ↳ The notebook will restart, and TPM will be enabled after the reboot.

Disabling TPM

- Requirement: You have set a supervisor password, see ["Security functions", Page 46](#).
- ▶ Call up the BIOS Setup and select the *Security* menu.
- ▶ Mark the *TPM (Security Chip) Setting* field and press the Enter key.
- ▶ Select the "*Security Chip*" "*Disabled*" entry to deactivate the TPM
- ▶ From the *Exit* menu, choose the option *Exit Saving Changes*.
- ▶ Press the Enter key and select *Yes*.
- ↳ Your notebook will now restart and TPM will be disabled.

SmartCard reader (optional)

SmartCards are not supplied as standard equipment. You can use all SmartCards that comply with the ISO standard 7816-1, -2 or -3. These SmartCards are available from various manufacturers.

With the appropriate software you can use your SmartCard as an alternative to password protection, but also as a digital signature, for encrypting your e-mails or for home banking.

We recommend that you always use two SmartCards. Always keep one of the SmartCards in a safe place if you are carrying the other SmartCard with you.

In order to be able to take advantage of all the security features of your notebook, you will need a CardOS SmartCard from Fujitsu.



The SmartCard can only be used with a PIN, offering maximum protection even if you lose the SmartCard. In order to maximise your security, the CardOS SmartCard is disabled if three incorrect attempts are made to enter the PIN.

When you use the CardOS SmartCard for the first time, you will either need to enter the preset PIN "12345678" or the PIN given to you by your systems administrator.

Inserting the SmartCard



Do not use force when inserting and removing the SmartCard.

Make sure that foreign objects do not fall into the SmartCard reader.

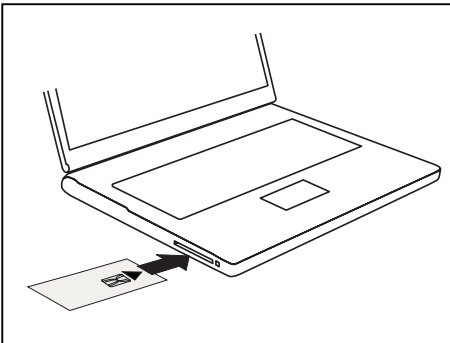

- ▶ Slide the SmartCard into the SmartCard reader with the chip facing upwards (on some variants it faces down) and to the front.

Connecting external devices



Always refer to the safety information provided in ["Important notes", Page 12](#) before connecting or disconnecting any devices to or from your notebook.

Always read the documentation supplied with the device you wish to connect.

Never connect or disconnect cables during a thunderstorm.

Never pull at a cable when disconnecting it. Always grasp the plug.



With some devices such as USB devices, it is not necessary to switch off the notebook and the device before connecting/disconnecting. For more information about whether or not devices need to be switched off, please refer to the documentation supplied with the external device.

Some of the external devices require special drivers (see the operating system and external device documentation).

HDMI port

The HDMI port on your notebook or on the optional Port Replicator can be used to connect an external amplifier, LCD TV or a plasma TV with an HDMI connection.

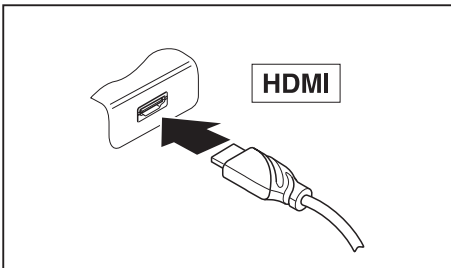

- ▶ Connect the data cable to the external device.
- ▶ Connect the data cable to the HDMI port on the notebook or on the optional Port Replicator.

Connecting an external monitor to the port replicator

Including the internal screen, up to 4 screens can be used simultaneously (please refer to ["Function keys and key combinations", Page 25](#), section "Switching to output screen").

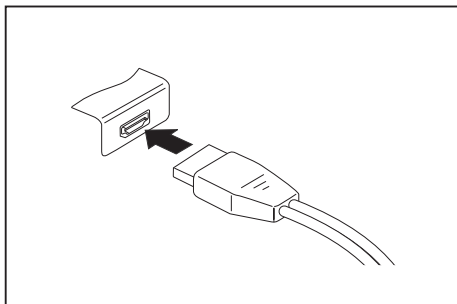

Digital DisplayPort (on optional Port Replicator)

- ▶ Switch off the notebook and the external monitor.
- ▶ Plug the data cable of the external monitor into the monitor port.
- ▶ First switch on the external monitor and then the notebook.



You can also switch between the external monitor and the LCD monitor of the notebook, see chapter ["Function keys and key combinations", Page 25](#).

You can display the same picture on the external monitor and the notebook LCD monitor simultaneously.

Connecting USB devices

On the USB ports, you can connect external devices that also have a USB port (e.g. a DVD drive, a printer, a scanner or a modem).



USB devices are hot-pluggable. This means you can connect and disconnect devices while your operating system is running.

USB 1.x has a maximum data transfer rate of 12 Mbit/s.

USB 2.0 has a data transfer rate of up to 480 Mbit/s.

USB 3.0 has a data transfer rate of up to 5 Gbit/s.

USB 3.2 (Gen1) has a data transfer rate of up to 5 Gbit/s.

USB 3.2 (Gen2) has a data transfer rate of up to 10 Gbit/s.

Additional information can be found in the documentation for the USB devices.

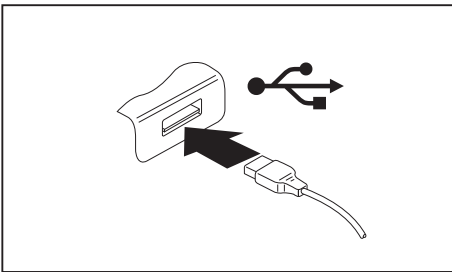

- ▶ Connect the data cable to the external device.
- ▶ Connect the data cable to a USB port of the notebook.



Device drivers

USB devices will be automatically recognised and installed by your operating system.

USB port Intel® Thunderbolt™ 4 with charging function and display port (USB Type-C)

At this USB port, you can charge a connected USB device or operate devices without additional power supply.

This is also possible with connected notebook computers by going to the *BIOS Setup Utility* under the menu *Advanced > Miscellaneous Configurations* and activating the function *USB Type-C Power Delivery on System-Off*. Instructions for how to call up and operate the *BIOS Setup Utility* can be found in section "[Settings in BIOS Setup Utility](#)", [Page 60](#).

With the USB Type-C Port Replicator available as an accessory, the notebook can be supplied with power via this USB port.



USB devices are hot-pluggable. This means you can connect and disconnect the cables of USB devices while the system is running.

Additional information can be found in the documentation for the USB devices.

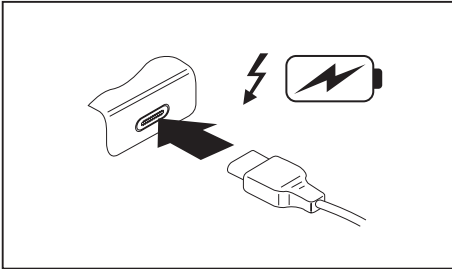

- ▶ Connect the data cable to the external device.
- ▶ Connect the data cable to the USB port Intel® Thunderbolt™ 4 with charging function and display port (USB Type-C) of the notebook.

USB port with charging function (Anytime USB charge)

You can use this USB port to charge or supply power to a connected USB device (e.g. to charge a PDA or a mobile phone or to connect a USB lamp).

Charging is also possible when the notebook is switched off, if the *Anytime USB Charge* function is activated in the *Advanced* menu of the *BIOS Setup Utility*. If the setting *AC* is selected, the device will only be charged when the mains adapter is connected.

Please refer to section "[Settings in BIOS Setup Utility](#)", [Page 60](#) for a description of how to call up and operate the *BIOS-Setup-Utility*.



It is recommended that the notebook be operated with the power supply connected whenever the USB port with charging function is in use, as this function will drain the battery more quickly if an external USB device is being charged.

The power supply unit must already be connected when the notebook is switched off, as otherwise the USB charging function will be disabled and the connected USB devices will not be charged.



Some USB devices (e.g. mobile telephones) require a driver in order to utilise the USB charging function. In this case the USB charging function will not work when the notebook is switched off, as no drivers are active when the notebook is switched off.

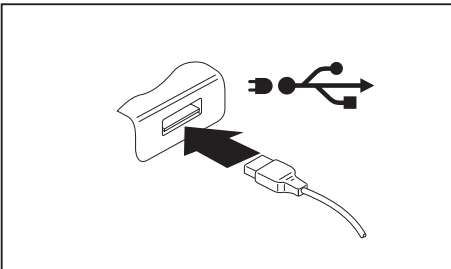

- ▶ Connect the data cable to the external device.
- ▶ Connect the data cable to a USB port (Anytime USB charge) of the notebook.

How to remove USB devices correctly



Always correctly remove the device according to the rules described below, to ensure that none of your data is lost.

- ▶ Left click on the icon to safely remove hardware, located in the taskbar.
- ▶ Select the device which you want to shut down and remove.
- ▶ Press the Enter key.
- ↳ Wait for the dialogue box which tells you that it is now safe to remove the device.

Headset port

The headset port lets you connect a headset, headphones, external speakers or microphones to your notebook.

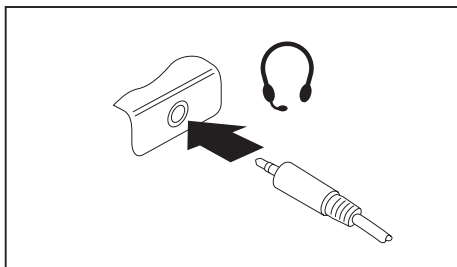

- ▶ Connect the audio cable to the external device.
- ▶ Connect the audio cable to the headset port of the notebook.
- ↳ The internal loudspeakers are disabled.



If you buy a cable from a retailer, please note the following information:

The headset port on your notebook is a "3.5 mm jack socket".

If you want to connect a headset, headphones or loudspeakers, you will need a "3.5 mm jack plug".

Removing and installing components during servicing



Only qualified technicians should repair your notebook. Unauthorised opening or incorrect repair may greatly endanger the user (electric shock, fire risk) and will invalidate your warranty.

Settings in BIOS Setup Utility

The *BIOS Setup Utility* allows you to set the system functions and the hardware configuration for the notebook.

When it is delivered, the notebook is set to factory default settings. You can change these settings in *BIOS Setup Utility*. Any changes you make take effect as soon as you save and exit the *BIOS Setup Utility*.

The *BIOS Setup Utility* program contains the following menus:

<i>Info</i>	Displays information relating to the BIOS, processor and notebook
<i>System</i>	Set calendar and clock, configure SATA drive
<i>Advanced</i>	Configuration of various hardware components, such as mouse, keyboard, processor
<i>Security</i>	Password settings and security functions
<i>Boot</i>	Configuration of the start-up sequence
<i>Exit</i>	Exits the <i>BIOS Setup Utility</i>

Starting the BIOS Setup Utility

- ▶ Start the device (switch off/on or reboot the Operating System).
- ↳ Depending on the setting for *Fast Boot* in the *BIOS Setup Utility* the following display, if applicable, appears on the screen on start-up:
 - <F2> BIOS Setup <F12> Boot Menu
- ▶ Press the function key **F2**.
- ▶ If a password has been assigned, enter the password and press the Enter key.



If you have forgotten the password, contact your system administrator or contact our customer service centre.

The *BIOS Setup Utility* starts.

Operating the BIOS Setup Utility



Press the **F1** key to display help on the operation of the *BIOS Setup Utility*. The description of the individual settings is shown in the right-hand window of the *BIOS Setup Utility*.

With the **F9** key you can load the default settings of the *BIOS Setup Utility*.

- ▶ Use the cursor keys **←** or **→** to select the menu in which you would like to configure settings.
↳ The menu is displayed on the screen.
- ▶ Select the option that you want to change with the cursor keys **↑** or **↓**.
- ▶ Press the Enter key.
- ▶ Press the **ESC** key to exit the selected menu.
- ▶ For future reference, make a note of the changes you have made (e.g. in this manual).

Exiting BIOS Setup Utility

You need to select the desired option in the *Exit* menu and activate it by pressing the Enter key:

Exit Saving Changes - save changes and exit BIOS Setup Utility

- ▶ To save the current menu settings and exit the *BIOS Setup Utility*, select *Exit Saving Changes* and *Yes*.
- ↳ The notebook is rebooted and the new settings come into effect.

Exit Discarding Changes – Discard changes and exit BIOS Setup Utility

- ▶ To discard the changes, select *Exit Discarding Changes* and *Yes*.
- ↳ The settings in place when *BIOS Setup Utility* was called remain effective. *BIOS Setup Utility* is terminated and the notebook is rebooted.

Load Setup Defaults – Copy Standard Entries

- ▶ To copy the standard entries for all menus of the *BIOS Setup Utility*, choose *Load Setup Defaults* and *Yes*.

Discard Changes – Discard changes without exiting the BIOS Setup Utility

- ▶ To discard the changes you have made, select *Discard Changes* and *Yes*.
- ↳ The settings in place when *BIOS Setup Utility* was called remain effective. You can now make additional settings in the *BIOS Setup Utility*.
- ▶ If you want to exit *BIOS Setup Utility* with these settings, select *Exit Saving Changes* and *Yes*.

Save Changes - save changes without exiting the BIOS Setup Utility

- ▶ To save the changes, select *Save Changes* and *Yes*.
- ↳ The changes are saved. You can now make additional settings in the BIOS Setup Utility.
- ▶ If you want to exit BIOS Setup Utility with these settings, choose *Exit Saving Changes* and *Yes*.

Save Changes and Power Off

- ▶ To save the changes and switch off your device, select *Save Changes and Power Off* and *Yes*.
- ↳ The changes are saved. Your device is shut down.

Erase Disk

Erase Disk is a solution that is integrated into the firmware of the FUJITSU Computer (UEFI: Unified Extensible Firmware Interface), to delete all the data from a hard disk or solid state drive (SSD).

This function can be used to delete all data from internal hard disks or SSDs, before the hard disks are discarded or the complete computer system is disposed of. The function can also be used if hard disks must be completely deleted, e.g. before installing a new operating system.



The application can only be selected and run if an administrator/supervisor password has been assigned (Menu *BIOS Setup - Security*).

To erase data from SATA hard disks or SSDs, proceed as follows:

- ▶ Call the *BIOS Setup* with the Administrator/Supervisor password.
- ▶ To start the application, select *Erase Disk (BIOS Setup - Advanced or BIOS Setup - Security)* and set *Start after Reboot*.
- ▶ Then select *Save Changes and Exit* in the menu *Save & Exit / Exit* to initiate a reboot and start *Erase Disk*.



Because of the reboot, the *Erase Disk* will be started. You have the option to interrupt the process during the user selection.

- ▶ After the application starts, the Administrator/Supervisor password must be entered for security reasons.
- ↳ A dialogue field appears in which a particular, several or all the hard disks can be selected for deletion. This depends on the number of hard disks in your system.
- ▶ Select the hard disk(s) to be deleted. The selected hard disk(s) will be deleted one-by-one.



Erase Disk offers four deletion options, from *fast* (with one deletion pass) to *very secure* (with 35 deletion passes). Depending on the algorithm chosen, the process can take between ~10 seconds and ~10 minutes per GB:

- *Zero Pattern* (1 pass)
- *German BSI/VSITR* (7 passes)
- *DoD 5220.22-M ECE* (7 passes)
- *Guttman* (35 passes)



SSD drives are securely erased with the *Enhanced Secure Erase ATA* command integrated in the firmware.

- ▶ Select the desired deletion algorithm for the selected hard disks.



The complete deletion process can be recorded as an audit-compliant log and copied to an external USB stick, which must be formatted as FAT32. Please connect only one external USB stick.

- ▶ Select whether a status report should be written to the USB stick.



The user can select the following tasks which should be run by the system after the deletion process:

- *Reset administrator and user password*
- *Load BIOS setup defaults*
- *Shutdown the Computer*
- *Exit Erase Disk with no additional options upon completion*

- ▶ Select the function which you require.

↳ The deletion process starts.

Troubleshooting and tips



Follow the safety notes in the "Safety/Regulations" manual when connecting or disconnecting cables.

If a fault occurs, try to correct it as described. If you fail to correct the problem, proceed as follows:

- ▶ Make a note of the steps and the circumstances that led to the fault. Also make a note of any error messages displayed.
- ▶ Switch the notebook off.
- ▶ Please contact the Hotline/Service Desk.



The telephone numbers can be found at: ["http://support.ts.fujitsu.com/contact/servicedesk"](http://support.ts.fujitsu.com/contact/servicedesk). Have the following information ready when you call:

- The model name and serial number of the notebook. The serial number is located on a sticker on the underside of the notebook.
- Notes of any messages that appear on the screen and information on acoustic signals.
- Any changes you have made to the hardware or software since receiving the notebook.
- Any changes you have made to the *BIOS Setup* settings since receiving the notebook.
- Your system configuration and all peripheral devices connected to your system.
- Your sales contract.



Our notebooks have been designed primarily with mobile applications in mind. This means that considerable effort has been made to optimise components and equipment in terms of weight, space and energy requirements. Depending on the particular configuration you have purchased, it is possible that functionality may be slightly reduced compared to a desktop PC if you are running processor-intensive gaming software, e.g. games with intensive 3D graphics. Updating your hardware with drivers which have not been approved by Fujitsu Technology Solutions may result in performance losses, data losses or malfunction of the equipment. A list of approved drivers and current BIOS versions can be downloaded from: ["http://support.ts.fujitsu.com/Download/Index.asp"](http://support.ts.fujitsu.com/Download/Index.asp)

Help if problems occur

Should you encounter a problem with your computer that you cannot resolve yourself:

- ▶ Note the ID number of your device. The ID number is found on the type rating plate on the back or underside of the casing.
- ▶ Contact the Service Desk responsible for your country for clarification of the problem: ["http://support.ts.fujitsu.com/contact/servicedesk"](http://support.ts.fujitsu.com/contact/servicedesk). When you do this, please have ready the ID number and serial number of your system.

Reset by switching off the battery

If the device no longer responds and does not react to the ON/OFF switch, use the battery on/off button to switch the device off, it is located on the bottom of the device.

- ▶ Switch the battery off, then switch it on again (see chapter ["Switch the battery off and on", Page 32](#))

Restore contents of the hard disk from Recovery CD/DVD

You can use the "Windows Recovery CD" (optionally available) and the "Drivers & Utilities CD/DVD" to reinstall the operating system.

The instructions are provided on the case of the Recovery CD.



You will need an external optical drive available as an accessory.



During the reinstall process your personal files and any installed programs will be deleted. We advise you to backup your files to an external hard drive, or CD / DVD disk before you start.

- ▶ Switch the notebook on.
- ↳ Depending on the *Fast Boot* setting in the *BIOS Setup utility*, the following information may appear on the screen during start:
<ESC>Diagnostic screen <F12>Boot Menu <F2>BIOS Setup
- ▶ When this message appears, press the function key **F12**.
- ▶ Insert the "Windows Recovery CD" into the optical drive.
- ▶ Select *CD-ROM* and press the Enter key.
- ▶ Follow the instructions on the screen.
After the installation you must install all the drivers again. Some installed hardware components will not be correctly supported until this has been done.
- ▶ Insert the "Drivers & Utilities" CD/DVD into the optical drive. The CD starts automatically.
- ▶ Click on the *Desk Update* button.
- ▶ Select *Automatic driver installation (Express)* and click on *Start installation*.
- ▶ Follow the instructions on the screen.
- ▶ Restart your notebook when the driver installation is completed.

Restoring the system under Windows 10

If necessary, you can reset your system to the original state of the hard disk.

- ▶ Select *Settings* from the Start menu.
- ▶ Select *Update & security*.
- ▶ Select *Recovery*.
- ▶ Select according to your requirements from the options given.

The notebook's date or time is incorrect

Cause	Troubleshooting
Time and date are incorrect.	▶ With the <i>BIOS-Setup-Utility</i> , you can set the date and time in the <i>main</i> menu.
If the time and date are still set incorrectly after switching on the notebook.	▶ Please contact your sales outlet or our Hotline/Service Desk.

When certain characters are entered on the keyboard, only numerals are written

Cause	Troubleshooting
The virtual numeric keypad of your device is activated, see "Virtual numeric keypad", Page 24	▶ Press the [Num] key.

The notebook's LCD screen remains blank

Cause	Troubleshooting
Monitor is switched off.	▶ Press a key or touch the touchpad.
External monitor or television set connected.	▶ Press the key to switch screen output, see "Function keys and key combinations", Page 25 .

The LCD screen is difficult to read

Cause	Troubleshooting
Reflected glare	<ul style="list-style-type: none"> ▶ Turn the notebook or alter the tilt of the LCD screen. ▶ Increase the brightness of the screen.

The external monitor remains blank

Cause	Troubleshooting
Monitor is switched off.	▶ Switch the external monitor on.
Power saving has been activated (monitor is blank).	▶ Press any key to continue.
Brightness is set to dark.	▶ Adjust the brightness of the monitor.
Screen output is set to the notebook's LCD screen	▶ Press the key to switch screen output, see "Function keys and key combinations", Page 25 .
The external monitor's power cable or data cable is not connected properly.	<ul style="list-style-type: none"> ▶ Switch off the external monitor and the notebook. ▶ Check whether the power cable is plugged properly into the external monitor and into the power socket. ▶ Check whether the data cable is properly connected to the notebook and the external monitor (if it is plugged in with a connector). ▶ Switch on the external monitor and the notebook.

The external monitor is blank or the image is unstable

Cause	Troubleshooting
The wrong external monitor has been selected or the wrong screen resolution has been set for the application program.	<ul style="list-style-type: none"> ▶ Stop the application program under Windows by pressing [Alt] + [F4]. If the error persists after stopping the program, use the key for switching screen output (see "Function keys and key combinations", Page 25) to switch to the LCD screen of the notebook. Change the following setting: <ul style="list-style-type: none"> ▶ Set the screen resolution: Set the screen resolution as described in the documentation for your operating system. ▶ Select monitor: Select monitor 1 or 2 as described in the documentation for your operating system.

The notebook cannot be started

Cause	Troubleshooting
The battery is dead.	▶ Connect the notebook to the mains voltage via the mains adapter and charge the battery.
The power adapter is not connected correctly.	▶ Check whether the mains adapter is connected correctly to the notebook. ▶ Switch the notebook on.

The notebook stops working

Cause	Troubleshooting
Notebook is in energy saving mode.	▶ Leave energy saving mode.
An application programme has caused the malfunction.	▶ Close the application program or restart the notebook (by restarting the operating system or switching the device off and back on again).
The battery is dead.	▶ Connect the notebook to the mains voltage via the mains adapter and charge the battery.

The printer does not print

Cause	Troubleshooting
The printer is not switched on.	▶ Make sure that the printer is switched on and ready for operation (refer to the documentation supplied with the printer).
The printer is not connected correctly.	▶ Check that the data cable connecting the notebook to the printer is properly connected.
The printer driver is faulty or not correctly installed, or it is the wrong printer driver.	▶ Check that the data cable connecting the notebook to the printer is properly connected. ▶ Check whether the correct printer driver is loaded (refer to the printer documentation).

The wireless connection to a network does not work

Cause	Troubleshooting
The wireless component is disabled.	<ul style="list-style-type: none"> ▶ Switch the wireless component on (see "Switching the wireless components on and off", Page 39).
The wireless component is enabled. Despite this, the wireless connection to a network does not work.	<ul style="list-style-type: none"> ▶ Check whether the wireless connection is switched on via the software. ▶ Further information on using the wireless component can be found in the help files.

SmartCard reader is not recognised.

Cause	Troubleshooting
Chip card inserted incorrectly.	<ul style="list-style-type: none"> ▶ Check if you inserted your SmartCard into the SmartCard reader correctly. ▶ Check whether the SmartCard you are using is supported. Your SmartCard must comply with the ISO standard 7816-1, -2, -3 and -4.

SmartCard PIN forgotten

Cause	Troubleshooting
PIN forgotten	<ul style="list-style-type: none"> ▶ If you are working in a network, contact your system administrator, who can unlock your system with a Supervisor PIN.

SmartCard lost

Cause	Troubleshooting
SmartCard lost	<ul style="list-style-type: none"> ▶ If you are working in a network, contact your system administrator, who can boot up your notebook with a Supervisor SmartCard.

Error messages on the screen

This section describes the error messages generated by the BIOS Setup. Error messages displayed by the operating system or programmes are described in the relevant documentation.



If the error message appears repeatedly, despite troubleshooting measures, please contact the place of purchase or our customer service centre.

Error message/cause	Resolution
<p><i>CMOS battery bad</i></p> <p>If the error message occurs repeatedly, the buffer battery in the notebook is flat.</p>	<ul style="list-style-type: none"> ▶ Contact your sales outlet or our customer service centre.
<p><i>System CMOS checksum bad - default configuration used</i></p> <p>The system configuration information is incorrect.</p>	<ul style="list-style-type: none"> ▶ Switch the notebook off. ▶ Switch the notebook on. ▶ Press the function key [F2] to access the <i>BIOS Setup</i>. ▶ In the <i>BIOS Setup</i>, select the <i>Exit</i> menu. ▶ Select the entry <i>Load Setup Defaults</i>. ▶ Select <i>OK</i> and press the Enter key.
<p><i>Extended memory failed at offset: xxxx Failing Bits: zzzz zzzz</i></p> <p>When testing the extended memory an error has resulted at the address xxxx.</p>	<ul style="list-style-type: none"> ▶ Check whether the additional memory module has been inserted correctly.
<p><i>Failure Fixed Disk n</i></p> <p>The settings of the hard disk drive are incorrect.</p>	<ul style="list-style-type: none"> ▶ Start the <i>BIOS Setup (Primary Master submenu)</i> and select the correct settings.
<p><i>Keyboard controller error</i></p>	<ul style="list-style-type: none"> ▶ Switch the notebook off using with the ON/OFF button. ▶ Wait 3 - 5 seconds and switch on the notebook again.
<p><i>Keyboard error</i></p>	<p>If you are using an external keyboard:</p> <ul style="list-style-type: none"> ▶ Check the connection and reboot the notebook.
<p><i>nn Stuck key</i></p>	<ul style="list-style-type: none"> ▶ Make sure that no key is pressed.
<p><i>Operating system not found</i></p>	<ul style="list-style-type: none"> ▶ Check in the <i>BIOS Setup</i> whether your hard disk has been set correctly. ▶ Make sure that the operating system is installed on the corresponding drive.
<p><i>Press <F1> to resume, <F2> to SETUP</i></p> <p>This error message appears if an error occurs during the self-test before starting the operating system.</p>	<ul style="list-style-type: none"> ▶ Press the [F1] function key to start the operating system. ▶ Press the function key [F2] to access the <i>BIOS Setup</i>.

Error message/cause	Resolution
<i>Previous boot incomplete - Default configuration used</i> Due to an error during the previous system boot, default values were used for certain settings. Check the settings in the BIOS Setup.	▶ Press the <input type="text" value="F1"/> function key when prompted to do so.
<i>Real time clock error</i>	▶ Contact your sales outlet or our customer service centre.
<i>nnnnK Shadow RAM failed at offset: xxxx Failing Bits: zzzz</i>	▶ Contact your sales outlet or our customer service centre.
<i>System battery is dead - Replace and run SETUP</i>	▶ Contact your sales outlet or our customer service centre.
<i>System cache error - Cache disabled</i>	▶ Contact your sales outlet or our customer service centre.
<i>System timer error</i>	▶ Contact your sales outlet or our customer service centre.

Technical data

LIFEBOOK

Ambient conditions	
Operating temperature	5 °C to 35 °C / 41 °F to 95 °F
Transport temperature	-10 °C 60 °C / 14 °F 140 °F
Relative humidity	20 % ... 80 % (no condensation)
Operating height	up to 3048 m
Dimensions	
Width x depth x height	307 mm x 197 mm x 15.5 mm (excl. rubber feet) / 12.09 inches x 7.76 inches x 0.61 inches (excl. rubber feet)
Weight	from 885 g with 50 Wh battery / from 1.95 lb with 50 Wh battery
Main memory	
	LPDDR4 memory with 8, 16 or 32 GByte (soldered)



The data sheet for the device provides further technical data. You can find the data sheet on your device or you can download it from the Internet at ["http://www.fujitsu.com.fts/support/"](http://www.fujitsu.com.fts/support/).

Rechargeable battery



You can find information on the batteries used in your device on the Internet at ["http://www.fujitsu.com.fts/support/"](http://www.fujitsu.com.fts/support/).

4-cell battery 50 Wh	
Nominal voltage	14.4 V
Rated capacity	3490 mAh
Type	Lithium ions
Interchangeability	By authorized service provider

Button cell battery CR1620	
Type	Lithium metal
Interchangeability	By authorized service provider

Mains adapter (notebook computer)

Electrical data	
Primary	65 W
Rated voltage	100 V – 240 V (automatic)
Rated frequency	50 Hz – 60 Hz (automatic)
Secondary	
Rated power voltage	19 V
Maximum rated current	3.42 A

An additional mains adapter or power cable can be ordered at any time.

Mains adaptor (Thunderbolt™ port replicator, optional)



Connect only the 170 W mains adapter to the Port Replicator.



The following technical data applies to the mains adapter supplied with the Port Replicator, which you can order separately.

Primary	
Rated voltage	100 V to 240 V (automatic)
Nominal frequency	50 Hz to 60 Hz (automatic)
Maximum rated current	2.5 A
Secondary	
Nominal power	170 W
Rated voltage	20 V
Max. rated current	8.5 A



An additional mains adapter or power cable can be ordered at any time.

Manufacturer's notes

Disposal and recycling

If the battery is not replaceable by the user, have it replaced and disposed of by an authorized service provider.

Information about this subject can be found on your notebook or on our website:

["https://www.fujitsu.com/emeia/about/local/csr/recycling/"](https://www.fujitsu.com/emeia/about/local/csr/recycling/)

TCO Certified

Please note that TCO-certified systems bear the "TCO certified" logo. Further information is given in the "TCO certified" manual appendix at ["http://support.ts.fujitsu.com/Manuals/"](http://support.ts.fujitsu.com/Manuals/).

SAR limit value (Specific Absorption Rate)

Body SAR value < 2W/kg

Certification markings

Certification markings are listed as applicable in the "Manual Appendix - Additional Certifications" supplement.

If such markings are available, you can find the supplement on the Internet at ["http://support.ts.fujitsu.com/Manuals/"](http://support.ts.fujitsu.com/Manuals/) with the Operating Manual for your device.

Index

- A**
 - Alt + Tab 26
 - Anti-theft protection 47
 - Audio ports 58
- B**
 - Back tab 26
 - Background lighting 27
 - Backspace 23
 - Bass loudspeaker (subwoofer) 36
 - Battery
 - battery life 32
 - caring for and maintaining 32
 - charge level 32–33
 - charging 32
 - Battery indicator 20
 - Battery status indicator
 - see Battery indicator 20
 - Battery status meter 32
 - Battery symbol
 - see Battery indicator 20
 - BIOS Setup Utility
 - calling 60
 - exiting 62
 - operating 61
 - protecting with password 48
 - settings 60
 - Bluetooth
 - Switching the module off 39
 - Switching the module on 39
 - Bluetooth, safety notes 13
 - Buttons 22
- C**
 - Caps Lock 23
 - indicator 20
 - Certification markings 75
 - Cleaning 15
 - Components
 - installing / removing 59
 - Configuration, BIOS Setup Utility 60
 - Connecting audio devices 58
 - Connecting headphones 58
 - Crystal View display
 - cleaning 15
 - Ctrl+Alt+Del 26
 - Cursor control 23
 - Cursor keys 23
- D**
 - Date is incorrect 67
 - Device
 - setting up 17
 - Disable
 - microphone 25
- E**
 - Enable
 - microphone 25
 - Energy
 - energy saving 13
 - Energy saving 13
 - Energy saving functions 25
 - Energy saving mode
 - leaving 69
 - Enter 23
 - Enter key 23
 - Error message:
 - on the screen 71
 - Error messages on the screen 71
 - Ethernet LAN 40
- F**
 - F Lock Indicator 20
 - F1 25
 - F10 26
 - F2 25
 - F3 25
 - F4 25
 - F5 25
 - F6 25
 - F7 25
 - F8 25
 - F9 25
 - Fault
 - correction 65
 - Fingerprint sensor 46
 - configure 46
 - First-time setup 16
 - Fn key 23
- G**
 - Getting started 16
- H**
 - Hard disk:
 - restoring the contents 66

Hardware configuration 60
 HDMI port 53

I

Important notes 12
 Incorrect date/time 67
 Indicator
 Caps Lock 20
 F Lock 20
 Num Lock 20
 Scroll Lock 20
 Intel Thunderbolt 56

K

Key combinations 25
 Keyboard 22
 Background lighting 27
 cleaning 15

L

LCD screen
 cleaning 15
 decrease brightness 25
 difficult to read 67
 notes 29
 reflected glare 67
 remains blank 67
 LCD screen is too dark 67
 Life, battery 32
 Line feed 23
 Loudspeakers 36
 switch off 25
 switch on 25

M

Mains adapter
 connecting 17
 setting up 17
 Mechanical backup 47
 Memory card
 handling 35
 inserting 35
 removing 35
 Microphone 36
 Mobile operation 14
 Monitor
 connecting 54
 drifting display 68
 remains blank 68
 Monitor port
 see VGA connection socket 54

N

Notebook
 before you travel 14
 cannot be started 69
 cleaning 15
 stops working 69
 switching off 21
 transporting 14
 using 19
 Notebook, operation 19
 Notes 12
 cleaning 15
 disposal / recycling 75
 energy saving 13
 LCD screen 29
 Safety 12
 transport 14
 Num Lock
 indicator 20, 24
 Numeric keypad 22
 see Virtual numeric keypad 24

O

Operating system
 activating system protection 50
 cancel system protection 50
 protecting with password 50
 Operating system, restoring 66

P

Packaging 16
 Palm vein sensor 47
 Configuring 47
 Password
 changing 49
 entering 49
 removing 49
 Password protection 48
 Port Replicator
 Ports 42
 Status indicators 42
 Ports
 Port Replicator 42
 Power
 power consumption 33
 power-management features 33
 Power-on indicator 20
 Preparing for operation 17
 Printer does not print 69

- R**
Radio component:
 safety notes 13
Rechargeable battery 32
 see Battery 32
Return 23
- S**
Safety notes 12
SAR 75
Screen
 no screen display 68
Screen brightness
 decrease 25
 increase 25
Scroll Lock
 indicator 20
Security functions 46
 SystemLock 52
Security functions,
 SmartCard 52
Security Lock 47
Selecting a location 17
Servicing 59
Setup
 see BIOS Setup Utility 60
Shift 23
Shift + Tab 26
Shift key 23
Slot
 Memory cards 35
Standby indicator 20
Status indicator
 Port Replicator 42
Status indicators 19
Supervisor password
 changing 49
 entering 49
 removing 49
Switching on
 the notebook 21
Switching on for the first time 18
System configuration 60
System settings, BIOS Setup Utility 60
- T**
Tab key 23
TCO Certified 75
Technical data 73
 Mains adapter 74
 notebook 73
- The wireless connection to a network
 does not work 70
Time not correct 67
Tips 65
Toggle output screen 26
Touchpad 25, 28
 buttons 28
 cleaning 15
 dragging items 29
 executing commands 28
 moving the pointer 28
 selecting an item 28
 switch off 25
Touchpad buttons 25
TPM 51
Transport
 Transport damage 16
Transportation 14
Travel, notebook 14
Troubleshooting 65
Trusted Platform Module 51
- U**
USB charging function 57
USB ports 55
USB-Anschluss mit Aufladefunktion (USB
 Type-C) 56
User password
 changing 49
 entering 49
 removing 49
Using the Kensington Lock Cable 47
- V**
VGA connection socket 54
Virtual numeric keypad 24
Volume
 decrease 25
 increase 25
Volume control 36
- W**
Webcam 31
Windows key 23
Wireless components
 switch off 25
 switch on 25
Wireless LAN
 Switching the module off 39
 Switching the module on 39
Wireless LAN:
 safety notes 13

