



# DS-51TL Interactive Display

User Manual

# Interactive Display

---

© 2020 Hangzhou Hikvision Digital Technology Co., Ltd. All rights reserved.

This Manual is the property of Hangzhou Hikvision Digital Technology Co., Ltd. or its affiliates (hereinafter referred to as "Hikvision"), and it cannot be reproduced, changed, translated, or distributed, partially or wholly, by any means, without the prior written permission of Hikvision. Unless otherwise expressly stated herein, Hikvision does not make any warranties, guarantees or representations, express or implied, regarding to the Manual, any information contained herein.

## About this Manual

The Manual includes instructions for using and managing the Product. Pictures, charts, images and all other information hereinafter are for description and explanation only. The information contained in the Manual is subject to change, without notice, due to firmware updates or other reasons. Please find the latest version of this Manual at the Hikvision website (<https://www.hikvision.com/>).

Please use this Manual with the guidance and assistance of professionals trained in supporting the Product.

## Trademarks Acknowledgement

- **HIKVISION** and other Hikvision's trademarks and logos are the properties of Hikvision in various jurisdictions.
- Other trademarks and logos mentioned are the properties of their respective owners.
- **HDMI**™ The terms HDMI and HDMI High-Definition Multimedia Interface, and the HDMI Logo are trademarks or registered trademarks of HDMI Licensing Administrator, Inc. in the United States and other countries.

## LEGAL DISCLAIMER

TO THE MAXIMUM EXTENT PERMITTED BY APPLICABLE LAW, THIS MANUAL AND THE PRODUCT DESCRIBED, WITH ITS HARDWARE, SOFTWARE AND FIRMWARE, ARE PROVIDED "AS IS" AND "WITH ALL FAULTS AND ERRORS". HIKVISION MAKES NO WARRANTIES, EXPRESS OR IMPLIED, INCLUDING WITHOUT LIMITATION, MERCHANTABILITY, SATISFACTORY QUALITY, OR FITNESS FOR A PARTICULAR PURPOSE. THE USE OF THE PRODUCT BY YOU IS AT YOUR OWN RISK. IN NO EVENT WILL HIKVISION BE LIABLE TO YOU FOR ANY SPECIAL, CONSEQUENTIAL, INCIDENTAL, OR INDIRECT DAMAGES, INCLUDING, AMONG OTHERS, DAMAGES FOR LOSS OF BUSINESS PROFITS, BUSINESS INTERRUPTION, OR LOSS OF DATA, CORRUPTION OF SYSTEMS, OR LOSS OF DOCUMENTATION, WHETHER BASED ON BREACH OF CONTRACT, TORT (INCLUDING NEGLIGENCE), PRODUCT LIABILITY, OR OTHERWISE, IN CONNECTION WITH THE USE OF THE PRODUCT, EVEN IF HIKVISION HAS BEEN ADVISED OF THE POSSIBILITY OF SUCH DAMAGES OR LOSS.

YOU ACKNOWLEDGE THAT THE NATURE OF INTERNET PROVIDES FOR INHERENT SECURITY RISKS, AND HIKVISION SHALL NOT TAKE ANY RESPONSIBILITIES FOR ABNORMAL OPERATION, PRIVACY LEAKAGE OR OTHER DAMAGES RESULTING FROM CYBER-ATTACK, HACKER ATTACK, VIRUS INSPECTION, OR OTHER INTERNET SECURITY RISKS; HOWEVER, HIKVISION WILL PROVIDE TIMELY TECHNICAL SUPPORT IF REQUIRED.

YOU AGREE TO USE THIS PRODUCT IN COMPLIANCE WITH ALL APPLICABLE LAWS, AND YOU ARE SOLELY RESPONSIBLE FOR ENSURING THAT YOUR USE CONFORMS TO THE APPLICABLE LAW. ESPECIALLY, YOU ARE RESPONSIBLE, FOR USING THIS PRODUCT IN A MANNER THAT DOES NOT INFRINGE ON THE RIGHTS OF THIRD PARTIES, INCLUDING WITHOUT LIMITATION, RIGHTS OF PUBLICITY, INTELLECTUAL PROPERTY RIGHTS, OR DATA PROTECTION AND OTHER PRIVACY RIGHTS. YOU SHALL NOT USE THIS PRODUCT FOR ANY PROHIBITED END-USES, INCLUDING THE DEVELOPMENT OR PRODUCTION OF WEAPONS OF MASS DESTRUCTION, THE DEVELOPMENT OR PRODUCTION OF CHEMICAL OR BIOLOGICAL WEAPONS, ANY ACTIVITIES IN THE CONTEXT RELATED TO ANY NUCLEAR EXPLOSIVE OR UNSAFE NUCLEAR FUEL-CYCLE, OR IN SUPPORT OF HUMAN RIGHTS ABUSES.

IN THE EVENT OF ANY CONFLICTS BETWEEN THIS MANUAL AND THE APPLICABLE LAW, THE LATER PREVAILS.

## Regulatory Information

### FCC Information

Please take attention that changes or modification not expressly approved by the party responsible for compliance could void the user's authority to operate the equipment.

**FCC compliance:** This equipment has been tested and found to comply with the limits for a Class A digital device, pursuant to part 15 of the FCC Rules. These limits are designed to provide reasonable protection against harmful interference when the equipment is operated in a commercial environment. This equipment generates, uses, and can radiate radio frequency energy and, if not installed and used in accordance with the instruction manual, may cause harmful interference to radio communications. Operation of this equipment in a residential area is likely to cause harmful interference in which case the user will be required to correct the interference at his own expense.

### FCC Conditions

This device complies with part 15 of the FCC Rules. Operation is subject to the following two conditions:

1. This device may not cause harmful interference.
2. This device must accept any interference received, including interference that may cause undesired operation.

### EU Conformity Statement

 This product and - if applicable - the supplied accessories too are marked with "CE" and comply therefore with the applicable harmonized European standards listed under the EMC Directive 2014/30/EU, the LVD Directive 2014/35/EU, the RoHS Directive 2011/65/EU.

 2012/19/EU (WEEE directive): Products marked with this symbol cannot be disposed of as unsorted municipal waste in the European Union. For proper recycling, return this product to your local supplier upon the purchase of equivalent new equipment, or dispose of it at designated collection points. For more information see: [www.recyclethis.info](http://www.recyclethis.info)

 2006/66/EC (battery directive): This product contains a battery that cannot be disposed of as unsorted municipal waste in the European Union. See the product documentation for specific battery information. The battery is marked with this symbol, which may include lettering to indicate cadmium (Cd), lead (Pb), or mercury (Hg). For proper recycling, return the battery to your supplier or to a designated collection point. For more information see: [www.recyclethis.info](http://www.recyclethis.info)

### Industry Canada ICES-003 Compliance



This device meets the CAN ICES-3 (A)/NMB-3(A) standards requirements.

## Applicable Models

This manual is applicable to DS-51TL/P Series Interactive Display (hereafter referred to the device).

## Symbol Conventions

The symbols that may be found in this document are defined as follows.

Symbol	Description
 <b>NOTE</b>	Provides additional information to emphasize or supplement important points of the main text.
 <b>WARNING</b>	Indicates a potentially hazardous situation, which if not avoided, could result in equipment damage, data loss, performance degradation, or unexpected results.
 <b>DANGER</b>	Indicates a hazard with a high level of risk, which if not avoided, will result in death or serious injury.

### Safety Instructions

- Proper configuration of all passwords and other security settings is the responsibility of the installer and/or end-user.
- In the use of the product, you must be in strict compliance with the electrical safety regulations of the nation and region. Please refer to technical specifications for detailed information.
- Input voltage should meet both the SELV (Safety Extra Low Voltage) and the Limited Power Source with 100~240 VAC or 12 VDC according to the IEC60950-1 standard. Please refer to technical specifications for detailed information.
- Do not connect several devices to one power adapter as adapter overload may cause overheating or a fire hazard.
- Please make sure that the plug is firmly connected to the power socket.
- If smoke, odor or noise rise from the device, turn off the power at once and unplug the power cable, and then please contact the service center.

### Preventive and Cautionary Tips

Before connecting and operating your device, please be advised of the following tips:

- Ensure unit is installed in a well-ventilated, dust-free environment.
- Unit is designed for indoor use only.
- Keep all liquids away from the device.
- Ensure environmental conditions meet factory specifications.
- Ensure unit is properly secured to a rack or shelf. Major shocks or jolts to the unit as a result of dropping it may cause damage to the sensitive electronics within the unit.
- Use the device in conjunction with an UPS if possible.
- Power down the unit before connecting and disconnecting accessories and peripherals.
- Improper use or replacement of the battery may result in hazard of explosion. Replace with the same or equivalent type only. Dispose of used batteries according to the instructions provided by the battery manufacturer.

# TABLE OF CONTENTS

<b>Chapter 1 Important Notice.....</b>	<b>8</b>
1.1 Safety Instructions .....	8
1.2 Preventive and Cautionary Tips .....	9
<b>Chapter 2 Operation and Maintenance Precautions .....</b>	<b>11</b>
2.1 Use of Power Cable .....	11
2.2 Cleaning and Maintenance .....	12
<b>Chapter 3 Connections and Installation .....</b>	<b>13</b>
3.1 Precautions for Installation .....	13
3.2 Control Panel Buttons .....	13
3.3 Interfaces .....	15
3.4 Connection to Personal Computer (PC).....	18
3.4.1 Connect to PC by VGA.....	19
3.4.2 Connect to PC by HDMI.....	19
3.5 Computer Installation .....	20
3.6 Remote Control.....	21
3.7 Mounting .....	22
Wall Mounting .....	22
Mobile Mounting.....	23
<b>Chapter 4 Basic Operation .....</b>	<b>24</b>
4.1 Startup & Shutdown .....	24
4.1.1 Startup.....	24
4.1.2 Eco Mode.....	24
4.1.3 Standby .....	24
4.1.4 Shutdown .....	25
<b>Chapter 5 Sidebar Operations .....</b>	<b>26</b>
5.1 Basic Operations .....	26
5.2 Annotating .....	27
5.3 Tool.....	29
5.3.1 Screenshot.....	29
5.3.2 Freeze Screen .....	30
5.4 Control Center .....	31
5.4.1 Live View.....	31
5.4.2 Switch Channel.....	32
5.4.3 Display Parameter.....	33
5.4.4 Sound Mode.....	34
5.4.5 Light Sensitive Settings .....	34
5.4.6 VGA Signal Control.....	35
<b>Chapter 6 Configuration.....</b>	<b>36</b>
6.1 Network .....	36
6.1.1 Set Wired Network.....	36
6.1.2 Set Wireless Network (Optional) .....	37

# Interactive Display

---

6.1.3 Set Hotspot .....	38
6.2 Display.....	38
6.3 Audio .....	40
6.4 Language and Input Method .....	41
6.5 Date and Time.....	41
6.6 Applicaion Mangagement .....	41
6.7 Temperature Control .....	42
6.8 Advanced Settings .....	43
6.8.1 Device Name .....	43
6.8.2 Input Source Settings .....	44
6.8.3 Startup/Shutdown Settings.....	44
6.8.4 Wakeup Settings.....	44
6.8.5 EDID Version.....	44
6.8.6 USB Settings.....	44
6.8.7 Boot Animation Settings .....	45
6.8.8 PC One-Touch Restore .....	45
6.8.9 Floating Ball Settings.....	45
6.8.10 Entity Key Settings .....	45
6.8.11 Restore to Factory Default .....	46
6.9 Security Settings .....	46
6.9.1 Lock Screen Password .....	46
6.9.2 USB Key.....	46
6.10 View System Info .....	47
<b>Chapter 7 Smart Applications .....</b>	<b>48</b>
7.1 File Management .....	48
7.2 Browser .....	49
7.3 Roaming Buttons .....	49
<b>Appendix 1 Parameter Description .....</b>	<b>51</b>
<b>Appendix 2 Troubleshooting .....</b>	<b>53</b>

# Chapter 1 Important Notice

## 1.1 Safety Instructions

For safety concerns, the device has been strictly tested before shipment. However, incorrect installation or usage may lead to hazardous results such as electric shock and fire. To ensure the service life and best performance of the device, please read the notice and plate signs carefully and follow the safety instructions. Keep this guide properly for later use.

---



### WARNING

- To reduce the risk of fire or electric shock, please do not expose the device to rain or humid environment.
- Electric discharge may last for a short period of time after the power is shut down. Please wait for two minutes after the power shut down to operate the device.
- To avoid the risk of electric shock, please do not operate when the power is on.
- Only use the original power cable delivered with the device. Contact authorized dealer to purchase power cable with same specifications.
- Please do not frequently plug and unplug the power cable when the power is on.

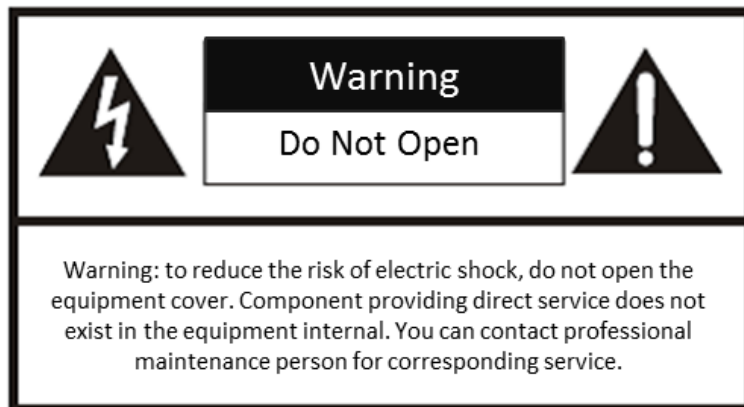

### WARNING

The device may generate radio interference in indoor environment. Necessary precautions may be required.

---



### 1.2 Preventive and Cautionary Tips

---



#### **WARNING**

- Only use power supply of 100-240 VAC, 50 Hz.
- Only connect/disconnect the recording and playback box and computer box when the power is shut down.
- Do not place the device in:
  - Direct strong lighted, humid, over-heated/cooled, dusty environment.
  - An environment where flammable and explosive matter are stored and used.
  - An environment of flammable and corrosive gas.
  - Places like bathroom and kitchen.
- Do not use damaged or unfit power socket. Make sure the plug and the socket are in good contact.
- Do not let dust or metal attachment adhere to the power plug and socket.
- Do not damage the power cable:
  - Do not modify the cable in any form.
  - Do not place heavy matter on the cable.
  - Keep the power away from heat.
  - Do not disconnect the power plug by pulling the cable.
- Do not parallel multiple plugs in one socket to avoid fire risk caused by power overload.
- Do not approach the device with fire (e.g. a lit candle) to avoid the risk of fire or electric shock.
- Do not place anything containing liquid on the device to avoid the risk of fire or electric shock caused by liquid-splashing.
- Do not let sharp or metal articles and liquids contact the signal connectors or heat dissipation holes to avoid short circuit, product damage and electric shock.
- The hole on the shell is designed for heat dissipation. Do not block the hole when installing the device.
- Do not touch the device with a wet finger to avoid risk of electric shock.
- Do not operate the device in heavy rain, especially lightning weather to avoid electric shock. Contact professional technicians for repairing.
- Do not use chemical reagent to clean the device. Do not let anything into the device.

## Interactive Display

---



### **DANGER**

- Do not let children climb onto the device.
- Keep small accessories away from children.
- If the device will not be used for a long time. Shut down the power of the device and disconnect the power supply.
- Disconnect the power plug before cleaning the device. Use soft cloth for cleaning.
- Contact service center for internal cleaning.
- Make sure the power supply matches the requirements specified by the plate on the shell.
- Disconnect power plug and antenna in thunderstorm weather.
- Keep the power cable away from physical or mechanical damage.
- Make sure the power supply is grounded.
- After the environment temperature changed from low to high. Wait for a period of time before powering on the device.
- Make sure the environment is dry and well-ventilated, and heat dissipation is good.
- Turn down the volume when using earphones.



### **NOTE**

Please read the warning information on device and manual carefully.

## Chapter 2 Operation and Maintenance Precautions

The LCD panel on the device is made by high-precision technology. However, tiny spots on the screen that are always or never lit may be observed, or when observed from side, the color may and brightness may appear to be uneven. Yet the above phenomena are common among LCD displays rather than faults and will not affect the performance of the device.

- The device and its accessories are subject to change without prior notice.
- The fragile materials of the display are vulnerable to falling and impact. Please hold with care.
- Improper operations during debugging and operating may cause damage to the device.
- Scratching or knocking the device with hard objects is strictly forbidden. Do not frequently turn on/off the power of the device when operating to avoid the risk of damage and faults.
- If smoke, odor or noise rise from the device, turn off the power at once and unplug the power cable, and then please contact the service center.
- When installing, clean the surface and rear of the display to ensure the performance.
- Do not fix the device too tight, otherwise the display may be bent.
- Our company is not responsible for any fault caused by third-party when operating the device and other failure or damage incurred.
- Do not operate the device in an environment of dust, high humidity, or oil and steam contacting to avoid the risk of fire and damage.
- Do not place the device on unstable or unsafe surface. Avoid strong impact, vibration or vibration.
- Do not operate the device near heating device or place of high temperature to avoid the risk of fire.
- Ensure the accessories are complete before installing the device. Otherwise contact your dealer.

### 2.1 Use of Power Cable

- If the power cable is damaged or failed, contact service center. Make sure the power supply is properly grounded and matches the requirements specified by the plate on the shell.
- Do not expose the device to rain or humid environment. Disconnect power plug and antenna in thunderstorm weather.
- If the device will not be used for a long time. Shut down the power of the device and disconnect the power supply.
- Electric discharge may last for a short period of time after the power is shut down. Please wait for two minutes after the power shut down to operate the device.

- Only use the original power cable delivered with the device. Contact authorized dealer to purchase power cable with same specifications.

## 2.2 Cleaning and Maintenance

- The hole on the rear shell is for heat dissipation. Do not pour or spray liquid to the rear shell or use wet cloth for cleaning.
- Disconnect the power plug before cleaning.
- Use a dry, soft and dust-free cloth to clean the device.
- Contact service center for internal cleaning.
- Proper maintenance can avoid certain early-stage failures.
- Clean the device on a regular basis to make the device look new.

## Chapter 3 Connections and Installation

### 3.1 Precautions for Installation

- Install the device near an available AC power socket for easy power connection.
- For safety, only use the wall mount or base that is suitable for the device.
- Place the device on a stable surface or fix the device steadily on the wall.
- Contact professional staff for wall mounting.
- Do not place the device near mechanical vibration source.
- Do not place the device in an environment where insects have easy access.
- Do not let the device face the air conditioner directly to avoid condensing.
- Do not place the device in strong electromagnetic field to avoid radio interference.

### 3.2 Control Panel Buttons.

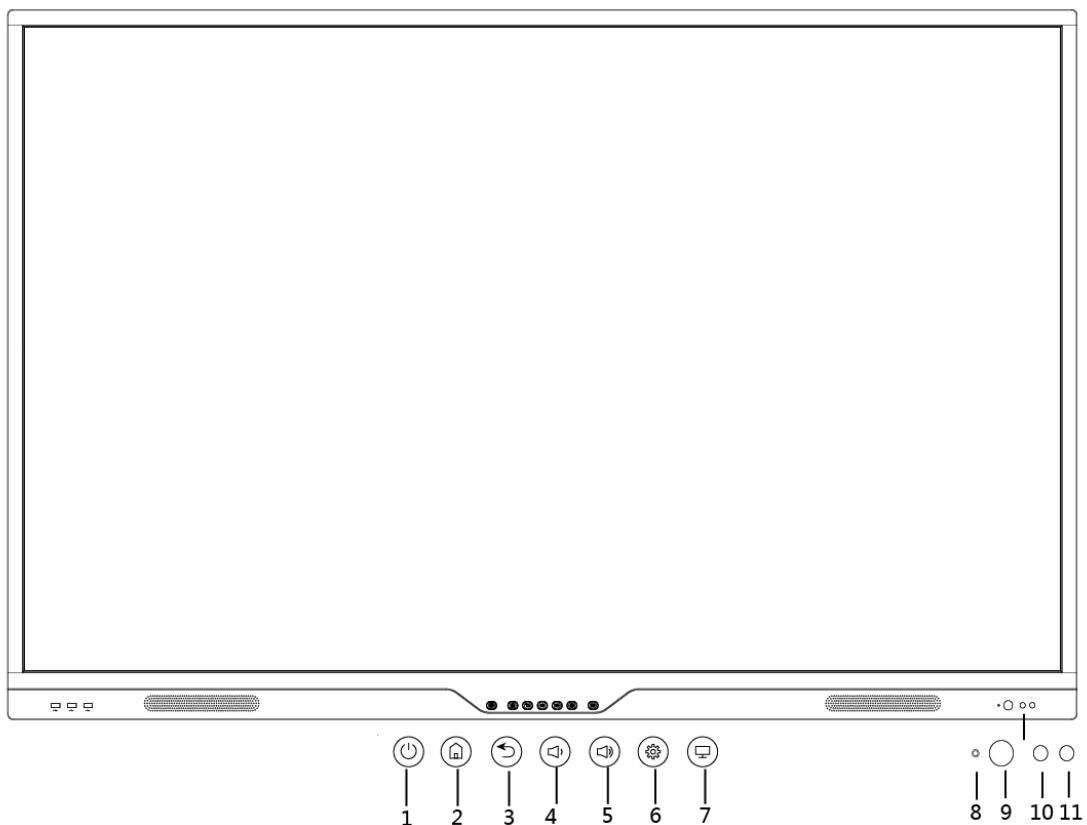













Figure 3-1 Control Panel Buttons

## Interactive Display

---

Table 3-1 Description of Control Panel Buttons

No.	Button	Description
1		Multi-functional button
2		Android home screen
3		Back
4		Volume-
5		Volume+
6		Short press to enter the main menu. Long press to lock the screen.
7		The entity key,. Its default function is start up/shut down Windows, you can customize its function.
8		Infrared receiver and power indicator.
9		Light sensor
10		Indicator of Android system <ul style="list-style-type: none"> <li>● Flashing(blue):The system is starting up.</li> <li>● Solid(blue): The system started normally.</li> <li>● Solid(red):The system is standby.</li> </ul>
11		Indicator of Windows power, it is green when windows start up.

### 3.3 Interfaces

#### Front and Back Panel

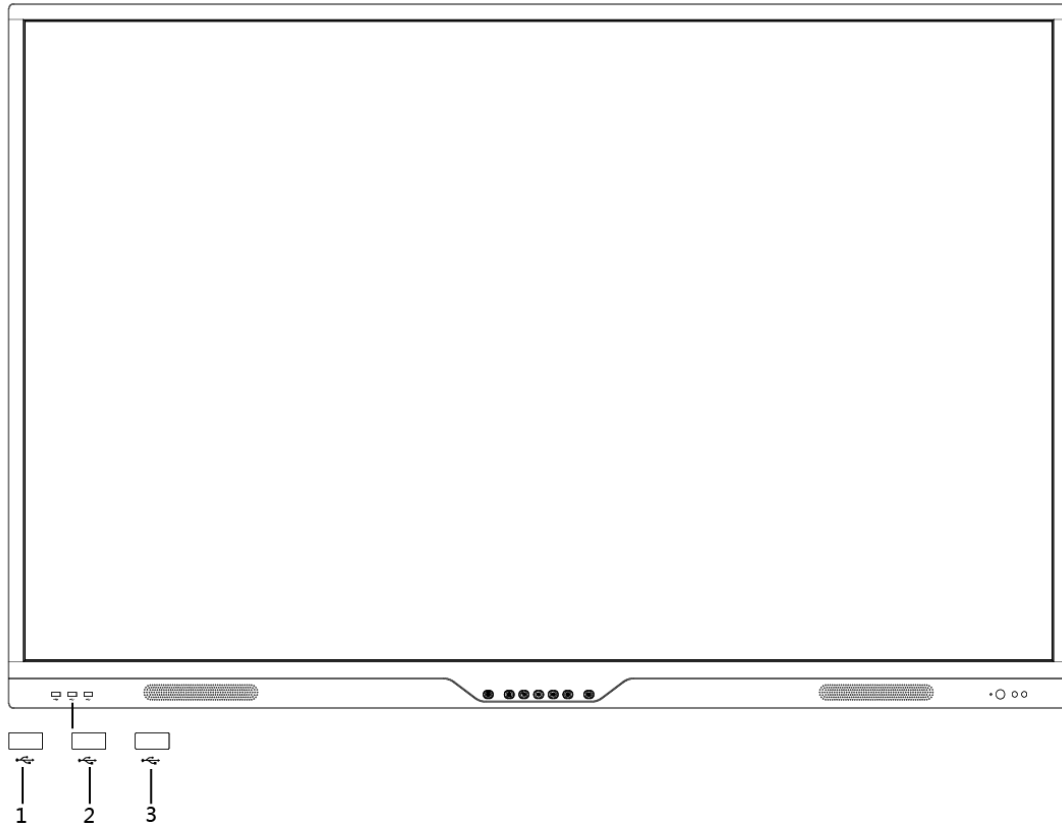

Figure 3-2 Front Panel

# Interactive Display

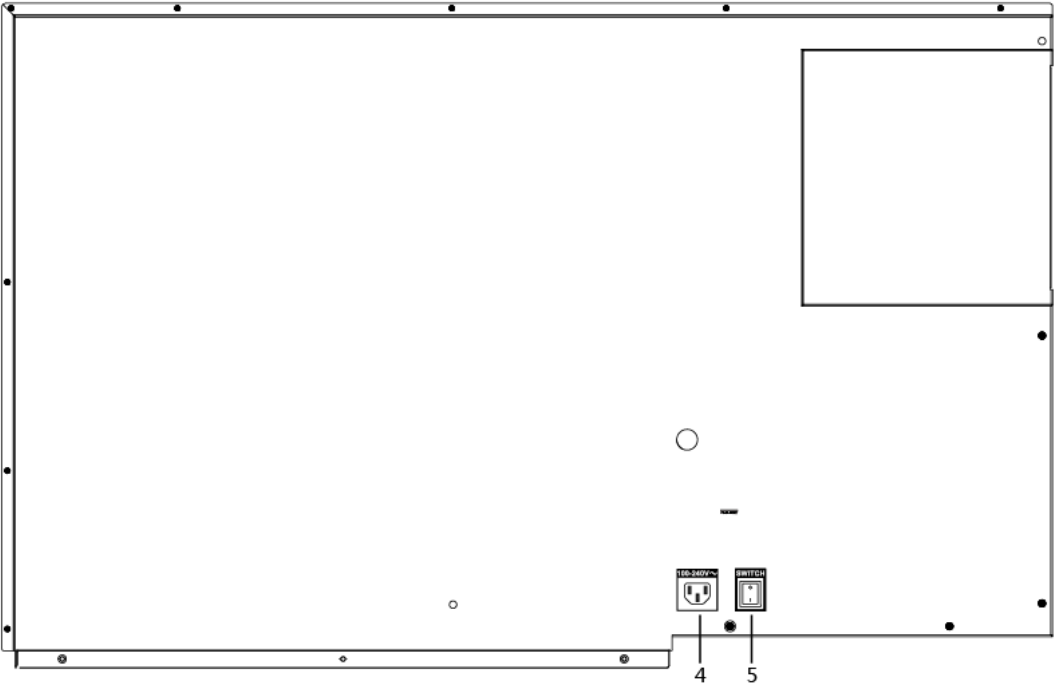

Figure 3-3 Back Panel

Table 3-2 Panel Description

No	Name	Function Description
1	USB	Windows/Android USB
2	USB	Windows/Android USB
3	USB	Windows/Android USB
4	100-240V~	Power supply
5	SWITCH	Power switch

## Interfaces on Side Panel

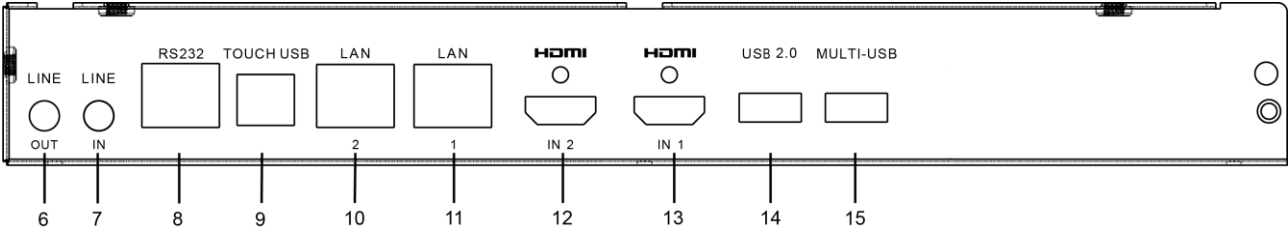

Figure 3-4 Interfaces on Side Panel



## Interactive Display

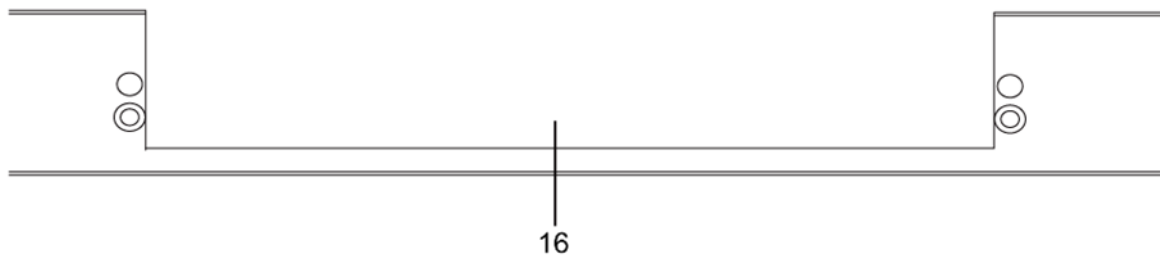

Figure 3-5 Computer Interface

Table 3-3 Panel Description

No.	Name	Function Description
6	LINE OUT	Audio output interface
7	LINE IN	Audio input interface
8	RS-232	RS-232 Serial interface
9	TOUCH USB	Touch control USB interface
10	LAN2	Network interface
11	LAN1	Network interface
12	HDMI IN2	HDMI2 input interface
13	HDMI IN1	HDMI1 input interface
14	USB 2.0	USB 2.0 interface
15	MULTI-USB	Multi-functional USB interface
16	PC Interface	Mounting interface for built-in PC

### Bottom Interfaces

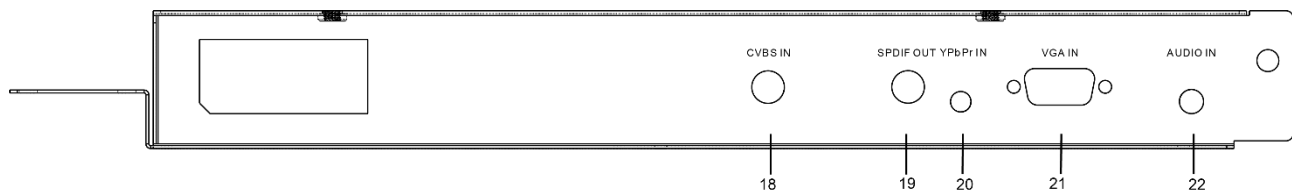

Figure 3-6 Bottom Interfaces

## Interactive Display

---

Table 3-4 Panel Description

No.	Name	Function Description
18	CVBS IN	CVBS signal input interface
19	SPDIF OUT	Digital multimedia speaker interface
20	YPbPr IN	YPbPr signal input interface
21	VGA IN	VGA input interface
22	AUDIO IN	Audio input interface

 **NOTE**

- The appearance of different models under the same series may vary and is subject to change.
- Connecting both VGA and YPbPr signal sources at the same time is not allowed. Only one of them can be connected.

### 3.4 Connection to Personal Computer (PC)

---

 **WARNING**

The device must be disconnected from power supply before installation and disassembly.

---

## 3.4.1 Connect to PC by VGA

### NOTE

- USB cable is not contained in the product. Please purchase USB cable with type A connector to type B connector.
- Connect audio cable to **LINE IN**.

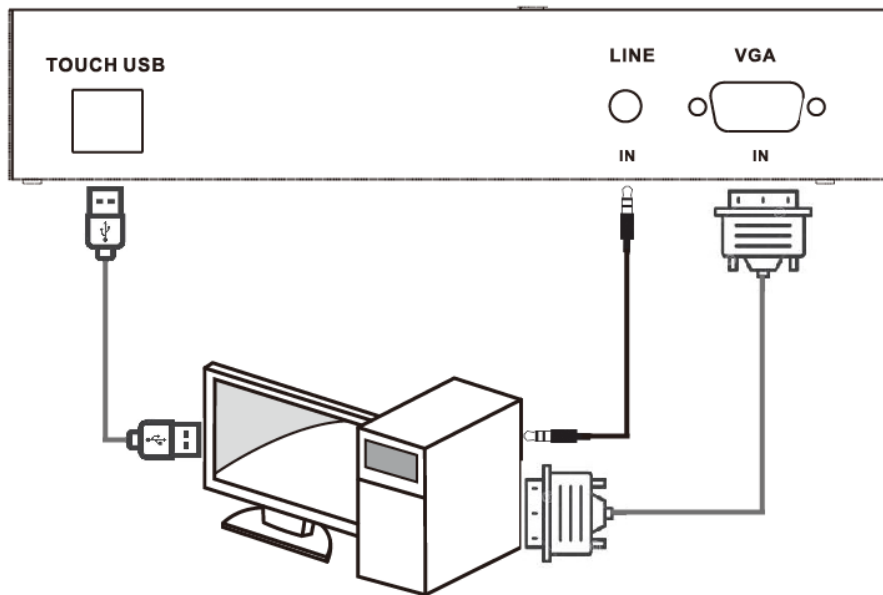

Figure 3-7 VGA Connection

## 3.4.2 Connect to PC by HDMI

### NOTE

- USB cable is not contained in the product. Please purchase USB cable with type A connector to type B connector.

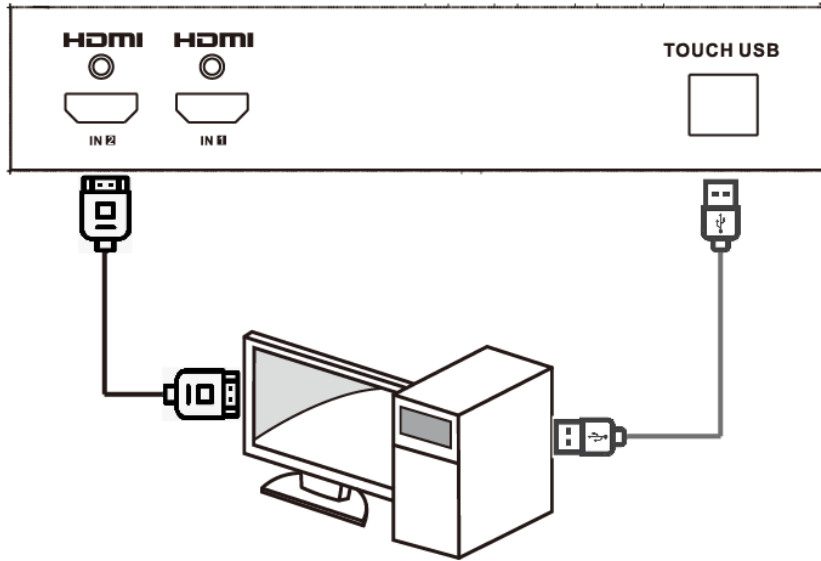

Figure 3-8 HDMI Connection

When PC signals are connected to the interfaces on the front panel of the device, the TOUCH-USB refers to the one on the front panel. The same applies to the rear panel.

## 3.5 Computer Installation

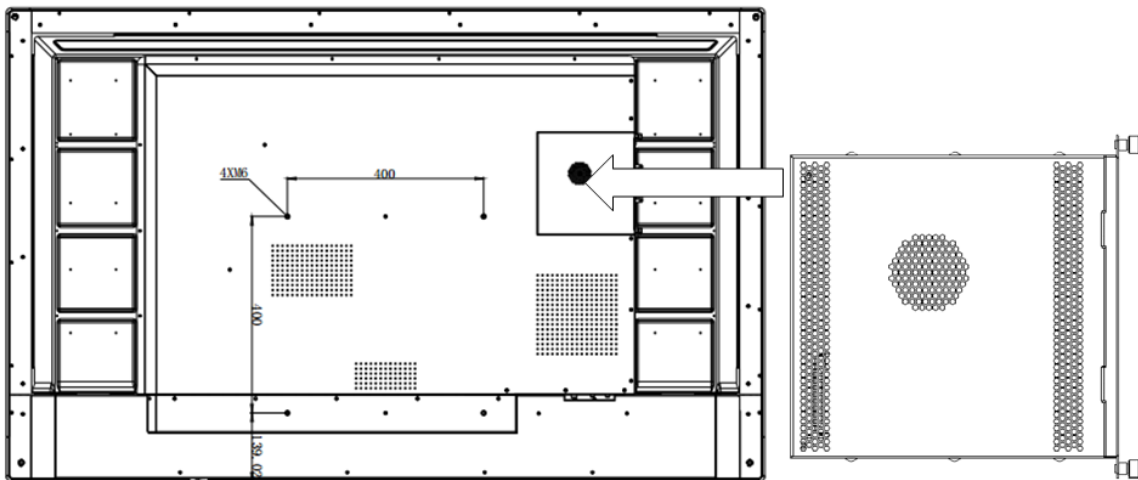

Figure 3-9 Computer Installation

The computer box is installed at the side slot of the device. When installing the box, make sure its ventilation hole is facing the same direction with the rear panel as shown above. Fasten the two side screws to fix the box into position.

### WARNING

To avoid potential device damage, the computer box can be removed only after the device is disconnected from power.

### 3.6 Remote Control

To replace the batteries: take off the battery case cover, put in two AAA batteries and make sure the positive and negative electrodes are properly matched.

Table 3-5 Description of Remote Control Buttons



Figure 3-10 Remote Controller

Button Name	Function Description
	Standby and startup
	Audio on/off
	Enter start menu
Space	Space
Alt + Tab	Switch window for external Windows input
Alt + F4	Close window for external Windows input
0 - 9	Input numbers
W-Board	Run Android whiteboard
Capture	Screenshot
PgUp	Previous page for powerpoint
PgDn	Next page for powerpoint
Red button	Run status bar
Green button	Extended function
Yellow button	Extended function
Blue button	Extended function
Home	Android home screen
	Backspace
	Navigation
Menu	OSD menu; switch to signal source
Back	Back
CH+/-	Select ATV/DTV, channel
VOL+/-	Adjust volume
ECO	Turn on/off the screen backlight
LOCK	Lock/unlock screen
F1 – F12	F1 - F12 in Windows



The appearance of the remote control is subject to change.

---



When using the remote control, aim the device at the sensor receiver. Any obstacle in between may disturb normal operation.

Keep the control from strong vibration. Avoid direct sunlight when setting or placing the control, otherwise it may be deformed.

The control may malfunction under direct or strong light condition. In this case, change the operating direction or move closer to the sensor receiver.

Low battery reduces controlling distance, and new battery should be replaced. If the control will not be used for a long time, take out the battery to avoid weeping which may damage the control.

Do not use batteries of different types together or mix new and old batteries. Always change the batteries in pair.

Do not recharge, short-circuit, heat or disassemble batteries, or throw batteries into fire. Dispose of batteries according to environmental regulations. Do not expose batteries to overheated environment.

---

## 3.7 Mounting

### Wall Mounting

The device can be installed using wall mount or mobile mount, as shown below.

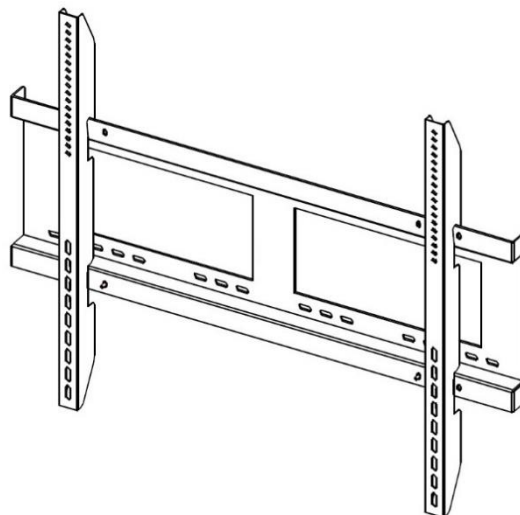

Figure 3-11 Wall Mount Front View

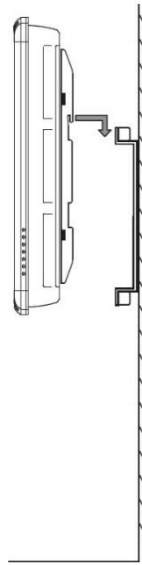

Figure 3-12 Wall Mount Side View

 **NOTE**

The wall mount is mobile horizontally. Please leave enough room at side for maintenance service.

## Mobile Mounting

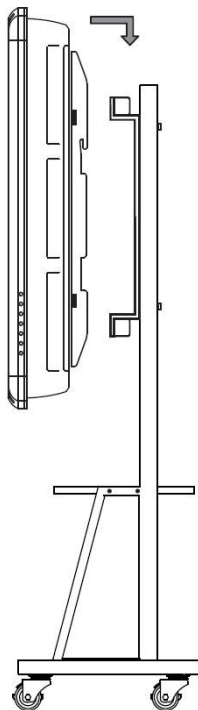

Figure 3-13 Mobile Mount

# Chapter 4 Basic Operation

## 4.1 Startup & Shutdown

### 4.1.1 Startup

Connect the device to power supply and turn on the power switch. The power indicator on the front panel will turn red. Then press the multi-function power button on the front panel, the power indicator will turn blue.

When the device is powered on, the multi-function power button on the front panel can control the internal PC to startup or shutdown.



**NOTE**

If the startup mode is set as Power On and Start, then the device will start up directly after turning on the power switch, and the power indicator will turn blue. See 6.8.3 Startup/Shutdown Settings for details.

### 4.1.2 Eco Mode

The Eco function reduces the power consumption of the device by controlling the electric current used by the panel. Enabling the Eco will reduce the screen brightness to save power, plus the screen brightness automatically transitions fluidly-reducing energy use even more.

Enable the Eco mode through the following two ways.

- Press the multi-function power button on the front panel.
- Press the ECO button of the remote control.

Repeat the same operation again or touch anywhere on the screen to turn on the screen.

### 4.1.3 Standby

Switch the device to the standby mode in the following two ways:

- Long press the multi-function power button on the front panel.
- Press the power button of the remote control



**NOTE**

When the device is installed with a running computer box, the system will prompt you to shut down the unit first.



**Result:** When the device is switched to standby, the power indicator on the panel turns from blue to red.



Press the power button on the front panel or remote control to wake up the device.

### 4.1.4 Shutdown

If the device is not installed with computer box, directly switch off the power to shut down the device.

If the device is installed with computer box. Press and hold the multi-function power button on the front panel to shut down the computer box. Then switch off the power to shut down the device.



Switching off the power of the device directly leads to force shutdown of the computer box. Next time when the device starts up, the Windows may enter error recovery mode and the touch screen will be disabled. Please access mouse and keyboard.

# Chapter 5 Sidebar Operations

 **NOTE**

Software interfaces and functions may vary with different device models. All pictures in this manual are for illustration purpose only.



Turn on the device to go to the main page. Tap  or  to show the sidebar.









Figure 5-1 Main Page

## 5.1 Basic Operations

Functions of the shortcut icons in sidebar are described below.

Table 5-1 Shortcut Icon Description

Icon	Function	Icon	Function
	Return to the previous page.		Display all the windows.
	Return to the main page.		Enable the annotating mode.
	Select shortcut tools.		Open the control center.

## 5.2 Annotating









Tap  to enable annotating. You can add annotations anywhere on the page by touching and moving on the screen. The annotation bar pops up on the side of the screen.



Figure 5-2 Annotation Bar

## Interactive Display

Table 5-2 Annotation Bar Descriptions

Icon	Description	Icon	Description
	Select the pen color and hue range.		Select pen thickness. Enable angled stroke or not.
	Delete the annotation.		Generate QR code to share the annotation. Other devices can scan the QR code to download the annotation. <ul style="list-style-type: none"> <li>● When the LAN download is enabled, annotation can only be shared in LAN.</li> <li>● When the LAN download is disabled, public network will be used as the prior way to share annotation. If public network is not available, then it will use LAN to share annotation.</li> </ul>
	Save the annotation page.		Exit annotating.
	Enable/Disable the LAN annotation sharing.		

## 5.3 Tool

Select Tools in the sidebar.

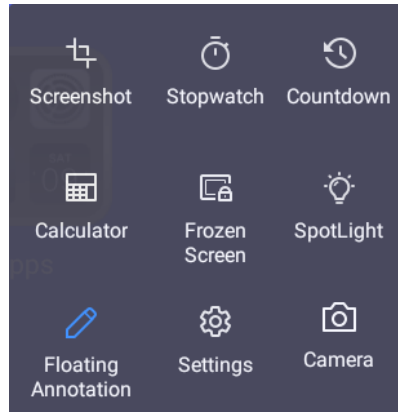



Figure 5-3 Tools

Table 5-3 Tool Description

Icon	Description	Icon	Description
	Capture a screenshot of the current page.		Freeze the current screen image.
	Stopwatch.		Spotlight. It can light up a desired circular region as your desire.
	Countdown.		Enable floating annotations.
	Calculator.		Go to settings.
	Camera.		

### 5.3.1 Screenshot

Tap , then a capture area pops up on the current page. Adjust the area by tapping and dragging the four corners. The screenshot toolbar pops up on the lower right corner of the area.



Figure 5-4 Screenshot Toolbar

Table 5-4 Screenshot Toolbar Descriptions

Icon	Description
	Capture the whole page.
	Save the screenshot in the capture area.
	Exit screenshot.

## 5.3.2 Freeze Screen







Tap , then the current image will be frozen. You can zoom in to view the details of the image, add annotations on the image, or move the frozen image.





Figure 5-5 Toolbar

Table 5-5 Figure 6-5 Frozen Toolbar Descriptions

Icon	Description	Icon	Description
	Zoom in the frozen image.		Zoom out the frozen image.
	Display the frozen image in full screen.		Save the frozen image.
	Call the annotation tool, and add annotations on the frozen image.		Exit.

## 5.4 Control Center

There are multiple ways to enter the control center.

- Go to the sidebar and tap .
- Press  on the panel.
- Press **MENU** on the remote control.

In the control center, you can view live image from other signal sources, switch channels, adjust brightness and volume, etc.

### 5.4.1 Live View



You can view live image from other connected signal sources under Android channel.

**Step 1** Tap Live View

**Step 2** Select a signal source. After a signal source is selected, the live view window on the right will display the waiting image.

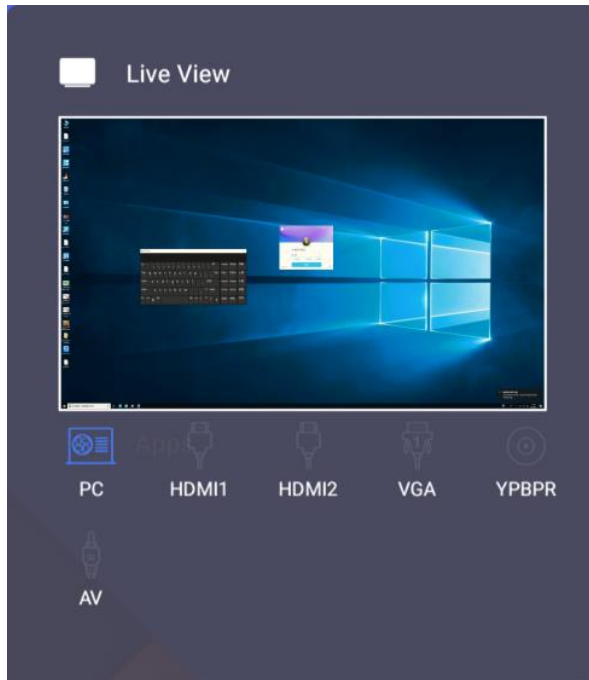

Figure 5-6 Live View

Step 3 (Optional) Tap the live view window, the device will switch to live view signal source.

### 5.4.2 Switch Channel

Tap Channel Switch, then select the available signal source (you can use direction buttons on remote control, or tap the screen to select the desired signal source).



Figure 5-7 Switching Channel

Figure 5-8

Name	Description	Name	Description
Android	Android operation system.	PC	Build-in computer signal source.
VGA	VGA signal source.	HDMI 1	HDMI signal source.
HDMI 2	HDMI signal source.	YPBPR	YPBPR signal source.
AV	AV signal source.	ATV	Analog TV signal source.



Name	Description	Name	Description
DTV	Digital TV signal source.		

### 5.4.3 Display Parameter



**NOTE**

When the channel is not an Android channel, display parameters will be configurable.

Use direction buttons on remote control, or tap the screen to enter the display parameter settings interface.

- Tap **Picture Mode** to select the picture display mode, four types are available, including **Standard**, **Game**, **Vivid**, and **User**.
- When **User** mode is selected, you can manually adjust contrast, brightness, acutance, and saturation (when **Zoom Mode** is **P2P**, only contrast and brightness are adjustable).
- Tap **Color Temperature**, three types of mode are available, including **Standard**, **Cold**, and **Warm**.
- Tap **Zoom Mode**, multiple types are available, including 16 : 9, 4 :3, etc.

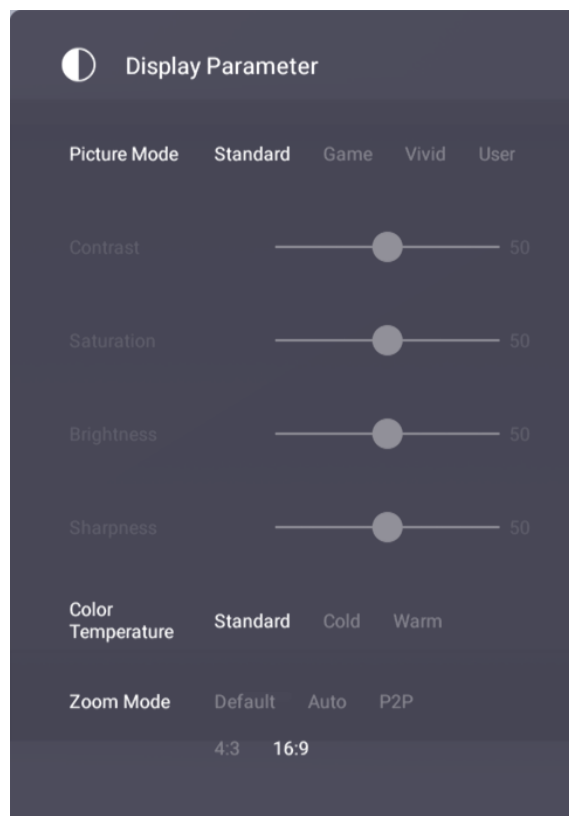
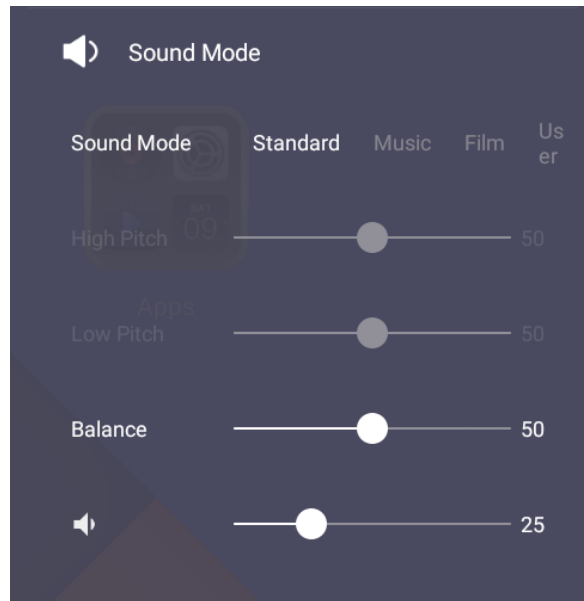

Figure 5-9 5.4.3 Display Parameter

### 5.4.4 Sound Mode

Use direction buttons on remote control, or tap the screen to enter the interface.

- Tap **Sound Mode**, four modes are available, including **Standard**, **Music**, **Film**, and **User**.
- After the mode is selected, you can adjust the volume and balance.
- When **Sound Mode** is selected as **User**, you can manually adjust its parameters, like **High Pitch**, **Low Pitch**, etc.



### 5.4.5 Light Sensitive Settings

Use direction buttons on remote control, or tap the screen to enter the interface.

- You can manually adjust the backlight.
- Enable **Light Sensitive**, the device will adjust the screen backlight according to the environment brightness.

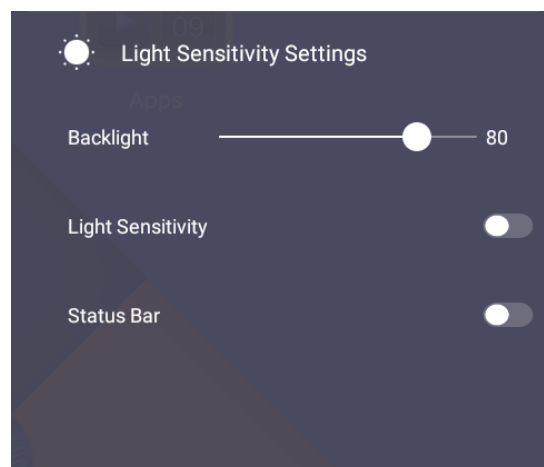

Figure 5-10 5.4.5 Light Sensitive Settings

- Enable Status Bar, then device temperature, CPU usage and memory usage will be displayed at the upper-right corner.

### 5.4.6 VGA Signal Control



NOTE

You can set VGA parameters when the channel is VGA.

Use direction buttons on remote control, or tap the screen to enter the interface of **Others**.

- When the signal source is VGA, you can manually adjust parameters like **Clock**, **Phase**, etc.
- After tapping **AUTO ADJUST**, the device will automatically adjust its parameters.

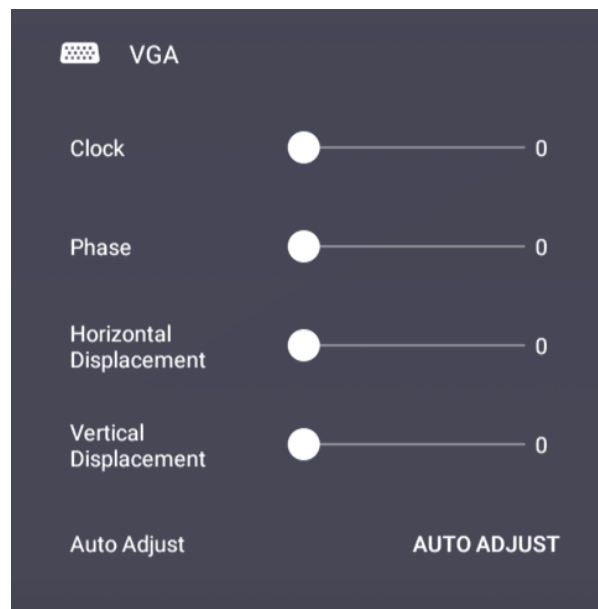



Figure 5-11 VGA

# Chapter 6 Configuration

After device starts up, press  at the control panel (or press **Menu** in remote control, or hold the infrared in screen bottom) to pop up menu on the screen.

By operating the menus, you can switch input signal sources, set display and sound parameters, search channels, and etc.

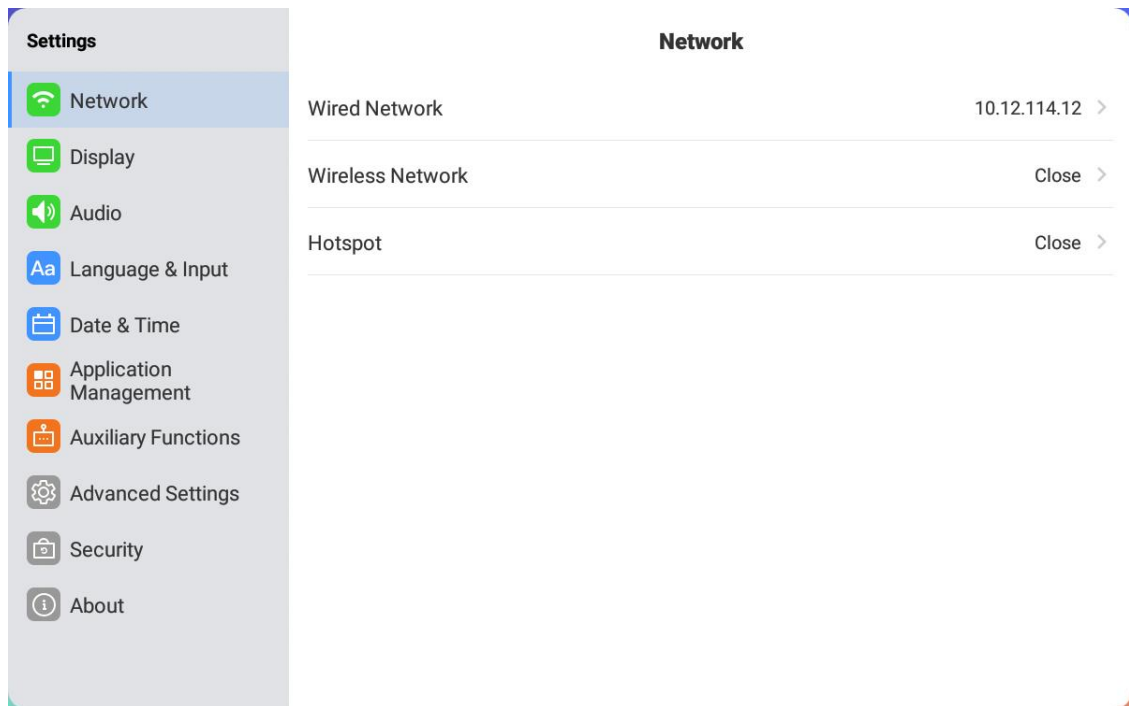

Figure 6-1 Menu

## 6.1 Network

From the **Settings** menu, you can configure the network, Bluetooth, hotspot, display, language, and date & time settings.

### 6.1.1 Set Wired Network

Step 1 Go to **Settings > Network > Wired Network**.

Step 2 Enable **Wired Network**.



Figure 6-2 Wired Network

Step 3 (Optional) Tap **Network Settings** to set proxy or static IP.

### 6.1.2 Set Wireless Network (Optional)

Go to **Settings > Network > Wireless Network** to enable it, and add or connect to an available wireless network.

#### Connect to an Wireless Network

Select an available wireless network, and enter its password to join it.

You can tap the connected wireless network to view its information. If you want to clear the network information, tap **Clear Network**.

Tap **Cancel** to exit the interface.

#### Add Other Networks

Step 1 Tap **Add Other Networks**.

Step 2 Enter the Wi-Fi name.

Step 3 Set **Security**.

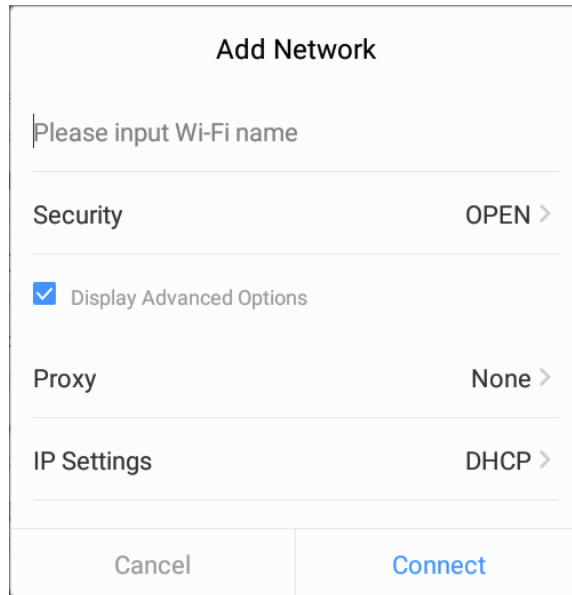

Figure 6-3 Add Wireless Network

Step 4 (Optional) Check **Display Advanced Options** to set proxy and IP settings.

Step 5 Tap **Connect** to connect your device to the network.

### 6.1.3 Set Hotspot

When your device is connected to a wired network, it can become a WLAN hotspot to share its network.

Step 1 Go to **Settings > Network > Hotspot**.

Step 2 Select **Hotspot**.

Step 3 Enable **Portable WLAN Hotspot** to turn on hotspot.

Step 4 Tap **Set WLAN Hotspot** to set hotspot parameters, including the security mode and the password.

Step 5 Click **Save**.



**NOTE**

If your device supports both 2.4 GHz and 5 GHz, it is recommend to set AP Frequency as 5 GHz to improve the network transmission speed.

## 6.2 Display

You can set display parameters like brightness and sleep mode in **Settings > Display**.

## Interactive Display

---

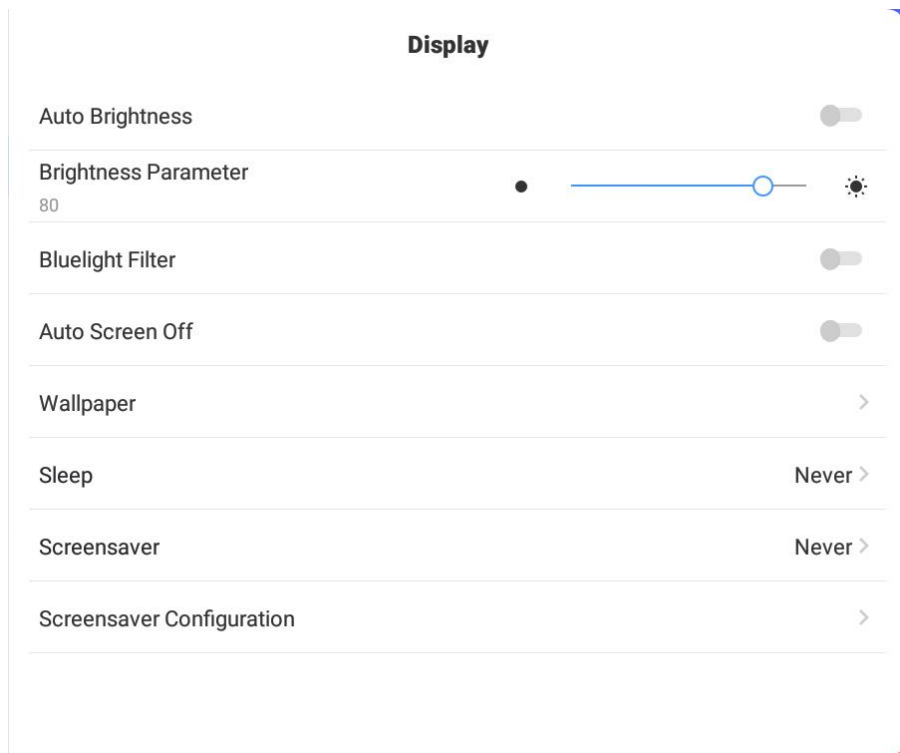

Figure 6-4 Display Settings

- **Auto Brightness:** The System will automatically adjust the brightness according the environment.
- **Brightness Parameter:** You can manually adjust the brightness.
- **Bluelight Filter:** After it enabled, the device will filter bluelight, and you can set the level of filtering. The higher filtering level you have set, the more bluelight will be filtered.
- **Wallpaper:** Select a wallpaper from local directory for your device.
- **Sleep:** The system will go to sleep mode when there is no operation for a certain period.
- **Screensaver:** When there is no operation for a certain period, the device will enable screensaver.
- **Screensaver Configuration:** You can set the screensaver image.

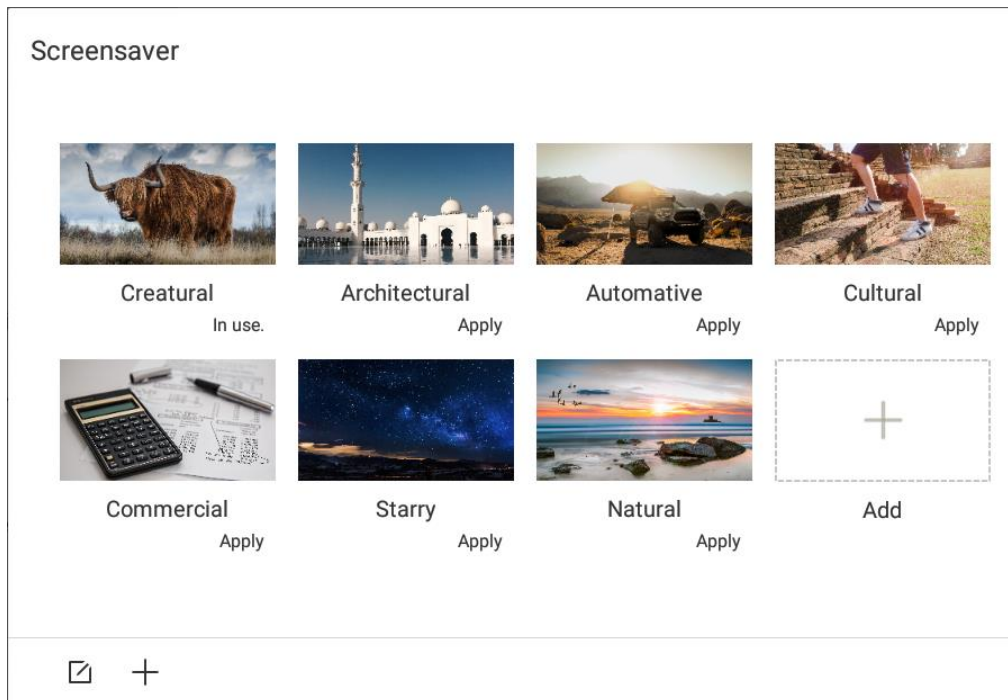

Figure 6-5 Set Screensaver

**NOTE**

You can click **+** to add new pictures into the screensaver.

## 6.3 Audio

Go to **Settings > Audio** to set audio parameters. Under **Standard, Music** and **Film** mode, you can only set **Balance** and **Volume**. Under **User** mode, you can custom all parameters.

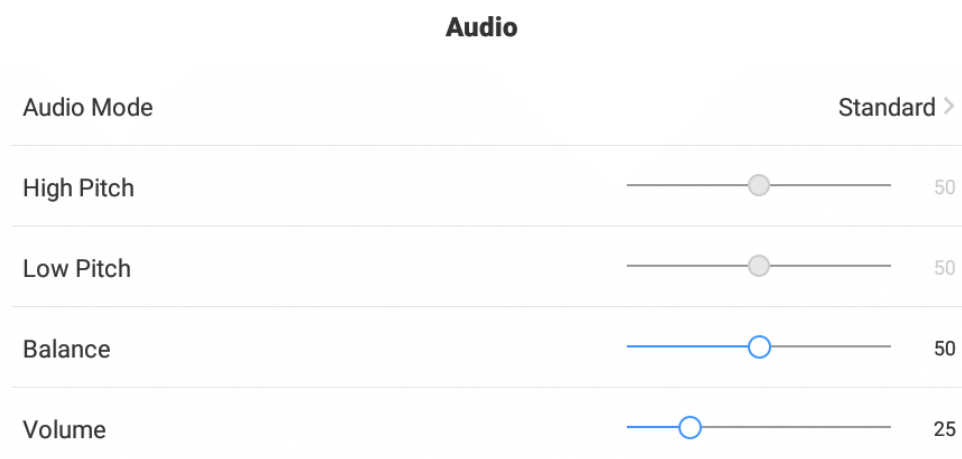

Figure 6-6 Audio Settings



### 6.4 Language and Input Method

Go to **Settings > Language & Input** to configure the following settings

- **Language:** Different languages are selectable.
- **Input Method:** Two input methods are provided. Downloading third-party input method is supported.

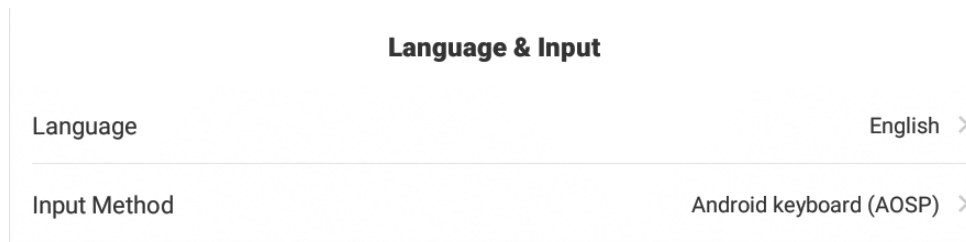

Figure 6-7 Language & Input

### 6.5 Date and Time

Go to **Settings > Date & Time** to set the date and time.

- **Time Sync:** The device will sync time with internet when it is enabled. You can disable it to manually set the time.

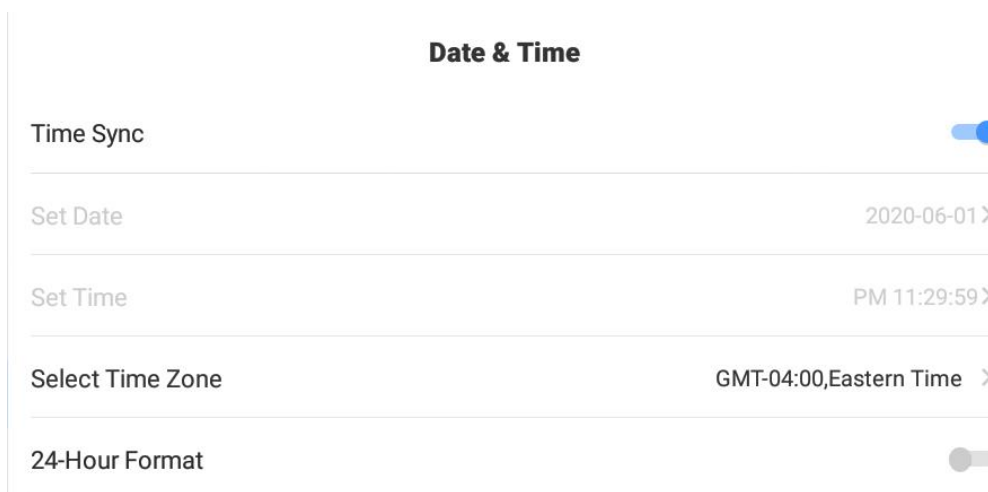

Figure 6-8 Date & Time

### 6.6 Application Management

Go to **Settings > Application Management** to manage the applications installed on the system.

You can select an application to view the detailed information, and perform the following operations for the application: force stop, clear data, clear cache, etc.

## Interactive Display

The pre-installed system apps cannot be uninstalled. You can go to **Application Details**, and tap the app icon to open an app.

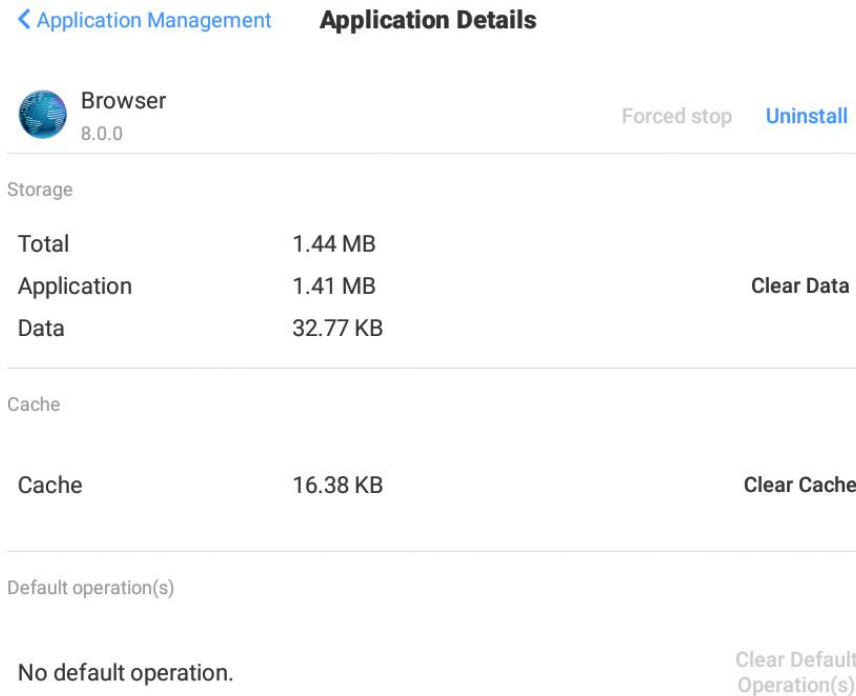

Figure 6-9 Application Management

## 6.7 Temperature Control

The system can monitor the internal temperature in real-time. When the temperature exceeds the warning or alarm threshold value, the system will notify you to avoid overheat and device damage.

Step 1 Go to **Settings > Auxiliary Functions > Intelligent Temperature Control**.

Step 2 Enable **Temperature Detection**.

Step 3 Set **Warning Temperature** and **Alarm Temperature**.

- **Warning Temperature:** When the device temperature exceeds the warning temperature threshold, the temperature will become red in the status bar at the upper-right corner.
- **Alarm Temperature:** When the device temperature exceeds the alarm temperature threshold, the temperature information will pop up, and ask you whether to shut down the device.

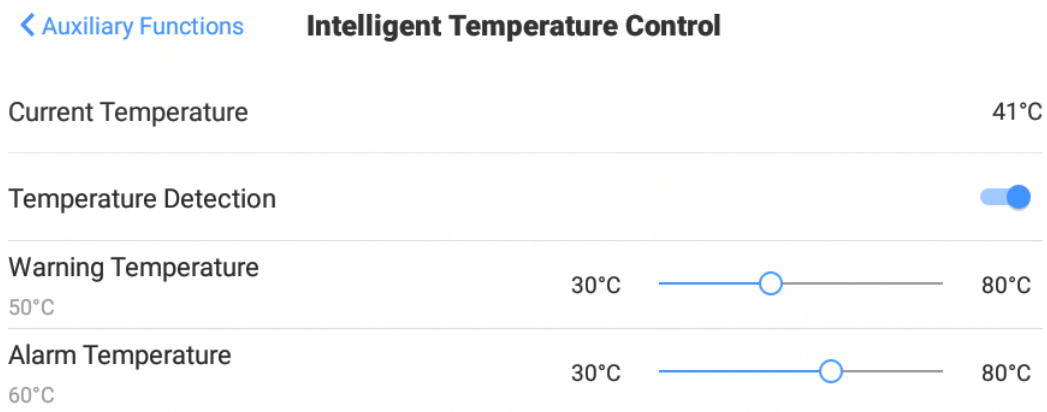

Figure 6-10 Intelligent Temperature Control

## 6.8 Advanced Settings

Go to **Settings** > **Advanced Settings** to configure the following settings.

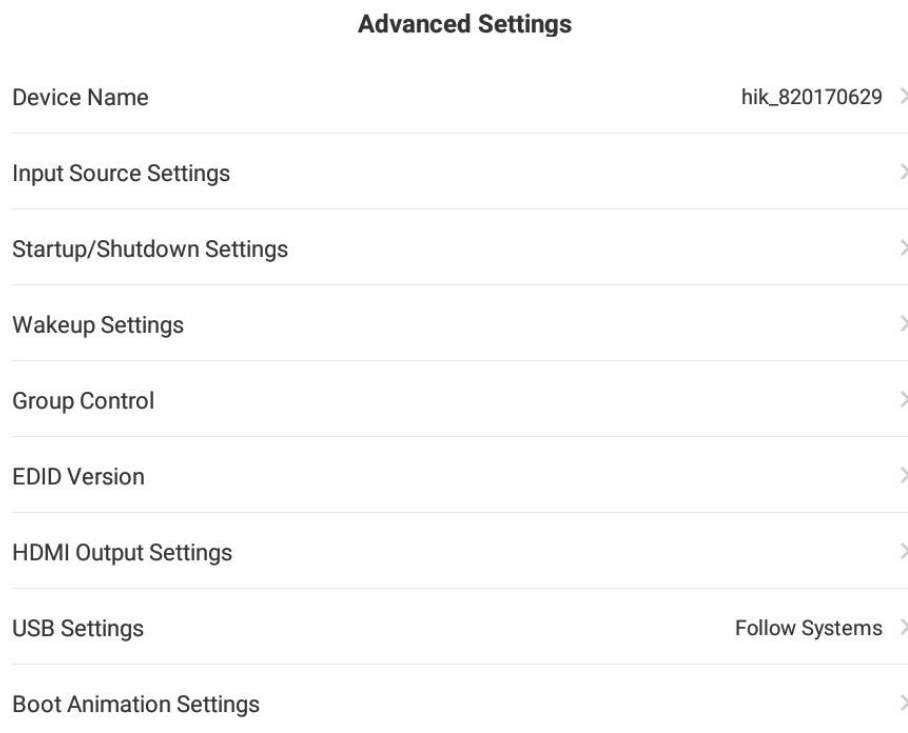

Figure 6-11 Advanced Settings

### 6.8.1 Device Name

You can view the device name, or tap the device name to edit it.

### 6.8.2 Input Source Settings

- **Startup Input Source:** Select the input signal source as internal PC or external signal source when the device starts up.
- **Rename Startup Input Source:** In order to distinguish different sources, you can edit the input source name.
- **Auto Switch When Connecting Signal Source:** When a signal source is plugged in and detected, the device will automatically switch to this source.
- **Auto Switch When Disconnecting Signal Source:** After the external signal source is disconnected, the device will automatically switch the source to which you have set in advance.

### 6.8.3 Startup/Shutdown Settings

- **Startup Mode:** Two options are available, **Startup When Powered On** and **Standby When Powered On**.
- **Scheduled Startup/Shutdown:** To set the daily startup and shutdown time for your device.
- **No-signal Shutdown:** When there is no signal in a certain period, the device will shut down automatically.

### 6.8.4 Wakeup Settings

- **Wake from Serial Port:** The device will wake up when it receives the request from serial port.
- **Wake from Signal Source:** The device will wake up when it detects input signal source.

### 6.8.5 EDID Version

EDID version is classified as 1.4 and 2.0.

- 1.4 version is suitable for input signals with wider resolution types (up to 3840 × 2160, 30 fps).
- 2.0 version is suitable for input signals with up to 4K, 60 fps.

### 6.8.6 USB Settings

You can assign which operating system to use the USB interface.

- **Android:** USB interface is only available for Android operating system.
- **PC:** USB interface is only available when operating system is PC.
- **Follow Systems:** The operating system of which can use the USB interface is depend on the system. If the system is using Android as its operating system, then USB interface will be available for Android.

## 6.8.7 Boot Animation Settings

If you have a boot animation in the bootanimation folder of a USB flash drive, you can use it as the device boot animation.

Or, you can reset the boot animation. New settings will take effect after restart.

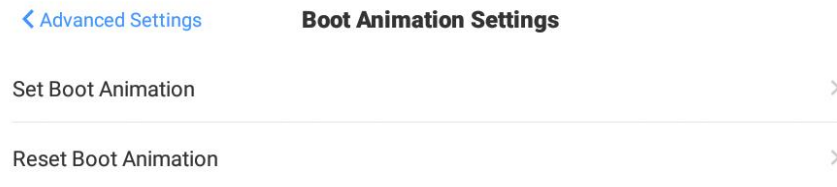

Figure 6-12 6.8.8 Boot Animation Settings

## 6.8.8 PC One-Touch Restore

You can restore the internal PC to factory defaults.

## 6.8.9 Floating Ball Settings

Floating ball functions can be customized.

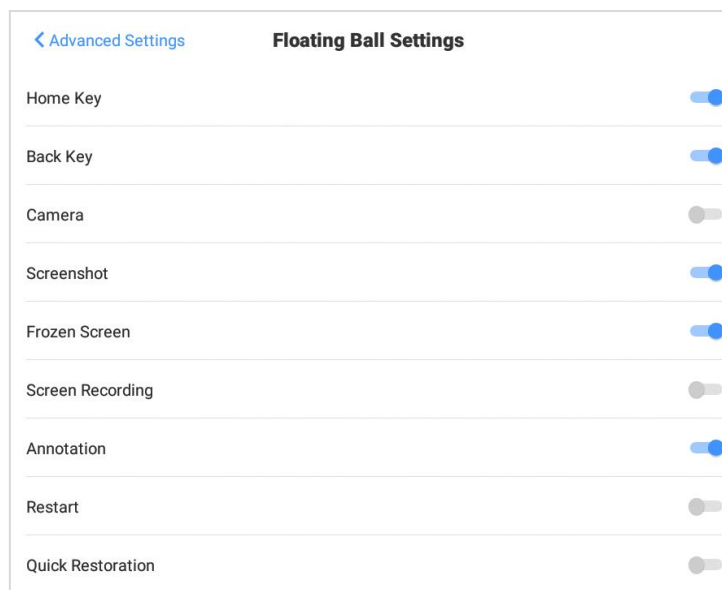



Figure 6-13 Floating Ball Settings

## 6.8.10 Entity Key Settings

You can customize the function of the rightmost button (  ) at your device front panel.

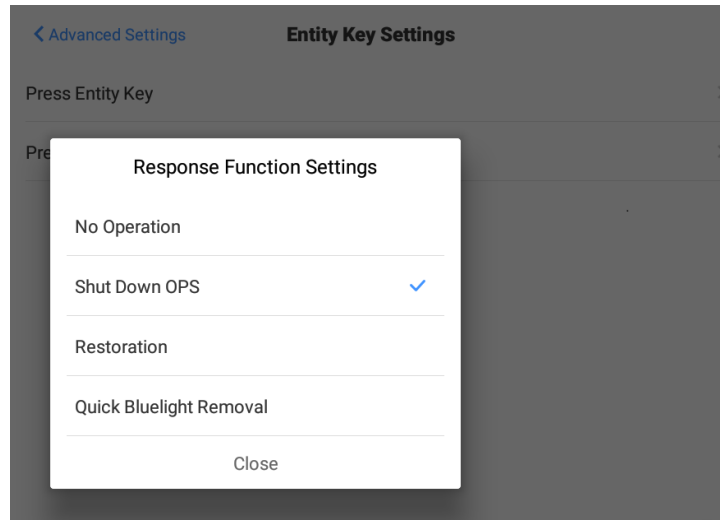

Figure 6-14 Entity Key Settings

### 6.8.11 Restore to Factory Default

When your device is restored to factory default settings, all configuration data will be lost. Please be cautious when operating this function.

## 6.9 Security Settings

### 6.9.1 Lock Screen Password

Lock screen password is used for unlocking your device when the device starts up, or wakes up.

Step 1 Go to **Settings > Security**.

Step 2 Enable lock screen password.

Step 3 Enter the lock screen password, and confirm it.

#### NOTE

- You can change the lock screen password after it is enabled.
- You can tap **Lock Setting Items** to select whether to enter lock screen password when go to network settings or advanced settings.

### 6.9.2 USB Key

When you have forgot your password, you can use a specified USB key to unlock the screen.



### NOTE

- USB key product is an optional item.
- The function is open by default.

## 6.10 View System Info

Go to **System** > **About** to view system information.

# Chapter 7 Smart Applications

## 7.1 File Management

Step 1 Tap **File Management**.

Step 2 Tap **Image/Doc/AV** to view the corresponding files.

- Tap the **All** tab to view all the document, capture, video, picture, and music files saved in device or connected USB flash drive.
- Tap the **All** button in right bottom corner to select all files in current page.
- Tap the **Copy/Paste/Delete** button to copy/paste/delete the selected files.

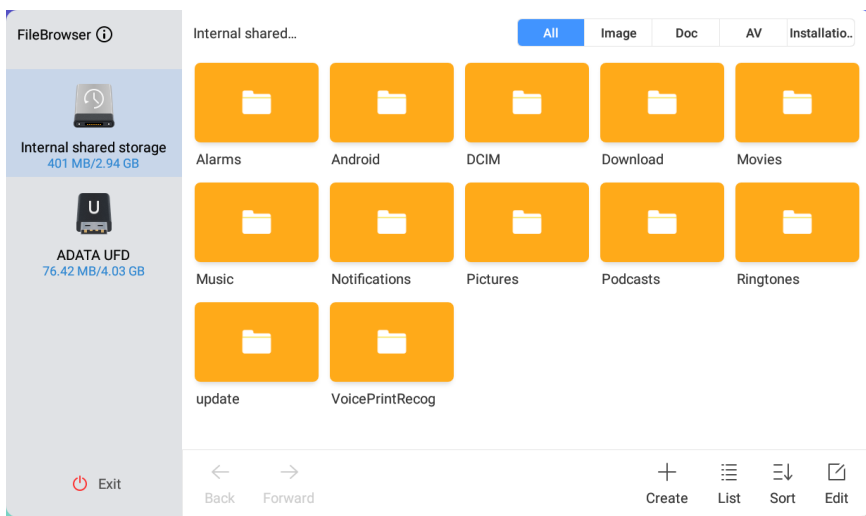

Figure 7-1 File Management

Table 7-1 File Management Icon Description

Icon	Description	Icon	Description
←, →	Go to the previous/next page.	+	Add new folder.
☰	Change the display type of viewing files.	≡↓	Sort the file order.
✍	Open the file operating bar. The icon description of file operating bar is shown below.		



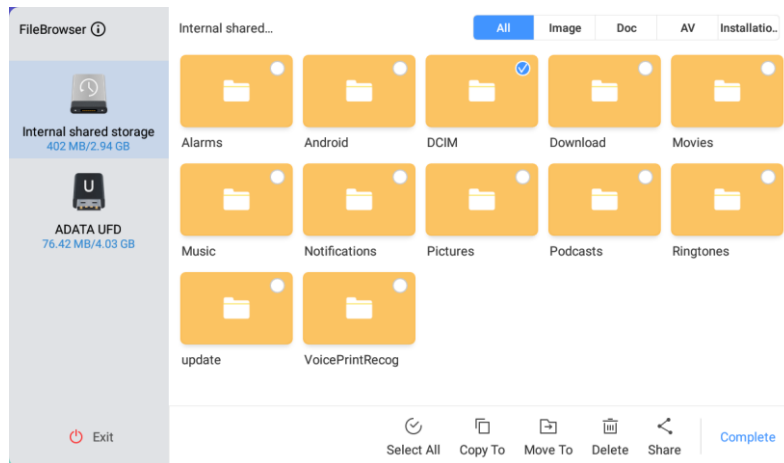

Figure 7-2 File Operating Bar

Table 7-2 File Operating Bar Icon Description

Icon	Description	Icon	Description
	Select all files.		Duplicate the selected file.
	Move the selected file.		Delete the selected file.
	Share the selected file.		

**NOTE**

Tap a file and hold, then the options like move, duplicate, share will appear.

## 7.2 Browser

**NOTE**

Ensure your device is properly connected to internet.

Tap **Browser**, then enter a website in the address bar to surf the internet.







## 7.3 Roaming Buttons

Tap the screen in two points and hold till the roaming button pops up. You can drag it to any area of screen, or tap the roaming button to unfold it and show buttons.



Figure 7-3 Roaming Button

Figure 7-4 Roaming Button Description

Icon	Description	Icon	Description
	Exit the current interface.		Go back to home page.
	Return to the previous step.		Add note to the captured picture
	Take a screenshot.		Freeze the current screen image.

## Appendix 1 Parameter Description

Image	Image mode	Bright, standard, gentle, user, game, auto, computer, bright-color, nature, and sport are provided.
	Contrast	The difference in luminance or color that makes an object distinguishable. Increase the value to enhance the difference. Decrease the value to reduce the difference. Contrast value range: [0,100].
	Brightness	The luminance of the image. Increase the value to enhance the brightness. Decrease the value to reduce the brightness. Brightness value range: [0,100].
	Sharpness	The definition of the image. Increase the value to enhance the sharpness. Decrease the value to reduce the sharpness. Sharpness value range: [0,100].
	Saturation	The color intensity of the image. Increase the value to enhance the saturation. Decrease the value to reduce the saturation. Saturation value range: [0,100].
	Color temperature	Standard, warm, and cool options are provided.
	Ratio	Default, 16:9, auto, panorama, Just Scan, zoom in 1, zoom 2, 14:9, and point-to-point options are provided.
Sound	Sound mode	Standard, Music, Movie, Sports, User, On-Site1, and On-Site2 are selectable.
	Low pitch	The low pitch value. Increase the value to enhance the low pitch. Decrease the value to reduce the low pitch. Low pitch value range: [0,100].
	High pitch	The high pitch value. Increase the value to enhance the high pitch. Decrease the value to reduce the high pitch. High pitch value range: [0,100].
	Balance	The balance of left and right channels. Drag the slider to left to increase the left channel volume. Drag the slider to right to increase the right channel volume. Balance value range: [L50, R50]. The balance volume is 0 as a general rule.
	Volume	The volume value. Increase the value to enhance the volume. Decrease the value to reduce the volume. Volume value range: [0,100].

## Interactive Display

---

Light	Backlight	The screen brightness. Increase the value to enhance the brightness. Decrease the value to reduce the brightness. Backlight value range: [0,100].
Other	Status bar	Shows the device temperature, CPU usage, and memory usage.

## Appendix 2 Troubleshooting

Trouble	Reason	Solution
Snow spots exist in image and the device is noisy.	<ul style="list-style-type: none"> <li>● Antenna is loose or cable is damaged.</li> <li>● Antenna type is wrong.</li> <li>● Antenna direction or position is wrong.</li> <li>● Signal is weak.</li> </ul>	<ul style="list-style-type: none"> <li>● Check whether the antenna plug and cable are well.</li> <li>● Check whether the antenna type is VHF or UHF.</li> <li>● Adjust the antenna direction and position.</li> <li>● Try the strengthening signal equipment.</li> </ul>
No image in screen, no sound sends out from the device, and the power indicator is unlit.	Power supply plug is loose.	Check the power cable connection.
Spots or stripes exist in the image.	Signal is being interrupted by automotive, neon light, electricity, blower, etc.	Do not use the interruption producing equipment near the device.
Image ghosting.	<ul style="list-style-type: none"> <li>● The device signal is reflected by the nearby mountain or high building.</li> <li>● Antenna direction is wrong.</li> </ul>	<ul style="list-style-type: none"> <li>● Try the high-gain antenna.</li> <li>● Adjust the antenna direction.</li> </ul>
The image is not colored.	The saturation is low.	Enter Image settings interface and increase the saturation value.
The device sends out no sound.	<ul style="list-style-type: none"> <li>● The volume is low.</li> <li>● The device is muted.</li> </ul>	<ul style="list-style-type: none"> <li>● Increase the volume.</li> <li>● Press the  button in remote control to turn on audio.</li> </ul>
No signal in display and power indicator flashes in red.	Signal input cable is loose or striped.	Check whether the signal input cable is well.

## Interactive Display

Trouble	Reason	Solution
Image doesn't perfectly fill into the display or is fuzzy.	<ul style="list-style-type: none"> <li>● Wrongly adjusted.</li> <li>● Display mode is wrong.</li> </ul>	<ul style="list-style-type: none"> <li>● Apply auto-adjust function.</li> <li>● Enter the More menu to adjust horizontal or vertical position.</li> <li>● Apply recommended display mode.</li> </ul>
Control via remote control is invalid. Or control distance of remote control is too short.	<ul style="list-style-type: none"> <li>● IR receiver is overlapped.</li> <li>● Remote control battery is insufficient.</li> </ul>	<ul style="list-style-type: none"> <li>● Remove the overlap object.</li> <li>● Change battery.</li> </ul>
Accessing internet via browser failed.	<ul style="list-style-type: none"> <li>● Network parameters are unavailable.</li> <li>● Network connection is not well.</li> <li>● Network server is not enabled.</li> </ul>	<ul style="list-style-type: none"> <li>● Request network administrator for available network IP address and other parameters.</li> <li>● Check the network cable connection.</li> <li>● Consult the internet service provider.</li> </ul>
Playing back online video is not fluent.	<ul style="list-style-type: none"> <li>● Network bandwidth is insufficient.</li> <li>● Buffer or download multiple movies synchronously.</li> <li>● Multiple computers share the same network.</li> </ul>	<ul style="list-style-type: none"> <li>● Increase your network bandwidth.</li> <li>● Try another playback address.</li> </ul>
Device halted or crashed.	<ul style="list-style-type: none"> <li>● Too many programs are running.</li> <li>● The device is interrupted by the external situation (lightning, static electricity, etc.).</li> </ul>	Cut off device power supply for 1 to 2 minutes. And power on the device again.



See Far, Go Further