

**USB KVM Extender  
CE770  
User Manual**



## FCC Information

This is an FCC Class A product. In a domestic environment this product may cause radio interference in which case the user may be required to take adequate measures.

This equipment has been tested and found to comply with the limits for a Class A digital device, pursuant to Part 15 of the FCC Rules. These limits are designed to provide reasonable protection against harmful interference when the equipment is operated in a commercial environment. This equipment generates, uses and can radiate radio frequency energy and, if not installed and used in accordance with the instruction manual, may cause harmful interference to radio communications. Operation of this equipment in a residential area is likely to cause harmful interference in which case the user will be required to correct the interference at his own expense.

## RoHS

This product is RoHS compliant.

## SJ/T 11364-2006

The following contains information that relates to China.

| 部件名称 | 有毒有害物质或元素 |   |   |     |      |       |
|------|-----------|---|---|-----|------|-------|
|      | 铅         | 汞 | 镉 | 六价铬 | 多溴联苯 | 多溴二苯醚 |
| 电器部件 | ●         | ○ | ○ | ○   | ○    | ○     |
| 机构部件 | ○         | ○ | ○ | ○   | ○    | ○     |

- : 表示该有毒有害物质在该部件所有均质材料中的含量均在SJ/T 11363-2006规定的限量要求之下。
- : 表示符合欧盟的豁免条款, 但该有毒有害物质至少在该部件的某一均质材料中的含量超出SJ/T 11363-2006的限量要求。
- ×: 表示该有毒有害物质至少在该部件的某一均质材料中的含量超出SJ/T 11363-2006的限量要求。



---

## User Information

---

### Online Registration

Be sure to register your product at our online support center:

|               |   |
|---------------|---|
| International | <a href="http://support.aten.com">http://support.aten.com</a>   |
| North America | <a href="http://www.aten-usa.com/product_registration">http://www.aten-usa.com/product_registration</a> |

### Telephone Support

For telephone support, call this number:

|                |                         |
|----------------|-------------------------|
| International  | 886-2-8692-6959         |
| China          | 86-10-5255-0110         |
| Japan          | 81-3-5615-5811          |
| Korea          | 82-2-467-6789           |
| North America  | 1-888-999-ATEN ext 4988 |
| United Kingdom | 44-8-4481-58923         |

### User Notice

All information, documentation, and specifications contained in this manual are subject to change without prior notification by the manufacturer. The manufacturer makes no representations or warranties, either expressed or implied, with respect to the contents hereof and specifically disclaims any warranties as to merchantability or fitness for any particular purpose. Any of the manufacturer's software described in this manual is sold or licensed *as is*. Should the programs prove defective following their purchase, the buyer (and not the manufacturer, its distributor, or its dealer), assumes the entire cost of all necessary servicing, repair and any incidental or consequential damages resulting from any defect in the software.

The manufacturer of this system is not responsible for any radio and/or TV interference caused by unauthorized modifications to this device. It is the responsibility of the user to correct such interference.

The manufacturer is not responsible for any damage incurred in the operation of this system if the correct operational voltage setting was not selected prior to operation. PLEASE VERIFY THAT THE VOLTAGE SETTING IS CORRECT BEFORE USE.

## Package Contents

---

The CE770 package consists of:

- ◆ 1 CE770L USB KVM Extender (Local Unit)
- ◆ 1 CE770RQ USB KVM Extender (Remote Unit)
- ◆ 1 USB KVM Cable (1.8 m)
- ◆ 2 Power Adapters
- ◆ 2 Mounting Kits
- ◆ 1 User Instructions\*

Check to make sure that all the components are present and that nothing got damaged in shipping. If you encounter a problem, contact your dealer.

Read this manual thoroughly and follow the installation and operation procedures carefully to prevent any damage to the unit, and/or any of the devices connected to it.

---

\* Features may have been added to the CE770 since this manual was printed. Please visit our website to download the most up-to-date version of the manual.

---

© Copyright 2012 ATEN® International Co., Ltd.  
Manual Part No. PAPE-0309-AT3G  
Manual Date: 2012-06-07

ATEN and the ATEN logo are registered trademarks of ATEN International Co., Ltd. All rights reserved.  
All other brand names and trademarks are the registered property of their respective owners.

# Contents

---

|  |      |
|--|------|
| FCC Information . . . . .                          | ii   |
| RoHS . . . . .                                     | ii   |
| SJ/T 11364-2006 . . . . .                          | ii   |
| User Information . . . . .                         | iii  |
| Online Registration . . . . .                      | iii  |
| Telephone Support . . . . .                        | iii  |
| User Notice . . . . .                              | iii  |
| Package Contents . . . . .                         | iv   |
| About this Manual . . . . .                        | vii  |
| Conventions . . . . .                              | vii  |
| Product Information . . . . .                      | viii |
| <br>   |      |
| <b>1. Introduction</b>                             |      |
| Overview . . . . .                                 | 1    |
| Features . . . . .                                 | 3    |
| Requirements . . . . .                             | 4    |
| Consoles . . . . .                                 | 4    |
| Computers . . . . .                                | 4    |
| Cables . . . . .                                   | 4    |
| Operating Systems . . . . .                        | 5    |
| Components . . . . .                               | 6    |
| CE770L (Local Unit) Front View . . . . .           | 6    |
| CE770RQ (Remote Unit) Front View . . . . .         | 7    |
| CE770L / CE770RQ Rear View . . . . .               | 8    |
| Side View . . . . .                                | 8    |
| <br>   |      |
| <b>2. Hardware Setup</b>                           |      |
| Rack Mounting . . . . .                            | 9    |
| Installation . . . . .                             | 11   |
| Grounding . . . . .                                | 11   |
| Setting Up . . . . .                               | 13   |
| Installation Diagrams . . . . .                    | 14   |
| CE770L / CE770RQ Rear View . . . . .               | 14   |
| CE770L Front View . . . . .                        | 15   |
| <br>   |      |
| <b>3. Operation</b>                                |      |
| Operating Modes . . . . .                          | 17   |
| Mode Selection . . . . .                           | 18   |
| Deskew and Picture Compensation . . . . .          | 19   |
| Color / Video Compensation (Remote Unit) . . . . . | 19   |
| LED Display . . . . .                              | 20   |
| CE770L (Local Unit) . . . . .                      | 20   |
| CE770RQ (Remote Unit) . . . . .                    | 21   |

|   |    |
|---|----|
| Hotkey Setting Mode . . . . .           | 22 |
| Invoking HSM . . . . .                  | 22 |
| Alternate HSM Invocation Keys . . . . . | 23 |
| Keyboard Operating Platform . . . . .   | 23 |
| Hotkey Summary Table. . . . .           | 24 |

## **4. Keyboard Emulation**

|                       |    |
|-----------------------|----|
| Mac Keyboard. . . . . | 25 |
| Sun Keyboard. . . . . | 26 |

## **Appendix**

|                                 |    |
|---------------------------------|----|
| Safety Instructions . . . . .   | 27 |
| General . . . . .               | 27 |
| Rack Mounting . . . . .         | 29 |
| Technical Support. . . . .      | 30 |
| International . . . . .         | 30 |
| North America . . . . .         | 30 |
| Specifications . . . . .        | 31 |
| Troubleshooting . . . . .       | 32 |
| Overview. . . . .               | 32 |
| About SPHD Connectors . . . . . | 32 |
| Limited Warranty. . . . .       | 32 |

## About this Manual

---

This User Manual is provided to help you get the most from your system. It covers all aspects of installation, configuration and operation. An overview of the information found in the manual is provided below.

**Chapter 1, Introduction**, introduces you to the CE770 system. Its purpose, features and benefits are presented, and its front and back panel components are described.

**Chapter 2, Hardware Setup**, describes the steps that are necessary to quickly and safely set up your installation.

**Chapter 3, Operation**, explains the fundamental concepts involved in operating the CE770.

**Chapter 4, Keyboard Emulation**, provides tables that list the PC to Mac and PC to Sun keyboard emulation mappings.

**An Appendix**, provides specifications and other technical information regarding the CE770.

## Conventions

---

This manual uses the following conventions:

|   |  |
|---|--|
| Monospaced  | Indicates text that you should key in.   |
| [ ]   | Indicates keys you should press. For example, [Enter] means to press the <b>Enter</b> key. If keys need to be chorded, they appear together in the same bracket with a plus sign between them: [Ctrl+Alt]. |
| 1.  | Numbered lists represent procedures with sequential steps.   |
| ◆   | Bullet lists provide information, but do not involve sequential steps.   |
| →   | Indicates selecting the option (on a menu or dialog box, for example), that comes next. For example, Start → Run means to open the <i>Start</i> menu, and then select <i>Run</i> .                         |
|  | Indicates critical information.  |

## Product Information

---

For information about all ATEN products and how they can help you connect without limits, visit ATEN on the Web or contact an ATEN Authorized Reseller. Visit ATEN on the Web for a list of locations and telephone numbers:

|               |   |
|---------------|---|
| International | <a href="http://www.aten.com">http://www.aten.com</a>         |
| North America | <a href="http://www.aten-usa.com">http://www.aten-usa.com</a> |



# Chapter 1

## Introduction

### Overview

---

The CE770 is a USB (Universal Serial Bus) based KVM Extender with Deskew function. The automatic signal compensation and RS-232 serial functionality allow access to a computer system from a remote USB console (USB keyboard, monitor, and USB mouse).

Because it allows access to a computer system from a remote console, the CE770 is perfect for use in any type of installation where you need to place the console where it is conveniently accessible, but you want the system equipment to reside in a safe location – away from the dust and dirt of the factory floor, or the harsh environmental influence of a construction site, for example. This allows users to deploy system equipment over large distances.

The CE770's automatic delay line synchronizing function (ATEN patent) corrects RGB color phase and timing errors that occur over long distance transmissions. It also enables you to manually tune the R/G/B signal settings, store the settings and retrieve them later using the memory button.

The CE770 is also useful for control and security purposes, where you can have the system unit in a secure area at the same time that you put the console in the most convenient location for user access. This is ideal for managing highly confidential data systems.

The CE770 improves on previous designs by: 1) RGB delay tuner – the CE770 supports RGB delay tuner to automatically or manually synchronize the RGB signals; 2) the addition of an RS-232 port, on both the Local and Remote Units – the RS-232 port on the Local Unit allows you to connect to a serial terminal for configuration, while the RS-232 port on the Remote Unit allows you to connect serial devices such as touchscreens and barcode scanners; 3) the addition of a dedicated KVM port section on the Local Unit so you can simply and easily include a KVM switch in your installation; 4) using inexpensive Cat 5e cable instead of bulkier, more expensive, standard cables, for a much neater, more convenient, more reliable data transfer connection; 5) its ability to sense the distance to the system and automatically adjust the gain accordingly; and 6) featuring a custom ASIC to ensure the utmost in reliability and compatibility.

Further CE770 key features are built-in 8KV/15KV ESD protection and 2KV surge protection, and color adjust picture compensation pushbuttons on the Remote Unit to adjust the picture on the remote console.

Setup is as easy as can be – simply connect the computer system box and local console to the Local CE770L Unit; run the Cat 5e cable to the Remote CE770RQ Unit (up to 300 meters away); and plug the remote console into the Remote Module.

## Features

---

- ◆ Local and Remote Units connect at distances up to 300 m using Cat 5e cable
- ◆ Deskw Function – automatically synchronizes the time delay of RGB signals to compensate for distance
- ◆ Dual console operation – control your system from both the local and remote USB keyboard, monitor, and mouse consoles
- ◆ Built-in ASIC for greater reliability and compatibility
- ◆ Auto Signal Compensation (ASC)
- ◆ RS-232 serial ports – allow you to connect to a serial terminal, or serial devices such as touchscreens and barcode scanners
- ◆ Sun/Mac keyboard support and emulation\*
- ◆ Audio Enabled – supports stereo speakers and microphone
- ◆ USB overcurrent detection and prevention
- ◆ Pushbutton operating mode selection (Local Unit only) – select between Local and Auto operating modes, with the press of a single button
- ◆ Built-in 8KV/15KV ESD protection (Contact voltage 8KV; Air voltage 15KV) and 2KV surge protection
- ◆ High resolution video – up to 1920 x 1200@60Hz (150 m); 1280 x 1024@60Hz (300 m)
- ◆ Superior Audio – no loss in audio quality at 300 m
- ◆ Supports Wide Screen formats
- ◆ Supports VGA, SVGA, SXGA (1280 x 1024), UXGA (1600 x 1200), WUXGA (1920 x 1200) and multisync monitors; local monitor supports DDC; DDC2; DDC2B
- ◆ Hot pluggable
- ◆ Rack mountable
- ◆ Easy to install – no software required – connecting cables to the devices is all it takes

---

\* 1. PC keyboard combinations emulate Sun/Mac keyboard  
2. Sun/Mac keyboards only work with their own computers

---

## Requirements

---

### Consoles

- ◆ A VGA, SVGA, SXGA, UXGA, WUXGA, or multisync monitor capable of the highest resolution that you will be using on any computer in the installation

---

**Note:** If you connect a DDC type monitor to the Local Unit, the monitor that connects to the Remote Unit must be able to support the highest video resolution that the DDC monitor can provide

---

- ◆ A USB keyboard

---

**Note:** You can use different brands and models of USB keyboard on the Local and Remote Units, but support for multi-function keyboards is limited to the standard 104 keys.

---

- ◆ A USB mouse

---

**Note:** You can use different brands and models of mouse on the Local and Remote Units, but only the left and right mouse buttons and scroll wheel features are supported. Other mouse features are not supported.

---

- ◆ Stereo microphone and stereo speakers (optional)

### Computers

The following equipment must be installed on each computer that is to be connected to the system:

- ◆ A VGA, SVGA, SXGA, UXGA, WUXGA, or multisync card.
- ◆ USB host controller and Type A USB port.

### Cables

- ◆ For optimal signal integrity, and to simplify the layout, we strongly recommend that you use the high quality custom USB KVM Cable that is provided with this package.
- ◆ Cat 5e cable is the minimum required to connect the Local and Remote CE770 Units. Cable of a lower standard will result in degrading of the video signal. For best performance, we strongly recommend Cat 5e cable.

## **Operating Systems**

Supported operating systems are shown in the table, below:

| <b>OS</b> |                     | <b>Version</b>  |
|-----------|---------------------|-----------------|
| Windows   |                     | 2000, XP, Vista |
| Linux     | RedHat              | 7.1 and higher  |
|           | SuSE                | 9.0 and higher  |
|           | Mandriva (Mandrake) | 9.0 and higher  |
| UNIX      | FreeBSD             | 4.2 and higher  |
| Novell    | Netware             | 6.0 and higher  |

## Components

### CE770L (Local Unit) Front View

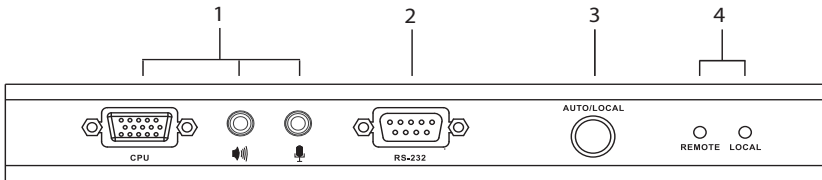

| No. | Component                 | Description  |
|-----|---------------------------|--|
| 1   | KVM Port Section          | If you are combining the CE770 with a KVM switch, the USB KVM cable that links to the respective ports on the Console section of the switch plugs into these ports.  |
| 2   | RS-232 Serial Port        | This RS-232 serial port is for connecting to a serial terminal for configuration.  |
| 3   | Operating Mode Pushbutton | This pushbutton toggles between the Operating Modes available from the Local Console: <ul style="list-style-type: none"> <li>◆ Local – only the Local Console can control the system(s).</li> <li>◆ Auto – both the Local and Remote Consoles can control the system.</li> </ul> <p><b>Note:</b> The default operating mode is <i>Auto</i>. See <i>Operating Modes</i>, page 17, for full details.</p> |
| 4   | LEDs                      | The CE770L has two LEDs to indicate the operating status of the Local (CE770L) and Remote (CE770RQ) Units. See <i>LED Display</i> , page 20, for full details.   |

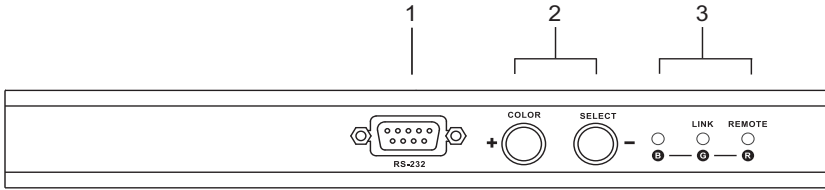
**CE770RQ (Remote Unit) Front View**

| No. | Component                                   | Description   |
|-----|---|---|
| 1   | RS-232 Serial Port                          | RS-232 serial devices – such as touchscreens or barcode scanners – plug into this port.   |
| 2   | Deskew and Picture Compensation Pushbuttons | These pushbuttons adjust the video quality of the remote console. See <i>Deskew and Picture Compensation</i> , page 19 for details. |
| 3   | LEDs<br>RGB                                 | The CE770RQ has three LEDs to indicate the operating status. See <i>LED Display</i> , page 20.                                      |

## **CE770L / CE770RQ Rear View**

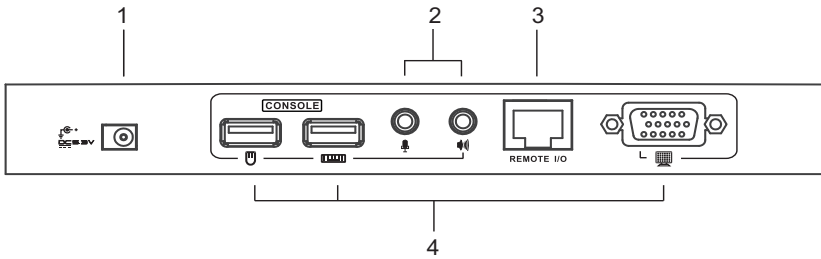

## **Side View**

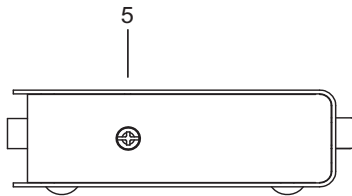

| No. | Component          | Description  |
|-----|--------------------|--|
| 1   | Power Jack         | The cable from the DC Power adapter connects here.   |
| 2   | Audio Ports        | These mini stereo ports are for the speakers (green) and microphone (pink).                                      |
| 3   | Remote I/O         | The Cat 5e cable that connects the Remote and Local Units plugs in here.   |
| 4   | Console Ports      | The Local and Remote console's keyboard, monitor, and mouse plug into these ports.                               |
| 5   | Grounding Terminal | The grounding wire (used to ground the unit) attaches here. See <i>Grounding</i> , page 11, for further details. |



# Chapter 2

## Hardware Setup



1. Important safety information regarding the placement of this device is provided on page 27. Please review it before proceeding.
2. Make sure that the power to all devices connected to the installation are turned off. You must unplug the power cords of any computers that have the Keyboard Power On function.

### Rack Mounting

---

For convenience and flexibility, the CE770L and CE770RQ can be mounted on system racks. To rack mount a unit do the following:

1. Using the screws provided in the Rack Mount Kit, screw the mounting bracket into the top or bottom of the unit as show in the diagram below:

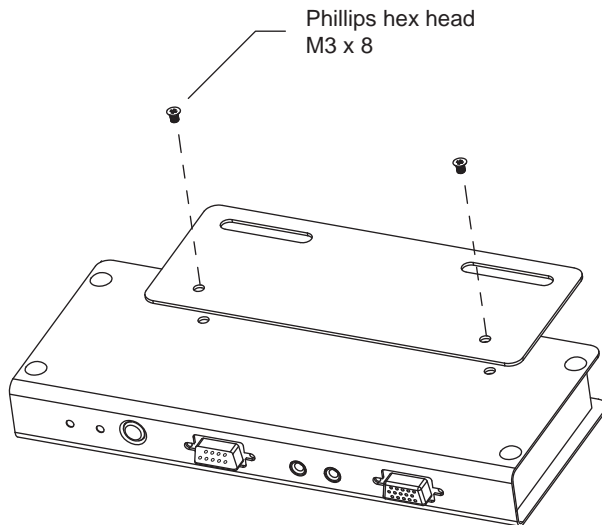

2. Screw the bracket into any convenient location on the rack.

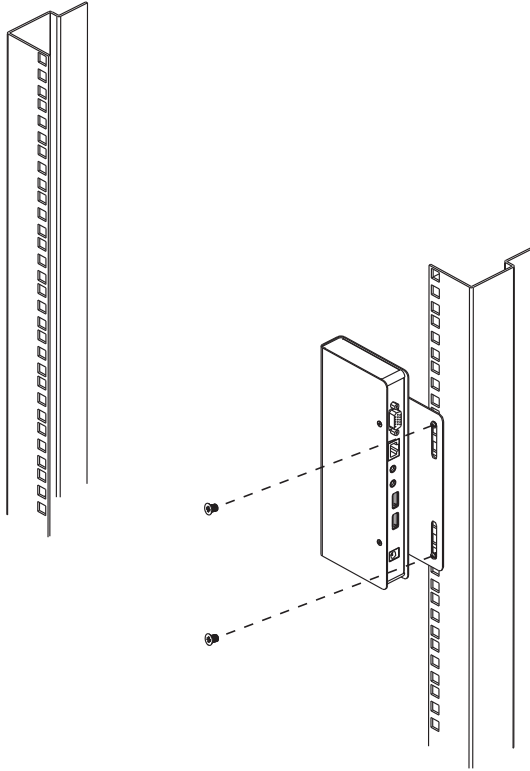

---

**Note:** These screws are not provided. We recommend that you use M5 x 12 Phillips Type I cross, recessed type screws.

---

## Installation

### Grounding

To prevent damage to your installation it is important that all devices are properly grounded.

1. Use two grounding wires to ground both units by connecting one end of a wire to the grounding terminal, and the other end of the wire to a suitable grounded object.

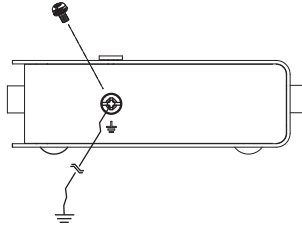

2. Make sure that the computer that the CE770L connects to and the monitor that the CE770RQ connects to are properly grounded.

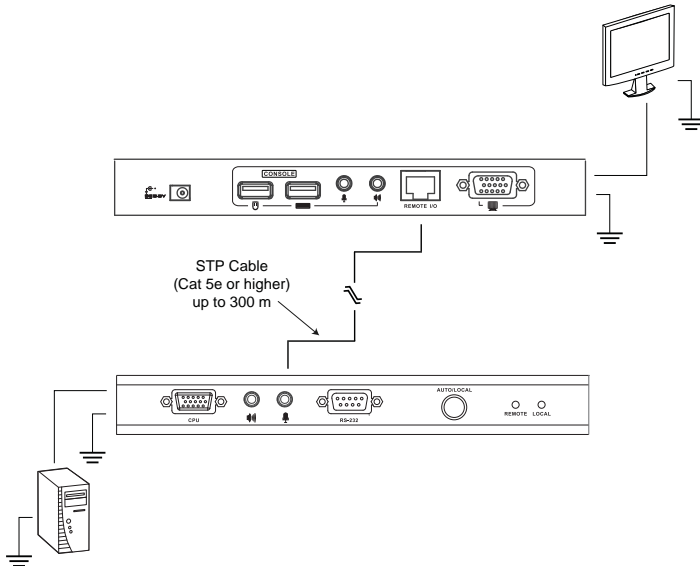

3. For increased grounding protection, use STP (shielded twisted pair) cable to connect the Local and Remote Units. There are two methods that can be used:

a) In addition to the eight paired wires, STP cable also contains a grounding wire. Solder this wire to the RJ-45 connector as shown in the diagram below:

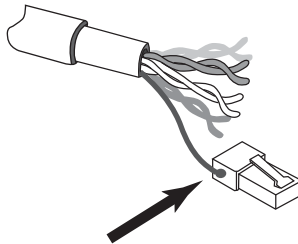

b) The second method is to use the STP cable shielding for grounding. In this case, make sure that the shielding makes tight contact with the top inside of the RJ-45 connector as shown in the diagram below:

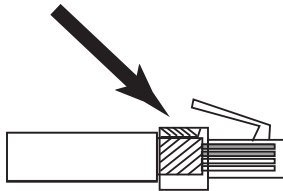

In either case, make sure that the sides of the RJ-45 connector make tight contact with the grounding contacts on the sides of the RJ-45 socket as shown in the diagram below:

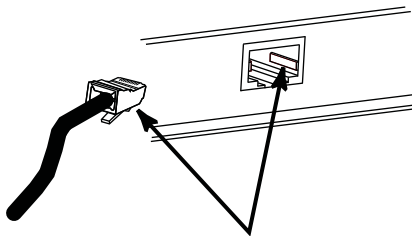

## Setting Up

Setting up the CE770 USB KVM Extender system is simply a matter of plugging in the cables. Make sure that all the equipment to be connected up is powered Off. Refer to the installation diagram on the following page and do the following:

1. Plug the cables from the local console devices (mouse, keyboard, monitor, microphone, speakers) into their ports on the Console section on the rear of the Local Unit (CE770L). Each port is marked with an appropriate icon to indicate itself.
2. Plug the appropriate connectors on the USB KVM cable supplied with this unit into their ports on the CPU section on the front of the Local Unit (CE770L).
3. Plug the connectors on the other end of the USB KVM cable into the appropriate ports on the local computer. Each connector is marked with an appropriate icon to indicate which it is.

---

**Note:** If you are combining the CE770 with a KVM switch, the other end of the USB KVM cable plugs into the appropriate ports on the KVM switch.

---

4. For control of serial devices, connect the RS-232 serial port on the local unit to a serial port on the local computer.
5. Plug either end of the Cat 5e cable into the CE770L's Remote I/O port. Plug the other end of the Cat 5e cable into the I/O port of the Remote Unit (CE770RQ).
6. Plug one of the power adapters (supplied with this package) into an AC source; plug the adapter's power cable into the CE770L's Power Jack.
7. Plug the cables from the remote console devices (mouse, keyboard, monitor, speakers, microphone), into their ports on the Console side of the CE770RQ.
8. Plug the second power adapter (supplied with this package) into an AC source; plug the adapter's power cable into the CE770RQ's Power Jack.

---

**Note:** Hot-plugging the cat5 cable will automatically trigger the deskew function.

---

## Installation Diagrams

### CE770L / CE770RQ Rear View

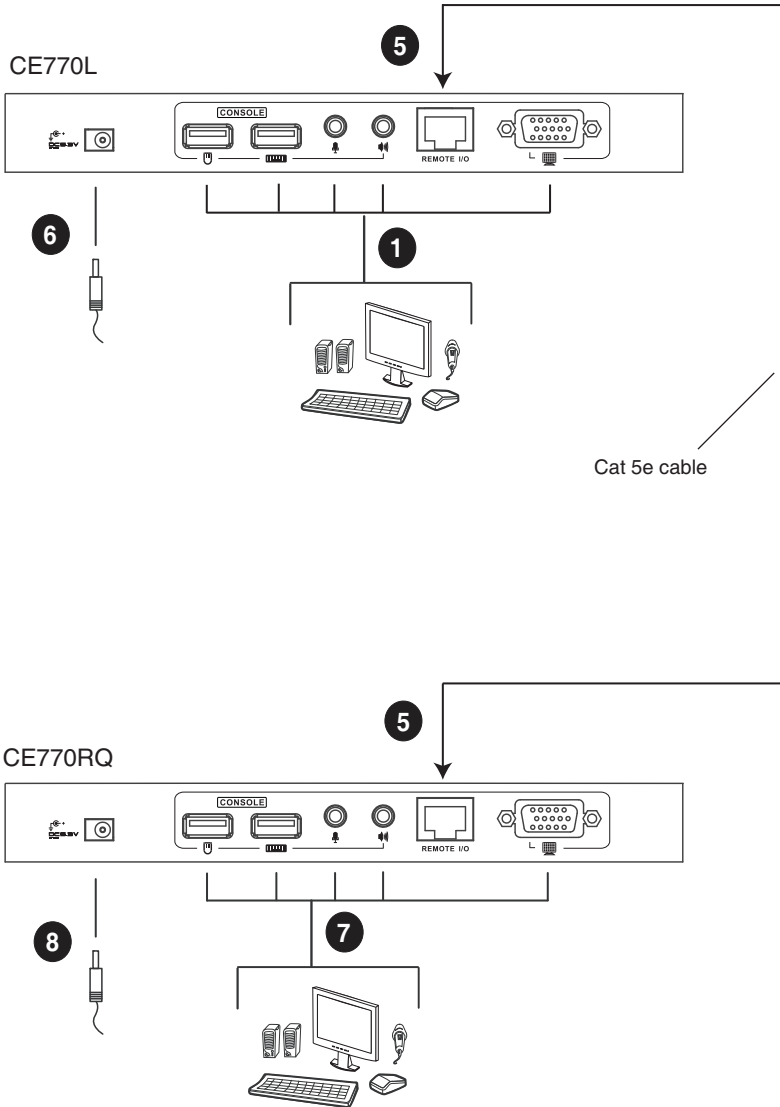

## CE770L Front View

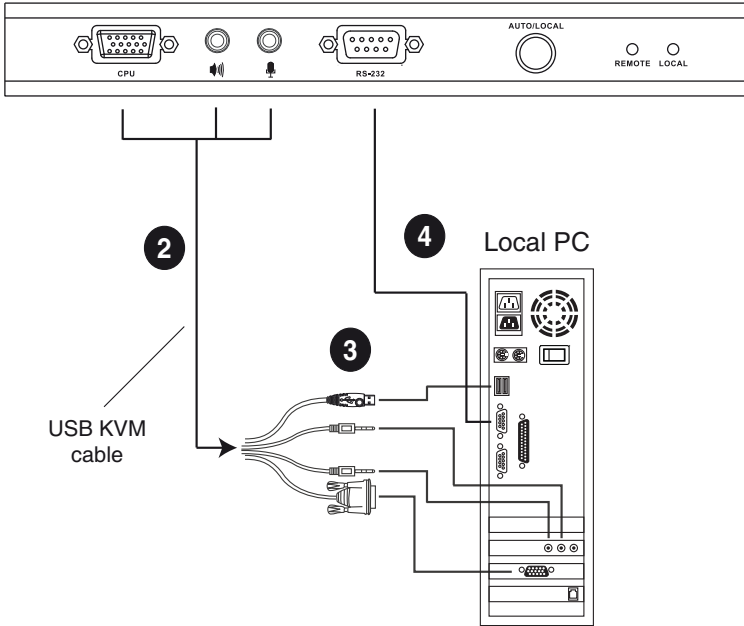

This Page Intentionally Left Blank



# Chapter 3

## Operation

### Operating Modes

---

The CE770 USB KVM Extender has three operating modes: Local, Auto, and Remote, as described in the table below:

| Mode   | Description  |
|--------|--|
| Local  | Only the local console has KVM access. The remote console's keyboard and mouse input is disabled.  |
| Auto   | Both the local and remote consoles can have KVM access, but not at the same time. The console without access has to wait until the console with access stops inputting data before it can gain access. |
| Remote | The remote console has KVM access. Remote mode can only occur when the pushbutton on the CE770L is set to <i>Auto</i> and the local console is idle. See note on page 18.                              |

---

**Note:** The default operating mode is *Auto*.

---

## Mode Selection

---

The *Operating Mode Pushbutton*, located on the CE770L's front panel, controls the operating mode of the CE770 USB KVM Extender system. Pressing the switch toggles through *Local* and *Auto* operating modes.

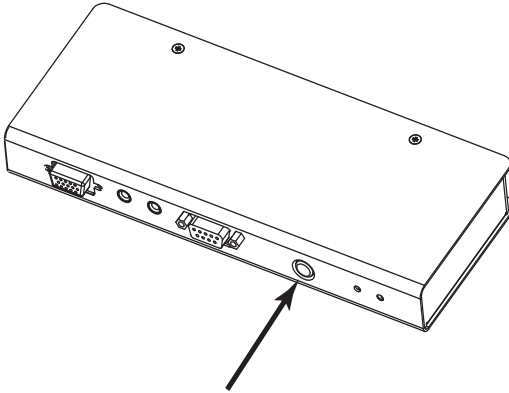

---

**Note:** Remote mode cannot be selected. The remote console can get control only when the Operating Mode Pushbutton on the CE770L is toggled to *Auto* and the local console is idle. If the remote console is then idle for more than five seconds, the local console can gain access.

---

## Deskew and Picture Compensation

The quality of the video display can deteriorate with distance. The pushbuttons on the front panel of the CE770RQ adjust the quality of the video on the remote console.

If it becomes necessary to fine-tune the video signal, press the color button to choose color (RGB) or compensation to adjust (see table below).

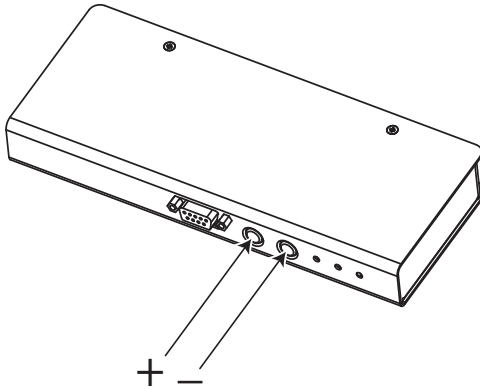

### Color / Video Compensation (Remote Unit)

| Button / Switch | Description  |
|-----------------|--|
| Color / +       | <ol style="list-style-type: none"> <li>1. Press the button to choose which color (RGB) or Compensation will be selected. (the sequence is R _ G _ B _ Video Compensation _ R ... )</li> <li>2. If the color or Compensation is selected, press the button to increase the value (delay time / Compensation) of the selection.</li> </ol> |
| Select / -      | <ol style="list-style-type: none"> <li>1. Press the button to select the color or Compensation.</li> <li>2. If Color or Compensation is selected, press the button to decrease the value (delay time / Compensation) of the selection. (B LED will light and turn off)</li> </ol>  |

## LED Display

---

The CE770 Local and Remote Units have front panel LEDs to indicate their operating status, as shown in the tables, below:

### **CE770L (Local Unit)**

| LED            | Operating Mode   |  |
|----------------|--|--|
|                | Local  | Auto   |
| Local (Green)  | Lights to indicate that the local console is active (the Remote LED is off). | Lights when the local console is active (the Remote LED is off).<br>Turns off when the remote console is active (the Remote LED turns on).<br>Flashes on and off alternately with the Remote LED when neither console is active. |
| Remote (Green) | The LED is off   | Lights when the remote console is active (the Local LED is off).<br>Turns off when the local console is active (the Local LED turns on).<br>Flashes on and off alternately with the Local LED when neither console is active.    |

**CE770RQ (Remote Unit)**

| LED                        | Indication  |
|----------------------------|---|
| B<br>(Blue)                | <p>Lights to indicate that the BLUE color will be selected to adjust the delay time of the BLUE color.</p> <p>Flashes to indicate that the BLUE color is selected and the pushbutton can be used to adjust the delay time of the BLUE color.</p>  |
| Link / G<br>(Orange/Green) | <p>Lights Orange to indicate that the connection to the Local unit is ok.</p> <p>Flashes Orange when there is a problem with the connection to the Local unit and the "Remote LED (Red)" is off.</p> <p>Lights Green to indicate that the GREEN color will be selected to adjust the delay time of the GREEN color.</p> <p>Flashes Green to indicate that the GREEN color is selected and the pushbutton can be used to adjust the delay time of GREEN color.</p>   |
| Remote / R<br>(Red)        | <p>Lights Red to indicate that the remote console is active.</p> <p>Turns off when the local console is active.</p> <p>Remote LED (Red) flashes when Auto Mode.</p> <p>Lights Red to indicate that the RED color will be selected to adjust the delay time of the RED color.</p> <p>Flashes Red to indicate that the RED color is selected and the pushbutton can be used to adjust the delay time of RED color.</p> <p>Both Red and Green light to indicate that the Video Compensation will be selected to adjust.</p> <p>Both Red and Green flash to indicate that the Video Compensation is selected and the pushbutton can be used to adjust the Video Compensation.</p> |

## Hotkey Setting Mode

---

The administrator and users can use hotkey combinations to configure a number of the KVM Extender's working environment parameters. All Hotkey operations begin by invoking Hotkey Setting Mode (HSM).

### **Invoking HSM**

To invoke HSM (CE770L only), do the following:

1. Hold down **[Ctrl]**.
2. Press and release **[F12]**.
3. Release **[Ctrl]**.

---

**Note:** There is an alternative key combination to invoke HSM (see *Alternate HSM Invocation Keys*, page 23).

---

### **When Hotkey Mode is active:**

- ◆ The Caps Lock, and Scroll Lock LEDs flash in succession to indicate that HSM is in effect. They stop flashing and revert to normal status when you exit HSM.
- ◆ A Command Line appears on the monitor screen. The command line prompt is the word *Hotkey:* in yellow text on a blue background. Hotkey information that you key in displays on the command line.
- ◆ Ordinary keyboard and mouse functions are suspended – only Hotkey compliant keystrokes and mouse clicks (described in the sections that follow), can be input.
- ◆ At the conclusion of some hotkey operations, you automatically exit hotkey mode. With some operations, you must exit manually. To exit HSM manually, press **[Esc]** or **[Spacebar]**.

## **Alternate HSM Invocation Keys**

An alternate set of HSM invocation keys is provided in case the default set conflicts with programs running on the computers.

To switch to the alternate HSM invocation set, do the following:

1. Invoke HSM (see page 22).
2. Press and release [**H**].

The HSM invocation keys become the Num Lock key (instead of Ctrl) and the minus key (instead of F12).

---

**Note:** This procedure is a toggle between the two methods. To revert back to the original [Ctrl] [F12] method, invoke HSM, then press and release the **H** key again.

---

## **Keyboard Operating Platform**

The CE770's default configuration is for a PC Compatible keyboard operating platform. If you have a Mac or a Sun on your installation, you can change the keyboard operating platform as follows:

3. Invoke HSM (see page 22).
4. Press and release the appropriate Function key (see table).

| <b>Key</b> | <b>Operation</b>  |
|------------|---|
| [F1]       | Sets the PC compatible keyboard operating platform for the port that currently has the KVM focus. |
| [F2]       | Enables Mac keyboard emulation.   |
| [F3]       | Enables Sun keyboard emulation.   |
| [F4]       | Print out the KVM's current settings and quit the Setting mode.                                   |

---

**Note:** 1. The brackets indicate the keys you should press. Simply press the indicated keys – do not type the brackets.

2. After completing a setting, you automatically exit HSM.
-

## **Hotkey Summary Table**

After invoking HSM (see page 22), key in one of the following keys to perform the corresponding function:

| <b>Key</b> | <b>Function</b>  |
|------------|--|
| [H]        | Toggles between the default ([Ctrl] [F12]) and alternate ([Num Lock] [-]) Hotkey invocation keys.  |
| [F1]       | Sets the PC compatible keyboard operating platform for the port that currently has the KVM focus.  |
| [F2]       | Sets the Mac compatible keyboard operating platform for the port that currently has the KVM focus. |
| [F3]       | Sets the Sun keyboard operating platform for the port that currently has the KVM focus.            |
| [F4]       | Print out the KVM's current settings and quit the Setting mode.                                    |

---

**Note:** The brackets indicate the keys you should press. Simply press the indicated keys – do not type the brackets.

---











# Chapter 4

## Keyboard Emulation

### Mac Keyboard

---

The PC compatible (101/104 key) keyboard can emulate the functions of the Mac keyboard. The emulation mappings are listed in the table below.

| PC Keyboard  | Mac Keyboard  |
|--|---|
| [Shift]  | Shift   |
| [Ctrl]   | Ctrl  |
|           |  |
| [Ctrl] [1]   |  |
| [Ctrl] [2]   |  |
| [Ctrl] [3]   |  |
| [Ctrl] [4]   |  |
| [Alt]  | Alt   |
| [Print Screen]   | F13   |
| [Scroll Lock]  | F14   |
|           | =   |
| [Enter]  | Return  |
| [Backspace]  | Delete  |
| [Insert]   | Help  |
| [Ctrl]  | F15   |







---

**Note:** When using key combinations, press and release the first key (Ctrl), then press and release the activation key.

---

## Sun Keyboard

The PC compatible (101/104 key) keyboard can emulate the functions of the Sun keyboard when the Control key [Ctrl] is used in conjunction with other keys. The corresponding functions are shown in the table below.

| PC Keyboard   | Sun Keyboard  |
|---|---|
| [Ctrl] [T]  | Stop  |
| [Ctrl] [F2]   | Again   |
| [Ctrl] [F3]   | Props   |
| [Ctrl] [F4]   | Undo  |
| [Ctrl] [F5]   | Front   |
| [Ctrl] [F6]   | Copy  |
| [Ctrl] [F7]   | Open  |
| [Ctrl] [F8]   | Paste   |
| [Ctrl] [F9]   | Find  |
| [Ctrl] [F10]  | Cut   |
| [Ctrl] [1]  |    |
| [Ctrl] [2]  |    |
| [Ctrl] [3]  |    |
| [Ctrl] [4]  |    |
| [Ctrl] [H]  | Help  |
|   | Compose   |
|  |  |

**Note:** When using key combinations, press and release the first key (Ctrl), then press and release the activation key.

## Safety Instructions

---

### General

- ◆ Read all of these instructions. Save them for future reference.
- ◆ Follow all warnings and instructions marked on the device.
- ◆ Do not place the device on any unstable surface (cart, stand, table, etc.). If the device falls, serious damage will result.
- ◆ Do not use the device near water.
- ◆ Do not place the device near, or over, radiators or heat registers.
- ◆ The device cabinet is provided with slots and openings to allow for adequate ventilation. To ensure reliable operation, and to protect against overheating, these openings must never be blocked or covered.
- ◆ The device should never be placed on a soft surface (bed, sofa, rug, etc.) as this will block its ventilation openings. Likewise, the device should not be placed in a built in enclosure unless adequate ventilation has been provided.
- ◆ Never spill liquid of any kind on the device.
- ◆ Unplug the device from the wall outlet before cleaning. Do not use liquid or aerosol cleaners. Use a damp cloth for cleaning.
- ◆ The device should be operated from the type of power source indicated on the marking label. If you are not sure of the type of power available, consult your dealer or local power company.
- ◆ The device is designed for IT power distribution systems with 230V phase-to-phase voltage.
- ◆ To prevent damage to your installation, it is important that all devices are properly grounded.
- ◆ The device is equipped with a 3-wire grounding type plug. This is a safety feature. If you are unable to insert the plug into the outlet, contact your electrician to replace your obsolete outlet. Do not attempt to defeat the purpose of the grounding-type plug. Always follow your local/national wiring codes.
- ◆ Do not allow anything to rest on the power cord or cables. Route the power cord and cables so that they cannot be stepped on or tripped over.

- ◆ If an extension cord is used with this device make sure that the total of the ampere ratings of all products used on this cord does not exceed the extension cord ampere rating. Make sure that the total of all products plugged into the wall outlet does not exceed 15 amperes.
- ◆ To help protect your system from sudden, transient increases and decreases in electrical power, use a surge suppressor, line conditioner, or un-interruptible power supply (UPS).
- ◆ Position system cables and power cables carefully; Be sure that nothing rests on any cables.
- ◆ Never push objects of any kind into or through cabinet slots. They may touch dangerous voltage points or short out parts resulting in a risk of fire or electrical shock.
- ◆ Do not attempt to service the device yourself. Refer all servicing to qualified service personnel.
- ◆ If the following conditions occur, unplug the device from the wall outlet and bring it to qualified service personnel for repair.
  - ◆ The power cord or plug has become damaged or frayed.
  - ◆ Liquid has been spilled into the device.
  - ◆ The device has been exposed to rain or water.
  - ◆ The device has been dropped, or the cabinet has been damaged.
  - ◆ The device exhibits a distinct change in performance, indicating a need for service.
  - ◆ The device does not operate normally when the operating instructions are followed.
- ◆ Only adjust those controls that are covered in the operating instructions. Improper adjustment of other controls may result in damage that will require extensive work by a qualified technician to repair.
- ◆ Do not connect the RJ-11 connector marked “UPGRADE” to a public telecommunication network.

## **Rack Mounting**

- ◆ Before working on the rack, make sure that the stabilizers are secured to the rack, extended to the floor, and that the full weight of the rack rests on the floor. Install front and side stabilizers on a single rack or front stabilizers for joined multiple racks before working on the rack.
- ◆ Always load the rack from the bottom up, and load the heaviest item in the rack first.
- ◆ Make sure that the rack is level and stable before extending a device from the rack.
- ◆ Use caution when pressing the device rail release latches and sliding a device into or out of a rack; the slide rails can pinch your fingers.
- ◆ After a device is inserted into the rack, carefully extend the rail into a locking position, and then slide the device into the rack.
- ◆ Do not overload the AC supply branch circuit that provides power to the rack. The total rack load should not exceed 80 percent of the branch circuit rating.
- ◆ Make sure that all equipment used on the rack – including power strips and other electrical connectors – is properly grounded.
- ◆ Ensure that proper airflow is provided to devices in the rack.
- ◆ Ensure that the operating ambient temperature of the rack environment does not exceed the maximum ambient temperature specified for the equipment by the manufacturer.
- ◆ Do not step on or stand on any device when servicing other devices in a rack.

## Technical Support

---

### International

- ◆ For online technical support – including troubleshooting, documentation, and software updates: **<http://support.aten.com>**
- ◆ For telephone support, *Telephone Support*, page iii

### North America

|                          |  |   |
|--------------------------|--|---|
| Email Support            |  | <a href="mailto:support@aten-usa.com">support@aten-usa.com</a>                |
| Online Technical Support | Troubleshooting<br>Documentation<br>Software Updates | <a href="http://www.aten-usa.com/support">http://www.aten-usa.com/support</a> |
| Telephone Support        |  | 1-888-999-ATEN ext 4988   |

When you contact us, please have the following information ready beforehand:

- ◆ Product model number, serial number, and date of purchase.
- ◆ Your computer configuration, including operating system, revision level, expansion cards, and software.
- ◆ Any error messages displayed at the time the error occurred.
- ◆ The sequence of operations that led up to the error.
- ◆ Any other information you feel may be of help.

# Specifications

| Function            |                          | CE770L   | CE770RQ                             |                       |
|---------------------|--------------------------|--|-------------------------------------|-----------------------|
| Connectors          | Console Ports            | Keyboard   | 1 x USB Type A Female (White)       |                       |
|                     |                          | Video  | 1 x HDB-15 Female (Blue)            |                       |
|                     |                          | Mouse  | 1 x USB Type A Female (White)       |                       |
|                     |                          | Speakers   | 1 x Mini Stereo Jack Female (Green) |                       |
|                     |                          | Mic.   | 1 x Mini Stereo Jack Female (Pink)  |                       |
|                     |                          | RS-232   | 1 x DB-9 Female (Black)             | 1 x DB-9 Male (Black) |
|                     | KVM Ports                | KB / Video / Mouse   | 1 x SPHD-18 Female (Yellow)         | N/A                   |
|                     |                          | Speakers   | 1 x Mini Stereo Jack (Green)        |                       |
|                     |                          | Mic.   | 1 x Mini Stereo Jack (Pink)         |                       |
|                     | Unit to Unit             |  | 1 x RJ-45 Female (Black)            |                       |
| Power               |                          | 1 x DC Jack (Black)  |                                     |                       |
| LEDs                | Local                    |  | 1 (Green)                           | N/A                   |
|                     | Remote                   |  | 1 (Green)                           | N/A                   |
|                     | B                        |  | N/A                                 | 1 (Blue)              |
|                     | G                        | Link   | N/A                                 | 1 (Orange/Green)      |
|                     | R                        | Remote   | N/A                                 | 1 (Red)               |
| Pushbuttons         | Operating Mode Selection |  | 1 x Pushbutton                      | N/A                   |
|                     | Color / Up               |  | N/A                                 | 1 x Pushbutton        |
|                     | Select / Down            |  | N/A                                 | 1 x Pushbutton        |
| Emulation           | Keyboard / Mouse         |  | USB                                 |                       |
| Video               |                          | 1920 x 1200 @ 60Hz (150 m); 1280 x 1024 @ 60Hz (300 m); DDC, DDC2, DDC2B |                                     |                       |
| Power Consumption   |                          | DC5.3V/3.5W  | DC5.3V/5.1W                         |                       |
| Environment         | Operating Temp.          |  | 0–50°C                              |                       |
|                     | Storage Temp             |  | -20–60°C                            |                       |
|                     | Humidity                 |  | 0–80% RH, Non-condensing            |                       |
| Physical Properties | Housing                  |  | Metal                               |                       |
|                     | Weight                   |  | 0.49 kg                             | 0.48 kg               |
|                     | Dimensions (L x W x H)   |  | 20.0 x 8.0 x 2.5 cm                 |                       |

## Troubleshooting

---

### Overview

Operation problems can be due to a variety of causes. The first step in solving them is to make sure that all cables are securely attached and seated completely in their sockets.

| Problem            | Action  |
|--------------------|---|
| No video           | Make sure that all cables are securely plugged into their sockets.  |
| Poor quality video | Hot-plug the Cat 5e cable again to trigger the deskew function.<br><br>The video quality can be improved by using the Picture Compensation pushbuttons on the CE770RQ to increase or reduce the video signal gain.<br><br>The video quality can be improved by reducing the refresh rate. |

## About SPHD Connectors

---



This product uses SPHD connectors for its KVM and/or Console ports. We have specifically modified the shape of these connectors so that only KVM cables that we have designed to work with this product can be connected.



## Limited Warranty

---

IN NO EVENT SHALL THE DIRECT VENDOR'S LIABILITY EXCEED THE PRICE PAID FOR THE PRODUCT FROM DIRECT, INDIRECT, SPECIAL, INCIDENTAL, OR CONSEQUENTIAL DAMAGES RESULTING FROM THE USE OF THE PRODUCT, DISK, OR ITS DOCUMENTATION.

The direct vendor makes no warranty or representation, expressed, implied, or statutory with respect to the contents or use of this documentation, and especially disclaims its quality, performance, merchantability, or fitness for any particular purpose.

The direct vendor also reserves the right to revise or update the device or documentation without obligation to notify any individual or entity of such revisions, or update. For further inquiries, please contact your direct vendor.