

FUJIFILM

DIGITAL CAMERA

X-E3

Owner's Manual

Introduction

Thank you for your purchase of this product. Be sure that you have read this manual and understood its contents before using the camera. Keep the manual where it will be read by all who use the product.

For the Latest Information

The latest versions of the manuals are available from:

<http://fujifilm-dsc.com/en/manual/>



The site can be accessed not only from your computer but also from smartphones and tablets.



For information on firmware updates, visit:

http://www.fujifilm.com/support/digital_cameras/software/

fujifilm firmware





Chapter Index

Menu List	iv
1 Before You Begin	1
2 First Steps	27
3 Basic Photography and Playback	47
4 Movie Recording and Playback	53
5 Taking Photographs	61
6 The Shooting Menus	113
7 Playback and the Playback Menu	173
8 The Setup Menus	201
9 Shortcuts	245
10 Peripherals and Optional Accessories	259
11 Connections	281
12 Technical Notes	293



Menu List

Camera menu options are listed below.

Shooting Menus

Adjust settings when shooting photos or movies.

 See page 113 for details.

1/3	IMAGE QUALITY SETTING		AF/MF	AF/MF SETTING	
1/3	IMAGE SIZE	115	1/3	FOCUS AREA	133
	IMAGE QUALITY	116		AF MODE	134
	RAW RECORDING	117		AF-C CUSTOM SETTINGS	135
	FILM SIMULATION	118		STORE AF MODE BY ORIENTATION	136
	GRAIN EFFECT	120		AF POINT DISPLAY 	136
	DYNAMIC RANGE	121		NUMBER OF FOCUS POINTS	137
	WHITE BALANCE	122		PRE-AF	137
	HIGHLIGHT TONE	126		AF-ILLUMINATOR	138
	SHADOW TONE	126		FACE/EYE DETECTION SETTING	139
	COLOR	127		AF+MF	141
2/3	SHARPNESS	127	MF ASSIST	142	
	NOISE REDUCTION	128	FOCUS CHECK	143	
	LONG EXPOSURE NR	128	INTERLOCK SPOT AE & FOCUS AREA	143	
	LENS MODULATION OPTIMIZER	129	INSTANT AF SETTING	144	
	COLOR SPACE	129	DEPTH-OF-FIELD SCALE	144	
3/3	PIXEL MAPPING	130	RELEASE/FOCUS PRIORITY	145	
	SELECT CUSTOM SETTING	131	TOUCH SCREEN MODE	146	
	EDIT/SAVE CUSTOM SETTING	131			

	SHOOTING SETTING				FLASH SETTING		
	SCENE POSITION		149		FLASH FUNCTION SETTING		164
	SELF-TIMER		151		RED EYE REMOVAL		165
	INTERVAL TIMER		152		TTL-LOCK MODE		166
1/2	SHOOTING		152		LED LIGHT SETTING		167
	AE BKT SETTING		154		MASTER SETTING		167
	FILM SIMULATION BKT		154		CH SETTING		168
	PHOTOMETRY		155		MOVIE SETTING		
	SHUTTER TYPE		156		MOVIE MODE		169
	IS MODE		157		MOVIE AF MODE		170
	ISO		158		HDMI OUTPUT INFO DISPLAY		170
2/2	MOUNT ADAPTOR SETTING		161		4K MOVIE OUTPUT		171
	WIRELESS		163		HDMI REC CONTROL		171
	COMMUNICATION		163		MIC LEVEL ADJUSTMENT		172
					MIC/REMOTE RELEASE		172

The Playback Menu

Adjust playback settings.







See page 180 for details.

	PLAY BACK MENU				PLAY BACK MENU		
	RAW CONVERSION		180		IMAGE TRANSFER ORDER		192
	ERASE		183		WIRELESS		193
	CROP		186		COMMUNICATION		193
1/2	RESIZE		187		SLIDE SHOW		193
	PROTECT		188	2/2	PHOTOBOOK ASSIST		194
	IMAGE ROTATE		189		PC AUTO SAVE		196
	RED EYE REMOVAL		190		PRINT ORDER (DPOF)		197
	VOICE MEMO SETTING		191		instax PRINTER PRINT		199
					DISP ASPECT		200

Setup Menus

Adjust basic camera settings.

 See page 201 for details.

 USER SETTING		 SCREEN SETTING	
FORMAT	203	EVF BRIGHTNESS	214
DATE/TIME	204	EVF COLOR	215
TIME DIFFERENCE	205	LCD BRIGHTNESS	215
言語/LANG.	206	LCD COLOR	216
MY MENU SETTING	206	1½ IMAGE DISP.	216
SENSOR CLEANING	208	AUTOROTATE DISPLAYS	217
RESET	209	PREVIEW EXP./WB IN MANUAL MODE	217
 SOUND SETTING		PREVIEW PIC. EFFECT	218
AF BEEP VOL.	210	FRAMING GUIDELINE	219
SELF-TIMER BEEP VOL.	211	2½ AUTOROTATE PB	220
OPERATION VOL.	211	FOCUS SCALE UNITS	220
SHUTTER VOLUME	212	DISP. CUSTOM SETTING	221
SHUTTER SOUND	212		
PLAYBACK VOLUME	213		









	 BUTTON/DIAL SETTING	
	FOCUS LEVER SETTING	223
	EDIT/SAVE QUICK MENU	224
	FUNCTION (Fn) SETTING	226
	COMMAND DIAL SETTING	228
1/2	 S.S. OPERATION	228
	ISO COMMAND DIAL SETTING	229
	SHUTTER AF	229
	SHUTTER AE	230
	SHOOT WITHOUT LENS	230
	SHOOT WITHOUT CARD	231
2/2	FOCUS RING	231
	AE/AF-LOCK MODE	232
	APERTURE SETTING	232
	TOUCH SCREEN SETTING	233
	 POWER MANAGEMENT	
	AUTO POWER OFF	234
	PERFORMANCE	235
	 SAVE DATA SETTING	
	FRAME NO.	237
	SAVE ORG IMAGE	238
	EDIT FILE NAME	238
	COPYRIGHT INFO	239
	 CONNECTION SETTING	
	Bluetooth SETTINGS	241
	PC AUTO SAVE SETTINGS	242
	instax PRINTER CONNECTION SETTING	242
	GENERAL SETTINGS	243
	INFORMATION	244
	RESET WIRELESS SETTING	244



Table of Contents

Introduction	ii
For the Latest Information.....	ii
Menu List	iv
Shooting Menus.....	iv
The Playback Menu	v
Setup Menus.....	vi
Supplied Accessories	xix
About This Manual	xx
Symbols and Conventions	xx
Terminology	xx

1 Before You Begin **1**



Parts of the Camera	2
The Serial Number Plate	4
The Focus Stick (Focus Lever).....	4
The Shutter Speed Dial.....	5
The Exposure Compensation Dial.....	5
The DRIVE Button.....	6
The Auto Mode Selector Lever.....	7
The Command Dials	8
The Indicator Lamp	10
The LCD Monitor.....	11
Focusing the Viewfinder.....	11
Camera Displays	12
Electronic Viewfinder/LCD Monitor.....	12
Choosing a Display Mode	14









Adjusting Display Brightness and Color	15
Display Rotation.....	15
The DISP/BACK Button	16
Customizing the Standard Display	17
Using the Menus	20
Touch Screen Mode.....	22
Shooting Touch Controls	22
Playback Touch Controls	25





2 First Steps 27

Attaching the Strap.....	28
Attaching a Lens.....	30
Charging the Battery	32
Inserting Batteries and Memory Cards	36
Compatible Memory Cards	40
Turning the Camera On and Off	42
Checking the Battery Level.....	43
Basic Setup	44
Choosing a Different Language.....	46
Changing the Time and Date.....	46

3 Basic Photography and Playback 47



Taking Photographs (Mode P).....	48
 Viewing Pictures.....	51
 Deleting Pictures	52

4	Movie Recording and Playback	53
	Recording Movies	54
	Adjusting Movie Settings.....	57
	Viewing Movies.....	58
5	Taking Photographs	61
	Choosing a Shooting Mode	62
	Mode P: Program AE	62
	Mode S: Shutter-Priority AE	64
	Mode A: Aperture-Priority AE.....	69
	Mode M: Manual Exposure.....	72
	Auto Mode.....	74
	Autofocus.....	77
	Focus Mode.....	78
	Autofocus Options (AF Mode).....	80
	Focus-Point Selection.....	82
	Manual Focus.....	87
	Checking Focus.....	89
	Exposure Compensation.....	91
	C (Custom)	91
	Focus/Exposure Lock.....	92
	The AF-L and AE-L Buttons.....	93
	BKT Bracketing.....	94
	AE BKT	95
	ISO BKT.....	95
	FILM SIMULATION BKT.....	95
	WHITE BALANCE BKT.....	96
	DYNAMIC RANGE BKT.....	96

 Continuous Shooting (Burst Mode)	97
 Advanced Filters	99
Advanced Filter Options	100
 Multiple Exposures	101
 Panoramas	103
Flash Photography	107
Flash Settings	109

6 The Shooting Menus **113**

 IMAGE QUALITY SETTING	114
IMAGE SIZE	115
IMAGE QUALITY	116
RAW RECORDING	117
FILM SIMULATION	118
GRAIN EFFECT	120
DYNAMIC RANGE	121
WHITE BALANCE	122
HIGHLIGHT TONE	126
SHADOW TONE	126
COLOR	127
SHARPNESS	127
NOISE REDUCTION	128
LONG EXPOSURE NR	128
LENS MODULATION OPTIMIZER	129
COLOR SPACE	129
PIXEL MAPPING	130
SELECT CUSTOM SETTING	131
EDIT/SAVE CUSTOM SETTING	131

AF/MF	AF/MF SETTING	133
	FOCUS AREA	133
	AF MODE	134
	AF-C CUSTOM SETTINGS	135
	STORE AF MODE BY ORIENTATION	136
	AF POINT DISPLAY  	136
	NUMBER OF FOCUS POINTS	137
	PRE-AF	137
	AF ILLUMINATOR	138
	FACE/EYE DETECTION SETTING	139
	AF+MF	141
	MF ASSIST	142
	FOCUS CHECK	143
	INTERLOCK SPOT AE & FOCUS AREA	143
	INSTANT AF SETTING	144
	DEPTH-OF-FIELD SCALE	144
	RELEASE/FOCUS PRIORITY	145
	TOUCH SCREEN MODE	146
📷	SHOOTING SETTING	149
	SCENE POSITION	149
	SELF-TIMER	151
	INTERVAL TIMER SHOOTING	152
	AE BKT SETTING	154
	FILM SIMULATION BKT	154
	PHOTOMETRY	155
	SHUTTER TYPE	156
	IS MODE	157
	ISO	158

MOUNT ADAPTOR SETTING	161
WIRELESS COMMUNICATION	163
⚡ FLASH SETTING.....	164
FLASH FUNCTION SETTING	164
RED EYE REMOVAL	165
TTL-LOCK MODE.....	166
LED LIGHT SETTING	167
MASTER SETTING	167
CH SETTING.....	168
🎬 MOVIE SETTING	169
MOVIE MODE.....	169
MOVIE AF MODE	170
HDMI OUTPUT INFO DISPLAY.....	170
4K MOVIE OUTPUT	171
HDMI REC CONTROL.....	171
MIC LEVEL ADJUSTMENT	172
MIC/REMOTE RELEASE.....	172

7 Playback and the Playback Menu **173**

The Playback Display	174
The DISP/BACK Button	176
Viewing Pictures.....	178
Playback Zoom.....	179
Multi-Frame Playback.....	179
🖼️ The Playback Menu	180
RAW CONVERSION	180
ERASE.....	183
CROP	186

RESIZE.....	187
PROTECT.....	188
IMAGE ROTATE	189
RED EYE REMOVAL	190
VOICE MEMO SETTING	191
IMAGE TRANSFER ORDER.....	192
WIRELESS COMMUNICATION	193
SLIDE SHOW.....	193
PHOTOBOOK ASSIST	194
PC AUTO SAVE.....	196
PRINT ORDER (DPOF).....	197
instax PRINTER PRINT.....	199
DISP ASPECT	200

8 The Setup Menus 201

USER SETTING	202
FORMAT	203
DATE/TIME.....	204
TIME DIFFERENCE	205
言語/LANG.....	206
MY MENU SETTING.....	206
SENSOR CLEANING.....	208
RESET	209
SOUND SETTING	210
AF BEEP VOL.....	210
SELF-TIMER BEEP VOL.....	211
OPERATION VOL.....	211
SHUTTER VOLUME.....	212

SHUTTER SOUND	212
PLAYBACK VOLUME	213
SCREEN SETTING	214
EVF BRIGHTNESS	214
EVF COLOR	215
LCD BRIGHTNESS	215
LCD COLOR	216
IMAGE DISP	216
AUTOROTATE DISPLAYS	217
PREVIEW EXP./WB IN MANUAL MODE	217
PREVIEW PIC. EFFECT	218
FRAMING GUIDELINE	219
AUTOROTATE PB	220
FOCUS SCALE UNITS	220
DISP. CUSTOM SETTING	221
BUTTON/DIAL SETTING	223
FOCUS LEVER SETTING	223
EDIT/SAVE QUICK MENU	224
FUNCTION (Fn) SETTING	226
COMMAND DIAL SETTING	228
S.S. OPERATION	228
ISO COMMAND DIAL SETTING	229
SHUTTER AF	229
SHUTTER AE	230
SHOOT WITHOUT LENS	230
SHOOT WITHOUT CARD	231
FOCUS RING	231
AE/AF-LOCK MODE	232

APERTURE SETTING	232
TOUCH SCREEN SETTING	233
⚡ POWER MANAGEMENT	234
AUTO POWER OFF	234
PERFORMANCE.....	235
💾 SAVE DATA SETTING.....	236
FRAME NO.	237
SAVE ORG IMAGE	238
EDIT FILE NAME.....	238
COPYRIGHT INFO	239
🔌 CONNECTION SETTING.....	240
Bluetooth SETTINGS.....	241
PC AUTO SAVE SETTINGS	242
instax PRINTER CONNECTION SETTING	242
GENERAL SETTINGS.....	243
INFORMATION.....	244
RESET WIRELESS SETTING	244

9 Shortcuts 245

Shortcut Options.....	246
The Q (Quick Menu) Button.....	247
The Quick Menu Display	247
Viewing and Changing Settings.....	249
Editing the Quick Menu.....	250
The Fn (Function) Buttons	252
Assigning Roles to the Function Buttons.....	254
MY MY MENU	256
MY MENU SETTING.....	256

10	Peripherals and Optional Accessories	259
	External Flash Units	260
	Flash Settings	261
	SYNC TERMINAL.....	263
	SHOE MOUNT FLASH	264
	MASTER(OPTICAL)	269
	Lenses.....	275
	Lens Parts.....	275
	Removing Lens Caps	276
	Attaching Lens Hoods	276
	Lenses with Aperture Rings.....	277
	Lenses with No Aperture Rings.....	278
	Lenses with O.I.S. Switches.....	278
	Manual Focus Lenses.....	279
	Lens Care.....	280
11	Connections	281
	HDMI Output	282
	Connecting to HDMI Devices	282
	Shooting.....	283
	Playback.....	283
	Wireless Transfer	284
	Smart Phones and Tablets:	
	FUJIFILM Camera Remote.....	284
	Smart Phones and Tablets: Bluetooth® Pairing.....	285
	Smartphones and Tablets: Wi-Fi.....	285
	Computers: FUJIFILM PC AutoSave	286
	Computers: Wireless Connections	286

Connecting to Computers via USB	287
Windows (MyFinePix Studio)	287
Mac OS X/macOS	287
RAW FILE CONVERTER EX 2.0	287
Connecting the Camera	288
instax SHARE Printers	291
Establishing a Connection	291
Printing Pictures	292

12 Technical Notes 293

Accessories from FUJIFILM	294
Software from FUJIFILM	298
FUJIFILM Camera Remote	298
FUJIFILM PC AutoSave	298
MyFinePix Studio	299
RAW FILE CONVERTER EX 2.0	299
For Your Safety	300
Product Care	313
Cleaning the Image Sensor	314
Firmware Updates	315
Checking the Firmware Version	315
Troubleshooting	316
Warning Messages and Displays	325
Memory Card Capacity	329
Specifications	330

Supplied Accessories

The following are included with the camera:

- NP-W126S rechargeable battery
- BC-W126 battery charger
- EF-X8 shoe mounted flash unit
- Body cap
- Metal strap clips (× 2)
- Clip attaching tool
- Protective covers (× 2)
- Shoulder strap
- *Owner's Manual* (this manual)



If you purchased a lens kit, check that a lens is included.

About This Manual

This manual contains instructions for your FUJIFILM X-E3 digital camera. Be sure you have read and understood its contents before proceeding.

Symbols and Conventions

The following symbols are used in this manual:



Information that should be read to prevent damage to the product.



Additional information that may be helpful when using the product.



Pages on which related information may be found.

Menus and other text in the displays are shown in **bold**. Illustrations are for explanatory purposes only; drawings may be simplified, while photographs are not necessarily taken with the model of camera described in this manual.

Terminology

The optional SD, SDHC, and SDXC memory cards the camera uses to store pictures are referred to as “memory cards”. The electronic viewfinder may be referred to as the “EVF” and the LCD monitor as the “LCD”.

Before You Begin



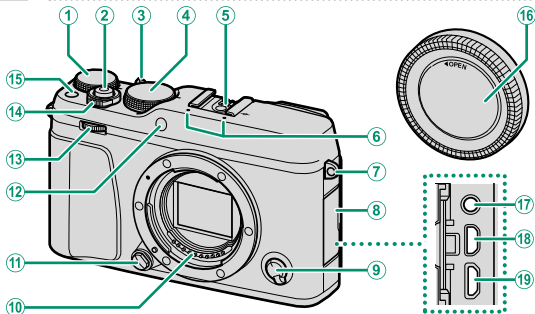

Parts of the Camera

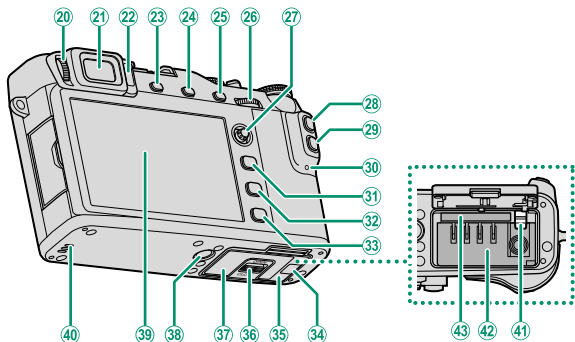

- | | |
|--|--|
| ① Exposure compensation dial
.....5, 91 | ⑬ Front command dial8, 228 |
| ② Shutter button..... 50 | ⑭ ON/OFF switch..... 42 |
| ③ Auto mode selector lever.....7 | ⑮ Function button (Fn1).....252 |
| ④ Shutter speed dial.....5, 64, 72 | ⑯ Body cap 30 |
| ⑤ Hot shoe.....107, 260 | ⑰ Microphone/remote release
connector (ø 2.5 mm)
..... 55, 68, 172 |
| ⑥ Microphone 172 | ⑱ HDMI Micro connector (Type D)
.....282 |
| ⑦ Strap eyelet..... 28 | ⑲ Micro USB (Micro-B)
USB 2.0 connector.....35, 68, 288 |
| ⑧ Connector cover | |
| ⑨ Focus mode selector..... 78 | |
| ⑩ Lens signal contacts | |
| ⑪ Lens release button..... 31 | |
| ⑫ AF-assist illuminator.....138 | |
| Self-timer lamp..... 151 | |



- 20 Diopter adjustment control 11
 21 Electronic viewfinder (EVF)
 12, 14, 15
 22 Eye sensor 14
 23 **VIEW MODE** button 14
 24 **DRIVE** button 6
  (delete) button
 (playback mode) 52
 25 **AE-L** (exposure lock) button 93
 26 Rear command dial
 9, 178, 228
 27 Focus stick (focus lever) 4
 28 **AF-L** (focus lock) button 93
 29 **Q** (quick menu) button 247
 30 Indicator lamp 10, 35
 31 **MENU/OK** button 20
 32 **DISP** (display)/**BACK** button
 16, 176
 33  (playback) button 51
 34 Cable channel cover for
 DC coupler 294
 35 Battery-chamber cover 36
 36 Battery-chamber cover latch 36
 37 Serial number plate 4
 38 Tripod mount
 9, 178, 228
 39 LCD monitor 11, 12, 14, 15
 40 Speaker 58
 41 Battery latch 39
 42 Battery chamber 36
 43 Memory card slot 36

The Serial Number Plate

Do not remove the serial number plate, which provides the FCC ID, KC mark, serial number, and other important information.

The Focus Stick (Focus Lever)

Tilt or press the focus stick to select the focus area. The focus stick can also be used to navigate the menus.



The Shutter Speed Dial

The shutter speed dial is used to choose the shutter speed.

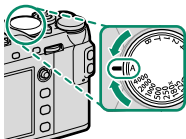

The Exposure Compensation Dial

Rotate the dial to choose an exposure compensation amount.

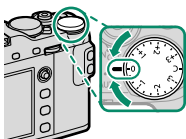

The DRIVE Button

Pressing the **DRIVE** button displays drive mode options, where you can choose from the following the drive modes.

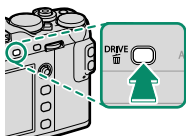

	Mode	
	STILL IMAGE	48
	CONTINUOUS	97
	AE BKT	95
	ISO BKT	95
	FILM SIMULATION BKT	95
	WHITE BALANCE BKT	96
	DYNAMIC RANGE BKT	96
Adv.	MULTIPLE EXPOSURE	101
	PANORAMA	103
	ADVANCED FILTER	99
	MOVIE	54

The Auto Mode Selector Lever

Switch between auto and manual modes.

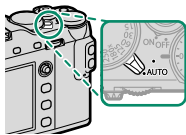

Position	Mode
	<p>Select from P (program AE), S (shutter-priority AE), A (aperture-priority AE), and M (manual) modes (📖 62, 64, 69, 72). Adjust shutter speed and aperture using program shift (mode P) or set shutter speed and/or aperture manually (modes S, A, and M).</p>
	<p>Auto mode. The camera adjusts settings automatically according to the option selected by rotating the front command dial. Choose from modes suited to specific subject types (📖 74), or select SR+ ADVANCED SR AUTO to let the camera automatically match the mode to the subject (📖 76). Scene selection is not available in Adv. or Adv. drive modes.</p>

 Restrictions may apply to camera settings depending on the mode and shooting conditions.

The Command Dials

Rotate or press the command dials to perform the operations listed below.

Front Command Dial



Rotate



- Select menu tabs or page through menus.
- Adjust aperture.
- Select a scene when shooting in auto mode.
- Select an advanced filter when shooting with **Adv** (**ADVANCED FILTER**) selected in auto mode.
- Adjust exposure compensation when **C** is selected with exposure compensation dial.
- Adjust sensitivity (**ON** selected for **ISO COMMAND DIAL SETTING**).
- View other pictures during playback.

Press



Switch back and forth between aperture and exposure compensation when **C** is selected with the exposure compensation dial, or between aperture, exposure compensation, and sensitivity when **C** is selected with the exposure compensation dial and **ISO COMMAND SETTING** is **ON**.

Rear Command Dial



Rotate



- Highlight menu items.
- Choose the desired combination of shutter speed and aperture (program shift).
- Choose a shutter speed.
- Adjust settings in the quick menu.
- Choose the size of the focus frame.
- Zoom in or out during focus zoom or in full frame or multi-frame playback.

Press



- Perform the function assigned to the *DIAL* function button.
- Press and hold to choose the manual focus mode focus display.
- Zoom in on the active focus point during playback.

The Indicator Lamp

When the viewfinder is not in use, camera status is shown by the indicator lamp.

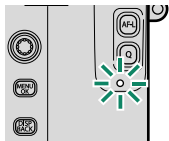

Indicator lamp	Camera status
Glows green	Focus locked.
Blinks green	Focus or slow shutter speed warning. Pictures can be taken.
Blinks green and orange	<ul style="list-style-type: none">• Camera on: Recording pictures. Additional pictures can be taken.• Camera off: Uploading pictures to a smartphone or tablet.
Glows orange	Recording pictures. No additional pictures can be taken at this time.
Blinks orange	Flash charging; flash will not fire when picture is taken.
Blinks red	Lens or memory error.



Warnings may also appear in the display.

The LCD Monitor

The LCD monitor also functions as a touch screen that can be used for:

- Touch photography (📖 23)
- Focus area selection (📖 22)
- Function selection (📖 24)
- Full-frame playback (📖 25)



Focusing the Viewfinder

The camera is equipped with diopter adjustment in the range -4 to $+2 \text{ m}^{-1}$ to accommodate individual differences in vision. Rotate the diopter adjustment control until the viewfinder display is in sharp focus.

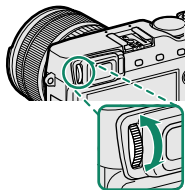

Camera Displays

This section lists the indicators that may be displayed during shooting.

! For illustrative purposes, displays are shown with all indicators lit.

Electronic Viewfinder/LCD Monitor

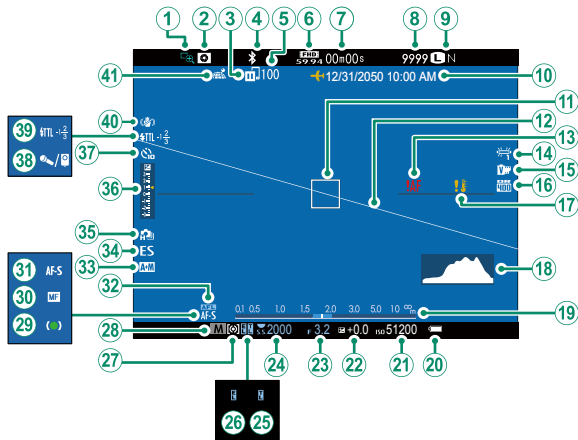

- | | |
|---|---|
| ① Focus check..... 89, 143 | ②② Exposure compensation 91 |
| ② Depth-of-field preview70, 89 | ②③ Aperture63, 69, 72 |
| ③ Image transfer status 192 | ②④ Shutter speed.....63, 64, 72 |
| ④ Bluetooth ON/OFF241 | ②⑤ TTL lock166, 227, 255 |
| ⑤ Number of frames selected for
upload 192 | ②⑥ AE lock 92, 93, 230 |
| ⑥ Movie mode..... 54, 169 | ②⑦ Metering..... 155 |
| ⑦ Time remaining 54 | ②⑧ Shooting mode..... 62 |
| ⑧ Number of available frames* ...329 | ②⑨ Focus indicator..... 79 |
| ⑨ Image quality and size 115, 116 | ③⑩ Manual focus indicator 87 |
| ⑩ Date and time 44, 204, 205 | ③① Focus mode..... 78 |
| ⑪ Focus frame82, 92 | ③② AF lock 92, 93, 229 |
| ⑫ Virtual horizon 18 | ③③ AF+MF indicator 141 |
| ⑬ Focus warning 50, 325 | ③④ Shutter type..... 156 |
| ⑭ White balance..... 122 | ③⑤ Continuous mode 97 |
| ⑮ Film simulation..... 118 | ③⑥ Exposure indicator72, 91 |
| ⑯ Dynamic range..... 121 | ③⑦ Self-timer indicator..... 151 |
| ⑰ Temperature warning..... 328 | ③⑧ Microphone/remote release .. 172 |
| ⑱ Histogram..... 19 | ③⑨ Flash (TTL) mode 109 |
| ⑲ Distance indicator..... 89 | Flash compensation..... 109 |
| ⑳ Battery level 43 | ④⑩ IS mode 157 |
| ㉑ Sensitivity..... 158 | ④① Location data download
status.....243 |

* Shows "9999" if there is space for over 9999 frames.

Choosing a Display Mode

Press the **VIEW MODE** button to cycle through the following display modes:

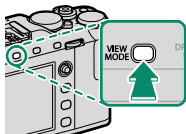

- **EYE SENSOR**: Putting your eye to the viewfinder turns the viewfinder on and the LCD monitor off; taking your eye away turns the viewfinder off and LCD monitor on.
- **EVF ONLY**: Viewfinder on, LCD monitor off.
- **LCD ONLY**: LCD monitor on, viewfinder off.
- **EVF ONLY + EYE SENSOR**: Putting your eye to the viewfinder turns the viewfinder on; taking it away turns the viewfinder off. The LCD monitor remains off.
- **EYE SENSOR + LCD IMAGE DISP.**: Putting your eye to the viewfinder during shooting turns the viewfinder on, but the LCD monitor is used for the display of images immediately after shooting.

The Eye Sensor

The eye sensor may respond to objects other than your eye or to light shining directly on the sensor.

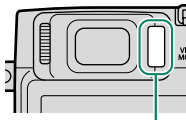

Eye sensor

Adjusting Display Brightness and Color

The brightness and hue of the viewfinder and LCD monitor can be adjusted using the items in the **SCREEN SET-UP** menu. Choose **EVF BRIGHTNESS** or **EVF COLOR** to adjust viewfinder brightness or hue, **LCD BRIGHTNESS** or **LCD COLOR** to do the same for the LCD monitor.

Display Rotation

When **ON** is selected for **SCREEN SET-UP > AUTOROTATE DISPLAYS**, the indicators in the viewfinder and LCD monitor automatically rotate to match camera orientation.

The DISP/BACK Button

The **DISP/BACK** button controls the display of indicators in the viewfinder and LCD monitor.

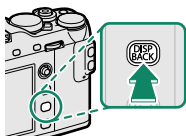

Indicators for the EVF and LCD must be selected separately. To choose the EVF display, place your eye to the viewfinder while using the **DISP/BACK** button.

Viewfinder



Standard



Information off

LCD Monitor

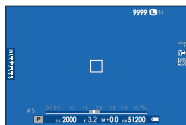

Standard

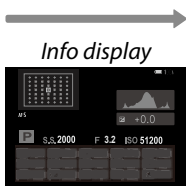

Info display



Information off



Customizing the Standard Display

To choose the items shown in the standard display:

1 Display standard indicators.

Use the **DISP/BACK** button to display standard indicators.

2 Select **DISP. CUSTOM SETTING**.

Select **SCREEN SET-UP > DISP. CUSTOM SETTING** in the setup menu.

3 Choose items.

Highlight items and press **MENU/OK** to select or deselect.

- FRAMING GUIDELINE
- ELECTRONIC LEVEL
- FOCUS FRAME
- AF DISTANCE INDICATOR
- MF DISTANCE INDICATOR
- HISTOGRAM
- LIVE VIEW HIGHLIGHT ALERT
- SHOOTING MODE
- APERTURE/S-SPEED/ISO
- INFORMATION BACKGROUND
- Expo. Comp. (Digit)
- Expo. Comp. (Scale)
- FOCUS MODE
- PHOTOMETRY
- SHUTTER TYPE
- FLASH
- CONTINUOUS MODE
- DUAL IS MODE
- TOUCH SCREEN MODE
- WHITE BALANCE
- FILM SIMULATION
- DYNAMIC RANGE
- FRAMES REMAINING
- IMAGE SIZE/QUALITY
- MOVIE MODE & REC. TIME
- IMAGE TRANSFER ORDER
- BATTERY LEVEL
- FRAMING OUTLINE

4 Save changes.

Press **DISP/BACK** to save changes.

5 Exit the menus.

Press **DISP/BACK** as needed to exit the menus and return to the shooting display.



Some indicators are not displayed in all modes.

Virtual Horizon

Selecting **ELECTRONIC LEVEL** displays a virtual horizon. The camera is level when the two lines overlap. Note that the virtual horizon may not be displayed if the camera lens is pointed up or down.

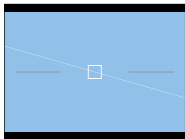

Framing Outline

Enable **FRAMING OUTLINE** to make the borders of the frame easier to see against dark backgrounds.

Histograms

Histograms show the distribution of tones in the image. Brightness is shown by the horizontal axis, the number of pixels by the vertical axis.

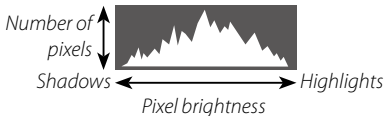

- **Optimal exposure:** Pixels are distributed in an even curve throughout the tone range.
- **Overexposed:** Pixels are clustered on the right side of the graph.
- **Underexposed:** Pixels are clustered on the left side of the graph.



To view separate RGB histograms and a display showing areas of the frame that will be overexposed at current settings superimposed on the view through the lens, press the function button to which **HISTOGRAM** is assigned (📖 226, 254).

- ① *Overexposed areas blink*
- ② *RGB histograms*

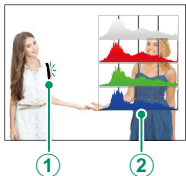

Using the Menu

To display the menu, press **MENU/OK**.

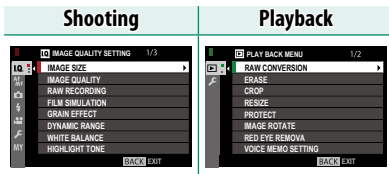
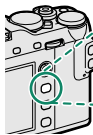

To navigate the menus:

- 1 Press **MENU/OK** to display the menu.

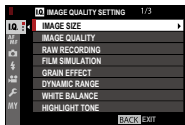

- 2 Press the focus stick (focus lever) left to highlight the tab for the current menu.

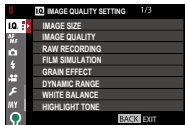

Tab

- 3 Press the focus stick up or down to highlight the tab (IQ, AF MF, , , , MY, or) containing the desired item.
- 4 Press the focus stick right to place the cursor in the menu.



Use the front command dial to select menu tabs or page through menus and the rear command dial to highlight menu items.

The focus stick (focus lever) does not tilt diagonally.

Touch Screen Mode

Use touch controls for shooting or playback.

Shooting Touch Controls





Touch Controls and the EVF

If **ON** is selected for **☑** **BUTTON/DIAL SETTING** > **TOUCH SCREEN SETTING** > **TOUCH SCREEN ON/OFF** and one of **ALL**, **RIGHT**, or **LEFT** for **EVF TOUCH SCREEN AREA SETTINGS**, the LCD monitor can be used to select the focus area while pictures are being framed in the electronic viewfinder (EVF).

LCD Monitor Touch Controls

Touch controls can be used for such operations as choosing the focus area and taking photographs. The operation performed can be selected by tapping the touchscreen mode indicator in the display to cycle through the following options:



Mode	Description
 TOUCH SHOOTING	Tap your subject in the display to focus and release the shutter.
 AF	Tap to select a focus point. In focus mode S (AF-S), focus will lock, while in focus mode C (AF-C), the camera will continually adjust focus in response to changes in the distance to the subject.
 AREA	Tap to select a point for focus or zoom. The focus frame will move to the selected point.
 OFF	Touch controls off. The display does not respond when tapped.

 Touch control settings can be adjusted using **AF/MF SETTING > TOUCH SCREEN MODE** (📖 146). To disable touch controls and hide the touch screen mode indicator, select **OFF** for **📷 BUTTON/DIAL SETTING > TOUCH SCREEN SETTING > TOUCH SCREEN ON/OFF**.

Touch Function

Functions can be assigned to the following flick gestures in much the same way as function buttons (📖 252):

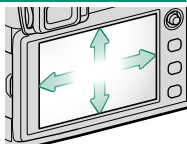

- Flick up: **T-Fn1**
- Flick left: **T-Fn2**
- Flick right: **T-Fn3**
- Flick down: **T-Fn4**

Playback Touch Controls

When **ON** is selected for **▶** **BUTTON/DIAL SETTING** > **TOUCH SCREEN SETTING** > **TOUCH SCREEN ON/OFF**, touch controls can be used for the following playback operations:

- **Swipe:** Swipe a finger across the display to view other images.
- **Pinch-out:** Place two fingers on the display and spread them apart to zoom in.
- **Pinch-in:** Place two fingers on the display and slide them together to zoom out.



Pictures can be zoomed out until the entire image is visible but no further.

- **Double-tap:** Tap the display twice to zoom in on the focus point.
- **Drag:** View other areas of the image during playback zoom.

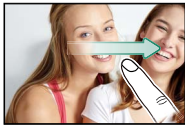

First Steps

2

Attaching the Strap

Attach the strap clips to the camera and then attach the strap.

1 Open a strap clip.

Use the clip attaching tool to open a strap clip, making sure that the tool and clip are in the orientations shown.

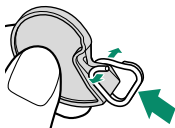

2 Slide the clip onto the tool.

Slide the clip onto the tool so that it hooks over the projection.

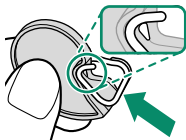

3 Place the strap clip on an eyelet.

Hook the strap eyelet in the clip opening. Remove the tool, using the other hand to keep the clip in place.

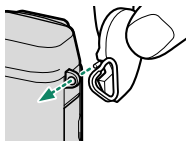

! Keep the tool in a safe place, as you will need it to open the strap clips when removing the strap.

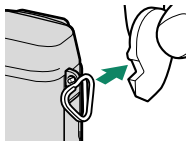

- 4 Pass the clip through the eyelet.**
Rotate the clip fully through the eyelet until it clicks closed.

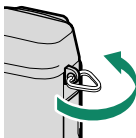

- 5 Attach a protective cover.**
Place a protective cover over the eyelet as shown, with the black side of the cover toward the camera.

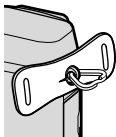
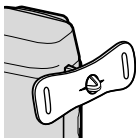

- 6 Fasten the strap.**
Insert the strap through a protective cover and strap clip and fasten as shown.

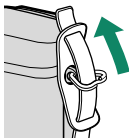

! To avoid dropping the camera, be sure the strap is correctly secured.

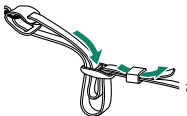

Repeat the above steps for the second eyelet.

Attaching a Lens

The camera can be used with lenses for the FUJIFILM X-mount.

Remove the body cap from the camera and the rear cap from the lens. Place the lens on mount, keeping the marks on the lens and camera aligned (①), and then rotate the lens until it clicks into place (②).

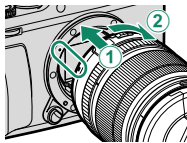

- ⚠ When attaching lenses, ensure that dust or other foreign matter does not enter the camera and be careful not to touch the camera's internal parts. Do not press the lens release button while attaching the lens and be sure the latch has securely clicked into place.

Removing Lenses

To remove the lens, turn the camera off, then press the lens release button (1) and rotate the lens as shown (2).

! To prevent dust accumulating on the lens or inside the camera, replace the lens caps and camera body cap when the lens is not attached.

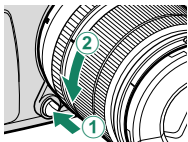

Lenses and Other Optional Accessories

The camera can be used with lenses and accessories for the FUJIFILM X-mount.

! Before attaching or removing (exchanging) lenses, attach the lens caps and check that the lenses are free of dust and other foreign matter. Do not change lenses in direct sunlight or under another bright light source, as light focused into the interior of the camera could cause it to malfunction.

Charging the Battery

The battery is not charged at shipment. Before use, charge the battery in the supplied battery charger.

! An NP-W126S rechargeable battery is supplied with the camera. Charging takes about 150 minutes.

1 Place the battery in the charger.

Place the battery in the supplied battery charger as shown.

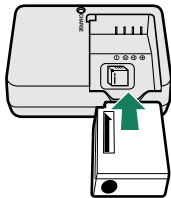

2 Plug the charger in.

Plug the charger into an indoor power outlet. The charging indicator will light.

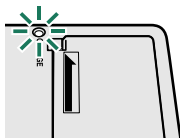

3 Charge the battery.

Remove the battery when charging is complete.

The Charging Indicator

The charging indicator shows battery charge status as follows:

 Charging indicator	Battery status	Action
Off	Battery not inserted.	Insert the battery.
	Battery fully charged.	Remove the battery.
On	Battery charging.	—
Blinks	Battery fault.	Unplug the charger and remove the battery.



The supplied AC cord is for use exclusively with the supplied battery charger. Do not use the supplied charger with other cords or the supplied cord with other devices.

Do not affix labels or other objects to the battery. Failure to observe this precaution could make it impossible to remove the battery from the camera.

Do not short the battery terminals. The battery could overheat.

Read the cautions in “The Battery and Power Supply”.

Use only battery chargers designated for use with the battery. Failure to observe this precaution could result in product malfunction.

Do not remove the labels from the battery or attempt to split or peel the outer casing.

The battery gradually loses its charge when not in use. Charge the battery one or two days before use. If the battery fails to hold a charge, it has reached the end of its charging life and must be replaced.

Unplug the charger when it is not in use.

Remove dirt from the battery terminals with a clean, dry cloth. Failure to observe this precaution could prevent the battery from charging.

Note that charging times increase at low temperatures.

Charging via Computer

The battery also charges if the camera is connected to a computer. Turn the camera off, insert the battery, and connect a Micro USB (Micro-B) USB 2.0 cable as shown, making sure the connectors are fully inserted (choose a cable suitable for data transfer and no more than 1.5 m/4.9 ft. long).

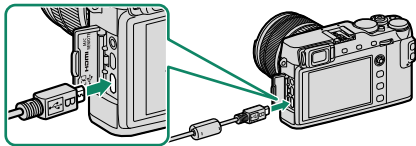

Charging takes about 300 minutes. Battery status is shown by the indicator lamp.

Indicator lamp	Battery status
On	Battery charging
Off	Charging complete
Blinks	Battery fault

Connect the camera directly to the computer; do not use a USB hub or keyboard. Charging stops if the computer enters sleep mode; to resume charging, activate the computer and disconnect and reconnect the USB cable. Charging may not be supported depending on the model of computer, computer settings, and the computer's current state.

Inserting Batteries and Memory Cards

After charging the battery, insert the battery and memory card as described below.

1 Open the battery-chamber cover.

Slide the battery-chamber latch as shown and open the battery-chamber cover.

! Do not open the battery-chamber cover when the camera is on. Failure to observe this precaution could damage image files or memory cards.

Do not use excessive force when handling the battery-chamber cover.

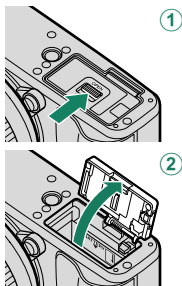

2 Insert the battery.

Using the battery to keep the battery latch pressed to one side, insert the battery contacts first in the direction shown by the arrow. Confirm that the battery is securely latched.

 Insert the battery in the orientation shown. *Do not use force or attempt to insert the battery upside down or backwards.* The battery will slide in easily in the correct orientation.

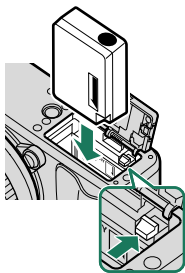

3 Insert the memory card.

Holding the card in the orientation shown, slide it in until it clicks into place at the back of the slot.

 Be sure card is in the correct orientation; do not insert at an angle or use force.

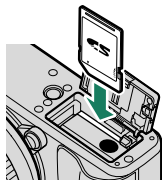

4 Close the battery-chamber cover. Close and latch the cover.

 If the cover does not close, check that the battery is in the correct orientation. Do not attempt to force the cover shut.

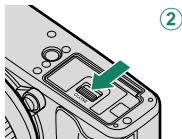
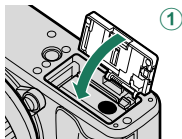

Removing the Battery

Before removing the battery, *turn the camera off* and open the battery-chamber cover.

To remove the battery, press the battery latch to the side, and slide the battery out of the camera as shown.

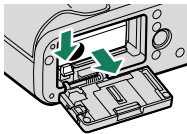

! The battery may become hot when used in high-temperature environments. Observe caution when removing the battery.

Removing Memory Cards

Before removing memory cards, *turn the camera off* and open the battery-chamber cover.

Press and release the card to eject it part way (to prevent the card falling from the slot, press the center of the card and release it slowly, without removing your finger from the card). The card can then be removed by hand.

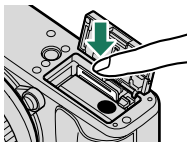

Compatible Memory Cards

FUJIFILM and SanDisk SD, SDHC, and SDXC memory cards have been approved for use in the camera; UHS-I is supported. Cards with a UHS speed class of 3 or better are recommended for movies. A complete list of approved memory cards is available at http://www.fujifilm.com/support/digital_cameras/compatibility/. Operation is not guaranteed with other cards. The camera cannot be used with xD-Picture Cards or MultiMediaCard (MMC) devices.

! *Do not turn the camera off or remove the memory card while the memory card is being formatted or data are being recorded to or deleted from the card. Failure to observe this precaution could damage the card.*

Memory cards can be locked, making it impossible to format the card or to record or delete images.

Before inserting a memory card, slide the write-protect switch to the unlocked position.





Format memory cards before first use, and be sure to reformat all memory cards after using them in a computer or other device.

Memory cards are small and can be swallowed; keep out of reach of children. If a child swallows a memory card, seek medical assistance immediately.

miniSD or microSD adapters that are larger or smaller than memory cards may not eject normally; if the card does not eject, take the camera to an authorized service representative. Do not forcibly remove the card.

Do not affix labels or other objects to memory cards. Peeling labels can cause camera malfunction.

Movie recording may be interrupted with some types of memory card.

Formatting a memory card in the camera creates a folder in which pictures are stored. Do not rename or delete this folder or use a computer or other device to edit, delete, or rename image files. Always use the camera to delete pictures; before editing or renaming files, copy them to a computer and edit or rename the copies, not the originals. Renaming the files on the camera can cause problems during playback.

Turning the Camera On and Off

Use the **ON/OFF** switch to turn the camera on and off.

Rotate the switch to **ON** to turn the camera on, or to **OFF** to turn the camera off.

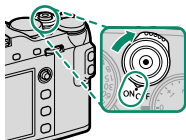

! Fingerprints and other marks on the lens or viewfinder can affect pictures or the view through the viewfinder. Keep the lens and viewfinder clean.







▶ Press the **▶** button to start playback. Press the shutter button halfway to return to shooting mode.

The camera will turn off automatically if no operations are performed for the length of time selected for **▶ POWER MANAGEMENT > AUTO POWER OFF**. To reactivate the camera after it has turned off automatically, press the shutter button halfway or turn the **ON/OFF** switch to **OFF** and then back to **ON**.

Checking the Battery Level

After turning the camera on, check the battery level in the display.

Battery level is shown as follows:

Indicator	Description
	Battery partially discharged.
	Battery about 80% full.
	Battery about 60% full.
	Battery about 40% full.
	Battery about 20% full.
 (red)	Low battery. Charge as soon as possible.
 (blinks red)	Battery exhausted. Turn camera off and recharge battery.



Basic Setup

When you turn the camera on for the first time, you can choose a language and set the camera clock. At default settings, you can also pair the camera with a smartphone or tablet so that you can later synchronize the clocks or download pictures. Follow the steps below when turning the camera on for the first time.



If you intend to pair the camera with a smartphone or tablet, install and launch the latest version of the FUJIFILM Camera Remote App on the smart device before proceeding. For more information, visit: http://app.fujifilm-dsc.com/en/camera_remote/

1 Turn the camera on.

A language-selection dialog will be displayed.

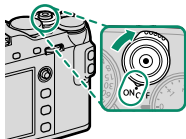

2 Choose a language.

Highlight a language using the focus stick (focus lever, ①) and press **MENU/OK** (②).

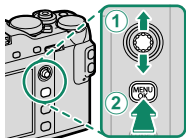

3 Pair the camera with the smartphone or tablet.

Press **MENU/OK** to pair the camera with a smartphone or tablet running the FUJIFILM Camera Remote app.

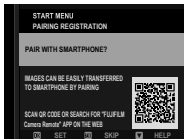



 To skip pairing, press **DISP/BACK**.

4 Check the time.

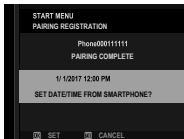
When pairing is complete, you will be prompted to set the camera clock to the time reported by the smartphone or tablet. Check that the time is correct.



 To set the clock manually, press **DISP/BACK** ( 46).

5 Set the clock.

Press **MENU/OK** to set the camera clock to the time reported by the smartphone or tablet and exit to shooting mode.

 If the battery is removed for an extended period, the camera clock will be reset and the language-selection dialog will be displayed when the camera is turned on.

Skipping the Current Step

Press **DISP/BACK** to skip the current step. A confirmation dialog will be displayed; select **NO** to avoid repeating any steps you skipped the next time the camera is turned on.

Choosing a Different Language

To change the language:

- 1 Display language options.**
Select **USER SETTING > 言語/LANG..**
- 2 Choose a language.**
Highlight the desired option and press **MENU/OK**.

Changing the Time and Date

To set the camera clock:

- 1 Display DATE/TIME options.**
Select **USER SETTING > DATE/TIME**.
- 2 Set the clock.**
Press the focus stick (focus lever) left or right to highlight the year, month, day, hour, or minute and press up or down to change. Press **MENU/OK** to set the clock.

Basic Photography and Playback

3

Taking Photographs (Mode P)

This section describes how to take pictures using program AE (mode P). See pages 62–73 for information on S, A, and M modes.



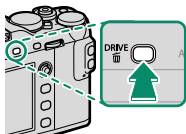

1 Select (STILL IMAGE) drive mode.

Press the **DRIVE** button and select  (STILL IMAGE) from the list of drive mode options.

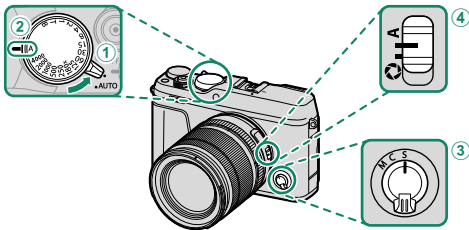

2 Adjust settings for program AE.



- 1 **Auto mode selector lever** ( 7): Select .
- 2 **Shutter speed** ( 62): Select A (auto).
- 3 **Focus mode** ( 78): Select S (single AF).
- 4 **Aperture** ( 62): Select A (auto).

3 Check the shooting mode.

Confirm that **P** appears in the display.

**4 Ready the camera.**

Hold the camera steady with both hands and brace your elbows against your sides. Shaking or unsteady hands can blur your shots.



To prevent pictures that are out of focus or too dark (underexposed), keep your fingers and other objects away from the lens and AF-assist illuminator.

**5 Frame the picture.****Lenses with Zoom Rings**

Use the zoom ring to frame the picture in the display. Rotate the ring left to zoom out, right to zoom in.

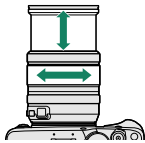

6 Focus.

Press the shutter button half-way to focus.



If the subject is poorly lit, the AF-assist illuminator may light.

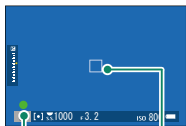

Focus indicator

Focus frame

If the camera is able to focus, it will beep twice and focus area and focus indicator will glow green. Focus and exposure will lock while the shutter button is pressed halfway.

If the camera is unable to focus, the focus frame will turn red, **!AF** will be displayed, and the focus indicator will blink white.

7 Shoot.

Smoothly press the shutter button the rest of the way down to take the picture.



Viewing Pictures

Pictures can be viewed in the viewfinder or LCD monitor.

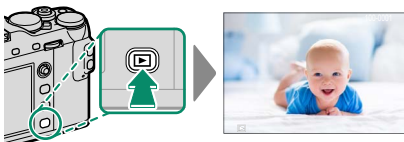
To view pictures full frame, press .



Additional pictures can be viewed by pressing the focus stick (focus lever) left or right or rotating the front command dial. Press the focus stick or rotate the dial right to view pictures in the order recorded, left to view pictures in reverse order. Keep the focus stick pressed to scroll rapidly to the desired frame.

 Pictures taken using other cameras are marked with a  ("gift image") icon to warn that they may not display correctly and that playback zoom may not be available.



Deleting Pictures

Use the  button to delete pictures.



Deleted pictures cannot be recovered. Copy important pictures to a computer or other storage device before proceeding.

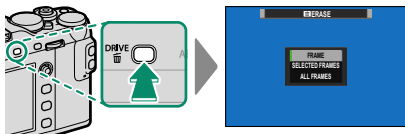

- 1 With a picture displayed full frame, press the  button and select **FRAME**.



- 2 Press the focus stick (focus lever) left or right to scroll through pictures and press **MENU/OK** to delete (a confirmation dialog is not displayed). Repeat to delete additional pictures.



Protected pictures cannot be deleted. Remove protection from any pictures you wish to delete ( 188).

Pictures can also be deleted from the menus using the  **PLAY BACK MENU** > **ERASE** option ( 183).

Movie Recording and Playback

4



Recording Movies

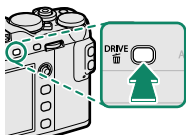

This section describes how to film movies in auto mode.

- 1 Press the **DRIVE** button and select  (**MOVIE**) from the list of drive mode options.

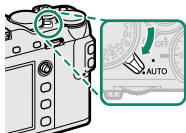

- 2 Rotate the auto mode selector lever to **AUTO** to shoot movies in  **ADVANCED SR AUTO** mode.



Rotate the lever to  to shoot movies in mode **P**. Movies shot with  selected for **MOVIE MODE** will also be recorded in mode **P**.

- 3 Press the shutter button to start recording. A recording indicator () blinks and the time remaining is displayed while recording is in progress.



- 4 Press the button again to end recording. Recording ends automatically when the maximum length is reached or the memory card is full.

Using an External Microphone

Sound can be recorded with external microphones that connect using jacks 2.5 mm in diameter; microphones that require bus power cannot be used. See the microphone manual for details.

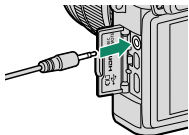



Sound is recorded via the built-in microphone or an optional external microphone. Do not cover the microphone during recording. Note that the microphone may pick up lens noise and other sounds made by the camera during recording.

Vertical or horizontal streaks may appear in movies containing very bright subjects. This is normal and does not indicate a malfunction.



The indicator lamp lights while recording is in progress. During recording, you can change exposure compensation by up to ± 2 EV and adjust zoom using the zoom ring on the lens (if available).

If the lens is equipped with an aperture mode switch, select the aperture mode before beginning recording. If an option other than **A** is selected, shutter speed and aperture can be adjusted while recording is in progress.

Recording may be unavailable at some settings, while in other cases settings may not apply during recording.

Adjusting Movie Settings

- The movie type, frame size, and frame rate can be selected using **MOVIE SETTING > MOVIE MODE**.
- The AF-area mode for movie recording is selected using **MOVIE SETTING > MOVIE AF MODE**; choose from **MULTI** and **AREA**.
- Focus mode is selected using the focus mode selector; for continuous focus adjustment, select **C**, or choose **S** and enable Intelligent Face Detection (Intelligent Face Detection is not available in focus mode **M**).

Depth of Field

Choose low f-numbers to soften background details.



Viewing Movies

View movies on the camera.

In full-frame playback, movies are identified by a  icon.



The following operations can be performed while a movie is displayed:

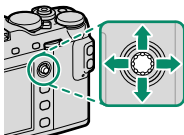

Focus stick (focus lever)	Playback in progress ()	Playback paused ()
Up	End playback	
Down	Pause playback	Start/resume playback
Left/right	Adjust speed	Single frame rewind/advance



Progress is shown in the display during playback.



 Do not cover the speaker during playback.

 Press **MENU/OK** to pause playback and display volume controls. Press the focus stick (focus lever) up or down to adjust the volume; press **MENU/OK** again to resume playback. Volume can also be adjusted using  **SOUND SET-UP > PLAYBACK VOLUME**.

Playback Speed

Press the focus stick (focus lever) left or right to adjust playback speed during playback. Speed is shown by the number of arrows (▶ or ◀).



Arrows

MEMO

Taking Photographs

5

Choosing a Shooting Mode

For control over shutter speed and aperture (P, S, A, and M modes), rotate the auto mode selector lever to ●. Rotate the lever to **AUTO** to choose from modes suited to specific subject types, or select **SR+ ADVANCED SR AUTO** to let the camera automatically match the mode to the subject.

Mode P: Program AE

Let the camera choose shutter speed and aperture for optimal exposure. Other values that produce the same exposure can be selected with program shift.

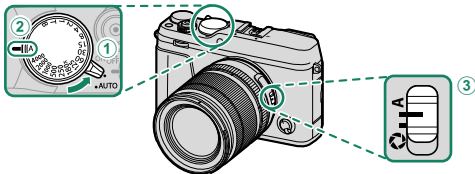

Adjust settings as follows:

- 1 **Auto mode selector lever:** ●
- 2 **Shutter speed:** A (auto)
- 3 **Aperture:** A (auto)

Confirm that **P** appears in the display.

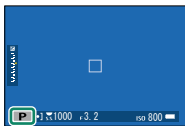

! If the subject is outside the metering range of the camera, the shutter speed and aperture displays will show “---”.

Program Shift

If desired, you can rotate the rear command dial to select other combinations of shutter speed and aperture without altering exposure (program shift).

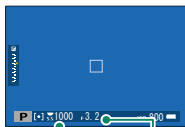

Shutter speed

Aperture

! Program shift is not available during movie recording or if the flash supports TTL auto or an auto option is selected for **Q IMAGE QUALITY SETTING > DYNAMIC RANGE**.

! To cancel program shift, turn the camera off.

Mode S: Shutter-Priority AE

Choose a shutter speed and let the camera adjust aperture for optimal exposure.

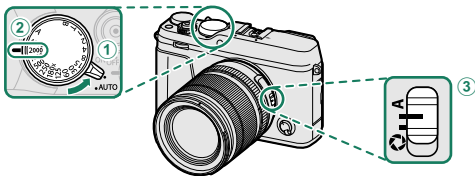

Adjust settings as follows:

- 1 **Auto mode selector lever:** ●
- 2 **Shutter speed:** Choose a shutter speed
- 3 **Aperture:** A (auto)

Confirm that **S** appears in the display.



! If the correct exposure cannot be achieved at the selected shutter speed, aperture will be displayed in red. If the subject is outside the metering range of the camera, the aperture display will show “— —”.



At settings other than **180X**, shutter speed can also be adjusted in increments of $\frac{1}{3}$ EV by rotating the rear command dial. Shutter speed can be adjusted even while the shutter button is pressed halfway.

Sensitivity and Depth of Field

If you choose a fast shutter speed when the subject is poorly lit, the camera autoexposure program will select a wider aperture. This will produce the correct exposure but may also reduce depth of field so that less of the area behind and in front of your subject appears to be in focus. To stop aperture down and increase depth of field, select a higher sensitivity.



Time (T)

Rotate the shutter speed dial to **T** (time) to choose slow shutter speeds for long time-exposures. Use of a tripod is recommended to prevent the camera moving during the exposure.

- 1 Rotate the shutter speed dial to **T**.

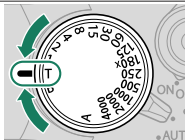

- 2 Rotate the rear command dial to choose a shutter speed.

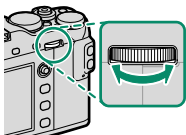

- 3 Press the shutter button all the way down to take a picture at the selected shutter speed. At speeds of 1 s or slower, a count-down timer will be displayed while the exposure is in progress.

 To reduce “noise” (mottling) in long time-exposures, select **ON** for **IMAGE QUALITY SETTING > LONG EXPOSURE NR.** Note that this may increase the time needed to record images after shooting.

Bulb (B)

Select a shutter speed of **B** (bulb) for long time-exposures in which you open and close the shutter manually. Use of a tripod is recommended to prevent the camera moving during the exposure.

- 1 Rotate the shutter speed dial to **B**.

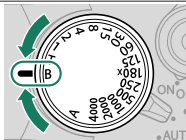

- 2 Press the shutter button all the way down. The shutter will remain open for up to 60 minutes while the shutter button is pressed; the display shows the time elapsed since the exposure started (if the electronic shutter is used, the shutter will remain open for 1 second, regardless of how long the shutter button is pressed).



Selecting an aperture of **A** fixes shutter speed at 30 s.

To reduce “noise” (mottling) in long time-exposures, select **ON** for **IMAGE QUALITY SETTING > LONG EXPOSURE NR.** Note that this may increase the time needed to record images after shooting.

Using a Remote Release

An optional RR-90 remote release can be used for long time-exposures. The RR-90 connects via the Micro USB (Micro-B) USB 2.0 connector.

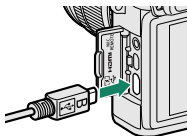

Alternatively, electronic releases from third-party suppliers can be connected via the microphone/remote release connector (ø2.5 mm 3-pole mini jack).

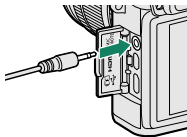

Third-party mechanical releases connect as shown.

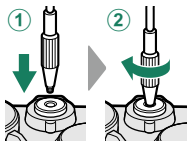

 A confirmation dialog will be displayed when a third-party release is connected; press **MENU/OK** and select **REMOTE** for **MIC/REMOTE RELEASE**.

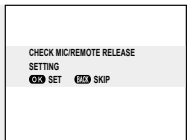

Mode A: Aperture-Priority AE

Choose an aperture and let the camera adjust shutter speed for optimal exposure.

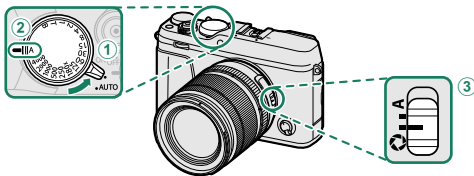



Adjust settings as follows:

- ① **Auto mode selector lever:** ●
- ② **Shutter speed:** A (auto)
- ③ **Aperture:** Select  and rotate the lens aperture ring to adjust aperture

Confirm that **A** appears in the display.



 If the correct exposure cannot be achieved at the selected aperture, shutter speed will be displayed in red. If the subject is outside the metering range of the camera, the shutter speed display will show “— — —”.

 Aperture can be adjusted even while the shutter button is pressed halfway.

Previewing Depth of Field

When **PREVIEW DEPTH OF FIELD** is assigned to a function button, pressing the button stops aperture down to the selected setting, allowing depth of field to be previewed in the display.

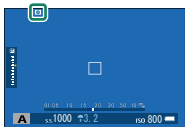

If both **AF DISTANCE INDICATOR** and **MF DISTANCE INDICATOR** are selected in the **SCREEN SET-UP > DISP. CUSTOM SETTING** list, depth of field can also be previewed using the depth-of-field indicator in the standard display. Use the **DISP/BACK** button to display standard indicators.

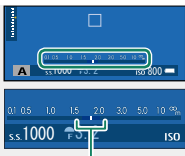

Depth of field

Use the **AF/MF SETTING > DEPTH-OF-FIELD SCALE** option to choose how depth of field is displayed. Choose **FILM FORMAT BASIS** to help you make practical assessments of depth of field for pictures that will be viewed as prints and the like, **PIXEL BASIS** to help you assess depth of field for pictures that will be viewed at high resolutions on computers or other electronic displays.

Sensitivity and Motion Blur

If you choose a narrow aperture when the subject is poorly lit, the shutter speed selected by the autoexposure program may not be fast enough to prevent motion blur. For faster shutter speeds that reduce motion blur, select a higher sensitivity.



Mode M: Manual Exposure

Alter exposure from that selected by the camera.

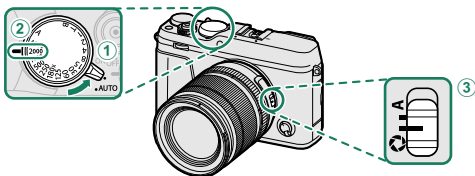

Adjust settings as follows:

- 1 **Auto mode selector lever:** ●
- 2 **Shutter speed:** Choose a shutter speed
- 3 **Aperture:** Select  and rotate the lens aperture ring to adjust aperture

Confirm that **M** appears in the display. The amount the picture would be under- or over-exposed at current settings is shown by the exposure indicator; adjust shutter speed and aperture until the desired exposure is reached.



 At settings other than **180X**, shutter speed can also be adjusted in increments of $\frac{1}{3}$ EV by rotating the rear command dial.

Exposure Preview

To preview exposure in the LCD monitor, select an option other than **OFF** for **SCREEN SET-UP > PREVIEW EXP./WB IN MANUAL MODE**. Select **OFF** when using the flash or on other occasions on which exposure may change when the picture is taken.



Auto Mode

The camera adjusts settings automatically according to the option selected by rotating the front command dial. Choose from modes suited to specific subject types, or select **SR+ ADVANCED SR AUTO** to let the camera automatically match the mode to the subject.

- 1 Press the **DRIVE** button and select  (**STILL IMAGE**) from the list of drive mode options.

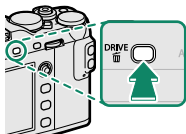

- 2 Rotate the auto mode selector lever to **AUTO**.

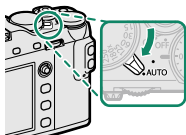



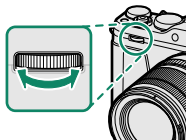



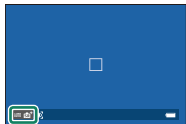

- 3 Rotate the front command dial to choose an option.



The currently-selected scene appears in the display.



Mode	Description
 ADVANCED SR AUTO	The camera automatically optimizes settings to suit the scene.
 PORTRAIT	Choose for portraits.
 PORTRAIT ENHANCER	Processes portraits to give the subject a smooth, natural-looking complexion.
 LANDSCAPE	Choose for daylight shots of buildings and landscapes.
 SPORT	Choose when photographing moving subjects.
 NIGHT	Choose for poorly lit twilight or night scenes.
 NIGHT (TRIPOD)	Choose this mode for slow shutter speeds when shooting at night.
 FIREWORKS	Slow shutter speeds are used to capture the expanding burst of light from a firework.
 SUNSET	Choose this mode to record the vivid colors in sunrises and sunsets.
 SNOW	Choose for crisp, clear shots that capture the brightness of scenes dominated by shining white snow.
 BEACH	Choose for crisp, clear shots that capture the brightness of sunlit beaches.
 UNDERWATER	Reduces the blue cast typically associated with underwater lighting.
 PARTY	Capture indoor background lighting under low-light conditions.
 FLOWER	Effective for taking more vivid shots of flowers.
 TEXT	Take clear pictures of text or drawings in print.

 Scene selection is also available using  **SHOOTING SETTING > SCENE POSITION** in the shooting menu.

SR+ ADVANCED SR AUTO

The scene selected by the camera in **SR+ ADVANCED SR AUTO** mode is shown by an icon in the display.

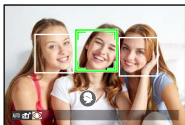

- AUTO
- LANDSCAPE
- NIGHT
- NIGHT (TRIPOD)
- MACRO
- BEACH
- SUNSET
- SNOW
- SKY
- GREENERY
- SKY & GREENERY
- PORTRAIT
- BACKLIT PORTRAIT
- MOVING OBJECT
- PORTRAIT&MOTION
- BACKLIT PORTRAIT&MOTION

The mode selected may vary with shooting conditions. If the mode and subject do not match, select a scene manually.

Autofocus

Take pictures using autofocus.

- 1 Rotate the focus mode selector to **S** or **C** (📖 78).

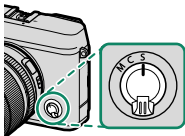

- 2 Use **AF/MF SETTING > AF MODE** to choose an AF mode (📖 80).

- 3 Choose the position and size of the focus frame (📖 82).

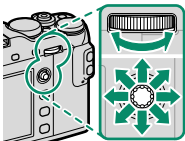

- 4 Take pictures.



For information on the autofocus system, visit:
<http://fujifilm-x.com/af/en/index.html>

Focus Mode

Use the focus mode selector to choose how the camera focuses.

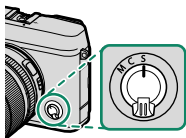

Choose from the following options:

Mode	Description
S (AF-S)	Single AF: Focus locks while the shutter button is pressed halfway. Choose for stationary subjects.
C (AF-C)	Continuous AF: Focus is continually adjusted to reflect changes in the distance to the subject while the shutter button is pressed halfway. Use for subjects that are in motion. Eye-detection AF is not available.
M (manual)	Manual: Focus manually using the lens focus ring. Choose for manual control of focus or in situations in which the camera is unable to focus using autofocus (📖 87).

Regardless of the option selected, manual focus will be used when the lens is in manual focus mode.

If **ON** is selected for **AF/MF SETTING > PRE-AF**, focus will be adjusted continuously in modes **S** and **C** even when the shutter button is not pressed.

The Focus Indicator

The focus indicator turns green when the subject is in focus and blinks white when the camera is unable to focus. Brackets (“()”) indicate that the camera is focusing and are displayed continuously in mode **C**. **MF** is displayed in manual focus mode.





Focus indicator

Autofocus Options (AF Mode)





Choose how the camera focuses in modes **S** and **C**.

- 1 Press **MENU/OK** and go to the shooting menu.
- 2 Select **AF/MF** **AF/MF SETTING** > **AF MODE**.
- 3 Choose an AF mode.

 This feature can also be accessed via shortcuts ( 246).

How the camera focuses depends on the focus mode.

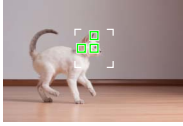
Focus Mode **S** (AF-S)

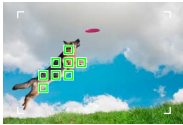
Option	Description	Sample image
 SINGLE POINT	Camera focuses on subject in selected focus point. Use for pin-point focus on selected subject.	
 ZONE	Camera focuses on subject in selected focus zone. Focus zones include multiple focus points, making it easier to focus on subjects in motion.	
 WIDE	Camera focuses automatically on high-contrast subjects; display shows areas in focus.	

Option	Description	Sample image
ALL ALL	Rotate the rear command dial in the focus-point selection display (📖 83, 84) to cycle through AF modes in the following order: □ SINGLE POINT , ☐ ZONE , and ☐ WIDE .	

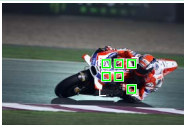
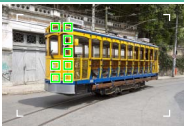

Focus Mode C (AF-C)

Option	Description	Sample image
□ SINGLE POINT	Focus tracks subject at selected focus point. Use for subjects moving toward or away from camera.	
☐ ZONE	Focus tracks subject in selected focus zone. Use for subjects that are moving fairly predictably.	
☐ TRACKING	Focus tracks subjects moving through wide area of frame.	
ALL ALL	Rotate the rear command dial in the focus-point selection display (📖 83, 84) to cycle through AF modes in the following order: □ SINGLE POINT , ☐ ZONE , and ☐ TRACKING .	

Focus-Point Selection

Choose a focus point for autofocus.

Viewing the Focus-Point Display

- 1 Press **MENU/OK** and go to the shooting menu.
- 2 Select  **AF/MF SETTING** > **FOCUS AREA** to view the focus-point display.
- 3 Use the focus stick (focus lever) and rear command dial to choose a focus area ( 83).









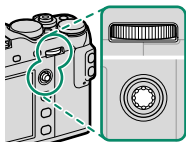

The focus point can also be selected using touch controls ( 22).







Selecting a Focus Point

Use the focus stick (focus lever) to choose the focus point and the rear command dial to choose the size of the focus frame. The procedure varies with the option selected for AF mode.



	Focus stick		Rear command dial	
AF mode	 Tilt	 Press	 Rotate	 Press
	Select focus point	Select center focus point	Choose from 6 frame sizes	Restore original size
			Choose from 3 frame sizes	
			—	

 Manual focus-point selection is not available when  **WIDE/TRACKING** is selected in focus mode **S**.





If  **ALL** is selected for AF mode, you can rotate the rear command dial in the focus-point selection display ( 84) to cycle through AF modes in the following order:  **SINGLE POINT** (6 frame sizes),  **ZONE** (3 frame sizes), and either  **WIDE** (focus mode **S**) or  **TRACKING** (focus mode **C**).

The Focus-Point Display

The focus-point display varies with the option selected for AF mode.

 Focus frames are shown by small squares (□), focus zones by the large squares.

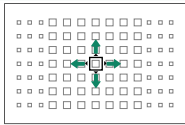
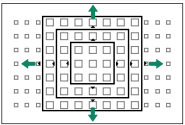
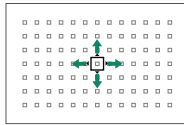
AF mode

 SINGLE POINT	 ZONE	 WIDE/TRACKING
		
Number of points available can be selected using  AF/MF SETTING > NUMBER OF FOCUS POINTS.	Choose from zones with 7×7 , 5×5 , or 3×3 focus points.	Position focus frame over subject and press MENU/OK.

Available Focus Points

TTL contrast-detect AF offers more focus points (①) than intelligent hybrid AF (②), which combines phase-detection with TTL contrast-detect AF.

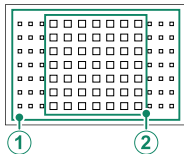

Burst Mode Focus-Frame Selection

When continuous high-speed (**8.0 fps, 11 fps, 14 fps**) is selected for drive mode, the number of focus frames available in focus mode **C** drops.

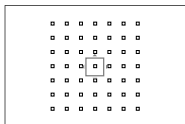
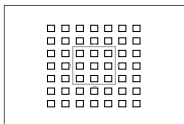
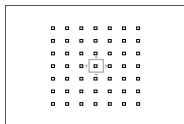
*Single point**Zone**Tracking***Autofocus**

Although the camera boasts a high-precision autofocus system, it may be unable to focus on the subjects listed below.

- Very shiny subjects such as mirrors or car bodies.
- Subjects photographed through a window or other reflective object.
- Dark subjects and subjects that absorb rather than reflect light, such as hair or fur.
- Insubstantial subjects, such as smoke or flame.
- Subjects that show little contrast with the background.
- Subjects positioned in front of or behind a high-contrast object that is also in the focus frame (for example, a subject photographed against a backdrop of highly contrasting elements).

Checking Focus

To zoom in on the current focus area for precise focus, press the center of the rear command dial. Press the center of the rear command dial again to cancel zoom.

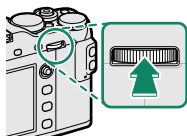

Normal display



Focus zoom



In focus mode **S**, zoom can be adjusted by rotating the rear command dial when **STANDARD** or **FOCUS PEAK HIGHLIGHT** is selected for **AF/MF SETTING > MF ASSIST** (📖 142). Focus zoom is not available in focus mode **C** or when **AF/MF SETTING > PRE-AF** is on or an option other than **SINGLE POINT** is selected for **AF MODE**.

Use **FUNCTION SETTING > FUNCTION (Fn) SETTING** to change the function performed by the center of the rear command dial or assign its default function to other controls.

Manual Focus

Adjust focus manually.

- 1 Rotate the focus mode selector to M.

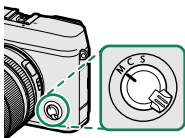

MF will appear in the display.

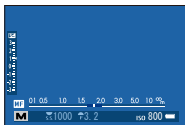

- 2 Focus manually using the lens focus ring. Rotate the ring left to reduce the focus distance, right to increase.



- 3 Take pictures.

Use **FUNCTION/DIAL SETTING > FOCUS RING** to reverse the direction of rotation of the focus ring.

Regardless of the option selected, manual focus will be used when the lens is in manual focus mode.

Quick Focus

To use autofocus to focus on the subject in the selected focus area, press the button to which focus lock or **AF-ON** has been assigned (the size of the focus area can be chosen with the rear command dial). In manual focus mode, you can use this feature to quickly focus on a chosen subject using either single or continuous AF according to the option chosen for

 **AF/MF SETTING > INSTANT AF SETTING.**

Checking Focus

A variety of options are available for checking focus in manual focus mode.

The Manual Focus Indicator

The manual focus indicator indicates how closely the focus distance matches the distance to the subject in the focus brackets. The white line indicates the distance to the subject in the focus area (in meters or feet according to the option selected for **SCREEN SET-UP > FOCUS SCALE UNITS** in the set-up menu), the blue bar the depth of field, or in other words the distance in front of and behind the subject that appears to be in focus.

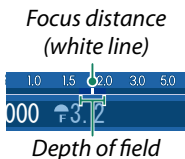

Focus Zoom

If **ON** is selected for **AF/MF SETTING > FOCUS CHECK**, the camera will automatically zoom in on the selected focus area when the focus ring is rotated. Press the center of the rear command dial to exit zoom.

If **STANDARD** or **FOCUS PEAK HIGHLIGHT** is selected for **AF/MF SETTING > MF ASSIST**, zoom can be adjusted by rotating the rear command dial.

MF Assist

The **AF/MF** **AF/MF SETTING** > **MF ASSIST** option can be used to check focus when pictures are framed in the LCD monitor or electronic viewfinder in manual focus mode.

 The **MF ASSIST** menu can be displayed by pressing and holding the center of the rear command dial.

The following options are available:

- **FOCUS PEAK HIGHLIGHT:** Highlights high-contrast outlines. Rotate the focus ring until the subject is highlighted.
- **DIGITAL SPLIT IMAGE:** Displays a split image in the center of the frame. Frame the subject in the split-image area and rotate the focus ring until the four parts of the split image are correctly aligned.

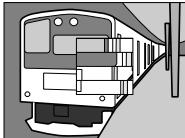



Exposure Compensation

Adjust exposure.

Rotate the exposure compensation dial.

 The amount of compensation available varies with the shooting mode.

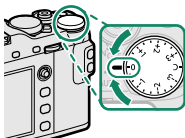

C (Custom)

When the exposure compensation dial is rotated to **C**, exposure compensation can be adjusted by rotating the front command dial.

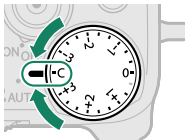

 The front command dial can be used to set exposure compensation to values between -5 and $+5$ EV.

The front command dial can be used to set aperture, exposure compensation, or (when **ON** is selected for **ISO COMMAND DIAL SETTING**) sensitivity. Press the dial to toggle between the different settings.

Focus/Exposure Lock

Compose photographs with off-center subjects.

- 1 Focus:** Position the subject in the focus frame and press the shutter button halfway to lock focus and exposure. Focus and exposure will remain locked while the shutter button is pressed halfway (AF/AE lock).



- 2 Recompose:** Keep the shutter button pressed halfway.



- 3 Shoot:** Press the button all the way down.



Focus lock using the shutter button is only available when **ON** is selected for **☑️ BUTTON/DIAL SETTING > SHUTTER AF, SHUTTER AE**.

The AF-L and AE-L Buttons

Focus and exposure can also be locked with the **AF-L** and **AE-L** buttons. At default settings, the **AF-L** button locks focus, the **AE-L** button exposure. Focus and/or exposure will remain locked while the button is pressed, whether or not the shutter button is pressed halfway.

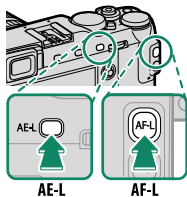

The roles of the buttons can be changed using the following **■ BUTTON/DIAL SETTING** options:

- **FUNCTION (Fn) SETTING:** Choose the roles played by the **AE-L** and **AF-L** buttons.
- **AE/AF-LOCK MODE:** If **AE&AF ON/OFF SWITCH** is selected for **AE/AF-LOCK MODE**, focus and/or exposure lock when the button is pressed and remain locked until the button is pressed again.

BKT Bracketing

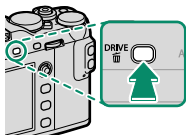

Automatically vary settings over a series of pictures.

- 1 Press the **DRIVE** button to display drive mode options.



- 2 Choose a bracketing type and (if **ISO** **ISO BKT** or **WB** **WHITE BALANCE BKT** is selected) a bracketing amount.
- 3 Press **MENU/OK** to end drive mode selection.
- 4 Take photographs.

 **AE BKT**

Use  **SHOOTING SETTING** > **AE BKT SETTING** to choose the bracketing amount and number of shots. Each time the shutter button is pressed, the camera will take the specified number of shots: one using the metered value for exposure and the others over- or under-exposed by multiples of the selected bracketing amount ( 154).





Regardless of the bracketing amount, exposure will not exceed the limits of the exposure metering system.

 **ISO BKT**

Select a bracketing amount (± 1 , $\pm 2/3$, or $\pm 1/3$). Each time the shutter is released, the camera will take a picture at the current sensitivity and process it to create two additional copies, one with sensitivity raised and the other with sensitivity lowered by the selected amount.

 **FILM SIMULATION BKT**

Each time the shutter is released, the camera takes one shot and processes it to create copies with different film simulation settings, chosen using  **SHOOTING SETTING** > **FILM SIMULATION BKT** ( 154).

WB WHITE BALANCE BKT

Select a bracketing amount (± 1 , ± 2 , or ± 3). Each time the shutter is released, the camera takes one shot and processes it to create three copies: one at the current white balanced setting, one with fine-tuning increased by the selected amount, and another with fine-tuning decreased by the selected amount.

DR DYNAMIC RANGE BKT

Each time the shutter button is pressed, the camera takes three shots with different dynamic ranges: 100% for the first, 200% for the second, and 400% for the third.



While dynamic range bracketing is in effect, sensitivity will be restricted to a minimum of ISO 800 (or to a minimum of ISO 200 to 800 when an auto option is selected for sensitivity); the sensitivity previously in effect is restored when bracketing ends.



Continuous Shooting (Burst Mode)

Capture motion in a series of pictures.

- 1 Press the **DRIVE** button to display drive mode options.

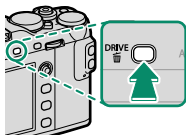

- 2 Select  **CONTINUOUS** and choose a frame advance rate.
- 3 Take photographs. The camera will take pictures while the shutter button is pressed; shooting ends when the shutter button is released or the memory card is full.



If file numbering reaches 999 before shooting is complete, the remaining pictures will be recorded to a new folder.



Burst shooting may not begin if the space available on the memory card is insufficient.

Frame rate varies with the subject, shutter speed, sensitivity, and focus mode. Frame rates may slow and recording times increase as more shots are taken.

The flash turns off automatically; the previously-selected flash mode is restored when burst shooting is disabled.

Focus and Exposure

Select focus mode **C** to vary focus with shot; to vary exposure with each shot, select **OFF** for  **BUTTON/DIAL SETTING > SHUTTER AE**.

 Selecting a frame rate of 8.0, 11, or 14fps restricts the choice of focus frames in focus mode **C** and limits Intelligent Face Detection to the area used for intelligent hybrid AF (TTL contrast-detect AF+phase-detection AF;  84).

Exposure and focus tracking performance may vary with such factors as aperture, sensitivity, and exposure compensation.



Advanced Filters

Take photos with filter effects.

- 1 Press the **DRIVE** button to display drive mode options.

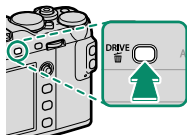













- 2 Highlight  **ADVANCED FILTER** and press **MENU/OK** to display advanced filter options.
- 3 Highlight an advanced filter and press **MENU/OK** to select the highlighted option and exit to shooting mode.
- 4 Take photographs.



When the auto mode selector lever is rotated to **AUTO**, you can rotate the front command dial to choose a filter in the shooting display.

Advanced Filter Options

Choose from the following filters:

Filter	Description
 TOY CAMERA	Choose for a retro toy camera effect.
 MINIATURE	The tops and bottoms of pictures are blurred for a diorama effect.
 POP COLOR	Create high-contrast images with saturated colors.
 HIGH-KEY	Create bright, low-contrast images.
 LOW-KEY	Create uniformly dark tones with few areas of emphasized highlights.
 DYNAMIC TONE	Dynamic tone expression is used for a fantasy effect.
 SOFT FOCUS	Create a look that is evenly soft throughout the whole image.
 PARTIAL COLOR (RED)	Areas of the image that are the selected color are recorded in that color. All other areas of the image are recorded in black-and-white.
 PARTIAL COLOR (ORANGE)	
 PARTIAL COLOR (YELLOW)	
 PARTIAL COLOR (GREEN)	
 PARTIAL COLOR (BLUE)	
 PARTIAL COLOR (PURPLE)	

 Depending on the subject and camera settings, images may in some cases be grainy or vary in brightness or hue.





Multiple Exposures

Create a photograph that combines two exposures.

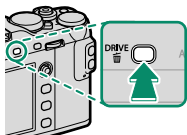

- 1 Press the **DRIVE** button to display drive mode options.



- 2 Select **Adv.**, then highlight  **MULTIPLE EXPOSURE** and press **MENU/OK** to select the highlighted option and return to shooting mode.
- 3 Take the first shot.

- 4 Press **MENU/OK**. The first shot will be shown superimposed on the view through the lens and you will be prompted to take the second shot.



To return to Step 3 and retake the first shot, press the focus stick (focus lever) left. To save the first shot and exit without creating a multiple exposure, press **DISP/BACK**.

- 5 Take the second shot, using the first frame as a guide.



- 6 Press **MENU/OK** to create the multiple exposure, or press the focus stick left to return to Step 5 and retake the second shot.







Panoramas

Follow an on-screen guide to create a panorama.

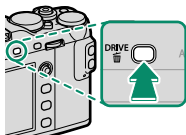
- 1 Press the **DRIVE** button to display drive mode options.



- 2 Select **Adv.**, then highlight  **PANORAMA** and press **MENU/OK** to select the highlighted option and return to shooting mode.
- 3 To select the size of the angle through which you will pan the camera while shooting, press the focus stick (focus lever) left. Highlight a size and press **MENU/OK**.
- 4 Press the focus stick right to view a choice of pan directions. Highlight a pan direction and press **MENU/OK**.
- 5 Press the shutter button all the way down to start recording. There is no need to keep the shutter button pressed during recording.

- 6 Pan the camera in the direction shown by the arrow. Shooting ends automatically when the camera is panned to the end of the guides and the panorama is complete.

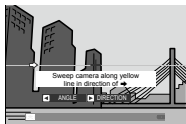

For Best Results

For best results, use a lens with a focal length of 35 mm or less (50 mm or less in 35 mm format). Prop your elbows against your sides and move the camera slowly in a small circle at a steady speed, keeping the camera parallel or at right angles to the horizon and being careful only to pan in the direction shown by the guides. Use a tripod for best results. If the desired results are not achieved, try panning at a different speed.



If the shutter button is pressed all the way down before the panorama is complete, shooting will end and no panorama may be recorded. Shooting may also be interrupted if the camera is panned too quickly or too slowly. Panning the camera in a direction other than that shown cancels shooting.

Panoramas are created from multiple frames; if **ON** is selected for **☑️ BUTTON/DIAL SETTING > SHUTTER AE**, exposure for the entire panorama is determined by the first frame. The camera may in some cases record an greater or lesser angle than selected or be unable to stitch the frames together perfectly. The last part of the panorama may not be recorded if shooting ends before the panorama is complete.

The desired results may not be achieved with moving subjects, subjects close to the camera, unvarying subjects such as the sky or a field of grass, subjects that are in constant motion, such as waves and waterfalls, or subjects that undergo marked changes in brightness. Panoramas may be blurred if the subject is poorly lit.

Viewing Panoramas

In full-frame playback, you can use the rear command dial to zoom panoramas in or out. Alternatively, you can play the panorama back using the focus stick (focus lever).

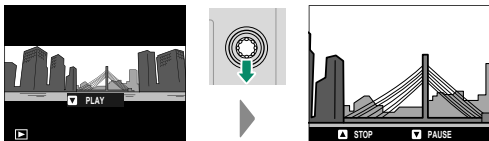

Press the focus stick down to start playback and press again to pause. Press the focus stick left or right to change the pan direction while playback is in progress or to scroll the panorama while playback is paused; vertical panoramas will scroll vertically, horizontal panoramas horizontally. To exit to full-frame playback, press the focus stick up.

Flash Photography

Use the supplied EF-X8 shoe-mounted flash unit for additional lighting at night or indoors under low light.

- 1 Slide the flash onto the hot shoe as shown, stopping when it clicks into place.

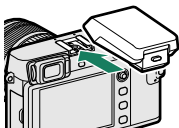

- 2 Raise the flash.

! If the flash is not raised, settings will be adjusted for units connected via the sync terminal (📖 263).

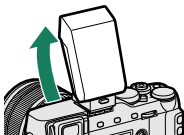

- 3 Select **FLASH SETTING** > **FLASH FUNCTION SETTING** in the camera menus to display options for the EF-X8.

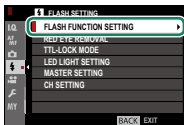

📖 This feature can also be accessed via shortcuts (📖 246).

- 4 Highlight items using the focus stick (focus lever) and rotate the rear command dial to change the highlighted setting (📖 109).

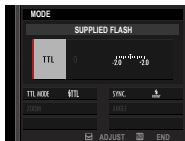

- 5 Press **DISP/BACK** to put the changes into effect.

! Depending on the distance to the subject, some lenses may cast shadows in photos taken with the flash.

The flash will not fire at some settings, for example in panorama mode or when the electronic shutter is used.

Choose shutter speeds slower than **180X** when using the flash in exposure mode **S** (shutter-priority AE) or manual (**M**).

📷 In TTL mode, the flash may fire several times with each shot. Do not move the camera until shooting is complete.

Flash Settings

The following settings are available when the supplied EF-X8 shoe-mounted flash unit is attached.

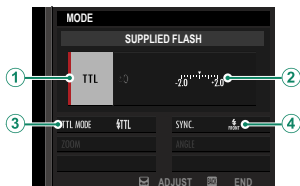

Setting	Description
<p>(1) Flash control mode</p>	<p>Choose from the following options:</p> <ul style="list-style-type: none"> • TTL: TTL mode. Adjust flash compensation ((2)) and choose a flash mode ((3)). • M: The flash fires at the selected output ((2)) regardless of subject brightness or camera settings. Output is expressed in fractions of full power, from 1/1 to 1/64. The desired results may not be achieved at low values if they exceed the limits of the flash control system; take a test shot and check the results. • COMMANDER: Choose if the flash is being used to control remote synced flash units, for example as part of a studio flash system. • OFF (OFF): The EF-X8 does not fire. Flash units connected via the sync terminal will still fire when the shutter is released, but can be disabled by lowering the EF-X8 and turning the units off in the flash settings menu.

Setting	Description
② Flash compensation/output	Adjust flash level. The options available vary with the flash control mode (①).
③ Flash mode (TTL)	<p>Choose a flash mode for TTL flash control. The options available vary with the shooting mode (P, S, A, or M) selected.</p> <ul style="list-style-type: none"> • FLASH AUTO: The flash fires only as required; flash level is adjusted according to subject brightness. A  icon displayed when the shutter button is pressed halfway indicates that the flash will fire when the photo is taken. • STANDARD: The flash fires with every shot if possible; flash level is adjusted according to subject brightness. The flash will not fire if not fully charged when the shutter is released. • SLOW SYNC.: Combine the flash with slow shutter speeds when photographing portrait subjects against a backdrop of night scenery. The flash will not fire if not fully charged when the shutter is released.
④ Sync	<p>Choose whether the flash is timed to fire immediately after the shutter opens (FRONT/1ST CURTAIN) or immediately before it closes (REAR/2ND CURTAIN). 1ST CURTAIN is recommended in most circumstances.</p>

Red-Eye Removal

Red-eye removal is available when an option other than **OFF** is selected for **[F] FLASH SETTING > RED EYE REMOVAL** and **[AF/MF] AF/MF SETTING > FACE/EYE DETECTION SETTING** is **ON**. Red-eye removal minimizes “red-eye” caused when light from the flash is reflected from the subject’s retinas.

Flash Sync Speed

The flash will synchronize with the shutter at shutter speeds of $\frac{1}{180}$ s or slower.

Optional Flash Units from FUJIFILM

The camera can be used with optional FUJIFILM shoe-mounted flash units.

Third-Party Flash Units

Do not use third-party flash units that apply over 300 V to the camera hot shoe.

MEMO

The Shooting Menus

6

IMAGE QUALITY SETTING

Adjust image quality settings.

To display image quality settings, press **MENU/OK** in the shooting display and select the **I.Q.** (**IMAGE QUALITY SETTING**) tab.



The options available vary with the shooting mode selected.

IMAGE SIZE

Choose the size and aspect ratio at which still pictures are recorded.

Option	Image size	Option	Image size	Option	Image size
L 3:2	6000 × 4000	L 16:9	6000 × 3376	L 1:1	4000 × 4000
M 3:2	4240 × 2832	M 16:9	4240 × 2384	M 1:1	2832 × 2832
S 3:2	3008 × 2000	S 16:9	3008 × 1688	S 1:1	2000 × 2000

 **IMAGE SIZE** is not reset when the camera is turned off or another shooting mode is selected.

Aspect Ratio

Pictures with an aspect ratio of 3:2 have the same proportions as a frame of 35 mm film, while an aspect ratio of 16:9 is suited to display on **H**igh **D**efinition (HD) devices. Pictures with an aspect ratio of 1:1 are square.

IMAGE QUALITY

Choose a file format and compression ratio. Select **FINE** or **NORMAL** to record JPEG images, **RAW** to record RAW images, or **FINE+RAW** or **NORMAL+RAW** to record both JPEG and RAW images. **FINE** and **FINE+RAW** use lower JPEG compression ratios for higher-quality JPEG images, while **NORMAL** and **NORMAL+RAW** use higher JPEG compression ratios to increase the number of images that can be stored.

The Function Buttons

To toggle RAW image quality on or off for a single shot, assign **RAW** to a function button (📖 254). If a JPEG option is currently selected for image quality, pressing the button temporarily selects the equivalent JPEG+RAW option. If a JPEG+RAW option is currently selected, pressing the button temporarily selects the equivalent JPEG option, while if **RAW** is selected, pressing the button temporarily selects **FINE**. Taking a picture or pressing the button again restores the previous setting.







RAW RECORDING



Choose whether to compress RAW images.

Option	Description
UNCOMPRESSED	RAW images are not compressed.
LOSSLESS COMPRESSED	RAW images are compressed using a reversible algorithm that reduces file size with no loss of image data. The images can be viewed in RAW FILE CONVERTER EX 2.0 or other software that supports "lossless" RAW compression.





FILM SIMULATION

Simulate the effects of different kinds of film, including black-and-white (with or without color filters). Choose a palette according to your subject and creative intent.

Option	Description
 PROVIA/ STANDARD	Standard color reproduction. Suited to a wide range of subjects, from portraits to landscapes.
 Velvia/VIVID	A high-contrast palette of saturated colors, suited to nature photos.
 ASTIA/SOFT	Enhances the range of hues available for skin tones in portraits while preserving the bright blues of daylight skies. Recommended for outdoor portrait photography.
 CLASSIC CHROME	Soft color and enhanced shadow contrast for a calm look.
 PRO Neg. Hi	Offers slightly more contrast than  PRO Neg. Std . Recommended for outdoor portrait photography.
 PRO Neg. Std	A soft-toned palette. The range of hues available for skin tones is enhanced, making this a good choice for studio portrait photography.

Option	Description
 ACROS*	Take black-and-white photos with rich gradation and outstanding sharpness.
 MONOCHROME*	Take pictures in standard black and white.
 SEPIA	Take pictures in sepia.

* Available with yellow (**Ye**), red (**R**), and green (**G**) filters, which deepen shades of gray corresponding to hues complementary to the selected color. The yellow (**Ye**) filter deepens purples and blues and the red (**R**) filter blues and greens. The green (**G**) filter deepens reds and browns, including skin tones, making it a good choice for portraits.

 The only options available when the auto mode selector lever is rotated to **AUTO** are  **STD**,  **B**, and  **SEPIA**.

Film simulation options can be combined with tone and sharpness settings.

Film simulation settings can also be accessed via shortcuts ( 246).

For more information, visit: <http://fujifilm-x.com/en/x-stories/the-world-of-film-simulation-episode-1/>

GRAIN EFFECT

Add a film grain effect. Select an amount (**STRONG** or **WEAK**) or choose **OFF** to turn film grain off.

Options		
STRONG	WEAK	OFF

DYNAMIC RANGE

Control contrast. Choose lower values to increase contrast when shooting indoors or under overcast skies, higher values to reduce loss of detail in highlights and shadows when photographing high-contrast scenes. Higher values are recommended for scenes that include both sunlight and deep shade, for such high-contrast subjects as sunlight on water, brightly-lit autumn leaves, and portraits taken against a blue sky, and for white objects or people wearing white; note, however, that mottling may appear in pictures taken at higher values.

Options			
AUTO	☺100 100%	☺200 200%	☺400 400%













If **AUTO** is selected, the camera will automatically choose either **☺100 100%** or **☺200 200%** according to the subject and shooting conditions. Shutter speed and aperture will be displayed when the shutter button is pressed halfway.

☺200 200% is available at sensitivities of ISO 400 and above, **☺400 400%** at sensitivities of ISO 800 and above.

WHITE BALANCE

For natural colors, choose a white balance option that matches the light source.

Option	Description
AUTO	White balance is adjusted automatically.
	Measure a value for white balance.
	Choose a color temperature.
	For subjects in direct sunlight.
	For subjects in the shade.
	Use under "daylight" fluorescent lights.
	Use under "warm white" fluorescent lights.
	Use under "cool white" fluorescent lights.
	Use under incandescent lighting.
	Reduces the blue cast typically associated with underwater lighting.

 Results vary with shooting conditions. Play pictures back after shooting to check colors.

White balance is adjusted for flash lighting only in **AUTO** and  modes. Turn the flash off using other white balance options.

White balance options can also be accessed via shortcuts ( 246).

Fine-Tuning White Balance

Pressing **MENU/OK** after selecting a white balance option displays the dialog shown at right; use the focus stick (focus lever) to fine-tune white balance or press **DISP/BACK** to exit without fine-tuning.

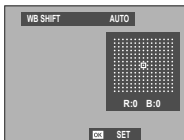

The focus stick (focus lever) does not tilt diagonally.

Custom White Balance

Choose \mathcal{Q}_1 , \mathcal{Q}_2 , or \mathcal{Q}_3 to adjust white balance for unusual lighting conditions. White balance measurement options will be displayed; frame a white object so that it fills the display and press the shutter button all the way down to measure white balance (to select the most recent custom value and exit without measuring white balance, press **DISP/BACK**, or press **MENU/OK** to select the most recent value and display the fine-tuning dialog).

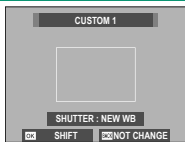

- If **"COMPLETED!"** is displayed, press **MENU/OK** to set white balance to the measured value.
- If **"UNDER"** is displayed, raise exposure compensation and try again.
- If **"OVER"** is displayed, lower exposure compensation and try again.

K: Color Temperature

Selecting **K** in the white balance menu displays a list of color temperatures; highlight a color temperature and press **MENU/OK** to select the highlighted option and display the fine-tuning dialog.

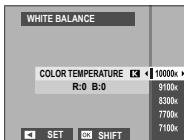

Color Temperature

Color temperature is an objective measure of the color of a light source, expressed in Kelvin (K). Light sources with a color temperature close to that of direct sunlight appear white; light sources with a lower color temperature have a yellow or red cast, while those with a higher color temperature are tinged with blue. You can match color temperature to the light source, or choose options that differ sharply from the color of the light source to make pictures “warmer” or “colder.”

HIGHLIGHT TONE

Adjust the appearance of highlights. Choose from seven options between +4 and -2.

Options						
+4	+3	+2	+1	0	-1	-2

SHADOW TONE

Adjust the appearance of shadows. Choose from seven options between +4 and -2.

Options						
+4	+3	+2	+1	0	-1	-2

COLOR

Adjust color density. Choose from nine options between +4 and -4.

Options								
+4	+3	+2	+1	0	-1	-2	-3	-4

SHARPNESS

Sharpen or soften outlines. Choose from nine options between +4 and -4.

Options								
+4	+3	+2	+1	0	-1	-2	-3	-4

NOISE REDUCTION

Reduce noise in pictures taken at high sensitivities. Choose from nine options between +4 and -4.

Options								
+4	+3	+2	+1	0	-1	-2	-3	-4

LONG EXPOSURE NR

Select **ON** to reduce mottling in long time-exposures.

Options	
ON	OFF

LENS MODULATION OPTIMIZER

Select **ON** to improve definition by adjusting for diffraction and the slight loss of focus at the periphery of the lens.

Options	
ON	OFF

COLOR SPACE

Choose the gamut of colors available for color reproduction.

Option	Description
sRGB	Recommended in most situations.
Adobe RGB	For commercial printing.

PIXEL MAPPING

Use this option if you notice bright spots in your pictures.

- 1 Press **MENU/OK** in the shooting display and select the  **IMAGE QUALITY SETTING** tab.
- 2 Highlight **PIXEL MAPPING** and press **MENU/OK** to perform pixel mapping. Processing may take a few seconds.



Results are not guaranteed.

Be sure the battery is fully charged before beginning pixel mapping.

Pixel mapping is not available when the camera temperature is elevated.

SELECT CUSTOM SETTING

Recall settings saved with **EDIT/SAVE CUSTOM SETTING**. Settings can be recalled from any of the seven custom settings banks.

Banks			
CUSTOM 1	CUSTOM 2	CUSTOM 3	CUSTOM 4
CUSTOM 5	CUSTOM 6	CUSTOM 7	

EDIT/SAVE CUSTOM SETTING

Save up to 7 sets of custom camera settings for commonly-encountered situations. Saved settings can be recalled using **Q IMAGE QUALITY SETTING > SELECT CUSTOM SETTING**.

- 1 Press **MENU/OK** in shooting mode to display the shooting menu. Select the **Q IMAGE QUALITY SETTING** tab, then highlight **EDIT/SAVE CUSTOM SETTING** and press **MENU/OK**.

- 2 Highlight a custom settings bank and press **MENU/OK** to select.

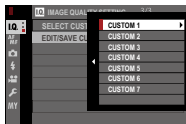

- 3 Adjust the following as desired:

- ISO
- DYNAMIC RANGE
- FILM SIMULATION
- GRAIN EFFECT
- WHITE BALANCE
- HIGHLIGHT TONE
- SHADOW TONE
- COLOR
- SHARPNESS
- NOISE REDUCTION

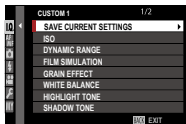

- 4 Press **DISP/BACK**. A confirmation dialog will be displayed; highlight **OK** and press **MENU/OK**.

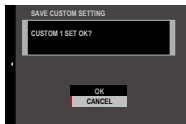

To store current camera settings in the selected bank, highlight **SAVE CURRENT SETTINGS** in Step 3 and press **MENU/OK**. Banks can be renamed using **EDIT CUSTOM NAME**.

To restore default settings for the current bank, select **RESET**.



AF/MF SETTING

Adjust focus settings.

To display focus settings, press **MENU/OK** in the shooting display and select the  (**AF/MF SETTING**) tab.

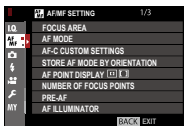









The options available vary with the shooting mode selected.

FOCUS AREA

Choose the focus area for autofocus, manual focus, and focus zoom.

AF MODE

Choose the AF mode for focus modes **S** and **C**.

Option	Description
 SINGLE POINT	The camera focuses on the subject in the selected focus point. The number of focus points available can be selected using  AF/MF SETTING > NUMBER OF FOCUS POINTS . Use for pin-point focus on a selected subject.
 ZONE	The camera focuses on the subject in the selected focus zone. Focus zones include multiple focus points, making it easier to focus on subjects that are in motion.
 WIDE/ TRACKING	In focus mode C , the camera tracks focus on the subject in the selected focus point while the shutter button is pressed halfway. In focus mode S , the camera automatically focuses on high-contrast subjects; the areas in focus are shown in the display. The camera may be unable to focus on small objects or subjects that are moving rapidly.
 ALL	Rotate the rear command dial in the focus-point selection display ( 83, 84) to cycle through AF modes in the following order:  SINGLE POINT ,  ZONE , and  WIDE/TRACKING .

AF-C CUSTOM SETTINGS

Select focus-tracking options for focus mode C. Choose from Sets 1–5 according to your subject.

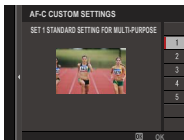

Option	Description
SET 1 STANDARD SETTING FOR MULTI-PURPOSE	A standard tracking option that works well with the typical range of moving subjects.
SET 2 IGNORE OBSTACLES & CONTINUE TO TRACK SUBJECT	The focus system attempts to track the chosen subject. Choose with subjects that are hard to keep in the focus area or if other objects are likely to enter the focus area with the subject.
SET 3 FOR ACCELERATING/ DECELERATING SUBJECT	The focus system attempts to compensate for subject acceleration or deceleration. Choose for subjects prone to rapid changes in velocity.
SET 4 FOR SUDDENLY APPEARING SUBJECT	The focus system attempts to focus quickly on subjects entering the focus area. Choose for subjects that appear abruptly or when rapidly switching subjects.
SET 5 FOR ERRATICALLY MOVING & ACCEL./DECEL. SUBJECT	Choose for hard-to-track subjects prone not only to sudden changes in velocity but also to large movements front to back and left to right.

STORE AF MODE BY ORIENTATION

Choose whether the focus mode and focus area used when the camera is in portrait orientation are stored separately from those used when the camera is in landscape orientation.

Option	Description
OFF	The same settings are used in both orientations.
FOCUS AREA ONLY	The focus area for each orientation can be selected separately.
ON	The focus mode and focus area can be selected separately.

AF POINT DISPLAY

Choose whether individual focus frames are displayed when **ZONE** or **WIDE/TRACKING** is selected for  **AF/MF SETTING > AF MODE**.

Options	
ON	OFF

NUMBER OF FOCUS POINTS

Choose the number of focus points available for focus-point selection in manual focus mode or when **SINGLE POINT** is selected for **AF MODE**.

Option	Description
91 POINTS (7 × 13)	Choose from 91 focus points arranged in a 7- by 13-point grid.
325 POINTS (13 × 25)	Choose from 325 focus points arranged in a 13- by 25-point grid.

PRE-AF

If **ON** is selected, the camera will continue to adjust focus even when the shutter button is not pressed halfway. Note that this increases the drain on the battery.

Options	
ON	OFF

AF ILLUMINATOR

If **ON** is selected, the AF-assist illuminator will light to assist autofocus.

Options	
ON	OFF

 The camera may be unable to focus using the AF-assist illuminator in some cases. If the camera is unable to focus, try increasing the distance to the subject.

Avoid shining the AF-assist illuminator directly into your subject's eyes.

FACE/EYE DETECTION SETTING

Intelligent Face Detection sets focus and exposure for human faces anywhere in the frame, preventing the camera from focusing on the background in group portraits. Choose for shots that emphasize portrait subjects. Faces can be detected with the camera in vertical or horizontal orientation; if a face is detected, it will be indicated by a green border. If there is more than one face in the frame, the camera will select the face closest to the center; other faces are indicated by white borders. You can also choose whether the camera detects and focuses on eyes when Intelligent Face Detection is on. Choose from the following options:

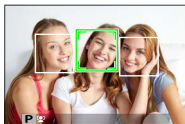

Option	Description
FACE ON/EYE OFF	Intelligent Face Detection only.
FACE ON/EYE AUTO	The camera automatically chooses which eye to focus on when a face is detected.
FACE ON/RIGHT EYE PRIORITY	The camera focuses on the right eye of subjects detected using Intelligent Face Detection.
FACE ON/LEFT EYE PRIORITY	The camera focuses on the left eye of subjects detected using Intelligent Face Detection.
FACE OFF/EYE OFF	Intelligent Face Detection and eye priority off.



In some modes, the camera may set exposure for the frame as a whole rather than the portrait subject.

If the subject moves as the shutter button is pressed, the face may not be in the area indicated by the green border when the picture is taken.



If the camera is unable to detect the subject's eyes because they are hidden by hair, glasses, or other objects, the camera will instead focus on faces.

Face/eye detection options can also be accessed via shortcuts ( 246).

AF+MF

If **ON** is selected in focus mode **S**, focus can be adjusted manually by rotating the focus ring while the shutter button is pressed halfway. Both standard and focus peaking MF assist options are supported.

Options	
ON	OFF

 Lenses with a focus distance indicator must be set to manual focus mode (MF) before this option can be used. Selecting MF disables the focus distance indicator. Set the focus ring to the center of the focus distance indicator, as the camera may fail to focus if the ring is set to infinity or the minimum focus distance.

AF + MF Focus Zoom

When **ON** is selected for  **AF/MF SETTING > FOCUS CHECK** and **SINGLE POINT** selected for **AF MODE**, focus zoom can be used to zoom in on the selected focus area. The zoom ratio (2.5x or 6x) can be selected using the rear command dial.

MF ASSIST

Choose how focus is displayed in manual focus mode.

Option	Description
STANDARD	Focus is displayed normally (focus peaking and digital split image are not available).
DIGITAL SPLIT IMAGE	Displays a black-and-white (MONOCHROME) or color (COLOR) split image in the center of the frame. Frame the subject in the split-image area and rotate the focus ring until the three parts of the split image are correctly aligned.
FOCUS PEAK HIGHLIGHT	The camera heightens high-contrast outlines. Choose a color and peaking level.



You can also choose MF assist options by holding the center of the rear command dial.

FOCUS CHECK

If **ON** is selected, the display will automatically zoom in on the selected focus area when the focus ring is rotated in manual focus mode.

Options	
ON	OFF

 Pressing the center of the rear command dial cancels focus zoom.

INTERLOCK SPOT AE & FOCUS AREA

Select **ON** to meter the current focus frame when **SINGLE POINT** is selected for **AF MODE** and **SPOT** is selected for **PHOTOMETRY**.

Options	
ON	OFF

INSTANT AF SETTING

Choose whether the camera focuses using single AF (**AF-S**) or continuous AF (**AF-C**) when the **AF-L** button is pressed in manual focus mode.

Options	
AF-S	AF-C

DEPTH-OF-FIELD SCALE

Choose **FILM FORMAT BASIS** to help you make practical assessments of depth of field for pictures that will be viewed as prints and the like, **PIXEL BASIS** to help you assess depth of field for pictures that will be viewed at high resolutions on computers or other electronic displays.

Options	
PIXEL BASIS	FILM FORMAT BASIS

RELEASE/FOCUS PRIORITY





Choose how the camera focuses in focus mode **AF-S** or **AF-C**.

Option	Description
RELEASE	Shutter response is prioritized over focus. Pictures can be taken when the camera is not in focus.
FOCUS	Focus is prioritized over shutter response. Pictures can be only taken when the camera is in focus.

TOUCH SCREEN MODE

Choose the shooting operations performed using touch controls.



Still Photography



Mode	Description
TOUCH SHOOTING 	Tap your subject in the display to focus and release the shutter. In burst mode, pictures will be taken while you keep your finger on the display.
AF 	Tap to select a focus point. In focus mode S (AF-S), focus will lock, while in focus mode C (AF-C), the camera will continually adjust focus in response to changes in the distance to the subject. Focus lock and continuous focus can be ended by tapping the AF OFF icon.
AREA 	Tap to select a point for focus or zoom. The focus frame will move to the selected point.
OFF 	Touch controls off. The display does not respond when tapped.



Movie Recording



We recommend that you select **AREA** for **MOVIE AF MODE** in the shooting menu  (movie) tab before recording movies using touch controls (in some movie modes, **AREA** will be selected automatically).

Mode	Description
<p>TOUCH SHOOTING</p> 	<p>Tap your subject in the display to focus and start recording. In focus mode C (AF-C), the camera will continually adjust focus in response to changes in the distance to the subject; to refocus in focus mode S (AF-S) or to focus on a new subject in focus mode C, tap the subject in the monitor. <i>To end recording, press the shutter button.</i></p>
<p>AF</p> 	<p>Tap your subject in the display to focus and <i>press the shutter button to start or end recording.</i> In focus mode C (AF-C), the camera will continually adjust focus in response to changes in the distance to the subject; to refocus in focus mode S (AF-S) or to focus on a new subject in focus mode C, tap the subject in the monitor.</p>

Mode	Description
<p>AREA</p> 	<p>Tap to select a focus point and <i>press the shutter button to start or end recording</i>. In focus mode C (AF-C), the camera will continually adjust focus in response to changes in the distance to the subject in the selected focus point. In focus mode S (AF-S), you can move the focus point by tapping the display, but can only re-focus using the control to which AF-ON has been assigned (📖 227).</p>
<p>OFF</p> 	<p>Touch controls off. The display does not respond when tapped.</p>

 To disable touch controls and hide the touch screen mode indicator, select **OFF** for  **BUTTON/DIAL SETTING** > **TOUCH SCREEN SETTING** > **TOUCH SCREEN ON/OFF**.



SHOOTING SETTING

Adjust shooting options.



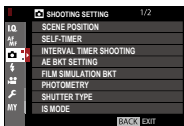



To display shooting options, press **MENU/OK** in the shooting display and select the  (**SHOOTING SETTING**) tab.











The options available vary with the shooting mode selected.

SCENE POSITION



Choose the shooting mode used when the auto mode selector lever is in the **AUTO** position.

Mode	Description
 ADVANCED SR AUTO	The camera automatically optimizes settings to suit the scene.
 PORTRAIT	Choose for portraits.
 PORTRAIT ENHANCER	Processes portraits to give the subject a smooth, natural-looking complexion.
 LANDSCAPE	Choose for daylight shots of buildings and landscapes.
 SPORT	Choose when photographing moving subjects.
 NIGHT	Choose for poorly lit twilight or night scenes.

Mode	Description
 NIGHT (TRIPOD)	Choose this mode for slow shutter speeds when shooting at night.
 FIREWORKS	Slow shutter speeds are used to capture the expanding burst of light from a firework.
 SUNSET	Choose this mode to record the vivid colors in sunrises and sunsets.
 SNOW	Choose for crisp, clear shots that capture the brightness of scenes dominated by shining white snow.
 BEACH	Choose for crisp, clear shots that capture the brightness of sunlit beaches.
 UNDERWATER	Reduces the blue cast typically associated with underwater lighting.
 PARTY	Capture indoor background lighting under low-light conditions.
 FLOWER	Effective for taking more vivid shots of flowers.
 TEXT	Take clear pictures of text or drawings in print.

SELF-TIMER

Choose a shutter release delay.

Option	Description
 2 SEC	The shutter is released two seconds after the shutter button is pressed. Use to reduce blur caused by the camera moving when the shutter button is pressed. The self-timer lamp blinks as the timer counts down.
 10 SEC	The shutter is released ten seconds after the shutter button is pressed. Use for photographs in which you wish to appear yourself. The self-timer lamp blinks immediately before the picture is taken.
OFF	Self-timer off.

If an option other than **OFF** is selected, the timer will start when the shutter button is pressed all the way down. The display in the monitor shows the number of seconds remaining until the shutter is released. To stop the timer before the picture is taken, press **DISP/BACK**.



 Stand behind the camera when using the shutter button. Standing in front of the lens can interfere with focus and exposure.

The self-timer turns off automatically when the camera is turned off.

INTERVAL TIMER SHOOTING

Configure the camera to take photos automatically at a preset interval.

- 1 Highlight **INTERVAL TIMER SHOOTING** in the  (**SHOOTING SETTING**) tab and press **MENU/OK**.

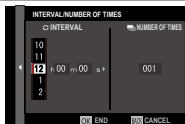

- 2 Use the focus stick (focus lever) to choose the interval and number of shots. Press **MENU/OK** to proceed.



- 3 Use the focus stick to choose the starting time and then press **MENU/OK**. Shooting will start automatically.





Interval timer photography cannot be used at a shutter speed of **B** (bulb) or with multiple exposure photography. In burst mode, only one picture will be taken each time the shutter is released.



Use of a tripod is recommended.

Check the battery level before starting. We recommend using an optional AC-9V AC power adapter and CP-W126 DC coupler.

The display sometimes turns off between shots and lights a few seconds before the next shot is taken. The display can be activated at any time by pressing the shutter button.

To continue shooting until the memory card is full, set the number of shots to ∞ .









AE BKT SETTING

Adjust exposure bracketing settings.

Option	Description
FRAMES/ STEP SETTING	Choose the number of shots in the bracketing sequence (FRAMES) and the amount exposure is varied with each shot (STEP).
1 FRAME/ CONTINUOUS	Choose whether the shots in the bracketing sequence are taken one at a time (1 FRAME) or in a single burst (CONTINUOUS).
SEQUENCE SETTING	Choose the order in which the shots are taken.

FILM SIMULATION BKT

Choose the three film simulation types used for film simulation bracketing (📖 118).





Options		
 STD PROVIA/STANDARD	 V Velvia/VIVID	 S ASTIA/SOFT
 G CLASSIC CHROME	 NH PRO Neg. Hi	 NS PRO Neg. Std
 A ACROS*	 B MONOCHROME*	 SEPIA

* Available with yellow (**Ye**), red (**R**), and green (**G**) filters.

PHOTOMETRY

Choose how the camera meters exposure.

 The selected option will only take effect when **AF/MF SETTING > FACE/EYE DETECTION SETTING** is **FACE OFF/EYE OFF**.

Mode	Description
 (multi)	The camera instantly determines exposure based on an analysis of composition, color, and brightness distribution. Recommended in most situations.
 (center-weighted)	The camera meters the entire frame but assigns the greatest weight to the area at the center.
 (spot)	The camera meters lighting conditions in an area at the center of the frame equivalent to 2% of the total. Recommended with backlit subjects and in other cases in which the background is much brighter or darker than the main subject.
 (average)	Exposure is set to the average for the entire frame. Provides consistent exposure across multiple shots with the same lighting, and is particularly effective for landscapes and portraits of subjects dressed in black or white.

SHUTTER TYPE

Choose the shutter type. Choose the electronic shutter to mute the shutter sound.

Option	Description
MS MECHANICAL SHUTTER	Take pictures with the mechanical shutter.
ES ELECTRONIC SHUTTER	Take pictures with the electronic shutter.
MS MECHANICAL + ES ELECTRONIC	The camera chooses the shutter type according to shooting conditions.





If an option other than **MS MECHANICAL SHUTTER** is selected, shutter speeds faster than $\frac{1}{4000}$ s can be chosen by rotating the shutter speed dial to **4000** and then rotating the rear command dial.

 Distortion may be visible in shots of moving subjects with electronic shutter, while banding and fog may occur in shots taken under fluorescent lights or other flickering or erratic illumination. When taking pictures with the shutter muted, respect your subjects' image rights and right to privacy.

 When the electronic shutter is used, the flash is disabled, sensitivity is restricted to values of ISO 12800–200, and long exposure noise reduction has no effect.

IS MODE

Choose from the following image stabilization options:

Option	Description
 CONTINUOUS + MOTION	Image stabilization on. If + MOTION is selected, the camera will adjust shutter speed to reduce motion blur when a moving objects are detected.
 CONTINUOUS	
 SHOOTING + MOTION	As above, except that image stabilization is performed only when the shutter button is pressed halfway (focus mode C only) or the shutter is released. If + MOTION is selected, the camera will adjust shutter speed to reduce motion blur when a moving objects are detected.
 SHOOTING ONLY	
OFF	Image stabilization off. Choose this option when using a tripod.



+ MOTION has no effect when sensitivity is set to a fixed value, and may also be unavailable at some other combinations of settings. The effect may vary with lighting conditions and the speed at which the object is moving.

This option is available only with lenses that support image stabilization.

ISO

Adjust the camera's sensitivity to light.

Option	Description
AUTO1 AUTO2 AUTO3	Sensitivity is automatically adjusted in response to shooting conditions. Choose the base sensitivity, maximum sensitivity, and minimum shutter speed for AUTO1 , AUTO2 , and AUTO3 .
12800–200	Adjust sensitivity manually. Selected value is shown in display.
H (25600/51200), L (100/125/160)	Choose for special situations. Note that mottling may appear in pictures taken at H , while L reduces dynamic range.



Sensitivity is not reset when the camera is turned off.

Sensitivity cannot be adjusted when the auto mode selector lever is rotated to **AUTO**.

When **ON** is selected for  **BUTTON/DIAL SETTING** > **ISO COMMAND DIAL SETTING**, sensitivity can be adjusted by pressing the center of the front command to select sensitivity and then rotating the dial to choose a setting.

Adjusting Sensitivity

High values can be used to reduce blur when lighting is poor, while lower values allow slower shutter speeds or wider apertures in bright light; note, however, that mottling may appear in pictures taken at high sensitivities.

AUTO

Choose the base sensitivity, maximum sensitivity, and minimum shutter speed for **AUTO1**, **AUTO2**, and **AUTO3**. Defaults are shown below.

Item	Options	Default		
		AUTO1	AUTO2	AUTO3
DEFAULT SENSITIVITY	12800–200	200		
MAX. SENSITIVITY	12800–400	800	1600	3200
MIN. SHUTTER SPEED	$\frac{1}{500}$ – $\frac{1}{4}$ SEC, AUTO	$\frac{1}{60}$ SEC		

The camera automatically chooses a sensitivity between the default and maximum values; sensitivity is only raised above the default value if the shutter speed required for optimal exposure would be slower than the value selected for **MIN. SHUTTER SPEED**.



If the value selected for **DEFAULT SENSITIVITY** is higher than that selected for **MAX. SENSITIVITY**, **DEFAULT SENSITIVITY** will be set to the value selected for **MAX. SENSITIVITY**.

The camera may select shutter speeds slower than **MIN. SHUTTER SPEED** if pictures would still be underexposed at the value selected for **MAX. SENSITIVITY**. If **AUTO** is selected for **MIN. SHUTTER SPEED**, the camera will automatically choose a minimum shutter speed approximately equal to the inverse of the lens' focal length, in seconds (for example, if the lens has a focal length of 50 mm, the camera will choose a minimum shutter speed in the neighborhood of $\frac{1}{50}$ s). The minimum shutter speed is not affected by the option selected for image stabilization.

MOUNT ADAPTOR SETTING

Adjust settings for M-mount lenses connected using an optional FUJIFILM M MOUNT ADAPTER.

Choosing a Focal Length

If the lens has a focal length of 21, 24, 28, or 35 mm, choose a matching option in the **MOUNT ADAPTOR SETTING** menu.

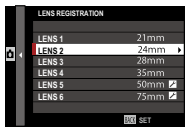

For other lenses, select **LENS 5** or **LENS 6** and use the focus stick (focus lever) to enter the focal length.

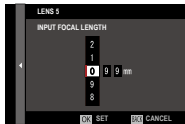

Distortion Correction

Choose from **STRONG**, **MEDIUM**, or **WEAK** options to correct **BARREL** or **PINCUSHION** distortion.

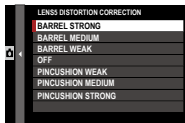

Color Shading Correction

Color (shading) variations between the center and edges of the frame can be adjusted separately for each corner.

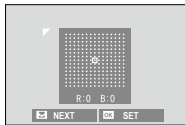

To use color shading correction, follow the steps below.

- 1 Rotate the rear command dial to choose a corner. The selected corner is indicated by a triangle.
- 2 Use the focus stick (focus lever) to adjust shading until there is no visible difference in color between the selected corner and the center of the image. Press the focus stick left or right to adjust colors on the cyan–red axis. Press the focus stick up or down to adjust colors on the blue–yellow axis.





To determine the amount required, adjust color shading correction while taking photos of blue sky or a sheet of gray paper.

Peripheral Illumination Correction

Choose from values between -5 and $+5$. Choosing positive values increases peripheral illumination, while choosing negative values reduces peripheral illumination.

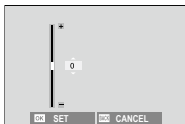
Positive values are recommended for vintage lenses, negative values to create the effect of images taken with an antique lens or a pinhole camera.



 To determine the amount required, adjust peripheral illumination correction while taking photos of blue sky or a sheet of gray paper.

WIRELESS COMMUNICATION

Connect to smartphones running the latest version of the FUJIFILM Camera Remote app. The smartphone can be used to browse the images on the camera, download selected images, control the camera remotely, or upload location data to the camera.

 For downloads and other information, visit:
http://app.fujifilm-dsc.com/en/camera_remote/

FLASH SETTING

Adjust flash-related settings.

To display flash-related settings, press **MENU/OK** in the shooting display and select the  (**FLASH SETTING**) tab.

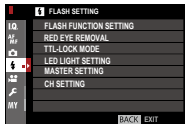

 The options available vary with the shooting mode selected.

FLASH FUNCTION SETTING

Choose a flash control mode, flash mode, or sync mode or adjust the flash level. The options available vary with the flash.



 See page 261 for more information.

RED EYE REMOVAL

Remove red-eye effects caused by the flash.

Option	Description
FLASH + REMOVAL	A red-eye reduction pre-flash is combined with digital red-eye removal.
FLASH	Flash red-eye reduction only.
REMOVAL	Digital red-eye removal only.
OFF	Flash red-eye reduction and digital red-eye removal off.



Flash red-eye reduction can be used in TTL flash control mode. Digital red-eye removal is performed only when a face is detected and is not available with RAW images.

TTL-LOCK MODE

Instead of adjusting flash level with each shot, TTL flash control can be locked for consistent results across a series of photographs.

Option	Description
LOCK WITH LAST FLASH	Flash output is locked at the value metered for the most recent photo. An error message will be displayed if no previously metered value exists.
LOCK WITH METERING FLASH	The camera emits a series of pre-flashes and locks flash output at the metered value.

 To use TTL lock, assign **TTL-LOCK** to a camera control and then use the control to enable or disable TTL lock ( 254).

Flash compensation can be adjusted while TTL lock is in effect.

LED LIGHT SETTING

Choose whether to use the flash unit's LED video light (if available) as a catchlight or AF-assist illuminator when taking photos.

Option	Role of LED video light in still photography
CATCHLIGHT	Catchlight
AF ASSIST	AF-assist illuminator
AF ASSIST + CATCHLIGHT	AF-assist illuminator and catchlight
OFF	None



This option can also be accessed via the flash settings menu.

MASTER SETTING

Choose a flash group (A, B, or C) for the flash mounted on the camera hot shoe when it functions as a master flash controlling remote flash units via FUJIFILM wireless optical flash control, or choose **OFF** to limit master flash output to a level that does not affect the final picture.

Options			
Gr A	Gr B	Gr C	OFF



This option can also be accessed via the flash settings menu.

CH SETTING

Choose the channel used for communication between the master flash and remote flash units when using FUJIFILM optical wireless flash control. Separate channels can be used for different flash systems or to prevent interference when multiple systems are operating in close proximity.

Options			
CH1	CH2	CH3	CH4



MOVIE SETTING

Adjust movie-recording options.



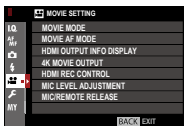













To display options for movie recording, press **MENU/OK** in the shooting display and select the  (**MOVIE SETTING**) tab.



The options available vary with the shooting mode selected.

MOVIE MODE

Choose a frame size and rate for movie recording.

Option	Frame size	Rate
 2160/29.97P	3840 × 2160 (4K)	29.97 fps
 2160/25P		25 fps
 2160/24P		24 fps
 2160/23.98P		23.98 fps
 1080/59.94P	1920 × 1080 (Full HD)	59.94 fps
 1080/50P		50 fps
 1080/29.97P		29.97 fps
 1080/25P		25 fps
 1080/24P		24 fps
 1080/23.98P		23.98 fps
 720/59.94P	1280 × 720 (HD)	59.94 fps
 720/50P		50 fps
 720/29.97P		29.97 fps
 720/25P		25 fps
 720/24P		24 fps
 720/23.98P		23.98 fps

MOVIE AF MODE

Choose how the camera selects the focus point for movie recording.

Option	Description
MULTI	Automatic focus-point selection.
AREA	The camera focuses on the subject in the selected focus area.

HDMI OUTPUT INFO DISPLAY

If **ON** is selected, HDMI devices to which the camera is connected will mirror the information in the camera display.

Options	
ON	OFF

4K MOVIE OUTPUT

Choose the destination for 4K movies shot while the camera is connected to an HDMI recorder or other device that supports 4K.

Option	Description
SD CARD	4K movies are recorded to a camera memory card in 4K and output to the HDMI device in Full HD.
HDMI	4K movies are output to the HDMI device in 4K, starting when the shutter button is pressed. The camera does not record 4K movies to a memory card.

HDMI REC CONTROL

Choose whether the camera sends movie start and stop signals to the HDMI device when the shutter button is pressed to start and stop movie recording.

Options	
ON	OFF

MIC LEVEL ADJUSTMENT

Adjust the recording level for the built-in and external microphones.

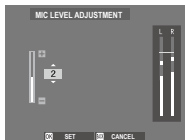

Option	Description
--------	-------------

4—1	Choose a recording level.
-----	---------------------------

 Displays shows the peak recording level detected in a given period.

You can assign **MIC LEVEL ADJUSTMENT** to a camera control and then using the control to adjust the microphone level during recording.

MIC/REMOTE RELEASE

Specify whether the device connected to the microphone/remote release connector is a microphone or a remote release.

Options	
 MIC	 REMOTE

Playback and the Playback Menu

7

The Playback Display

This section lists the indicators that may be displayed during playback.

! For illustrative purposes, displays are shown with all indicators lit.

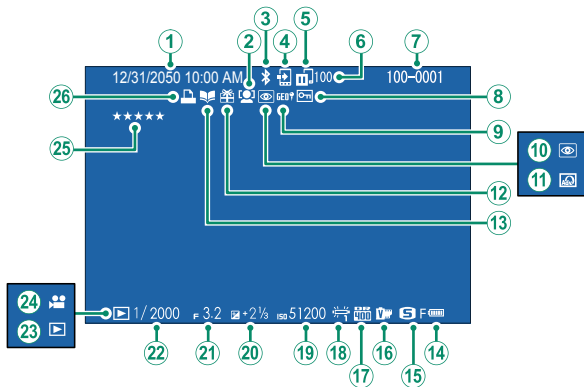

- | | |
|---|---------------------------------------|
| ① Date and time 44, 204 | ⑬ Photobook assist indicator..... 194 |
| ② Face detection indicator..... 139 | ⑭ Battery level 43 |
| ③ Bluetooth ON/OFF 241 | ⑮ Image size/quality 115, 116 |
| ④ Image transfer order..... 192 | ⑯ Film simulation..... 118 |
| ⑤ Image transfer status 192 | ⑰ Dynamic range..... 121 |
| ⑥ Number of frames selected for
upload 192 | ⑱ White balance..... 122 |
| ⑦ Frame number 237 | ⑲ Sensitivity..... 158 |
| ⑧ Protected image 188 | ⑳ Exposure compensation 91 |
| ⑨ Location data 243 | ㉑ Aperture 63, 69, 72 |
| ⑩ Red-eye removal indicator
..... 165, 190 | ㉒ Shutter speed..... 63, 64, 72 |
| ⑪ Advanced filter 99 | ㉓ Playback mode indicator..... 51 |
| ⑫ Gift image..... 51 | ㉔ Movie icon..... 58 |
| | ㉕ Rating 176 |
| | ㉖ DPOF print indicator 197 |

The DISP/BACK Button

The **DISP/BACK** button controls the display of indicators during playback.

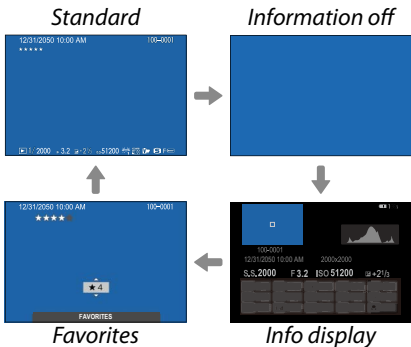

Favorites: Rating Pictures

To rate the current picture, press **DISP/BACK** and press the focus stick (focus lever) up and down to select from zero to five stars.

Viewing Photo Information

The photo information display changes each time the focus stick (focus lever) is pressed up.

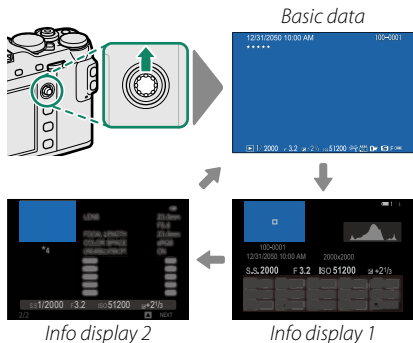

Zooming in on the Focus Point

Press the center of the rear command dial to zoom in on the focus point. Press again to return to full-frame playback.



Viewing Pictures

Read this section for information on playback zoom and multi-frame playback.

Use the rear command dial to go from full-frame playback to playback zoom or multi-frame playback.

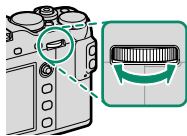

Full-frame playback



Multi-frame playback



Nine-frame view

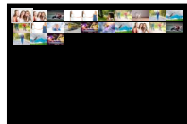

Hundred-frame view

Playback zoom

DISP/BACK MENU/OK ↑ ↓

Medium zoom



Maximum zoom



Playback Zoom

Rotate the rear command dial right to zoom in on the current picture, left to zoom out. To exit zoom, press **DISP/BACK, MENU/OK**, or the center of the rear command dial.

 The maximum zoom ratio varies with the option selected for **IQ IMAGE QUALITY SETTING > IMAGE SIZE**. Playback zoom is not available with cropped or resized copies saved at a size of **640**.

Scroll

When the picture is zoomed in, the focus stick (focus lever) can be used to view areas of the image not currently visible in the display.



Navigation window

Multi-Frame Playback

To change the number of images displayed, rotate the rear command dial left when a picture is displayed full frame.

 Use the focus stick (focus lever) to highlight images and press **MENU/OK** to view the highlighted image full frame. In the nine- and hundred-frame displays, press the focus stick up or down to view more pictures.



The Playback Menu

Adjust playback settings.

The playback menu is displayed when you press **MENU/OK** in playback mode.

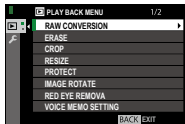



RAW CONVERSION

RAW pictures store information on camera settings separately from the data captured by the camera image sensor. Using **PLAY BACK MENU > RAW CONVERSION**, you can create JPEG copies of RAW pictures using different options for the settings listed on page 182. The original image data are unaffected, allowing a single RAW image to be processed in a multitude of different ways.

- 1 With a RAW picture displayed, press **MENU/OK** to display the playback menu.

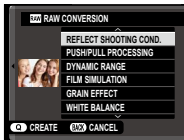
- 2 In the playback menu, highlight **RAW CONVERSION** and press **MENU/OK** to display settings.



 These options can also be displayed by pressing the **Q** button during playback.

- 3 Highlight a setting and press the focus stick (focus lever) right to display options. Press the focus stick up or down to highlight the desired option and press **MENU/OK** to select and return to the settings list. Repeat this step to adjust additional settings.
- 4 Press the **Q** button to preview the JPEG copy and press **MENU/OK** to save.

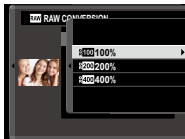

The settings that can be adjusted when converting pictures from RAW to JPEG are:

Setting	Description
REFLECT SHOOTING COND.	Create a JPEG copy using the settings in effect at the time the photo was taken.
PUSH/PULL PROCESSING	Adjust exposure.
DYNAMIC RANGE	Enhance details in highlights for natural contrast.
FILM SIMULATION GRAIN EFFECT	Simulate the effects of different types of film. Add a film grain effect.
WHITE BALANCE	Adjust white balance.
WB SHIFT	Fine-tune white balance.
HIGHLIGHT TONE	Adjust highlights.
SHADOW TONE	Adjust shadows.
COLOR	Adjust color density.
SHARPNESS	Sharpen or soften outlines.
NOISE REDUCTION	Process the copy to reduce mottling.
LENS MODULATION OPTIMIZER	Improve definition by adjusting for diffraction and the slight loss of focus at the periphery of the lens.
COLOR SPACE	Choose the color space used for color reproduction.

ERASE

Delete individual pictures, multiple selected pictures, or all pictures.

 Deleted pictures cannot be recovered. Protect important pictures or copy them to a computer or other storage device before proceeding.

Option	Description
FRAME	Delete pictures one at a time.
SELECTED FRAMES	Delete multiple selected pictures.
ALL FRAMES	Delete all unprotected pictures.

FRAME

- 1 Select **FRAME** for **ERASE** in the playback menu.
- 2 Press the focus stick (focus lever) left or right to scroll through pictures and press **MENU/OK** to delete (a confirmation dialog is not displayed). Repeat to delete additional pictures.

SELECTED FRAMES

- 1 Select **SELECTED FRAMES** for **ERASE** in the playback menu.
- 2 Highlight pictures and press **MENU/OK** to select or deselect (pictures in photobooks or printer orders are shown by **!**). Selected pictures are indicated by check marks (**✓**).
- 3 When the operation is complete, press **DISP/BACK** to display a confirmation dialog.
- 4 Highlight **OK** and press **MENU/OK** to delete the selected pictures.

ALL FRAMES

- 1 Select **ALL FRAMES** for **ERASE** in the playback menu.
- 2 A confirmation dialog will be displayed; highlight **OK** and press **MENU/OK** to delete all unprotected pictures.



Pressing **DISP/BACK** cancels deletion; note that any pictures deleted before the button was pressed cannot be recovered.

If a message appears stating that the selected images are part of a DPOF print order, press **MENU/OK** to delete the pictures.

CROP

Create a cropped copy of the current picture.

- 1 Display the desired picture.
- 2 Select **CROP** in the playback menu.
- 3 Use the rear command dial to zoom in and out and press the focus stick (focus lever) up, down, left, or right to scroll the picture until the desired portion is displayed.
- 4 Press **MENU/OK** to display a confirmation dialog.
- 5 Press **MENU/OK** again to save the cropped copy to a separate file.



Larger crops produce larger copies; all copies have an aspect ratio of 3:2. If the size of the final copy will be **640**, **YES** will be displayed in yellow.

RESIZE

Create a small copy of the current picture.

- 1 Display the desired picture.
- 2 Select **RESIZE** in the playback menu.
- 3 Highlight a size and press **MENU/OK** to display a confirmation dialog.
- 4 Press **MENU/OK** again to save the resized copy to a separate file.



The sizes available vary with the size of the original image.

PROTECT

Protect pictures from accidental deletion. Highlight one of the following options and press **MENU/OK**.

- **FRAME:** Protect selected pictures. Press the focus stick (focus lever) left or right to view pictures and press **MENU/OK** to select or deselect. Press **DISP/BACK** when the operation is complete.
- **SET ALL:** Protect all pictures.
- **RESET ALL:** Remove protection from all pictures.



Protected pictures will be deleted when the memory card is formatted.



Protecting images currently selected for upload to paired smartphones or tablets removes upload marking.

IMAGE ROTATE

Rotate pictures.

- 1 Display the desired picture.
- 2 Select **IMAGE ROTATE** in the playback menu.
- 3 Press the focus stick (focus lever) down to rotate the picture 90° clockwise, up to rotate it 90° counterclockwise.
- 4 Press **MENU/OK**. The picture will automatically be displayed in the selected orientation whenever it is played back on the camera.



Protected pictures cannot be rotated. Remove protection before rotating pictures.



The camera may not be able to rotate pictures created with other devices. Pictures rotated on the camera will not be rotated when viewed on a computer or on other cameras.

Pictures taken with **SCREEN SET-UP > AUTOROTATE PB** are automatically displayed in the correct orientation during playback.

RED EYE REMOVAL

Remove red-eye from portraits. The camera will analyze the image; if red-eye is detected, the image will be processed to create a copy with reduced red-eye.

- 1 Display the desired picture.
- 2 Select **RED EYE REMOVAL** in the playback menu.
- 3 Press **MENU/OK**.

 Results vary depending on the scene and the camera's success in detecting faces. Red eye cannot be removed from pictures that have already been processed using red-eye removal, which are indicated by a  icon during playback.

The amount of time needed to process the image varies with the number of faces detected.

Red eye removal cannot be performed on RAW images.

VOICE MEMO SETTING

Add a voice memo to the current photograph.

- 1 Select **ON** for **VOICE MEMO SETTING** in the playback menu.
- 2 Display a photo to which you wish to add a voice memo.
- 3 Press and hold the center of the front command dial to record the memo. Recording ends after 30 s or when you release the dial.



The new memo will be recorded over any existing memos. Deleting the picture also deletes the memo.

Voice memos cannot be added to movies or protected pictures.

Playing Voice Memos



Pictures with voice memos are indicated by  icons during playback. To play a memo, select the picture and press the center of the front command dial; a progress bar will be displayed while the memo plays back. Volume can be adjusted by pressing **MENU/OK** to pause playback and then pressing the focus stick (focus lever) up or down to adjust the volume. Press **MENU/OK** again to resume playback. Volume can also be adjusted using  **SOUND SET-UP > PLAYBACK VOLUME**.

IMAGE TRANSFER ORDER

Select photos for upload to a paired smartphone or tablet.

- 1 Select **IMAGE TRANSFER ORDER** in the playback menu.
- 2 Highlight photos and press **MENU/OK** to select or deselect. Repeat until all the desired photos have been selected.
- 3 Press **MENU/OK** to exit to playback.



If **ON** is selected for **CONNECTION SETTING** > **Bluetooth SETTINGS** > **AUTO IMAGE TRANSFER**, upload will begin shortly after you exit to playback or turn the camera off.



Image transfer orders can contain a maximum of 999 pictures.

Protected pictures, RAW images, “gift” pictures, and movies cannot be selected for upload.

You can also mark images for upload by pressing the **AF-L** button.

WIRELESS COMMUNICATION

Connect to smartphones running the latest version of the FUJIFILM Camera Remote app. The smartphone can be used to browse the images on the camera, download selected images, control the camera remotely, or upload location data to the camera.



For downloads and other information, visit:
http://app.fujifilm-dsc.com/en/camera_remote/

SLIDE SHOW

View pictures in an automated slide show. Press **MENU/OK** to start and press the focus stick (focus lever) right or left to skip ahead or back. Press **DISP/BACK** at any time during the show to view on-screen help. The show can be ended at any time by pressing **MENU/OK**.



The camera will not turn off automatically while a slide show is in progress.

PHOTOBOOK ASSIST

Create books from your favorite photos.

Creating a Photobook

- 1 Select **NEW BOOK** for  **PLAY BACK MENU > PHOTOBOOK ASSIST**.
- 2 Scroll through the images and press the focus stick (focus lever) up to select or deselect. Press **MENU/OK** to exit when the book is complete.



Neither photographs **640** or smaller nor movies can be selected for photobooks.

The first picture selected becomes the cover image. Press the focus stick down to select the current image for the cover instead.

- 3 Highlight **COMPLETE PHOTOBOOK** and press **MENU/OK** (to select all photos for the book, choose **SELECT ALL**). The new book will be added to the list in the photobook assist menu.



Books can contain up to 300 pictures. Books that contain no photos are automatically deleted.

Photobooks

Photobooks can be copied to a computer using MyFinePix Studio software.

Viewing Photobooks

Highlight a book in the photobook assist menu and press **MENU/OK** to display the book, then press the focus stick (focus lever) left or right to scroll through the pictures.

Editing and Deleting Photobooks

Display the photobook and press **MENU/OK**. The following options will be displayed; select the desired option and follow the on-screen instructions.

- **EDIT**: Edit the book as described in “Creating a Photobook”.
- **ERASE**: Delete the book.

PC AUTO SAVE

Upload pictures from the camera to a computer running the latest version of FUJIFILM PC AutoSave (note that you must first install the software and configure the computer as a destination for images copied from the camera).



For downloads and other information, visit:
http://app.fujifilm-dsc.com/en/pc_autosave/

PRINT ORDER (DPOF)

Create a digital “print order” for DPOF-compatible printers.

- 1 Select **PLAY BACK MENU > PRINT ORDER (DPOF)**.
- 2 Select **WITH DATE** to print the date of recording on pictures, **WITHOUT DATE** to print pictures without dates, or **RESET ALL** to remove all pictures from the print order before proceeding.
- 3 Display a picture you wish to include in or remove from the print order.
- 4 Press the focus stick (focus lever) up or down to choose the number of copies (up to 99). To remove a picture from the order, press the focus stick down until the number of copies is 0.

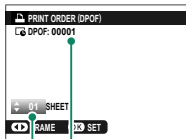

Total number of prints of prints
Number of copies

- 5 Repeat steps 3–4 to complete the print order.
- 6 The total number of prints is displayed in the monitor. Press **MENU/OK** to exit.



The pictures in the current print order are indicated by a  icon during playback.

Print orders can contain a maximum of 999 pictures.

If a memory card is inserted containing a print order created by another camera, you will need to delete the order before creating as described above.

instax PRINTER PRINT

To print pictures to optional FUJIFILM instax SHARE printers, first select **CONNECTION SETTING** > **instax PRINTER CONNECTION SETTING** and enter the instax SHARE printer name (SSID) and password, then follow the steps below.

- 1 Turn the printer on.
- 2 Select **PLAY BACK MENU** > **instax PRINTER PRINT**. The camera will connect to the printer.



 To print a frame from a burst sequence, display the frame before selecting **instax PRINTER PRINT**.

- 3 Use the focus stick (focus lever) to display the picture you want to print, then press **MENU/OK**. The picture will be sent to the printer and printing will start.





 Pictures taken with other cameras cannot be printed.
The area printed is smaller than the area visible in the LCD monitor.

DISP ASPECT

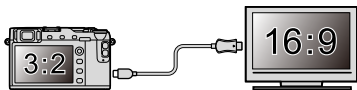
Choose how High Definition (HD) devices display pictures with an aspect ratio of 3:2 (this option is available only when an HDMI cable is connected). Select 16:9 to display the image so that it fills the screen with its top and bottom cropped out, 3:2 to display the entire image with black bands at either side.



		Option	
		16:9	3:2
Display			

The Setup Menus

8



USER SETTING

Adjust basic camera settings.

To access basic camera settings, press **MENU/OK**, select the **SET UP** tab, and choose **USER SETTING**.

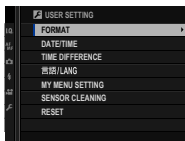

FORMAT

To format a memory card:

- 1 Select **USER SETTING > FORMAT** in the **(SET UP)** tab.
- 2 A confirmation dialog will be displayed. To format the memory card, highlight **OK** and press **MENU/OK**. To exit without formatting the memory card, select **CANCEL** or press **DISP/BACK**.

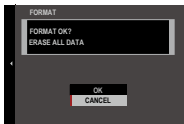



! All data—including protected pictures—will be deleted from the memory card. Be sure important files have been copied to a computer or other storage device.

Do not open the battery-chamber cover during formatting.

📷 The format menu can also be displayed by pressing the center of the rear command dial while pressing and holding the **🗑️** button.

DATE/TIME

To set the camera clock:

- 1 Select  **USER SETTING** > **DATE/TIME** in the  (**SET UP**) tab.
- 2 Press the focus stick (focus lever) left or right to highlight the year, month, day, hour, or minute and press up or down to change. To change the order in which the year, month, and day are displayed, highlight the date format and press the focus stick up or down.
- 3 Press **MENU/OK** to set the clock.

TIME DIFFERENCE

Switch the camera clock instantly from your home time zone to the local time at your destination when traveling. To specify the difference between your local and home time zone:

- 1 Highlight **← LOCAL** and press **MENU/OK**.
- 2 Use the focus stick (focus lever) to choose the time difference between local time and your home time zone. Press **MENU/OK** when settings are complete.

To set the camera clock to local time, highlight **← LOCAL** and press **MENU/OK**. To set the clock to the time in your home time zone, select **🏠 HOME**. If **← LOCAL** is selected, **←** will be displayed in yellow for about three seconds when the camera is turned on.

Options	
← LOCAL	🏠 HOME

言語/LANG.

Choose a language.

MY MENU SETTING

Edit the items listed in the **MY** (MY MENU) tab, a personalized custom menu of frequently-used options.

- 1 Highlight **USERSETTING > MY MENU SETTING** in the **(SET UP)** tab and press **MENU/OK** to display the options at right.

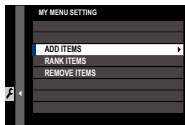

- Press the focus stick (focus lever) up or down to highlight **ADD ITEMS** and press **MENU/OK**. Options that can be added to “my menu” are highlighted in blue.

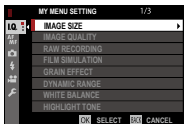

 Items currently in “my menu” are indicated by check marks.

- Highlight an item and press **MENU/OK** to add it to “my menu”.

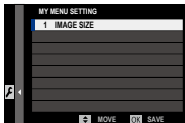

- Press **MENU/OK** to return to the edit display.
- Repeat Steps 3 and 4 until all the desired items have been added.

 “My menu” can contain up to 16 items.

Editing “My Menu”

To reorder or delete items, select **RANK ITEMS** or **REMOVE ITEMS** in Step 1.

SENSOR CLEANING

Remove dust from the camera image sensor.

- **OK:** Clean the sensor immediately.
- **WHEN SWITCHED ON:** Sensor cleaning will be performed when the camera is turned on.
- **WHEN SWITCHED OFF:** Sensor cleaning will be performed when the camera turns off (sensor cleaning is not however performed if the camera turns off in playback mode).



Dust that cannot be removed using sensor cleaning can be removed manually.

RESET

Reset shooting or setup menu options to default values. Custom white balance, custom settings banks created using **EDIT/SAVE CUSTOM SETTING**, **WIRELESS SETTINGS**, and the setup menu **DATE/TIME** and **TIME DIFFERENCE** options are not affected.

- 1 Highlight the desired option and press **MENU/OK**.
- 2 A confirmation dialog will be displayed; highlight **OK** and press **MENU/OK**.



SOUND SETTING

Make changes to camera sounds.

To access sound settings, press **MENU/OK**, select the  (**SET UP**) tab, and choose **SOUND SET-UP**.

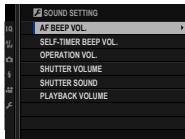

AF BEEP VOL.

Choose the volume of the beep that sounds when the camera focuses. The beep can be muted by selecting  **OFF**.

Options

 (high)

 (medium)

 (low)

 **OFF** (mute)

SELF-TIMER BEEP VOL.

Choose the volume of the beep that sounds while the self-timer is active. The beep can be muted by selecting OFF.

Options

 (high) (medium) (low)OFF (mute)

OPERATION VOL.

Adjust the volume of the sounds produced when camera controls are operated. Choose OFF to disable control sounds.

Options

 (high) (medium) (low)OFF (mute)

SHUTTER VOLUME

Adjust the volume of the sounds produced by the electronic shutter. Choose  OFF to disable the shutter sound.

Options

 (high) (medium) (low) OFF (mute)

SHUTTER SOUND

Choose the sound made by the electronic shutter.

Options

 1 SOUND 1 2 SOUND 2 3 SOUND 3

PLAYBACK VOLUME

Adjust the volume for movie playback. Choose from 10 options between 10 (high) and 1 (low) or select 0 to mute audio during movie playback.

Options										
10	9	8	7	6	5	4	3	2	1	0



SCREEN SETTING

Make changes to display settings.

To access display settings, press **MENU/OK**, select the **SET UP** tab, and choose **SCREEN SET-UP**.

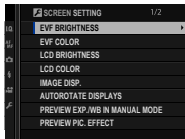

EVF BRIGHTNESS

Adjust the brightness of the display in the electronic viewfinder. Select **MANUAL** to choose from 13 options from +5 (bright) to -7 (dark), or select **AUTO** for automatic brightness adjustment.

Options

MANUAL

AUTO

EVF COLOR

Adjust the hue of the display in the electronic viewfinder. Choose from 11 options between +5 and -5.

Options										
+5	+4	+3	+2	+1	0	-1	-2	-3	-4	-5

LCD BRIGHTNESS

Adjust monitor brightness. Choose from 11 options between +5 and -5.

Options										
+5	+4	+3	+2	+1	0	-1	-2	-3	-4	-5

LCD COLOR

Adjust monitor hue. Choose from 11 options between +5 and -5.

Options										
+5	+4	+3	+2	+1	0	-1	-2	-3	-4	-5

IMAGE DISP.

Choose how long images are displayed after shooting. Colors may differ slightly from those in the final image and “noise” mottling may be visible at high sensitivities.

Option	Description
CONTINUOUS	Pictures are displayed until the MENU/OK button is pressed or the shutter button is pressed halfway. To zoom in on the active focus point, press the center of the rear command dial; press again to cancel zoom.
1.5 SEC	Pictures are displayed for the selected time or until the shutter button is pressed halfway.
0.5 SEC	
OFF	Pictures are not displayed after shooting.

AUTOROTATE DISPLAYS

Choose whether the indicators in the viewfinder and LCD monitor rotate to match camera orientation.

Options		
ON		OFF

PREVIEW EXP./WB IN MANUAL MODE

Select **PREVIEW EXP./WB** to enable exposure and white balance preview in manual exposure mode, or choose **PREVIEW WB** to preview only white balance (**PREVIEW WB** is recommended in situations in which exposure and white balance are likely to change during shooting, as may be the case when you use a flash with an incandescent monitoring lamp). Select **OFF** when using a flash or on other occasions on which exposure may change when the picture is taken.

Options		
PREVIEW EXP./WB	PREVIEW WB	OFF

PREVIEW PIC. EFFECT

Choose **ON** to preview the effects of film simulation, white balance, and other settings in the monitor, **OFF** to make shadows in low-contrast, back-lit scenes and other hard-to-see subjects more visible.

Options

ON







OFF



If **OFF** is selected, the effects of camera settings will not be visible in the monitor and colors and tone will differ from those in the final picture. The display will however be adjusted to show the effects of advanced filters and of monochrome and sepia settings.

FRAMING GUIDELINE

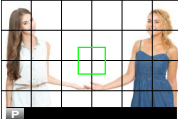
Choose a framing grid for shooting mode.

		Option		
		 GRID 9	 GRID 24	 HD FRAMING
Display				
	For "rule of thirds" composition.	A six-by-four grid.	Frame HD pictures in the crop shown by the lines at the top and bottom of the display.	



Framing guides are not shown at default settings but can be displayed using **SCREEN SET-UP > DISP. CUSTOM SETTING** ( 221).

AUTOROTATE PB

Choose **ON** to automatically rotate “tall” (portrait-orientation) pictures during playback.

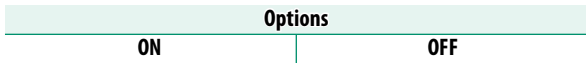

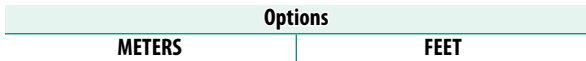

FOCUS SCALE UNITS

Choose the units used for the focus distance indicator.



DISP. CUSTOM SETTING

Choose the items shown in the standard display.

- 1 In shooting mode, use the **DISP/BACK** button to display standard indicators.
- 2 Press **MENU/OK** and select  **SCREEN SET-UP** > **DISP. CUSTOM SETTING** in the  (**SET UP**) tab.
- 3 Highlight items and press **MENU/OK** to select or deselect.

Item	Default	Item	Default
FRAMING GUIDELINE	<input type="checkbox"/>	SHUTTER TYPE	<input checked="" type="checkbox"/>
ELECTRONIC LEVEL	<input type="checkbox"/>	FLASH	<input checked="" type="checkbox"/>
FOCUS FRAME	<input checked="" type="checkbox"/>	CONTINUOUS MODE	<input checked="" type="checkbox"/>
AF DISTANCE INDICATOR	<input type="checkbox"/>	DUAL IS MODE	<input checked="" type="checkbox"/>
MF DISTANCE INDICATOR	<input checked="" type="checkbox"/>	TOUCH SCREEN MODE	<input checked="" type="checkbox"/>
HISTOGRAM	<input type="checkbox"/>	WHITE BALANCE	<input checked="" type="checkbox"/>
LIVE VIEW HIGHLIGHT ALERT	<input type="checkbox"/>	FILM SIMULATION	<input checked="" type="checkbox"/>
SHOOTING MODE	<input checked="" type="checkbox"/>	DYNAMIC RANGE	<input checked="" type="checkbox"/>
APERTURE/S-SPEED/ISO	<input checked="" type="checkbox"/>	FRAMES REMAINING	<input checked="" type="checkbox"/>
INFORMATION BACKGROUND	<input checked="" type="checkbox"/>	IMAGE SIZE/QUALITY	<input checked="" type="checkbox"/>
Expo. Comp. (Digit)	<input type="checkbox"/>	MOVIE MODE & REC. TIME	<input checked="" type="checkbox"/>
Expo. Comp. (Scale)	<input checked="" type="checkbox"/>	IMAGE TRANSFER ORDER	<input checked="" type="checkbox"/>
FOCUS MODE	<input checked="" type="checkbox"/>	BATTERY LEVEL	<input checked="" type="checkbox"/>
PHOTOMETRY	<input checked="" type="checkbox"/>	FRAMING OUTLINE	<input type="checkbox"/>

- 4 Press **DISP/BACK** to save changes.
- 5 Press **DISP/BACK** as needed to exit the menus and return to the shooting display.



Some indicators are not displayed in all modes.



BUTTON/DIAL SETTING

Access options for camera controls.

To access control options, press **MENU/OK**, select the  (**SET UP**) tab, and choose **BUTTON/DIAL SETTING**.

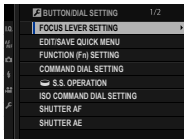

FOCUS LEVER SETTING

Choose the functions performed by the focus stick (focus lever).

Option	Description
LOCK (OFF)	The focus stick cannot be used during shooting.
PUSH  TO UNLOCK	Press the stick to view the focus-point display and tilt the stick to select a focus point.
ON	Tilt the stick to view the focus-point display and select a focus point.

EDIT/SAVE QUICK MENU

Choose the items displayed in the quick menu.

- 1 Select **FUNCTION** **BUTTON/DIAL SETTING** > **EDIT/SAVE QUICK MENU** in the **FUNCTION** (**SET UP**) tab.
- 2 The current quick menu will be displayed; use the focus stick (focus lever) to highlight the item you wish to change and press **MENU/OK**.
- 3 Highlight any of the following options and press **MENU/OK** to assign it to the selected position.

- IMAGE SIZE
- IMAGE QUALITY
- FILM SIMULATION*
- GRAIN EFFECT*
- DYNAMIC RANGE*
- WHITE BALANCE*
- HIGHLIGHT TONE*
- SHADOW TONE*
- COLOR*
- SHARPNESS*
- NOISE REDUCTION*
- SELECT CUSTOM SETTING*
- AF MODE
- AF-C CUSTOM SETTINGS
- FACE/EYE DETECTION SETTING
- MF ASSIST
- TOUCH SCREEN MODE
- SELF-TIMER
- PHOTOMETRY
- SHUTTER TYPE
- ISO
- FLASH FUNCTION SETTING
- FLASH COMPENSATION
- MOVIE MODE
- MIC LEVEL ADJUSTMENT
- EVF/LCD BRIGHTNESS
- EVF/LCD COLOR
- NONE

* Stored in custom settings bank.

 Select **NONE** to assign no option to the selected position. When **SELECT CUSTOM SETTING** is selected, current settings are shown in the quick menu by the label **BASE**.

4 Highlight the desired item and press **MENU/OK** to assign it to the selected position.

 The quick menu can also be accessed in shooting mode by holding the **Q** button.

FUNCTION (Fn) SETTING

Choose the roles played by the function buttons.

1 Select **FUNCTION/DIAL SETTING > FUNCTION (Fn) SETTING** in the **(SET UP)** tab.

2 Highlight the desired control and press **MENU/OK**.

3 Highlight any of the following options and press **MENU/OK** to assign it to the selected control.

- IMAGE SIZE
- IMAGE QUALITY
- RAW
- FILM SIMULATION
- GRAIN EFFECT
- DYNAMIC RANGE
- WHITE BALANCE
- SELECT CUSTOM SETTING
- FOCUS AREA
- FOCUS CHECK
- AF MODE
- AF-C CUSTOM SETTINGS
- FACE/EYE DETECTION SETTING
- SELF-TIMER
- AE BKT SETTING
- PHOTOMETRY
- SHUTTER TYPE
- ISO
- WIRELESS COMMUNICATION
- FLASH FUNCTION SETTING
- TTL-LOCK
- MODELING FLASH
- MIC LEVEL ADJUSTMENT
- PREVIEW DEPTH OF FIELD
- PREVIEWEXP/WBINMANUALMODE
- PREVIEW PIC. EFFECT
- HISTOGRAM
- AE LOCK ONLY
- AF LOCK ONLY
- AE/AF LOCK
- AF-ON
- APERTURE SETTING
- AUTO IMAGE TRANSFER
- Bluetooth ON/OFF
- PLAYBACK
- NONE (control disabled)



Function button assignment options can also be accessed by holding the **DISP/BACK** button.

AE LOCK ONLY, **AF LOCK ONLY**, **AE/AF LOCK**, and **AF-ON** cannot be assigned to the touch function buttons (**T-Fn1** through **T-Fn4**).

AF-ON

If **AF-ON** is selected, you can press the control instead of keeping the shutter button pressed halfway.

MODELING FLASH

If **MODELING FLASH** is selected when a compatible shoe-mounted flash unit is attached, you can press the control to test-fire the flash and check for shadows and the like (modeling flash).

TTL-LOCK

If **TTL-LOCK** is selected, you can press the control to lock flash output according to the option selected for **⚡ FLASH SETTING > TTL-LOCK MODE** (📖 166).

COMMAND DIAL SETTING

Choose the roles played by the command dials.

Option	Description
☺ F ☹ S.S.	The front command dial controls aperture, the rear command dial shutter speed.
☹ S.S. ☺ F	The front command dial controls shutter speed, the rear command dial aperture.

☺ S.S. OPERATION

Select **OFF** to disable shutter-speed fine-tuning using the command dials.

Options	
ON	OFF

ISO COMMAND DIAL SETTING

Select **ON** to allow sensitivity to be adjusted using the front command dial.

Options	
ON	OFF

 The sensitivity selected with the command dial is reflected in the setting chosen for  **SHOOTING SETTING > ISO**.

SHUTTER AF

Choose whether the camera focuses when the shutter button is pressed halfway.

Option	Description
AF-S	<ul style="list-style-type: none"> • ON: Focus locks when the shutter button is pressed halfway. • OFF: No focus operation is performed when the shutter button is pressed halfway.
AF-C	<ul style="list-style-type: none"> • ON: The camera focuses while the shutter button is pressed halfway. • OFF: No focus operation is performed when the shutter button is pressed halfway.

SHUTTER AE

If **ON** is selected, exposure will lock while the shutter button is pressed halfway.

Option	Description
AF-S/MF	<ul style="list-style-type: none"> • ON: Exposure locks when the shutter button is pressed halfway. • OFF: Exposure does not lock when the shutter button is pressed halfway.
AF-C	<ul style="list-style-type: none"> • ON: Exposure locks while the shutter button is pressed halfway. • OFF: Exposure does not lock when the shutter button is pressed halfway.



Select **OFF** to allow the camera to adjust exposure before each shot taken in burst mode.

SHOOT WITHOUT LENS

Choose **ON** to enable the shutter release when no lens is attached.

Options	
ON	OFF

SHOOT WITHOUT CARD

Choose whether the shutter can be released without a memory card inserted in the camera.

Option	Description
ON	When no memory card is inserted, the shutter can be released to test camera function and the shooting and setup menus can be displayed.
OFF	The shutter is disabled if no memory card is inserted, preventing accidental loss of pictures taken without a memory card.

FOCUS RING

Choose the direction in which the focus ring is rotated to increase the focus distance.

Options	
 CW (clockwise)	 CCW (counterclockwise)

AE/AF-LOCK MODE

If **AE & AF ON WHEN PRESSING** is selected, exposure and/or focus will lock while the **AE-L** or **AF-L** button is pressed. If **AE & AF ON/OFF SWITCH** is selected, exposure and/or focus will lock when the **AE-L** or **AF-L** button is pressed and remain locked until the button is pressed again.

Options

AE & AF ON WHEN PRESSING

AE & AF ON/OFF SWITCH

APERTURE SETTING

Choose the method used to adjust aperture when using lenses with no aperture rings.

Option	Description
AUTO +  MANUAL	Rotate the front command dial to choose the aperture. Rotate past minimum aperture to choose A (auto).
AUTO	Aperture is selected automatically; camera functions in exposure mode P (program AE) or S (shutter-priority AE).
MANUAL	Rotate the front command dial to choose the aperture; camera functions in exposure mode A (aperture-priority AE) or M (manual).

TOUCH SCREEN SETTING

Enable or disable touch-screen controls.

Option	Description
TOUCH SCREEN ON/OFF	<ul style="list-style-type: none"> • ON: Touch controls enabled; the LCD monitor functions as a touch screen. • OFF: Touch controls disabled; the LCD monitor cannot be used as a touch screen.
EVF TOUCH SCREEN AREA SETTINGS	<p>Select the area of the LCD monitor (ALL, RIGHT, or LEFT) used for touch controls while the viewfinder is active, or choose OFF to disable touch controls while the viewfinder is in use.</p>



POWER MANAGEMENT

Adjust power management settings.

To access power management settings, press **MENU/OK**, select the  (**SET UP**) tab, and choose **POWER MANAGEMENT**.

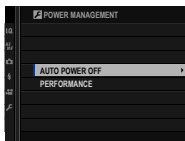

AUTO POWER OFF

Choose the length of time before the camera turns off automatically when no operations are performed. Shorter times increase battery life; if **OFF** is selected, the camera must be turned off manually.

Options

5 MIN**2 MIN****1 MIN****30 SEC****15 SEC****OFF**

PERFORMANCE

Adjust power management settings.

Option	AF performance (speed)	LCD/EVF display quality	Battery endurance
HIGH PERFORMANCE	Fast	Very high	Low
STANDARD	Normal	High	Normal



When **STANDARD** is selected, the frame rate will drop when no operations are being performed. Operating camera controls returns the frame rate to normal.



SAVE DATA SETTING

Make changes to file management settings.

To access file management settings, press **MENU/OK**, select the  (**SET UP**) tab, and choose **SAVE DATA SET-UP**.

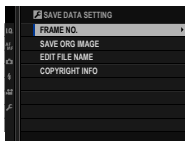

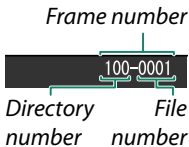

FRAME NO.

New pictures are stored in image files named using a four-digit file number assigned by adding one to the last file number used. The file number is displayed during playback as shown. **FRAME NO.** controls whether file numbering is reset to 0001 when a new memory card is inserted or the current memory card is formatted.



Option	Description
CONTINUOUS	Numbering continues from the last file number used or the first available file number, whichever is higher. Choose this option to reduce the number of pictures with duplicate file names.
RENEW	Numbering is reset to 0001 after formatting or when a new memory card is inserted.

 If the frame number reaches 999-9999, the shutter release will be disabled. Format the memory card after transferring to a computer any pictures you wish to keep.

Selecting  **USER SETTING > RESET** sets **FRAME NO.** to **CONTINUOUS** but does not reset the file number.

Frame numbers for pictures taken with other cameras may differ.

SAVE ORG IMAGE

Choose **ON** to save unprocessed copies of pictures taken using **RED EYE REMOVAL**.

Options	
ON	OFF

EDIT FILE NAME

Change the file name prefix. sRGB images use a four-letter prefix (default “DSCF”), Adobe RGB images a three-letter prefix (“DSF”) preceded by an underscore.

Option	Default prefix	Sample file name
sRGB	DSCF	ABCD0001
AdobeRGB	_DSF	_ABC0001

COPYRIGHT INFO

Copyright information, in the form of Exif tags, can be added to new images as they are taken. Changes to copyright information are reflected only in images taken after the changes are made.

Option	Description
DISP COPYRIGHT INFO	View the current copyright information.
ENTER AUTHOR'S INFO	Enter the creator's name.
ENTER COPYRIGHT INFO	Enter the name of the copyright holder.
DELETE COPYRIGHT INFO	Delete the current copyright information. This change applies only to images taken after this option is selected; copyright information recorded with existing images is not affected.



CONNECTION SETTING

Adjust settings for connection to other devices.

To access connection settings, press **MENU/OK**, select the  (**SET UP**) tab, and choose **CONNECTION SETTING**.

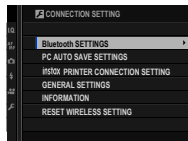

For more information on wireless connections, visit:
<http://fujifilm-dsc.com/wifi/>

Bluetooth SETTINGS

Adjust Bluetooth settings.

Option	Description
PAIRING REGISTRATION	To pair the camera with a smartphone or tablet, select this option, then launch FUJIFILM Camera Remote on the smart device and tap PAIRING REGISTRATION .
DELETE PAIRING REG.	End pairing.
Bluetooth ON/OFF	<ul style="list-style-type: none"> • ON: The camera automatically establishes a Bluetooth connection with paired devices when turned on. • OFF: The camera does not connect via Bluetooth.
AUTO IMAGE TRANSFER	<ul style="list-style-type: none"> • ON: Mark photos for upload as they are taken. • OFF: Photos are not marked for upload as they are taken, but JPEG images can be selected for upload using the IMAGE TRANSFER ORDER option in the playback menu.



Install the latest version of the FUJIFILM Camera Remote app on your smartphone or tablet before pairing the device with your camera or uploading images.

When **ON** is selected for both **Bluetooth ON/OFF** and **AUTO IMAGE TRANSFER**, upload to paired devices will begin shortly after you exit to playback or turn the camera off.

PC AUTO SAVE SETTINGS

Adjust settings for connection to computers via wireless LAN.

Option	Description
PC AUTO SAVE SETTING	<p>Choose the method used for connection to computers via a wireless LAN.</p> <ul style="list-style-type: none"> • SIMPLE SETUP: Connect using WPS. • MANUAL SETUP: Choose the network from a list (SELECT FROM NETWORK LIST) or enter the name manually (ENTER SSID).
DELETE REGISTERED DESTINATION PC	Remove selected destinations.
DETAILS OF PREVIOUS CONNECTION	View computers to which the camera has recently connected.

instax PRINTER CONNECTION SETTING

Adjust settings for connection to optional FUJIFILM instax SHARE printers.

The Printer Name (SSID) and Password

The printer name (SSID) can be found on the bottom of the printer; the default password is "1111". If you have already chosen a different password to print from a smartphone, enter that password instead.

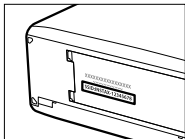

GENERAL SETTINGS

Adjust settings for connection to wireless networks.

Option	Description
NAME	Choose a name (NAME) to identify the camera on the wireless network (the camera is assigned a unique name by default).
RESIZE IMAGE FOR SMARTPHONE 3M	Choose ON (the default setting, recommended in most circumstances) to resize larger images to 3M for upload to smartphones, OFF to upload images at their original size. Resizing applies only to the copy uploaded to the smartphone; the original is not affected.
GEOTAGGING	Choose whether location data downloaded from a smartphone are embedded in pictures as they are taken.
LOCATION INFO	Display the location data last downloaded from a smartphone.

INFORMATION

View the camera's MAC and Bluetooth address.

RESET WIRELESS SETTING

Restore wireless settings to their default values.

Shortcuts

9

Shortcut Options

Customize camera controls to suit your style or situation.

Frequently-used options can be added to the **Q** menu or a custom “my” menu or assigned to an **Fn** (function) button for direct access:

- **The Q menu** (📖 247): The **Q** menu is displayed by pressing the **Q** button. Use the **Q** menu to view or change the options selected for frequently-used menu items.
- **“My menu”** (📖 256): Add frequently-used options to this custom menu, which can be viewed by pressing **MENU/OK** and selecting the **MY** (“MY MENU”) tab.
- **The function buttons** (📖 252): Use the function buttons for direct access to selected features.

The Q (Quick Menu) Button

Press **Q** for quick access to selected options.

The Quick Menu Display

At default settings, the quick menu contains the following items:

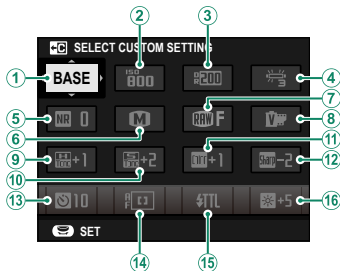

- | | |
|-------------------------|--------------------------|
| ① SELECT CUSTOM SETTING | ⑨ HIGHLIGHT TONE |
| ② ISO | ⑩ SHADOW TONE |
| ③ DYNAMIC RANGE | ⑪ COLOR |
| ④ WHITE BALANCE | ⑫ SHARPNESS |
| ⑤ NOISE REDUCTION | ⑬ SELF-TIMER |
| ⑥ IMAGE SIZE | ⑭ AF MODE |
| ⑦ IMAGE QUALITY | ⑮ FLASH FUNCTION SETTING |
| ⑧ FILM SIMULATION | ⑯ EVF/LCD BRIGHTNESS |

The quick menu shows the options currently selected for items ②–⑯, which can be changed as described on page 250.

SELECT CUSTOM SETTING

The **IQ IMAGE QUALITY SETTING > SELECT CUSTOM SETTING** item (item ①) shows the current custom settings bank:

- **BASE**: No custom settings bank selected.
- **C1–C7**: Select a bank to view the settings saved using the **IQ IMAGE QUALITY SETTING > EDIT/SAVE CUSTOM SETTING** option.
- ~~BASE~~ **C1–C7**: The current custom settings bank.

Viewing and Changing Settings

- 1 Press **Q** to display the quick menu during shooting.

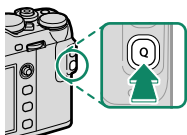

- 2 Use the focus stick (focus lever) to highlight items and rotate the rear command dial to change.



Changes are not saved to the current settings bank. Settings that differ from those in the current settings bank (**C1–C7**) are shown in red.

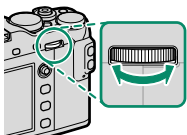

- 3 Press **Q** to exit when settings are complete.

Editing the Quick Menu

To choose the items displayed in the quick menu:

- 1 Press and hold the **Q** button during shooting.

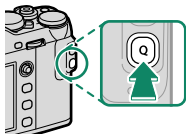

- 2 The current quick menu will be displayed; use the focus stick (focus lever) to highlight the item you wish to change and press **MENU/OK**.

3 Highlight any of the following options and press **MENU/OK** to assign it to the selected position.

- IMAGE SIZE
- IMAGE QUALITY
- FILM SIMULATION*
- GRAIN EFFECT*
- DYNAMIC RANGE*
- WHITE BALANCE*
- HIGHLIGHT TONE*
- SHADOW TONE*
- COLOR*
- SHARPNESS*
- NOISE REDUCTION*
- SELECT CUSTOM SETTING*
- AF MODE
- AF-C CUSTOM SETTINGS
- FACE/EYE DETECTION SETTING
- MF ASSIST
- TOUCH SCREEN MODE
- SELF-TIMER
- PHOTOMETRY
- SHUTTER TYPE
- ISO
- FLASH FUNCTION SETTING
- FLASH COMPENSATION
- MOVIE MODE
- MIC LEVEL ADJUSTMENT
- EVF/LCD BRIGHTNESS
- EVF/LCD COLOR
- NONE

* Stored in custom settings bank.



Select **NONE** to assign no option to the selected position. When **SELECT CUSTOM SETTING** is selected, current settings are shown in the quick menu by the label **BASE**.



The quick menu can also be edited using **FUNCTION BUTTON/DIAL SETTING > EDIT/SAVE QUICK MENU**.

The Fn (Function) Buttons

The roles played by each of the function buttons can be selected by pressing and holding the button.

The functions assigned to **T-Fn1** through **T-Fn4** can be accessed by flicking the monitor.

The default assignments are:

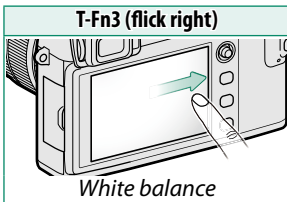
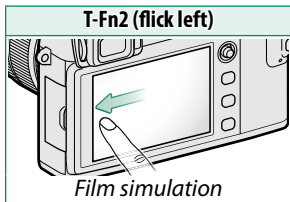
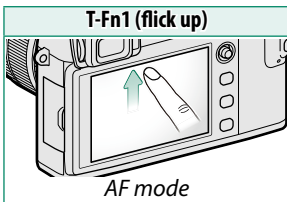
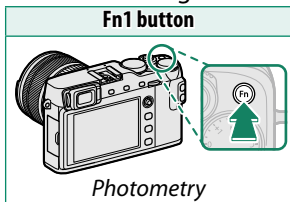

T-Fn4 (flick down)

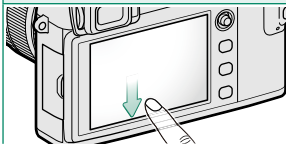

Sensitivity

AE-L button

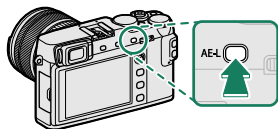

Exposure lock

AF-L button

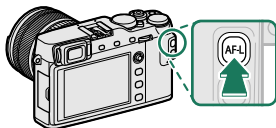

Focus lock

Center of rear command dial

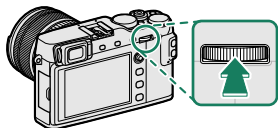

Focus check

Assigning Roles to the Function Buttons

To assign roles to the buttons:

- 1 Press and hold the **DISP/BACK** button until a button selection menu is displayed.

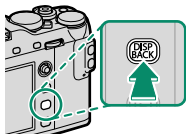

- 2 Highlight a button and press **MENU/OK**.
- 3 Highlight the desired role and press **MENU/OK** to assign it to the selected button. Choose from:

- IMAGE SIZE
- IMAGE QUALITY
- RAW
- FILM SIMULATION
- GRAIN EFFECT
- DYNAMIC RANGE
- WHITE BALANCE
- SELECT CUSTOM SETTING
- FOCUS AREA
- FOCUS CHECK
- AF MODE
- AF-C CUSTOM SETTINGS
- FACE/EYE DETECTION SETTING
- SELF-TIMER
- AE BKT SETTING
- PHOTOMETRY
- SHUTTER TYPE
- ISO
- WIRELESS COMMUNICATION
- FLASH FUNCTION SETTING
- TTL-LOCK
- MODELING FLASH
- MIC LEVEL ADJUSTMENT
- PREVIEW DEPTH OF FIELD
- PREVIEW EXP./WB IN MANUAL MODE
- PREVIEW PIC. EFFECT
- HISTOGRAM
- AE LOCK ONLY
- AF LOCK ONLY
- AE/AF LOCK
- AF-ON
- APERTURE SETTING
- AUTO IMAGE TRANSFER
- Bluetooth ON/OFF
- PLAYBACK
- NONE (control disabled)



Button assignments can also be selected using **⚡ BUTTON/DIAL SETTING > FUNCTION (Fn) SETTING**.

AE LOCK ONLY, **AF LOCK ONLY**, **AE/AF LOCK**, and **AF-ON** cannot be assigned to the touch function buttons (**T-Fn1** through **T-Fn4**).

AF-ON

If **AF-ON** is selected, you can press the control instead of keeping the shutter button pressed halfway.

MODELING FLASH

If **MODELING FLASH** is selected when a compatible shoe-mounted flash unit is attached, you can press the control to test-fire the flash and check for shadows and the like (modeling flash).

TTL-LOCK

If **TTL-LOCK** is selected, you can press the control to lock flash output according to the option selected for **⚡ FLASH SETTING > TTL-LOCK MODE** ( 166).

MY MENU

Access a personalized menu of frequently-used options.

To display “my menu”, press **MENU/OK** in the shooting display and select the **MY** (**MY MENU**) tab.

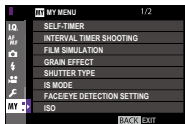

The **MY** tab is only available if options have been assigned to **MY MENU**.

MY MENU SETTING

To choose the items listed in the **MY** (**MY MENU**) tab:

- 1 Highlight **USER SETTING** > **MY MENU SETTING** in the **SET UP** tab and press **MENU/OK** to display the options at right.

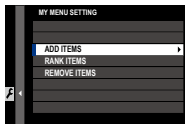

- 2 Press the focus stick (focus lever) up or down to highlight **ADD ITEMS** and press **MENU/OK**. Options that can be added to “my menu” are highlighted in blue.

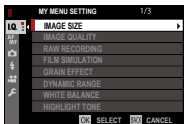

 Items currently in “my menu” are indicated by check marks.

- 3 Highlight an item and press **MENU/OK** to add it to “my menu”.

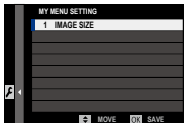

- 4 Press **MENU/OK** to return to the edit display.
- 5 Repeat Steps 3 and 4 until all the desired items have been added.

 “My menu” can contain up to 16 items.

Editing “My Menu”

To reorder or delete items, select **RANK ITEMS** or **REMOVE ITEMS** in Step 1.

10 Peripherals and Optional Accessories

External Flash Units

Flash units can be mounted on the hot shoe or connected via the sync terminal.

Optional external flash units are more powerful than the EF-X8 supplied with the camera. Some support high-speed sync (FP) and can be used at shutter speeds faster than the sync speed, while others can function as master flash units controlling remote units via optical wireless flash control.



You may be unable to test-fire the flash in some circumstances, for example when a setup menu is displayed on the camera.

- 3 Highlight items using the focus stick (focus lever) and rotate the rear command dial to change the highlighted setting.

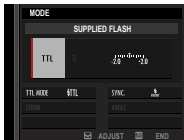

- 4 Press **DISP/BACK** to put the changes into effect.

Red-Eye Removal

Red-eye removal is available when an option other than **OFF** is selected for **[F] FLASH SETTING > RED EYE REMOVAL** and a "FACE ON" option is selected for **[AF/MF] AF/MF SETTING > FACE/EYE DETECTION SETTING**. Red-eye removal minimizes "red-eye" caused when light from the flash is reflected from the subject's retinas.

SYNC TERMINAL

SYNC TERMINAL is displayed if the EF-X8 is lowered and either no flash unit, or an incompatible flash unit, is mounted on the hot shoe.

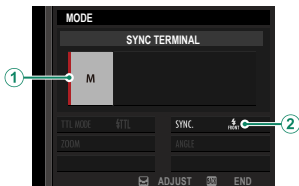

Setting	Description
① Flash control mode	<p>Choose from the following options:</p> <ul style="list-style-type: none"> • M: A trigger signal is transmitted via the hot shoe X contacts when a picture is taken. Choose a shutter speed slower than the sync speed; even slower speeds may be required if the unit uses long flashes or has a slow response time. • OFF (OFF): The trigger signal is disabled.
② Sync	<p>Choose whether the flash is timed to fire immediately after the shutter opens (FRONT/1ST CURTAIN) or immediately before it closes (REAR/2ND CURTAIN). 1ST CURTAIN is recommended in most circumstances.</p>

SHOE MOUNT FLASH



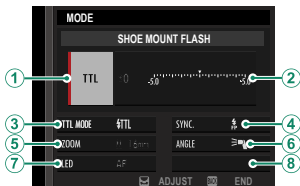



The following options are available with optional shoe-mounted flash units.





Setting	Description
① Flash control mode	<p>The flash control mode selected with the flash unit. This can in some cases be adjusted from the camera; the options available vary with the flash.</p> <ul style="list-style-type: none">• TTL: TTL mode. Adjust flash compensation (②).• M: The flash fires at the selected output regardless of subject brightness or camera settings. Output in some cases can be adjusted from the camera (②).• MULTI: Repeating flash. Compatible shoe-mounted flash units will fire multiple times with each shot.• OFF (OFF): The flash does not fire. Some flash units can be turned off from the camera.

Setting	Description
② Flash compensation/output	<p>The options available vary with flash control mode.</p> <ul style="list-style-type: none"> • TTL: Adjust flash compensation (the full value may not be applied if the limits of the flash control system are exceeded). In the cases of the EF-X20, EF-20, EF-42, and EF-X500, the selected value is added to the value selected with the flash unit. • M/MULTI: Adjust flash output (compatible units only). Choose from values expressed as fractions of full power, from $\frac{1}{1}$ (mode M) or $\frac{1}{4}$ (MULTI) down to $\frac{1}{512}$ in increments equivalent to $\frac{1}{3}$ EV. The desired results may not be achieved at low values if they exceed the limits of the flash control system; take a test shot and check the results.

Setting	Description
③ Flash mode (TTL)	<p>Choose a flash mode for TTL flash control. The options available vary with the shooting mode (P, S, A, or M) selected.</p> <ul style="list-style-type: none">• TTL (FLASH AUTO): The flash fires only as required; flash level is adjusted according to subject brightness. A  icon displayed when the shutter button is pressed halfway indicates that the flash will fire when the photo is taken.• TTL (STANDARD): The flash fires with every shot if possible; flash level is adjusted according to subject brightness. The flash will not fire if not fully charged when the shutter is released.• TTL SLOW (SLOW SYNC.): Combine the flash with slow shutter speeds when photographing portrait subjects against a backdrop of night scenery. The flash will not fire if not fully charged when the shutter is released.

Setting	Description
④ Sync	<p>Control flash timing.</p> <ul style="list-style-type: none"> •  (1ST CURTAIN): The flash fires immediately after the shutter opens (generally the best choice). •  (2ND CURTAIN): The flash fires immediately before the shutter closes. •  (AUTO FP(HSS)): High-speed sync (compatible units only). The camera automatically engages front-curtain high-speed sync at shutter speeds faster than the flash sync speed. Equivalent to 1ST CURTAIN when MULTI is selected for flash control mode.
⑤ Zoom	<p>The angle of illumination (flash coverage) for units that support flash zoom. Some units allow the adjustment to be made from the camera. If AUTO is selected, zoom will automatically be adjusted to match coverage to lens focal length.</p>
⑥ Lighting	<p>If the unit supports this feature, choose from:</p> <ul style="list-style-type: none"> •  (FLASH POWER PRIORITY): Gain range by slightly reducing coverage. •  (STANDARD): Match coverage to picture angle. •  (EVEN COVERAGE PRIORITY): Slightly increase coverage for more even lighting.

Setting	Description
⑦ LED light	Choose how the built-in LED light functions during still photography (compatible units only): as a catchlight ( /CATCHLIGHT), as an AF-assist illuminator (AF/AF ASSIST), or as both a catchlight and an AF-ASSIST illuminator ( /AF ASSIST+CATCHLIGHT). Choose OFF to disable the LED during photography.
⑦ Number of flashes *	Choose the number of times the flash fires each time the shutter is released in MULTI mode.
⑧ Frequency *	Choose the frequency at which the flash fires in MULTI mode.

* Full value may not be applied if limits of flash control system are exceeded.

MASTER(OPTICAL)

The options at right will be displayed if the unit is currently functioning as master flash for FUJIFILM optical wireless remote flash control.

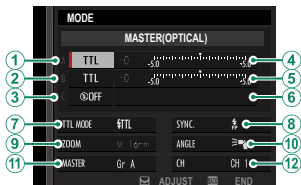



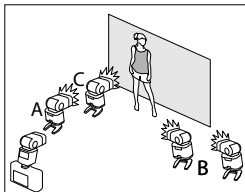



The master and remote units can be placed in up to three groups (A, B, and C) and flash mode and flash level adjusted separately for each group. Four channels are available for communication between the units; separate channels can be used for different flash systems or to prevent interference when multiple systems are operating in close proximity.



Setting	Description
① Flash control mode (group A)	<p>Choose flash control modes for groups A, B, and C. TTL% is available for groups A and B only.</p> <ul style="list-style-type: none">• TTL: The units in the group fire in TTL mode. Flash compensation can be adjusted separately for each group.• TTL%: If TTL% is selected for either group A or B, you can specify the output of the selected group as a percentage of the other and adjust overall flash compensation for both groups.
② Flash control mode (group B)	<ul style="list-style-type: none">• M: In mode M, the units in the group fire at the selected output (expressed as a fraction of full power) regardless of subject brightness or camera settings.
③ Flash control mode (group C)	<ul style="list-style-type: none">• MULTI: Choosing MULTI for any group sets all the units in all groups to repeating flash mode. All units will fire multiple times with each shot.• OFF (OFF): If OFF is selected, the units in the group will not fire.

Setting	Description	
④ Flash compensation/output (group A)	Adjust flash level for the selected group according to option selected for flash control mode. Note that the full value may not be applied if the limits of the flash control system are exceeded.	
⑤ Flash compensation/output (group B)		<ul style="list-style-type: none"> • TTL: Adjust flash compensation. • M/MULTI: Adjust flash output.
⑥ Flash compensation/output (group C)		<ul style="list-style-type: none"> • TTL%: Choose the balance between groups A and B and adjust overall flash compensation.

Setting	Description
⑦ Flash mode (TTL)	<p>Choose a flash mode for TTL flash control. The options available vary with the shooting mode (P, S, A, or M) selected.</p> <ul style="list-style-type: none">• TTL (FLASH AUTO): The flash fires only as required; flash level is adjusted according to subject brightness. A  icon displayed when the shutter button is pressed halfway indicates that the flash will fire when the photo is taken.• TTL (STANDARD): The flash fires with every shot if possible; flash level is adjusted according to subject brightness. The flash will not fire if not fully charged when the shutter is released.• TTL SLOW (SLOW SYNC.): Combine the flash with slow shutter speeds when photographing portrait subjects against a backdrop of night scenery. The flash will not fire if not fully charged when the shutter is released.

Setting	Description
<p>⑧ Sync</p>	<p>Control flash timing.</p> <ul style="list-style-type: none"> •  (1ST CURTAIN): The flash fires immediately after the shutter opens (generally the best choice). •  (2ND CURTAIN): The flash fires immediately before the shutter closes. •  (AUTO FP(HSS)): High-speed sync (compatible units only). The camera automatically engages front-curtain high-speed sync at shutter speeds faster than the flash sync speed. Equivalent to 1ST CURTAIN when MULTI is selected for flash control mode.
<p>⑨ Zoom</p>	<p>The angle of illumination (flash coverage) for units that support flash zoom. Some units allow the adjustment to be made from the camera. If AUTO is selected, zoom will automatically be adjusted to match coverage to lens focal length.</p>
<p>⑩ Lighting</p>	<p>If the unit supports this feature, choose from:</p> <ul style="list-style-type: none"> •  (FLASH POWER PRIORITY): Gain range by slightly reducing coverage. •  (STANDARD): Match coverage to picture angle. •  (EVEN COVERAGE PRIORITY): Slightly increase coverage for more even lighting.

Setting	Description
⑪ Master	Assign the master flash to group A (Gr A), B (Gr B), or C (Gr C). If OFF is selected, output from the master flash will be held to a level that does not affect the final picture. Available only if the unit is mounted on the camera hot shoe as a master flash for FUJIFILM optical wireless remote flash control in TTL , TTL% , or M mode.
⑪ Number of flashes	Choose the number of times the flash fires each time the shutter is released in MULTI mode.
⑫ Channel	Choose the channel used by the master flash for communication with the remote flash units. Separate channels can be used for different flash systems or to prevent interference when multiple systems are operating in close proximity.
⑫ Frequency	Choose the frequency at which the flash fires in MULTI mode.

Lenses

The camera can be used with lenses for the FUJIFILM X-mount.

Lens Parts

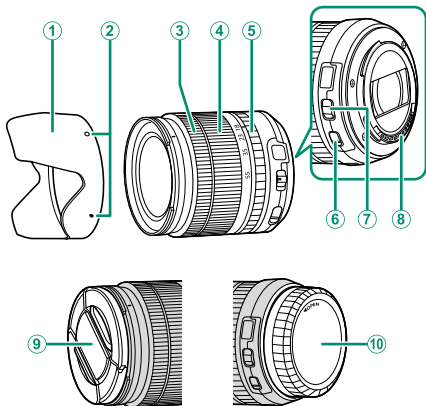

- ① Lens hood
- ② Mounting marks
- ③ Focus ring
- ④ Zoom ring
- ⑤ Aperture ring

- ⑥ O.I.S. switch
- ⑦ Aperture mode switch
- ⑧ Lens signal contacts
- ⑨ Front lens cap
- ⑩ Rear lens cap

Removing Lens Caps

Remove lens caps as shown.

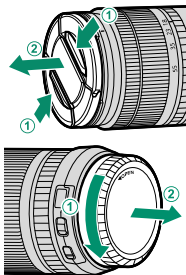

 Lens caps may differ from those shown.

Attaching Lens Hoods

When attached, lens hoods reduce glare and protect the front lens element.

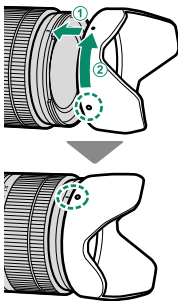

Lenses with Aperture Rings

At settings other than **A**, you can adjust aperture by rotating the lens aperture ring (exposure modes **A** and **M**).

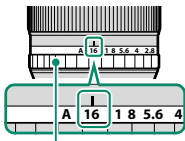

Aperture ring

The Aperture Mode Switch

If the lens has an aperture mode switch, aperture can be adjusted manually by sliding the switch to  and rotating the aperture ring.

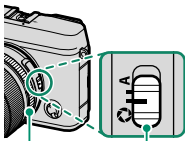

Aperture ring
Aperture mode switch

-  When the aperture ring is set to **A**, rotate the front command dial to adjust aperture.

Lenses with No Aperture Rings

The method used to adjust aperture can be selected using **FUNCTION/DIAL SETTING > APERTURE SETTING**. When an option other than **AUTO** is selected, aperture can be adjusted using the front command dial.

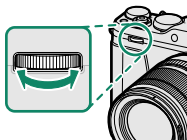

FUNCTION/DIAL SETTING Aperture control defaults to the front command dial, but can be reassigned to the rear command dial using **FUNCTION/DIAL SETTING > COMMAND DIAL SETTING**.

Lenses with O.I.S. Switches

If the lens supports optical image stabilization (O.I.S.), the image stabilization mode can be chosen in the camera menus. To activate image stabilization, slide the O.I.S. switch to **ON**.

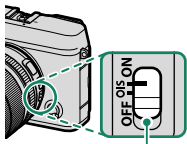

O.I.S. switch

Manual Focus Lenses

Slide the focus ring to the front for autofocus.

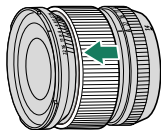

For manual focus, slide the focus ring to the back and rotate it while checking the results in the camera display. The focus distance and depth-of-field indicators can be used to assist manual focus.

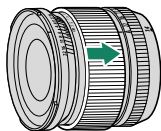

! Note that manual focus may not be available in all shooting modes.

The Depth-of-Field Indicator

The depth-of-field indicator shows the approximate depth of field (the distance in front of and behind the focus point that appears to be in focus). The indicator is displayed in film format.



Lens Care

Use a blower to remove dust, then gently wipe with a soft, dry cloth. Any remaining stains can be removed by wiping gently with a piece of FUJIFILM lens-cleaning paper to which a small amount of lens-cleaning fluid has been applied. Replace the front and rear caps when the lens is not in use.

11 Connections

HDMI Output

Camera shooting and playback displays can be output to HDMI devices.

Connecting to HDMI Devices

Connect the camera to TVs or other HDMI devices using a third-party HDMI cable.

- 1 Turn the camera off.
- 2 Connect the cable as shown below, making sure the connectors are fully inserted.

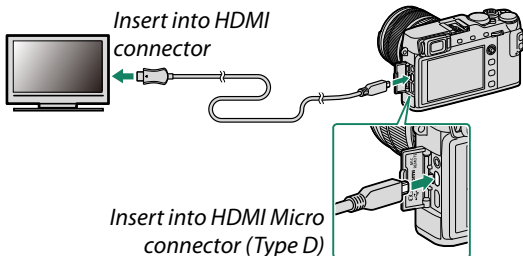

! Use an HDMI cable no more than 1.5 m (4.9 ft.) long.

- 3 Configure the device for HDMI input as described in the documentation supplied with the device.

- 4 Turn the camera on. You can now shoot and play back pictures while viewing the television display and save pictures to the HDMI device.



The USB cable cannot be used while an HDMI cable is connected.

Shooting

Shoot photos and record movies while viewing the scene through the camera lens on or saving footage to the HDMI device.



This feature can be used to save 4K and Full HD movies to an HDMI recorder.

Playback

To start playback, press the camera  button. The camera monitor turns off and pictures and movies are output to the HDMI device. Note that the camera volume controls have no effect on sounds played on the TV; use the television volume controls to adjust the volume.



Some televisions may briefly display a black screen when movie playback begins.

Wireless Transfer

Access wireless networks and connect to computers, smartphones, or tablets. For more information, visit:

<http://fujifilm-dsc.com/wifi/>



Smart Phones and Tablets: FUJIFILM Camera Remote

Install the latest version of the FUJIFILM Camera Remote app on your smartphone or tablet to connect to the camera via Bluetooth® or Wi-Fi. For downloads and other information, visit:

http://app.fujifilm-dsc.com/en/camera_remote/

Smart Phones and Tablets: Bluetooth® Pairing

Use **CONNECTION SETTING > Bluetooth SETTINGS > PAIRING REGISTRATION** to pair the camera with smartphones or tablets. Pairing offers a simple method for downloading photos from the camera.



 Photos are downloaded via a wireless connection.

Smartphones and Tablets: Wi-Fi

Use the **WIRELESS COMMUNICATION** options in **SHOOTING SETTING** or the playback menu to connect to a smartphone or tablet via Wi-Fi. Once connected, you can browse the images on the camera, download selected images, control the camera remotely, or copy location data to the camera.



Computers: FUJIFILM PC AutoSave

Install the latest version of FUJIFILM PC Autosave to your computer to upload pictures from the camera over wireless networks. For downloads and other information, visit:

http://app.fujifilm-dsc.com/en/pc_autosave/

Computers: Wireless Connections

You can upload pictures from the camera using the **PC AUTO SAVE** option in the playback menu.

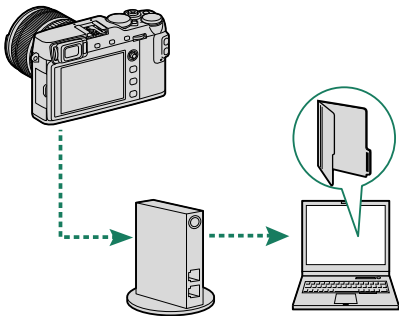

Connecting to Computers via USB

Copy pictures to a computer via USB.

Windows (MyFinePix Studio)

Use MyFinePix Studio to copy pictures to your computer, where they can be stored, viewed, organized, and printed. MyFinePix Studio is available for download from the following website:

<http://fujifilm-dsc.com/mfs/>



Once download is complete, double-click the downloaded file ("MFPS_Setup.EXE") and follow the on-screen instructions to complete installation.

Mac OS X/macOS

Pictures can be copied to your computer using Image Capture (supplied with your computer) or other software.

RAW FILE CONVERTER EX 2.0

To view RAW files on your computer, use RAW FILE CONVERTER EX 2.0, available for download from:

<http://fujifilm-dsc.com/rfc/>



Connecting the Camera

- 1 Find a memory card containing pictures you want to copy to the computer and insert the card into the camera.

! Loss of power during transfer could result in loss of data or damage to the memory card. Insert a fresh or fully-charged battery before connecting the camera.

- 2 Ready a third-party USB 2.0 cable with a Micro USB (Micro-B) connector. Turn the camera off and connect the cable, making sure the connectors are fully inserted.

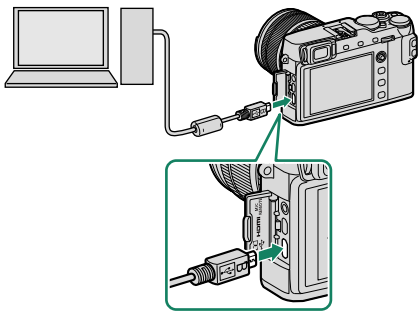

! The USB cable must be no more than 1.5 m (4.9 ft.) long and be suitable for data transfer.

- 3 Turn the camera on.
- 4 Copy pictures to the computer using MyFinePix Studio or applications provided with your operating system.
- 5 When transfer is complete, turn the camera off and disconnect the USB cable.



If a memory card containing a large number of images is inserted, there may be a delay before the software starts and you may be unable to import or save images. Use a memory card reader to transfer pictures.

Connect the camera directly to the computer; do not use a USB hub or keyboard.

Make sure that the computer does not display a message stating that copying is in progress and that the indicator lamp is out before turning the camera off or disconnecting the USB cable (if the number of images copied is very large, the indicator lamp may remain lit after the message has cleared from the computer display). Failure to observe this precaution could result in loss of data or damage to the memory card.

Disconnect the camera before inserting or removing memory cards.

In some cases, it may not be possible to access pictures saved to a network server using the software in the same way as on a standalone computer.

The user bears all applicable fees charged by the phone company or Internet service provider when using services that require an Internet connection.

instax SHARE Printers

Print pictures from your digital camera to instax SHARE printers.

Establishing a Connection

Select **CONNECTION SETTING** > **instax PRINTER CONNECTION SETTING** and enter the instax SHARE printer name (SSID) and password.

The Printer Name (SSID) and Password

The printer name (SSID) can be found on the bottom of the printer; the default password is "1111". If you have already chosen a different password to print from a smartphone, enter that password instead.

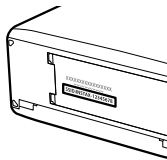

Printing Pictures

- 1 Turn the printer on.
- 2 Select  **PLAY BACK MENU** > **instax PRINTER PRINT**. The camera will connect to the printer.



To print a frame from a burst sequence, display the frame before selecting **instax PRINTER PRINT**.

- 3 Use the focus stick (focus lever) to display the picture you want to print, then press **MENU/OK**.



Pictures taken with other cameras cannot be printed.
The area printed is smaller than the area visible in the LCD monitor.

- 4 The picture will be sent to the printer and printing will start.

12

Technical Notes

Accessories from FUJIFILM

The following optional accessories are available from FUJIFILM. For the latest information on the accessories available in your region, check with your local FUJIFILM representative or visit http://www.fujifilm.com/products/digital_cameras/index.html.

Rechargeable Li-ion batteries

NP-W126/NP-W126S: Additional high-capacity NP-W126/NP-W126S rechargeable batteries can be purchased as required.



Battery chargers

BC-W126: Replacement battery chargers can be purchased as required. At +20°C/+68°F, the BC-W126 charges an NP-W126/NP-W126S in about 150 minutes.



AC power adapters

AC-9V (requires CP-W126 DC coupler): Use this 100–240 V, 50/60 Hz AC power adapter for extended shooting and playback or when copying pictures to a computer.

DC couplers

CP-W126: Connect the AC-9V to the camera.

Remote releases

RR-90: Use to reduce camera shake or keep the shutter open during a time exposure.

**Stereo microphones**

MIC-ST1: An external microphone for movie recording.

**FUJINON lenses**

XF-series lenses: Interchangeable lenses for use exclusively with the FUJIFILM X-mount.



XC-series lenses: Interchangeable lenses for use exclusively with the FUJIFILM X-mount.

**Shoe-mounted flash units**

EF-X500: This clip-on flash unit has a Guide Number of 50/164 (ISO 100, m/ft.) and supports FP (high-speed sync), allowing it to be used at shutter speeds that exceed the flash sync speed. Powered by four AA batteries or an optional EF-BP1 battery pack, it supports manual and TTL flash control and auto power zoom in the range 24–105 mm (35 mm format equivalent) and features FUJIFILM optical wireless flash control, allowing it to be used as a master or remote flash unit for remote wireless flash photography. The flash head can be rotated 90° up, 10° down, 135° left, or 180° right for bounce lighting.



Shoe-mounted flash units (continued)

EF-42: This clip-on flash unit (powered by four AA batteries) has a Guide Number of 42/137 (ISO 100, m/ft.) and supports manual and TTL flash control and auto power zoom in the range 24–105 mm (35 mm format equivalent). The flash head can be rotated 90° up, 180° left, or 120° right for bounce lighting.



EF-X20: This clip-on flash unit has a Guide Number of 20/65 (ISO 100, m/ft.). Powered by two AAA batteries, this light, compact unit features a dial for adjusting TTL flash compensation or manual flash output.



EF-20: This clip-on flash unit (powered by two AA batteries) has a Guide Number of 20/65 (ISO 100, m/ft.) and supports TTL flash control (manual flash control is not supported). The flash head can be rotated upwards 90° for bounce lighting.



Hand grips

MHG-XE3: Features an improved grip. Batteries and memory cards can be removed with the grip in place, and the grip is equipped with a rail for quick-shoe camera mounts.

Leather cases

BLC-XE3: This case combines practicality with the luxury of leather and comes with a cloth that can be used to wrap the camera before putting it in the case and on other occasions. Pictures can be taken and batteries inserted or removed with the camera still in its case.

Grip belts

GB-001: Improves grip. Combine with a hand grip for more secure handling.

Macro extension tubes

MCEX-11/16: Attach between the camera and the lens to shoot at high reproduction ratios.

Teleconverters

XF1.4X TC WR: Increases the focal length of the compatible lenses by about 1.4x.

XF2X TC WR: Increases the focal length of the compatible lenses by about 2.0x.

Mount adapters

FUJIFILM M MOUNT ADAPTER: Allows the camera to be used with a wide selection of M-mount lenses.

Body caps

BCP-001: Cover the camera lens mount when no lens is attached.

instax SHARE printers

SP-1/SP-2: Connect via wireless LAN to print pictures on instax film.

Software from FUJIFILM

The camera can be used with the following FUJIFILM software.

FUJIFILM Camera Remote

Establish a wireless connection between your camera and a smartphone or tablet (📖 284).

http://app.fujifilm-dsc.com/en/camera_remote/

FUJIFILM PC AutoSave

Download pictures from your camera over wireless networks (📖 286).

http://app.fujifilm-dsc.com/en/pc_autosave/

MyFinePix Studio

Manage, view, print, and edit the many images downloaded from your digital camera (📖 287).

<http://fujifilm-dsc.com/mfs/>

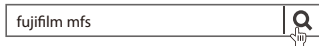

RAW FILE CONVERTER EX 2.0

View RAW pictures on your computer and convert them into other formats (📖 287).

<http://fujifilm-dsc.com/rfc/>

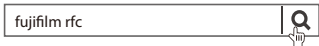

For Your Safety

IMPORTANT SAFETY INSTRUCTIONS

- **Read Instructions:** All the safety and operating instructions should be read before the appliance is operated.
- **Retain Instructions:** The safety and operating instructions should be retained for future reference.
- **Heed Warnings:** All warnings on the appliance and in the operating instructions should be adhered to.
- **Follow Instructions:** All operating and use instructions should be followed.

Installation

Power Sources: This video product should be operated only from the type of power source indicated on the marking label. If you are not sure of the type of power supply to your home, consult your appliance dealer or local power company. For video products intended to operate from battery power, or other sources, refer to the operating instructions.

Grounding or Polarization: This video product is equipped with a polarized alternating-current line plug (a plug having one blade wider than the other). This plug will fit into the power outlet only one way. This is a safety feature. If you are unable to insert the plug fully into the outlet, try reversing the plug. If the plug should still fail to fit, contact your electrician to replace your obsolete outlet. Do not defeat the safety purpose of the polarized plug.

Alternate Warnings: This video product is equipped with a three-wire grounding-type plug, a plug having a third (grounding) pin. This plug will only fit into a grounding-type power outlet. This is a safety feature. If you are unable to insert the plug into the outlet, contact your electrician to replace your obsolete outlet. Do not defeat the safety purpose of the grounding type plug.

Overloading: Do not overload wall outlets and extension cords as this can result in a risk of fire or electric shock.

Ventilation: Slots and openings in the cabinet are provided for ventilation, to ensure reliable operation of the video product and to protect it from overheating, and these openings must not be blocked or covered. The openings should never be blocked by placing the video product on a bed, sofa, rug, or other similar surface.

This video product should not be placed in a built-in installation such as a bookcase or rack unless proper ventilation is provided or the manufacturer's instructions have been adhered to. This video product should never be placed near or over a radiator or heat register.

Attachments: Do not use attachments not recommended by the video product manufacturer as they may cause hazards.

Water and Moisture: Do not use this video product near water—for example, near a bath tub, wash bowl, kitchen sink, or laundry tub, in a wet basement, or near a swimming pool, and the like.

Power-Cord Protection: Power-supply cords should be routed so that they are not likely to be walked on or pinched by items placed upon or against them, paying particular attention to cords at plugs, convenience receptacles, and the point where they exit from the appliance.

Accessories: Do not place this video product on an unstable cart, stand, tripod, bracket, or table. The video product may fall, causing serious injury to a child or adult, and serious damage to the appliance. Use only with a cart, stand, tripod, bracket, or table recommended by the manufacturer, or sold with the video product. Any mounting of the appliance should follow the manufacturer's instructions, and should use a mounting accessory recommended by the manufacturer.

An appliance and cart combination should be moved with care. Quick stops, excessive force, and uneven surfaces may cause the appliance and cart combination to overturn.



Antennas

Outdoor Antenna Grounding: If an outside antenna or cable system is connected to the video product, be sure the antenna or cable system is grounded so as to provide some protection against voltage surges and built-up static charges. Section 810 of the National Electrical Code, ANSI/NFPA No. 70, provides information with respect to proper grounding of the mast and supporting structure, grounding of the lead-in wire to an antenna discharge unit, size of grounding conductors, location of antenna discharge unit, connection to grounding electrodes, and requirements for the grounding electrode.

EXAMPLE OF ANTENNA GROUNDING AS PER
NATIONAL ELECTRICAL CODE

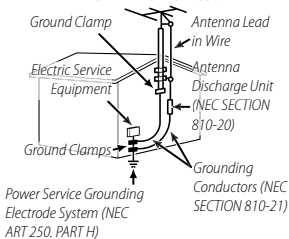

Power Lines: An outside antenna system should not be located in the vicinity of overhead power lines or other electric light or power circuits, or where it can fall into such power lines or circuits. When installing an outside antenna system, extreme care should be taken to keep from touching such power lines or circuits as contact with them might be fatal.

Use

Cleaning: Unplug this video product from the wall outlet before cleaning. Do not use liquid cleaners or aerosol cleaners. Use a damp cloth for cleaning.

Object and Liquid Entry: Never push objects of any kind into this video product through openings as they may touch dangerous voltage points or short out parts that could result in a fire or electric shock. Never spill liquid of any kind on the video product.

Lightning: For added protection for this video product receiver during a lightning storm, or when it is left unattended and unused for long periods of time, unplug it from the wall outlet and disconnect the antenna or cable system. This will prevent damage to the video product due to lightning and power-line surges.

Service

Servicing: Do not attempt to service this video product yourself as opening or removing covers may expose you to dangerous voltage or other hazards. Refer all servicing to qualified service personnel.

Damage Requiring Service: Unplug this video product from the wall outlet and refer servicing to qualified service personnel under the following conditions:

- When the power-supply cord or plug is damaged
- If liquid has been spilled, or objects have fallen into the video product.
- If the video product has been exposed to rain or water.
- If the video product has been dropped or the cabinet has been damaged.

If the video product does not operate normally follow the operating instructions. Adjust only those controls that are covered by the operating instructions as an improper adjustment of other controls may result in damage and will often require extensive work by a qualified technician to restore the video product to its normal operation.

When the video product exhibits a distinct change in performance — this indicates a need for service.

Replacement Parts: When replacement parts are required, be sure the service technician has used replacement parts specified by the manufacturer or have the same characteristics as the original part. Unauthorized substitutions may result in fire, electric shock or other hazards.

Safety Check: Upon completion of any service or repairs to this video product, ask the service technician to perform safety checks to determine that the video product is in proper operating condition.



Be sure to read these notes before use

Safety Notes



- Make sure that you use your camera correctly. Read these safety notes and your *Owner's Manual* carefully before use.
- After reading these safety notes, store them in a safe place.

About the Icons



The icons shown below are used in this document to indicate the severity of the injury or damage that can result if the information indicated by the icon is ignored and the product is used incorrectly as a result.

	WARNING	This icon indicates that death or serious injury can result if the information is ignored.
	CAUTION	This icon indicates that personal injury or material damage can result if the information is ignored.

The icons shown below are used to indicate the nature of the instructions which are to be observed.

	Triangular icons tell you that this information requires attention ("Important").
	Circular icons with a diagonal bar tell you that the action indicated is prohibited ("Prohibited").
	Filled circles with an exclamation mark indicate an action that must be performed ("Required").

The symbols on the product (including the accessories) represent the following:

	AC
	DC
	Class II equipment (The construction of the product is double-insulated.)









WARNING









If a problem arises, turn the camera off, remove the battery, and disconnect and unplug the AC power adapter. Continued use of the camera when it is emitting smoke, is emitting any unusual odor, or is in any other abnormal state can cause a fire or electric shock. Contact your FUJIFILM dealer.

Do not allow water or foreign objects to enter the camera. If water or foreign objects get inside the camera, turn the camera off, remove the battery, and disconnect and unplug the AC power adapter. Continued use of the camera can cause a fire or electric shock. Contact your FUJIFILM dealer.

Do not use the camera in the bathroom or shower. This can cause a fire or electric shock.

Never attempt to change or take apart the camera (never open the case). Failure to observe this precaution can cause fire or electric shock.

 WARNING	
 <small>Do not touch internal parts</small>	<u>Should the case break open as the result of a fall or other accident, do not touch the exposed parts.</u> Failure to observe this precaution could result in electric shock or in injury from touching the damaged parts. Remove the battery immediately, taking care to avoid injury or electric shock, and take the product to the point of purchase for consultation.
	<u>Do not change, heat or unduly twist or pull the connection cord and do not place heavy objects on the connection cord.</u> These actions could damage the cord and cause a fire or electric shock. If the cord is damaged, contact your FUJIFILM dealer.
	<u>Do not place the camera on an unstable surface.</u> This can cause the camera to fall or tip over and cause injury.
	<u>Never attempt to take pictures while in motion.</u>
	Do not use the camera while walking or driving. This can result in you falling down or being involved in a traffic accident.
	<u>Do not touch any metal parts of the camera during a thunderstorm.</u> This can cause an electric shock due to induced current from the lightning discharge.
	<u>Do not use the battery except as specified.</u> Load the battery as shown by the indicator.
	<u>Do not disassemble, modify, or heat batteries. Do not drop, strike, or throw batteries or otherwise subject them to strong impacts. Do not use batteries that show signs of leaking, deformation, discoloration, or other abnormalities. Use only designated chargers to recharge rechargeable batteries and do not attempt to recharge non-rechargeable Li-ion or alkaline batteries. Do not short batteries or store them with metallic objects.</u> Failure to observe these precautions could result in the batteries overheating, igniting, rupturing, or leaking, causing fire, burns, or other injury.

 WARNING	
	<u>Use only batteries or AC power adapters specified for use with this camera. Do not use voltages other than the power supply voltage shown.</u> The use of other power sources can cause a fire.
	<u>If the battery leaks and fluid gets in contact with your eyes, skin or clothing, flush the affected area with clean water and seek medical attention or call an emergency number right away.</u>
	<u>Do not use the charger to charge batteries other than those specified here.</u> The supplied charger is for use only with batteries of the type supplied with the camera. Using the charger to charge conventional batteries or other types of rechargeable batteries can cause the battery to leak, overheat or burst.
	<u>Using a flash too close to a person's eyes may cause visual impairment.</u> Take particular care when photographing infants and young children.
	<u>Do not remain in prolonged contact with hot surfaces.</u> Failure to observe this precaution could result in low-temperature burns, particularly at high ambient temperatures or with users who suffer from poor circulation or reduced sensation, in which case use of a tripod or similar precautions are recommended.
	<u>Do not leave one part of the body in contact with the product for prolonged periods while the product is on.</u> Failure to observe this precaution could result in low-temperature burns, particularly during prolonged use, at high ambient temperatures, or with users who suffer from poor circulation or reduced sensation, in which case use of a tripod or similar precautions are recommended.
	<u>Do not use in the presence of flammable objects, explosive gases, or dust.</u>

 **WARNING**

When carrying the battery, install it in a digital camera or keep it in the hard case. When storing the battery, keep it in the hard case.



When discarding, cover the battery terminals with insulation tape. Contact with other metallic objects or batteries could cause the battery to ignite or burst.

Keep memory cards, hot shoes, and other small parts out of the reach of small children.



Children may swallow small parts; keep out of reach of children. Should a child swallow a small part, seek medical attention or call emergency.

Keep out of reach of small children. Among the elements that could cause injury are the strap, which could become entangled about a child's neck, causing strangulation, and the flash, which could cause visual impairment.



Follow the directions of airline and hospital personnel. This product generates radio-frequency emissions that could interfere with navigational or medical equipment.



 **CAUTION**



Do not cover or wrap the camera or the AC power adapter in a cloth or blanket. This can cause heat to build up and distort the casing or cause a fire.



When you are cleaning the camera or you do not plan to use the camera for an extended period, remove the battery and disconnect and unplug the AC power adapter. Failure to do so can cause a fire or electric shock.



When charging ends, unplug the charger from the power socket. Leaving the charger plugged into the power socket can cause a fire.



When a memory card is removed, the card could come out of the slot too quickly. Use your finger to hold it and gently release the card. Injury could result to those struck by the ejected card.



Request regular internal testing and cleaning for your camera. Build-up of dust in your camera can cause a fire or electric shock. Contact your FUJIFILM dealer to request internal cleaning every two years. Please note that this service is not free of charge.



Danger of explosion if battery is incorrectly replaced. Replace only with the same or equivalent type.

 **CAUTION**



Do not use this camera in locations affected by oil fumes, steam, humidity or dust. This can cause a fire or electric shock.



Do not leave this camera in places subject to extremely high temperatures. Do not leave the camera in locations such as a sealed vehicle or in direct sunlight. This can cause a fire.



Do not place heavy objects on the camera. This can cause the heavy object to tip over or fall and cause injury.



Do not move the camera while the AC power adapter is still connected. Do not pull on the connection cord to disconnect the AC power adapter. This can damage the power cord or cables and cause a fire or electric shock.

The Battery and Power Supply

Note: Check the type of battery used in your camera and read the appropriate sections.

The following describes the proper use of batteries and how to prolong their life. Incorrect use can shorten battery life or cause leakage, overheating, fire, or explosion.

Li-ion Batteries

Read this section if your camera uses a rechargeable Li-ion battery.

The battery is not charged at shipment. Charge the battery before use. Keep the battery in its case when not in use.

■ Notes on the Battery

The battery gradually loses its charge when not in use. Charge the battery one or two days before use.

Battery life can be extended by turning the camera off when not in use.

Battery capacity decreases at low temperatures; a depleted battery may not function when cold. Keep a fully charged spare battery in a warm place and exchange as necessary, or keep the battery in your pocket or other warm place and insert it in the camera only when shooting. Do not place the battery in direct contact with hand warmers or other heating devices.

■ Charging the Battery

Charge the battery in the supplied battery charger. Charging times will increase at ambient temperatures below +10°C (+50°F) or above +35°C (+95°F). Do not attempt to charge the battery at temperatures above 40°C (+104°F); at temperatures below 0°C (+32°F), the battery will not charge.

Do not attempt to recharge a fully charged battery. The battery does not however need to be fully discharged before charging.

The battery may be warm to the touch immediately after charging or use. This is normal.

■ Battery Life

At normal temperatures, the battery can be recharged about 300 times. A noticeable decrease in the length of time the battery will hold a charge indicates that it has reached the end of its service life and should be replaced.

■ Storage

Performance may be impaired if the battery is left unused for extended periods when fully charged. Run the battery flat before storing it.

If the camera will not be used for an extended period, remove the battery and store it in a dry place with an ambient temperature of from +15°C to +25°C (+59°F to +77°F). Do not store in locations exposed to extremes of temperature.

■ Cautions: Handling the Battery

- Do not transport or store with metal objects such as necklaces or hairpins.
- Do not expose to flame or heat.
- Do not disassemble or modify.
- Use with designated chargers only.
- Dispose of used batteries promptly.
- Do not drop or subject to strong physical shocks.
- Do not expose to water.
- Keep the terminals clean.
- The battery and camera body may become warm to the touch after extended use. This is normal.

■ Disposal

Dispose of used batteries in accord with local regulations.

AC Power Adapters (Available Separately)

Use only FUJIFILM AC power adapters designated for use with this camera. Other adapters could damage the camera.

- The AC power adapter is for indoor use only.
- Be sure the DC plug is securely connected to the camera.
- Turn the camera off before disconnecting the adapter. Disconnect the adapter by the plug, not the cable.

- Do not use with other devices.
- Do not disassemble.
- Do not expose to high heat and humidity.
- Do not subject to strong physical shocks.
- The adapter may hum or become hot to the touch during use. This is normal.
- If the adapter causes radio interference, reorient or relocate the receiving antenna.

Using the Camera

- Do not aim the camera at extremely bright light sources, such as the sun in a cloudless sky. Failure to observe this precaution could damage the camera image sensor.
- Strong sunlight focused through the viewfinder may damage the panel of electronic viewfinder (EVF). Do not aim the electronic viewfinder at the sun.

Take Test Shots

Before taking photographs on important occasions (such as at weddings or before taking the camera on a trip), take a test shot and view the results to ensure that the camera is functioning normally. FUJIFILM Corporation cannot accept liability for damages or lost profits incurred as a result of product malfunction.

Notes on Copyright

Unless intended solely for personal use, images recorded using your digital camera system cannot be used in ways that infringe copyright laws without the consent of the owner. Note that some restrictions apply to the photographing of stage performances, entertainments, and exhibits, even when intended purely for personal use. Users are also asked to note that the transfer of memory cards containing images or data protected under copyright laws is only permissible within the restrictions imposed by those copyright laws.

Handling

To ensure that images are recorded correctly, do not subject the camera to impact or physical shocks while images are being recorded.

Liquid Crystal

In the event that the display is damaged, care should be taken to avoid contact with liquid crystal. Take the urgent action indicated should any of the following situations arise:

- **If liquid crystal comes in contact with your skin**, clean the area with a cloth and then wash thoroughly with soap and running water.
- **If liquid crystal enters your eyes**, flush the affected eye with clean water for at least 15 minutes and then seek medical assistance.
- **If liquid crystal is swallowed**, rinse your mouth thoroughly with water. Drink large quantities of water and induce vomiting, then seek medical assistance.

Although the display is manufactured using extremely high-precision technology, it may contain pixels that are always lit or that do not light. This is not a malfunction, and images recorded with the product are unaffected.

Trademark Information

Digital Split Image is a trademark or registered trademark of FUJIFILM Corporation. xD-Picture Card and  are trademarks of FUJIFILM Corporation. The typefaces included herein are solely developed by DynaComware Taiwan Inc. Macintosh, Mac OS, and macOS are trademarks of Apple Inc. in the U.S.A. and other countries. Windows is a registered trademark of Microsoft Corporation in the U.S.A. and other countries. Wi-Fi® and Wi-Fi Protected Setup® are registered trademarks of the Wi-Fi Alliance. The Bluetooth® word mark and logos are registered trademarks owned by the Bluetooth SIG, Inc., and any use of such marks by FUJIFILM is under license. The SDHC and SDXC logos are trademarks of SD-3C, LLC. The HDMI logo is a trademark. All other trade names mentioned in this manual are the trademarks or registered trademarks of their respective owners.

Electrical Interference

This camera may interfere with hospital or aviation equipment. Consult with hospital or airline staff before using the camera in a hospital or on an aircraft.

Color Television Systems

NTSC (National Television System Committee) is a color television telecasting specification adopted mainly in the U.S.A., Canada, and Japan. PAL (Phase Alternation by Line) is a color television system adopted mainly in European countries and China.

Exif Print (Exif Version 2.3)

Exif Print is a newly revised digital camera file format in which information stored with photographs is used for optimal color reproduction during printing.

IMPORTANT NOTICE: Read Before Using the Software

Direct or indirect export, in whole or in part, of licensed software without the permission of the applicable governing bodies is prohibited.

NOTICES

To prevent fire or shock hazard, do not expose the unit to rain or moisture.

Please read the "Safety Notes" and make sure you understand them before using the camera.

Perchlorate Material—special handling may apply. See:

<http://www.dtscc.ca.gov/hazardouswaste/perchlorate>

For Customers in the U. S. A.

Tested To Comply With FCC Standards

FOR HOME OR OFFICE USE



FCC Statement: This device complies with Part 15 of the FCC Rules. Operation is subject to the following two conditions: (1) This device may not cause harmful interference, and (2) this device must accept any interference received, including interference that may cause undesired operation.

CAUTION: This equipment has been tested and found to comply with the limits for a Class B digital device, pursuant to Part 15 of the FCC Rules. These limits are designed to provide reasonable protection against harmful interference in a residential installation. This equipment generates, uses, and can radiate radio frequency energy and, if not installed and used in accordance with the instructions, may cause harmful interference to radio communications. However, there is no guarantee that interference will not occur in a particular installation. If this equipment does cause harmful interference to radio or television reception, which can be determined by turning the equipment off and on, the user is encouraged to try to correct the interference by one or more of the following measures:

- Reorient or relocate the receiving antenna.
- Increase the separation between the equipment and receiver.
- Connect the equipment into an outlet on a circuit different from that to which the receiver is connected.
- Consult the dealer or an experienced radio/TV technician for help.

FCC Caution: Any changes or modifications not expressly approved by the party responsible for compliance could void the user's authority to operate this equipment.

This transmitter must not be co-located or operating in conjunction with any other antenna or transmitter.

Radiation Exposure Statement: This device meets the government's requirements for exposure to radio waves. This device is designed and manufactured not to exceed the emission limits for exposure to radio frequency (RF) energy set by the Federal Communications Commission of the U.S. Government.

The exposure standard for wireless device employs a unit of measurement known as the Specific Absorption Rate, or SAR. The SAR limit set by the FCC is 1.6W/kg. Tests for SAR are conducted using standard operating positions accepted by the FCC with the device transmitting at its highest certified power level in all tested frequency bands.

Notes on the Grant: To comply with Part 15 of the FCC Rules, this product must be used with a Fujifilm-specified ferrite-core A/V cable, USB cable, and DC supply cord.



A lithium ion battery that is recyclable powers the product you have purchased. Please call 1-800-8-BATTERY for information on how to recycle this battery.

For Customers in Canada

CAN ICES-3 (B)/NMB-3(B)

CAUTION: This Class B digital apparatus complies with Canadian ICES-003.

Industry Canada statement: This device complies with Industry Canada's licence-exempt RSSs. Operation is subject to the following two conditions: (1) This device may not cause interference; and (2) This device must accept any interference, including interference that may cause undesired operation of the device.

This device and its antenna(s) must not be co-located or operating in conjunction with any other antenna or transmitter, except tested built-in radios. The County Code Selection feature is disabled for products marketed in the US/ Canada.

Radiation Exposure Statement: The available scientific evidence does not show that any health problems are associated with using low power wireless devices. There is no proof, however, that these low power wireless devices are absolutely safe. Low power Wireless devices emit low levels of radio frequency energy (RF) in the microwave range while being used. Whereas high levels of RF can produce health effects (by heating tissue), exposure of low-level RF that does not produce heating effects causes no known adverse health effects. Many studies of low-level RF exposures have not found any biological effects. Some studies have suggested that some biological effects might occur, but such findings have not been confirmed by additional research. X-E3 has been tested and found to comply with IC radiation exposure limits set forth for an uncontrolled environment and meets RSS-102 of the IC radio frequency (RF) Exposure rules.

Disposal of Electrical and Electronic Equipment in Private Households

In the European Union, Norway, Iceland and Liechtenstein:

This symbol on the product, or in the manual and in the warranty, and/or on its packaging indicates that this product shall not be treated as household waste. Instead it should be taken to an applicable collection point for the recycling of electrical and electronic equipment.

By ensuring this product is disposed of correctly, you will help prevent potential negative consequences to the environment and human health, which could otherwise be caused by inappropriate waste handling of this product.

This symbol on the batteries or accumulators indicates that those batteries shall not be treated as household waste.



If your equipment contains easy removable batteries or accumulators please dispose these separately according to your local requirements.

The recycling of materials will help to conserve natural resources. For more detailed information about recycling this product, please contact your local city office, your household waste disposal service or the shop where you purchased the product.

In Countries Outside the European Union, Norway, Iceland and Liechtenstein: If you wish to discard this product, including the batteries or accumulators, please contact your local authorities and ask for the correct way of disposal.

In Japan: This symbol on the batteries indicates that they are to be disposed of separately.



Li-ion



Wireless Network and Bluetooth Devices: Cautions

This product complies with the following EU Directives:

- RoHS Directive 2011/65/EU
- RE Directive 2014/53/EU

Hereby, FUJIFILM Corporation declares that the radio equipment type FF170001 is in compliance with Directive 2014/53/EU.

The full text of the EU declaration of conformity is available at the following internet address: http://www.fujifilm.com/products/digital_cameras/x/fujifilm_x_e3/pdf/index/fujifilm_x_e3_cod.pdf

This compliance is indicated by the following conformity marking placed on the product:



This marking is valid for non-Telecom products and EU harmonized Telecom products (e.g. Bluetooth®).

IMPORTANT: Read the following notices before using the camera's built-in wireless transmitter.

- ① This product, which contains encryption function developed in the United States, is controlled by the United States Export Administration Regulations and may not be exported or re-exported to any country to which the United States embargoes goods.
- **Use only a wireless network or Bluetooth device.** FUJIFILM does not accept liability for damages resulting from unauthorized use. Do not use in applications requiring a high degree of reliability, for example in medical devices or other systems that may directly or indirectly impact human life. When using the device in computer and other systems that demand a greater degree of reliability than offered by wireless network or Bluetooth devices, be sure to take all necessary precautions to ensure safety and prevent malfunction.

- **Use only in the country in which the device was purchased.** This device conforms to regulations governing wireless network and Bluetooth devices in the country in which it was purchased. Observe all location regulations when using the device. FUJIFILM does not accept liability for problems arising from use in other jurisdictions.
- **Do not use the device in locations subject to magnetic fields, static electricity, or radio interference.** Do not use the transmitter in the vicinity of microwave ovens or in other locations subject to magnetic fields, static electricity, or radio interference that may prevent reception of wireless signals. Mutual interference may occur when the transmitter is used in the vicinity of other wireless devices operating in the 2.4 GHz band.
- **The wireless transmitter operates in the 2.4 GHz band using DSSS, OFDM and GFSK modulation.**
- **Security:** Wireless network and Bluetooth devices transmit data via radio and consequently their use requires greater attention to security than applies in the case of wired networks.
 - Do not connect to unknown networks or networks to which you do not have access rights, even if they are displayed on your device, as such access may be considered unauthorized. Connect only to networks to which you have access rights.
 - Be aware that wireless transmissions may be vulnerable to interception by third parties.
- **The following may be punishable by law:**
 - Disassembly or modification of this device
 - Removal of device certification labels
- **This device operates on the same frequency as commercial, educational, and medical devices and wireless transmitters.** It also operates on the same frequency as licensed transmitters and special unlicensed low-voltage transmitters used in RFID tracking systems for assembly lines and in other similar applications.

- **To prevent interference with the above devices, observe the following precautions.** Confirm that the RFID transmitter is not in operation before using this device. Should you observe that the device causes interference in licensed transmitters used for RFID tracking, immediately stop using the affected frequency or move the device to another location. If you notice that this device causes interference in low-voltage RFID tracing systems, contact a FUJIFILM representative.
- **Do not use this device on board an aircraft.** Note that Bluetooth may remain on even when the camera is off. Bluetooth can be disabled by selecting **OFF** for  **CONNECTION SETTING > Bluetooth SETTINGS > Bluetooth ON/OFF.**

Be sure to read these notes before use

Safety Notes

- Make sure that you use the lens correctly. Read these safety notes and the camera *Owner's Manual* carefully before use.
- After reading these safety notes, store them in a safe place.

About the Icons

The icons shown below are used in this document to indicate the severity of the injury or damage that can result if the information indicated by the icon is ignored and the product is used incorrectly as a result.

**WARNING**

This icon indicates that death or serious injury can result if the information is ignored.

**CAUTION**

This icon indicates that personal injury or material damage can result if the information is ignored.

The icons shown below are used to indicate the nature of the instructions which are to be observed.



Triangular icons tell you that this information requires attention ("Important").



Circular icons with a diagonal bar tell you that the action indicated is prohibited ("Prohibited").



Filled circles with an exclamation mark indicate an action that must be performed ("Required").

**WARNING**

Do not immerse

Do not immerse in or expose to water. Failure to observe this precaution can cause a fire or electric shock.



Do not disassemble

Do not disassemble (do not open the case). Failure to observe this precaution can cause fire, electric shock, or injury due to product malfunction.

**WARNING**

Should the case break open as the result of a fall or other accident, do not touch the exposed



Do not touch internal parts

parts. Failure to observe this precaution could result in electric shock or in injury from touching the damaged parts. Remove the battery immediately, taking care to avoid injury or electric shock, and take the product to the point of purchase for consultation.



Do not place on unstable surfaces. The product may fall, causing injury.



Do not view the sun through the lens or camera viewfinders. Failure to observe this precaution can cause permanent visual impairment.

**CAUTION**

Do not use or store in locations that are exposed to steam, or smoke or are very humid or extremely dusty. Failure to observe this precaution can cause fire or electric shock.



Do not leave in direct sunlight or in locations subject to very high temperatures, such as in a closed vehicle on a sunny day. Failure to observe this precaution can cause fire.



Keep out of the reach of small children. This product could cause injury in the hands of a child.



Do not handle with wet hands. Failure to observe this precaution can cause electric shock.



Keep the sun out of the frame when shooting backlit subjects. Sunlight focused into the camera when the sun is in or close to the frame can cause fire or burns.



When the product is not in use, replace the lens caps and store out of direct sunlight. Sunlight focused by the lens can cause fire or burns.



Do not carry the camera or lens while they are attached to a tripod. The product can fall or strike other objects, causing injury.

Product Care

To ensure continued enjoyment of the product, observe the following precautions.

Camera body: Use a soft, dry cloth to clean the camera body after each use. Do not use alcohol, thinner, or other volatile chemicals, which could discolor or deform the leather on the camera body. Any liquid on the camera should be removed immediately with a soft, dry cloth. Use a blower to remove dust from the monitor, taking care to avoid scratches, and then gently wipe with a soft, dry cloth. Any remaining stains can be removed by wiping gently with a piece of FUJIFILM lens-cleaning paper to which a small amount of lens-cleaning fluid has been applied. To prevent dust entering the camera, replace the body cap when no lens is in place.

Image sensor: Multiple photographs marred by spots or blotches in identical locations may indicate the presence of dust on the image sensor. Clean the sensor using  **USER SETTING > SENSOR CLEANING.**

Cleaning the Image Sensor

Dust that cannot be removed using **USER SETTING > SENSOR CLEANING** can be removed manually as described below.

! Note that there will be a charge to repair or replace the image sensor if it is damaged during cleaning.

- 1 Use a blower (not a brush) to remove dust from the sensor.

! Do not use a brush or blower brush. Failure to observe this precaution could damage the sensor.

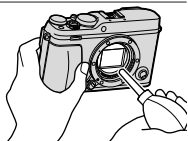

- 2 Check whether the dust has been successfully removed. Repeat Steps 1 and 2 as necessary.
- 3 Replace the body cap or lens.

Firmware Updates

Updates to product firmware may result in changes not described in the manual. For more information, visit:

http://www.fujifilm.com/support/digital_cameras/software



Checking the Firmware Version

 The camera will only display the firmware version if a memory card is inserted.

- 1 Turn the camera off and check that a memory card is inserted.
- 2 Turn the camera on while pressing the **DISP/BACK** button. The current firmware version will be displayed; check the firmware version.
- 3 Turn the camera off.

 To view the firmware version or update firmware for optional accessories such as interchangeable lenses, shoe-mounted flash units, and mount adapters, mount the accessories on the camera.

Troubleshooting

Consult the table below should you encounter problems using your camera. If you don't find the solution here, contact your local FUJIFILM distributor.

Power and Battery

Problem	Solution
The camera does not turn on.	<ul style="list-style-type: none">• The battery is exhausted: Charge the battery or insert a fully-charged spare battery (📖 32).• The battery is inserted incorrectly: Reinsert in the correct orientation (📖 37).• The battery-chamber cover is not latched: Latch the battery-chamber cover (📖 38).
The monitor does not turn on.	The monitor may not turn on if the camera is turned off and then on again very quickly. Keep the shutter button pressed halfway until the monitor activates.
The battery runs down quickly.	<ul style="list-style-type: none">• The battery is cold: Warm the battery by placing it in a pocket or other warm place and reinsert it in the camera immediately before taking a picture.• There is dirt on the battery terminals: Clean the terminals with a soft, dry cloth.• ON is selected for AF/MF AF/MF SETTING > PRE-AF: Turn PRE-AF off (📖 137).• The battery has been charged many times: The battery has reached the end of its charging life. Purchase a new battery.

Problem	Solution
The camera turns off suddenly.	The battery is exhausted: Charge the battery or insert a fully-charged spare battery (📖 32).
Charging does not start.	Reinsert the battery in the correct orientation and make sure that the charger is plugged in (📖 32).
Charging is slow.	Charge the battery at room temperature.
The charging lamp blinks, but the battery does not charge.	<ul style="list-style-type: none"> • There is dirt on the battery terminals: Clean the terminals with a soft, dry cloth. • The battery has been charged many times: The battery has reached the end of its charging life. Purchase a new battery. If the battery still fails to charge, contact your FUJIFILM dealer (📖 294).

Menus and Displays

Problem	Solution
Display is not in English.	Select ENGLISH for USER SETTING > 言語/LANG. (📖 46, 206).

Shooting

Problem	Solution
No picture is taken when the shutter button is pressed.	<ul style="list-style-type: none"> • The memory card is full: Insert a new memory card or delete pictures (📖 36, 183). • The memory card is not formatted: Format the memory card (📖 203). • There is dirt on the memory card contacts: Clean the contacts with a soft, dry cloth.

Problem	Solution
<p>No picture is taken when the shutter button is pressed (continued).</p>	<ul style="list-style-type: none"> • The memory card is damaged: Insert a new memory card (📖 36). • The battery is exhausted: Charge the battery or insert a fully-charged spare battery (📖 32). • The camera has turned off automatically: Turn the camera on (📖 42). • You are using a third-party mount adapter: Select ON for SHOOT WITHOUT LENS (📖 230). • The indicator lamp was orange when you attempted to record a panorama: Wait until the indicator lamps turns off (📖 10).
<p>Mottling (“noise”) appears in the monitor or viewfinder when the shutter button is pressed halfway.</p>	<p>Gain is increased to aid composition when the subject is poorly lit and aperture is stopped down, which may result in noticeable mottling when images are previewed in the displays. Images taken with the camera are unaffected.</p>
<p>The camera does not focus.</p>	<p>The subject is not suited to autofocus: Use focus lock or manual focus (📖 92).</p>

Problem	Solution
No face is detected.	<ul style="list-style-type: none"> • The subject's face is obscured by sunglasses, a hat, long hair, or other objects: Remove the obstructions (📖 139). • The subject's face occupies only a small area of the frame: Change the composition so that the subject's face occupies a larger area of the frame (📖 139). • The subject's head is tilted or horizontal: Ask the subject to hold their head straight (📖 139). • The camera is tilted: Keep the camera level. • The subject's face is poorly lit: Shoot in bright light.
Wrong subject is selected.	<p>The selected subject is closer to the center of the frame than the main subject. Recompose the picture or turn face detection off and frame the picture using focus lock (📖 92).</p>
The flash does not fire.	<ul style="list-style-type: none"> • The flash is disabled: Adjust settings (📖 107). • The flash is lowered: Raise the flash (📖 107). • The battery is exhausted: Charge the battery or insert a fully-charged spare battery (📖 32). • The camera is in bracketing or continuous mode: Select single frame mode (📖 6).

Problem	Solution
The flash does not fully light the subject.	<ul style="list-style-type: none"> • The subject is not in range of the flash: Position the subject in range of the flash. • The flash window is obstructed: Hold the camera correctly. • Shutter speed is faster than the sync speed: Choose a slower shutter speed (📖 64, 72).
Pictures are blurred.	<ul style="list-style-type: none"> • The lens is dirty: Clean the lens (📖 280). • The lens is blocked: Keep objects away from the lens (📖 49). • !AF is displayed during shooting and the focus frame is displayed in red: Check focus before shooting (📖 50).
Pictures are mottled.	<ul style="list-style-type: none"> • Shutter speed is slow and the ambient temperature is high: This is normal and does not indicate a malfunction. • Pixel mapping is required: Perform pixel mapping using 📷 IMAGE QUALITY SETTING > PIXEL MAPPING (📖 130). • The camera has been used continuously at high temperatures or a temperature warning is displayed: Turn the camera off and wait for it to cool down (📖 42).

Playback

Problem	Solution
Pictures are grainy.	The pictures were taken with a different make or model of camera.
Playback zoom is unavailable.	The pictures were created using RESIZE or with a different make or model of camera.
No sound in movie playback.	<ul style="list-style-type: none"> • Playback volume is too low: Adjust playback volume (📖 213). • The microphone was obstructed: Hold the camera correctly during recording. • The speaker is obstructed: Hold the camera correctly during playback.
Selected pictures are not deleted.	Some of the pictures selected for deletion are protected. Remove protection using the device with which it was originally applied (📖 188).
File numbering is unexpectedly reset.	The battery-chamber cover was opened while the camera was on. Turn the camera off before opening the battery-chamber cover (📖 237).

Connections

Problem	Solution
The monitor is blank.	The camera is connected to a TV: Pictures will be displayed on the TV instead of in the camera monitor (📖 282).
No picture or sound on TV.	<ul style="list-style-type: none">• The camera is not properly connected: Connect the camera properly (📖 282).• Input on the television is set to “TV”: Set input to “HDMI” (📖 282).• The volume on the TV is too low: Use the controls on the television to adjust the volume.
Both the TV and camera monitor are blank.	The display mode selected with the VIEW MODE button is EVF ONLY +  SENSOR: Put your eye to the viewfinder or use the VIEW MODE button to choose another display mode.
The computer does not recognize the camera.	Be sure the camera and computer are correctly connected (📖 287).
Cannot transfer RAW or JPEG files to computer.	Use MyFinePix Studio to transfer pictures (Windows only; 📖 287).

Wireless Transfer

For additional information on troubleshooting wireless connections, visit:

<http://digital-cameras.support.fujifilm.com/app?pid=x>



Problem	Solution
<p>Problem connecting or uploading pictures to smartphone.</p>	<ul style="list-style-type: none"> • The smartphone is too far away: Move the devices closer (📖 284). • Nearby devices are causing radio interference: Move the camera and smartphone away from microwave ovens or cordless phones (📖 284).
<p>Cannot upload images.</p>	<ul style="list-style-type: none"> • The smartphone is connected to another device: The smartphone and camera can connect to only one device at a time. End the connection and try again (📖 284). • There are several smartphones in the vicinity: Try connecting again. The presence of multiple smartphones can make connection difficult (📖 284). • The current image is a movie or was created on another device and cannot be uploaded to a smartphone (📖 284).
<p>Smartphone will not display pictures.</p>	<p>Select ON for RESIZE IMAGE FOR SMARTPHONE 3M. Selecting OFF increases upload times for larger images; in addition, some phones may not display images over a certain size (📖 243).</p>

Miscellaneous

Problem	Solution
The camera is unresponsive.	<ul style="list-style-type: none"> • Temporary camera malfunction: Remove and reinsert the battery (📖 36). • The battery is exhausted: Charge the battery or insert a fully-charged spare battery (📖 32). • The camera is connected to a wireless LAN: End the connection.
The camera does not function as expected.	Remove and reinsert the battery (📖 36). If the problem persists, contact your FUJIFILM dealer.
No sound.	Adjust the volume (📖 210).
Pressing the Q button does not display the quick menu.	TTL-LOCK is active: End TTL-LOCK (📖 255).







Warning Messages and Displays

The following warnings appear in the display.

Warning	Description
 (red)	Low battery. Charge the battery or insert a fully-charged spare battery.
 (blinks red)	Battery exhausted. Charge the battery or insert a fully-charged spare battery.
!AF (displayed in red with red focus frame)	The camera cannot focus. Use focus lock to focus on another subject at the same distance, then re-compose the picture.
Aperture or shutter speed displayed in red	The subject is too bright or too dark and the picture will be over- or under-exposed. Use the flash for additional lighting when taking photographs of poorly-lit subject.
FOCUS ERROR LENS CONTROL ERROR TURN OFF THE CAMERA AND TURN ON AGAIN	Camera malfunction. Turn the camera off and then on again. If the message persists, contact a FUJIFILM dealer.
NO CARD	The shutter can only be released when a memory card is inserted. Insert a memory card.
CARD NOT INITIALIZED	<ul style="list-style-type: none">• The memory card is not formatted or the memory card has been formatted in a computer or other device: Format the memory card using  USER SETTING > FORMAT.





Warning	Description
CARD NOT INITIALIZED (continued)	<ul style="list-style-type: none"> • The memory card contacts require cleaning: Clean the contacts with a soft, dry cloth. If the message is repeated, format the card. If the message persists, replace the card. • Camera malfunction: Contact a FUJIFILM dealer.
LENS ERROR	Turn the camera off, remove the lens, and clean the mounting surfaces, then replace the lens and turn the camera on. If the problem persists, contact a FUJIFILM dealer.
CARD ERROR	<ul style="list-style-type: none"> • The memory card is not formatted for use in the camera: Format the card. • The memory card contacts require cleaning or the memory card is damaged: Clean the contacts with a soft, dry cloth. If the message is repeated, format the card. If the message persists, replace the card. • Incompatible memory card: Use a compatible card. • Camera malfunction: Contact a FUJIFILM dealer.
PROTECTED CARD	The memory card is locked. Unlock the card.
BUSY	The memory card is incorrectly formatted. Use the camera to format the card.
 MEMORY FULL	The memory card is full and pictures cannot be recorded. Delete pictures or insert a memory card with more free space.
WRITE ERROR	<ul style="list-style-type: none"> • Memory card error or connection error: Reinsert the card or turn the camera off and then on again. If the message persists, contact a FUJIFILM dealer.

Warning	Description
WRITE ERROR (continued)	<ul style="list-style-type: none"> • Not enough memory remaining to record additional pictures: Delete pictures or insert a memory card with more free space. • The memory card is not formatted: Format the memory card.
FRAME NO. FULL	<p>The camera has run out of frame numbers (current frame number is 999-9999). Insert a formatted memory card and select RENEW for  SAVE DATA SET-UP > FRAME NO.. Take a picture to reset frame numbering to 100-0001, then select CONTINUOUS for FRAME NO..</p>
READ ERROR	<ul style="list-style-type: none"> • The file is corrupt or was not created with the camera: The file cannot be viewed. • The memory card contacts require cleaning: Clean the contacts with a soft, dry cloth. If the message is repeated, format the card. If the message persists, replace the card. • Camera malfunction: Contact a FUJIFILM dealer.
PROTECTED FRAME	<p>An attempt was made to delete or rotate to a protected picture. Remove protection and try again.</p>
CAN NOT CROP	<p>The picture is damaged or was not created with the camera.</p>
DPOF FILE ERROR	<p>Print orders can contain no more than 999 pictures. Copy any additional pictures you wish to print to another memory card and create a second print order.</p>
CAN NOT ROTATE	<p>The selected picture cannot be rotated.</p>

Warning	Description
 CAN NOT ROTATE	Movies cannot be rotated.
CAN NOT SET DPOF	The picture cannot be printed using DPOF.
 CAN NOT SET DPOF	Movies cannot be printed using DPOF.
 CANNOT EXECUTE	Red-eye removal cannot be applied to movies.
 CANNOT EXECUTE	Red-eye removal cannot be applied to pictures created with other devices.
MISMATCH: 4K MODE AND EXTERNAL MONITOR CHANGE MOVIE MODE	The movie mode selected with the camera is not compatible with the device to which the camera is connected via HDMI. Try selecting a different movie mode.
 (yellow)	Turn the camera off and wait for it to cool. Mottling may increase in pictures taken when this warning is displayed.
 (red)	Turn the camera off and wait for it to cool. While this warning is displayed, movies cannot be recorded, mottling may increase, and performance, including frame advance rate and display quality, may drop.

Memory Card Capacity

The following table shows the recording time or number of pictures available at different image sizes. All figures are approximate; file size varies with the scene recorded, producing wide variations in the number of files that can be stored. The number of exposures or length remaining may not diminish at an even rate.

		Capacity	8 GB		16 GB	
			FINE	NORMAL	FINE	NORMAL
Photos	 3:2		540	800	1110	1660
	RAW (UNCOMPRESSED)		150		320	
	RAW (LOSSLESS COMPRESSED)		300		630	
Movies ¹	 2160/29.97P, 25P, 24P, 23.98P ²		9 minutes		20 minutes	
	 1080/59.94P, 50P, 29.97P, 25P, 24P, 23.98P ³		26 minutes		54 minutes	
	 720/59.94P, 50P, 29.97P, 25P, 24P, 23.98P ⁴		51 minutes		105 minutes	

1 Use a UHS speed class 3 card or better.

2 Individual movies cannot exceed 10 minutes in length, or 30 minutes if filmed using a power booster grip.

3 Individual movies cannot exceed 15 minutes in length, or 30 minutes if filmed using a power booster grip.

4 Individual movies cannot exceed 30 minutes in length.

 Although movie recording will continue without interruption when the file size reaches 4GB, subsequent footage will be recorded to a separate file which must be viewed separately.

Specifications

System

Model	FUJIFILM X-E3									
Product Number	FF170001									
Effective pixels	Approx. 24.3 million									
Image sensor	23.5 mm × 15.6 mm (APS-C), X-Trans CMOS III sensor with primary color filter									
Storage media	FUJIFILM-recommended SD/SDHC/SDXC memory cards									
Memory card slot	SD memory card slot (UHS-1)									
File system	Compliant with Design Rule for Camera File System (DCF), Exif 2.3, and Digital Print Order Format (DPOF)									
File format	<ul style="list-style-type: none">• Still pictures: Exif 2.3 JPEG (compressed); RAW (original RAF format, uncompressed or compressed using a lossless algorithm; special purpose software required); RAW+JPEG available• Movies: H.264 standard with stereo sound (MOV)• Voice memo: Stereo (WAVE)									
Image size	<table><tr><td>L 3:2 (6000 × 4000)</td><td>L 16:9 (6000 × 3376)</td><td>L 1:1 (4000 × 4000)</td></tr><tr><td>M 3:2 (4240 × 2832)</td><td>M 16:9 (4240 × 2384)</td><td>M 1:1 (2832 × 2832)</td></tr><tr><td>S 3:2 (3008 × 2000)</td><td>S 16:9 (3008 × 1688)</td><td>S 1:1 (2000 × 2000)</td></tr></table> <p>RAW (6000 × 4000)</p> <p>L panorama: vertical (2160 × 9600)/horizontal (9600 × 1440)</p> <p>M panorama: vertical (2160 × 6400)/horizontal (6400 × 1440)</p>	L 3:2 (6000 × 4000)	L 16:9 (6000 × 3376)	L 1:1 (4000 × 4000)	M 3:2 (4240 × 2832)	M 16:9 (4240 × 2384)	M 1:1 (2832 × 2832)	S 3:2 (3008 × 2000)	S 16:9 (3008 × 1688)	S 1:1 (2000 × 2000)
L 3:2 (6000 × 4000)	L 16:9 (6000 × 3376)	L 1:1 (4000 × 4000)								
M 3:2 (4240 × 2832)	M 16:9 (4240 × 2384)	M 1:1 (2832 × 2832)								
S 3:2 (3008 × 2000)	S 16:9 (3008 × 1688)	S 1:1 (2000 × 2000)								
Lens mount	FUJIFILM X mount									

System**Sensitivity**

- **Still pictures:** Standard output sensitivity equivalent to ISO 200–12800 in increments of $\frac{1}{3}$ EV; AUTO; extended output sensitivity equivalent to ISO 100, 125, 160, 25600, or 51200
- **Movies:** Standard output sensitivity equivalent to ISO 200–12800 in increments of $\frac{1}{3}$ EV; AUTO

Metering

256-segment through-the-lens (TTL) metering; MULTI, SPOT, AVERAGE, CENTER WEIGHTED

Exposure control

Programmed AE (with program shift); shutter-priority AE; aperture-priority AE; manual exposure

Exposure compensation

- **Still pictures:** –5 EV–+5 EV in increments of $\frac{1}{3}$ EV
- **Movies:** –2 EV–+2 EV in increments of $\frac{1}{3}$ EV

Shutter speed

	Mode P	Mode A	Modes S and M	Bulb
Mechanical shutter	4 s to $\frac{1}{4000}$ S	30 s to $\frac{1}{4000}$ S	15 min. to $\frac{1}{4000}$ S	Max. 60 min.
Electronic shutter	4 s to $\frac{1}{32000}$ S	30 s to $\frac{1}{32000}$ S	15 min. to $\frac{1}{32000}$ S	Fixed at 1 s
Mechanical+ electronic	4 s to $\frac{1}{32000}$ S	30 s to $\frac{1}{32000}$ S	15 min. to $\frac{1}{32000}$ S	Max. 60 min.

System

Continuous

Frame rate (JPEG)	Frames per burst
14 fps*	Up to approximately 35
11 fps*	Up to approximately 50
8.0 fps	Up to approximately 53
5.0 fps	Up to approximately 56
4.0 fps	Up to approximately 58
3.0 fps	Up to approximately 62

* Available with electronic shutter only.



The frame rate varies with shooting conditions and the number of images recorded. In addition, the frame rate and number of frames per burst may vary depending on the type of memory card used.

Focus

- **Mode:** Single or continuous AF; manual focus with focus ring
- **Focus-area selection:** SINGLE POINT, ZONE, WIDE/TRACKING, ALL
- **Autofocus system:** Intelligent hybrid AF (TTL contrast-detect/phase-detection AF) with AF-assist illuminator



















White balance

Custom 1, Custom 2, Custom 3, color temperature selection, auto, direct sunlight, shade, daylight fluorescent, warm white fluorescent, cool white fluorescent, incandescent, underwater

Self-timer

Off, 2 sec., 10 sec.

System

Flash mode	<ul style="list-style-type: none"> • MODE: TTL MODE (FLASH AUTO, STANDARD, SLOW SYNC.), MANUAL, COMMANDER, OFF • SYNC. MODE: 1ST CURTAIN, 2ND CURTAIN • RED EYE REMOVAL:  FLASH+REMOVAL,  FLASH,  REMOVAL, OFF 		
Hot shoe	Accessory shoe with TTL contacts		
Sync contact	X contact; supports sync speeds as fast as $\frac{1}{180}$ s		
Viewfinder	0.39-in., 2,360k-dot color OLED viewfinder with diopter adjustment (-4 to $+2$ m $^{-1}$); magnification 0.62 \times with 50 mm lens (35 mm format equivalent) at infinity and diopter set to -1.0 m $^{-1}$; diagonal angle of view approximately 30.0° (horizontal angle of view approximately 25.0°); eye point approx. 17.5 mm		
LCD monitor	Fixed 3.0-in./7.6 cm, 1040k-dot color touch-screen LCD monitor		
Movies	 2160/29.97P	 1080/59.94P	 720/59.94P
(with stereo sound)	 2160/25P	 1080/50P	 720/50P
	 2160/24P	 1080/29.97P	 720/29.97P
	 2160/23.98P	 1080/25P	 720/25P
		 1080/24P	 720/24P
		 1080/23.98P	 720/23.98P

Input/output terminals

Digital input/output	USB 2.0 High-Speed Micro USB connector (Micro-B)
HDMI output	HDMI Micro connector (Type D)
Microphone/remote release connector	∅2.5 mm 3-pole mini jack

Power supply/other

Power supply	NP-W126S rechargeable battery (supplied with camera)
Camera size (W × H × D)	121.3 mm × 73.9 mm × 42.7 mm (32.4 mm excluding projections, measured at thinnest part)/ 4.78 in. × 2.91 in. × 1.68 in. (1.28 in.)
Camera weight	Approx. 287 g/10.1 oz., excluding battery, accessories, and memory card
Shooting weight	Approx. 337 g/11.9 oz., including battery and memory card
Operating conditions	<ul style="list-style-type: none">• Temperature: 0 °C to +40 °C/ +32 °F to +104 °F• Humidity: 10% to 80% (no condensation)



Power supply/other

Battery life

- **Battery type:** NP-W126S
- **Photographs:** The number of frames varies with the option selected for **PERFORMANCE:**

PERFORMANCE	LCD	EVF
HIGH PERFORMANCE	Approx. 260	Approx. 260
STANDARD	Approx. 350	Approx. 350

- **Movies:** The length of footage that can be recorded varies with the movie mode:

Mode	Actual Battery life of movie capture	Continuance Battery life of movie capture
	Approx. 50 minutes	Approx. 70 minutes
	Approx. 60 minutes	Approx. 95 minutes

CIPA standard, measured in mode **P**, using fully charged battery (NP-W126S), XF35mmF1.4 R lens, and SD memory card.

Note: Battery life varies with battery charge level and will decline at low temperatures.

Wireless transmitter

Wireless LAN

Standards	IEEE 802.11b/g/n (standard wireless protocol)
Operating frequency (center frequency)	<ul style="list-style-type: none">• U. S. A., Canada, Taiwan: 2,412 MHz–2,462 MHz (11 channels)• Other countries: 2,412 MHz–2,472 MHz (13 channels)
Access protocols	Infrastructure

Bluetooth®

Standards	Bluetooth version 4.0 (Bluetooth Low Energy)
Operating frequency (center frequency)	2,402 MHz–2,480 MHz

EF-X8 shoe-mounted flash unit

Guide number	GN8 (ISO100), GN11 (ISO200)
Dimensions (W × H × D)	39.7 mm × 24.2 mm × 63.4 mm/ 1.6 in. × 1.0 in. × 2.5 in.
Weight	Approx. 41 g/1.4 oz.

NP-W126S rechargeable battery

Nominal voltage	7.2 V
Nominal capacity	1260 mAh
Operating temperature	0 °C to +40 °C/ +32 °F to +104 °F
Dimensions (W × H × D)	36.4 mm × 47.1 mm × 15.7 mm/ 1.4 in. × 1.9 in. × 0.6 in.
Weight	Approx. 47 g/1.7 oz.

BC-W126 battery charger

Rated input	100V – 240V AC, 50/60 Hz
Input capacity	13 – 21 VA
Rated output	8.4V DC, 0.6 A
Supported batteries	NP-W126S rechargeable batteries
Charging time	Approx. 150 minutes (+20 °C/+68 °F)
Operating temperature	5 °C to +40 °C/ +41 °F to +104 °F
Dimensions (W × H × D)	65 mm × 91.5 mm × 28 mm/ 2.6 in. × 3.6 in. × 1.1 in., excluding projections
Weight	Approx. 77 g/2.7 oz.

Weight and dimensions vary with the country or region of sale. Labels, menus, and other displays may differ from those on the actual camera.



Specifications and performance are subject to change without notice. FUJIFILM will not be held liable for any errors this manual may contain. The appearance of the product may differ from that described in this manual.

FUJIFILM

FUJIFILM Corporation

7-3, AKASAKA 9-CHOME, MINATO-KU, TOKYO 107-0052, JAPAN

http://www.fujifilm.com/products/digital_cameras/index.html

