



LG

Life's Good

ENGLISH

OWNER'S MANUAL

LED LCD MONITOR

Please read this manual carefully before operating your set and retain it for future reference.

LED LCD MONITOR MODELS

E1951S	E1951T	E2251VR	E2251VQ
E2051S	E2051T	E2351VR	E2351VQ
E2251S	E2251T		
	E2351T		

CONTENTS

3 ASSEMBLING AND PREPARING

- 3 Unpacking
- 4 Parts and buttons
- 6 Setting up the Monitor set
 - 6 - Attaching the Stand Base
 - 6 - Detaching the Stand Base
 - 6 - Detaching the Stand Body (Using the Wall mount)
- 7 - Mounting on a table
- 9 - Mounting on a wall

- 26 - HDMI Timing
- 26 Indicator

27 PROPER POSTURE

- 27 Proper posture for using the Monitor set.

10 USING THE MONITOR SET

- 10 Connecting to a PC
 - 10 - D-SUB connection
 - 11 - DVI-D connection
 - 12 - HDMI connection

13 CUSTOMIZING SETTINGS

- 13 Accessing The Main Menus
- 14 Customizing Settings
 - 14 - Menu Settings
 - 15 - SUPER ENERGY SAVING Settings
 - 16 - SUPER+ RESOLUTION Settings
 - 16 - Volume Settings (Only supported in HDMI)
 - 17 - DUAL MONITOR Settings
 - 17 - DUAL WEB Settings

18 TROUBLESHOOTING

20 SPECIFICATIONS

- 25 Preset Modes (Resolution)
 - 25 - D-SUB / DVI Timing

ASSEMBLING AND PREPARING

Unpacking

Check your product box for the following items. If there are any missing accessories, contact the local dealer where you purchased your product. The illustrations in this manual may differ from the actual product and accessories.

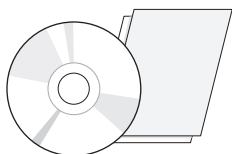

**CD(Owner's Manual) /
Card**

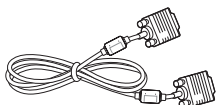

D-SUB Cable

(This signal cable may be attached
to this product before shipping out.)

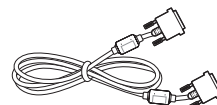

DVI-D Cable

(This cable is not included in all
countries.)

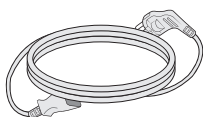

Power Cord

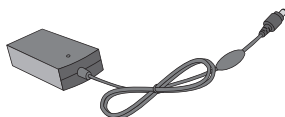

AC-DC Adapter

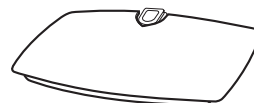

Stand Base



CAUTION

- Do not use any unapproved accessories to ensure the safety and product life span.
- Any damages or injuries by using unapproved accessories are not covered by the warranty.



NOTE

- The accessories supplied with your product may vary depending on the model.
- Product specifications or contents in this manual may be changed without prior notice due to upgrade of product functions.
- User should use shielded signal interface cables (RGB cable / DVI-D cable) with ferrite cores to maintain standard compliance for the product.

Parts and buttons

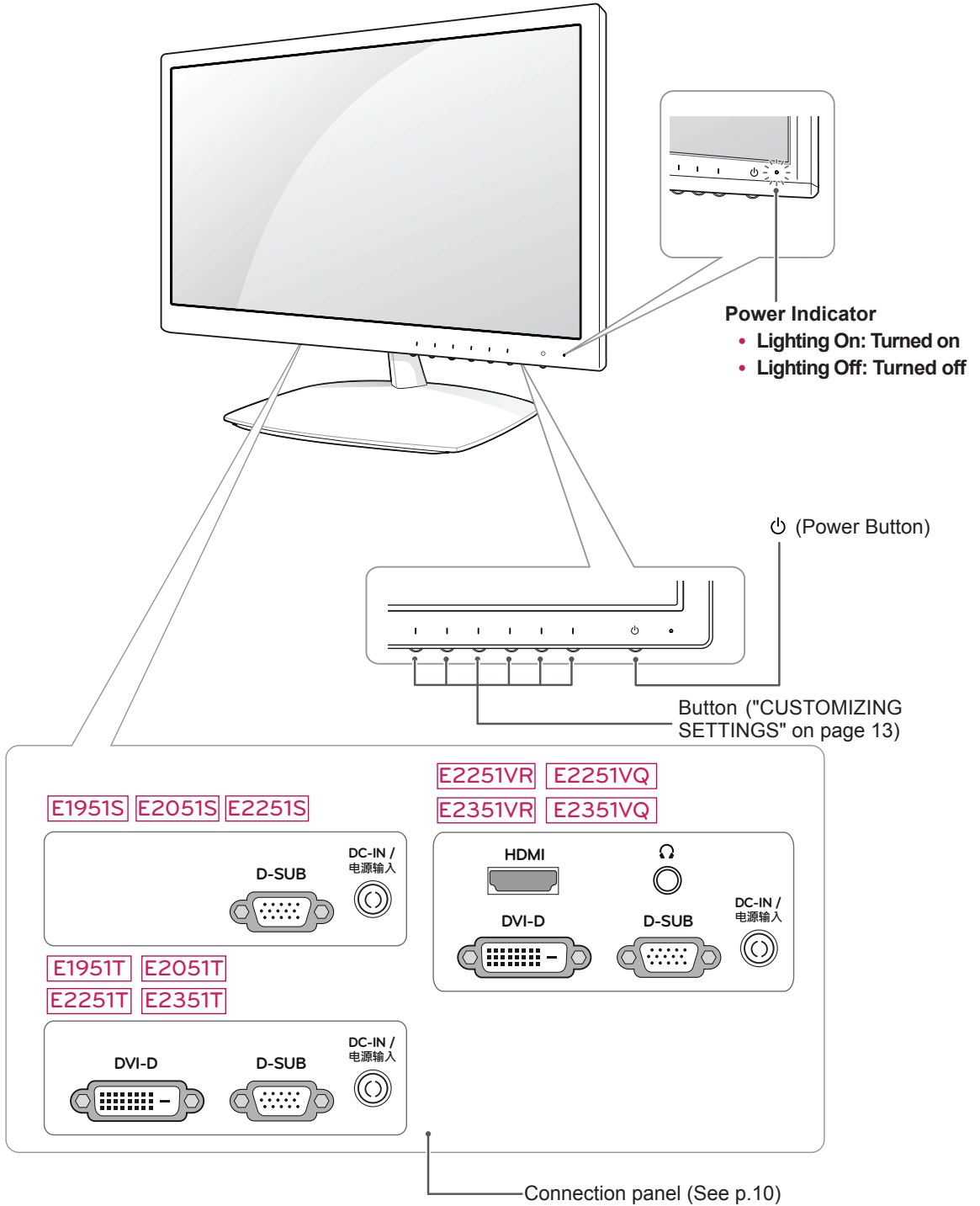

Button	Description						
MENU	Accesses the main menus.(See p.14)						
Left First Button	<p>OSD LOCKED/ UNLOCKED</p> <p>This function allows you to lock the current control settings, so that they cannot be inadvertently changed. Press and hold the Left First Button for several seconds. The message "OSD LOCKED" should appear. You can unlock the OSD controls at any time by pushing the Left First Button for several seconds. The message "OSD UNLOCKED" should appear.</p>						
SUPER+ RESOLUTION	Use this button to enter SUPER+ RESOLUTION menu. For more information.(See p.16)						
DUAL	Use this button to enter DUAL menu. For more information.(See p.17)						
AUTO	<p>When adjusting your display settings, always press the AUTO button on the MONITOR SETUP OSD. (Only supported in Analog Mode)</p> <p>The best display mode</p> <table border="1"> <tbody> <tr> <td>E1951S / E1951T</td> <td>1366 x 768</td> </tr> <tr> <td>E2051S / E2051T</td> <td>1600 x 900</td> </tr> <tr> <td>E2251S / E2251T E2251VR / E2251VQ E2351T / E2351VR E2351VQ</td> <td>1920 x 1080</td> </tr> </tbody> </table>	E1951S / E1951T	1366 x 768	E2051S / E2051T	1600 x 900	E2251S / E2251T E2251VR / E2251VQ E2351T / E2351VR E2351VQ	1920 x 1080
E1951S / E1951T	1366 x 768						
E2051S / E2051T	1600 x 900						
E2251S / E2251T E2251VR / E2251VQ E2351T / E2351VR E2351VQ	1920 x 1080						
VOLUME (Only HDMI mode)	<p>Adjust the volume of the Monitor set.(See p.16)</p> <p>E2251VR / E2351VR / E2251VQ / E2351VQ</p>						
INPUT	<p>You can choose the input signal.</p> <ul style="list-style-type: none"> • When two input signals are at least are connected, you can select the input signal (D-SUB/DVI/HDMI) you want. • When only one signal is connected, it is automatically detected. The default setting is D-SUB. 						
EXIT	Exit the OSD(On Screen Display).						
⏻ (Power Button)	<p>Turns the power on or off.</p> <p>Power Indicator</p> <p>The power indicator stays blue if the display is running properly (On Mode). If the display is in Sleep Mode, the power indicator blinks blue.</p>						

Setting up the Monitor set

Attaching the Stand Base

- 1 Place the Monitor set with the screen side down on a flat and cushioned surface.



CAUTION

Lay a foam mat or soft protective cloth on the surface to protect the screen from damage.

- 2 Attach the **Stand Base** into the Monitor set by turning the **Screw** to the right.

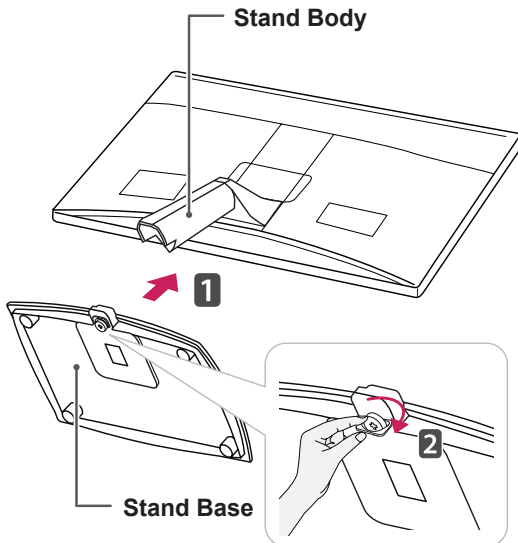

CAUTION

- This illustration depicts the general model of connection. Your monitor may differ from the items shown in the picture.
- Do not carry the product upside down holding only the stand base. The product may fall and get damaged or injure your foot.

Detaching the Stand Base

- 1 Place the Monitor set with the screen side down on a flat and cushioned surface.
- 2 Turn the screw to the left, and then pull out the **Stand Base** from the **Stand Body**.

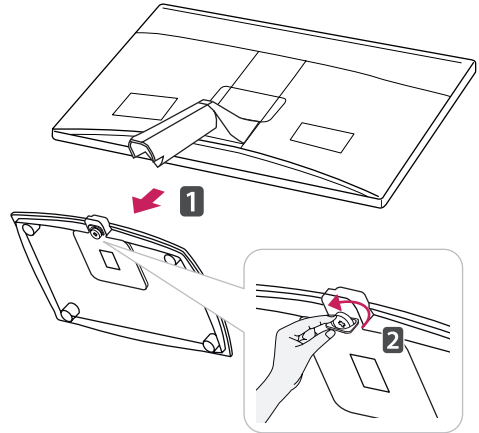

Detaching the Stand Body (Using the Wall mount)

- 1 Remove 2 screws and pull out the Hinge Cover from the Monitor set.

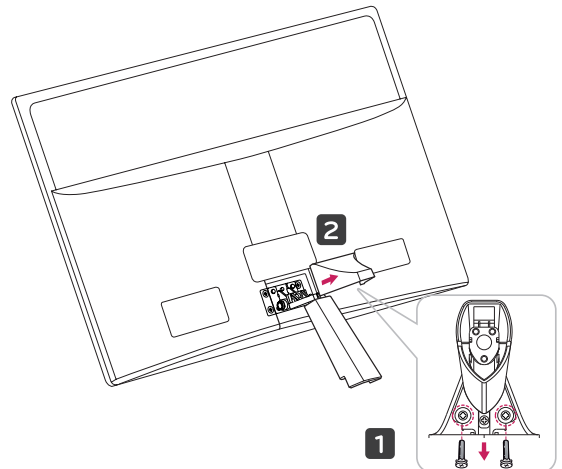

- 2 Remove 4 screws and pull out the Stand Body from the Monitor set.

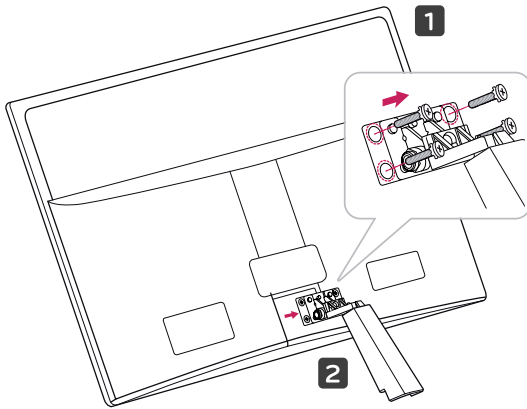

- 2 Connect the AC-DC Adapter and Power Cord to a wall outlet.

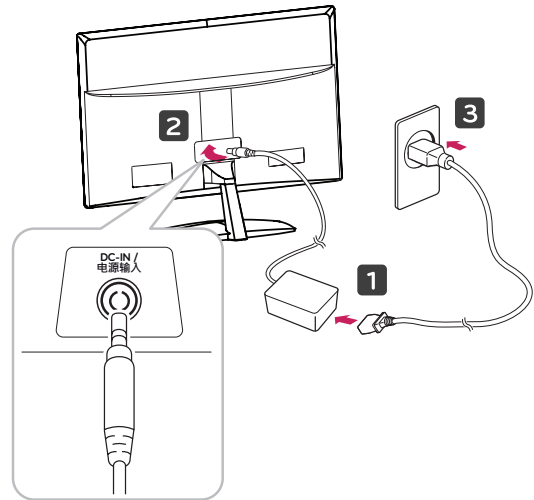

- 3 Press Power button on the front switch of panel to turn the power on.

Mounting on a table

- 1 Lift and tilt the Monitor set into its upright position on a table.
Leave a 10 cm (minimum) space from the wall for proper ventilation.

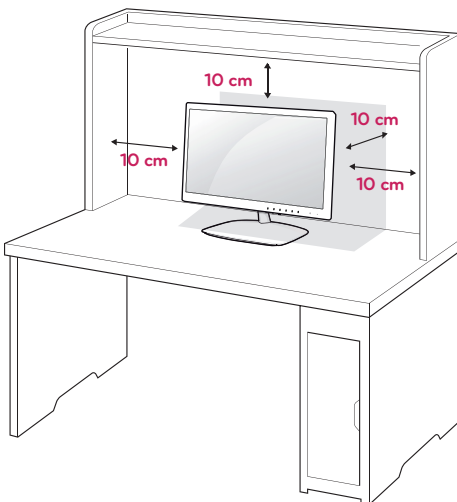

CAUTION

Disconnect the power cord first, and then move or install the Monitor set. Otherwise electric shock may occur.

WARNING

When you adjust the angle, do not hold the bottom of the Monitor set frame as shown on the following illustration, as may injure your fingers.

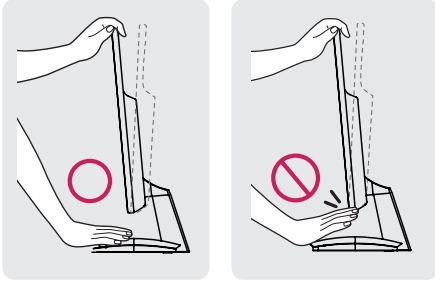

Do not touch or press the screen when adjusting the angle of the monitor.

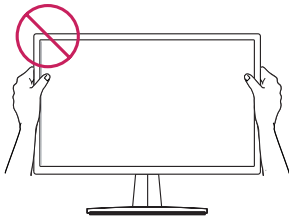
**NOTE**

Tilt from +15 to -5 degrees up or down to adjust the angle of the Monitor set to suit your view.

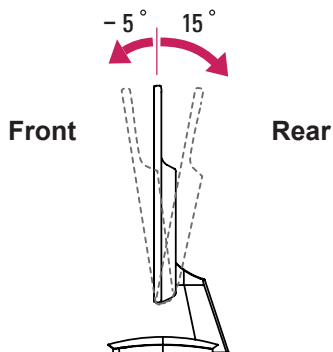
**Using the Kensington security system**

The Kensington security system connector is located at the back of the Monitor set. For more information of installation and using, refer to the

manual supplied with the Kensington security system or visit <http://www.kensington.com>.

Connect the Kensington security system cable between the Monitor set and a table.

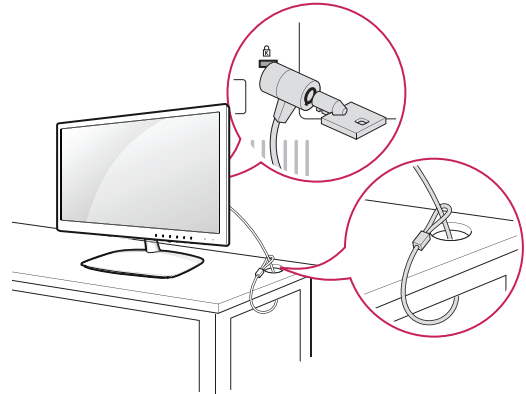
**NOTE**

The Kensington security system is optional. You can obtain it from most electronics stores.

Mounting on a wall

For proper ventilation, allow a clearance of 10 cm on each side and from the wall. Detailed instructions are available from your dealer, see the optional Tilt Wall Mounting Bracket Installation and Setup Guide.

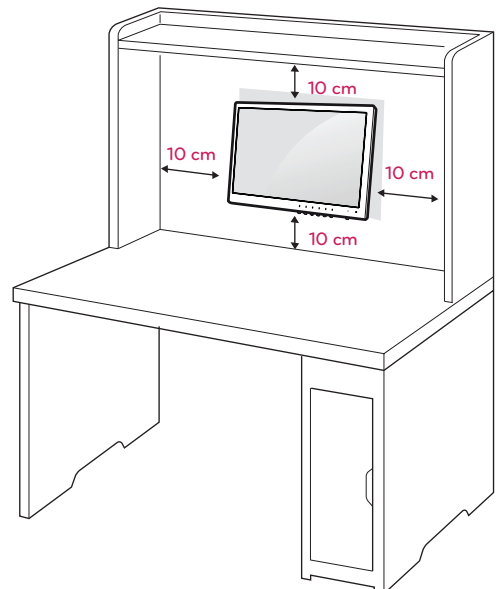

If you intend to mount the Monitor set to a wall, attach Wall mounting interface (optional parts) to the back of the set.

When you install the Monitor set using the wall mounting interface (optional parts), attach it carefully so it will not drop.

- 1 Please, Use the screw and wall mount interface in accordance with VESA Standards.
- 2 If you use screw longer than standard, the monitor might be damaged internally.
- 3 If you use improper screw, the product might be damaged and drop from mounted position. In this case, LG Electronics is not responsible for it.
- 4 VESA compatible only with respect to screw mounting interface dimensions and mounting screw specifications.
- 5 Please use VESA standard as below.
 - 784.8 mm (30.9 inch) and under
 - * Wall Mount Pad Thickness : 2.6 mm
 - * Screw : Φ 4.0 mm x Pitch 0.7 mm x Length 10 mm
 - 787.4 mm (31.0 inch) and above
 - * Please use VESA standard wall mount pad and screws.



CAUTION

- Disconnect the power cord first, and then move or install the Monitor set. Otherwise electric shock may occur.
- If you install the Monitor set on a ceiling or slanted wall, it may fall and result in severe injury.
- Use only an authorized LG wall mount and contact the local dealer or qualified personnel.
- Do not over tighten the screws as this may cause damage to the Monitor set and void your warranty.
- Use only screws and wall mounts that meet the VESA standard. Any damages or injuries by misuse or using an improper accessory are not covered by the warranty.



NOTE

- Use the screws that are listed on the VESA standard screw specifications.
- The wall mount kit will include an installation manual and necessary parts.
- The wall mount bracket is optional. You can obtain additional accessories from your local dealer.
- The length of screws may differ depending on the wall mount. Be sure to use the proper length.
- For more information, refer to the instructions supplied with the wall mount.

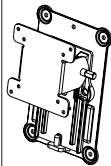
Model	E1951S	E2351T
	E2051S	E2251VR
	E2251S	E2351VR
	E1951T	E2251VQ
	E2051T	E2351VQ
	E2251T	
	VESA (A x B)	75 x 75
Standard screw	M4	
Number of screws	4	
Wall mount bracket (optional)	RW120 	

- VESA (A x B)

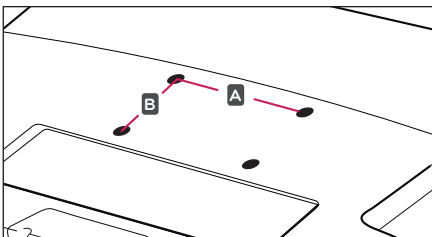

USING THE MONITOR SET

Connecting to a PC

- Your Monitor set supports Plug & Play*.
- *Plug & Play: A PC recognizes a connected device that users connect to a PC and turn on, without device configuration or user intervention.

D-SUB connection

Transmits analog video from your PC to the Monitor set. Connect the PC and the Monitor set with the supplied D-sub 15 pin signal cable as shown in the following illustrations.

E2251VR E2351VR E2251VQ E2351VQ

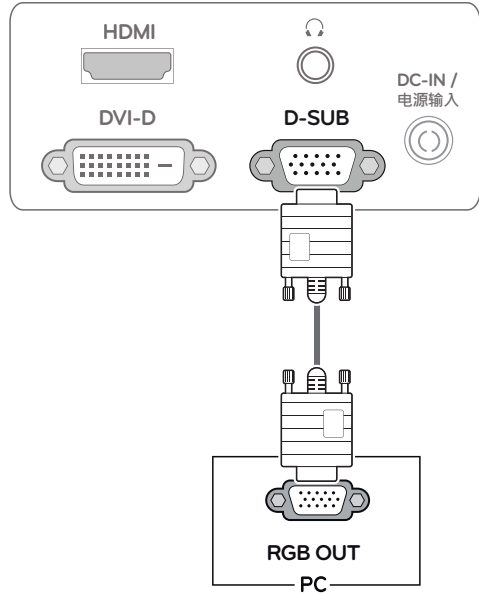

E1951S E2051S E2251S

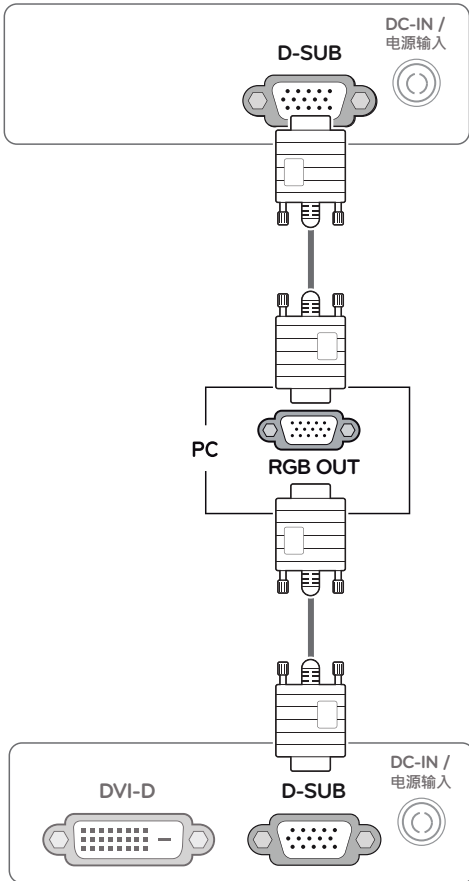

E1951T E2051T E2251T E2351T

NOTE

- When using a D-Sub signal input cable connector for Macintosh

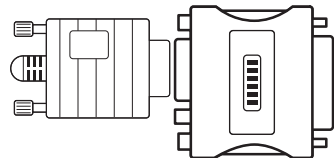

Mac adapter

For Apple Macintosh use, a separate plug adapter is needed to change the 15 pin high density (3 row) D-SUB VGA connector on the supplied cable to a 15 pin 2 row connector.

DVI-D connection

Transmits a digital video signal from your PC to the Monitor set. Connect the PC and the Monitor set with a DVI cable as shown in the following illustrations.

E1951T **E2051T** **E2251T** **E2351T**

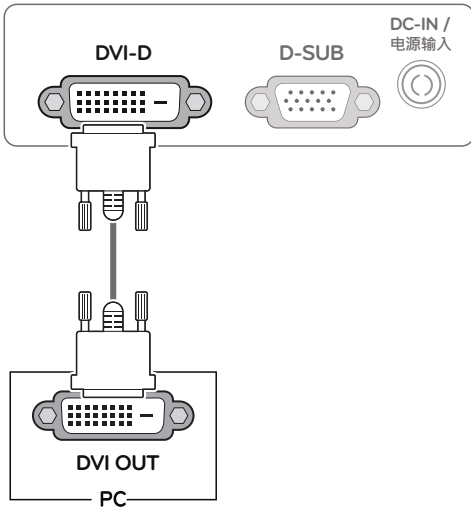

E2251VR **E2351VR** **E2251VQ** **E2351VQ**

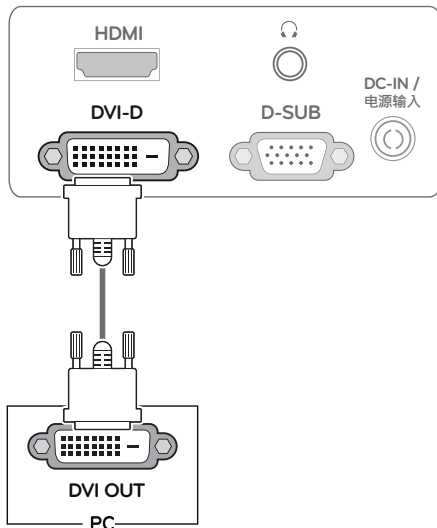

CAUTION

- Connect the signal input cable and tighten it by turning the screws clockwise.
- Do not press the screen with your finger for a long time as this may result in temporary distortion on the screen.
- Avoid displaying a fixed image on the screen for a long period of time to prevent image burn. Use a screensaver if possible.

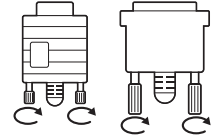

HDMI connection

Transmits the digital video and audio signals from your PC or A/V to the Monitor set. Connect the PC or A/V and the Monitor set with the HDMI cable as shown in the following illustrations.

E2251VR E2351VR E2251VQ E2351VQ

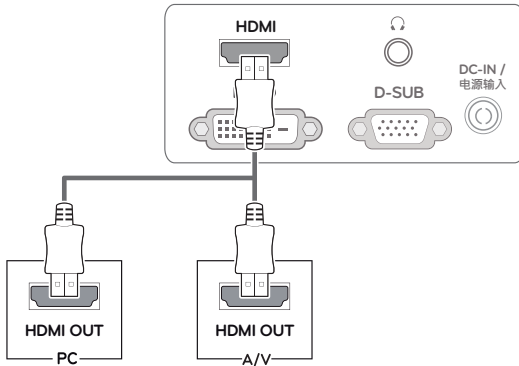

! NOTE

- If you use HDMI PC, it can cause compatibility problem.
- When you want to use two PC in our Monitor, please connect the signal cable(D-SUB/ DVI-D/HDMI) respectively in Monitor set.
- If you turn the Monitor set on while it is cold, the screen may flicker. This is normal.
- Some red, green, or blue spots may appear on the screen. This is normal.

Self Image Setting Function

Press the power button on the front panel to turn the power on. When monitor power is turned on, the **"Self Image Setting"** Function is executed automatically. (Only supported in Analog Mode)

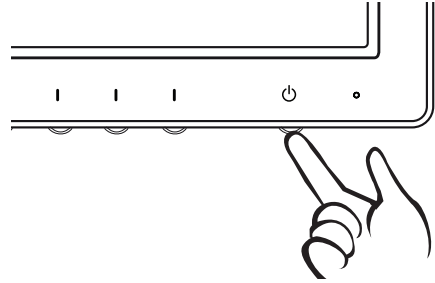

! NOTE

- **"Self Image Setting" Function.**
This function provides the user with optimal display settings. When the user connects the monitor for the first time, this function automatically adjusts the display to optimal settings for individual input signals. (Only supported in Analog Mode)
- **'AUTO' Function.**
When you encounter problems such as blurry screen, blurred letters, screen flicker or tilted screen while using the device or after changing screen resolution, press the AUTO function button to improve resolution. (Only supported in Analog Mode)

CUSTOMIZING SETTINGS

Accessing The Main Menus

- 1 Press any button on the front of the Monitor set to display the **MONITOR SETUP** OSD menu.
- 2 Press the desired menu item.
- 3 Change the value of the menu item by pressing the buttons on the front of the Monitor set.
To return to the upper menu or set other menu items, use the up arrow (↑) button.
- 4 Select **EXIT** to leave the OSD menu.

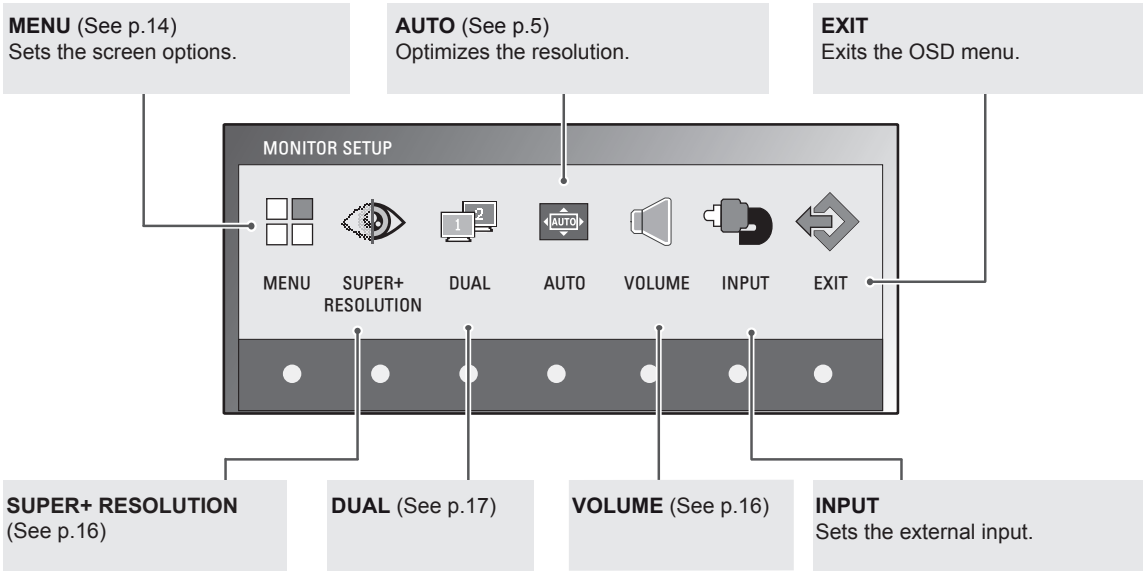
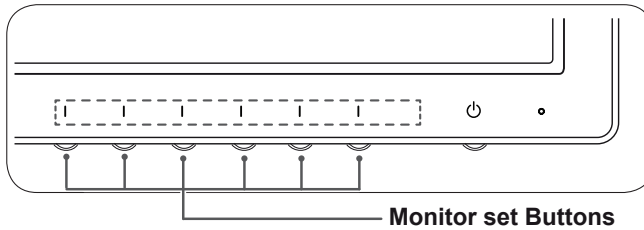

NOTE

Different menu items are enabled depending on the type of input signal and model.

	Menu	SUPER+ RESOLUTION	DUAL	AUTO	VOLUME	INPUT	EXIT
E1951S / E2051S / E22551S	•	-	•	•	-	-	•
E1951T / E2051T / E2251T / E2351T	•	-	•	•	-	•	•
E2251VR / E2351VR	•	•	•	•	-	•	•
E2251VR / E2351VR (Only HDMI Mode)	•	•	•	-	•	•	•
E2251VQ / E2351VQ	•	-	•	•	-	•	•
E2251VQ / E2351VQ (Only HDMI Mode)	•	-	•	-	•	•	•

Customizing Settings

Menu Settings

- 1 Press any button on the front of the Monitor set to display the **MONITOR SETUP** OSD menu.
- 2 Press the **MENU** button to display the options in the OSD menu.
- 3 Set the options by pressing the ◀ or ▶ or ▼ buttons.
- 4 Select **EXIT** to leave the OSD menu.
To return to the upper menu or set other menu items, use the up arrow (⬆) button.

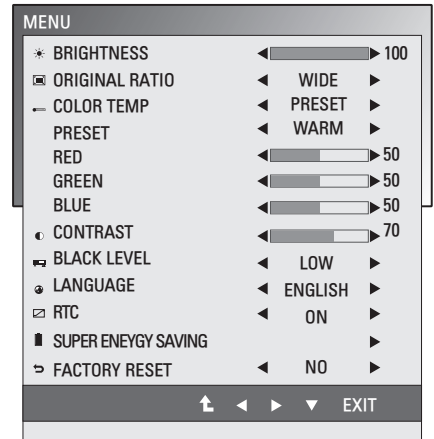

The available MENU settings are described below.

Menu	Analog	Digital	HDMI	Description
BRIGHTNESS	•	•	•	Adjusts the brightness of the screen.
ORIGINAL RATIO	•	•	•	WIDE Switch to full screen mode according to input image signal.
				ORIGINAL Change the input image signal ratio to original. * This function works only if input resolution is lower than Monitor set ratio (16:9).
COLOR TEMP	•	•	•	PRESET Select the screen color. • WARM : Set the screen to warm color temperature (more red). • MEDIUM : Set the screen to medium color temperature. • COOL : Set the screen to cool color temperature (More blue).
				USER • RED : Set your own red color levels. • GREEN : Set your own green color levels. • BLUE : Set your own blue color levels.
CONTRAST	•	•	•	Adjusts the contrast of the screen.
BLACK LEVEL (Only supported in HDMI mode)	-	-	•	You can set the offset level. If you select 'HIGH', the screen will be bright and if you select 'LOW', the screen will be dark. • Offset : As the criteria for video signal, it is the darkest screen the monitor can show.
LANGUAGE	•	•	•	Changes the menu language.
RTC	•	•	•	If you set ON , you enable the Response Time Control function and reduce the afterimage of the screen. If you set OFF , you disable the Response Time Control function and operate at panel response time.
SUPER ENERGY SAVING	•	•	•	Move the SUPER ENERGY SAVING function.
FACTORY RESET	•	•	•	Returns the monitor to original factory settings except "LANGUAGE".

- **Analog**: D-SUB(Analog signal) input.
- **Digital**: DVI-D(Digital signal) input.
- **HDMI**: HDMI(Digital signal) input.

SUPER ENERGY SAVING Settings

- 1 Press any button on the front of the Monitor set to display the **MONITOR SETUP** OSD menu.
- 2 Press the **MENU** button to display the options in the OSD Menu.
- 3 Select **SUPER ENERGY SAVING** by pressing the ▼ button.
- 4 Enter to **SUPER ENERGY SAVING** by pressing the ► button.
- 5 Set the options by pressing ◀ or ▶ buttons.
- 6 Select **EXIT** to leave the OSD menu.
To return to the upper menu or set other menu items, use the up arrow (⬆) button.

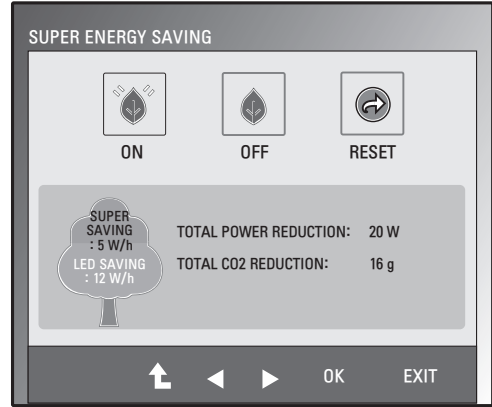

The available SUPER ENERGY SAVING settings are described below.

Menu	Description
ON	Enables SUPER ENERGY SAVING you can save energy with this energy-efficient function.
OFF	Disables SUPER ENERGY SAVING.
RESET	Resets the values of total energy consumption reduction and CO2 emission reduction estimates.

NOTE

- **TOTAL POWER REDUCTION:** How much power is saved while using the monitor.
- **TOTAL CO2 REDUCTION:** Change the TOTAL POWER REDUCTION to CO2.
- **SAVING DATA(W/h)**

	470 mm (18.5 inch)	508 mm (20 inch)	546 mm (21.5 inch)	584 mm (23 inch)
SUPER SAVING	3 W/h	3 W/h	4 W/h	5 W/h
LED SAVING	3 W/h	18 W/h	15 W/h	12 W/h

- Saving Data depends on the Panel. So, those values should be different from each panel and panel vendor.
- LG calculated these values by using “**broadcast video signal**”.
- LED Saving means how much power can be saved using a WLED Panel instead of CCFL panel.
- SUPER SAVING means how much power can be saved using the SUPER ENERGY SAVING function.

SUPER+ RESOLUTION Settings

- 1 Press any button on the front of the Monitor set to display the **MONITOR SETUP** OSD menu.
- 2 Press the **SUPER+ RESOLUTION** button to display the options in the OSD menu.
- 3 Set the options by pressing ◀ or ▶ buttons.
- 4 Select **EXIT** to leave the OSD menu.
To return to the upper menu or set other menu items, use the up arrow (⬆) button.

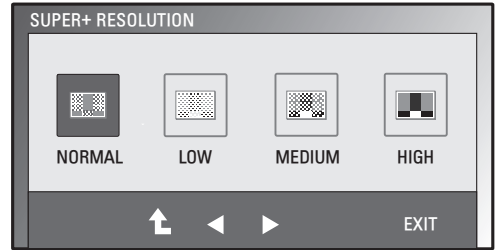

The available SUPER+ RESOLUTION settings are described below.

Menu	Description
NORMAL	Select this when you want to use the product in the most general using environment. In the General mode, the SUPER+ RESOLUTION is turned off.
LOW	When the user wants a natural video screen with soft image, it helps to get the optimized screen. It is effective for video with small movement or still image.
MEDIUM	When the user wants a comfortable video screen at the medium level between low and high mode, it helps to get the optimized screen. It is effective for UCC and SD level videos.
HIGH	When the user wants a sharp video screen with clear images, it helps to get the optimized screen. It is effective for high resolution video screens and games.



NOTE

- Noise may exist according to SR(SUPER+ RESOLUTION) Mode, so enjoy the clear image by selecting SR(SUPER+ RESOLUTION) Mode according to the Contents.

Volume Settings (Only supported in HDMI)

- 1 Press any button on the front of the Monitor set to display the **MONITOR SETUP** OSD menu.
- 2 Press the **VOLUME** button to display the options in the OSD menu.
- 3 Adjust the **VOLUME** by pressing ◀ or ▶ buttons.
- 4 Select **EXIT** to leave the OSD menu.
To return to the upper menu or set other menu items, use the up arrow (⬆) button.

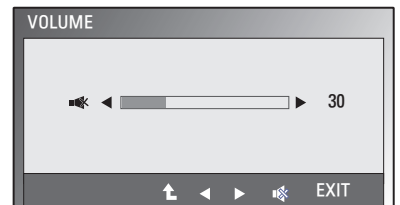

DUAL MONITOR Settings

- 1 Press any button on the front of the Monitor set to display the **MONITOR SETUP** OSD menu.
- 2 Press the **DUAL** button to display the options in the OSD menu.
- 3 Set the options by pressing ▼ and then ◀ and ▶ buttons.
- 4 Select **EXIT** to leave the OSD menu.
To return to the upper menu or set other menu items, use the up arrow (⬆) button.

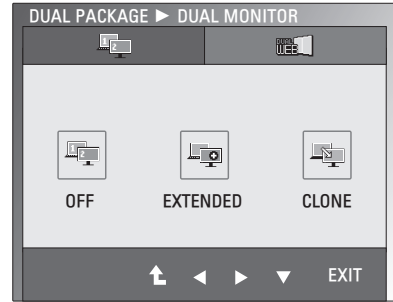

The available DUAL MONITOR settings are described below.

Menu	Description	
DUAL MONITOR	OFF	If select OFF,DUAL MONITOR off
	EXTENDED	By selecting EXETNDED,user can use secondary monitor as extended mode of primary monitor.
	CLONE	By selecting CLONE,user can use secondary monitor as clone mode of primary monitor.

DUAL WEB Settings

- 1 Press any button on the front of the Monitor set to display the **MONITOR WEB** OSD menu.
- 2 Press the **DUAL** button to display the options in the OSD menu.
- 3 Set the options by pressing ▼ and then ◀ and ▶ buttons.
- 4 Select **EXIT** to leave the OSD menu.
To return to the upper menu or set other menu items, use the up arrow (⬆) button.

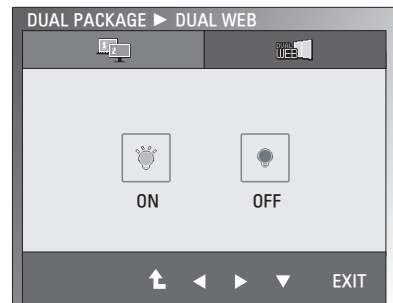

The available DUAL WEB settings are described below.

Menu	Description	
DUAL WEB	ON	Help user to browse web efficiently by dividing in half. Help to arrange and move windows on screen. Help user to control divided windows ratio.
	OFF	If select OFF,DUAL WEB is off.

! NOTE

- When monitor goes to Power Saving Mode with PC power saving option , on pressing any button and selecting Dual option user can bring back monitor to normal mode.

TROUBLESHOOTING

Check the following before calling for service.

No image appears	
Is the power cord of the display connected?	<ul style="list-style-type: none"> Check and see if the power cord is connected properly to the power outlet.
Is the power indicator light on?	<ul style="list-style-type: none"> Press the Power button.
Is the power indicator blinking?	<ul style="list-style-type: none"> If the display is in power saving mode, try moving the mouse or pressing any key on the keyboard to bring up the screen. Try to turn on the PC.
Do you see an "OUT OF RANGE" message on the screen?	<ul style="list-style-type: none"> This message appears when the signal from the PC (video card) is out of horizontal or vertical frequency range of the display. See the 'Specifications' section of this manual and configure your display again.
Do you see a "CHECK SIGNAL CABLE" message on the screen?	<ul style="list-style-type: none"> This message appears when the signal cable between your PC and your display is not connected. Check the signal cable and try again.

Do you see a "OSD LOCKED" message on the screen?	
Do you see "OSD LOCKED" when you push Left First Button?	<ul style="list-style-type: none"> You can secure the current control settings, so that they cannot be inadvertently changed. You can unlock the OSD controls at any time by pushing the Left First Button for several seconds: the message "OSD UNLOCKED" will appear.

Display image is incorrect	
Display Position is incorrect.	<ul style="list-style-type: none"> Press the AUTO button to automatically adjust your display image to the ideal setting.
On the screen background, vertical bars or stripes are visible.	<ul style="list-style-type: none"> Press the AUTO button to automatically adjust your display image to the ideal setting.
Any horizontal noise appearing in any image or characters are not clearly portrayed.	<ul style="list-style-type: none"> Press the AUTO button to automatically adjust your display image to the ideal setting. Check Control Panel ► Display ► Settings and adjust the display to the recommended resolution or adjust the display image to the ideal setting. Set the color setting higher than 24 bits (true color).



CAUTION

- Check **Control Panel ► Display ► Settings** and see if the frequency or the resolution were changed. If yes, readjust the video card to the recommend resolution.
- If the recommended resolution (optimal resolution) is not selected, letters may be blurred and the screen may be dimmed, truncated or biased. Make sure to select the recommend resolution.
- The setting method can differ by computer and O/S (Operation System), and resolution mentioned above may not be supported by the video card performance. In this case, please ask to the computer or the video card manufacturer.

Display image is incorrect	
The screen color is mono or abnormal.	<ul style="list-style-type: none"> • Check if the signal cable is properly connected and use a screwdriver to fasten if necessary. • Make sure the video card is properly inserted in the slot. • Set the color setting higher than 24 bits (true color) at Control Panel ► Settings.
The screen blinks.	<ul style="list-style-type: none"> • Check if the screen is set to interlace mode and if yes, change it to the recommend resolution.

Do you see an "Unrecognized monitor, Plug&Play (VESA DDC) monitor found" message?	
Have you installed the display driver?	<ul style="list-style-type: none"> • Be sure to install the display driver from the display driver CD (or diskette) that comes with your display. Or, you can also download the driver from our web site: http://www.lg.com. • Make sure to check if the video card supports Plug&Play function.

The Audio function is not working	
Picture OK & No sound.	<ul style="list-style-type: none"> • Check whether volume is "0". • Check sound muted. • HDMI cable installed properly. • Head phone cable installed properly. • Check sound format. Not supply to compressed sound format.

SPECIFICATIONS

E1951S

E1951T

Display	Screen Type	47.0 cm (18.5 inch) Flat Panel Active matrix-TFT LCD Anti-Glare coating Visible diagonal size: 47.0 cm
	Pixel Pitch	0.3 mm x 0.3 mm (Pixel Pitch)
Sync Input	Horizontal Frequency	30 kHz to 61 kHz (Automatic)
	Vertical Frequency	56Hz to 75Hz (Automatic)
	Input Form	
	E1951S	Separate Sync.
	E1951T	Separate Sync. Digital
Video Input	Signal Input	
	E1951S	15 pin D-SUB Connector
	E1951T	15 pin D-SUB Connector /DVI-D Connector (Digital)
	Input Form	
	E1951S	RGB Analog (0.7 Vp-p/ 75 ohm)
	E1951T	RGB Analog (0.7 Vp-p/ 75 ohm), Digital
Resolution	Max	
	E1951S	D-SUB(Analog) : 1366 x 768 @ 60 Hz
	E1951T	D-SUB(Analog) / DVI(Digital): 1366 x 768 @ 60 Hz
	Recommend	VESA 1366 x 768 @ 60 Hz
Plug & Play	E1951S	DDC 2B(Analog)
	E1951T	DDC 2B(Analog,Digital)
Power Consumption	On Mode : 17 W(Typ.) Sleep Mode ≤ 0.5 W Off Mode ≤ 0.5 W	
Power Input	12 V $\overline{\text{---}}$ 2.0 A	
AC-DC Adapter	Type ADS-24NP-12-1 12024G, manufactured by HONOR Electronic	
Dimensions (Width x Height x Depth)	With Stand	44.94 cm x 17.26 cm x 35.6 cm
	Without Stand	44.94 cm x 3.35 cm x 27.9 cm
Weight	2 kg	
Tilt Range	-5° to 15°	
Environmental conditions	Operating Temperature	10°C to 35 °C
	Operating Humidity	20 % to 80 % non-Condensing
	Storage Temperature	-10°C to 60 °C
	Storage Humidity	5 % to 90 % non-Condensing
Stand Base	Attached (), Detached (O)	
Power cord	Wall-outlet type	

Product specifications shown above may be changed without prior notice due to upgrade of product functions.

E2051S E2051T

Display	Screen Type	50.8 cm (20.0 inch) Flat Panel Active matrix-TFT LCD Anti-Glare coating Visible diagonal size: 50.8 cm
	Pixel Pitch	0.2766 mm x 0.2766 mm (Pixel Pitch)
Sync Input	Horizontal Frequency	30 kHz to 83 kHz (Automatic)
	Vertical Frequency	56Hz to 75Hz (Automatic)
	Input Form	
	E2051S	Separate Sync.
E2051T	Separate Sync. Digital	
Video Input	Signal Input	
	E2051S	15 pin D-SUB Connector
	E2051T	15 pin D-SUB Connector / DVI-D Connector (Digital)
	Input Form	
	E2051S	RGB Analog (0.7 Vp-p/ 75 ohm)
E2051T	RGB Analog (0.7 Vp-p/ 75 ohm), Digital	
Resolution	Max	
	E2051S	D-SUB(Analog) : 1600 x 900 @ 60 Hz
	E2051T	D-SUB(Analog) / DVI(Digital): 1600 x 900 @ 60 Hz
	Recommend	VESA 1600 x 900 @ 60 Hz
Plug & Play	E2051S	DDC 2B(Analog)
	E2051T	DDC 2B(Analog,Digital)
Power Consumption	On Mode : 21 W(Typ.) Sleep Mode ≤ 0.5 W Off Mode ≤ 0.5 W	
Power Input	12 V  2.0 A	
AC-DC Adapter	Type ADS-24NP-12-1 12024G, manufactured by HONOR Electronic	
Dimensions (Width x Height x Depth)	With Stand	48.28 cm x 17.42 cm x 37.5 cm
	Without Stand	48.28 cm x 3.35 cm x 29.7 cm
Weight	2.197 kg	
Tilt Range	-5° to 15°	
Environmental conditions	Operating Temperature	10°C to 35 °C
	Operating Humidity	20 % to 80 % non-Condensing
	Storage Temperature	-10°C to 60 °C
	Storage Humidity	5 % to 90 % non-Condensing
Stand Base	Attached (<input type="checkbox"/>), Detached (<input type="checkbox"/>)	
Power cord	Wall-outlet type	

Product specifications shown above may be changed without prior notice due to upgrade of product functions.

E2251S

E2251T

Display	Screen Type	54.6 cm (21.5 inch) Flat Panel Active matrix-TFT LCD Anti-Glare coating. Visible diagonal size: 54.6 cm
	Pixel Pitch	0.248 mm x 0.248 mm (Pixel Pitch)
Sync Input	Horizontal Frequency	30 kHz to 83 kHz (Automatic)
	Vertical Frequency	56Hz to 75Hz (Automatic)
	Input Form	
	E2251S	Separate Sync.
	E2251T	Separate Sync. Digital
Video Input	Signal Input	
	E2251S	15 pin D-SUB Connector
	E2251T	15 pin D-SUB Connector / DVI-D Connector (Digital)
	Input Form	
	E2251S	RGB Analog (0.7 Vp-p/ 75 ohm)
	E2251T	RGB Analog (0.7 Vp-p/ 75 ohm), Digital
Resolution	Max	
	E2251S	D-SUB(Analog) : 1920 x 1080 @ 60 Hz
	E2251T	D-SUB(Analog) / DVI(Digital) : 1920 x 1080 @ 60 Hz
	Recommend	VESA 1920 x 1080 @ 60 Hz
Plug & Play	E2251S	DDC 2B(Analog)
	E2251T	DDC 2B(Analog, Digital)
Power Consumption	On Mode : 26 W(Typ.) Sleep Mode ≤ 0.5 W Off Mode ≤ 0.5 W	
Power Input	19 V $\overline{=}$ 2.1 A	
AC-DC Adapter	Type EADP-40LB B, manufactured by Delta Electronics	
Dimensions (Width x Height x Depth)	With Stand	51.75 cm x 18.65 cm x 39.4 cm
	Without Stand	51.75 cm x 3.35 cm x 31.7 cm
Weight	2.477 kg	
Tilt Range	-5° to 15°	
Environmental conditions	Operating Temperature	10°C to 35 °C
	Operating Humidity	20 % to 80 % non-Condensing
	Storage Temperature	-10°C to 60 °C
	Storage Humidity	5 % to 90 % non-Condensing
Stand Base	Attached (), Detached (O)	
Power cord	Wall-outlet type	

Product specifications shown above may be changed without prior notice due to upgrade of product functions.

E2251VR E2251VQ

Display	Screen Type	54.6 cm (21.5 inch) Flat Panel Active matrix-TFT LCD Anti-Glare coating. Visible diagonal size: 54.6 cm
	Pixel Pitch	0.248 mm x 0.248 mm (Pixel Pitch)
Sync Input	Horizontal Frequency	30 kHz to 83 kHz (Automatic)
	Vertical Frequency	56Hz to 75Hz (D-SUB, DVI-D) 56Hz to 61Hz (HDMI)
	Input Form	Separate Sync. Digital. HDMI
Video Input	Signal Input	15 pin D-SUB Connector DVI-D Connector (Digital) HDMI (TYPE - A) Connector
	Input Form	RGB Analog (0.7 Vp-p/ 75 ohm), Digital, HDMI
Resolution	Max	D-SUB(Analog) :1920 x 1080 @ 60 Hz DVI(Digital) / HDMI(Digital) :1920 x 1080 @ 60 Hz
	Recommend	VESA 1920 x 1080 @ 60 Hz
Plug & Play	DDC 2B(Analog, Digital, HDMI)	
Power Consumption	On Mode : 26 W(Typ.) Sleep Mode ≤ 0.5 W Off Mode ≤ 0.5 W	
Power Input	19 V $\overline{\text{---}}$ 2.1 A	
AC-DC Adapter	Type EADP-40LB B, manufactured by Delta Electronics	
Dimensions (Width x Height x Depth)	With Stand	51.75 cm x 18.65 cm x 39.4 cm
	Without Stand	51.75 cm x 3.35 cm x 31.7 cm
Weight	2.477 kg	
Tilt Range	-5° to 15°	
Environmental conditions	Operating Temperature	10°C to 35 °C
	Operating Humidity	20 % to 80 % non-Condensing
	Storage Temperature	-10°C to 60 °C
	Storage Humidity	5 % to 90 % non-Condensing
Stand Base	Attached (), Detached (O)	
Power cord	Wall-outlet type	

Product specifications shown above may be changed without prior notice due to upgrade of product functions.

E2351T
E2351VR
E2351VQ

Display	Screen Type	58.4 cm (23 inch) Flat Panel Active matrix-TFT LCD Anti-Glare coating Visible diagonal size: 58.4 cm
	Pixel Pitch	0.265 mm x 0.265 mm (Pixel Pitch)
Sync Input	Horizontal Frequency	30 kHz to 83 kHz (Automatic)
	Vertical Frequency	
	E2351T	56Hz to 75Hz (Automatic)
	E2351VR / E2351VQ	56Hz to 75Hz (D-SUB, DVI-D) 56Hz to 61Hz (HDMI)
	Input Form	
	E2351T	Separate Sync. Digital
E2351VR / E2351VQ	Separate Sync. Digital. HDMI	
Video Input	Signal Input	
	E2351T	15 pin D-SUB Connector / DVI-D Connector (Digital)
	E2351VR / E2351VQ	15 pin D-SUB Connector / DVI-D Connector (Digital) HDMI (TYPE - A) Connector
	Input Form	
	E2351T	RGB Analog (0.7 Vp-p/ 75 ohm), Digital
E2351VR / E2351VQ	RGB Analog (0.7 Vp-p/ 75 ohm), Digital, HDMI	
Resolution	Max	
	E2351T	D-SUB(Analog) / DVI (Digital) : 1920 x 1080 @ 60 Hz
	E2351VR / E2351VQ	D-SUB(Analog) : 1920 x 1080 @ 60 Hz DVI(Digital) / HDMI(Digital) : 1920 x 1080 @ 60 Hz
	Recommend	VESA 1920 x 1080 @ 60 Hz
Plug & Play	E2351T	DDC 2B(Analog, Digital)
	E2351VR / E2351VQ	DDC 2B(Analog, Digital, HDMI)
Power Consumption	On Mode : 30 W(Typ.) Sleep Mode ≤ 0.5 W Off Mode ≤ 0.5 W	
Power Input	19 V  2.1 A	
AC-DC Adapter	Type EADP-40LB B, manufactured by Delta Electronics	
Dimensions (Width x Height x Depth)	With Stand	54.92 cm x 18.65 cm x 41.2 cm
	Without Stand	54.92 cm x 3.35 cm x 33.5 cm
Weight	2.724 kg	
Tilt Range	-5° to 15°	
Environmental conditions	Operating Temperature	10°C to 35 °C
	Operating Humidity	20 % to 80 % non-Condensing
	Storage Temperature	-10°C to 60 °C
	Storage Humidity	5 % to 90 % non-Condensing
Stand Base	Attached (), Detached (O)	
Power cord	Wall-outlet type	

Product specifications shown above may be changed without prior notice due to upgrade of product functions.

Preset Modes (Resolution)

D-SUB / DVI Timing

E1951S / E1951T

*If you can't select 1366 x 768 in display property timing option, please update your video card driver from your video card vendor.

Display Modes (Resolution)	Horizontal Frequency(kHz)	Vertical Frequency(Hz)	Polarity(H/V)	
720 x 400	31.468	70	-/+	
640 x 480	31.469	60	-/-	
640 x 480	37.500	75	-/-	
800 x 600	37.879	60	+/+	
800 x 600	46.875	75	+/+	
832 x 624	49.725	75	-/-	
1024 x 768	48.363	60	-/-	
1024 x 768	60.123	75	+/+	
1366 x 768	47.712	60	+/+	Recommend Mode

E2051S / E2051T

Display Modes (Resolution)	Horizontal Frequency(kHz)	Vertical Frequency(Hz)	Polarity(H/V)	
720 x 400	31.468	70	-/+	
640 x 480	31.469	60	-/-	
640 x 480	37.500	75	-/-	
800 x 600	37.879	60	+/+	
800 x 600	46.875	75	+/+	
1024 x 768	48.363	60	-/-	
1024 x 768	60.123	75	+/+	
1152 x 864	67.500	75	+/+	
1600 x 900	60.000	60	+/+	Recommend Mode

E2251S / E2251T / E2251VR / E2251VQ / E2351T / E2351VR / E2351VQ

Display Modes (Resolution)	Horizontal Frequency(kHz)	Vertical Frequency(Hz)	Polarity(H/V)	
720 x 400	31.468	70	-/+	
640 x 480	31.469	60	-/-	
640 x 480	37.500	75	-/-	
800 x 600	37.879	60	+/+	
800 x 600	46.875	75	+/+	
1024 x 768	48.363	60	-/-	
1024 x 768	60.123	75	+/+	
1152 x 864	67.500	75	+/+	
1280 x 1024	63.981	60	+/+	
1280 x 1024	79.976	75	+/+	
1680 x 1050	65.290	60	-/+	
1920 x 1080	67.500	60	+/+	Recommend Mode

HDMI Timing

E2251VR / E2251VQ / E2351VR / E2351VQ

Display Modes (Resolution)	Horizontal Frequency(kHz)	Vertical Frequency(Hz)
480P	31.50	60
576P	31.25	50
720P	37.50	50
720P	45.00	60
1080i	28.12	50
1080i	33.75	60
1080P	56.25	50
1080P	67.50	60

Indicator

Mode	LED Color
On Mode	Blue
Sleep Mode	Blinking Blue
Off Mode	Off

PROPER POSTURE

Proper posture for using the Monitor set.

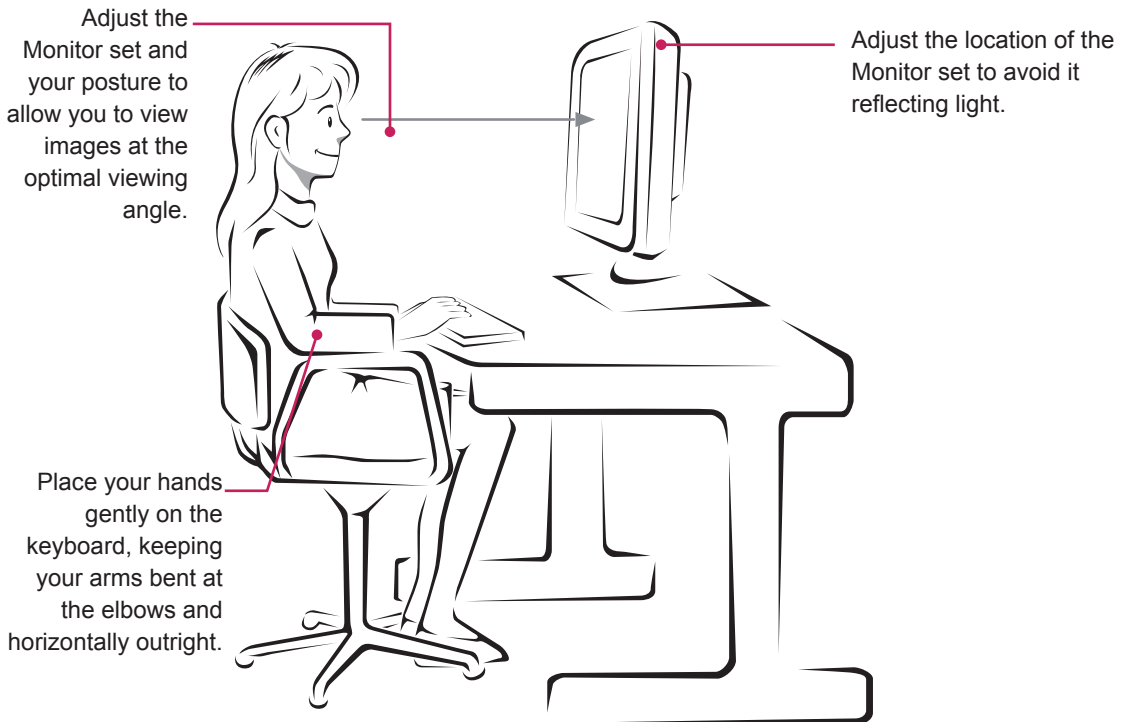



Make sure to read the Safety Precautions before using the product.

Keep the Owner's Manual (CD) in an accessible place for future reference.

The model and serial number of the SET is located on the back and one side of the SET. Record it below should you ever need service.

MODEL _____

SERIAL _____

ENERGY STAR is a set of power-saving guidelines issued by the U.S. Environmental Protection Agency (EPA).



As an ENERGY STAR Partner LGE U. S. A., Inc. has determined that this product meets the ENERGY STAR guidelines for energy efficiency.