

**OSHS89EDC 0 (K)**  
**OSHS89EDC 0 (MI)**  
**OSHS89ED 0 (MI)**



# Operating Instructions

## OVEN

### Contents

Operating Instructions,1
Warnings,2
Description of the appliance,3
Description of the appliance,4
Installation,5
Electrical Connection,5
Oven structure,7
Start-up and use,8
Cooking modes,9
Precautions and tips,15
Maintenance and care,15
Troubleshooting,17
After Sales Service,19
Guarantee,20



Please phone us on  
08448 24 24 24  
to activate your  
guarantee

## Warnings

**WARNING:** The appliance and its accessible parts become hot during use. Care should be taken to avoid touching heating elements. Children less than 8 years of age shall be kept away unless continuously supervised. This appliance can be used by children aged from 8 years and above and persons with reduced physical, sensory or mental capabilities or lack of experience and knowledge if they have been given supervision or instruction concerning use of the appliance in a safe way and understand the hazards involved. Children shall not play with the appliance. Cleaning and user maintenance shall not be made by children without supervision.

Do not use harsh abrasive cleaners or sharp metal scrapers to clean the oven door glass since they can scratch the surface, which may result in shattering of the glass.

Keep children away from the appliance during the automatic cleaning cycle as surfaces may become very hot.

Never use steam cleaners or pressure cleaners on the appliance.

**WARNING:** Ensure that the appliance is switched off before replacing the lamp to avoid the possibility of electric shock.

! When you place the rack inside, make sure that the stop is directed upwards and in the back of the cavity.

## Description of the appliance

### Overall view

1. POSITION 1
2. POSITION 2
3. POSITION 3
4. POSITION 4
5. POSITION 5
6. DIVIDER "D" POSITION
7. POSITION 6
8. POSITION 7
9. GUIDES for the sliding racks
10. DRIPPING PAN
11. RACK shelf
12. DIVIDER shelf
13. Control panel

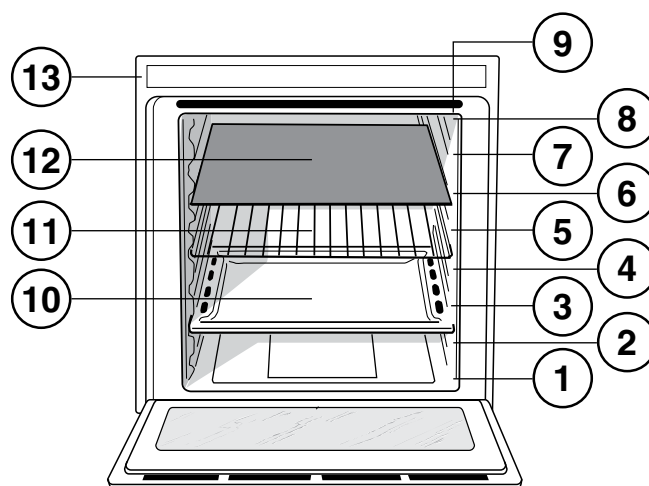

## Description of the appliance

### Control panel

1. SELECTOR knob
2. CONTROL PANEL POWER BUTTON
3. DISPLAY
4. THERMOSTAT / TIMER knob
5. START / STOP
6. MINUTE MINDER icon
7. TIMER icon
8. CONTROL PANEL LOCK icon
9. SELECT CAVITY icon
10. LIGHT icon

### Display

11. SMALL CAVITY icon
12. CAVITY TEMPERATURE display
13. CONTROL PANEL LOCK indicator
14. TIME display
15. DURATION icon
16. END OF COOKING icon
17. CLOCK icon
18. MINUTE MINDER icon
19. CAVITY PREHEATING / RESIDUAL HEAT indicator
20. MAIN CAVITY icon
21. MODE icons

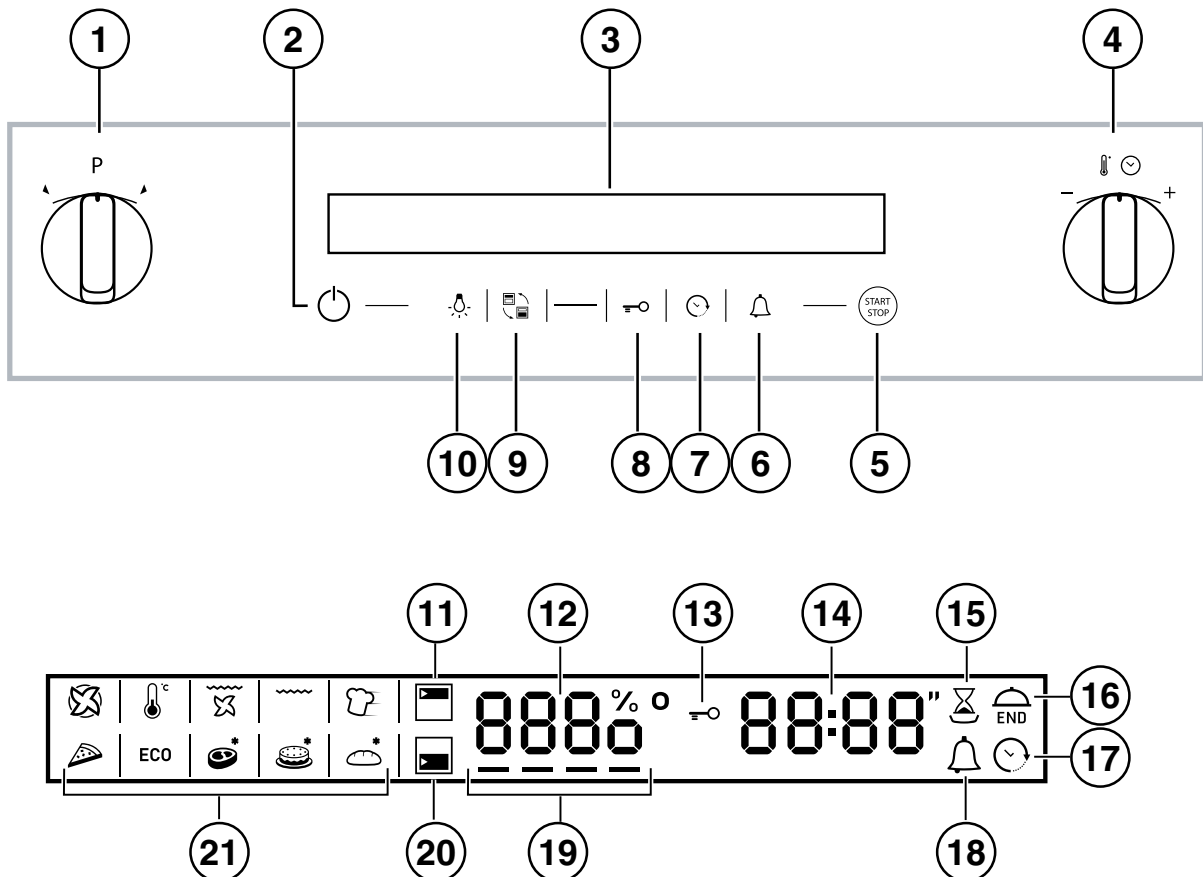

## Installation

! Please keep this instruction booklet in a safe place for future reference. If the appliance is sold, given away or moved, please make sure the booklet is also passed on to the new owners so that they may benefit from the advice contained within it.

! Please read this instruction manual carefully: it contains important information concerning the safe operation, installation and maintenance of the appliance.

### Positioning

! Do not let children play with the packaging material; it should be disposed of in accordance with local separated waste collection standards (see Precautions and tips).

! The appliance must be installed by a qualified professional in accordance with the instructions provided. Incorrect installation may damage property or cause harm to people or animals.

### Built-in appliances

Use an appropriate cabinet to ensure that the appliance operates properly:

- the panels adjacent to the oven must be made of heat-resistant material.
- cabinets with a veneer exterior must be assembled with glues which can withstand temperatures of up to 100°C.
- to install the oven **under the counter** (see diagram) or in a **kitchen unit**, the cabinet must have the following dimensions:

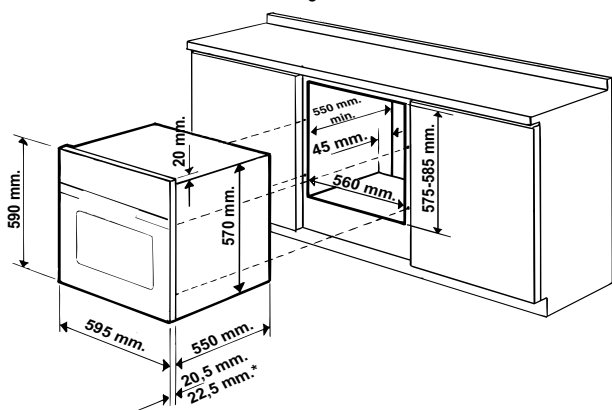

! The appliance must not come into contact with electrical parts once it has been installed.

The indications for consumption given on the data plate have been calculated for this type of installation.

### Ventilation

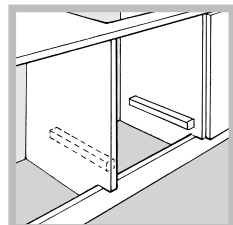

To ensure adequate ventilation, the back panel of the cabinet must be removed. It is advisable to install the oven so that it rests on two strips of wood, or on a completely flat surface with an opening of at least 45 x 560 mm (see diagrams).

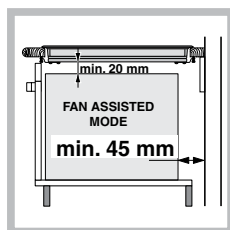
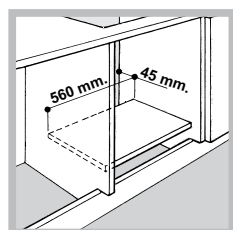

### Centring and fixing

Secure the appliance to the cabinet:

- open the oven door.
- slide out the side gaskets at the top until the 2 fixing holes are exposed;
- fix the oven to the cabinet using the 2 wood screws.
- reposition the 2 gaskets.

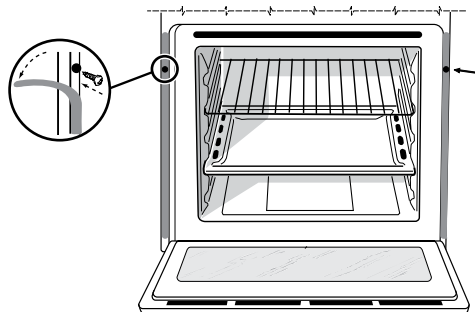

! All parts which ensure the safe operation of the appliance must not be removable without the aid of a tool.

## Electrical Connection

The electrical connection to the mains must be made on the appliance. The power voltage and frequency are as indicated on the rating plate.

**! THIS APPLIANCE MUST BE EARTHED.**

### Fitting the power supply cable

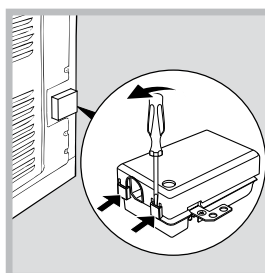

1. Open the terminal board by inserting a screwdriver into the side tabs of the cover. Use the screwdriver as a lever by pushing it down to open the cover (see diagram).

2. Install the power supply cable by loosening the cable clamp screw and the three wire contact screws L-N- $\perp$ .

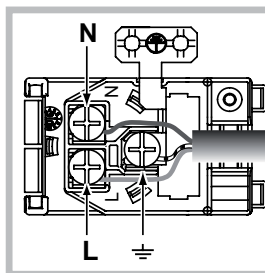

Connect the wires to the corresponding terminals: the Blue wire to the terminal marked (N), the Brown wire to the terminal marked (L) and the Yellow/Green wire to the terminal marked  $\perp$  (see diagram).

3. Secure the cable by fastening the clamp screw.

4. Close the cover of the terminal board.

### Electrical Connection:

Voltage Frequency: see data plate

Fuse Section: 16A

Supply cable: 3x1.5mm<sup>2</sup>

You can connect your oven to the system means of a terminal board. Refer to above information for the minimal cable sections and the calibration of the protective elements according to the connection.

If the appliance is installed **with a junction box**, an **omnipolar circuit breaker** - with a minimum contact opening of 3mm - should be installed between the appliance and the mains.

**Power cable supply connection to the electrical mains:**

We recommend you use a power supply cable which is long enough to allow you to take the oven out of its recess in the event of maintenance operations (only use HAR - H 05 - RRF quality cables fitted with a plug conforming to the regulations in force.

The plug must be accessible at all times.

**Unplug the appliance before all operations, even when replacing the oven lamp.**

**Using the appliance without correct earthing is highly dangerous.**

**! After connecting the appliance to the flexible cable, tighten all the screws on the terminal board.**

APPLIANCE SPECIFICATIONS	
<b>Dimensions*</b>	width 43.5 cm
	height 41 cm
	depth 41 cm
<b>Volume*</b>	74 l
<b>Dimensions**</b>	width 45.6 cm
	height 41 cm
	depth 41 cm
<b>Volume**</b>	77 l
<b>Electrical connections</b>	voltage: 230-240V~ 50Hz (see data plate) maximum power absorbed 2600-2800 W
<b>Energy Label e Ecodesign</b>	Regulation (EU) No 65/2014 to supplement Directive 2010/30/EU Regulation (EU) No 66/2014 to supplement Directive 2009/125/EC Standard EN 60350-1 Standard EN 50564  Declared energy consumption for Forced convection Class - heating mode: <b>ECO</b>
	This appliance conforms to the following European Economic Community directives: - 2006/95/EC dated 12/12/06 (Low Voltage) and subsequent amendments. - 2004/108/EC dated 03/05/89 (Electromagnetic Compatibility) and subsequent amendments. - 93/68/EEC dated 22/07/93 and subsequent amendments. - 2012/19/EU and subsequent amendments. 1275/2008 Stand-by/off mode

\* Only for models with drawn rails.

\*\* Only for models with wire rails.

## Oven structure

The OPEN SPACE oven has a capacity of 70 litres and offers users the option of cooking on 4 shelves at the same time or cooking large quantities which would not necessarily be possible in a traditional oven.

The 56 universal (Creation) and automatic (Success) cooking modes guarantee perfect results every time, regardless of the dish you are cooking. OPEN SPACE also offers maximum comfort for all requirements, with 4 different operating options: the oven is one large compartment but can be divided into separate spaces of various sizes, each with its own independent temperature and duration controls.

This is made possible thanks to the heat-insulating DIVIDER, which divides the whole ExtraLarge Space into two different-sized spaces: the Main Space and the Small Space.

The two Main and Small Space compartments may be used at the same time to cook different dishes more quickly, or they may be used separately so that only the space necessary is used.

When the two compartments are used at the same time, the cooking temperature of each may be adjusted to a value between 30° and 300°. There may be a difference in temperature of 100° between the two zones, which means it is possible to cook very different dishes without any flavours or aromas intermingling.

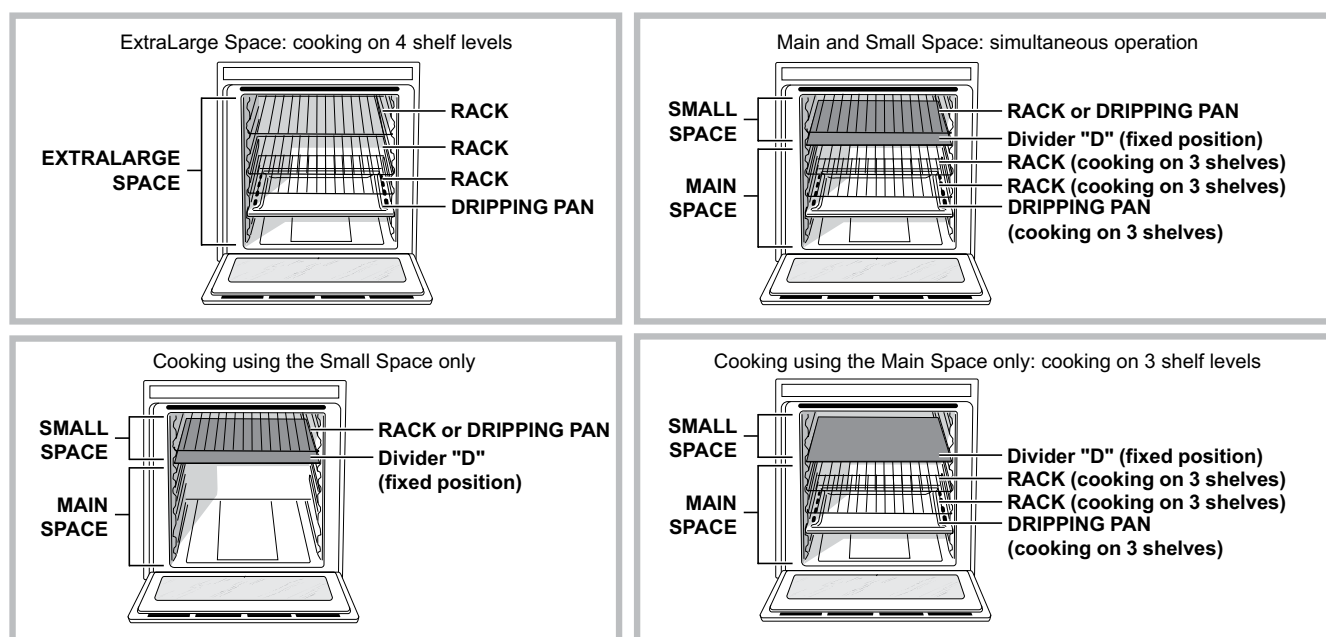

The table below lists the possible temperature values which may be set. The intelligent display will guide you through the correct procedure used to adjust the temperature of the two cavities.

Temperature in the first cavity (Main or Small Space)	Temperature in the second cavity (Small or Main Space)
Between 40°C and 150°C	The temperature difference in relation to the first recess selected is no greater than 50°C <i>For example: if you set one recess to 90°C, you may set a value of between 40°C (90°C-50°C) and 140°C (90°C+50°C) for the other.</i>
Between 155°C and 200°C	The temperature difference in relation to the first recess selected is no greater than 70°C <i>For example: if you set one recess to 180°C, you may set a value of between 110°C (180°C-70°C) and 250°C (180°C+70°C) for the other.</i>
Between 205°C and 250°C	The temperature difference in relation to the first recess selected is no greater than 100°C <i>For example: if you set one recess to 210°C, you may set a value of between 110°C (210°C-100°C) and 250°C (maximum temperature setting) for the other.</i>

## Start-up and use

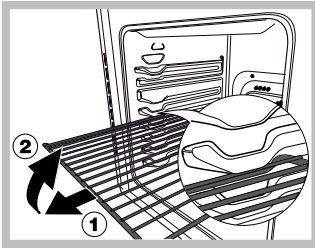

**WARNING!** The oven is provided with a stop system to extract the racks and prevent them from coming out of the oven (1). As shown in the drawing, to extract them completely, simply lift the racks, holding them on the front part, and pull (2).

! The first time you use your appliance, heat the empty oven with its door closed at its maximum temperature for at least half an hour. Make sure that the room is well ventilated before switching the oven off and opening the oven door. The appliance may emit a slightly unpleasant odour caused by protective substances used during the manufacturing process burning away.

! To make the setting process easier, keep the knob in “+” or “-” position: this will increase the scrolling speed of the numbers on the display.

! Each setting will automatically be stored in the appliance memory after 10 seconds.

! During operation, we recommend the removal of any crockery or delicate foodstuffs from the cavities not being used.

! Once cooking has begun, before the DIVIDER is removed, the oven must be switched off using the  icon.

! Every time the oven is switched on it is set to the CREATION cooking mode.

! The touch controls cannot be activated if the user is wearing gloves.



! In order to optimise the cooking performance, when starting the selected function, product settings will be applied that could cause a delayed start of the fan and heating elements.

Some models are equipped with a system of hinges which allows the door to close slowly, without the user having to follow the movement through with his/her hand. To use the system correctly, before closing the door:

- open the door fully.
- do not force the closing movement manually.

### Control panel lock

! The control panel can be locked while the oven is off, once cooking has started or finished and during programming.

To lock the oven controls, press and hold the  icon for at least 2 seconds. A buzzer will sound and the TEMPERATURE display shows the key symbol “O—n”. The  icon will light up to indicate lock activation.



To deactivate the lock, press and hold the  icon again for at least 2 seconds.

### Setting the clock

! The clock can only be set when the oven is switched off. If the oven is in standby mode, pressing the  icon once will display the current time setting. Press it again to set the time.

After connection to the power supply network or after a blackout, the  icon and the digits on the display will flash for 10 seconds.

To set the clock:

1. Press icon .
2. Turn the TIMER knob towards “+” and “-” to adjust the hour value.
3. Once you have reached the correct hour value, press the  icon.
4. Repeat the above process to set the minutes.



If a blackout occurs, it will be necessary to reset the clock. If the  icon flashes on the display, this indicates that the clock has not been set correctly.

### Setting the minute minder

! The minute minder may be set regardless of whether the oven is switched on or off. It does not switch the oven on or off.

When the set time has elapsed, the minute minder emits a buzzer that will automatically stop after 30 seconds or when any active button on the control panel is pressed.

To adjust the minute minder, proceed as follows:

1. Press the  icon.
2. Adjust the time as desired by turning the TIMER knob towards “+” and “-”.
3. Once you have reached the desired value, press the  icon again.

The lit  symbol will remind you that the minute minder is on. The DISPLAY will show the countdown.

To cancel the minute minder, press the  icon and use the knob to set the time to 00:00. Press button again.

The  icon will switch off to indicate that the minute minder has been disabled.

### Cooling ventilation

In order to cool down the external temperature of the oven, a cooling fan blows a stream of air between the control panel and the oven door, as well as towards the bottom of the oven door. In the FAST COOKING mode, the fan is activated automatically after ten minutes.

! Once the cooking has been completed, the cooling fan remains on until the oven has cooled down sufficiently.

### Oven light

The light comes on when the oven door is opened or when a cooking mode starts.



The  icon can be used to switch on the light at any time.

### Residual heat indicators

The appliance is fitted with a residual heat indicator. When the oven is off, the “residual heat” light on the display comes on to indicate high temperatures inside the oven cavity. The indicator light switches off when the inside of the oven has cooled down.

### Restoring the factory settings

The oven factory settings can be restored to reset all selections made by the user (clock and customised durations). To carry out a reset, switch off

the oven, then keep the SELECTOR knob turned while pressing the  icon for 6 seconds. Once the restore procedure is complete, a buzzer will sound. The first time the  icon is pressed, the oven will behave as if it is being switched on for the first time.



## Standby

This product complies with the requirements of the latest European Directive on the limitation of power consumption in standby mode. If no buttons are pressed for 30 minutes and the control panel/door lock has not been activated, the appliance automatically reverts to standby mode. The standby mode is visualised by the high luminosity "Watch Icon". As soon as interaction with the machine resumes, system operation is restored.

## Cooking modes

! To guarantee perfectly soft or crispy food, the oven releases water contained within the food in the form of steam. This means it is possible to achieve optimal cooking results for all dishes.

! Every time the oven is switched on, it suggests the first CREATION cooking mode.





! Never put objects directly on the bottom of the oven; this will prevent the enamel coating from being damaged.

! Always place cookware on the rack(s) provided.

### ExtraLarge Space

! Do not use position "D" for racks.

#### Starting the oven

- Switch the control panel on by pressing the  icon. The appliance buzzer sounds three times (ascending) and all icons light up in sequence.
- Select the desired cooking mode by turning the SELECTOR knob. The TEMPERATURE display shows:
  - the temperature associated with the mode, if programming manually;
  - "Auto", if programming is automatic.
 The TIME display shows:
  - the current time, if programming manually;
  - the duration, if programming is automatic.
- Press the  icon to begin cooking.
- The oven will begin its preheating stage: the preheating light flashes.
- When the preheating process has finished, a buzzer sounds and the preheating indicator light shows that this stage has been completed: the food can then be placed in the oven.
- During cooking it is always possible to:
  - modify the temperature by turning the THERMOSTAT knob (*manual modes only*);
  - set the duration of a cooking mode (*see Cooking Modes*);
  - press the  icon to stop cooking. In this case the appliance stores the temperature modified previously in its memory (*manual modes only*);
  - switch off the oven by pressing the  icon for 3 seconds.
- In case of a blackout, if the oven was already operating, an automatic system within the appliance will reactivate the cooking mode from where it was interrupted as long as the temperature did not drop below a certain level. Programmed cooking modes which have not yet started will not be restored and must be reprogrammed (for example: a cooking mode has been programmed to start at 20:30. At 19:30 a blackout occurs. When the power supply is restored, the mode will have to be reprogrammed).

! There is no preheating stage for the BARBECUE mode.

! The oven will begin its preheating phase after 2 seconds from selecting the desired cycle.

#### CREATION cooking modes

! All cooking modes have a default cooking temperature which may be adjusted manually to a value between 30°C and 250°C as desired (300°C for GRILL mode). CREATION cooking modes include all manual programmes. The oven controls all essential aspects of each of these cooking modes and makes it easier for you to create the perfect dish, from the simplest recipe to the most sophisticated culinary delights: the temperature, heat source, humidity and fan assisted operation are all controlled automatically.

This chapter was written with the help of our very own culinary expert. We invite you to follow his advice so you can benefit from his experience and perfect your cooking skills.

The recommended cooking modes, temperatures and oven shelf heights reflect our expert's own experience in the kitchen and will help you achieve the very best results.

The table below specifies whether it is best to **pre-heat** your oven or **not** for each CREATION cooking mode. Observing these suggestions will guarantee perfect results.

If you wish to place food in a preheated oven, wait for the preheating stage to be completed (this will be signalled by a series of beeps).

The temperature is set automatically, according to the cooking mode selected; **however, you may adjust it to suit your recipe.**

You can also set a cooking duration with an immediate or delayed start.



#### MULTILEVEL mode

All heating elements and the fan are activated. Since the heat remains constant throughout the oven, the air cooks and browns food in a uniform manner. A maximum of two racks may be used at the same time.



#### LOW TEMPERATURE modes

This type of cooking can be used for proving, defrosting, preparing yoghurt, heating dishes at the required speed and slow cooking at low temperatures. The temperature options are: 40, 65 and 90°C.



#### FAN GRILLING mode

The top heating element and the rotisserie spit (where present) are activated and the fan begins to operate. During part of the cycle the circular heating element is also activated. This combination of features increases the effectiveness of the unidirectional thermal radiation provided by the heating elements through the forced circulation of the air throughout the oven.

This helps prevent food from burning on the surface and allows the heat to penetrate right into the food. Always cook in this mode with the oven door closed.



#### GRILL mode

The top heating element and the rotisserie spit (where present) are activated. The high and direct temperature of the grill is recommended for food which requires a high surface temperature. Always cook in this mode with the oven door closed (*see "Practical cooking advice"*).



#### FAST COOKING mode

Preheating is not necessary for this cooking mode. This mode is particularly suitable for cooking pre-packed food quickly (frozen or pre-cooked). The best results are achieved using one cooking rack only.

**PIZZA mode**

The top and circular heating elements switch on and the fan begins to operate. This combination heats the oven rapidly. If you use more than one rack at a time, switch the position of the dishes halfway through the cooking process.

**ECO mode**

The back heating element is turned on and the fan starts working, ensuring a smooth and uniform heat level inside the oven.

This programme is indicated for slow cooking of any type of food with temperatures which can be set up to a maximum of 200°C; the programme is also suitable for heating food and to complete the cooking process.

The programme is particularly suitable for the slow cooking of meat and fish, as it allows you to have softer meat and save energy at the same time. For a better energy effectiveness, when the product is turned on, the light stays on only for 30 seconds; in order to turn the light back on, please press the  icon.

**SUCCESS cooking modes**

! The **temperature** and **cooking duration** are **pre-set** values, guaranteeing a perfect result every time - automatically. These values cannot be adjusted and use the **C.O.P.® (Programmed Optimal Cooking)** system. The cooking cycle stops automatically and the oven indicates when the dish is cooked. You may start cooking whether the oven has been **preheated** or **not**. The cooking duration can be customised according to personal tastes, modifying it - before the start time - by  $\pm 5/20$  minutes depending on the selected programme. Once cooking has begun, it is still possible to modify its duration. If the value is modified before cooking begins, it is stored in the appliance memory and suggested again when that cooking mode is next used. If the temperature inside the oven is higher than the suggested value for the selected mode, the text "Hot" appears on the TEMPERATURE display and it will not be possible to begin cooking; wait for the oven to cool.

! When the cooking stage has been reached, the oven buzzer sounds.

! Do not open the oven door as this will disrupt the cooking time and temperature.

**BEEF mode**

Use this function to cook beef and pork. Place the food inside the oven while it is still cold. The dish may also be placed in a preheated oven.

**DESSERTS mode**

This function is ideal for cooking desserts which are made using natural yeast, baking powder and desserts which contain no yeast. Place the dish in the oven while it is still cold. The dish may also be placed in a preheated oven.

**BREAD mode**

Use this function to bake bread. To obtain the best results, we recommend that you carefully observe the instructions below:

- Follow the recipe.
- Do not exceed the **maximum weight** of the dripping pan.
- **Remember to pour 100 g (1dl) of cold water into the dripping pan, which should be placed in position 7.**
- The dough must be left to rise at room temperature for 1 – 1 ½ hours (depending on the room temperature) or until the dough has doubled in size.

**Recipe for BREAD:**

1 dripping pan holding 1000 g max, lower level

2 dripping pans each holding 1000 g max, middle and lower levels

Recipe for 1000 g of dough: 600 g flour, 360 g water, 11g salt, 25 g fresh yeast (or 2 sachets of powder yeast)

**Method:**



- Mix the flour and salt in a large bowl.
- Dilute the yeast in lukewarm water (approximately 35 degrees).
- Make a small well in the mound of flour.
- Pour in the water and yeast mixture.
- Knead the dough by stretching and folding it over itself with the palm of your hand for 10 minutes until it has a uniform consistency and is not too sticky.
- Form the dough into a ball shape, place it in a large bowl and cover it with transparent plastic wrap to prevent the surface of the dough from drying out. Select the manual LOW TEMPERATURE function on the oven and set the temperature to 40°C. Place the bowl inside and leave the dough to rise for approximately 1 hour (the dough should double in volume).
- Cut the dough into equal sized loaves.
- Place them in the dripping pan, on a sheet of baking paper.
- Dust the loaves with flour.
- Make incisions on the loaves.
- Place the food inside the oven while it is still cold.
- Start the  BREAD cooking mode.
- Once baked, leave the loaves on one of the grill racks until they have cooled completely.

**THE DIVIDER**

Fit the DIVIDER to the DIVIDER shelf "D" using the pin, with the arrows turned towards the rear part of the oven. A buzzer will sound to confirm that the DIVIDER has been fitted correctly; it will then be possible to use the two MAIN and SMALL Space compartments separately or at the same time.

The  button will be enabled. The selected cavity alternates every time the button is pressed. The MAIN cavity is selected by default.

**Small Space****Starting the oven**

1. With the DIVIDER inserted, use the  button to select the SMALL Space cavity. The  icon will light up.
2. Follow the above instructions for the EXTRALARGE cavity when carrying out the various adjustment and setting procedures.



**Cooking modes****GRILL mode**

The top heating element and the rotisserie spit (where present) are activated. The high and direct temperature of the grill is recommended for food which requires a high surface temperature. Always cook in this mode with the oven door closed (see "Practical cooking advice").

**FAST COOKING mode**

Preheating is not necessary for this cooking mode. This mode is particularly suitable for cooking pre-packed food quickly (frozen or pre-cooked). The best results are achieved using one cooking rack only.

**Main Space****Starting the oven**

1. With the DIVIDER inserted, use the  button to select the SMALL Space cavity. The  icon will light up.

2. Follow the above instructions for the EXTRALARGE cavity when carrying out the various adjustment and setting procedures.

### CREATION cooking modes

! All cooking modes have a default cooking temperature which may be adjusted manually to a value between 30°C and 250°C as desired (300°C for GRILL mode). **CREATION** cooking modes include all manual programmes. The oven controls all essential aspects of each of these cooking modes and makes it easier for you to create the perfect dish, from the simplest recipe to the most sophisticated culinary delights: the temperature, heat source, humidity and fan assisted operation are all controlled automatically. This chapter was written with the help of our very own culinary expert. We invite you to follow his advice so you can benefit from his experience and perfect your cooking skills.

The recommended cooking modes, temperatures and oven shelf heights reflect our expert's own experience in the kitchen and will help you achieve the very best results.

The table below specifies whether it is best to **pre-heat** your oven or **not** for each **CREATION** cooking mode. Observing these suggestions will guarantee perfect results.

If you wish to place food in a preheated oven, wait for the preheating stage to be completed (this will be signalled by a series of beeps).

The temperature is set automatically, according to the cooking mode selected; **however, you may adjust it to suit your recipe.**

You can also set a cooking duration with an immediate or delayed start.



### MULTILEVEL mode

All heating elements and the fan are activated. Since the heat remains constant throughout the oven, the air cooks and browns food in a uniform manner. A maximum of two racks may be used at the same time.



### LOW TEMPERATURE modes

This type of cooking can be used for proving, defrosting, preparing yoghurt, heating dishes at the required speed and slow cooking at low temperatures. The temperature options are: 40, 65 and 90°C.



### PIZZA mode

The top and circular heating elements switch on and the fan begins to operate. This combination heats the oven rapidly. If you use more than one rack at a time, switch the position of the dishes halfway through the cooking process.

### ECO mode

The back heating element is turned on and the fan starts working, ensuring a smooth and uniform heat level inside the oven.

This programme is indicated for slow cooking of any type of food with temperatures which can be set up to a maximum of 200°C; the programme is also suitable for heating food and to complete the cooking process.

The programme is particularly suitable for the slow cooking of meat and fish, as it allows you to have softer meat and save energy at the same time. For a better energy effectiveness, when the product is turned on, the light stays on only for 30 seconds; in order to turn the light back on, please press the  icon.

### SUCCESS cooking modes

! The **temperature** and **cooking duration** are **pre-set** values, guaranteeing a perfect result every time - automatically. These values cannot be adjusted and use the **C.O.P.® (Programmed Optimal Cooking)** system. The cooking cycle stops automatically and the oven indicates when the dish is cooked. You may start cooking whether the oven has been **preheated** or **not**. The cooking duration can be customised according to personal tastes, modifying it - before the start time - by  $\pm 5/20$  minutes depending on the selected programme.

Once cooking has begun, it is still possible to modify its duration. If the value is modified before cooking begins, it is stored in the appliance memory and suggested again when that cooking mode is next used. If the temperature inside the oven is higher than the suggested value for the selected mode, the text "Hot" appears on the TEMPERATURE display and it will not be possible to begin cooking; wait for the oven to cool.

! When the cooking stage has been reached, the oven buzzer sounds.

! Do not open the oven door as this will disrupt the cooking time and temperature.



### BEEF mode

Use this function to cook beef and pork. Place the food inside the oven while it is still cold. The dish may also be placed in a preheated oven.



### DESSERTS mode

This function is ideal for cooking desserts which are made using natural yeast, baking powder and desserts which contain no yeast. Place the dish in the oven while it is still cold. The dish may also be placed in a preheated oven.

## Using the Small Space and Main Space at the same time

! Simultaneous operation is only possible when using CREATION cooking modes.

### Starting the oven

For simultaneous use, simply start a cooking mode for both cavities in succession.

The TEMPERATURE display shows the cooking parameters for both cavities.

! Thanks to the high energy efficiency of the appliance, it only takes around 15 minutes for the SMALL SPACE cavity to preheat.

## Programming cooking

! A cooking mode must be selected before programming can take place.

### Programming the cooking duration

1. Press the  icon until the  icon and the numerical digits on the display begin to flash.

2. Turn the TIMER knob towards "+" and "-" to adjust the time as desired; keep the knob in position to scroll through the numbers more quickly and make the setting process easier.

3. Once you have reached the desired duration, press the  icon again. The display will show the duration and set temperature alternately.

4. Press the  icon to begin cooking.

5. When cooking has finished, "END" appears on the display and a buzzer sounds.



- For example: it is 9:00 a.m. and a duration of 1 hour and 15 minutes is programmed. The programme will stop automatically at 10:15 a.m.

### Setting the end time for a cooking mode

! A cooking duration must be set before the cooking end time can be scheduled.

! For the delayed programming to work properly, the clock should be set to the correct time.



1. Follow steps 1 to 3 to set the duration as detailed above.

2. Press the  icon twice: the  icon and the numerical digits on the display will begin to flash.

3. Turn the TIMER knob towards “+” and “-” to adjust the cooking end time value.

4. Once you have reached the desired end time, press the  icon again. The display will show the duration, the cooking end time and the set temperature alternately.

5. Press the  icon to activate the programmed mode.

Programming has been set when the  and  icons are illuminated. The DISPLAY shows the cooking end time and the cooking duration alternately.

6. Once cooking has finished, “END” appears on the display and a buzzer sounds.

- For example: it is 9:00 a.m. and a time of 1 hour and 15 minutes is programmed, while the end time is set to 12:30. The programme will start automatically at 11:15 a.m.

To cancel programming press the  button.

## Practical cooking advice

### MULTILEVEL

- Use positions 1, 3, 5 and 6.
- Place the dripping pan at the bottom and the rack at the top.
- When cooking pizzas or focaccia breads, use a lightweight aluminium tray with a maximum diameter of 30 cm, placing it on top of the rack supplied. If the pizza has a lot of toppings, we recommend adding the mozzarella cheese to the top of the pizza halfway through the cooking process. During the cooking process, it is advisable to change the order of the shelves.
- Use positions 2 and 4, placing the food which requires more heat on 2.
- Place the dripping pan on the bottom and the rack on top.

### GRILL

- Preheat the oven for 5 minutes.
- Fit the DIVIDER to the DIVIDER rack “D”.
- Keep the oven door closed when cooking in this mode.
- Place the rack in position 7. Position the food in the centre of the rack. Position the dripping pan on shelf level 6.
- This function is recommended for: browning food, cooking gratins, colouring meringues, making toasted sandwiches and grilling small quantities of thin, lean meat.
- We recommend that the power level is set to maximum. The top heating element is regulated by a thermostat and may not always operate constantly.
- Place the grill rack in position 3 or 4 and place the food in the centre of the rack.
- We recommend that the temperature is set to its maximum level. The top heating element is regulated by a thermostat and may not always operate constantly.

### FAST COOKING

- Use the dripping pan on shelf level 6.
- When cooking frozen foods, always follow the instructions on the packaging.

**Cooking advice table for ovens with an ExtraLarge Space cavity**

Function	Food	Weight (Kg)	Cook on shelf no.	Shelf position			Preheating	Recommended temperature (°C)	Cooking duration (minutes)		
				Dripping pan	Rack 1	Rack 2				Rack 3	
<b>Creation</b>											
<b>Multilevel*</b>	Tarts		1		2 or 3			Yes	190	25-30	
			2		1 or 2	3 or 5		Yes	180	35-45	
			3		1	3	5		Yes	180	40-50
			4	1	3	5	6		Yes	180	45-55
	Cream puffs		1		2 or 3			Yes	190	25-35	
			2	1 to 2	3 to 5			Yes	190	25-35	
			3	1	3	5		Yes	190	30-40	
			4	1	3	5	6	Yes	190	30-40	
	Biscuits		1		2 or 3			Yes	180	15-25	
			2	1 to 2	3 to 5			Yes	180	15-25	
		3	1	3	5		Yes	180	20-30		
		4	1	3	5	6	Yes	180	20-30		
Small pastries		1		2 or 3			Yes	200	30-40		
		2		2	5		Yes	200	35-45		
		3	1	4	6		Yes	200	40-50		
Crème Caramel (bain-marie)		1		2 or 3			Yes	170	35-45		
		2		2	5		Yes	170	35-45		
		3	1	4	6		Yes	170	40-50		
Panettone		1		1 or 2			Yes	160	45-60		
Cake		1		2 or 3			Yes	160	60-75		
		2		1	4 or 5		Yes	160	60-75		
Sponge cake		1		2 or 3			Yes	190	30-35		
		2		2	5		Yes	190	35-40		
		3	1	4	6		Yes	190	40-45		
Roast	1,5 -2	1		1***	2		Yes	160	90-240		
<b>Fast cooking*</b>	Kebabs		1	1	5		No	210	20-25		
	Fish fillets		1	1	5		No	200	15-20		
	Frozen potatoes		1	5			No	230	25-30		
<b>Pizza*</b>	Pizza/Focaccia		1	2 or 3			Yes	220	15-25		
			2	1 or 2	3 or 5		Yes	220	20-30		
			3	1	3	5		Yes	220	25-35	
			4	1	3	5	6	Yes	220	30-40	
<b>Fan grilling*</b>	Roast meats		1	2***	3		No	200	35-75		
	Gratin		1	3 or 4			No	190	40-60		
	Large roasting joint		1	1***	2		No	200	90-120		
	Large game roasting joint		1	1***	2		No	200	90-120		
<b>Grill*</b>	Beef ribs		1	3***	4 or 5		Yes	100%	20-30		
	Sausages		1	3***	5 or 7		Yes	100%	10-20		
	Pork ribs		1	3***	5 or 7		Yes	100%	15-25		
	Bacon		1	3***	5 or 7		Yes	100%	3-6		
<b>Low temperature*</b>	Proving/Defrosting		1	2			No	40			
	White meringues		4	1	3	5	6	No	65	8-12 hours	
	Meat/Fish		3	1	3	5		No	90	90-180	
<b>Success</b>											
<b>Bread</b>	Bread (see recipe)		2	1	7**	2		No			
			2	2	7**	1	4		No		
			2	3	7**	1	3	5	No		
<b>Beef</b>	Roast	1,2-1,5	1	1***	5			No			
<b>Cakes</b>	Cakes		1		2			No			
			2		2	5		No			

\* The cooking times listed above are intended as guidelines only and may be modified according to personal tastes. Oven preheating times are set as standard and may not be modified manually.

\*\* As stated in the recipe, pour 100 g water into the dripping pan in position 7.

\*\*\* Use the dripping pan to collect any oil or fat produced as a result of the cooking process.

**! ECO cooking mode:** This programme can be used for slow cooking of any type of food with temperatures which can be set up to a maximum of 200°C; the programme is also suitable for heating food and to complete the cooking process

**Cooking advice table for the Small Space feature**

Function	Food	Weight (Kg)	Cook on shelf no.	Shelf position		Preheating	Recommended temperature (°C)	Cooking duration (minutes)
				Dripping pan	Rack 1			
<b>Fast cooking*</b>	Fish fillets		1	6		D	160-180	20-30
	Meat fillets		1	6		D	180-200	30-40
	Frozen pizza		1	6		D		
	Frozen prepared foods		1	6		D		
<b>Grill*</b>	Toast		1		6	D	100%	3-5
	Bacon		1	6**	7	D	100%	3-6
	Pork steaks		1	6**	7	D	100%	15-25

\* The cooking times listed above are intended as guidelines only and may be modified according to personal tastes. Oven preheating times are set as standard and may not be modified manually.

\*\* Use the dripping pan to collect any oil or fat produced as a result of the cooking process.



## Cooking advice table for using the Small Space and Main Space at the same time

### Main Space

Function	Food	Weight (kg)	Cook on shelf no.	Rack position			Preheating	Recommended temperature (°C)	Cooking duration (minutes)
				Dripping pan	Rack 1	Divider			
<b>Creation</b>									
<b>Multilevel*</b>	Tarts		1	2	3	D	Yes	200	30-40
			2	1					
	Biscuits		1	2	3	D	Yes	180	15-25
			2	1					
	Small pastries		1	2	3	D	Yes	200	30-40
2			1						
Crème Caramel (bain-marie)		1	2		D	Yes	170	35-45	
Cake		1	2		D	Yes	160	60-75	
<b>Pizza*</b>	Pizza (see recipe)		1	2 or 3	3 or 5	D	Yes	220	15-25
			2	1 or 2					

### Small Space

Function	Food	Weight (kg)	Cook on shelf no.	Shelf position			Preheating	Recommended temperature (°C)	Cooking duration (minutes)
				Dripping pan	Rack 1	Divider			
<b>Fast cooking*</b>	Fish fillets		1	6		D	Yes	160-180	20-30
	Meat fillets		1	6		D	Yes	180-200	30-40
	Frozen pizza		1	6		D	Yes		
	Frozen prepared foods		1	6		D	Yes		
<b>Grill*</b>	Pork steaks		1	6**	7	D	Yes	100%	15-25

\* The cooking times listed above are intended as guidelines only and may be modified according to personal tastes. Oven preheating times are set as standard and may not be modified manually.

\*\* Use the dripping pan to collect any oil or fat produced as a result of the cooking process.

## Cooking advice table for the Main Space feature

Function	Food	Weight (Kg)	Cook on shelf no.	Shelf position			Preheating	Recommended temperature (°C)	Cooking duration (minutes)
				Dripping pan	Rack 1	Divider			
<b>Creation</b>									
<b>Multilevel*</b>	Tarts		1	2	3	D	Yes	200	30-40
			2	1					
	Cream puffs		1	2	3	D	Yes	190	25-35
			2	1					
	Biscuits		1	2	3	D	Yes	180	15-25
			2	1					
	Small pastries		1	2	3	D	Yes	200	30-40
			2	1					
	Crème Caramel (bain-marie)		1	2		D	Yes	170	35-45
	Cake		1	2		D	Yes	160	60-75
Sponge cake			1	2	3	D	Yes	190	30-35
			2	1					
<b>Pizza*</b>	Pizza/Focaccia		1	2 or 3	3 or 5	D	Yes	220	15-25
			2	1 or 2					
<b>Low temperature*</b>	Proving/Defrosting White meringues Meat/Fish		1	2	3	D	No	40	8-12 hours
			2	1					
			2	1					
<b>Success</b>									
<b>Beef</b>	Roast	1,2-1,5	1	1**	2	D	No		
<b>Cakes</b>	Cakes		1	2	3	D	No		
			2	1					

\* The cooking times listed above are intended as guidelines only and may be modified according to personal tastes. Oven preheating times are set as standard and may not be modified manually.

\*\* Use the dripping pan to collect any oil or fat produced as a result of the cooking process.

**! ECO cooking mode:** This programme can be used for slow cooking of any type of food with temperatures which can be set up to a maximum of 200°C; the programme is also suitable for heating food and to complete the cooking process.

## Precautions and tips

! This appliance has been designed and manufactured in compliance with international safety standards. The following warnings are provided for safety reasons and must be read carefully.

### General safety

- The appliance was designed for domestic use inside the home and is not intended for commercial or industrial use.
- The appliance must not be installed outdoors, even in covered areas. It is extremely dangerous to leave the appliance exposed to rain and storms.
- When moving or positioning the appliance, always use the handles provided on the sides of the oven.
- Do not touch the appliance while barefoot or with wet or damp hands and feet.
- **The appliance must be used by adults only for the preparation of food, in accordance with the instructions provided in this booklet. Any other use of the appliance (e.g. for heating the room) constitutes improper use and is dangerous. The manufacturer may not be held responsible for any damage caused as a result of improper, incorrect and unreasonable use of the appliance.**
- **Do not touch the heating elements or certain parts of the oven door when the appliance is in use; these parts become extremely hot. Keep children well away from the appliance.**
- Make sure that the power supply cables of other electrical appliances do not come into contact with the hot parts of the oven.
- The ventilation and heat dispersal openings must never be obstructed.
- Always grip the oven door handle in the centre: the ends may be hot.
- Always use oven gloves when placing cookware in the oven or when removing it.
- Do not use aluminium foil to line the bottom of the oven.
- Do not place flammable materials in the oven: if the appliance is switched on accidentally, the materials could catch fire.
- Contrôler toujours que les boutons sont bien dans la position "●"/"○" quand l'appareil n'est pas utilisé.
- When unplugging the appliance, always pull the plug from the mains socket; do not pull on the cable.
- Do not perform any cleaning or maintenance work without having disconnected the appliance from the electricity mains.
- If the event of malfunctions, under no circumstances should you attempt to perform the repairs yourself. Contact an authorised Service Centre (see Assistance).
- Do not rest objects on the open oven door.
- Do not let children play with the appliance.
- The appliance should not be operated by people (including children) with reduced physical, sensory or mental capacities, by inexperienced individuals or by anyone who is not familiar with the product. These individuals should, at the very least, be supervised by someone who assumes responsibility for their safety or receive preliminary instructions relating to the operation of the appliance.
- **The appliance is not intended to be operated by means of an external timer or separate remote-control system.**

### Disposal

- When disposing of packaging material: observe local legislation so that the packaging may be reused.
- The European Directive 2012/19/EU on Waste Electrical and Electronic Equipment (WEEE), requires that old household electrical appliances must not be disposed of in the normal unsorted municipal waste stream. Old appliances must be collected separately in order to optimise the recovery and recycling of the materials they contain and reduce the impact on human health and the environment.

The crossed out "wheeled bin" symbol on the product reminds you of your obligation, that when you dispose of the appliance it must be separately collected.

Consumers should contact their local authority or retailer for information concerning the correct disposal of their old appliance.

### Respecting and conserving the environment

- Whenever possible, avoid pre-heating the oven and always try to fill it. Open the oven door as little as possible because heat is lost every time it is opened. To save a substantial amount of energy, simply switch off the oven 5 to 10 minutes before the end of your planned cooking time and use the heat the oven continues to generate.
- Automatic programmes are based on standard food product.
- Keep gaskets clean and tidy to prevent any door energy losses.
- If you have a timed tariff electricity contract, the "delay cooking" option will make it easier to save money by moving operation to cheaper time periods.

! This product complies with the requirements of the latest European Directive on the limitation of power consumption of the standby mode.

## Maintenance and care

### Switching the appliance off

Disconnect your appliance from the electricity supply before carrying out any work on it.

### Cleaning the appliance

- Slight differences in colour on the front of the oven are due to the different materials used, i.e. glass, plastic or metal.
- Any shady areas resembling grooves on the oven door glass are caused by reflections from the oven light.
- The enamel is branded at very high temperatures. This process may cause colour variations. This is normal and will not affect appliance operation in any way. The thin edges of the sheet metal cannot be entirely enamelled and may therefore appear to be unfinished. This will not affect the rust protection.
- The stainless steel or enamel-coated external parts and the rubber seals may be cleaned using a sponge that has been soaked in lukewarm water and neutral soap. Use specialised products for the removal of stubborn stains. After cleaning, rinse and dry thoroughly. Do not use abrasive powders or corrosive substances.
- The inside of the oven should ideally be cleaned after each use, while it is still lukewarm. Use hot water and detergent, then rinse well and dry with a soft cloth. Do not use abrasive products.
- All accessories - with the exception of the sliding racks - can be washed like everyday crockery, and are even dishwasher safe.
- We recommend that detergents are not sprayed directly onto the control panel, but that a sponge is used instead.

! Never use steam cleaners or pressure cleaners on the appliance.

### Cleaning the oven door

Clean the glass part of the oven door using a sponge and a non-abrasive cleaning product, then dry thoroughly with a soft cloth. Do not use rough abrasive material or sharp metal scrapers as these could scratch the surface and cause the glass to crack.

For more thorough cleaning purposes, the oven door may be removed:

1. Open the oven door fully (see diagram).
2. Use a screwdriver to lift up and turn the small levers **F** located on the two hinges (see diagram).

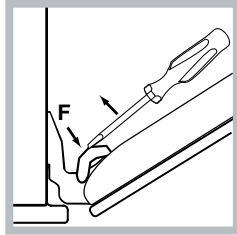
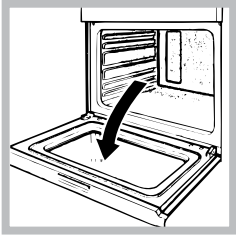

3. Grip the door on the two outer sides and close it approximately half way. Pull the door towards you, lifting it out of its slot (see diagram). To replace the door, reverse this sequence.

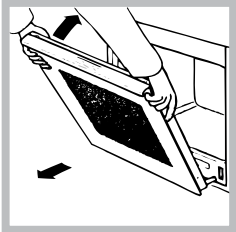

### Inspecting the seals

Check the door seals around the oven regularly. If the seals are damaged, please contact your nearest Service Centre (see Assistance). We recommend that the oven is not used until the seals have been replaced.

## VERY HOT SURFACES

Food or grease on these surfaces could cause smoke and possibly even burn

**YOU MUST KEEP THE OVEN AND GRILL CAVITIES CLEAN**

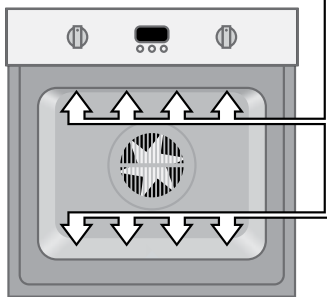

### Replacing the light bulb

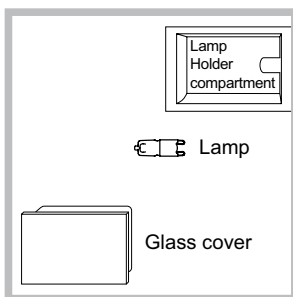

To replace the oven light bulb:

1. Remove the glass cover of the lamp-holder.
2. Remove the light bulb and replace it with a similar one: halogen lamp voltage 230 V, wattage 25 W, cap G 9.
3. Replace the glass cover (see diagram).

! Do not touch the light bulb directly with your hands.

! Do not use the oven lamp as/for ambient lighting.

\* Only available in certain models.

### Sliding rack kit assembly\*

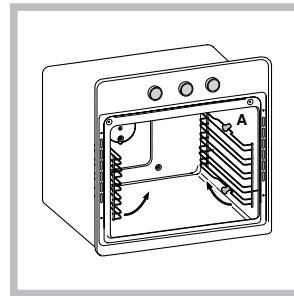

To assemble the sliding racks:

1. Remove the two frames, lifting them away from the spacers **A** (see figure).

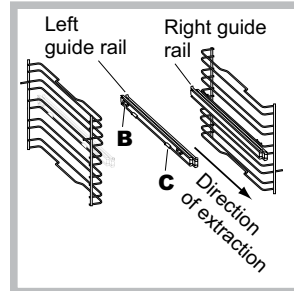

2. Choose which shelf to use with the sliding rack. Paying attention to the direction in which the sliding rack is to be extracted, position joint **B** and then joint **C** on the frame.

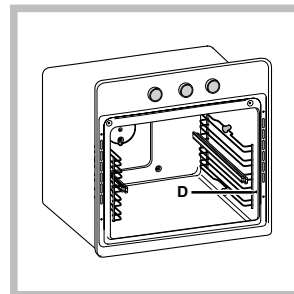

3. Secure the two frames with the guide rails using the holes provided on the oven walls (see diagram). The holes for the left frame are situated at the top, while the holes for the right frame are at the bottom.
4. Finally, fit the frames on the spacers **A**.

! Do not place the sliding racks in position 5.

### Side and rear catalytic liners\*

These are panels coated with a special enamel, which is able to absorb the fat released by food as it cooks.

This enamel is quite strong, so that the various accessories (racks, dripping pans, etc.) can slide along them without damaging them. White marks may appear on the surfaces; these are not a cause for concern.

Nevertheless, the following should be avoided:

- scraping the enamel with sharp objects (a knife, for example);
- using detergents or abrasive materials.



## Troubleshooting

<b>Problem</b>	<b>Possible cause</b>	<b>Solution</b>
The "Clock button" and the digits on the display flash.	The appliance has just been connected to the electricity mains or there has been a blackout.	Set the clock.
A programmed cooking mode does not start.	There has been a blackout.	Reprogram the cooking mode.
Only the high luminosity "Clock button" is lit.	The appliance is in standby mode.	Press any button to exit standby mode.
An automatic mode has been selected. "Hot" appears on the display and cooking does not start.	The temperature inside the oven is higher than the suggested value for the selected mode.	Wait for the oven to cool down.
Fan-assisted cooking has been selected and the food looks burnt.	Positions 1 and 5: the direct heat could cause temperature-sensitive foods to burn.	We recommend switching dripping pan positions halfway through cooking.



## After Sales Service

No one is better placed to care for your Hotpoint appliance during the course of its working life than us – the manufacturer.

### Essential Contact Information

#### Hotpoint Service

We are the largest service team in the country offering you access to 400 skilled telephone advisors and 1000 fully qualified engineers on call to ensure you receive fast, reliable, local service.

**UK: 08448 224 224**  
**Republic of Ireland: 0818 313 413**  
**[www.hotpointservice.co.uk](http://www.hotpointservice.co.uk)**

**Please note: Our advisors will require the following information:**

**Model number:**

**Serial number:**

#### Parts and Accessories

We supply a full range of genuine replacement parts as well as accessory products that protect and hygienically clean your appliance to keep it looking good and functioning efficiently throughout its life.

**UK: 08448 225 225**  
**Republic of Ireland: 0818 313 413**  
**[www.hotpointservice.co.uk](http://www.hotpointservice.co.uk)**

#### Appliance Registration

We want to give you additional benefits of Hotpoint ownership. To activate your free 5 year parts guarantee you must register your appliance with us.

**UK: 08448 24 24 24**  
**Republic of Ireland: 01 230 0800**  
**[www.hotpointservice.co.uk](http://www.hotpointservice.co.uk)**

**Indesit Company UK Ltd. Morley Way, Peterborough, PE2 9JB**  
Indesit Company Unit 49 Airways Industrial Estate, Dublin 17

#### Recycling and Disposal Information

As part of Hotpoint's continued commitment to helping the environment, Hotpoint reserves the right to use quality, recycled components to keep down customer costs and minimise material wastage.

Please dispose of packaging and old appliances carefully. To minimise the risk of injury to children, remove the door, plug, and cut the mains cable off flush with the appliance. Dispose of these parts separately to ensure that the appliance can no longer be plugged into mains socket, and the door cannot be locked shut.

## Guarantee

### 12 months Parts and Labour Guarantee

Your appliance has the benefit of our manufacturer's guarantee, which covers the cost of breakdown repairs for twelve months from the date of purchase.

This gives you the reassurance that if, within that time, your appliance is proven to be defective because of either workmanship or materials, we will, at our discretion, either repair or replace the appliance at no cost to you.

This guarantee is subject to the following conditions:

- The appliance has been installed and operated correctly and in accordance with our operating and maintenance instructions.
- The appliance is used only on the electricity or gas supply printed on the rating plate.
- The appliance has been used for normal domestic purposes only.
- The appliance has not been altered, serviced, maintained, dismantled, or otherwise interfered with by any person not authorised by us.
- Any repair work must be undertaken by us or our appointed agent.
- Any parts removed during repair work or any appliance that is replaced become our property.
- The appliance is used in the United Kingdom or Republic of Ireland.

The guarantee does not cover:

- Damage resulting from transportation, improper use, neglect or interference or as a result of improper installation
- Replacement of any consumable item or accessory. These included but not limited to: plugs, cables, batteries, light bulbs, fluorescent tubes and starters, covers and filters.
- Replacement of any removable parts made of glass or plastic.

THIS GUARANTEE WILL NOT APPLY IF THE APPLIANCE HAS BEEN USED IN COMMERCIAL OR NON-DOMESTIC PREMISES.

### 5 Year Parts Guarantee

Hotpoint also offers you a free 5 year parts guarantee. This additional guarantee is conditional on you registering your appliance with us and the parts being fitted by one of our authorised engineers. There will be a charge for our engineer's time. To activate the extra parts warranty on your appliance, simply call our registration line on **08448 24 24 24 (Republic of Ireland 01 230 0800)**

### Extended Guarantees

We offer a selection of protection plans that enable you to fully cover yourself against the expense of repair bills for the life of your policy. To find the ideal plan for you please call our advice line on **08448 226 226 (Republic of Ireland 01 230 0233)**.

### Free Helpdesk Service

We have a dedicated team who can provide free advice and assistance with your appliance if you experience any technical difficulties within the first 90 days of ownership. Simply call our Hotpoint Service Hotline on **08448 224 224 (Republic of Ireland 0818 313 413)** for telephone assistance, or, where necessary, to arrange for an engineer to call.

#### Indesit Company S.p.A.

Viale Aristide Merloni, 47  
60044 Fabriano (AN)  
www.hotpoint.co.uk