



Lexmark X264dn, X363dn, X364dn, and X364dw

User's Guide

August 2011

www.lexmark.com

Machine type(s):

7013

Model(s):

231, 235, 432, 436, 43W, d01, d02, gd1, gd2, dn1, dn2, gd1, gd2

Contents

- Safety information.....6**
- Learning about the printer.....8**
 - Thank you for choosing this printer!.....8
 - Finding information about the printer.....8
 - Selecting a location for the printer.....9
 - Printer configurations.....10
 - Basic functions of the scanner.....13
 - Understanding the ADF and scanner glass.....14
 - Understanding the printer control panel.....15
- Additional printer setup.....19**
 - Installing internal options.....19
 - Installing hardware options.....21
 - Attaching cables.....22
 - Verifying printer setup.....23
 - Setting up the printer software.....24
 - Setting up wireless printing.....26
 - Installing the printer on a wired network.....31
- Minimizing your printer's environmental impact.....34**
 - Saving paper and toner.....34
 - Saving energy.....35
 - Recycling.....36
 - Reducing printer noise.....37
- Loading paper and specialty media.....39**
 - Setting the Paper Size and Paper Type.....39
 - Configuring Universal paper settings.....39
 - Avoiding jams.....40
 - Loading trays.....41
 - Using a multipurpose or manual feeder.....45
 - Paper capacities.....50
 - Linking and unlinking trays.....51

Paper and specialty media guidelines.....	53
Paper guidelines.....	53
Storing paper.....	55
Supported paper sizes, types, and weights.....	56
Printing.....	59
Printing a document.....	59
Printing from a flash drive.....	59
Printing on both sides of the paper (duplexing).....	61
Printing specialty documents.....	61
Printing information pages.....	65
Canceling a print job.....	66
Copying.....	68
Making copies.....	68
Copying photos.....	69
Copying on specialty media.....	69
Customizing copy settings.....	70
Pausing the current print job to make copies.....	75
Placing an overlay message on each page.....	75
Canceling a copy job.....	76
Improving copy quality.....	76
E-mailing.....	77
Getting ready to e-mail.....	77
Creating an e-mail shortcut using the Embedded Web Server.....	78
E-mailing a document.....	78
Canceling an e-mail.....	80
Faxing.....	81
Getting the printer ready to fax.....	81
Sending a fax.....	93
Creating shortcuts.....	96
Using shortcuts and the address book.....	97
Customizing fax settings.....	98
Canceling an outgoing fax.....	100
Understanding fax options.....	101

Improving fax quality.....	102
Scanning to a computer or flash drive.....	103
Scanning to a computer.....	103
Scanning to a flash drive.....	104
Understanding the Scan Center features.....	104
Understanding scan profile options.....	105
Improving scan quality.....	106
Understanding printer menus.....	108
Menus list.....	108
Paper menu.....	108
Reports menu.....	115
Network/Ports menu.....	116
Settings menu.....	122
Maintaining the printer.....	146
Cleaning the exterior of the printer.....	146
Cleaning the scanner glass.....	146
Cleaning the ADF separator rollers.....	147
Storing supplies.....	148
Checking the status of supplies from a network computer.....	148
Moving the printer to another location.....	149
Shipping the printer.....	149
Ordering supplies.....	150
Replacing supplies.....	151
Administrative support.....	157
Finding advanced networking and administrator information.....	157
Restoring the factory default settings.....	157
Using the Embedded Web Server.....	157
Viewing reports.....	158
Checking the device status.....	158
Restricting access to printer menus.....	158
Setting up e-mail alerts.....	159
Configuring supply notifications.....	159
Copying printer settings to other printers.....	159

Clearing jams.....	161
Clearing jams.....	161
Troubleshooting.....	176
Solving basic printer problems.....	176
Printer control panel display is blank or displays only diamonds.....	176
Understanding printer messages.....	176
Solving printing problems.....	187
Solving copy problems.....	190
Solving scanner problems.....	192
Solving fax problems.....	194
Solving option problems.....	198
Solving paper feed problems.....	199
Solving print quality problems.....	200
Embedded Web Server does not open.....	209
Contacting Customer Support.....	210
Notices.....	211
Product information.....	211
Edition notice.....	211
Power consumption.....	215
Index.....	229

Safety information

Connect the power supply cord to a properly grounded electrical outlet that is near the product and easily accessible.

 **CAUTION—SHOCK HAZARD:** Do not use the fax feature during a lightning storm. Do not set up this product or make any electrical or cabling connections, such as the fax feature, power cord, or telephone, during a lightning storm.

Refer service or repairs, other than those described in the user documentation, to a professional service person.

This product is designed, tested, and approved to meet strict global safety standards with the use of specific Lexmark components. The safety features of some parts may not always be obvious. Lexmark is not responsible for the use of other replacement parts.

 **CAUTION—SHOCK HAZARD:** Make sure that all external connections (such as Ethernet and telephone system connections) are properly installed in their marked plug-in ports.

 **CAUTION—POTENTIAL INJURY:** This product uses a laser. Use of controls or adjustments or performance of procedures other than those specified herein may result in hazardous radiation exposure.

This product uses a printing process that heats the print media, and the heat may cause the media to release emissions. You must understand the section in your operating instructions that discusses the guidelines for selecting print media to avoid the possibility of harmful emissions.

 **CAUTION—HOT SURFACE:** The fuser and the inside of the printer near the fuser may be hot. To reduce the risk of injury from a hot component, allow the surface to cool before removing paper from this area.

 **CAUTION—HOT SURFACE:** The inside of the printer might be hot. To reduce the risk of injury from a hot component, allow the surface to cool before touching.

Use care when you replace a lithium battery.

 **CAUTION—POTENTIAL INJURY:** There is a danger of explosion if a lithium battery is incorrectly replaced. Replace it only with the same or an equivalent type of lithium battery. Do not recharge, disassemble, or incinerate a lithium battery. Discard used batteries according to the manufacturer's instructions and local regulations.

Use only the telecommunications (RJ-11) cord provided with this product or a 26 AWG or larger replacement when connecting this product to the public switched telephone network.

 **CAUTION—POTENTIAL INJURY:** Do not cut, twist, bind, crush, or place heavy objects on the power cord. Do not subject the power cord to abrasion or stress. Do not pinch the power cord between objects such as furniture and walls. If any of these things happen, a risk of fire or electrical shock results. Inspect the power cord regularly for signs of such problems. Remove the power cord from the electrical outlet before inspecting it.

 **CAUTION—SHOCK HAZARD:** To avoid the risk of electric shock when cleaning the exterior of the printer, unplug the power cord from the wall outlet and disconnect all cables from the printer before proceeding.

 **CAUTION—SHOCK HAZARD:** If you are installing an optional drawer after setting up the printer, then turn the printer off and unplug the power cord from the wall outlet before continuing.

 **CAUTION—SHOCK HAZARD:** If you are accessing the system board or installing optional hardware or memory devices sometime after setting up the printer, then turn the printer off, and unplug the power cord from the wall outlet before continuing. If you have any other devices attached to the printer, then turn them off as well, and unplug any cables going into the printer.

 **CAUTION—POTENTIAL INJURY:** The printer weight is greater than 18 kg (40 lb) and requires two or more trained personnel to move it safely.



CAUTION—POTENTIAL INJURY: Follow these guidelines to avoid personal injury or printer damage:

- Turn the printer off using the power switch, and then unplug the power cord from the wall outlet.
- Disconnect all cords and cables from the printer before moving it.
- Use the handholds located on both sides of the printer to lift it.
- Make sure your fingers are not under the printer when you set it down.
- Before setting up the printer, make sure there is adequate clearance around it.

SAVE THESE INSTRUCTIONS.

Learning about the printer

Thank you for choosing this printer!

We've worked hard to make sure it will meet your needs.

To start using your new printer right away, use the setup materials that came with the printer, and then skim the *User's Guide* to learn how to perform basic tasks. To get the most out of your printer, read the *User's Guide* carefully, and make sure you check the latest updates on our Web site.

We're committed to delivering performance and value with our printers, and we want to make sure you're satisfied. If you do encounter any problems along the way, one of our knowledgeable support representatives will be delighted to help you get back on track fast. And if you find something we could do better, please let us know. After all, you are the reason we do what we do, and your suggestions help us do it better.

Finding information about the printer

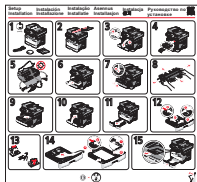
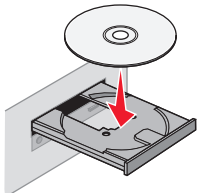
What are you looking for?	Find it here
<p>Initial setup instructions:</p> <ul style="list-style-type: none"> • Connecting the printer • Installing the printer software 	<p>Setup documentation—The setup documentation came with the printer and is also available on the Lexmark Web site at www.lexmark.com/publications/.</p> 
<p>Additional setup and instructions for using the printer:</p> <ul style="list-style-type: none"> • Selecting and storing paper and specialty media • Loading paper • Performing printing, copying, scanning, and faxing tasks, depending on your printer model • Configuring printer settings • Viewing and printing documents and photos • Setting up and using printer software • Setting up and configuring the printer on a network, depending on your printer model • Caring for and maintaining the printer • Troubleshooting and solving problems 	<p><i>User's Guide</i>—The <i>User's Guide</i> is available on the <i>Software and Documentation CD</i>.</p>  <p>For updates, check our Web site at www.lexmark.com/publications/.</p>

What are you looking for?	Find it here
Help using the printer software	<p>Windows or Mac Help—Open a printer software program or application, and then click Help.</p> <p>Click  to view context-sensitive information.</p> <p>Notes:</p> <ul style="list-style-type: none"> • The Help installs automatically with the printer software. • The printer software is located in the printer Program folder or on the desktop, depending on your operating system.
<p>The latest supplemental information, updates, and technical support:</p> <ul style="list-style-type: none"> • Documentation • Driver downloads • Live chat support • E-mail support • Telephone support 	<p>Lexmark Support Web site—support.lexmark.com</p> <p>Note: Select your region, and then select your product to view the appropriate support site.</p> <p>Support telephone numbers and hours of operation for your region or country can be found on the Support Web site or on the printed warranty that came with your printer.</p> <p>Record the following information (located on the store receipt and the back of the printer), and have it ready when you contact support so that they may serve you faster:</p> <ul style="list-style-type: none"> • Machine Type number • Serial number • Date purchased • Store where purchased
Warranty information	<p>Warranty information varies by country or region:</p> <ul style="list-style-type: none"> • In the US—See the Statement of Limited Warranty included with this printer, or at support.lexmark.com. • Rest of the world—See the printed warranty that came with your printer.

Selecting a location for the printer

 **CAUTION—POTENTIAL INJURY:** The printer weight is greater than 18 kg (40 lbs) and requires two or more trained personnel to lift it safely.

When selecting a location for the printer, leave enough room to open trays, covers, and doors. If you plan to install any options, leave enough room for them also. It is important to:

- Make sure airflow in the room meets the latest revision of the ASHRAE 62 standard.
- Provide a flat, sturdy, and stable surface.
- Keep the printer:
 - Away from the direct airflow of air conditioners, heaters, or ventilators
 - Free from direct sunlight, humidity extremes, or temperature fluctuations
 - Clean, dry, and free of dust

- Allow the following recommended amount of space around the printer for proper ventilation:

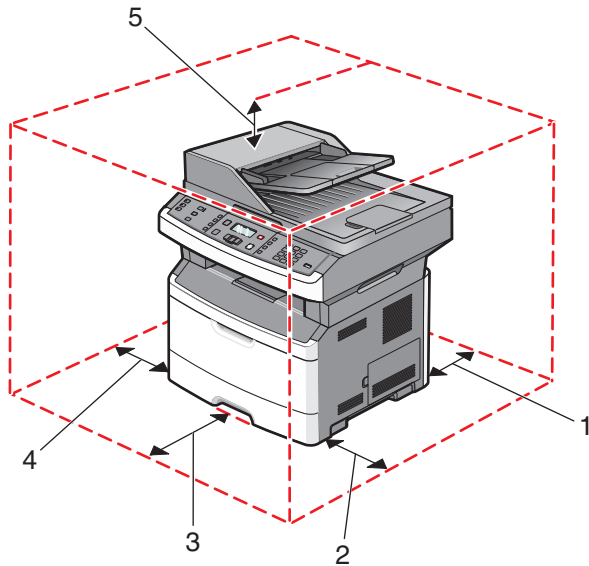

1	Rear	305 mm (12 in.)
2	Right side	203 mm (8 in.)
3	Front	203 mm (8 in.)
4	Left side	76 mm (3 in.)
5	Top	254 mm (10 in.)

Printer configurations

Basic model

The following illustration shows the printer front with its basic features or parts:

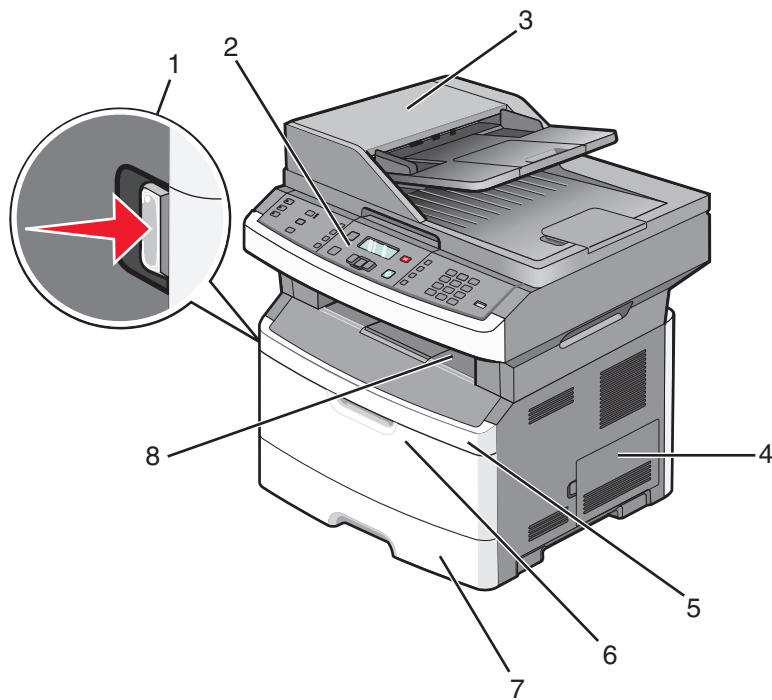

1	Front door release button
2	Printer control panel
3	Automatic Document Feeder (ADF)
4	System board door
5	Front door
6	Multipurpose feeder door Note: Depending on your printer model, this could be the manual feeder door.
7	Standard 250-sheet tray (Tray 1)
8	Standard exit bin

The following illustration shows the printer back with its basic features or parts:

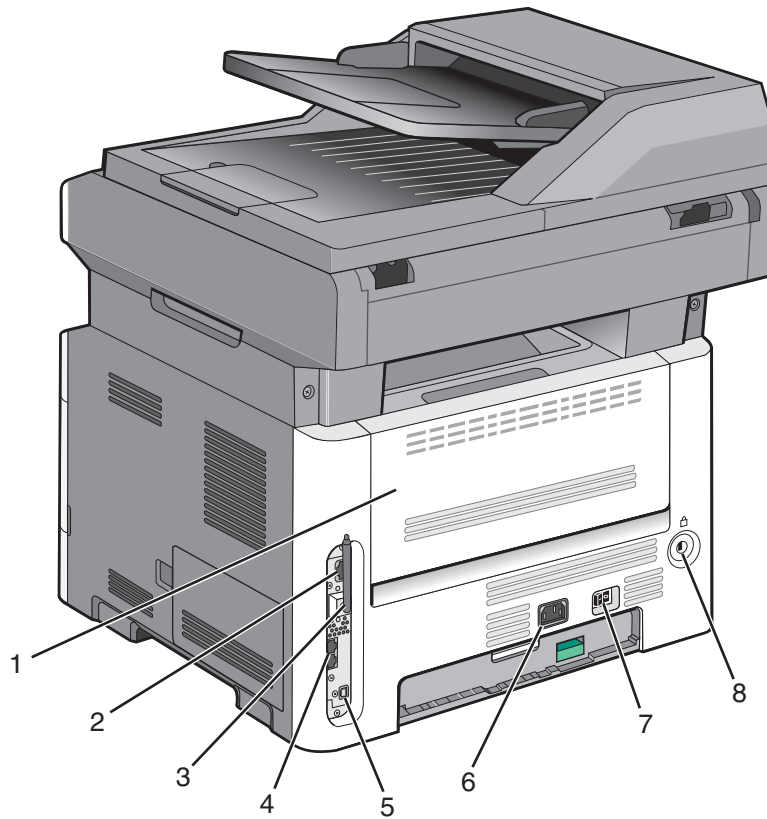

1	Rear door
2	Ethernet port
3	Wireless antenna Note: The wireless antenna appears on wireless models only.
4	Fax ports Note: Fax ports appear on fax models only.
5	USB port
6	Printer power cord socket
7	Power switch
8	Locking device

Configured model

The following illustration shows the printer configured with an optional 250- or 550-sheet drawer:

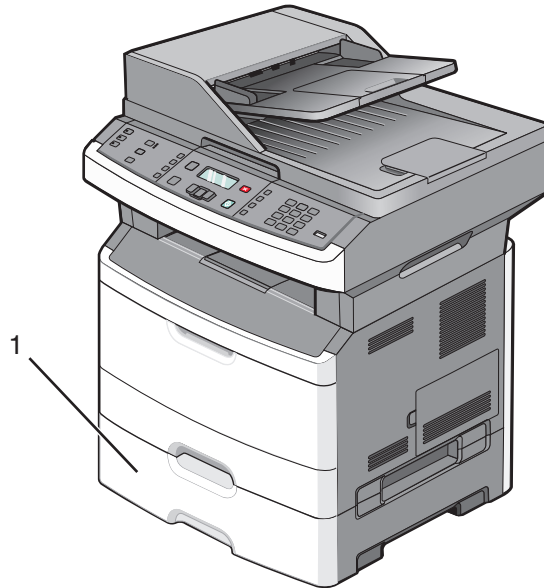

1 Optional 250- or 550-sheet drawer (Tray 2)

Basic functions of the scanner

The scanner provides copy, fax, and scan capability. You can:

- Make quick copies, or change the settings on the printer control panel to perform specific copy jobs.
- Send a fax using the printer control panel.
- Send a fax to multiple fax destinations at the same time.
- Scan documents and send them to your computer, an e-mail address, or a flash drive.

Note: The fax function is available on selected printer models only.

Understanding the ADF and scanner glass

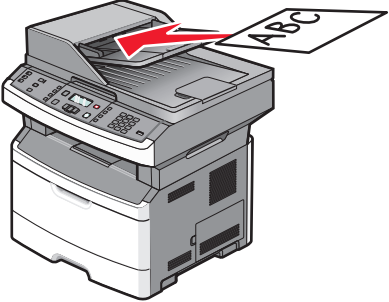
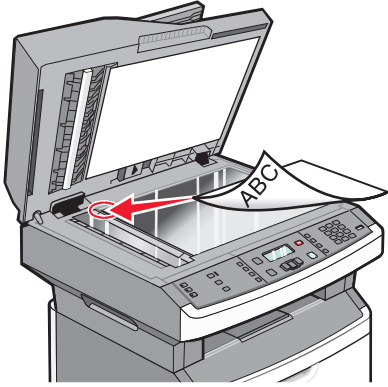
Automatic Document Feeder (ADF)	Scanner glass
 <p data-bbox="151 766 613 793">Use the ADF for multiple-page documents.</p>	 <p data-bbox="630 766 1409 861">Use the scanner glass for single pages, small items (such as postcards or photos), transparencies, photo paper, or thin media (such as magazine clippings).</p>

Using the ADF

The ADF can scan multiple pages, including two-sided pages on some models. When using the ADF:

- Load the document into the ADF faceup, short edge first.
- Adjust the paper guides to touch the sides of the paper loaded.
- Remove staples before loading.
- Separate punched sheets before loading.
- Load up to 50 sheets of plain paper in the ADF input tray, based on 75 g/m² (20 lb.) paper.
- Scan sizes from 124.46 x 127 mm (4.9 x 5 in.) to 215.9 x 355.6 mm (8.5 x 14 in.).
- Scan documents with mixed page sizes (letter and legal).
- Scan media weights from 52 to 120 g/m² (14 to 32 lb).
- Do not load postcards, photos, small items, transparencies, photo paper, or thin media (such as magazine clippings) into the ADF. Place these items on the scanner glass.

Using the scanner glass

The scanner glass can be used to scan or copy single pages or book pages. When using the scanner glass:

- Place a document facedown on the scanner glass in the upper left corner.
- Scan or copy documents up to 215.9 x 297.18 mm (8.5 x 11.7 in.).
- Copy books up to 25.3-mm (1-in.) thick.

Understanding the printer control panel

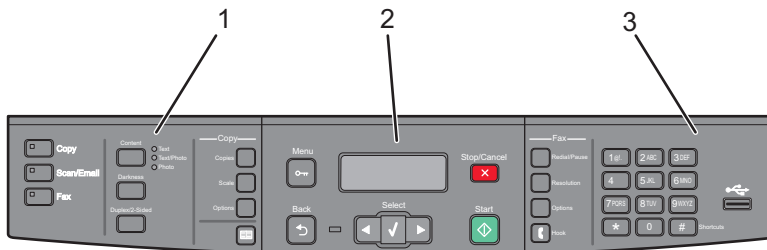



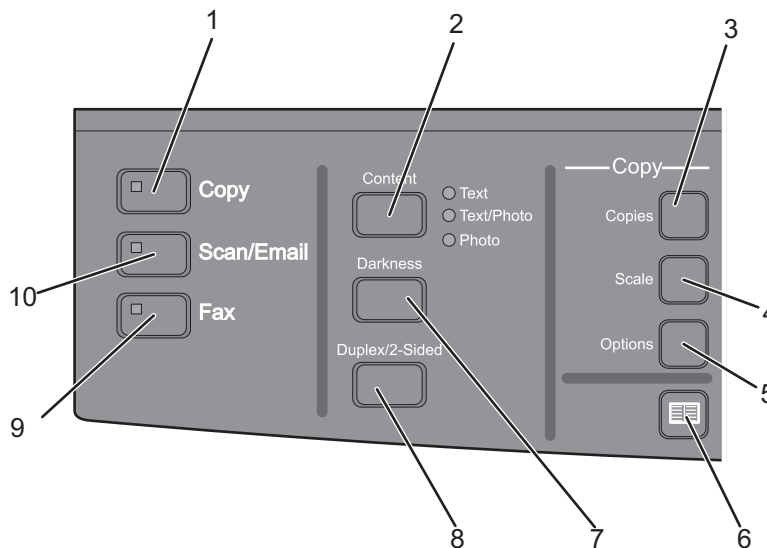

Item	Description
1	Selections and settings Select a function such as Copy, Scan, Email, or Fax. Change default copy and scan settings such as the number of copies, duplex printing, copy options, and scaling. Use the address book when scanning to e-mail.
2	Display area View scanning, copying, faxing, and printing options as well as status and error messages. Access the administration menus, start, stop, or cancel a print job.
3	Keypad area Enter numbers, letters, or symbols on the display, print using the USB flash memory device, or change the default fax settings.



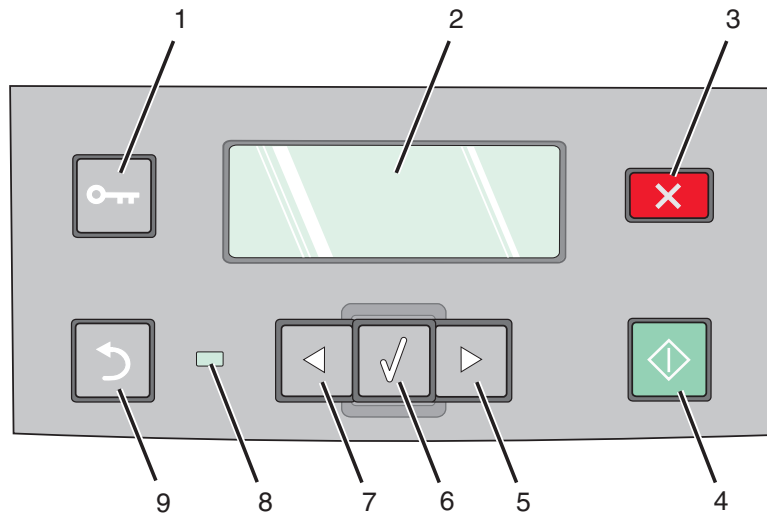



Item	Description
1	Copy Enters the copy function
2	Content Enhances copy, scan, e-mail, or fax quality. Choose from Text, Text/Photo, or Photo.
3	Copies Enters the number of copies to print
4	Scale Changes the size of the copied document to fit onto the currently selected paper size
5	Options Changes Original Size, Paper Source, and Collate settings
6	Address Book Opens the address book
7	Darkness Adjusts the current darkness settings

Item	Description	
8	Duplex 2-Sided	Makes a two-sided copy Note: On selected printer models, you can also perform two-sided scan jobs.
9	Fax	Enters the fax function Note: Fax mode is not available on selected printer models.
10	Scan/Email	Enters the scan or scan to e-mail function







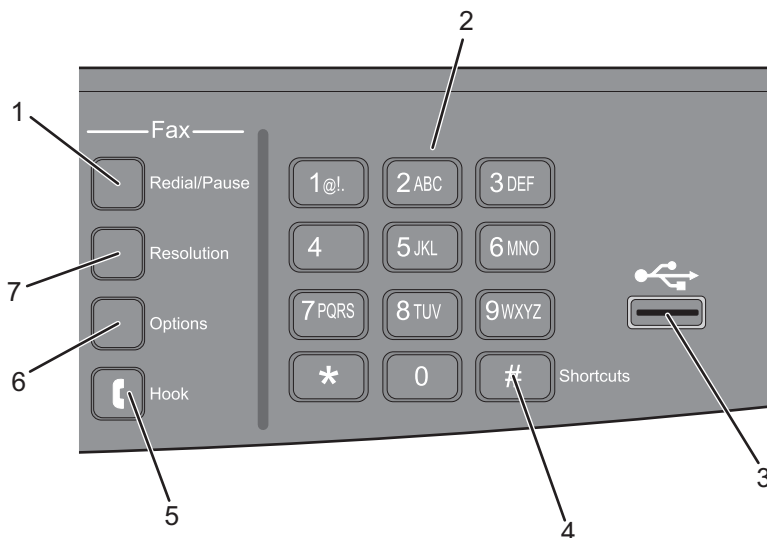

Item	Description	
1	Menu 	Enters the administration menus
2	Display	View scanning, copying, faxing, and printing options as well as status and error messages.
3	Stop/Cancel 	Stops all printer activity
4	Start 	Starts a copy or scan job
5	Right arrow 	Scrolls right

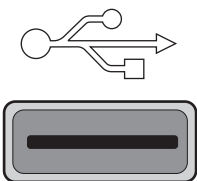
Item	Description	
6	Select 	Accepts menu selections and settings
7	Left arrow 	Scrolls left
8	Indicator light 	<ul style="list-style-type: none"> • Off—The power is off. • Blinking green—The printer is warming up, processing data, or printing. • Solid green—The printer is on, but idle. • Blinking red—Operator intervention is needed.
9	Back 	<p>Returns one screen at a time to the Ready screen</p> <p>Note: An error beep sounds when you press  if a flash drive is connected and the USB menu is displayed.</p>



Item	Description	
1	Redial/Pause	<ul style="list-style-type: none"> • Press once to cause a two- or three-second dial pause in a fax number. In the "Fax To" field, a Dial Pause is represented by a comma (,). • Press to redial a fax number.
2	Keypad	Enters numbers, letters, or symbols on the display

Item		Description
3	Front USB port 	Lets you scan to a flash drive or print supported file types Notes: <ul style="list-style-type: none"> • The front USB port is available only on selected printer models. • When a USB flash memory device is inserted into the printer, the printer can only scan to the USB device or print files from the USB device. All other printer functions are unavailable.
4	Shortcuts 	Enters the shortcut screen
5	Hook 	Press  once to take the telephone line off-hook (like picking up a telephone receiver). Press  a second time to hang up the line. Note: The Hook button is available only on selected printer models.
6	Options	Changes Original Size, Broadcast, Delayed Send, and Cancel settings
7	Resolution	Selects a dpi value for the scan Note: Press the arrow buttons to scroll through the values, and then press  to enter a value.

Additional printer setup

Installing internal options

CAUTION—SHOCK HAZARD: If you are accessing the system board or installing optional hardware or memory devices sometime after setting up the printer, then turn the printer off, and unplug the power cord from the wall outlet before continuing. If you have any other devices attached to the printer, then turn them off as well, and unplug any cables going into the printer.

Installing a flash memory card

The system board has a connection for one optional flash memory card.

CAUTION—SHOCK HAZARD: If you are accessing the system board or installing optional hardware or memory devices sometime after setting up the printer, then turn the printer off, and unplug the power cord from the wall outlet before continuing. If you have any other devices attached to the printer, then turn them off as well, and unplug any cables going into the printer.

Warning—Potential Damage: System board electronic components are easily damaged by static electricity. Touch something metal on the printer before touching any system board electronic components or connectors.

- 1 Access the system board.

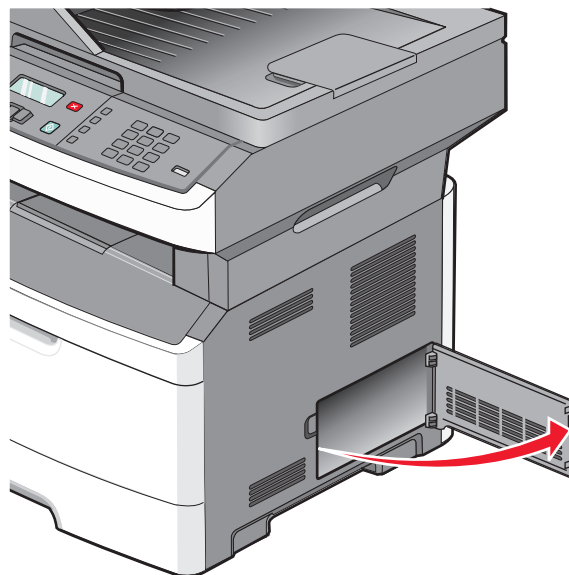

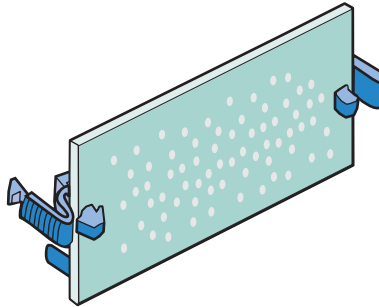
2 Unpack the card.

Note: Avoid touching the connection points along the edge of the card.

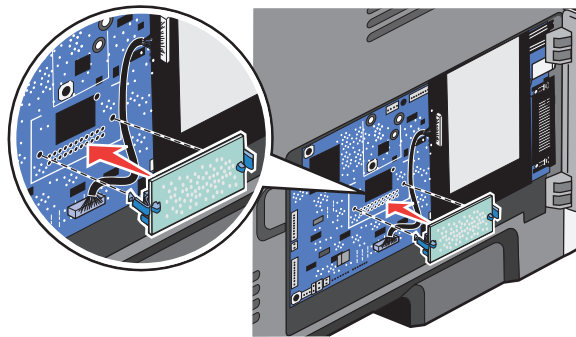
3 Holding the card by its sides, align the card with the connector on the system board.**4** Push the card firmly into place.**Notes:**

- The entire length of the connector on the card must touch and be flush against the system board.
- Be careful not to damage the connectors.
- If your printer model does not fax, your system board will not have the fax card attached to the system board.

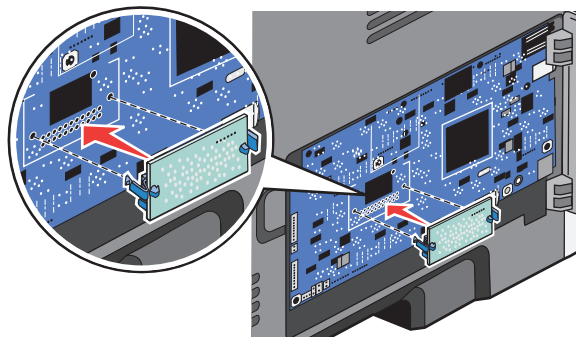
**5** Close the system board door.

Installing hardware options

Installing a 250- or 550-sheet drawer

The printer supports one optional drawer; you can install a 250- or 550-sheet drawer.

⚠ CAUTION—SHOCK HAZARD: If you are accessing the system board or installing optional hardware or memory devices sometime after setting up the printer, then turn the printer off, and unplug the power cord from the wall outlet before continuing. If you have any other devices attached to the printer, then turn them off as well, and unplug any cables going into the printer.

- 1 Unpack the drawer, and then remove any packing material from the outside of the drawer.
- 2 Remove the tray from the support unit.

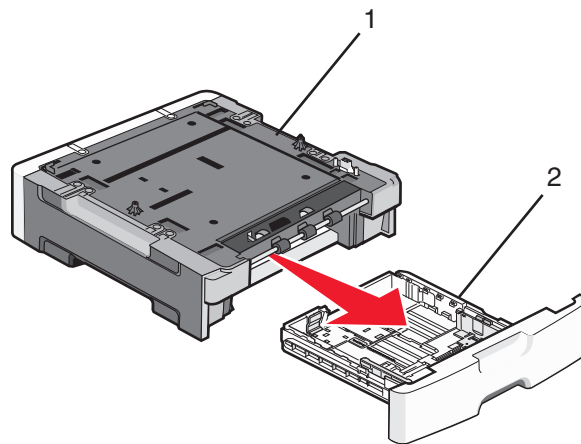

1	Support unit
2	Tray

- 3 Remove any packing material and tape from inside the tray.
- 4 Insert the tray into the support unit.
- 5 Place the drawer in the location chosen for the printer.

6 Align the printer with the drawer, and then lower the printer into place.

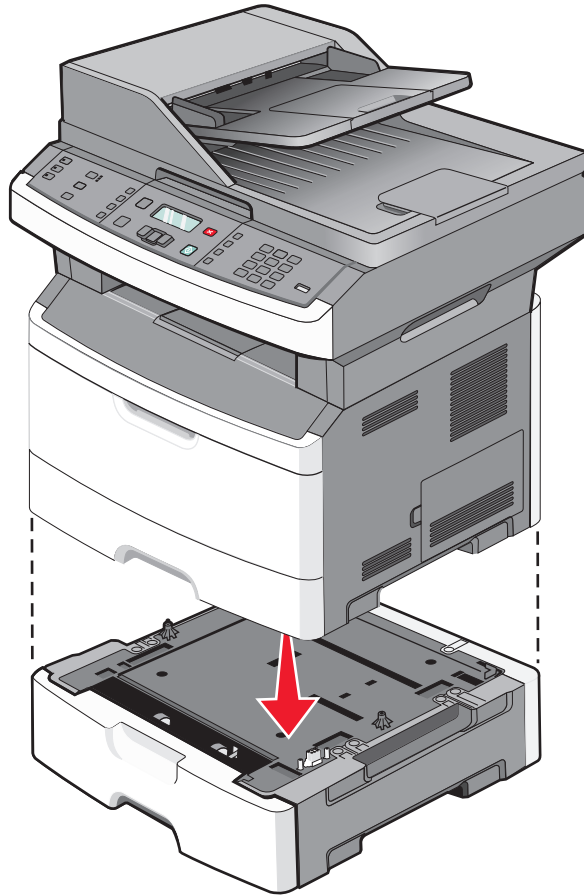

Attaching cables

- 1 Connect the printer to a computer or a network.
 - For a local connection, use a USB cable.
 - For a network connection, use an Ethernet cable.
- 2 Connect the power cord to the printer first and then to a wall outlet.

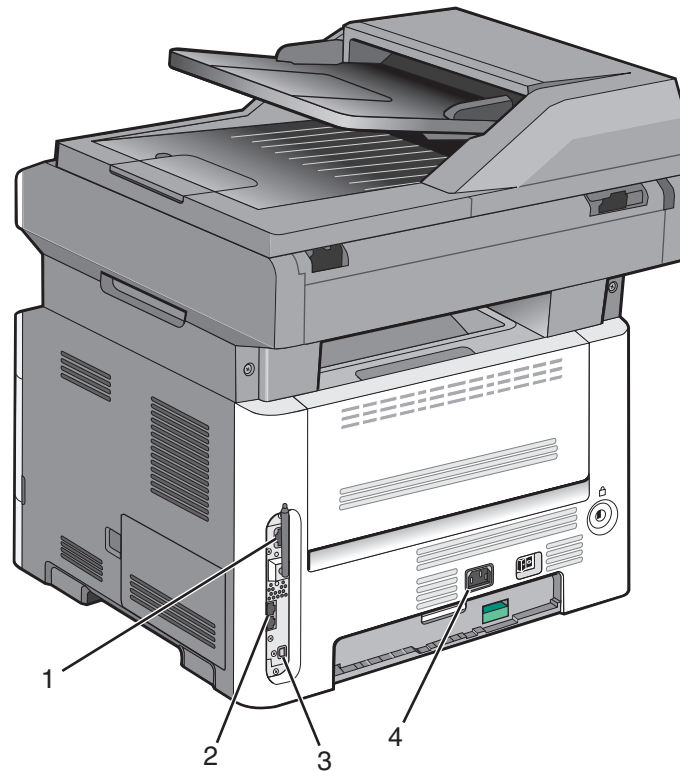

1	Ethernet port
2	Fax ports Note: The fax ports are available on selected printer models only.
3	USB port
4	Printer power cord socket

Verifying printer setup



Once all hardware and software options are installed and the printer is turned on, verify that the printer is set up correctly by printing the following:

- **Menu settings page**—Use this page to verify that all printer options are installed correctly. A list of installed options appears toward the bottom of the page. If an option you installed is not listed, then it is not installed correctly. Remove the option and install it again.
- **Network setup page**—If your printer is a network model and is attached to a network, print a network setup page to verify the network connection. This page also provides important information that aids network printing configuration.

Printing a menu settings page





Print a menu settings page to review the current menu settings and to verify printer options are installed correctly.

Note: If you have not made any menu item settings changes yet, then the menu settings page lists all the factory default settings. Once you select and save other settings from the menus, they replace the factory default settings as *user default settings*. A user default setting remains in effect until you access the menu again, choose another value, and save it.

- 1 Make sure the printer is on and **Ready** appears.
 - 2 From the printer control panel, press .
 - 3 Press the arrow buttons until **Reports** appears, and then press .
 - 4 Press the arrow buttons until **Menu Settings Page** appears, and then press .
- After the menu settings page prints, **Ready** appears.

Printing a network setup page

If the printer is attached to a network, print a network setup page to verify the network connection. This page also provides important information that aids network printing configuration.

- 1 Make sure the printer is on and **Ready** appears.
 - 2 From the printer control panel, press .
 - 3 Press the down arrow button until  **Reports** appears, and then press .
 - 4 Press the down arrow button until  **Network Setup Page** appears, and then press .
- After the network setup page prints, **Ready** appears.
- 5 Check the first section on the network setup page, and confirm that Status is “Connected.”
- If Status is “Not Connected,” the LAN drop may not be active, the network cable may be malfunctioning, or, if you have a wireless printer model, the wireless network may not be configured properly. Consult a system support person for a solution, and then print another network setup page.

Setting up the printer software

Installing printer software

A printer driver is software that lets the computer communicate with the printer. The printer software is typically installed during the initial printer setup. If you need to install the software after setup, follow these instructions:

For Windows users

- 1 Close all open software programs.
- 2 Insert the *Software and Documentation* CD.
- 3 From the main installation dialog, click **Install**.
- 4 Follow the instructions on the screen.

For Macintosh users

- 1 Close all open software applications.
- 2 Insert the *Software and Documentation* CD.
- 3 From the Finder desktop, double-click the printer CD icon that automatically appears.
- 4 Double-click the **Install** icon.
- 5 Follow the instructions on the screen.

Using the World Wide Web

- 1 Go to the Lexmark Web site at **www.lexmark.com**.
- 2 From the Drivers & Downloads menu, click **Driver Finder**.
- 3 Select your printer, and then select your operating system.
- 4 Download the driver and install the printer software.

Updating available options in the printer driver

Once the printer software and any options are installed, it may be necessary to manually add the options in the printer driver to make them available for print jobs.

For Windows users

- 1 Click , or click **Start** and then click **Run**.
- 2 In the Start Search or Run box, type **control printers**.
- 3 Press **Enter**, or click **OK**.
The printer folder opens.
- 4 Select the printer.
Note: If the printer has a fax option, choose the appropriate printer model with the letters "PS."
- 5 Right-click the printer, and then select **Properties**.
- 6 Click the **Install Options** tab.
- 7 Under Available Options, add any installed hardware options.
Note: If the printer has a fax option, select **Fax**, and then add it as an installed option.
- 8 Click **Apply**.

For Macintosh users

In Mac OS X version 10.5 or later

- 1 From the Apple menu, choose **System Preferences**.
- 2 Click **Print & Fax**.
- 3 Select the printer, and then click **Options & Supplies**.

4 Click **Driver**, and then add any installed hardware options.

5 Click **OK**.

In Mac OS X version 10.4 and earlier

1 From the Finder desktop, choose **Go > Applications**.

2 Double-click **Utilities**, and then double-click **Print Center** or **Printer Setup Utility**.

3 Select the printer, and then from the Printers menu, choose **Show Info**.

4 From the pop-up menu, choose **Installable Options**.

5 Add any installed hardware options, and then click **Apply Changes**.

Setting up wireless printing

Note: Wireless printing is available on select printer models only.

Information you will need to set up the printer on a wireless network

Note: Do not connect the installation or network cables until prompted to do so by the setup software.

- **SSID**—The SSID is also referred to as the network name.
- **Wireless Mode (or Network Mode)**—The mode will be either infrastructure or ad hoc.
- **Channel (for ad hoc networks)**—The channel defaults to auto for infrastructure networks.

Some ad hoc networks will also require the auto setting. Check with your system support person if you are not sure which channel to select.

- **Security Method**—There are three basic options for Security Method:

- WEP key

If your network uses more than one WEP key, enter up to four in the provided spaces. Select the key currently in use on the network by selecting the Default WEP Transmit Key.

or

- WPA or WPA2 passphrase

WPA includes encryption as an additional layer of security. The choices are AES or TKIP. Encryption must be set for the same type on the router and on the printer, or the printer will not be able to communicate on the network.

- No security

If your wireless network does not use any type of security, then you will not have any security information.

Note: Using an unsecured wireless network is not recommended.

If you are installing the printer on an 802.1X network using the Advanced method, then you may need the following:

- Authentication type
- Inner authentication type
- 802.1X username and password
- Certificates

Note: For more information on configuring 802.1X security, see the *Networking Guide* on the *Software and Documentation CD*.

Installing the printer on a wireless network (Windows)

Before you install the printer on a wireless network, make sure that:

- Your wireless network is set up and working properly.
- The computer you are using is connected to the same wireless network where you want to set up the printer.

1 Connect the power cable to the printer and then to a properly grounded electrical outlet, and then turn the printer on.

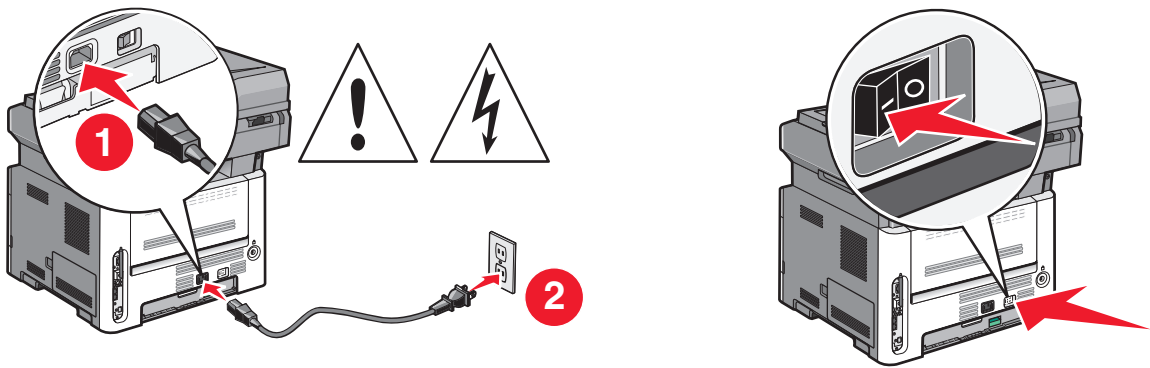

Note: For fax setup, see the *User's Guide* on the *Software and Documentation CD*.



Make sure the printer and computer are fully on and ready.



Do not connect the USB cable until instructed to do so on the screen.

2 Insert the *Software and Documentation CD*.

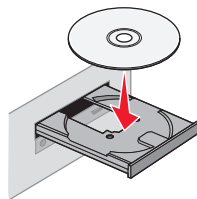

3 Click **Install Printer and Software**.

4 Click **Agree** to accept the terms of the License Agreement.

5 Select **Suggested** and then click **Next**.

6 Click **Wireless Network Attach**.

- 7 Remove the label covering the USB port on the back of the printer.

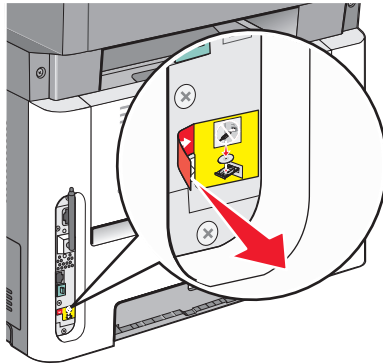

- 8 Temporarily connect a USB cable between the computer on the wireless network and the printer.

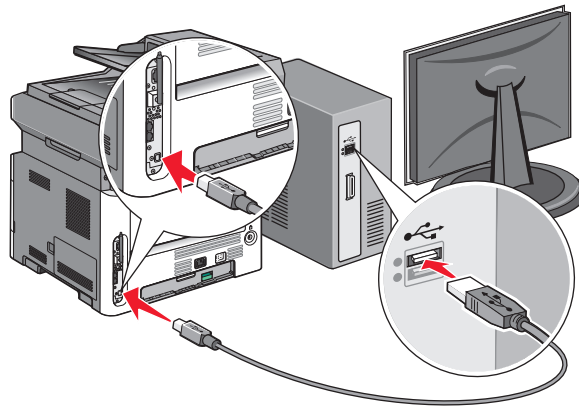

Notes:

- After the printer is configured, the software will instruct you to disconnect the temporary USB cable so you can print wirelessly.
- If your printer has faxing capabilities, then connect the telephone cable.

- 9 Follow the on-screen instructions to complete the software installation.

Note: **Basic** is the recommended path to choose. Choose **Advanced** only if you want to customize your installation.

- 10 To allow other computers on the wireless network to use the wireless printer, follow steps 2 through 6 for each computer.

Installing the printer on a wireless network (Macintosh)

Before you install the printer on a wireless network, make sure that:

- Your wireless network is set up and working properly.
- The computer you are using is connected to the same wireless network where you want to set up the printer.

Prepare to configure the printer

- 1 Locate the printer MAC address on the sheet that came with the printer. Write the last six digits of the MAC address in the space provided below:
MAC address: _____
- 2 If your printer has faxing capabilities, then connect the telephone cable.
- 3 Connect the power cable to the printer, and then to a properly grounded electrical outlet, and then turn the printer on.

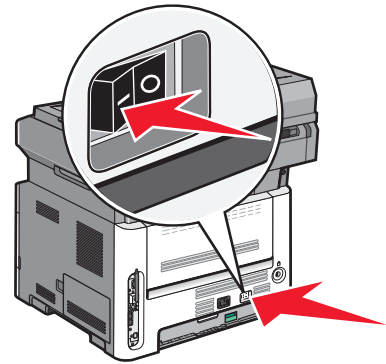
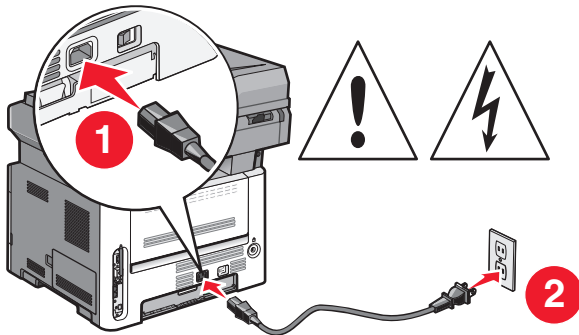

Enter the printer information

- 1 Access the AirPort options.

In Mac OS X version 10.5 or later

- a From the Apple menu, choose **System Preferences**.
- b Click **Network**.
- c Click **AirPort**.

In Mac OS X version 10.4 and earlier

- a From the Go menu, choose **Applications**.
- b Double-click **Internet Connect**.
- c From the toolbar, click **AirPort**.

- 2 From the Network pop-up menu, select **print server xxxxxx**, where the x's are the last six digits of the MAC address located on the MAC address sheet.
- 3 Open the Safari browser.
- 4 From the Bookmarks drop-down menu, select **Show**.
- 5 Under Collections, select **Bonjour** or **Rendezvous**, and then double-click the printer name.

Note: The application is referred to as *Rendezvous* in MAC OS X version 10.3, but is now called *Bonjour* by Apple Computer.

- 6 From the main page of the Embedded Web Server, navigate to the page where the wireless settings information is stored.

Configure the printer for wireless access

- 1 Type the name of your network (SSID) in the appropriate field.
- 2 Select **Infrastructure** as your Network Mode if you are using a wireless router.
- 3 Select the type of security you use to protect your wireless network.
- 4 Enter the security information necessary for the printer to join your wireless network.
- 5 Click **Submit**.
- 6 Open the AirPort application on your computer:

In Mac OS X version 10.5 or later

- a From the Apple menu, choose **System Preferences**.
- b Click **Network**.
- c Click **AirPort**.

In Mac OS X version 10.4 and earlier

- a From the Go menu, choose **Applications**.
- b Double-click **Internet Connect**.
- c From the toolbar, click **AirPort**.

- 7 From the Network pop-up menu, select your wireless network.

Configure your computer to use the printer wirelessly

To print to a network printer, each Macintosh user must install a custom *PostScript Printer Description* (PPD) file and create a printer in the Print Center or Printer Setup Utility.

- 1 Install a PPD file on the computer:
 - a Insert the *Software and Documentation* CD in the CD or DVD drive.
 - b Double-click the installer package for the printer.
 - c From the Welcome screen, click **Continue**.
 - d Click **Continue** again after viewing the Readme file.
 - e Click **Continue** after viewing the license agreement, and then click **Agree** to accept the terms of the agreement.
 - f Select a Destination, and then click **Continue**.
 - g From the Easy Install screen, click **Install**.
 - h Type the user password, and then click **OK**.
All necessary software is installed on the computer.
 - i Click **Restart** when installation is complete.
- 2 Add the printer:
 - a For IP printing:
 - In Mac OS X version 10.5 or later**
 - 1 From the Apple menu, choose **System Preferences**.
 - 2 Click **Print & Fax**.
 - 3 Click **+**.

- 4 Select the printer from the list.
- 5 Click **Add**.

In Mac OS X version 10.4 and earlier

- 1 From the Go menu, choose **Applications**.
- 2 Double-click **Utilities**.
- 3 Locate and double-click **Printer Setup Utility** or **Print Center**.
- 4 From the Printer List, choose **Add**.
- 5 Select the printer from the list.
- 6 Click **Add**.

b For AppleTalk printing:**In Mac OS X version 10.5**

- 1 From the Apple menu, choose **System Preferences**.
- 2 Click **Print & Fax**.
- 3 Click **+**.
- 4 Click **AppleTalk**.
- 5 Select the printer from the list.
- 6 Click **Add**.

In Mac OS X version 10.4

- 1 From the Go menu, choose **Applications**.
- 2 Double-click **Utilities**.
- 3 Locate and double-click **Print Center** or **Printer Setup Utility**.
- 4 From the Printer List, choose **Add**.
- 5 Choose the **Default Browser** tab.
- 6 Click **More Printers**.
- 7 From the first pop-up menu, choose **AppleTalk**.
- 8 From the second pop-up menu, choose **Local AppleTalk zone**.
- 9 Select the printer from the list.
- 10 Click **Add**.

Installing the printer on a wired network

Use the following instructions to install the printer on a wired network. These instructions apply to Ethernet and fiber optic network connections.

Before you install the printer on a wired network, make sure that:

- You have completed the initial setup of the printer.
- The printer is connected to your network with the appropriate type of cable.

For Windows users

- 1 Insert the *Software and Documentation* CD.
Wait for the Welcome screen to appear.

If the CD does not launch after a minute, then do the following:

- a Click , or click **Start** and then click **Run**.
- b In the Start Search or Run box, type **D:\setup.exe**, where **D** is the letter of your CD or DVD drive.

2 Click **Install Printer and Software**.

3 Click **Agree** to agree to the License Agreement.

4 Select **Suggested**, and then click **Next**.

Note: To configure the printer using a static IP address, using IPv6, or to configure printers using scripts, select **Custom** and follow the on-screen instructions.

5 Select **Wired Network Attach**, and then click **Next**.

6 Select the printer manufacturer from the list.

7 Select the printer model from the list, and then click **Next**.

8 Select the printer from the list of printers discovered on the network, and then click **Finish**.

Note: If your configured printer does not appear in the list of discovered printers, click **Add Port** and follow the on-screen instructions.

9 Follow the on-screen instructions to complete the installation.

For Macintosh users

1 Allow the network DHCP server to assign an IP address to the printer.

2 Print the network setup page from the printer. For information on printing a network setup page, see “Printing a network setup page” on page 24.

3 Locate the printer IP address in the TCP/IP section of the network setup page. You will need the IP address if you are configuring access for computers on a different subnet than the printer.

4 Install the drivers and add the printer.

a Install a PPD file on the computer:

1 Insert the *Software and Documentation* CD in the CD or DVD drive.

2 Double-click the installer package for the printer.

3 From the Welcome screen, click **Continue**.

4 Click **Continue** again after viewing the Readme file.

5 Click **Continue** after viewing the license agreement, and then click **Agree** to accept the terms of the agreement.

6 Select a Destination, and then click **Continue**.

7 From the Easy Install screen, click **Install**.

8 Type the user password, and then click **OK**.

All the necessary software is installed on the computer.

9 Click **Restart** when installation is complete.

b Add the printer:

- For IP printing:

In Mac OS X version 10.5 or later

- 1 From the Apple menu, choose **System Preferences**.
- 2 Click **Print & Fax**.
- 3 Click **+**.
- 4 Click **IP**.
- 5 Type in the IP address of your printer in the Address field.
- 6 Click **Add**.

In Mac OS X version 10.4 and earlier

- 1 From the Finder desktop, choose **Go > Applications**.
- 2 Double-click **Utilities**.
- 3 Double-click **Printer Setup Utility** or **Print Center**.
- 4 From the Printer List, click **Add**.
- 5 Click **IP**.
- 6 Type in the IP address of your printer in the Address field.
- 7 Click **Add**.

- For AppleTalk printing:

In Mac OS X version 10.5

- 1 From the Apple menu, choose **System Preferences**.
- 2 Click **Print & Fax**.
- 3 Click **+**.
- 4 Click **AppleTalk**.
- 5 Select the printer from the list.
- 6 Click **Add**.

In Mac OS X version 10.4 and earlier

- 1 From the Finder desktop, choose **Go > Applications**.
- 2 Double-click **Utilities**.
- 3 Double-click **Print Center** or **Printer Setup Utility**.
- 4 From the Printer List, click **Add**.
- 5 Choose the **Default Browser** tab.
- 6 Click **More Printers**.
- 7 From the first pop-up menu, choose **AppleTalk**.
- 8 From the second pop-up menu, select **Local AppleTalk zone**.
- 9 Select the printer from the list.
- 10 Click **Add**.

Note: If the printer doesn't show up in the list, you may need to add it using the IP address. Contact your system support person for assistance.

Minimizing your printer's environmental impact

Lexmark is committed to environmental sustainability and is continually improving its printers to reduce their impact on the environment. We design with the environment in mind, engineer our packaging to reduce materials, and provide collection and recycling programs. For more information, see:

- The Notices chapter
- The Environmental Sustainability section of the Lexmark Web site at www.lexmark.com/environment
- The Lexmark recycling program at www.lexmark.com/recycling

By selecting certain printer settings or tasks, you may be able to reduce your printer's impact even further. This chapter outlines the settings and tasks that may yield a greater environmental benefit.

Saving paper and toner

Studies show that as much as 80% of the carbon footprint of a printer is related to paper usage. You can significantly reduce your carbon footprint by using recycled paper and the following printing suggestions, such as printing on both sides of the paper and printing multiple pages on one side of a single sheet of paper.

For information on how you can quickly save paper and energy using one printer setting, see "Using Eco-Mode".

Using recycled paper

As an environmentally conscious company, Lexmark supports the use of recycled office paper produced specifically for use in laser printers. For more information on recycled papers that work well with your printer, see "Using recycled paper and other office papers" on page 55.

Conserving supplies

There are a number of ways to reduce the amount of paper you use when printing, copying, or receiving faxes. You can:

Use both sides of the paper

You can control whether print appears on one or two sides of the paper for an incoming fax, a printed document, or a copy. For more information, see:

- "Printing on both sides of the paper (duplexing)" on page 61
- "Copying on both sides of the paper (duplexing)" on page 71
- "Printing incoming faxes on both sides of the paper (duplexing)" on page 98

Place multiple pages on one sheet of paper

You can print up to 16 consecutive pages of a multiple-page document onto one side of a single sheet of paper from the Print dialog.

To copy two or four consecutive pages of a multiple-page document onto one side of a single sheet of paper, see "Copying multiple pages onto a single sheet" on page 74.

Choose scanning

You can avoid making a paper output of a document or photograph by scanning it to save to a computer program, application, or flash drive. For more information, see:

- “Scanning to a computer” on page 103
- “Scanning to a flash drive” on page 104

Check your first draft for accuracy

Before printing or making multiple copies of a document:

- Use the Lexmark preview feature, which you can select from the Print dialog, the Lexmark Toolbar, or the printer display, to see what the document will look like before you print it.
- Print one copy of the document to check its content and format for accuracy.

Avoid paper jams

Carefully select and load paper to avoid paper jams. For more information, see “Avoiding jams” on page 40.

Saving energy

You may be able to further reduce energy by adjusting Power Saver.



Using Eco-Mode



Use Eco-Mode to quickly select one or more ways to reduce your printer's environmental impact.

Note: See the table for the multiple settings that change when you select an Eco-Mode setting.









Choose	To
Energy	Reduce energy use, especially when the printer is idle. <ul style="list-style-type: none"> • Printer engine motors do not start until a job is ready to print. You may notice a short delay before the first page is printed. • The printer enters Power Saver mode after one minute of inactivity. • When the printer enters Power Saver mode, the printer control panel display and option lights are turned off. • The scanner lamps are activated only when a scan job is started.
Paper	<ul style="list-style-type: none"> • Print appears on both sides of a print, copy, or received fax. • Fax transmission log features are turned off.
Energy/Paper	Use all the settings associated with Energy mode and Paper mode.
Off	Use factory default settings. This setting supports the performance specifications for your printer.

To select an Eco-Mode setting:

- 1 From the printer control panel, press .
- 2 Press the arrow buttons until **Settings** appears, and then press .
- 3 Press the arrow buttons until **General Settings** appears, and then press .

- 4 Press the arrow buttons until **Eco-Mode** appears, and then press .
- 5 Select the setting you want, and then press .
Submitting changes appears.

Adjusting Power Saver using the printer control panel

- 1 Make sure the printer is on and **Ready** appears.
- 2 From the printer control panel, press .
- 3 Press the arrow buttons until **Settings** appears, and then press .
- 4 Press the arrow buttons until **General Settings** appears, and then press .
- 5 Press the arrow buttons until **Timeout** appears, and then press .
- 6 Press the arrow buttons until **Power Saver** appears, and then press .
- 7 Press the arrow buttons to enter the number of minutes for the printer to wait before entering the Power Saver mode. Available settings range from 1–240 minutes.
- 8 Press .
- Submitting changes** appears.
- 9 Press , and then press  until **Ready** appears.

Adjusting Power Saver using the Embedded Web Server

Available settings range from 1-240 minutes. The factory default setting is 30 minutes.

To increase or decrease the number of minutes before the printer enters Power Saver mode:

- 1 Type the printer IP address into the address field of your Web browser.
Note: If you do not know the IP address of the printer, then print a network setup page and locate the IP address in the TCP/IP section.
- 2 Click **Settings**, and then click **General Settings**.
- 3 Click **Timeouts**.
- 4 In the Power Saver box, increase or decrease the number of minutes you want the printer to wait before it enters Power Saver mode.
- 5 Click **Submit**.

Recycling

Lexmark provides collection programs and environmentally progressive approaches to recycling. For more information, see:

- The Notices chapter
- The Environmental Sustainability section of the Lexmark Web site at www.lexmark.com/environment
- The Lexmark recycling program at www.lexmark.com/recycling

Recycling Lexmark products

To return Lexmark products to Lexmark for recycling:

- 1 Visit our Web site at www.lexmark.com/recycle.
- 2 Find the product type you want to recycle, and then select your country from the list.
- 3 Follow the instructions on the computer screen.

Recycling Lexmark packaging

Lexmark continually strives to minimize packaging. Less packaging helps to ensure that Lexmark printers are transported in the most efficient and environmentally sensitive manner and that there is less packaging to dispose of. These efficiencies result in fewer greenhouse emissions, energy savings, and natural resource savings.

Lexmark cartons are 100% recyclable where corrugated recycling facilities exist. Facilities may not exist in your area.

Expanded polystyrene (EPS) foam used in Lexmark packaging is recyclable where foam recycling facilities exist. Facilities may not exist in your area. For information on EPS foam recycling locations:

- 1 Visit EPS Recycling International's Web site at www.epsrecycling.org/pages/intcon.html.
- 2 Select your country or region from the list, and then click the links or use the contact information provided.

When you return a cartridge to Lexmark, you can reuse the box that the cartridge came in. Lexmark will recycle the box.

Returning Lexmark cartridges for reuse or recycling

The Lexmark Cartridge Collection Program diverts millions of Lexmark cartridges from landfills annually by making it both easy and free for Lexmark customers to return used cartridges to Lexmark for reuse or recycling. One hundred percent of the empty cartridges returned to Lexmark are either reused or demanufactured for recycling. Boxes used to return the cartridges are also recycled.

To return Lexmark cartridges for reuse or recycling, follow the instructions that came with your printer or cartridge and use the pre-paid shipping label. You can also:

- 1 Visit our Web site at www.lexmark.com/recycle.
- 2 From the Toner Cartridges section, select your country from the list.
- 3 Follow the instructions on the computer screen.





Reducing printer noise

Use Quiet Mode to reduce the printer noise.

Note: See the table for the multiple settings that change when you select a Quiet Mode setting.

Choose	To
On	Reduce printer noise. <ul style="list-style-type: none">• You may notice a reduction in processing speed.• Printer engine motors do not start until a job is ready to print. You may notice a short delay before the first page is printed.• Fans run at a reduced speed or are turned off.• If your printer has faxing capability, fax sounds are reduced or disabled, including the fax speaker and ringer.
Off	Use factory default settings. This setting supports the performance specifications for your printer.

To select a Quiet Mode setting:

- 1 From the printer control panel, press .
 - 2 Press the arrow buttons until **Settings** appears, and then press .
 - 3 Press the arrow buttons until **General Settings** appears, and then press .
 - 4 Press the arrow buttons until **Quiet Mode** appears, and then press .
 - 5 Select the setting you prefer between **Yes** and **No**, and then press .
- Submitting changes** appears.









Loading paper and specialty media

This section explains how to load the trays and feeders. It also includes information about paper orientation, setting the Paper Size and Paper Type, and linking and unlinking trays.

Setting the Paper Size and Paper Type

After you set the Paper Size and Paper Type to the correct settings for the size and type used in the trays, then any trays containing the same size and type are automatically linked by the printer.

Note: If the size of the paper being loaded now is the same size as the previously loaded paper, do not change the Paper Size setting.

- 1 Make sure the printer is on and **Ready** appears.
- 2 From the printer control panel, press .
Paper Menu appears.
- 3 Press .
- 4 Press the arrow buttons until **Size/Type** appears, and then press .
- Select Source** appears.
- 5 Press the arrow buttons until the correct source appears, and then press .
- Size** appears under the source name.
- 6 Press .
- 7 Press the arrow buttons until the correct size appears, and then press .
- Submitting Changes** appears, followed by **Size**.
- 8 Press the arrow buttons until **Type** appears, and then press .
- 9 Press the arrow buttons until the correct type appears, and then press .
- Submitting Changes** appears, followed by **Type**.





Configuring Universal paper settings

The Universal Paper Size is a user-defined setting that lets you print on paper sizes that are not preset in the printer menus. Set the Paper Size for the Manual Feeder to Universal when the size you want is not available from the Paper Size menu. Then, specify all of the following Universal size settings for your paper:

- Units of measure (inches or millimeters)
- Portrait Height and Portrait Width
- Feed Direction

Note: The smallest supported Universal size is 76 x 127 mm (3 x 5 in.); the largest is 216 x 356 mm (8.5 x 14 in.). Paper that weighs at least 75 g/m² (20 lb) is recommended for sizes less than or equal to 182 mm (7.17 in.) wide.





Specify a unit of measurement

- 1 Make sure the printer is on and **Ready** appears.
 - 2 From the printer control panel, press .
Paper Menu appears.
 - 3 Press .
 - 4 Press the arrow buttons until **Universal Setup** appears, and then press .
 - 5 Press the arrow buttons until **Units of Measure** appears, and then press .
 - 6 Press the arrow buttons until the correct unit of measure appears, and then press .
- Submitting Changes** appears, followed by the **Universal Setup** menu.

Specify the paper height and width

Defining a specific height and width measurement for the Universal paper size (in the portrait orientation) allows the printer to support the size, including support for standard features such as duplex printing and printing multiple pages on one sheet.

Note: Select **Portrait Height** to adjust the paper height setting or **Paper Width** to adjust the paper width setting, or adjust both. Instructions to adjust both follow.

- 1 From the Universal Setup menu, press the arrow buttons until **Portrait Width** appears, and then press .
 - 2 Press the left arrow button to decrease the setting or the right arrow button to increase the setting, and then press .
- Submitting Changes** appears, followed by the **Universal Setup** menu.
- 3 From the Universal Setup menu, press the arrow buttons until **Portrait Height** appears, and then press .
 - 4 Press the left arrow button to decrease the setting or the right arrow button to increase the setting, and then press .
- Submitting Changes** appears, followed by the **Universal Setup** menu.

Avoiding jams

The following hints can help you avoid jams:

Paper tray recommendations

- Make sure the paper lies flat in the paper tray.
- Do not remove the paper tray while the printer is printing.
- Do not load the paper tray while the printer is printing. Load it prior to printing, or wait for a prompt to load it.
- Do not load too much paper. Make sure the stack height does not exceed the indicated maximum height.
- Make sure the guides in the paper tray or the manual feeder are properly positioned and are not pressing too tightly against the paper or envelopes.
- Push the paper tray in firmly after loading paper.

Paper recommendations

- Use only recommended paper or specialty media.
- Do not load wrinkled, creased, damp, bent, or curled paper.
- Flex, fan, and straighten paper before loading it.

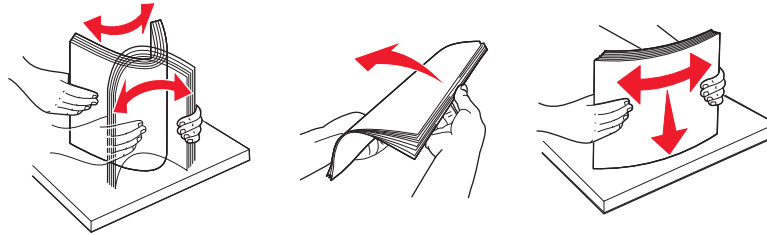

- Do not use paper that has been cut or trimmed by hand.
- Do not mix paper sizes, weights, or types in the same stack.
- Make sure all sizes and types are set correctly in the printer control panel menus.
- Store paper per the manufacturer's recommendations.

Loading trays

- 1 Pull the tray completely out.

Note: Do not remove trays while a job prints or while **Busy** appears on the display. Doing so may cause a jam.

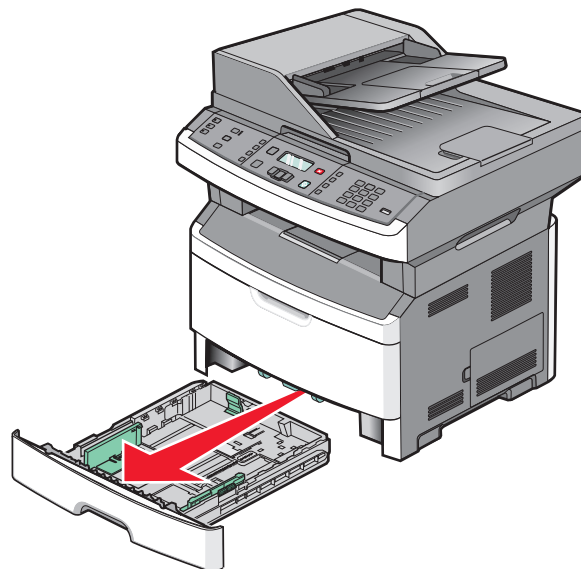

2 Squeeze and slide the guides to the correct position for the paper size you are loading.

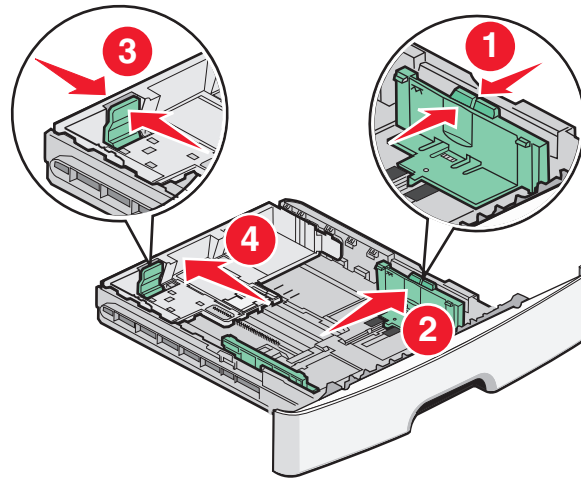

For long paper like A4 or legal, squeeze and slide the length guide backwards to accommodate the length of paper you are loading.

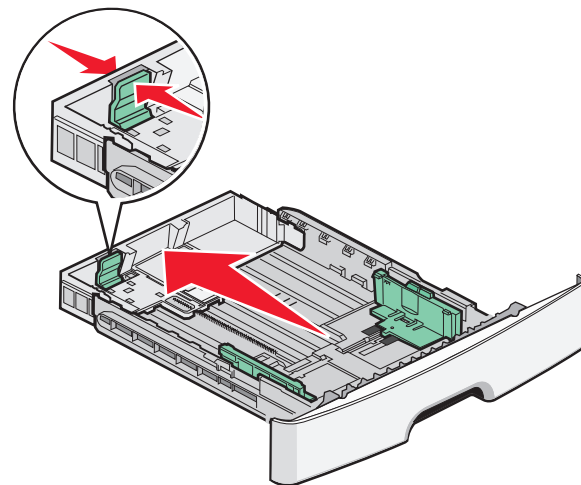

If you are loading A6-size paper:

- a Squeeze and slide the length guide toward the center of the tray to the A5 size position.
- b Raise the A6 backstop.

Notes:

- The standard tray accommodates only 150 sheets of A6-size paper. Notice the maximum fill line on the A6 backstop which indicates the maximum height for loading A6-size paper. Do not try to overload the tray.
- A6-size paper cannot be loaded in the optional tray.

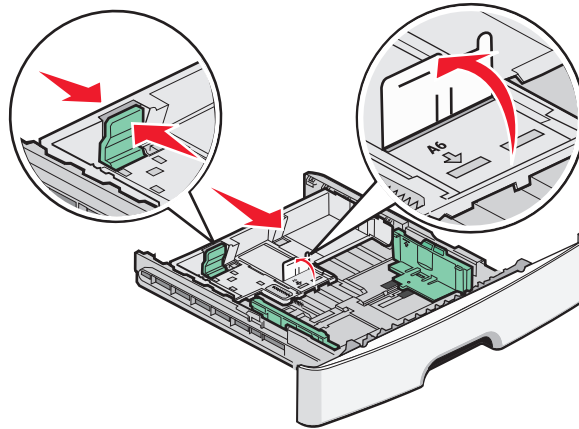
**Notes:**

- Use the size indicators on the bottom of the tray to help position the guide.
- For setup, load letter- or A4-size paper based on the standard size for your country or region.

- 3** Flex a stack of paper back and forth to loosen the sheets, and then fan them. Do not fold or crease the paper. Straighten the edges on a level surface.

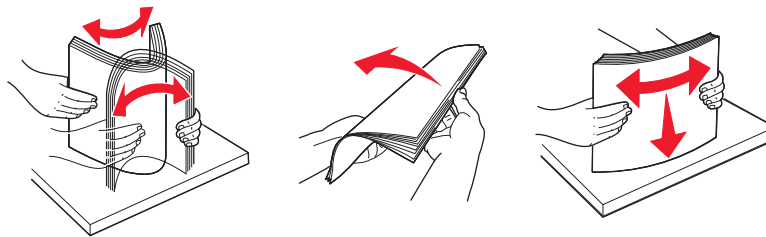

- 4** Load the paper stack toward the back of the tray as shown with the recommended print side facedown.

Note: The maximum fill line on the width guide indicates the maximum height for loading paper. Do not load A6-size paper to the maximum fill line; the tray holds only 150 sheets of A6-size paper.

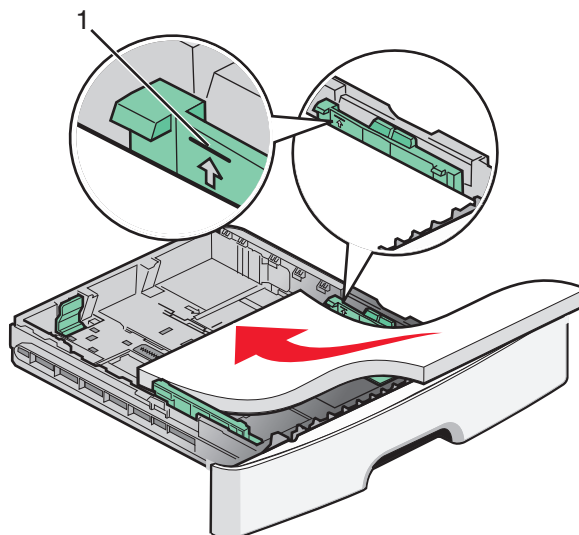

1 Maximum fill line

Load letterhead with the top edge of the sheet toward the front of the tray and the design facedown.

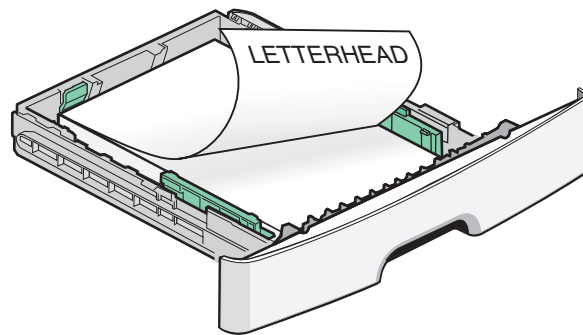

5 Squeeze and slide the guides to lightly touch the side of the stack.

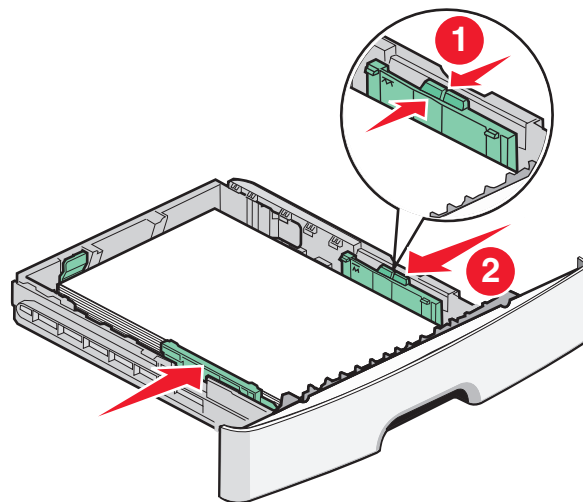

6 Insert the tray.

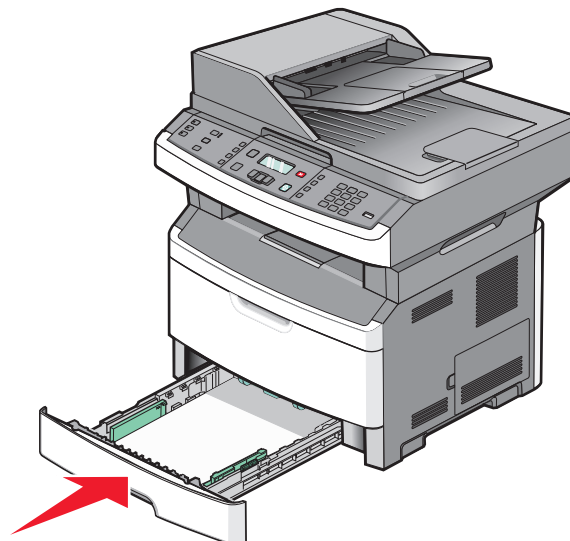

7 If the paper type you loaded differs from the type that was previously loaded in the tray, then change the Paper Type setting for the tray.

Using a multipurpose or manual feeder

Some models of the printer have a multipurpose feeder, whereas other models have a manual feeder. The multipurpose feeder can be loaded like a tray with up to 50 sheets of paper. The manual feeder can be loaded with one sheet of paper at a time.

Using the multipurpose feeder

You may want to use the multipurpose feeder when you print on different sizes and types of papers or specialty media, such as card stock, transparencies, paper labels, and envelopes. You may also want to use the multipurpose feeder for single-page print jobs on letterhead or on other specialty media you do not keep in a tray.

Opening the multipurpose feeder

- 1 Pull the multipurpose feeder door down.

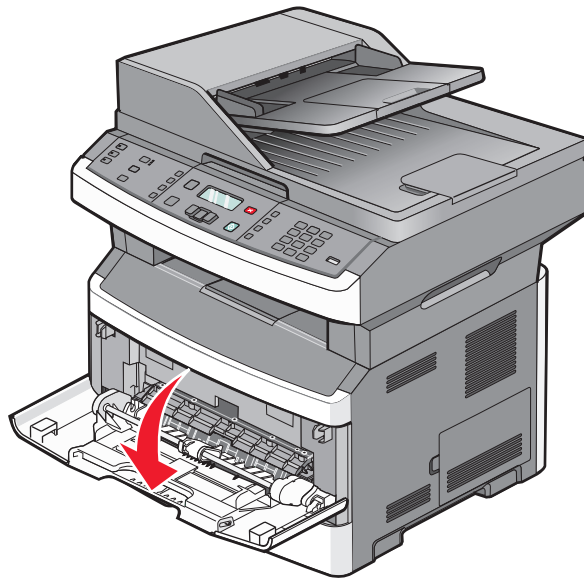

- 2 Pull the extension forward.

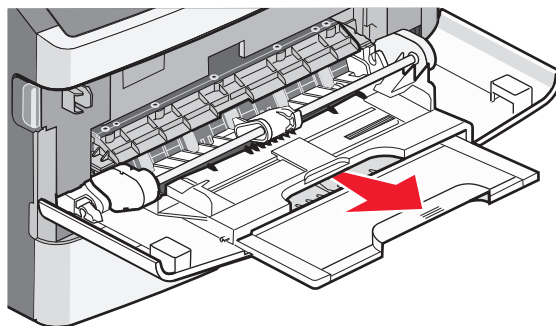

- 3 Pull the extension so it flips forward and down.

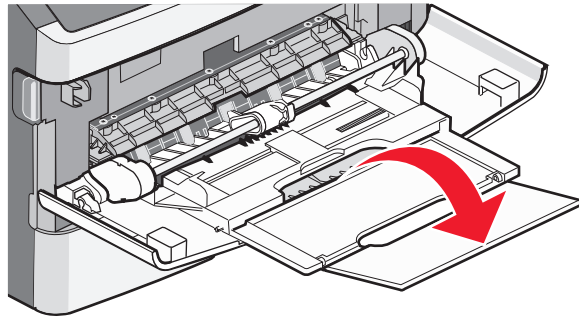

Loading the multipurpose feeder

- 1 Squeeze and slide the guides out fully.

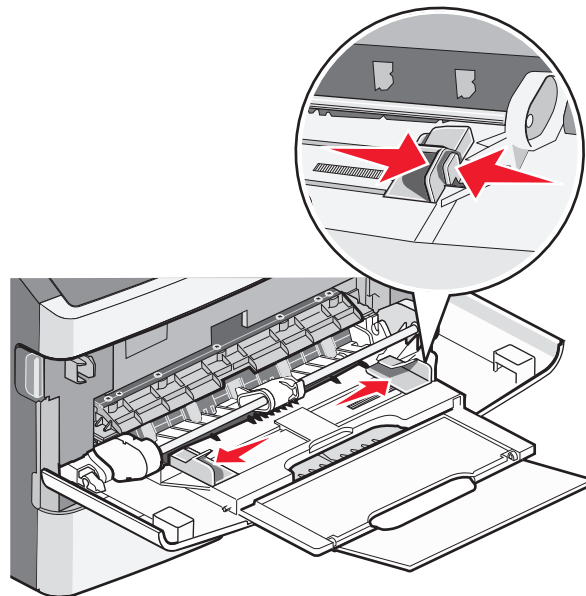

- 2 Flex sheets of paper or paper labels back and forth to loosen them, and then fan them. Do not fold or crease the paper or labels. Straighten the edges on a level surface.

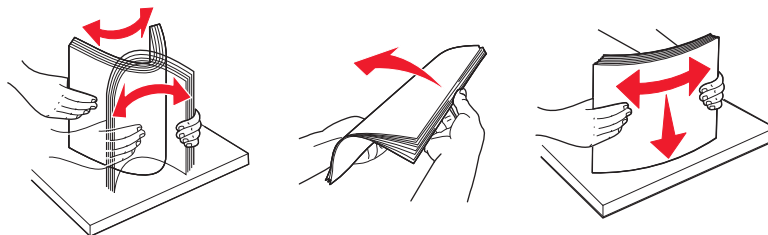

- 3 Load the paper or specialty media.

Notes:

- Do not force paper into the multipurpose feeder.
- Do not exceed the maximum stack height. Overfilling may cause jams.

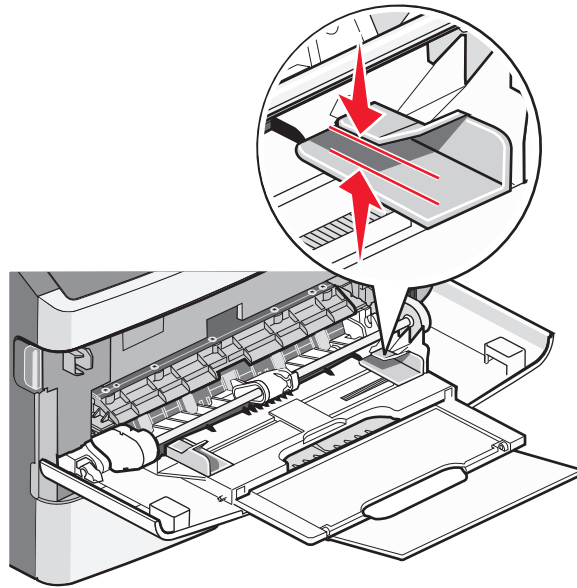

- Load paper, transparencies, and card stock with the recommended print side faceup and the top edge entering the printer first. For more information on loading transparencies, see the packaging the transparencies came in.

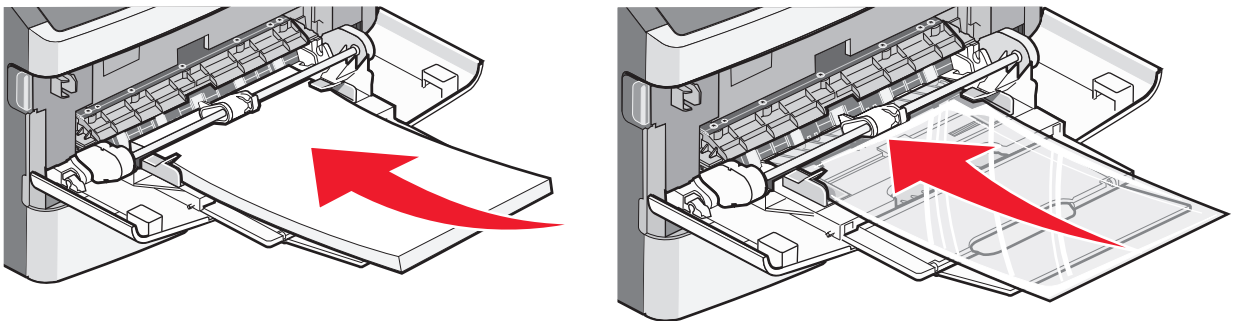

- Load letterhead with the logo faceup and the top edge entering the printer first.

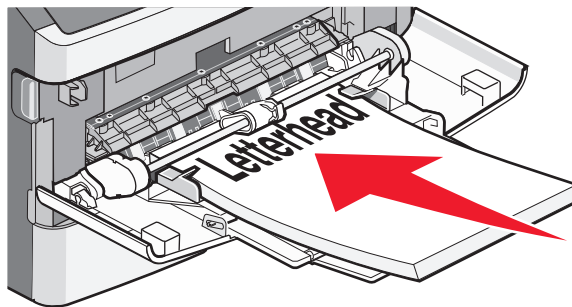

- Load envelopes with the flap side down and the stamp location in the position shown.

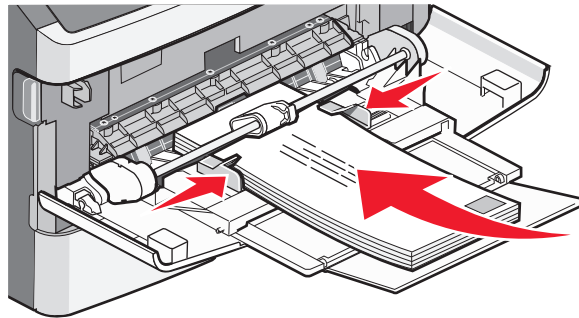

Warning—Potential Damage: Never use envelopes with stamps, clasps, snaps, windows, coated linings, or self-stick adhesives. These envelopes may severely damage the printer.

- 4 Squeeze and slide the guides to support the paper.

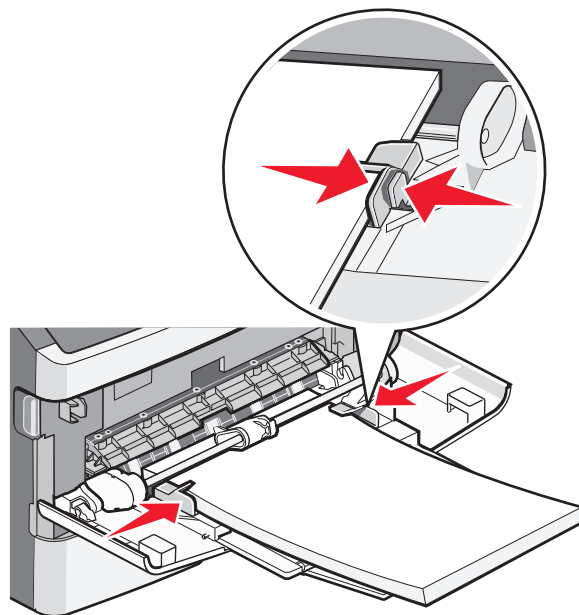

- 5 Slide the paper gently into the multipurpose feeder until it comes to a stop. Make sure the paper fits loosely and is not bent or wrinkled.

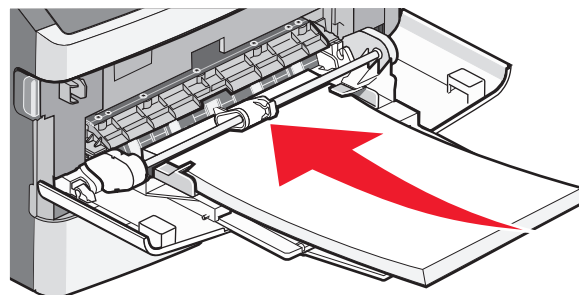

- 6 From the printer control panel, set the Paper Size and Paper Type.

Using the manual feeder

The manual feeder can feed only one sheet of paper at a time. You can use the manual feeder to print on paper types or sizes that are not currently loaded in a tray.

- 1 Open the manual feeder door.

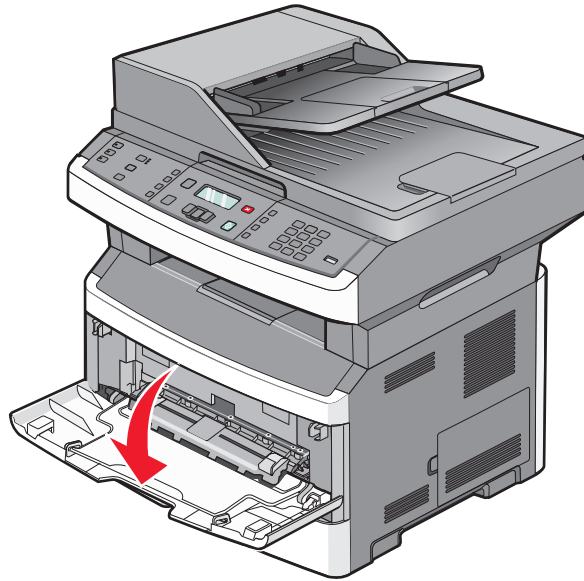

- 2 Load one sheet of paper faceup into the center of the manual feeder.

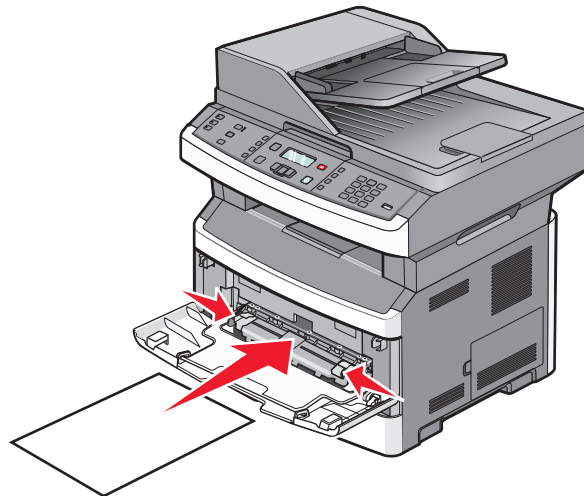

Notes:

- Load letterhead faceup, with the top of the sheet entering first.
- Load envelopes with the flap side down and with the stamp area as shown.

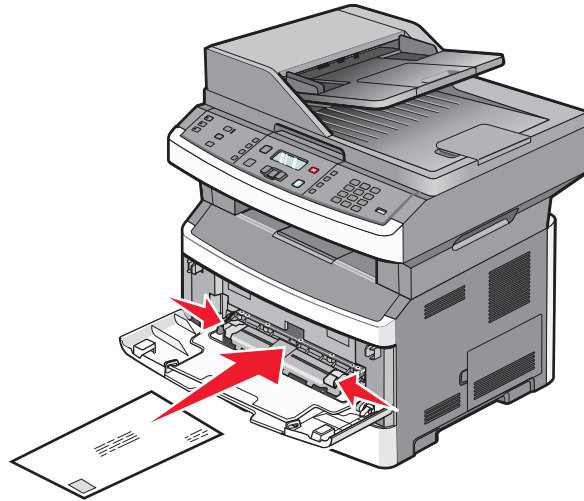

3 Feed paper into the manual feeder only to the point where its leading edge can contact the paper guides.

4 Adjust the paper guides to the paper width.

Warning—Potential Damage: Do not force the paper into the feeder. Forcing the paper causes jams.

Paper capacities

The capacities of the trays and feeders are based on 75 g/m² (20 lb) paper.

Load up to	Notes
Tray 1 250 sheets of paper 150 sheets of A6-size paper 50 paper labels 50 transparencies	Vinyl, pharmacy, or dual-sided labels are not supported. Use paper labels only. Single-sided paper labels designed for laser printers are supported for occasional use. It is recommended to print no more than 20 pages of paper labels per month.
Tray 2 250 or 550 sheets of paper 50 paper labels	Only one optional drawer may be installed on the printer at a time. The maximum amount of paper that can be loaded depends on whether you have an optional 250- or 550-sheet tray.
Multipurpose feeder 50 sheets of paper 15 paper labels 10 transparencies 10 sheets of card stock 7 envelopes	Feed paper into the multipurpose feeder only to the point where its leading edge can contact the paper guides. Do not force the paper into the feeder.
Manual feeder 1 sheet of paper 1 sheet of paper labels 1 transparency 1 sheet of card stock 1 envelope	Depending on your printer model, you have either a multipurpose feeder or a manual feeder.

Linking and unlinking trays

Linking trays

Tray linking is useful for large print jobs or multiple copies. When one linked tray is empty, paper feeds from the next linked tray. When the Size and Type settings are the same for any trays, the trays are automatically linked. The Size and Type settings for all trays must be set from the Paper menu.

Unlinking trays

Unlinked trays have settings that are *not* the same as the settings of any other tray. To unlink a tray using the Paper menu, change the Paper Type and Paper Size settings so that they do not match the settings of any other tray.

- 1 From the Paper menu, make sure the Type setting (for example, Plain Paper, letterhead, Custom Type <x>) for the tray you want to unlink does not match the Type setting of any other tray.

If the name that best describes your paper is used by linked trays, assign a different Paper Type name to the tray, such as Custom Type <x>, or assign your own custom name.







- 2 Make sure the Size setting (for example, letter, A4, statement) for the tray you want to unlink does not match the Size setting of any other tray.

Note: Paper Size settings are not automatic; they must be set manually from the Paper menu.

Warning—Potential Damage: Do not assign a Paper Type name that does not accurately describe the type of paper loaded in the tray. The temperature of the fuser varies according to the specified Paper Type. Paper may not be properly processed if an inaccurate Paper Type is selected.

Assigning a Custom Type <x> name

Assign a Custom Type <x> name to a tray to link or unlink it. Associate the same Custom Type <x> name to each tray that you want to link.

- 1 Make sure the printer is on and **Ready** appears.
- 2 From the printer control panel, press .
- 3 Press the arrow buttons until **Paper Menu** appears, and then press .
- 4 Press the arrow buttons until **Size/Type** appears, and then press 
Select Source appears.
- 5 Press the arrow buttons until the name of the tray you want appears, and then press 
The **Size** menu item appears.
- 6 Press the arrow buttons until the size you want appears, and then press 
Submitting changes appears.
- 7 Press the arrow buttons until **Custom Type <x>** or another custom name appears, and then press 
Submitting Changes appears.
- 8 Press and release  until **Ready** appears.

Changing a Custom Type <x> name

You can use the Embedded Web Server or MarkVision Professional™ to define a name other than Custom Type <x> for each of the custom paper types that are loaded. When a Custom Type <x> name is changed, the menus display the new name instead of Custom Type <x>.

To change a Custom Type <x> name from the Embedded Web Server:

- 1 Type the printer IP address into the address field of your Web browser.

Note: If you do not know the IP address of the printer, then print a network setup page and locate the IP address in the TCP/IP section.

- 2 Click **Settings**.

- 3 Under Default Settings, click **Paper Menu**.

- 4 Click **Custom Names**.

- 5 Type a name for the paper type in a Custom Name <x> box.

Note: This custom name will replace a custom type <x> name under the Custom Types and Paper Size/Type menus.

- 6 Click **Submit**.

- 7 Click **Custom Types**.

Custom Types appears, followed by your custom name.

- 8 Select a Paper Type setting from the list next to your custom name.

- 9 Click **Submit**.

Paper and specialty media guidelines

Paper guidelines

Selecting the correct paper or specialty media reduces printing problems. For the best print quality, try a sample of the paper or specialty media before buying large quantities.

Paper characteristics

The following paper characteristics affect print quality and reliability. Consider these characteristics when evaluating new paper stock.

Weight

The printer trays can automatically feed paper weights up to 90 g/m² (24 lb bond) grain long paper. The multipurpose feeder can automatically feed paper weights up to 163 g/m² (43 lb bond) grain long. Paper lighter than 60 g/m² (16 lb) might not be stiff enough to feed properly, causing jams. For best performance, use 75 g/m² (20 lb bond) grain long paper. For paper smaller than 182 x 257 mm (7.2 x 10.1 in.), we recommend 90 g/m² (24 lb) or heavier paper.

Note: Duplex printing is supported only for 60–90 g/m² (16–24 lb bond) paper.

Curl

Curl is the tendency for paper to curl at its edges. Excessive curl can cause paper feeding problems. Curl can occur after the paper passes through the printer, where it is exposed to high temperatures. Storing paper unwrapped in hot, humid, cold, or dry conditions, even in the trays, can contribute to paper curling prior to printing and can cause feeding problems.

Smoothness

Paper smoothness directly affects print quality. If paper is too rough, toner cannot fuse to it properly. If paper is too smooth, it can cause paper feeding or print quality issues. Always use paper between 100–300 Sheffield points; smoothness between 150–250 Sheffield points produces the best print quality.

Moisture content

The amount of moisture in paper affects both print quality and the ability of the printer to feed the paper correctly. Leave paper in its original wrapper until it is time to use it. This limits the exposure of paper to moisture changes that can degrade its performance.

Condition paper before printing by storing it in its original wrapper in the same environment as the printer for 24 to 48 hours before printing. Extend the time several days if the storage or transportation environment is very different from the printer environment. Thick paper may also require a longer conditioning period.

Grain direction

Grain refers to the alignment of the paper fibers in a sheet of paper. Grain is either *grain long*, running the length of the paper, or *grain short*, running the width of the paper.

For 60–90 g/m² (16–24 lb bond) paper, grain long paper is recommended.

Fiber content

Most high-quality xerographic paper is made from 100% chemically treated pulped wood. This content provides the paper with a high degree of stability resulting in fewer paper feeding problems and better print quality. Paper containing fibers such as cotton can negatively affect paper handling.

Unacceptable paper

The following paper types are not recommended for use with the printer:

- Chemically treated papers used to make copies without carbon paper, also known as carbonless papers, carbonless copy paper (CCP), or no carbon required (NCR) paper
- Preprinted papers with chemicals that may contaminate the printer
- Preprinted papers that can be affected by the temperature in the printer fuser
- Preprinted papers that require a registration (the precise print location on the page) greater than ± 2.3 mm (± 0.9 in.), such as optical character recognition (OCR) forms

In some cases, registration can be adjusted with a software application to successfully print on these forms.

- Coated papers (erasable bond), synthetic papers, thermal papers
- Rough-edged, rough or heavily textured surface papers, or curled papers
- Recycled papers that fail EN12281:2002 (European)
- Paper weighing less than 60 g/m² (16 lb)
- Multiple-part forms or documents

Selecting paper

Using appropriate paper prevents jams and helps ensure trouble-free printing.

To help avoid jams and poor print quality:

- *Always* use new, undamaged paper.
- Before loading paper, know the recommended print side. This information is usually indicated on the package.
- *Do not* use paper, paper labels, or card stock that has been cut or trimmed by hand.
- *Do not* mix sizes, types, or weights in the same source; mixing results in jams.
- *Do not* use coated papers unless they are specifically designed for electrophotographic printing.

Selecting preprinted forms and letterhead

Use these guidelines when selecting preprinted forms and letterhead:

- Use grain long for 60 to 90 g/m² weight paper.
- Use only forms and letterhead printed using an offset lithographic or engraved printing process.
- Avoid papers with rough or heavily textured surfaces.

Use papers printed with heat-resistant inks designed for use in xerographic copiers. The ink must be able to withstand temperatures up to 230°C (446°F) without melting or releasing hazardous emissions. Use inks that are not affected by the resin in toner. Inks that are oxidation-set or oil-based generally meet these requirements; latex inks might not.

When in doubt, contact the paper supplier.

Preprinted papers such as letterhead must be able to withstand temperatures up to 230°C (446°F) without melting or releasing hazardous emissions.

Using recycled paper and other office papers

As an environmentally conscious company, Lexmark supports the use of recycled office paper produced specifically for use in laser (electrophotographic) printers. In 1998, Lexmark presented to the US government a study demonstrating that recycled paper produced by major mills in the US fed as well as non-recycled paper. However, no blanket statement can be made that *all* recycled paper will feed well.

Lexmark consistently tests its printers with recycled paper (20–100% post-consumer waste) and a variety of test paper from around the world, using chamber tests for different temperature and humidity conditions. Lexmark has found no reason to discourage the use of today's recycled office papers, but generally the following property guidelines apply to recycled paper.

- Low moisture content (4–5%)
- Suitable smoothness (100–200 Sheffield units, or 140–350 Bendtsen units, European)

Note: Some much smoother papers (such as premium 24 lb laser papers, 50–90 Sheffield units) and much rougher papers (such as premium cotton papers, 200–300 Sheffield units) have been engineered to work very well in laser printers, despite surface texture. Before using these types of paper, consult your paper supplier.

- Suitable sheet-to-sheet coefficient of friction (0.4–0.6)
- Sufficient bending resistance in the direction of feed

Recycled paper, paper of lower weight (<60 g/m² [16 lb bond]) and/or lower caliper (<3.8 mils [0.1 mm]), and paper that is cut grain-short for portrait (or short-edge) fed printers may have lower bending resistance than is required for reliable paper feeding. Before using these types of paper for laser (electrophotographic) printing, consult your paper supplier. Remember that these are general guidelines only and that paper meeting these guidelines may still cause paper feeding problems in any laser printer (for example, if the paper curls excessively under normal printing conditions).

Storing paper

Use these paper storage guidelines to help avoid jams and uneven print quality:

- For best results, store paper where the temperature is 21°C (70°F) and the relative humidity is 40%. Most label manufacturers recommend printing in a temperature range of 18 to 24°C (65 to 75°F) with relative humidity between 40 and 60%.
- Store paper in cartons when possible, on a pallet or shelf, rather than on the floor.
- Store individual packages on a flat surface.
- Do not store anything on top of individual paper packages.

Supported paper sizes, types, and weights

The following tables provide information on standard and optional paper sources and the types of paper they support.

Note: For an unlisted paper size, select the closest *larger* listed size.

For information on card stock and labels, see the *Card Stock & Label Guide*.

Paper types and weights supported by the printer

The printer engine and the duplex path support 60–90 g/m² (16–24 lb) paper weights. The multipurpose and manual feeders support 60–163 g/m² (16–43 lb) paper weights.

Paper type	Standard 250-sheet tray	Optional 250- or 550-sheet tray	Multipurpose feeder	Manual feeder	Duplex path
Paper	✓	✓	✓	✓	✓
<ul style="list-style-type: none"> • Plain • Light • Heavy • Recycled • Custom 					
Rough/Cotton	✓	✓	✓	✓	X
Bond	✓	✓	✓	✓	✓
Letterhead	✓	✓	✓	✓	✓
Preprinted	✓	✓	✓	✓	✓
Colored Paper	✓	✓	✓	✓	✓
Card stock	X	X	✓	✓	X
Glossy paper	X	X	X	X	X
Paper labels¹	✓	✓	✓	✓	X
Transparencies	✓	✓	✓	✓	X
Envelopes (smooth)²	X	X	✓	✓	X

¹ Single-sided paper labels designed for laser printers are supported for occasional use. It is recommended to print no more than 20 pages of paper labels a month. Vinyl, pharmacy, and dual-sided labels are not supported.

² Use envelopes that lie flat when individually placed on a table facedown.

Paper sizes supported by the printer

Paper size	Dimensions	Standard 250-sheet tray	Optional 250- or 550-sheet tray	Multipurpose feeder or Manual feeder	Duplex path
A4	210 x 297 mm (8.3 x 11.7 in.)	✓	✓	✓	✓
A5	148 x 210 mm (5.8 x 8.3 in.)	✓	✓	✓	X
A6¹	105 x 148 mm (4.1 x 5.8 in.)	✓	X	✓	X
Executive	184 x 267 mm (7.3 x 10.5 in.)	✓	✓	✓	X
Folio	216 x 330 mm (8.5 x 13 in.)	✓	✓	✓	✓
JIS B5	182 x 257 mm (7.2 x 10.1 in.)	✓	✓	✓	X
Legal	216 x 356 mm (8.5 x 14 in.)	✓	✓	✓	✓
Letter	216 x 279 mm (8.5 x 11 in.)	✓	✓	✓	✓
Oficio (Mexico)	216 x 340 mm (8.5 x 13.4 in.)	✓	✓	✓	✓
Statement	140 x 216 mm (5.5 x 8.5 in.)	✓	✓	✓	X
Universal²	76.2 x 127 mm (3 x 5 in.) up to 216 x 356 mm (8.5 x 14 in.)	X ³	X ³	✓	X ³
B5 Envelope	176 x 250 mm (6.9 x 9.8 in.)	X	X	✓	X
C5 Envelope	162 x 229 mm (6.4 x 9 in.)	X	X	✓	X
DL Envelope	110 x 220 mm (4.3 x 8.7 in.)	X	X	✓	X
7 3/4 Envelope (Monarch)	98 x 191 mm (3.9 x 7.5 in.)	X	X	✓	X
9 Envelope	98 x 225 mm (3.9 x 8.9 in.)	X	X	✓	X

¹ A6 is supported only for grain long papers.

² If a paper size you want to use is not listed, configure a Universal paper size. For more information, see “Configuring Universal paper settings” on page 39.

³ Universal paper size has limited support in the trays for paper sizes 140 mm x 210 mm (5.5 x 8.3 in.) or larger and in the duplex path for paper sizes 210 x 279 mm (8.3 x 11 in.) or larger.

Paper size	Dimensions	Standard 250-sheet tray	Optional 250- or 550-sheet tray	Multipurpose feeder or Manual feeder	Duplex path
10 Envelope	105 x 241 mm (4.1 x 9.5 in.)	X	X	✓	X
Other Envelope	229 x 356 mm (9 x 14 in.)	X	X	✓	X

¹ A6 is supported only for grain long papers.

² If a paper size you want to use is not listed, configure a Universal paper size. For more information, see “Configuring Universal paper settings” on page 39.

³ Universal paper size has limited support in the trays for paper sizes 140 mm x 210 mm (5.5 x 8.3 in.) or larger and in the duplex path for paper sizes 210 x 279 mm (8.3 x 11 in.) or larger.

Printing

This chapter covers printing, printer reports, and job cancelation. Selection and handling of paper and specialty media can affect how reliably documents print. For more information, see “Avoiding jams” on page 40 and “Storing paper” on page 55.

Printing a document

- 1 Load paper into a tray or feeder.
- 2 From the printer control panel Paper menu, set the Paper Type and Paper Size to match the loaded paper.
- 3 Do one of the following:

For Windows users

- a With a document open, click **File > Print**.
- b Click **Properties, Preferences, Options, or Setup**, and then adjust the settings as needed.
Note: To print on a specific size or type of paper, adjust the paper size or type settings to match the loaded paper, or select the appropriate tray or feeder.
- c Click **OK**, and then click **Print**.

For Macintosh users

- a Customize the settings as needed in the Page Setup dialog:
 - 1 With a document open, choose **File > Page Setup**.
 - 2 Choose a paper size or create a custom size to match the loaded paper.
 - 3 Click **OK**.
- b Customize the settings as needed in the Print dialog:
 - 1 With a document open, choose **File > Print**.
If necessary, click the disclosure triangle to see more options.
 - 2 From the Print dialog and pop-up menus, adjust the settings as needed.
Note: To print on a specific paper type, adjust the paper type setting to match the loaded paper, or select the appropriate tray or feeder.
 - 3 Click **Print**.

Printing from a flash drive

A USB port is located on the printer control panel of certain models of the printer. Insert a flash drive to print supported file types. Supported file types include: .pdf, .gif, .jpeg, .jpg, .bmp, .png, .tiff, .tif, .pcx, and .dcx.

The following flash drives are tested and approved for use with the printer:

- Lexar Firefly (512 MB or 1 GB sizes)
- SanDisk Cruizer Micro (512 MB, or 1G sizes)
- Sony (512 MB or 1G sizes)



Notes:

- When a USB flash memory device is inserted into the printer, the printer can only scan to the USB device or print files from the USB device. All other printer functions are unavailable.
- Hi-Speed flash drives must meet the USB 2.0 specification, specifically supporting the High Speed mode. Devices having only USB Low-speed capabilities are not supported.
- USB devices must support the FAT or FAT32 (*File Allocation Tables*) system. Devices formatted with NTFS (*New Technology File System*) or any other file system are not supported.
- You cannot print files for which you do not have printing permissions.
- Some USB drives and USB hubs are not supported.

To print from a flash drive:

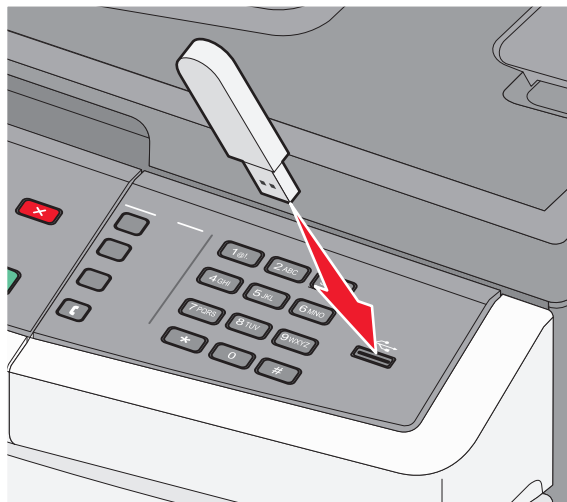





- 1 Make sure the printer is on and **Ready** or **Busy** appears.
- 2 Insert a flash drive into the USB port.

**Notes:**

- If you insert the flash drive when the printer requires attention, such as when a jam has occurred, the printer ignores the flash drive.
 - If you insert the flash drive while the printer is printing other jobs, **Busy** appears. After the other jobs are processed, you may need to view the held jobs list to print documents from the flash drive.
- 3 Press the arrow buttons until the document you want to print appears, and then press .
- Note:** Folders found on the flash drive appear with a + in front of the folder (for example, + documents). File names are appended by the extension type (for example, .jpg).
- 4 Press  to print one copy, or enter the number of copies using the keypad, and then press  to initiate the print job.
- Note:** Do not remove the flash drive from the USB port until the document has finished printing.

Printing on both sides of the paper (duplexing)

In order to save paper, you can print on both sides of a sheet of paper.

- 1 From the printer control panel, press .
- 2 Press the arrow buttons until **Settings** appears, and then press .
- 3 Press the arrow buttons until **Print Settings** appears, and then press .
- 4 Press the arrow buttons until **Finishing Menu** appears, and then press .
- 5 Press the arrow buttons until **Sides (Duplex)** appears, and then press .
- 6 Press the arrow buttons until **2 sided** appears, and then press .
- 7 Press  to return to **Ready**.

Printing specialty documents

Tips on using letterhead

Page orientation is important when printing on letterhead. Use the following table to determine which direction to load the letterhead:

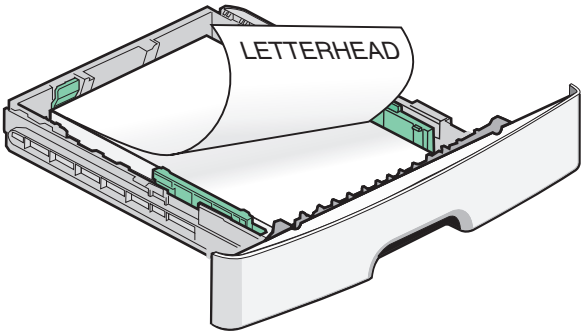
Source or process	Print side	Paper orientation
One-sided printing from trays	Printed letterhead design is placed facedown.	The top edge of the sheet with the logo is placed at the front of the tray. 
Note: Check with the manufacturer or vendor to determine whether the chosen preprinted letterhead is acceptable for laser printers.		

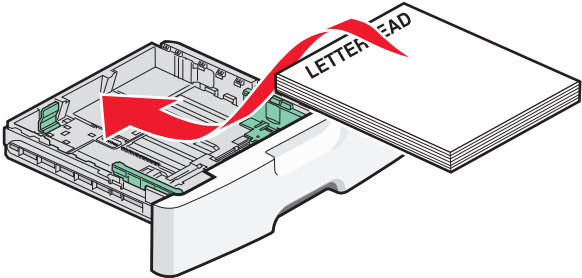
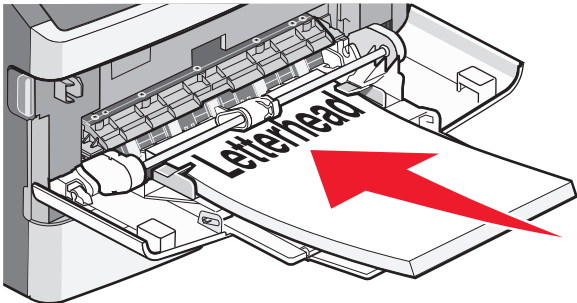
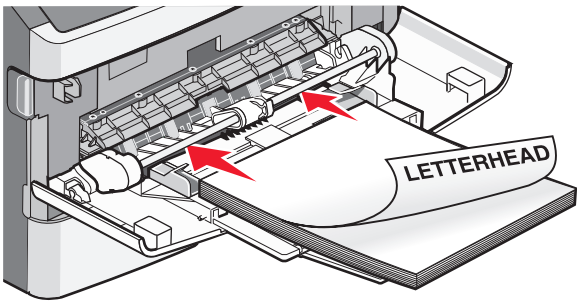
Source or process	Print side	Paper orientation
Two-sided printing from trays	Printed letterhead design is placed faceup.	<p>The top edge of the sheet with the logo is placed at the front of the tray.</p> 
One-sided printing using the multipurpose feeder or manual feeder	Preprinted letterhead design is placed faceup.	<p>The top edge of the sheet with the logo should enter the multipurpose feeder or manual feeder first.</p> 
Two-sided printing using the multipurpose feeder or the manual feeder	Preprinted letterhead design is placed facedown.	<p>The top edge of the sheet with the logo should enter the multipurpose feeder or manual feeder last.</p> 
<p>Note: Check with the manufacturer or vendor to determine whether the chosen preprinted letterhead is acceptable for laser printers.</p>		

Tips on using transparencies

Print samples on the transparencies being considered for use before buying large quantities.

When printing on transparencies:

- Feed transparencies from the standard 250-sheet tray or the multipurpose or manual feeder.
- Use transparencies designed specifically for laser printers. Check with the manufacturer or vendor to ensure transparencies are able to withstand temperatures up to 175°C (350°F) without melting, discoloring, offsetting, or releasing hazardous emissions.

Note: Transparencies can be printed at a temperature up to 180°C (356°F) if Transparency Weight is set to Heavy and Transparency Texture is set to Rough. Select these settings using the Embedded Web Server, or from the printer control panel Paper menu.

- To prevent print quality problems, avoid getting fingerprints on the transparencies.
- Before loading transparencies, fan the stack to prevent sheets from sticking together.
- We recommend Lexmark part number 70X7240 for letter-size transparencies and Lexmark part number 12A5010 for A4-size transparencies.

Tips on using envelopes

Print samples on the envelopes being considered for use before buying large quantities.

When printing on envelopes:

- Use envelopes designed specifically for laser printers. Check with the manufacturer or vendor to ensure the envelopes can withstand temperatures up to 210°C (410°F) without sealing, wrinkling, curling excessively, or releasing hazardous emissions.
- For the best performance, use envelopes made from 90 g/m² (24 lb bond) paper. Use up to 105 g/m² (28 lb bond) weight for envelopes as long as the cotton content is 25% or less. All-cotton envelopes must not exceed 90 g/m² (24 lb bond) weight.
- Use only new envelopes.
- To optimize performance and minimize jams, do not use envelopes that:
 - Have excessive curl or twist
 - Are stuck together or damaged in any way
 - Have windows, holes, perforations, cutouts, or embossing
 - Have metal clasps, string ties, or folding bars
 - Have an interlocking design
 - Have postage stamps attached
 - Have any exposed adhesive when the flap is in the sealed or closed position
 - Have bent corners
 - Have rough, cockle, or laid finishes
- Adjust the width guides to fit the width of the envelopes.

Note: A combination of high humidity (over 60%) and the high printing temperature may wrinkle or seal envelopes.

Tips on using labels

Print samples on the labels being considered for use before buying large quantities.

Note: Use only paper label sheets. Vinyl, pharmacy, and dual-sided labels are not supported.

For detailed information on label printing, characteristics, and design, see the *Card Stock & Label Guide* available on the Lexmark Web site at www.lexmark.com/publications.

When printing on labels:

- Use labels designed specifically for laser printers. Check with the manufacturer or vendor to verify that:
 - The labels can withstand temperatures up to 210°C (410°F) without sealing, excessive curling, wrinkling, or releasing hazardous emissions.

Note: Labels can be printed at a higher fusing temperature up to 220°C (428°F) if Label Weight is set to Heavy. Select this setting using the Embedded Web Server, or from the printer control panel Paper menu.
 - Label adhesives, face sheet (printable stock), and topcoats can withstand up to 25 psi (172 kPa) pressure without delaminating, oozing around the edges, or releasing hazardous fumes.
- Do not use labels with slick backing material.
- Use full label sheets. Partial sheets may cause labels to peel off during printing, resulting in a jam. Partial sheets also contaminate the printer and the cartridge with adhesive, and could void the printer and cartridge warranties.
- Do not use labels with exposed adhesive.
- Do not print within 1 mm (0.04 in.) of the edge of the label, of the perforations, or between die-cuts of the label.
- Be sure adhesive backing does not reach to the sheet edge. Zone coating of the adhesive at least 1 mm (0.04 in.) away from edges is recommended. Adhesive material contaminates the printer and could void the warranty.
- If zone coating of the adhesive is not possible, remove a 1.6 mm (0.06 in.) strip on the leading and driver edge, and use a non-oozing adhesive.
- Portrait orientation works best, especially when printing bar codes.

Tips on using card stock

Card stock is heavy, single-ply specialty media. Many of its variable characteristics, such as moisture content, thickness, and texture, can significantly impact print quality. Print samples on the card stock being considered for use before buying large quantities.

When printing on card stock:





- Make sure the Paper Type is Card Stock.
- Select the appropriate Paper Texture setting.
- Be aware that preprinting, perforation, and creasing may significantly affect the print quality and cause jams or other paper handling problems.
- Check with the manufacturer or vendor to ensure the card stock can withstand temperatures up to 210°C (410°F) without releasing hazardous emissions.
- Do not use preprinted card stock manufactured with chemicals that may contaminate the printer. Preprinting introduces semi-liquid and volatile components into the printer.
- Use grain short card stock when possible.

Printing information pages

See “Printing a menu settings page” on page 24 and “Printing a network setup page” on page 24 for more information on printing these pages.



Printing a font sample list

To print samples of the fonts currently available for your printer:

- 1 Make sure the printer is on and **Ready** appears.
 - 2 From the printer control panel, press .
 - 3 Press the arrow buttons until **Reports** appears, and then press .
 - 4 Press the arrow buttons until **Print Fonts** appears, and then press .
 - 5 Press the arrow buttons until **PCL Fonts** or **PostScript Fonts** appears, and then press .
- After the font sample list prints, **Ready** appears.





Printing a directory list

A directory list shows the resources stored in flash memory.

- 1 Make sure the printer is on and **Ready** appears.
 - 2 From the printer control panel, press .
 - 3 Press the arrow buttons until **Reports** appears, and then press .
 - 4 Press the arrow buttons until **Print Directory** appears, and then press .
- After the directory list prints, **Ready** appears.

Printing the print quality test pages

Print the print quality test pages to isolate print quality problems.

- 1 Turn the printer off.
 - 2 Hold down  and  while turning the printer on.
 - 3 Release the buttons when the clock appears, and wait for **CONFIG MENU** to appear.
 - 4 Press the arrow buttons until **Prt Quality Pgs** appears, and then press .
 - 5 Press the arrow buttons until **Exit Config Menu** appears, and then press .
- Resetting the Printer** appears briefly, followed by a clock, and then **Ready** appears.

Canceling a print job

Canceling a print job from the printer control panel

- 1 Press **X**.
Stopping... appears, followed by **Cancel Print Job** or a list of jobs.
- 2 If a list of jobs appears, press the arrow buttons to select which job to cancel, and then press  or **X**.

Canceling a print job from the computer

To cancel a print job, do one of the following:

For Windows users

- 1 Click , or click **Start** and then click **Run**.
- 2 In the Start Search or Run box, type **control printers**.
- 3 Press **Enter**, or click **OK**.
The printer folder opens.
- 4 Double-click the printer icon.
- 5 Select the job to cancel.
- 6 From the keyboard, press **Delete**.

From the Windows taskbar:

When you send a job to print, a small printer icon appears in the right corner of the taskbar.

- 1 Double-click the printer icon.
A list of print jobs appears in the printer window.
- 2 Select a job to cancel.
- 3 From the keyboard, press **Delete**.

For Macintosh users

In Mac OS X version 10.5 or later:

- 1 From the Apple menu, choose **System Preferences**.
- 2 Click **Print & Fax**, and then double-click the printer icon.
- 3 From the printer window, select the job to cancel.
- 4 From the icon bar at the top of the window, click the **Delete** icon.

In Mac OS X version 10.4 and earlier:

- 1 From the Go menu, choose **Applications**.
- 2 Double-click **Utilities**, and then double-click **Print Center** or **Printer Setup Utility**.

- 3 Double-click the printer icon.
- 4 From the printer window, select the job to cancel.
- 5 From the icon bar at the top of the window, click the **Delete** icon.

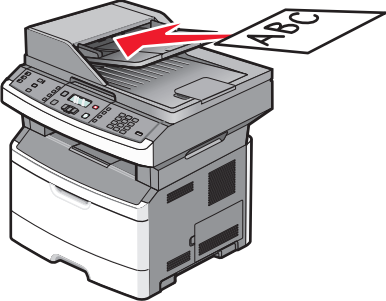
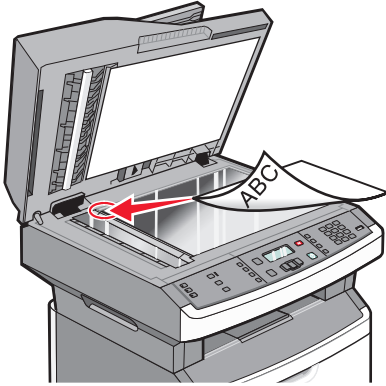

Copying

ADF	Scanner glass
 <p>Use the ADF for multiple-page documents.</p>	 <p>Use the scanner glass for single pages, small items (such as postcards or photos), transparencies, photo paper, or thin media (such as magazine clippings).</p>

Making copies

Making a quick copy



- 1 Load an original document faceup, short edge first into the ADF or facedown on the scanner glass.

Note: Do not load postcards, photos, small items, transparencies, photo paper, or thin media (such as magazine clippings) into the ADF. Place these items on the scanner glass.
- 2 If you are loading a document into the ADF, then adjust the paper guides.
- 3 From the printer control panel, press .
- 4 If you placed the document on the scanner glass and have additional pages to copy, then place the next page on the scanner glass, and then press **1** on the keypad. Otherwise, press **2** on the keypad.
- 5 Press  to return to **Ready**.



Copying using the ADF

- 1 Load an original document faceup, short edge first into the ADF.



Note: Do not load postcards, photos, small items, transparencies, photo paper, or thin media (such as magazine clippings) into the ADF. Place these items on the scanner glass.
- 2 Adjust the paper guides so they touch the sides of the paper.
- 3 From the printer control panel, press **Copy**, or use the keypad to enter the number of copies.
- 4 Change the copy settings as needed.

- 5 From the printer control panel, press .
- 6 Press  to return to **Ready**.

Copying using the scanner glass



- 1 Place an original document facedown on the scanner glass in the upper left corner.
- 2 From the printer control panel, press the **Copy** button, or use the keypad to enter the number of copies.
- 3 Change the copy settings as needed.
- 4 From the printer control panel, press .
- 5 Place the next document on the scanner glass, and then press **1** on the keypad. Otherwise, press **2** on the keypad.
- 6 Press  to return to **Ready**.



Copying photos

- 1 Place a photo facedown on the scanner glass in the upper left corner.
- 2 From the printer control panel, press the **Copy** button.
- 3 Press the **Content** button until the light next to **Photo** comes on.
- 4 Change the copy settings as needed.
- 5 From the printer control panel, press .
Another page? 1=Yes 2=No appears.
- 6 If you want to copy another photo, place it on the scanner glass, and then press **1** on the keypad. Otherwise, press **2** on the keypad.
- 7 Press  to return to **Ready**.





Copying on specialty media

Copying to transparencies

- 1 Load an original document faceup, short edge first into the ADF or facedown on the scanner glass.
Note: Do not load postcards, photos, small items, transparencies, photo paper, or thin media (such as magazine clippings) into the ADF. Place these items on the scanner glass.
- 2 If you are loading a document into the ADF, then adjust the paper guides.
- 3 From the printer control panel, press the **Copy** button.
- 4 From the Copy area, press the **Options** button.
- 5 Press the arrow buttons until **Paper Source** appears, and then press .
- 6 Press the arrow buttons until the paper source containing the transparencies appears, and then press .
- 7 Press .



- 8 Change the copy settings as needed.
- 9 Press .
- 10 If you placed the document on the scanner glass and have additional pages to copy, then place the next page on the scanner glass, and then press **1** on the keypad. Otherwise, press **2** on the keypad.
- 11 Press  to return to **Ready**.





Copying to letterhead

- 1 Load an original document faceup, short edge first into the ADF or facedown on the scanner glass.
Note: Do not load postcards, photos, small items, transparencies, photo paper, or thin media (such as magazine clippings) into the ADF. Place these items on the scanner glass.
- 2 If you are loading a document into the ADF, then adjust the paper guides.
- 3 From the printer control panel, press the **Copy** button.
- 4 Press the **Options** button.
- 5 Press the arrow buttons until **Paper Source** appears, and then press .
- 6 Press the arrow buttons until the paper source containing the letterhead appears, and then press .
- 7 Change the copy settings as needed.
- 8 Press .
- 9 If you placed the document on the scanner glass and have additional pages to copy, then place the next page on the scanner glass, and then press **1** on the keypad. Otherwise, press **2** on the keypad.
- 10 Press  to return to **Ready**.





Customizing copy settings

Copying from one size to another

- 1 Load an original document faceup, short edge first into the ADF or facedown on the scanner glass.
Note: Do not load postcards, photos, small items, transparencies, photo paper, or thin media (such as magazine clippings) into the ADF. Place these items on the scanner glass.
- 2 If you are loading a document into the ADF, then adjust the paper guides.
- 3 From the printer control panel, press the **Copy** button.
- 4 Press the **Options** button.
Original Size appears.
- 5 Press .
- 6 Press the arrow buttons until the size of the original document appears, and then press .
- 7 Press the arrow buttons until **Paper Source** appears, and then press .

- 8 Press the arrow buttons until the tray or source containing the size you want the copy to be appears, and then press .
- Note:** If you select a paper size that is different from the original size, then the printer will scale the size automatically.
- 9 Press .
- 10 Change the copy settings as needed.
- 11 Press .
- 12 If you placed the document on the scanner glass and have additional pages to copy, then place the next page on the scanner glass, and then press **1** on the keypad. Otherwise, press **2** on the keypad.
- 13 Press  to return to **Ready**.

Making copies using paper from a selected tray

- 1 Load an original document faceup, short edge first into the ADF or facedown on the scanner glass.
Note: Do not load postcards, photos, small items, transparencies, photo paper, or thin media (such as magazine clippings) into the ADF. Place these items on the scanner glass.
- 2 If you are loading a document into the ADF, then adjust the paper guides.
- 3 From the printer control panel, press the **Copy** button.
- 4 Press the **Options** button.
- 5 Press the arrow buttons until **Paper Source** appears, and then press .
- 6 Press the arrow buttons until the tray or source containing the paper type that you want appears, and then press .
- 7 Press .
- 8 Change the copy settings as needed.
- 9 Press .
- 10 If you placed the document on the scanner glass and have additional pages to copy, then place the next page on the scanner glass, and then press **1** on the keypad. Otherwise, press **2** on the keypad.
- 11 Press  to return to **Ready**.



Copying on both sides of the paper (duplexing)

Note: The ADF duplex feature is not available on selected printer models.

- 1 Load a document faceup, short edge first into the ADF or facedown on the scanner glass.
Note: Do not load postcards, photos, small items, transparencies, photo paper, or thin media (such as magazine clippings) into the ADF. Place these items on the scanner glass.
- 2 If you are loading a document into the ADF, then adjust the paper guides.
- 3 From the printer control panel, press the **Copy** button.
- 4 Press the **Duplex/2-Sided** button.

- 5 Press the arrow buttons to select a duplex option, and then press .

The first number represents sides of the original documents; the second number represents sides of the copy. For example, select **1 To 2 Sided** if you have 1-sided original documents and you want 2-sided copies.

- 6 Press .
- 7 If you placed the document on the scanner glass and have additional pages to copy, then place the next page on the scanner glass, and then press **1** on the keypad. Otherwise, press **2** on the keypad.
- 8 Press  to return to **Ready**.

Reducing or enlarging copies



Copies can be reduced to 25% of the original document size or enlarged to 400% of the original document size. The factory default setting for Scale is Auto. If you leave Scale set to Auto, then the content of your original document will be scaled to fit the size of the paper onto which you are copying.

To reduce or enlarge a copy:

- 1 Load an original document faceup, short edge first into the ADF or facedown on the scanner glass.
Note: Do not load postcards, photos, small items, transparencies, photo paper, or thin media (such as magazine clippings) into the ADF. Place these items on the scanner glass.
- 2 If you are loading a document into the ADF, then adjust the paper guides.
- 3 From the printer control panel, press the **Copy** button.
- 4 Press the **Scale** button.
- 5 Press the arrow buttons until the scale option you want appears, and then press .



If you selected Custom, then do the following:

 - a Press the arrow buttons to decrease or increase the size, or enter a number between 25 and 400 on the keypad.
 - b Press .

- 6 Press .
- 7 If you placed the document on the scanner glass and have additional pages to copy, then place the next page on the scanner glass, and then press **1** on the keypad. Otherwise, press **2** on the keypad.
- 8 Press  to return to **Ready**.



Making a copy lighter or darker

- 1 Load an original document faceup, short edge first into the ADF or facedown on the scanner glass.
Note: Do not load postcards, photos, small items, transparencies, photo paper, or thin media (such as magazine clippings) into the ADF. Place these items on the scanner glass.
- 2 If you are loading a document into the ADF, then adjust the paper guides.
- 3 From the printer control panel, press the **Copy** button.
- 4 Press the **Darkness** button.
- 5 Press the arrow buttons to make the copy lighter or darker.

- 6 Press .
- 7 Press .
- 8 If you placed the document on the scanner glass and have additional pages to copy, then place the next page on the scanner glass, and then press **1** on the keypad. Otherwise, press **2** on the keypad.
- 9 Press  to return to **Ready**.

Adjusting copy quality

- 1 Load an original document faceup, short edge first into the ADF or facedown on the scanner glass.

Note: Do not load postcards, photos, small items, transparencies, photo paper, or thin media (such as magazine clippings) into the ADF. Place these items on the scanner glass.
- 2 If you are loading a document into the ADF, then adjust the paper guides.
- 3 From the printer control panel, press the **Copy** button.
- 4 Press the **Content** button until the light comes on next to the setting that best represents what you are copying:
 - **Text**—Used for original documents that are mostly text or line art
 - **Text/Photo**—Used when the original documents are a mixture of text and graphics or pictures
 - **Photo**—Used when the original document is a high-quality photograph or inkjet print
- 5 Press .
- 6 If you placed the document on the scanner glass and have additional pages to copy, then place the next page on the scanner glass, and then press **1** on the keypad. Otherwise, press **2** on the keypad.
- 7 Press  to return to **Ready**.

Collating copies

If you print multiple copies of a document, then you can choose to print each copy as a set (collated) or to print the copies as groups of pages (not collated).

Collated



Not collated







If you want to collate your copies, then select On. If you do not want to collate your copies, then select Off.

To select a Collate setting:

- 1 Load an original document faceup, short edge first into the ADF or facedown on the scanner glass.

Note: Do not load postcards, photos, small items, transparencies, photo paper, or thin media (such as magazine clippings) into the ADF. Place these items on the scanner glass.
- 2 If you are loading a document into the ADF, then adjust the paper guides.
- 3 From the printer control panel, press the **Copy** button.
- 4 Press the **Options** button.

- 5 Press the arrow buttons until **Collate** appears, and then press .
- 6 Press the arrow buttons until **On [1, 2, 1, 2, 1, 2]** or **Off [1, 1, 1, 2, 2, 2]** appears, and then press  to select one.
- 7 Press .
- 8 If you placed the document on the scanner glass and have additional pages to copy, then place the next page on the scanner glass, and then press **1** on the keypad. Otherwise, press **2** on the keypad.
- 9 Press  to return to **Ready**.

Placing separator sheets between copies





- 1 Type the printer IP address into the address field of your Web browser.
Note: If you do not know the IP address of the printer, then print a network setup page and locate the address in the TCP/IP section.
- 2 Click **Settings**.
- 3 Click **Copy Settings**.
- 4 Click **Separator Sheets**.
Note: Collate must be On for the separator sheets to be placed between copies. If Collate is Off, then the separator sheets are added to the end of the print job.
- 5 Select one of the following:
 - **Between pages**
 - **Between copies**
 - **Between jobs**
- 6 Click **Submit**.

Copying multiple pages onto a single sheet

In order to save paper, you can copy either two or four consecutive pages of a multiple-page document onto a single sheet of paper.

Notes:



- The Paper Size must be set to Letter, Legal, A4, or B5 JIS.
 - The Copy Size must be set to 100%.
- 1 Load an original document faceup, short edge first into the ADF or facedown on the scanner glass.
Note: Do not load postcards, photos, small items, transparencies, photo paper, or thin media (such as magazine clippings) into the ADF. Place these items on the scanner glass.
 - 2 If you are loading a document into the ADF, then adjust the paper guides.
 - 3 From the printer control panel, press the **Copy** button.
 - 4 Press the **Options** button.
 - 5 Press the arrow buttons until **Paper Saver** appears, and then press .

- 6 Select the output you want, and then press .
For example, if you have four portrait-oriented original documents that you want copied to the same side of one sheet, then select **4 on 1 Portrait**, and then press .
- 7 Press .
- 8 If you placed the document on the scanner glass and have additional pages to copy, then place the next page on the scanner glass, and then press **1** on the keypad. Otherwise, press **2** on the keypad.
- 9 Press  to return to **Ready**.

Pausing the current print job to make copies







When the “Allow priority copies” setting is On, the printer pauses the current print job when you start a copy job.

Note: The “Allow priority copies” setting must be set to On in the Copy Settings menu so that you can pause the current print job and make copies.

- 1 Load an original document faceup, short edge first into the ADF or facedown on the scanner glass.
Note: Do not load postcards, photos, small items, transparencies, photo paper, or thin media (such as magazine clippings) into the ADF. Place these items on the scanner glass.
- 2 If you are loading a document into the ADF, then adjust the paper guides.
- 3 From the printer control panel, press .
- 4 If you placed the document on the scanner glass and have additional pages to copy, then place the next page on the scanner glass, and then press **1** on the keypad. Otherwise, press **2** on the keypad.
- 5 Press  to return to **Ready**.

Placing an overlay message on each page

An overlay message can be placed on each page. The message choices are Confidential, Copy, Draft, Urgent, or Custom. To place a message on the copies:

- 1 Load an original document faceup, short edge first into the ADF or facedown on the scanner glass.
Note: Do not load postcards, photos, small items, transparencies, photo paper, or thin media (such as magazine clippings) into the ADF. Place these items on the scanner glass.
- 2 If you are loading a document into the ADF, then adjust the paper guides.
- 3 From the printer control panel, press .
- 4 Press the arrow buttons until **Settings** appears, and then press .
- 5 Press the arrow buttons until **Copy Settings** appears, and then press .
- 6 Press the arrow buttons until **Overlay** appears, and then press .
- 7 Select the message you prefer among **Confidential**, **Copy**, **Draft**, **Urgent**, or **Custom**, and then press .
- 8 Press .

Canceling a copy job

A copy job can be canceled when the document is in the ADF, on the scanner glass, or while the document is printing. To cancel a copy job:

- 1 From the printer control panel, press **X**.
Stopping appears, followed by **Cancel Job**.
- 2 Press **X** to cancel the job.
Canceling appears.

The printer clears all pages in the ADF or printer and then cancels the job.

Improving copy quality

Question	Tip
When should I use Text mode?	<ul style="list-style-type: none"> • Use text mode when text preservation is the main goal of the copy, and preserving images copied from the original document is not a concern. • Text mode is recommended for receipts, carbon copy forms, and documents that contain only text or fine line art.
When should I use Text/Photo mode?	<ul style="list-style-type: none"> • Use Text/Photo mode when copying an original document that contains a mixture of text and graphics. • Text/Photo mode is recommended for magazine articles, business graphics, and brochures.
When should I use Photograph mode?	Use Photograph mode when the original document is a high-quality photograph or inkjet print.

E-mailing

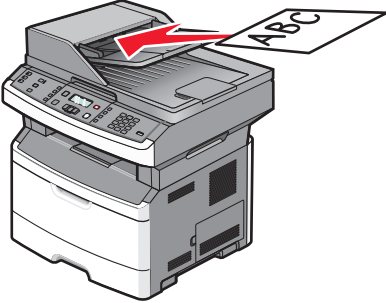
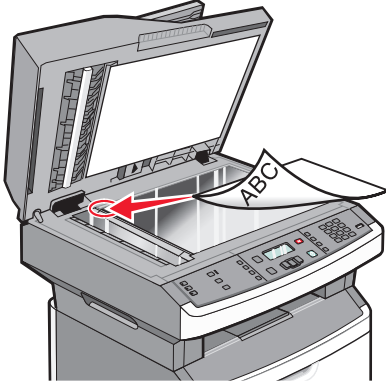
ADF	Scanner glass
 <p data-bbox="151 806 613 835">Use the ADF for multiple-page documents.</p>	 <p data-bbox="630 806 1409 898">Use the scanner glass for single pages, small items (such as postcards or photos), transparencies, photo paper, or thin media (such as magazine clippings).</p>

You can use the printer to e-mail scanned documents to one or more recipients. There are three ways to send an e-mail from the printer. You can type the e-mail address, use a shortcut number, or use the address book.

Getting ready to e-mail

Setting up the e-mail function

For e-mail to operate, it must be turned on in the printer configuration and have a valid IP address or gateway address. To set up the e-mail function:

- 1 Type the printer IP address into the address field of your Web browser.

Note: If you do not know the IP address of the printer, then print a network setup page and locate the IP address in the TCP/IP section.

- 2 Click **Settings**.
- 3 Under Default Settings, click **E-mail/FTP Settings**.
- 4 Click **E-mail Settings**.
- 5 Click **Setup E-mail Server**.
- 6 Fill in the fields with the appropriate information.
- 7 Click **Add**.

Setting up the address book

- 1 Type the printer IP address into the address field of your Web browser.

Note: If you do not know the IP address of the printer, then print a network setup page and locate the address in the TCP/IP section.

- 2 Click **Settings**.
- 3 Click **E-mail/FTP Settings**.
- 4 Click **Manage E-mail Shortcuts**.
- 5 Change the e-mail settings as needed.
- 6 Click **Submit**.

Creating an e-mail shortcut using the Embedded Web Server

- 1 Type the printer IP address into the address field of your Web browser.

Note: If you do not know the IP address of the printer, then print a network setup page and locate the IP address in the TCP/IP section.

- 2 Click **Settings**.
- 3 Under Other Settings, click **Manage Shortcuts**.
- 4 Click **E-mail Shortcut Setup**.
- 5 Type a unique name for the recipient, and then enter the e-mail address.

Note: If you are entering multiple addresses, then separate each address with a comma (,).

- 6 Select the scan settings (Format, Content, Color, and Resolution).
- 7 Enter a shortcut number, and then click **Add**.
If you enter a number that is already in use, then you are prompted to select another number.

E-mailing a document

Sending an e-mail using the keypad

- 1 Load an original document faceup, short edge first into the ADF or facedown on the scanner glass.

Note: Do not load postcards, photos, small items, transparencies, photo paper, or thin media (such as magazine clippings) into the ADF. Place these items on the scanner glass.



- 2 If you are loading a document into the ADF, then adjust the paper guides.
- 3 From the printer control panel, press the **Scan/Email** button.

Scan to E-mail appears.



- 4 Press .

Search appears.

Note: If there are no entries in the address book, then **Manual Entry** appears.



- 5 Press  to search the address book, or press the arrow buttons until **Manual** appears, and then press  to select or enter an e-mail address.

Using the address book

- a After selecting **Search** on the printer control panel, press the arrow buttons until the address you want appears, and then press .
- b Press **1** to search for another address, or press **2** to end the search.
After you press **2**, **Press Start To Begin** appears.
- c Press .

Manually entering an e-mail address

After selecting **Manual** on the printer control panel, **Entry Name** appears on the first line, and a blank line with a blinking cursor appears on the second line.

- a Press the button on the keypad that corresponds with the number or letter you want. The first time you press the button, the number for that button appears. When you press the button again, one of the letters assigned to that button appears.
 - b Press the right arrow button to move to the next space, or wait a few seconds, and the cursor will move to the next space.
 - c Once the e-mail address is entered, press .
- Another E-mail? 1=Yes 2=NO** appears.
- d Press **1** to enter another address, or press **2** to end the address entry.
After you press **2**, **Press Start To Begin** appears.
 - e Press .

Sending an e-mail using a shortcut number

- 1 Load an original document faceup, short edge first into the ADF or facedown on the scanner glass.

Note: Do not load postcards, photos, small items, transparencies, photo paper, or thin media (such as magazine clippings) into the ADF. Place these items on the scanner glass.

- 2 If you are loading a document into the ADF, then adjust the paper guides.

- 3 From the printer control panel, press the **Scan/Email** button.

Scan to E-mail appears.

- 4 Press .





Search appears.

Note: If there are no entries in the address book, then **Manual Entry** appears.

- 5 Press , and then enter the recipient's shortcut number.



- 6 Press **1** to enter another shortcut, or press **2** to end the shortcut entry.
- 7 Press .

Sending an e-mail using the address book

- 1 Load an original document faceup, short edge first into the ADF or facedown on the scanner glass.
Note: Do not load postcards, photos, small items, transparencies, photo paper, or thin media (such as magazine clippings) into the ADF. Place these items on the scanner glass.
- 2 If you are loading a document into the ADF, then adjust the paper guides.
- 3 From the printer control panel, press the **Scan/Email** button.
Scan to E-mail appears.
- 4 Press .
- Search** appears.
Note: If there are no entries in the address book, then **Manual Entry** appears.
- 5 Press  to search the address book.
- 6 Press the arrow buttons until the address you want appears, and then press .
- 7 Press **1** to search for another address, or press **2** to end the search.
After you press **2**, **Press Start To Begin** appears.
- 8 Press .

Canceling an e-mail

An e-mail can be canceled when the document is in the ADF or on the scanner glass. To cancel an e-mail:

- 1 From the printer control panel, press .
- Stopping** appears, and then **Cancel Job** appears.
- 2 Press  to cancel the job.
Note: If you want to continue to process the job, press  to continue scanning the e-mail.
Canceling appears.

The printer clears all pages in the ADF and then cancels the job. Once the job is canceled, the copy screen appears.

Faxing

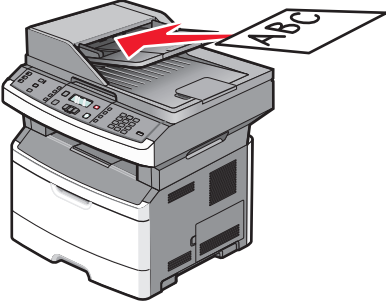
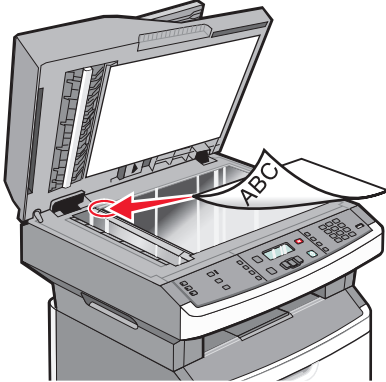
ADF	Scanner glass
 <p>Use the ADF for multiple-page documents.</p>	 <p>Use the scanner glass for single pages, small items (such as postcards or photos), transparencies, photo paper, or thin media (such as magazine clippings).</p>

Getting the printer ready to fax

Only select printer models have fax capability.

The following connection methods may not be applicable in all countries or regions.

⚡ CAUTION—SHOCK HAZARD: Do not use the fax feature during a lightning storm. Do not set up this product or make any electrical or cabling connections, such as the fax feature, power cord, or telephone, during a lightning storm.

Initial fax setup

Many countries and regions require outgoing faxes to contain the following information in a margin at the top or bottom of each transmitted page, or on the first page of the transmission: station name (identification of the business, other entity, or individual sending the message) and station number (telephone number of the sending fax machine, business, other entity, or individual).

To enter your fax setup information, use the printer control panel, or use your browser to access the Embedded Web Server and then enter the Settings menu.



Note: If you do not have a TCP/IP environment, then you must use the printer control panel to enter your fax setup information.

Using the printer control panel for fax setup

When the printer is turned on for the first time or if the printer has been off for an extended time, a series of start-up screens appear. If the printer has fax capabilities, then the following screens appear:

- Station Name
- Station Number

Note: The Station Name and Station Number must be set before a fax can be sent from the printer.

- 1 When **Station Name** appears, enter the name to be printed on all outgoing faxes.
 - a Press the button on the numeric keypad that corresponds with the number or letter you want. The first time you press the button, the number for that button appears. When you press the button again, one of the letters assigned to that button appears.
 - b Press the right arrow button to move to the next space, or wait a few seconds and the cursor will move to the next space.
- 2 After entering the Station Name, press .
- The display changes to Station Number.
- 3 When **Station Number** appears, enter the printer fax number.
 - a Press the button on the numeric keypad that corresponds with the number you want.
 - b Press the right arrow button to move to the next space, or wait a few seconds and the cursor will move to the next space.
- 4 After entering the Station Number, press .

Using the Embedded Web Server for fax setup

- 1 Type the printer IP address into the address field of your Web browser.

Note: If you do not know the IP address of the printer, then print a network setup page and locate the address in the TCP/IP section.
- 2 Click **Settings**.
- 3 Click **Fax Settings**.
- 4 Click **Analog Fax Setup**.
- 5 Click inside the Station Name box, and then enter the name to be printed on all outgoing faxes.
- 6 Click inside the Station Number box, and then enter the printer fax number.
- 7 Click **Submit**.

Choosing a fax connection

You can connect the printer with equipment such as a telephone, an answering machine, or a computer modem. To determine the best way to set up the printer, see the following table.

Notes:

- The printer is an analog device that works best when directly connected to the wall outlet. Other devices (such as a telephone or answering machine) can be successfully attached to pass through the printer, as described in the setup steps.
- If you want a digital connection such as ISDN, DSL, or ADSL, a third-party device (such as a DSL filter) is required. Contact your DSL provider for a DSL filter. The DSL filter removes the digital signal on the telephone line that can interfere with the ability of the printer to fax properly.
- You *do not* need to attach the printer to a computer, but you *do* need to connect it to an analog telephone line to send and receive faxes.

Equipment and service options	Fax connection setup
Connect directly to the telephone line	See “Connecting to an analog telephone line” on page 83
Connect to a Digital Subscriber Line (DSL or ADSL) service	See “Connecting to a DSL service” on page 83.
Connect to a Private Branch eXchange (PBX) or Integrated Services Digital Network (ISDN) system	See “Connecting to a PBX or ISDN system” on page 84.
Use a Distinctive Ring service	See “Connecting to a distinctive ring service” on page 84.
Connect to a telephone line, telephone, and answering machine	See “Connecting the printer and a telephone or answering machine to the same telephone line” on page 85
Connect through an adapter used in your area	See “Connecting to an adapter for your country or region” on page 86.
Connect to a computer with a modem	See “Connecting to a computer with a modem” on page 90.

Connecting to an analog telephone line

If your telecommunications equipment uses a US-style (RJ11) telephone line, then follow these steps to connect the equipment:

- 1 Connect one end of the telephone cable that came with the printer to the printer LINE port .
- 2 Connect the other end of the telephone cable to an active analog telephone wall jack.

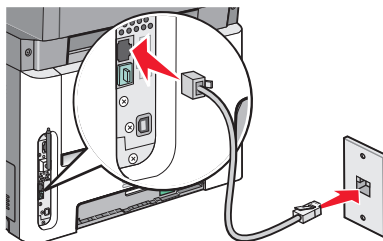

Connecting to a DSL service

If you subscribe to a DSL service, then contact the DSL provider to obtain a DSL filter and telephone cord, and then follow these steps to connect the equipment:

- 1 Connect one end of the telephone cable that came with the printer to the printer LINE port .
- 2 Connect the other end of the telephone cable to the DSL filter.

Note: Your DSL filter may look different than the one in the illustration.

- 3 Connect the DSL filter cable to an active telephone wall jack.

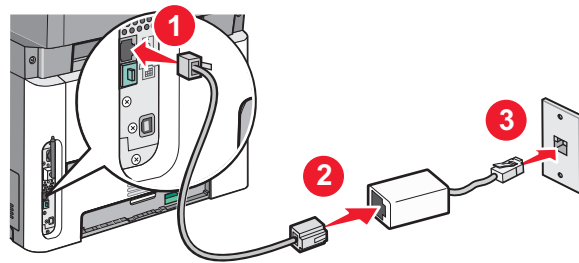

Connecting to a PBX or ISDN system

If you use a PBX or ISDN converter or terminal adapter, then follow these steps to connect the equipment:

- 1 Connect one end of the telephone cable that came with the printer to the printer LINE port .
- 2 Connect the other end of the telephone cable to the port designated for fax and telephone use.

Notes:



- Make sure the terminal adapter is set to the correct switch type for your region.
- Depending on the ISDN port assignment, you may have to connect to a specific port.
- When using a PBX system, make sure the call waiting tone is off.
- When using a PBX system, dial the outside line prefix before dialing the fax number.
- For more information on using the fax with a PBX system, see the documentation that came with your PBX system.

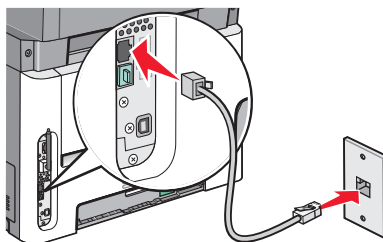

Connecting to a distinctive ring service

A distinctive ring service may be available from your telephone service provider. This service allows you to have multiple telephone numbers on one telephone line with each telephone number having a different ring pattern. This may be useful for distinguishing between fax and voice calls. If you subscribe to a distinctive ring service, follow these steps to connect the equipment:

- 1 Connect one end of the telephone cable that came with the printer to the printer LINE port .
- 2 Connect the other end of the telephone cable to an active analog telephone wall jack.





- 3 Change the Distinctive Rings setting to match the setting you want the printer to answer:
 - a From the printer control panel, press .
 - b Press the arrow buttons until **Settings** appears, and then press .
 - c Press the arrow buttons until **Fax Settings** appears, and then press .

- d Press the arrow buttons until **Distinctive Rings** appears, and then press .
- e Press the arrow buttons until the desired ring tone appears, and then press .

Connecting the printer and a telephone or answering machine to the same telephone line

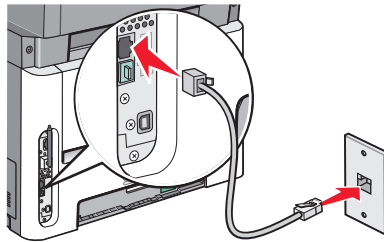
- 1 Connect one end of the telephone cable that came with the printer to the printer LINE port .
- 2 Connect the other end of the telephone cable to an active analog telephone wall jack .



- 3 Remove the plug from the printer EXT port .

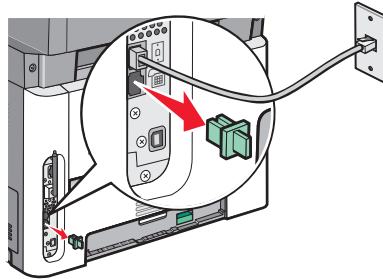

- 4 Connect your telecommunications equipment directly to the printer EXT port .
- Use one of the following methods:

Answering machine

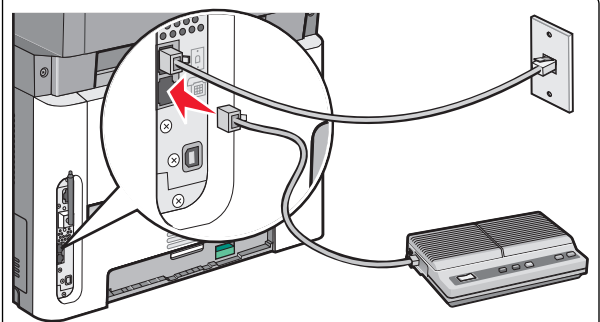

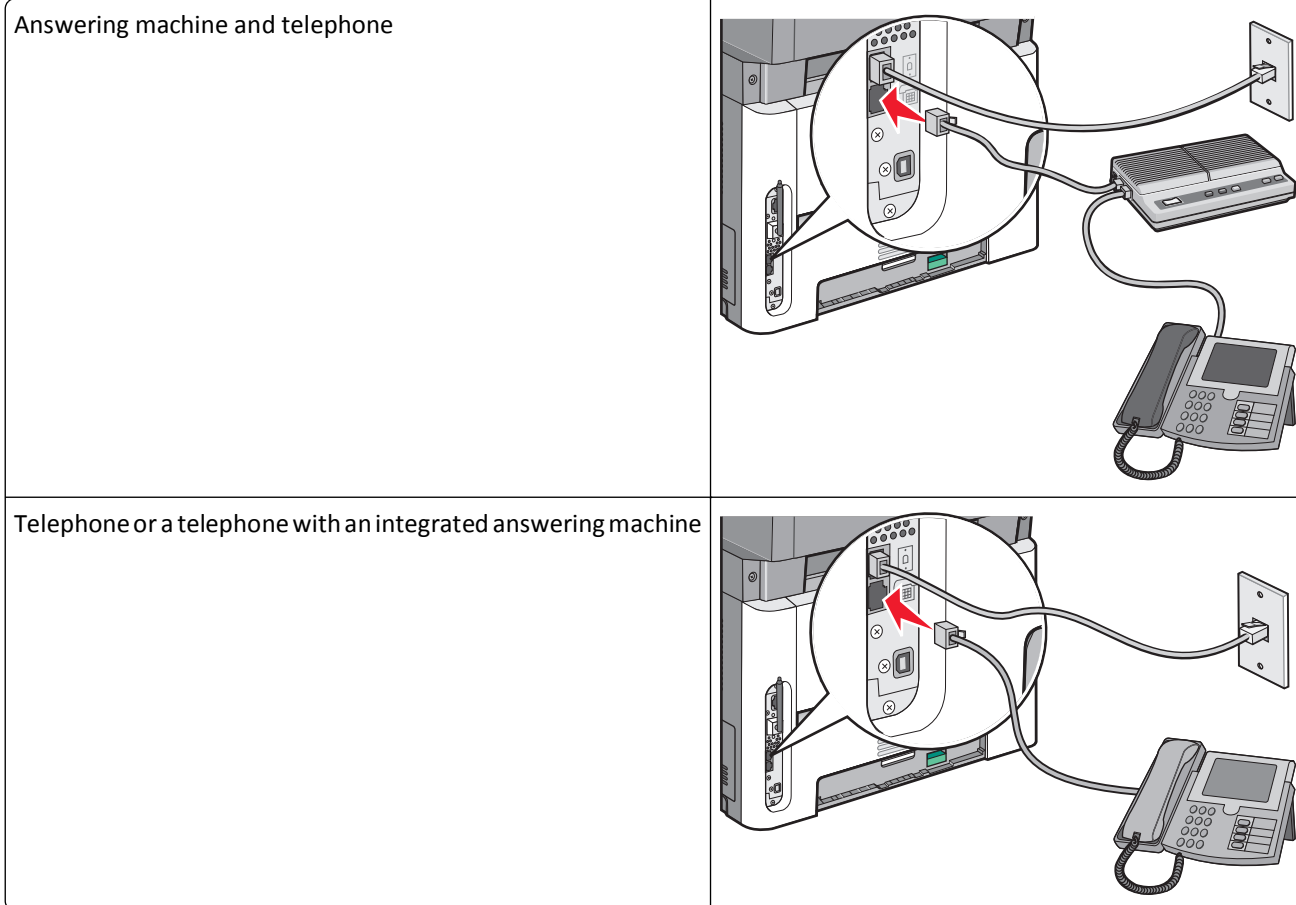

Connecting to an adapter for your country or region

The following countries or regions may require a special adapter to connect the telephone cable to the active telephone wall jack:

Country/region

- Austria
- Cyprus
- Denmark
- Finland
- France
- Germany
- Ireland
- Italy
- New Zealand
- Netherlands
- Norway
- Portugal
- Sweden
- Switzerland
- United Kingdom

Countries or regions except Germany

For some countries or regions, a telephone line adapter is included in the box. Use this adapter to connect an answering machine, telephone, or other telecommunications equipment to the printer.

There is a plug installed in the printer EXT port . This plug is necessary for the proper functioning of the adapter.

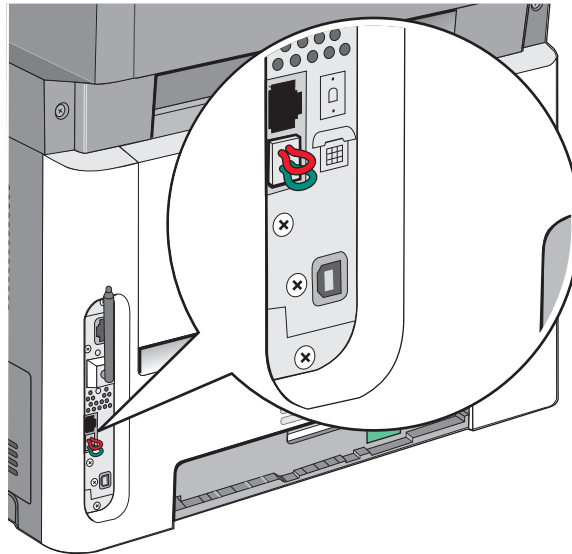

Note: Do not remove the plug if you have a serial phone system or wish to connect a phone or answering machine to the adapter. If you remove it, then other telecommunications devices in your home (such as telephones or answering machines) may not work.

- 1 Connect one end of the telephone cable that came with the printer to the printer LINE port .
- 2 Connect the other end of the telephone cable to the adapter, and then connect the adapter to the active telephone wall jack.

Note: Your telephone adapter may look different than the one shown. It will fit the wall jack used in your location.

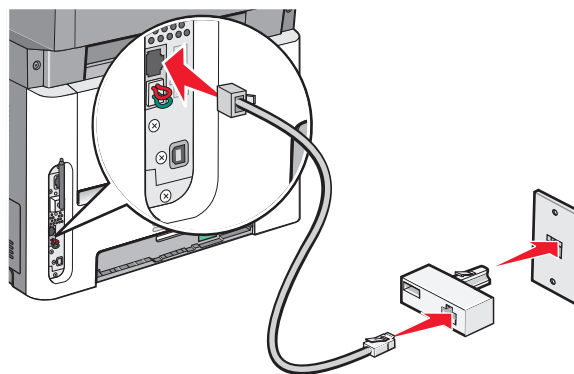

3 Connect the answering machine or telephone to the adapter.

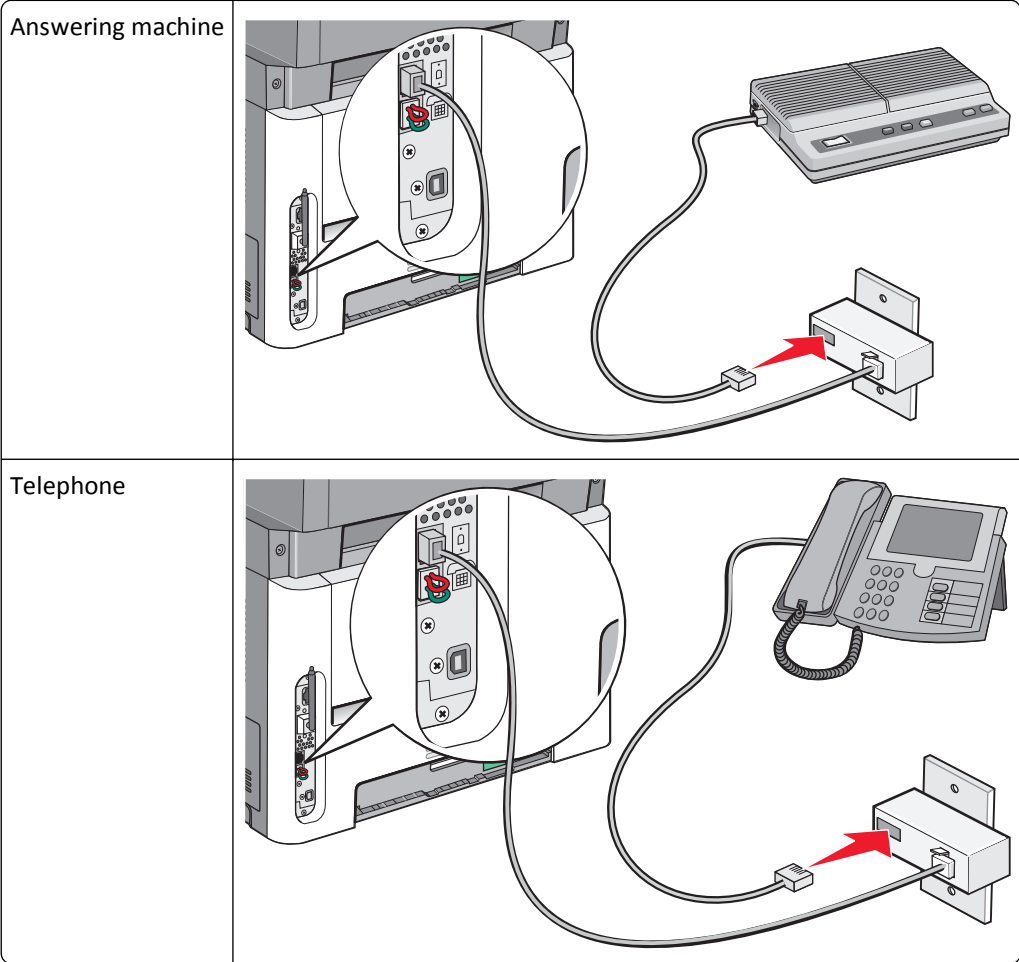

Germany

There is a special RJ-11 plug installed in the printer EXT port . Do not remove this plug. It is necessary for the proper operation of the fax function and of downstream telephones.

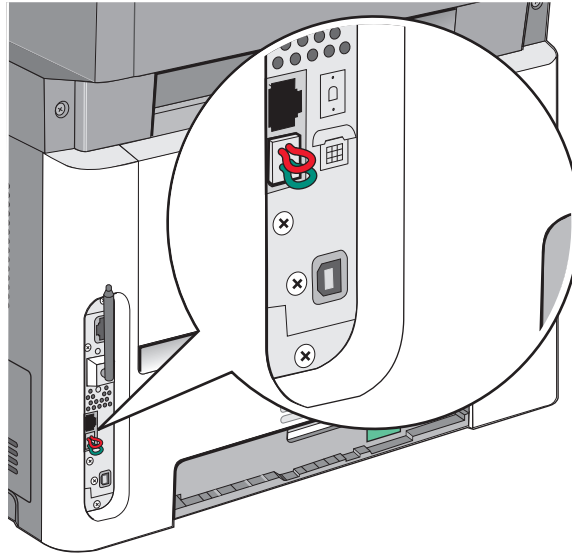

Connecting to a telephone wall jack in Germany

Note: Do not remove the plug. If you remove it, then other telecommunications devices in your home (such as telephones or answering machines) may not work.

- 1 Connect one end of the telephone cable that came with the printer to the printer LINE port .
- 2 Connect the other end of the telephone cable to the adapter.

Note: Your telephone adapter may look different than the one shown. It will fit the wall jack used in your location.

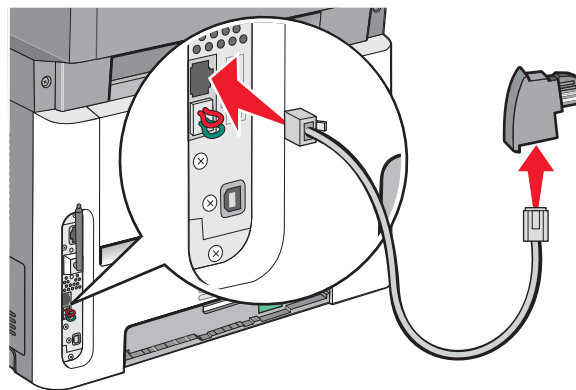

- 3 Connect the adapter into the N slot of an active analog telephone wall jack.

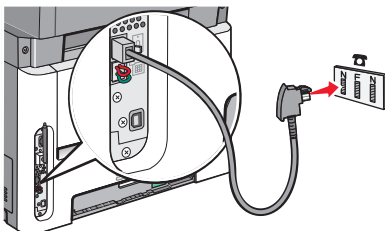

- 4 If you would like to use the same line for both fax and telephone communication, then connect a second telephone line (not provided) between the telephone and the F slot of an active analog telephone wall jack.

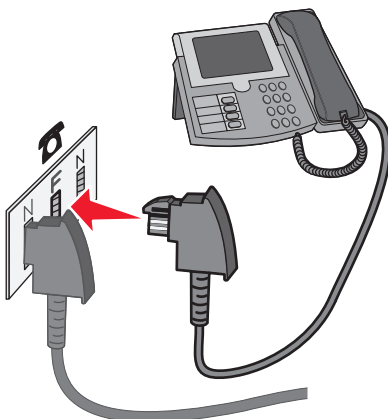

- 5 If you would like to use the same line for recording messages on your answering machine, then connect a second telephone cable between the answering machine and the other N slot of the active analog telephone wall jack.

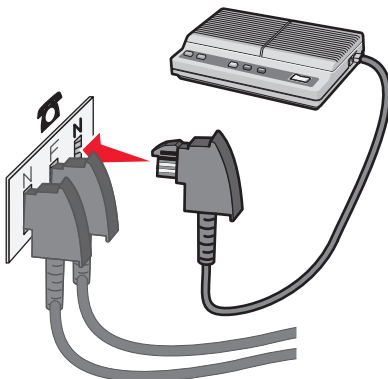

Connecting to a computer with a modem

Connect the printer to a computer with a modem to send faxes from the software program.

Note: Setup steps may vary depending on your country or region.

- 1 Make sure you have the following:
 - A telephone
 - A computer with a modem

- Three telephone cords
- A telephone wall jack

2 Connect one end of the telephone cable that came with the printer to the printer LINE port .

3 Connect the other end of the telephone cable to an active analog telephone wall jack.

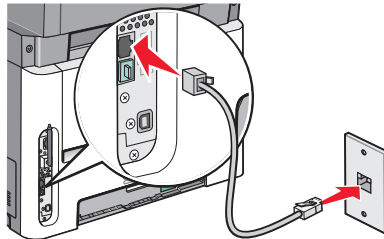

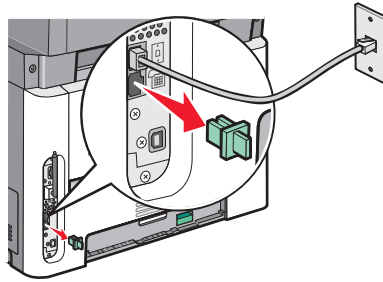

4 Remove the protective plug from the printer EXT port .

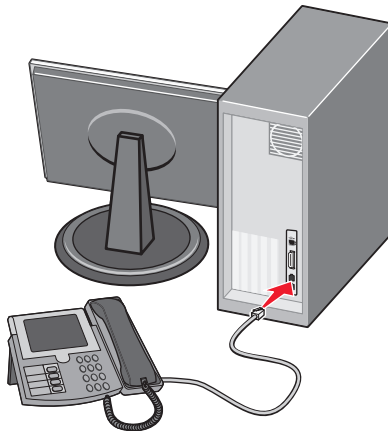

5 Connect your telephone to the computer telephone jack.

Note: See the manual that came with your computer for the telephone connections.



- 6 Connect an additional telephone cord from the computer modem LINE port  to the printer EXT port .

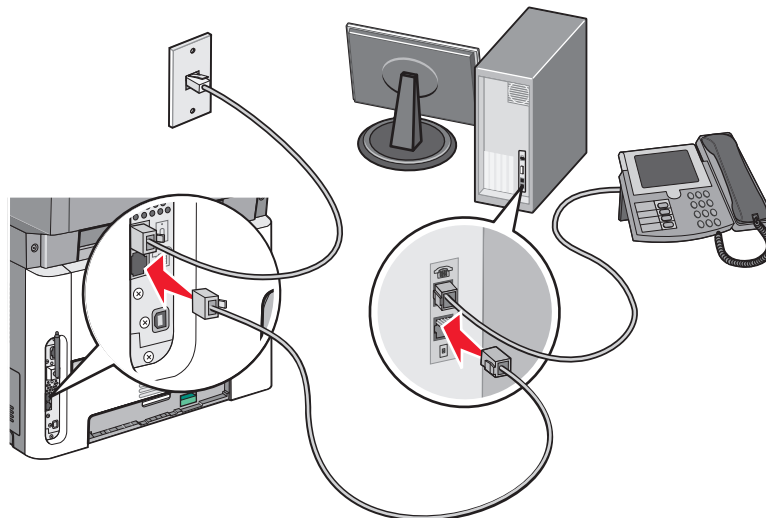

Setting the outgoing fax name and number

To have the designated fax name and fax number printed on outgoing faxes:

- 1 Type the printer IP address into the address field of your Web browser.

Note: If you do not know the IP address of the printer, then print a network setup page and locate the address in the TCP/IP section.

- 2 Click **Settings**.
- 3 Click **Fax Settings**.
- 4 Click **Analog Fax Setup**.
- 5 Click inside the Station Name box, and then enter the name to be printed on all outgoing faxes.
- 6 Click inside the Station Number box, and then enter the printer fax number.
- 7 Click **Submit**.

Setting the date and time

If the date or time that is printed on a fax job is incorrect, then you can reset the date and time. Then the correct date and time will be printed on every fax job. To set the date and time:

- 1 Type the printer IP address into the address field of your Web browser.

Note: If you do not know the IP address of the printer, then print a network setup page and locate the address in the TCP/IP section.

- 2 Click **Settings**.
- 3 Click **Security**.
- 4 Click **Set Date and Time**.

5 In the Network Time Protocol section, select **Enable NTP**.

Note: If you prefer to set the date and time manually, click inside the Manually Set Date & Time box, and then enter the current date and time.

6 Verify that the time zone is correct.

7 Click **Submit**.

Turning daylight saving time on or off

The printer can be set to automatically adjust for daylight saving time for certain time zones:

1 Type the printer IP address into the address field of your Web browser.

Note: If you do not know the IP address of the printer, then print a network setup page and locate the address in the TCP/IP section.

2 Click **Settings**.

3 Click **Security**.

4 Click **Set Date and Time**.

5 Select **Automatically Observe DST**.

6 Click **Submit**.

Sending a fax

Sending a fax using the printer control panel

1 Load an original document faceup, short edge first into the ADF or facedown on the scanner glass.



Note: Do not load postcards, photos, small items, transparencies, photo paper, or thin media (such as magazine clippings) into the ADF. Place these items on the scanner glass.

2 If you are loading a document into the ADF, then adjust the paper guides.

3 From the printer control panel, press the **Fax** button.

4 Enter the fax number, and then press .

Notes:

- To cause a two- or three-second pause in a fax number, press the **Redial/Pause** button. The dial pause appears as a comma on the "Fax to" line. Use this feature if you need to dial an outside line first.
- Press  to move the cursor to the left and delete a number.
- To use a fax shortcut, press , and then press the arrow buttons until the fax shortcut you want appears. Press .

5 Press **1** to enter another fax number, or press **2** to end fax number entry.

6 Press .

Getting ready to send a fax using the computer

For Windows users

- 1 Verify that the PostScript driver is installed.
- 2 Verify that the fax option is installed in the printer driver.
- 3 From the Print dialog Fax screen, type the name and number of the fax recipient.

For Mac OS X version 10.2 and 10.3 users

- 1 With a document open, choose **File > Print**.
- 2 From the print options pop-up menu, choose **Job Routing**.
- 3 Select **Fax**, and then enter the recipient name, number, and other information as needed.
- 4 Click **Print**.

For Mac OS X version 10.4 or later users

- 1 With a document open, choose **File > Print**.
- 2 From the PDF pop-up menu, choose **Fax PDF**.
- 3 Type the fax number in the To field, and enter other information as needed.
- 4 Click **Fax**.

If you receive an error, "No fax modems were found", follow these directions to add your printer as a fax:

- a From the Printer pop-up menu, choose **Add Printer**.
- b Select the printer from the dialog that appears.
- c From the Print Using pop-up menu, choose **Select a driver to use**.
- d From the list, choose your printer fax model, and then click **Add**.

Installing a PostScript driver

A PostScript printer driver is software that lets the computer communicate with the printer. A PostScript driver is needed to send a fax from a computer. This driver may be installed during the initial printer setup. If you need to install the software after setup, follow these instructions:

For Windows users

- 1 Close all open software programs.
- 2 Insert the *Software and Documentation* CD.
Note: If you cannot locate the *Software and Documentation* CD, you can download the driver from the Lexmark Web site at www.lexmark.com. See "Using the World Wide Web" on page 95.
- 3 From the main installation dialog, click **Install Printer and Software**.
- 4 Click **Agree** to accept the licensing agreement.
- 5 From the Drivers and Utilities dialog, select **Custom**, and then click **Next**.
- 6 Choose **Select Components**, and then click **Next**.

- 7 From the “Select your printer from the list” area, choose your printer model with the letters “PS” in the Print Emulation column.
- 8 Click **Add Printer**.
- 9 Click **Finish**, and then follow the instructions on the screen.

Using the World Wide Web

- 1 Go to the Lexmark Web site at **www.lexmark.com**.
- 2 From the Drivers & Downloads menu, click **Driver Finder**.
- 3 Select your printer, select your operating system, and then select the PostScript driver.
- 4 Download the driver and install the printer software.
- 5 Click **Agree** to accept the licensing agreement.
- 6 From the Drivers and Utilities dialog, select **Custom**, and then click **Next**.
- 7 Choose **Select Components**, and then click **Next**.
- 8 From the “Select your printer from the list” area, choose your printer model with the letters “PS” in the Print Emulation column.
- 9 Click **Add Printer**.
- 10 Click **Finish**, and then follow the instructions on the screen.

Sending a fax using the computer

Faxing from a computer lets you send electronic documents without leaving your desk. This gives you the flexibility of faxing documents directly from software programs.

For Windows users

Notes:

- In order to perform this function from your computer, you must use the PostScript printer driver for your printer.
- Verify that the fax option is installed in the printer driver.

- 1 With a file open, click **File > Print**.
- 2 Click **Properties, Preferences, Options, or Setup**.
- 3 Click the **Other Options** tab, and then click **Fax**.
- 4 On the Fax screen, type the name and number of the fax recipient.
- 5 Click **OK**, and then click **OK** again.
- 6 Click **OK**.

For Mac OS X version 10.2 and 10.3 users

- 1 With a document open, choose **File > Print**.
- 2 From the print options pop-up menu, choose **Job Routing**.

- 3 Select **Fax**, and then enter the recipient name, number, and other information as needed.
- 4 Click **Print**.

For Mac OS X version 10.4 or later users

- 1 With a document open, choose **File > Print**.
- 2 From the PDF pop-up menu, choose **Fax PDF**.
- 3 Type the fax number in the To field, and enter other information as needed.
- 4 Click **Fax**.

If you receive an error, "No fax modems were found", follow these directions to add your printer as a fax:

- a From the Printer pop-up menu, choose **Add Printer**.
- b Select the printer from the dialog that appears.
- c From the Print Using pop-up menu, choose **Select a driver to use**.
- d From the list, choose your printer fax model, and then click **Add**.

Creating shortcuts

Creating a fax destination shortcut using the Embedded Web Server

Instead of entering the entire phone number of a fax recipient on the printer control panel each time you want to send a fax, you can create a permanent fax destination and assign a shortcut number. A shortcut can be created to a single fax number or a group of fax numbers.

- 1 Type the printer IP address into the address field of your Web browser.

Note: If you do not know the IP address of the printer, then print a network setup page and locate the IP address in the TCP/IP section.

- 2 Click **Settings**.
- 3 Click **Manage Shortcuts**.







Note: A password may be required. If you do not have an ID and password, get one from your system support person.

- 4 Click **Fax Shortcut Setup**.
- 5 Type a unique name for the shortcut, and then enter the fax number.
To create a multiple-number shortcut, enter the fax numbers for the group.

Note: Separate each fax number in the group with a semicolon (;).

- 6 Assign a shortcut number.
If you enter a number that is already in use, then you are prompted to select another number.
- 7 Click **Add**.



Creating a fax destination shortcut using the printer control panel

- 1 Load an original document faceup, short edge first into the ADF or facedown on the scanner glass.
Note: Do not load postcards, photos, small items, transparencies, photo paper, or thin media (such as magazine clippings) into the ADF. Place these items on the scanner glass.
- 2 If you are loading a document into the ADF, then adjust the paper guides.
- 3 From the printer control panel, press the **Fax** button.
To: appears on the first line, and the time and date appear on the second line.
- 4 Press .
Address Book Search appears.
- 5 Press the arrow buttons until **Add** appears, and then press .
- 6 Press the arrow buttons until **Enter Fax Number** appears, and then press .
- 7 Enter the fax number, and then press .
- 8 Press **1** to enter another fax number, or press **2** to end fax number entry.
- 9 After selecting **2=NO**, **Enter Name** appears.
 - a Press the button on the keypad that corresponds with the letter you want. The first time you press the button, the number for that button appears. When you press the button again, one of the letters assigned to that button appears.
 - b Press the right arrow button to move to the next space, or wait a few seconds and the cursor will move to the next space.
 - c Once the fax name is entered, press .
 - Save as Shortcut** appears.
 - d Enter the shortcut number, and then press .

Using shortcuts and the address book



Using fax shortcuts

Fax shortcuts are just like the speed dial numbers on a telephone or fax machine. You can assign shortcut numbers when creating permanent fax destinations. You create permanent fax destinations or speed dial numbers in the Manage Shortcuts link located under Settings on the Embedded Web Server. A shortcut number (1–99999) can contain a single recipient or multiple recipients. By making a group fax destination with a shortcut number, you can easily fax broadcast information to an entire group.

- 1 Load an original document faceup, short edge first into the ADF or facedown on the scanner glass.
Note: Do not place postcards, photos, small items, transparencies, photo paper, or thin media (such as magazine clippings) into the ADF. Place these items on the scanner glass.
- 2 If you are loading a document into the ADF, then adjust the paper guides.
- 3 Press , and then enter the shortcut number.
- 4 Press .

Using the address book



Note: If the address book feature is not enabled, contact your system support person.

- 1 Load an original document faceup, short edge first into the ADF or facedown on the scanner glass.
Note: Do not load postcards, photos, small items, transparencies, photo paper, or thin media (such as magazine clippings) into the ADF. Place these items on the scanner glass.
- 2 If you are loading a document into the ADF, then adjust the paper guides.
- 3 From the printer control panel, press the **Fax** button.
To: appears on the first line, and the time and date appear on the second line.
- 4 Press , and then press the arrow buttons until the fax number you want appears. Then, press .

Customizing fax settings

Changing the fax resolution

Adjusting the resolution setting changes the quality of the fax. Settings range from Standard (fastest speed) to Ultra Fine (slowest speed, best quality).



- 1 Load an original document faceup, short edge first into the ADF or facedown on the scanner glass.
Note: Do not load postcards, photos, small items, transparencies, photo paper, or thin media (such as magazine clippings) into the ADF. Place these items on the scanner glass.
- 2 If you are loading a document into the ADF, then adjust the paper guides.
- 3 From the Fax area of the printer control panel, press the **Resolution** button.
- 4 Press the arrow buttons until the resolution value you want appears, and then press .
- 5 Press .

Printing incoming faxes on both sides of the paper (duplexing)





- 1 From the printer control panel, press the **Fax** button.
 - 2 Press the **Duplex/2-Sided** button.
 - 3 Press the arrow buttons to select a duplex option, and then press .
- The first number represents sides of the original documents; the second number represents sides of the copy. For example, select **1 To 2 Sided** if you have 1-sided original documents and you want 2-sided copies.

Making a fax lighter or darker

- 1 Load an original document faceup, short edge first into the ADF or facedown on the scanner glass.
Note: Do not load postcards, photos, small items, transparencies, photo paper, or thin media (such as magazine clippings) into the ADF. Place these items on the scanner glass.
- 2 If you are loading a document into the ADF, then adjust the paper guides.

- 3 From the printer control panel, press the **Darkness** button.
- 4 Press the arrow buttons to make the fax lighter or darker.
- 5 Press .
- 6 Press .

Sending a fax at a scheduled time

- 1 Load an original document faceup, short edge first into the ADF or facedown on the scanner glass.
Note: Do not load postcards, photos, small items, transparencies, photo paper, or thin media (such as magazine clippings) into the ADF. Place these items on the scanner glass.
- 2 If you are loading a document into the ADF, then adjust the paper guides.
- 3 From the printer control panel, press the **Fax** button.
- 4 Enter the fax number, and then press .
- 5 From the Fax area, press the **Options** button.
- 6 Press the arrow buttons until **Delayed Send** appears, and then press 
Set Send Time appears.
- 7 Using the keypad, enter the time you want to send the fax.
If the printer clock is set to 12 Hour format, then use the arrow buttons to select **AM** or **PM**.
- 8 Press 
Set Send Date appears.
- 9 Using the keypad, enter the date you want to send the fax, and then press .
- 10 Press .

Forwarding a fax

This option lets you print and forward received faxes to a fax number.

- 1 Type the printer IP address into the address field of your Web browser.
Note: If you do not know the IP address of the printer, then print a network setup page and locate the address in the TCP/IP section.
- 2 Click **Settings**.
- 3 Click **Fax Settings**.
- 4 Click **Analog Fax Setup**.
- 5 Click inside the **Fax Forwarding** box, and then select one of the following:
 - Print
 - Print and Forward
 - Forward
- 6 From the **Forward to** list, select **Fax**.

- 7 Click inside the **Forward to Shortcut** box, and then enter the shortcut number where you want the fax forwarded.
Note: The shortcut number must be a valid shortcut number for the setting that was selected in the “Forward to” box.
- 8 Click **Submit**.

Viewing a fax log

- 1 Type the printer IP address into the address field of your Web browser.
Note: If you do not know the IP address of the printer, then print a network setup page and locate the IP address in the TCP/IP section.
- 2 Click **Settings**.
- 3 Click **Reports**.
- 4 Click **Fax Job Log** or **Fax Call Log**.

Blocking junk faxes

- 1 Type the printer IP address into the address field of your Web browser.
Note: If you do not know the IP address of the printer, then print a network setup page and locate the IP address in the TCP/IP section.
- 2 Click **Settings**.
- 3 Click **Fax Settings**.
- 4 Click **Analog Fax Setup**.
- 5 Click the **Block No Name Fax** option.
This option blocks all incoming faxes that have a private caller ID or no fax station name.
- 6 In the Banned Fax List field, enter the phone numbers or fax station names of specific fax callers you want to block.

Canceling an outgoing fax

A fax can be canceled when the document is in the ADF or on the scanner glass. To cancel a fax:



- 1 From the printer control panel, press **X**.
Stopping appears, and then **Cancel Job** appears.
- 2 Press **X** to cancel the job.
Note: If you want to continue to process the job, press  to resume scanning the fax.
Canceling appears.

The printer clears all pages in the ADF and then cancels the job.

Understanding fax options

Original Size

This option lets you choose the size of the documents you are going to fax.

- 1 From the Fax area of the printer control panel, press the **Options** button.
Original Size appears.
- 2 Press .
- 3 Press the arrow buttons until the size of the original document appears, and then press .

Content

This option tells the printer the original document type. Choose from Text, Text/Photo, or Photo. Content affects the quality and size of your scan.

- **Text**—Emphasizes sharp, black, high-resolution text against a clean, white background
- **Text/Photo**—Used when the original documents are a mixture of text and graphics or pictures
- **Photograph**—Tells the scanner to pay extra attention to graphics and pictures. This setting increases the time it takes to scan, but emphasizes a reproduction of the full dynamic range of tones in the original document. This increases the amount of information saved.

Sides (Duplex)

This option informs the printer if the original document is simplex (printed on one side) or duplex (printed on both sides). This lets the scanner know what needs to be scanned for inclusion in the fax.

Note: Duplex scanning is not available on selected printer models.

Resolution

This option increases how closely the scanner examines the document you want to fax. If you are faxing a photo, a drawing with fine lines, or a document with very small text, increase the Resolution setting. This will increase the amount of time required for the scan and will increase the quality of the fax output.

- **Standard**—Suitable for most documents
- **Fine**—Recommended for documents with small print
- **Super fine**—Recommended for original documents with fine detail

Darkness

This option adjusts how light or dark your faxes will turn out in relation to the original document.

Improving fax quality

Question	Tip
When should I use Text mode?	<ul style="list-style-type: none">• Use Text mode when text preservation is the main goal of the fax, and preserving images copied from the original document is not a concern.• Text mode is recommended for faxing receipts, carbon copy forms, and documents that contain only text or fine line art.
When should I use Text/Photo mode?	<ul style="list-style-type: none">• Use Text/Photo mode when faxing an original document that contains a mixture of text and graphics.• Text/Photo mode is recommended for magazine articles, business graphics, and brochures.• Use Text/Photo mode when faxing photos printed on a laser printer or taken from a magazine or newspaper.
When should I use Photo mode?	Use Photo mode when faxing high quality original photographs.

Scanning to a computer or flash drive

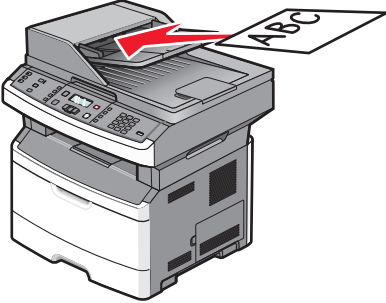
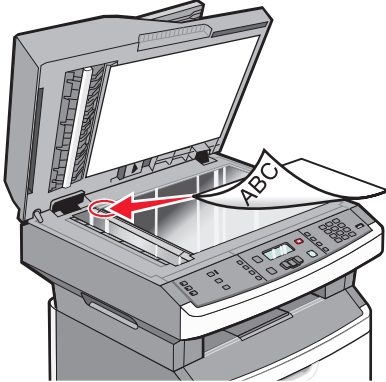
ADF	Scanner glass
 <p data-bbox="151 806 613 835">Use the ADF for multiple-page documents.</p>	 <p data-bbox="630 806 1409 896">Use the scanner glass for single pages, small items (such as postcards or photos), transparencies, photo paper, or thin media (such as magazine clippings).</p>

You can scan documents directly to a computer or a flash drive. The computer does not have to be directly connected to the printer for you to receive Scan to PC images. You can scan the document back to the computer over the network by creating a scan profile on the computer and then downloading the profile to the printer.

Scanning to a computer

- 1 Type the printer IP address into the address field of your Web browser.

Note: If you do not know the IP address of the printer, then print a network setup page and locate the address in the TCP/IP section.

- 2 Click **Scan Profile**.

Note: In order to use the Scan Profile function, you must have Java installed on your computer.

- 3 Click **Create**.

- 4 Select your scan settings, and then click **Next**.

- 5 Select a location on your computer where you want to save the scanned output file.

- 6 Enter a profile name.

The profile name is the name that appears in the Scan Profile list on the display.

- 7 Click **Submit**.

- 8 Scan your document.

A shortcut number was automatically assigned when you clicked Submit. Remember this shortcut number and use it when you are ready to scan your documents.

- a** Load an original document faceup, short edge first into the ADF or facedown on the scanner glass.

Note: Do not load postcards, photos, small items, transparencies, photo paper, or thin media (such as magazine clippings) into the ADF. Place these items on the scanner glass.

- b** If you are loading a document into the ADF, then adjust the paper guides.

- c** Press the **Scan/Email** button.

- d** Press the arrow buttons until **Profiles** appears, and then press .

- e** Press , and then enter the shortcut number.

- f** Press .

- 9** Return to the computer to view the file.

The output file is saved in the location you specified or launched in the program you specified.

Scanning to a flash drive

Note: The USB port is not available on selected printer models.

- 1** Insert a flash drive into the front USB port.

Access USB appears.

Note: When a flash drive is inserted into the printer, the printer can only scan to the flash drive or print files from the flash drive. No other printer functions are available.

- 2** Press **1** on the keypad.

- 3** Press the arrow buttons until **Scan to USB** appears, and then press .

Press Start To Begin appears.

- 4** Load an original document faceup, short edge first into the ADF or facedown on the scanner glass.

Note: Do not load postcards, photos, small items, transparencies, photo paper, or thin media (such as magazine clippings) into the ADF. Place these items on the scanner glass.

- 5** If you are loading a document into the ADF, then adjust the paper guides.

- 6** Press .

Understanding the Scan Center features

The Scan Center software lets you modify scan settings and select where to send the scanned output. Scan settings modified with the Scan Center software can be saved and used for other scan jobs.

The following features are available:

- Scan and send images to your computer
- Convert scanned images to text
- Preview the scanned image and adjust the brightness and contrast
- Make larger scans without losing detail
- Scan two-sided documents

Understanding scan profile options

Quick Setup

This option lets you select preset formats or customize the scan job settings. You can select one of these settings:

Custom	Photo - Color JPEG
Text - BW PDF	Photo - Color TIFF
Text - BW TIFF	Text/Photo - BW PDF Text/Photo - Color PDF

To customize the scan job settings, from the Quick Setup menu, select **Custom**. Then change the scan settings as needed.

Format Type

This option defines the format (PDF, JPEG, or TIFF) for the scanned image.

- **PDF**—Creates a single file with multiple pages, viewable with Adobe Reader. Adobe Reader is provided free by Adobe at www.adobe.com.
- **JPEG**—Creates and attaches a separate file for each page of your original document, viewable by most Web browsers and graphics programs
- **TIFF**—Creates multiple files or a single file. If Multi-page TIFF is turned off in the Settings menu of the Embedded Web Server, then TIFF saves one page in each file. The file size is usually larger than an equivalent JPEG.

Compression

This option sets the format used to compress the scanned output file.

Default Content

This option tells the printer the original document type. Choose from Text, Text/Photo, or Photo. Default Content affects the quality and size of your scanned file.

Text—Emphasizes sharp, black, high-resolution text against a clean, white background

Text/Photo—Used when the original documents are a mixture of text and graphics or pictures

Photo—Tells the scanner to pay extra attention to graphics and pictures. This setting increases the time it takes to scan, but emphasizes a reproduction of the full dynamic range of tones in the original document. This increases the amount of information saved.

Color

This option tells the printer the color of the original documents. You can select Gray, BW (Black and White), or Color.

JPEG Quality

This option adjusts the degree of compression for scanned JPEG documents in relation to the original document.

Darkness

This option adjusts how light or dark your scanned documents will turn out in relation to the original document.

Resolution

This option adjusts the output quality of your file. Increasing the image resolution increases the file size and the time needed to scan your original document. Image resolution can be decreased to reduce the file size.

Original Size

This option sets the size of the documents you are going to scan. When Original Size is set to Mixed Sizes, you can scan an original document that contains mixed paper sizes (letter- and legal-size pages).

Orientation

This option tells the printer whether the original document is in portrait or landscape orientation and then changes the Sides and Binding settings to match the original document orientation.

Duplex

This option informs the printer if your original document is printed on a single side or duplex (printed on both sides). This lets the scanner know what needs to be scanned for inclusion in the document.

Note: Duplex scanning is not available on selected printer models.

Advanced Imaging

This option lets you adjust Background Removal, Contrast, Shadow Detail, and Sharpness before you scan the document. It also lets you Scan edge to edge.

- **Background Removal**—Adjusts the white portion of the output. Click the arrow buttons to increase or decrease the white portion.
- **Contrast**—Click the arrow buttons to increase or decrease the contrast.
- **Shadow Detail**—Click the arrow buttons to increase or decrease the visible detail in the shadows.
- **Sharpness**—Click the arrow buttons to increase or decrease the sharpness.
- **Scan edge to edge**—Select this check box to scan edge to edge.

Improving scan quality

Question	Tip
When should I use Text mode?	<ul style="list-style-type: none"> • Use Text mode when text preservation is the main goal of the scan, and preserving images copied from the original document is not a concern. • Text mode is recommended for receipts, carbon copy forms, and documents that only contain text or fine line art.

Question	Tip
When should I use Text/Photo mode?	<ul style="list-style-type: none">• Use Text/Photo mode when scanning an original document that contains a mixture of text and graphics.• Text/Photo mode is recommended for magazine articles, business graphics, and brochures.
When should I use Photo mode?	Use Photo mode when scanning photos printed on a laser printer or taken from a magazine or newspaper.

Understanding printer menus

Menus list

A number of menus are available to make it easy for you to change printer settings.

Note: Certain menus are not available on selected printer models.

Paper Menu	Reports	Network/Ports	Settings
Default Source	Menu Settings Page	Active NIC	General Settings
Size/Type	Device Statistics	Network Menu	Copy Settings
Configure MP	Network Setup Page	Network Reports Menu	Fax Settings
Paper Texture	Shortcut List	Network Card Menu	Flash Drive Menu
Paper Weight	Fax Job Log	TCP/IP Menu	Print Settings
Paper Loading	Fax Call Log	IPv6 Menu	Set Date/Time
Custom Types	E-mail Shortcuts	Wireless Menu	
Universal Setup	Fax Shortcuts	AppleTalk Menu	
Custom Scan Sizes	Profiles List	USB Menu	
	Print Fonts		
	Print Directory		
	Print Demo		
	Asset Report		

Paper menu

Default Source menu

Menu item	Description
Default Source Tray <x> MP Feeder Manual Paper Manual Env	Sets a default paper source for all print jobs Notes: <ul style="list-style-type: none"> • From the Paper menu, Configure MP must be set to Cassette in order for MP Feeder to appear as a menu setting. • Tray 1 (standard tray) is the factory default setting. • Only an installed paper source will appear as a menu setting. • A paper source selected by a print job will override the Default Source setting for the duration of the print job. • If the same size and type of paper are in two trays and the Paper Size and Paper Type settings match, the trays are automatically linked. When one tray is empty, the job prints using the linked tray.

Size/Type menu

Menu item	Description
Select Source menu Tray 1 Tray 2 MP Feeder Manual Paper Manual Env	Notes: <ul style="list-style-type: none"> • These menus let you specify the installed paper size and type in the selected tray or manual feeder. • Only installed trays and feeders are listed in this menu.
Set Size menu for Tray 1 or Tray 2 A4 A5 A6 JIS B5 Executive Folio Legal Letter Oficio (Mexico) Statement Universal	Lets you specify the paper size loaded in each tray Notes: <ul style="list-style-type: none"> • Letter is the US factory default setting. A4 is the international factory default setting. • If the same size and type of paper are in two trays and the Paper Size and Paper Type settings match, then the trays are automatically linked. When one tray is empty, the job prints using paper from the linked tray. • The A6 paper size is supported only in Tray 1.
Set Size menu for Manual Paper A4 A5 Executive Folio JIS B5 Legal Letter Oficio (Mexico) Statement Universal	Lets you specify the size of the paper being loaded in the manual feeder Note: Letter is the US factory default setting. A4 is the international factory default setting.
Set Size menu for Manual Env 7 3/4 Envelope 9 Envelope 10 Envelope C5 Envelope B5 Envelope DL Envelope Other Envelope	Lets you specify the size of the envelope being manually loaded Note: 10 Envelope is the US factory default setting. DL Envelope is the international factory default setting.

Menu item	Description
<p>Set Type menu for Tray 1</p> <ul style="list-style-type: none"> Plain Paper Card Stock Transparency Recycled Labels Bond Letterhead Preprinted Colored Paper Light Paper Heavy Paper Rough/Cotton Custom Type <x> 	<p>Lets you specify the type of paper loaded in Tray 1</p> <p>Notes:</p> <ul style="list-style-type: none"> • Plain Paper is the factory default setting for Tray 1. • If available, a user-defined name will appear instead of Custom Type <x>. • Use this menu item to configure automatic tray linking.
<p>Set Type menu for Tray 2</p> <ul style="list-style-type: none"> Plain Paper Card Stock Recycled Labels Bond Letterhead Preprinted Colored Paper Light Paper Heavy Paper Rough/Cotton Custom Type <x> 	<p>Lets you specify the type of paper loaded in Tray 2</p> <p>Notes:</p> <ul style="list-style-type: none"> • Custom Type <x> is the factory default setting. • If available, a user-defined name will appear instead of Custom Type <x>. • Use this menu item to configure automatic tray linking.
<p>Set Type menu for Manual Paper</p> <ul style="list-style-type: none"> Plain Paper Card Stock Transparency Labels Bond Letterhead Preprinted Colored Paper Light Paper Heavy Paper Rough/Cotton Custom Type <x> 	<p>Lets you specify the type of paper being manually loaded</p> <p>Note: Plain Paper is the factory default setting.</p>
<p>Set Type menu for Manual Env</p> <ul style="list-style-type: none"> Envelope Custom Type <x> 	<p>Lets you specify the type of envelope being manually loaded</p> <p>Note: Envelope is the factory default setting.</p>

Configure MP menu

This menu is available only on printer models equipped with multipurpose feeders.

Menu item	Description
Configure MP Cassette Manual	Determines when the printer selects paper from the multipurpose feeder Notes: <ul style="list-style-type: none"> • Cassette is the factory default setting. • The Cassette setting configures the multipurpose feeder as an automatic paper source. • When Manual is selected, the multipurpose feeder can be used only for manual feed print jobs.

Paper Texture menu

In the Paper Texture menu, the Select Type and Select Texture features work together to enable you to select the texture for a specific type of paper.

Menu item	Description
Select Type Plain Texture Card Stock Texture Transparency Texture Recycled Texture Labels Texture Bond Texture Envelope Texture Rough Envelope Texture Letterhead Texture Preprinted Texture Colored Texture Light Texture Heavy Texture Rough/Cotton Texture Custom <x> Texture	Specifies the paper type
Select Texture Smooth Normal Rough	After you select a setting for Select Type, the Select Texture feature lets you set the texture for that type of media. Notes: <ul style="list-style-type: none"> • Normal is the factory default setting for most items. • Rough is the factory default setting for Bond. • When Rough Texture is the setting selected for Select Type, Rough is the only Select Texture setting available. • Settings appear only if the paper is supported.

Paper Weight menu

In the Paper Weight menu, the Select Type and Select Weight features work together to enable you to select the weight for a specific type of paper.

Menu item	Description
Select Type Plain Weight Card Stock Weight Transparency Weight Recycled Weight Labels Weight Bond Weight Envelope Weight Rough Envelope Weight Letterhead Weight Preprinted Weight Colored Weight Light Weight Heavy Weight Rough/Cotton Weight Custom <x> Texture	Specifies the paper type
Select Weight Light Normal Heavy	After you select a setting for Select Type, the Select Weight feature lets you set the weight for that type of media. Notes: <ul style="list-style-type: none"> • Normal is the factory default setting for most items. • When Light Weight is the setting selected for Select Type, Light is the only Select Weight setting available. • When Heavy Weight is the setting selected for Select Type, Heavy is the only Select Weight setting available. • Settings appear only if the paper is supported.

Paper Loading menu

Menu item	Description
Select Type Recycled Loading Bond Loading Letterhead loading Preprinted Loading Colored Loading Light Loading Heavy Loading Custom Loading	Specifies the paper type Note: After you select the type of paper, the Set Loading menu appears.

Menu item	Description
Set Loading <ul style="list-style-type: none"> • Duplex • Off 	Specifies whether duplex (2-sided) printing is turned on Note: Off is the factory default setting.

Custom Types menu

Menu item	Description
Custom Type <x> Paper Card Stock Transparency Rough/Cotton Labels Envelope	Name a Custom Type <x> , and this user-defined name displays instead of Custom Type <x> . Notes: <ul style="list-style-type: none"> • The Custom Name must be limited to 16 characters. • Paper is the factory default setting for the Custom Type. • The custom media type must be supported by the selected tray or feeder in order for you to print from that source.
Recycled Paper Card Stock Transparency Rough/Cotton Labels Envelope	Assign a paper type for the Recycled paper type loaded, and it will also be the Recycled paper type in other menus. Notes: <ul style="list-style-type: none"> • Paper is the factory default setting. • The Recycled type must be supported by the selected tray or feeder in order for you to print from that source.

Custom Scan Sizes menu

Menu item	Description
Custom Scan Size <x> Width 1–8.50 inches (25–216 mm) Height 1–14 inches (25–356 mm) Orientation Portrait Landscape 2 scans/side Off On	<p>Specifies a custom scan size name and options. This name replaces a Custom Scan Size <x> name in the printer menus. <x> can be either 1 or 2.</p> <p>Notes:</p> <ul style="list-style-type: none"> • The panel displays “ID Card” in place of “Custom Scan Size 1” unless you have named it differently. • 4.65 inches is the US factory default setting for Width for Size 1. 118 millimeters is the international factory default setting for Width for Size 1. • 8.5 inches is the US factory default setting for Width for Size 2. 216 millimeters is the international factory default setting for Width for Size 2. • 6 inches is the US factory default setting for Height for Size 1. 154 millimeters is the international factory default setting for Height for Size 1. • 14 inches is the US factory default setting for Height for Size 2. 356 millimeters is the international factory default setting for Height for Size 2. • Landscape is the factory default setting for Orientation. • Off is the factory default setting for 2 scans/side for Size 2. • On is the factory default setting for 2 scans/side for Size 1.

Universal Setup menu

These menu items are used to specify the height, width, and feed direction of the Universal Paper Size. The Universal Paper Size is a user-defined paper size. It is listed with the other paper size settings and includes similar options, such as support for duplex printing and printing multiple pages on one sheet.

Menu item	Description
Units of Measure Inches Millimeters	<p>Identifies the units of measure</p> <p>Notes:</p> <ul style="list-style-type: none"> • Inches is the US factory default setting. • Millimeters is the international factory default setting.
Portrait Width 3–14.17 inches 76–360 mm	<p>Sets the portrait width</p> <p>Notes:</p> <ul style="list-style-type: none"> • If the width exceeds the maximum, then the printer uses the maximum width allowed. • 8.5 inches is the US factory default setting. Inches can be increased in 0.01-inch increments. • 216 mm is the international factory default setting. Millimeters can be increased in 1-mm increments.

Menu item	Description
Portrait Height 3–14.17 inches 76–360 mm	Sets the portrait height Notes: <ul style="list-style-type: none"> • If the height exceeds the maximum, then the printer uses the maximum height allowed. • 14 inches is the US factory default setting. Inches can be increased in 0.01-inch increments. • 356 mm is the international factory default setting. Millimeters can be increased in 1-mm increments.
Feed Direction Short Edge Long Edge	Specifies the feed direction Notes: <ul style="list-style-type: none"> • Short Edge is the factory default setting. • Long Edge appears only if the longest edge is shorter than the maximum length supported in the tray.

Reports menu

Reports menu

Note: When you select a menu item from the Reports menu, the indicated report prints.

Menu item	Description
Menu Settings Page	Prints a report containing information about paper loaded into trays, installed memory, the total page count, alarms, timeouts, the printer control panel language, the TCP/IP address, the status of supplies, the status of the network connection, and other information
Device Statistics	Prints a report containing printer statistics such as supply information and details about printed pages
Network Setup Page	Prints a report containing information about the network printer settings, such as the TCP/IP address information Note: This menu item appears only for network printers or printers connected to print servers.
Shortcut List	Prints a report containing information about configured shortcuts
Fax Job Log	Prints a report containing information about the last 200 completed faxes
Fax Call Log	Prints a report containing information about the last 100 attempted, received, and blocked calls
E-mail Shortcuts	Prints a report containing information about e-mail shortcuts
Fax Shortcuts	Prints a report containing information about fax shortcuts
Profiles List	Prints a list of profiles stored in the printer
Print Fonts	Prints a report of all the fonts available for the printer language currently set in the printer

Menu item	Description
Print Directory	Displays the resources stored in the user's flash option. This feature appears only if there is an installed/mounted flash device.
Asset Report	Prints a report containing asset information including the printer serial number and model name. The report contains text and UPC barcodes that can be scanned into an asset database.

Network/Ports menu

Active NIC menu

Menu item	Description
Active NIC Auto <list of available network cards>	Notes: <ul style="list-style-type: none"> • Auto is the factory default setting. • This menu item appears only if an optional network card is installed.

Network menu

Menu item	Description
PCL SmartSwitch On Off	Sets the printer to automatically switch to PCL emulation when a print job requires it, regardless of the default printer language Notes: <ul style="list-style-type: none"> • On is the factory default setting. • When the Off setting is used, the printer does not examine incoming data. • When the Off setting is used, the printer uses PostScript emulation if PS SmartSwitch is set to On. It uses the default printer language specified in the Setup menu if PS SmartSwitch is set to Off.
PS SmartSwitch On Off	Sets the printer to automatically switch to PS emulation when a print job requires it, regardless of the default printer language Notes: <ul style="list-style-type: none"> • On is the factory default setting. • When the Off setting is used, the printer does not examine incoming data. • When the Off setting is used, the printer uses PCL emulation if PCL SmartSwitch is set to On. It uses the default printer language specified in the Setup menu if PCL SmartSwitch is set to Off.

Menu item	Description
NPA Mode Off Auto	Sets the printer to perform the special processing required for bidirectional communication following the conventions defined by the NPA protocol Notes: <ul style="list-style-type: none"> • Auto is the factory default setting • Changing this setting from the printer control panel and then exiting the menus causes the printer to restart. The menu selection is updated.
Network Buffer Disabled Auto	Sets the size of the network input buffer Notes: <ul style="list-style-type: none"> • Auto is the factory default setting. • The value can be changed in 1-K increments. • The maximum size allowed depends on the amount of memory in the printer, the size of the other link buffers, and whether Resource Save is set to On or Off. • To increase the maximum size range for the Network Buffer, disable or reduce the size of the USB buffer. • Changing this setting from the printer control panel and then exiting the menus causes the printer to restart. The menu selection is updated.
Mac Binary PS On Off Auto	Sets the printer to process Macintosh binary PostScript print jobs Notes: <ul style="list-style-type: none"> • Auto is the factory default setting. • The Off setting filters print jobs using the standard protocol. • The On setting processes raw binary PostScript print jobs.
Network Setup Reports Menu Network Card menu TCIP Menu IPv6 Menu Wireless menu AppleTalk menu	Lists all the network setup menus, regardless of the active network of the printer Note: Certain options are not available on selected printer models.

Network Reports menu

This menu is available from the Network/Ports menu:

Network/Ports > Standard Network or Network <x> > Std Network Setup or Net <x> Setup > Reports or Network Reports

Menu item	Description
Print Setup Page	Prints a report containing information about the current network setup Note: The Print Setup Page contains information about the network printer settings, such as the TCP/IP address.

Network Card menu

Menu item	Description
View Card Status Connected Disconnected	Allows you to ascertain whether the Network Card is connected.
View Card Speed	Reflects the speed of a currently active network card.
View Network Address UAA LAA	Both addresses are represented by 12-digit hexadecimal numbers.
Job Timeout 0-225 seconds	Sets the amount of time in seconds that a network print job can take before it is canceled. Notes: <ul style="list-style-type: none"> • 90 seconds is the factory default setting. • A setting value of 0 disables the timeout. • If a value of 1–9 is selected, the setting is saved as 10.
Banner Page On Off	Allows the printer to print a banner page. Note: Off is the factory default setting.

TCP/IP menu

Use the following menu items to view or set the TCP/IP information.

Note: This menu is available only for network models or printers attached to print servers.

Menu item	Description
TCP/IP Activate On Off	Specifies whether to activate TCP/IP Note: On is the factory default setting.
TCP/IP View Hostname	Shows the current TCP/IP hostname
TCP/IP IP Address Netmask Gateway	Lets you view or change the current TCP/IP Address, Netmask, and Gateway information Note: Each requires four fields.

Menu item	Description
TCP/IP Enable DHCP Enable AutoIP Enable FTP/TFTP Enable HTTP Server Yes No	Lets you view or change the settings Note: Yes is the factory default setting for each.
TCP/IP WINS Server Address	Lets you view or change the setting Note: This is a four-field IP address.
TCP/IP Enable DDNS Enable mDNS	Lets you view or change the settings Note: Yes is the factory default setting for both.
TCP/IP DNS Server Address	Lets you view or change the setting Note: This is a four-field IP address.

IPv6 menu

Use the following menu items to view or set the Internet Protocol version 6 (IPv6) information.

Note: This menu is available only for network models or printers attached to print servers.

This menu is available from the Network/Ports menu:

Network/Ports > Standard Network or Network <x> > Std Network Setup or Net <x> Setup > IPv6

Menu item	Description
Enable IPv6 On Off	Enables IPv6 in the printer Note: On is the factory default setting.
Auto Configuration On Off	Specifies whether the network adapter accepts the automatic IPv6 address configuration entries provided by a router Note: On is the factory default setting.
View Hostname View Address View Router Address	Lets you view the current setting Note: These settings can be changed only from the Embedded Web Server.
Enable DHCPv6 On Off	Enables DHCPv6 in the printer Note: On is the factory default setting.

Wireless menu

Use the following menu items to view or configure the wireless internal print server settings.

Note: This menu is available only for models able to be connected to a wireless network.

This menu is available from the Network/Ports menu:

Network/Ports > Network <x> > Net <x> Setup > Wireless

Menu item	Description
Network Mode Infrastructure Ad hoc	Specifies the network mode Notes: <ul style="list-style-type: none"> Infrastructure mode lets the printer access a network using an access point. Ad hoc is the factory default setting. Ad hoc mode configures the printer for wireless networking directly between it and a computer.
Compatibility 802.11n 802.11b/g 802.11b/g/n	Specifies the wireless standard for the wireless network Note: 802.11b/g/n is the factory default setting.
Choose Network <list of available networks>	Lets you select an available network for the printer to use Note: If the network you want to join is protected by a security setting, you will have to join it from the Embedded Web Server or the Wireless Setup Utility.
View Signal Quality	Lets you view the quality of the wireless connection
View Security Mode	Lets you view the encryption method for the wireless connection. "Disabled" indicates that the wireless network is not encrypted.

AppleTalk menu

Menu item	Description
Activate Yes No	Activates or deactivates AppleTalk support Note: Yes is the factory default setting.
View Name	Shows the assigned AppleTalk name
View Address	Shows the assigned AppleTalk address
Set Zone <list of zones available on the network>	Provides a list of AppleTalk zones available on the network Note: The factory default setting is the default zone for the network. If no default zone exists, the zone marked with an * is the factory default setting.

USB menu

Menu item	Description
PCL SmartSwitch On Off	Sets the printer to automatically switch to PCL emulation when a print job received through a USB port requires it, regardless of the default printer language Notes: <ul style="list-style-type: none"> • On is the factory default setting. • When the Off setting is used, the printer does not examine incoming data. • When the Off setting is used, the printer uses PostScript emulation if the PS Smartswitch setting is On. It uses the default printer language specified in the Setup menu if the PS SmartSwitch setting is Off.
PS SmartSwitch On Off	Sets the printer to automatically switch to PS emulation when a print job received through a USB port requires it, regardless of the default printer language Notes: <ul style="list-style-type: none"> • On is the factory default setting. • When the Off setting is used, the printer does not examine incoming data. • When the Off setting is used, the printer uses PCL emulation if the PCL Smartswitch setting is On. It uses the default printer language specified in the Setup menu if the PCL SmartSwitch setting is Off.
NPA Mode Off Auto	Sets the printer to perform the special processing required for bidirectional communication following the conventions defined by the NPA protocol Notes: <ul style="list-style-type: none"> • Auto is the factory default setting. • Changing this setting causes the printer to restart.
USB Buffer Disabled Auto	Sets the size of the USB input buffer Notes: <ul style="list-style-type: none"> • Auto is the factory default setting. • The Disabled setting turns off job buffering. Any jobs already buffered are printed before normal processing is resumed. • The USB buffer size value can be changed in 1-K increments. • The maximum size allowed depends on the amount of memory in the printer, the size of the other link buffers, and whether the Resource Save setting is On or Off. • Changing this setting causes the printer to restart.
Mac Binary PS On Off Auto	Sets the printer to process Macintosh binary PostScript print jobs Notes: <ul style="list-style-type: none"> • Auto is the factory default setting. • The Off setting filters print jobs using the standard protocol. • The On setting processes raw binary PostScript print jobs.

Menu item	Description
USB with ENA ENA Address ENA Netmask ENA Gateway	Sets the network address, netmask, and gateway information for an external print server that is attached to the printer using a USB cable Note: This menu item and its submenus are available only if the printer is attached to an external print server through the USB port.

Settings menu

General Settings menu

Menu item	Description
Display Language English Francais Deutsch Italiano Espanol Dansk Norsk Nederlands Svenska Portuguese Suomi Russian Polski Magyar Turkce Cesky Simplified Chinese Traditional Chinese Korean Japanese	Sets the language of the text appearing on the display Note: All languages may not be available for all printers.
Eco-Mode Off Energy Energy/Paper Paper	Minimizes the use of energy, paper, or specialty media Notes: <ul style="list-style-type: none"> • Off is the factory default setting. Off resets the printer to its factory default settings. • The Energy setting minimizes the power used by the printer. Performance may be affected but quality is not. • Paper minimizes the amount of paper and specialty media needed for a print job. Performance may be affected but quality is not. • Energy/Paper minimizes the use of power and of paper and specialty media.

Menu item	Description
Quiet Mode Off On	Reduces the amount of noise produced by the printer Notes: <ul style="list-style-type: none"> Off is the factory default setting. On configures the printer to produce as little noise as possible.
Run Initial setup Yes No	Instructs the printer to run the setup wizard Notes: <ul style="list-style-type: none"> Yes is the factory default setting. After completing the setup wizard by selecting Done at the Country select screen, the default setting becomes No.
Paper Sizes U.S. Metric	Specifies the printer factory default measurements. The default setting is determined by the country selection in the initial setup wizard.
Scan to PC Port Range <port range>	Specifies a valid port range for printers behind a port blocking firewall. The valid ports are specified by two sets of numbers separated by a semicolon. Note: 9751:12000 is the factory default setting.
Default Mode Copy Fax	Sets the function the printer enters when Go, Content, Darkness, or any number is pressed on the printer control panel Note: Copy is the factory default setting
Date Format MM-DD-YYYY DD-MM-YYYY YYYY-MM-DD	Formats the printer date Note: MM-DD-YYYY is the US factory default setting and DD-MM-YYYY is the international factory default setting.
Time Format 12 hour A.M./P.M. 24 hour clock	Formats the printer time Note: The factory default setting is 12 hour A.M./P.M.
Alarms Alarm Control Cartridge Alarm	Sets an alarm to sound when the printer requires operator intervention. Available selections for each alarm type are: Off Single Continuous Notes: <ul style="list-style-type: none"> Single is the factory default setting for Alarm Control. Single sounds three quick beeps. Off means no alarm will sound. Continuous repeats three beeps every 10 seconds.
Timeouts Power Saver Disabled 1–240	Specifies the number of minutes of inactivity before some systems begin entering a minimum power state. Note: 30 minutes is the factory default setting.

Menu item	Description
Timeouts Screen Timeout 15–300	Sets the amount of time in seconds the printer waits before returning the printer display to a Ready state Note: 30 seconds is the factory default setting.
Timeouts Print Timeout Disabled 1–255	Sets the amount of time in seconds the printer waits to receive an end-of-job message before canceling the remainder of the print job Notes: <ul style="list-style-type: none"> • 90 seconds is the factory default setting. • When the timer expires, any partially printed page still in the printer is printed, and then the printer checks to see if any new print jobs are waiting. • Print Timeout is available only when using PCL or PPDS emulation. This setting has no effect on PostScript emulation print jobs.
Timeouts Wait Timeout Disabled 15–65535	Sets the amount of time in seconds the printer waits for additional data before canceling a print job Notes: <ul style="list-style-type: none"> • 40 seconds is the factory default setting. • Wait Timeout is available only when the printer is using PostScript emulation. This setting has no effect on PCL or PPDS emulation print jobs.
Print Recovery Auto Continue Disabled 5–255	Lets the printer automatically continue printing from certain offline situations when not resolved within the specified time period Notes: <ul style="list-style-type: none"> • Disabled is the factory default setting. • 5–255 is a range of time in seconds.
Print Recovery Jam Recovery On Off Auto	Specifies whether the printer reprints jammed pages Notes: <ul style="list-style-type: none"> • Auto is the factory default setting. The printer reprints jammed pages unless the memory required to hold the pages is needed for other printer tasks. • On sets the printer to always reprint jammed pages. • Off sets the printer to never reprint jammed pages.
Print Recovery Page Protect On Off	Lets the printer successfully print a page that may not have printed otherwise Notes: <ul style="list-style-type: none"> • Off is the factory default setting. Off prints a partial page when there is not enough memory to print the whole page. • On sets the printer to process the whole page so that the entire page prints.

Menu item	Description
Factory Defaults Do Not Restore Restore Now	Returns the printer settings to the factory default settings Notes: <ul style="list-style-type: none"> Do Not Restore is the factory default setting. Do Not Restore keeps the user-defined settings. Restore returns all printer settings to the factory default settings except Network/Ports menu settings. All downloads stored in RAM are deleted.

Copy Settings menu

Menu item	Description
Content Text Text/Photo Photograph	Specifies the type of content contained in the copy job Notes: <ul style="list-style-type: none"> Text emphasizes sharp, black, high-resolution text against a clean, white background. Text/Photo is the factory default setting. Text/Photo is used when the original documents are a mixture of text and graphics or pictures. Photograph tells the scanner to pay extra attention to graphics and pictures. This setting increases the time it takes to scan, but emphasizes a reproduction of the full dynamic range of tones in the original document. This increases the amount of information saved.
Sides (Duplex) 1 sided to 1 sided 1 sided to 2 sided 2 sided to 1 sided 2 sided to 2 sided	Specifies whether an original document is duplex (two-sided) or simplex (one-sided), and then specifies whether the copy should be duplex or simplex Notes: <ul style="list-style-type: none"> Sides (Duplex) is not available on selected models. 1 sided to 1 sided—The original page has printing on one side. The copied page will have printing on one side. 1 sided to 2 sided—The original page has printing on one side. The copied page will have printing on both sides. For example, if the original is six sheets, the copy is three sheets with printing on both sides. 2 sided to 1 sided—The original page has printing on both sides. The copied page will have printing on only one side. For example, if the original draft is three sheets of paper with an image on each side of each sheet, then the copy is six sheets with only one image on one side of each sheet. 2 sided to 2 sided—The original page has printing on both sides. The copy mimics the original exactly.
Paper Saver Off 2 on 1 Portrait 2 on 1 Landscape 4 on 1 Portrait 4 on 1 Landscape	Sets two or four sheets of an original document together on the same page Note: Off is the factory default setting.

Menu item	Description
Print Page Borders On Off	Specifies whether a border is printed around the edge of the page at the margins Note: Off is the factory default setting.
Collate On Off	Keeps the pages of a print job stacked in sequence when making multiple copies of the job Note: Off is the factory default setting.
Original Size Letter Legal Executive Folio Statement Universal ID Card 4 x 6 in. 3 x 5 in. Business Card Custom Scan Size <x> A4 A5 Oficio (Mexico) A6 JIS B5	Specifies the paper size of the original document Note: Letter is the US factory default setting. A4 is the international factory default setting.
Paper Source Tray <x> Manual Feeder	Specifies the paper source for copy jobs Note: Tray 1 is the factory default setting.
Transparency Separators On Off	Places a sheet of paper between transparencies Note: On is the factory default setting.
Separator Sheets None Between Copies Between Jobs Between Pages	Places a sheet of paper between pages, copies, or jobs based on the value selected Note: None is the factory default setting.
Separator Source Tray <x> Manual Feeder	Specifies a paper source Note: Tray 1 is the factory default setting.
Darkness -4 to +4	Specifies the level of darkness for the copy job Note: The factory default setting is 0.
Number of Copies 1–999	Specifies the number of copies for the copy job Note: The factory default setting is 1.

Menu item	Description
Overlay Off Confidential Copy Draft Urgent Custom	Specifies overlay text that is printed on each page of the copy job Note: Off is the factory default setting.
Allow priority copies On Off	Allows interruption of a print job to copy a page or document Note: On is the factory default setting.
Background Removal -4 to +4	Adjusts the amount of background visible on a copy Note: The factory default setting is 0.
Contrast 0–5 Best for content	Specifies the contrast used for the copy job Note: “Best for content” is the factory default setting.
Shadow Detail -4 to +4	Adjusts the amount of shadow detail visible on a copy Note: 0 is the factory default setting.
Scan edge to edge On Off	Specifies if the original document is scanned edge-to-edge prior to copying Note: Off is the factory default setting.
Sharpness 1–5	Adjusts the amount of sharpness on a copy Note: 3 is the factory default setting.

Fax Settings menu

General Fax Settings

Menu item	Description
Station Name	Specifies the name of the fax within the printer
Station Number	Specifies a number associated with the fax
Station ID Station Name Station Number	Specifies how the fax is identified to recipients on the fax header
Enable Manual Fax On Off	Sets the printer to fax manually only, which requires a line splitter and a telephone hand set Notes: <ul style="list-style-type: none"> • Off is the factory default setting. • Use a regular telephone to answer an incoming fax job and to dial a fax number. • Press # 0 on the numeric keypad to go directly to the Manual Fax function.

Menu item	Description
Memory Use All receive Mostly receive Equal Mostly sent All send	Defines the amount of non-volatile memory used to fax a job Notes: <ul style="list-style-type: none"> • “All receive” specifies that all the memory is set to receive fax jobs. • “Mostly receive” specifies that most of the memory is set to receive fax jobs. • “Equal” is the factory default setting. It splits the memory for sending and receiving fax jobs into equal amounts. • “Mostly sent” specifies that most of the memory is set to send fax jobs. • “All send” specifies that all the memory is set to send fax jobs.
Cancel Faxes Allow Don't Allow	Specifies whether the user may cancel fax jobs Note: If Cancel Faxes is not enabled, it will not appear as an option. Allow is the factory default setting.
Caller ID FSK DTMF	Specifies the type of caller ID being used Note: This option appears only when the selected country supports multiple caller ID patterns.

Fax Send Settings

Menu item	Description
Resolution Standard Fine Super Fine	Specifies quality in dots per inch (dpi). A higher resolution gives greater print quality, but it increases the fax transmission time for outgoing faxes. Note: Standard is the factory default setting.
Original Size Letter Legal Executive Mixed Letter/Legal Folio Statement A4 A5 A6 Oficio (Mexico) JIS B5 4 x 6 3 x 5 ID Card Universal Custom Scan Size Business Card	Specifies the paper size of the document that is being scanned Note: Mixed Letter/Legal is the US factory default setting. A4 is the international factory default setting.

Menu item	Description
Sides (Duplex) Off Long edge Short edge	Specifies how the text and graphics are oriented on the page Notes: <ul style="list-style-type: none"> • Sides (Duplex) is not available on selected printer models. • Off is the factory default setting. • Long edge assumes binding along the long edge of the page (left edge for portrait orientation and top edge for landscape orientation). • Short edge assumes binding along the short edge of the page (top edge for portrait orientation and left edge for landscape orientation).
Content Text Text/Photo Photograph	Specifies the type of content that will be scanned to fax Notes: <ul style="list-style-type: none"> • Text is the factory default setting. • Text is used when the document is mostly text. • Text/Photo is the factory default setting. Text/Photo is used when the documents are mostly text or line art. • Photograph is used when the document is a high-quality photograph or inkjet print.
Darkness -4 to +4	Lightens or darkens the output Note: 0 is the factory default setting.
Dial Prefix	A numeric entry field is provided to enter numbers
Automatic Redial 0–9	Specifies the number of times the printer tries to send the fax to a specified number Note: 5 is the factory default setting.
Redial Frequency 1–200	Specifies the number of minutes between redials Note: 3 minutes is the factory default setting.
Behind a PABX Yes No	Enables switchboard blind dialing without a dial tone Note: No is the factory default setting.
Enable ECM Yes No	Enables Error Correction Mode for fax jobs Note: Yes is the factory default setting.
Enable Fax Scans On Off	Lets you send faxes by scanning at the printer Note: On is the factory default setting.
Driver to fax Yes No	Allows driver to fax jobs to be sent by the printer Note: Yes is the factory default setting.
Dial Mode Tone Pulse	Specifies the dialing sound, either as a tone or a pulse Note: Tone is the factory default setting.

Menu item	Description
Max Speed 2400 4800 9600 14400 33600	Specifies the maximum speed in baud at which faxes are sent Note: 33600 baud is the factory default setting.
Background Removal -4 to +4	Adjusts the amount of background visible on a copy Note: 0 is the factory default setting.
Contrast Best for content 0–5	Specifies the contrast of the output Note: “Best for content” is the factory default setting.
Shadow Detail -4 to +4	Adjusts the amount of shadow detail visible on a copy Note: 0 is the factory default setting.
Scan edge to edge On Off	Specifies if the original document is scanned edge-to-edge Note: Off is the factory default setting.
Sharpness 1–5	Adjusts the amount of sharpness on a fax Note: 3 is the factory default setting.

Fax Receive Settings

Menu item	Description
Enable Fax Receive On Off	Allows fax jobs to be received by the printer Note: On is the factory default setting.
Rings to Answer 1–25	Specifies the number of rings before answering an incoming fax job Note: 3 is the factory default setting.
Auto Answer Yes No	Allows the printer to answer an incoming fax job Note: Yes is the factory default setting.
Manual Answer Code 1–9	Lets you enter a code on the telephone number pad to begin receiving a fax Notes: <ul style="list-style-type: none"> • This menu item is used when the printer shares a line with a telephone. • 9 is the factory default setting.
Auto Reduction On Off	Scales an incoming fax job so it fits the size of the paper loaded in the designated fax source Note: On is the factory default setting.
Paper Source Auto Tray <x> Manual Feeder	Specifies the paper source selected to supply paper for the printer to print an incoming fax Note: Auto is the factory default setting.

Menu item	Description
Sides (Duplex) On Off	Enables duplex (two-sided) printing for incoming fax jobs Note: Off is the factory default setting.
Fax Footer On Off	Prints the transmission information at the bottom of each page from a received fax Note: Off is the factory default setting.
Max Speed 2400 4800 9600 14400 33600	Specifies the maximum speed in baud at which faxes are received Note: 33600 (baud) is the factory default setting.
Block No Name Fax On Off	Enables blocking of incoming faxes sent from devices with no station ID specified Note: Off is the factory default setting.

Fax Log Settings

Menu item	Description
Transmission Log Print log Do not print log Print only for error	Enables printing of a transmission log after each fax job Note: Print log is the factory default setting.
Receive Error Log Print Never Print on Error	Enables printing of a receive error log following a receive error Note: Print Never is the factory default setting.
Auto Print Logs On Off	Enables automatic printing of fax logs Note: On is the factory default setting.
Log Paper Source Tray <x>	Selects the source of the paper used for printing logs Note: Tray 1 is the factory default setting.
Logs Display Remote Station Name Dialed Number	Specifies whether printed logs display the dialed number or the station name Note: "Remote Station Name" is the factory default setting.
Enable Job Log On Off	Enables access to the Fax Job log Note: On is the factory default setting.
Enable Call Log On Off	Enables access to the Fax Call log Note: On is the factory default setting.

Speaker Settings

Menu item	Description
Speaker Mode Always Off On until Connected Always On	Notes: <ul style="list-style-type: none"> • Always Off turns the speaker off. • “On until Connected” is the factory default setting. The speaker is on and issues a noise until the fax connection is made. • Always On turns the speaker on.
Speaker Volume High Medium Low	Controls the volume setting Note: High is the factory default setting.
Ringer Volume On Off	Controls the ringer volume for the fax speaker Note: On is the factory default setting.

Distinctive Ring Settings

Menu item	Description
Single Ring On Off	Answers calls with a one-ring pattern Note: On is the factory default setting.
Double Ring On Off	Answers calls with a double-ring pattern Note: On is the factory default setting.
Triple Ring On Off	Triple Ring answers calls with a triple-ring pattern Note: On is the factory default setting.

Flash Drive menu

Flash Drive menu

Menu item	Description
Enable Drive Enable Disable	Enables or disables the USB port on the front of the printer Notes: <ul style="list-style-type: none"> • Certain options are not available on selected printer models. • Enable is the factory default setting.
Update Code Enable Disable	Enables or disables the ability of the printer to update its firmware code from a USB device Note: Enable is the factory default setting

Scan Settings

Menu item	Description
Format PDF (.pdf) TIFF (.tif) JPEG (.jpg)	Specifies the format of the file Note: PDF is the factory default setting.
PDF Version 1.2–1.6	Sets the version of the PDF file that will be scanned to USB Note: 1.5 is the factory default setting.
Content Text Text/Photo Photograph	Specifies the type of content that will be scanned to USB Notes: <ul style="list-style-type: none"> • Text is used when the document is mostly text. • Text/Photo is the factory default setting. Text/Photo is used when the documents are mostly text or line art. • Photograph is used when the document is a high-quality photograph or inkjet print.
Color Gray Color	Specifies whether a job scans in grayscale or color Note: Gray is the factory default setting.
Resolution 75 150 200 300 400 600	Specifies how many dots per inch are scanned Note: 150 dpi is the factory default setting.
Darkness -4 to +4	Lightens or darkens the output Note: 0 is the factory default setting.
Orientation Portrait Landscape	Specifies the orientation of the scanned image Note: Portrait is the factory default setting.

Menu item	Description
Original Size Letter Legal Mixed Letter/Legal Executive Folio Statement Universal 4 x 6 in. 3 x 5 in. Business Card ID Card Custom Scan Size <x> A4 A5 Oficio (Mexico) A6 JIS B5	Specifies the paper size of the document that is being scanned Note: Letter is the US factory default setting. A4 is the international factory default setting.
Sides (Duplex) Off Long edge Short edge	Specifies how the text and graphics are oriented on the page Notes: <ul style="list-style-type: none"> • Sides (Duplex) is not available on all printer models. • Off is the factory default setting. • Long edge assumes binding along the long edge of the page (left edge for portrait orientation and top edge for landscape orientation). • Short edge assumes binding along the short edge of the page (top edge for portrait orientation and left edge for landscape orientation).
JPEG Quality Text Text/Photo Photo	Sets the quality of a JPEG text, text/photo, or photo image in relation to file size and the quality of the image. Notes: <ul style="list-style-type: none"> • 75 is the factory default setting for Text and Text/Photo. 50 is the factory default setting for Photo. • 5 reduces the file size, but the quality of the image is lessened. • 90 provides the best image quality, but the file size is very large.
Use Multi-Page TIFF On Off	Provides a choice between single-page TIFF files and multiple-page TIFF files. For a multiple-page scan to USB job, either one TIFF file is created containing all the pages, or multiple TIFF files are created with one file for each page of the job. Notes: <ul style="list-style-type: none"> • On is the factory default setting. • This menu item applies to all scan functions.
Scan Bit Depth 8 bit 1 bit	Enables the Text/Photo mode to have smaller file sizes by using 1-bit images Note: 8 bit is the factory default setting.

Menu item	Description
Base File Name	Limit the base file name to under 53 characters, because the time is added to the end of the base file name Note: Scanned-image is the factory default setting.
Background Removal -4 to +4	Adjusts the amount of background visible on a copy Note: 0 is the factory default setting.
Contrast 0–5 Best for content	Specifies the contrast of the output Note: “Best for content” is the factory default setting.
Shadow Detail -4 to +4	Adjusts the amount of shadow detail visible on a scanned image Note: 0 is the factory default setting.
Scan edge to edge On Off	Specifies if the original document is scanned edge to edge Note: Off is the factory default setting.
Sharpness 1–5	Adjusts the sharpness of a scanned image Note: 3 is the factory default setting.

Print Settings

Menu item	Description
Copies 1-999	Specifies the number of copies to print Note: 1 is the factory default setting.
Sides (Duplex) 1 sided 2 sided	Enables duplex (two-sided) printing Note: 1 sided is the factory default setting.

Print Settings

Setup menu

Menu item	Description
Printer Language PS Emulation PCL Emulation	Sets the default printer language Notes: <ul style="list-style-type: none"> • PostScript emulation uses a PS interpreter for processing print jobs. PCL emulation uses a PCL interpreter for processing print jobs. • The factory default printer language is PCL Emulation. • Setting a printer language as the default does not prevent a software program from sending print jobs that use another printer language.

Menu item	Description
Print Area Normal Whole Page	Sets the logical and physical printable area Notes: <ul style="list-style-type: none"> • Normal is the factory default setting. When attempting to print data in the non-printable area defined by the Normal setting, the printer clips the image at the boundary. • The Whole Page setting allows the image to be moved into the non-printable area defined by the Normal setting, but the printer will clip the image at the Normal setting boundary. • The Whole Page setting affects only pages printed using a PCL 5e interpreter. This setting has no effect on pages printed using the PCL XL or PostScript interpreter.
Download Target RAM Flash	Sets the storage location for downloads Notes: <ul style="list-style-type: none"> • RAM is the factory default setting. • Flash appears only if a flash option is installed. • Storing downloads in RAM is temporary.
Resource Save On Off	Specifies how the printer handles temporary downloads, such as fonts and macros stored in RAM, when the printer receives a job that requires more memory than is available Notes: <ul style="list-style-type: none"> • Off is the factory default setting. Off sets the printer to retain the downloads only until memory is needed. Downloads are deleted in order to process print jobs. • The On setting retains the downloads during language changes and printer resets. If the printer runs out of memory, downloads are not deleted.

Finishing menu

Note: Certain options are not available on selected printer models.

Menu item	Description
Sides 2 Sided 1 Sided	Specifies whether duplex (2-sided) printing is set as the default for all print jobs Note: 1 Sided is the factory default setting.

Menu item	Description
Duplex Binding Long Edge Short Edge	Defines the way duplexed pages are bound and how the printing on the back of the page is oriented in relation to the printing on the front of the page Notes: <ul style="list-style-type: none"> • Long Edge is the factory default setting. • Long Edge specifies that binding be placed on the left edge of portrait pages and the top edge of landscape pages. • Short Edge specifies that binding be placed on the top edge of portrait pages and the left edge of landscape pages.
Copies 1–999	Specifies a default number of copies for each print job Note: 1 is the factory default setting.
Blank Pages Do Not Print Print	Specifies whether blank pages are inserted in a print job Note: “Do Not Print” is the factory default setting.
Collate On Off	Stacks the pages of a print job in sequence when printing multiple copies Notes: <ul style="list-style-type: none"> • Off is the factory default setting. No pages will be collated. • The On setting stacks the print job sequentially. • Both settings print the entire job the number of times specified by the Copy menu setting.
Separator Sheets None Between Copies Between Jobs Between Pages	Specifies whether blank separator sheets are inserted Notes: <ul style="list-style-type: none"> • None is the factory default setting. • Between Copies inserts a blank sheet between each copy of a print job if Collation is set to On. If Collation is set to Off, a blank page is inserted between each set of printed pages, such as after all page 1's, all page 2's, and so on. • Between Jobs inserts a blank sheet between print jobs. • Between Pages inserts a blank sheet between each page of the print job. This setting is useful when printing transparencies or inserting blank pages in a document for notes.
Separator Source Tray <x> Multi-Page Feeder	Specifies the paper source for separator sheets Note: Tray 1 (standard tray) is the factory default setting.
N-Up Off 2 Up 4 Up 6 Up 9 Up 16 Up	Specifies that multiple-page images are printed on one side of a sheet of paper Notes: <ul style="list-style-type: none"> • The number selected is the number of page images that will print per side • Off is the factory default setting.

Menu item	Description
N-Up Ordering Horizontal Reverse Horizontal Reverse Vertical Vertical	Specifies how the page images appear on the physical page Note: Horizontal is the factory default setting.
Orientation Auto Landscape Portrait	Specifies the orientation of a multiple-page sheet Notes: <ul style="list-style-type: none"> • Auto is the factory default setting. The printer chooses between portrait and landscape. • Long Edge uses landscape. • Short Edge uses portrait.
N-Up Border None Solid	Prints a border around each page image Note: None is the factory default setting.

Quality menu

Menu item	Description
Print Resolution 300 dpi 600 dpi 1200 dpi 1200 Image Q 2400 Image Q	Specifies the printed output resolution Note: 600 dpi is the factory default setting. The printer driver default is 1200 IQ.
Pixel Boost Off Fonts Horizontally Vertically Both Directions	Enhances the printed quality of small fonts and graphics Notes: <ul style="list-style-type: none"> • Off is the factory default setting. • Fonts applies this setting only to text. • Horizontally darkens horizontal lines of text and images. • Vertically darkens vertical lines of text and images. • Both Directions darkens horizontal and vertical lines on text and images.
Toner Darkness 1–10	Lightens or darkens the printed output Notes: <ul style="list-style-type: none"> • 8 is the factory default setting. • Selecting a smaller number can help conserve toner.

Menu item	Description
Enhance Fine Lines On Off	Enables a print mode preferable for files such as architectural drawings, maps, electrical circuit diagrams, and flow charts Notes: <ul style="list-style-type: none"> • Off is the factory default setting. • To set Enhance Fine Lines using the Embedded Web Server, type the network printer IP address in a browser window.
Gray Correction Auto Off	Adjusts the gray value of printed output Note: Auto is the factory default setting.
Brightness -6 to +6	Adjusts or darkens printed output and conserves toner Notes: <ul style="list-style-type: none"> • 0 is the factory default setting. • A negative value will darken text, images, and graphics. A positive value will lighten them and conserve toner.
Contrast 0–5	Adjusts the degree of difference between levels of gray in printed output Notes: <ul style="list-style-type: none"> • 0 is the factory default setting. • Higher settings show more difference between levels of gray.

Utilities menu

Menu item	Description
Format Flash No Yes	Formats the flash memory. Flash memory refers to the memory added by installing an optional flash memory card in the printer. Warning—Potential Damage: Do not turn off the printer while the flash memory is formatting. Notes: <ul style="list-style-type: none"> • An optional flash memory card must be installed in the printer and operating properly for this menu item to be available. • No cancels the format request. • Selecting Yes deletes all data stored in flash memory.

Menu item	Description
Defragment Flash No Yes	Prepares the flash memory to receive new data by retrieving lost storage space Warning—Potential Damage: Do not turn off the printer while the flash memory is defragmenting. Notes: <ul style="list-style-type: none"> • An optional flash memory card must be installed in the printer and operating properly for this menu item to be available. The flash memory card must not be Read/Write or Write protected. • No cancels the defragment request. • Selecting Yes reformats the flash memory after transferring all downloads to regular printer memory. When formatting is complete, the downloads are loaded back into flash memory.
Hex Trace Activate	Assists in isolating the source of a print job problem Notes: <ul style="list-style-type: none"> • When Activate is selected, all data sent to the printer is printed in hexadecimal and character representation and control codes are not executed. • To exit Hex Trace, turn the printer off or reset the printer.
Coverage Estimator Off On	Provides an estimate of the percentage coverage of black on a page. The estimate is printed on a separator page. Note: Off is the factory default setting.

PDF menu

Menu item	Description
Scale to Fit No Yes	Scales page content to fit the selected page size Note: No is the factory default setting.
Annotations Do Not Print Print	Specifies whether to print annotations in the PDF Note: Do Not Print is the factory default setting.

PostScript menu

Menu item	Description
Print PS Error On Off	Prints a page containing the PostScript error Note: Off is the factory default setting.

Menu item	Description
Font Priority Resident Flash/Disk	Establishes the font search order Notes: <ul style="list-style-type: none"> • Resident is the factory default setting. • A formatted flash memory option card must be installed in the printer and operating properly for this menu item to be available. • The flash memory option cannot be Read/Write, Write, or password-protected. • Job Buffer Size must not be set to 100%.

PCL Emul menu

Menu item	Description
Font Source Resident Download Flash All	Specifies the set of fonts available Notes: <ul style="list-style-type: none"> • Resident is the factory default setting. It shows the factory default set of fonts downloaded into RAM. • Download appears only if downloaded fonts exist. It shows all the fonts downloaded into RAM. • Flash appears only if a flash option containing fonts is installed. • A flash option must be properly formatted and cannot be Read/Write, Write, or password protected. • All shows all fonts available to any option.
Font Name <x>	Lets you view or change the setting from a selection list
Symbol Set <x>	Lets you view or change the setting from a selection list
PCL Emulation Settings Point Size 1.00–1008.00	Changes the point size for scalable typographic fonts Notes: <ul style="list-style-type: none"> • 12 is the factory default setting. • Point Size refers to the height of the characters in the font. One point equals approximately 1/72 of an inch. • Point sizes can be increased or decreased in 0.25-point increments.
PCL Emulation Settings Pitch 0.08–100	Specifies the font pitch for scalable monospaced fonts Notes: <ul style="list-style-type: none"> • 10 is the factory default setting. • Pitch refers to the number of fixed-space characters per inch (cpi). • Pitch can be increased or decreased in 0.01-cpi increments. • For nonscalable monospaced fonts, the pitch appears on the display but cannot be changed.

Menu item	Description
PCL Emulation Settings Orientation Portrait Landscape	Specifies the orientation of text and graphics on the page Notes: <ul style="list-style-type: none"> • Portrait is the factory default setting. • Portrait prints text and graphics parallel to the short edge of the page. • Landscape prints text and graphics parallel to the long edge of the page.
PCL Emulation Settings Lines per Page 1–255 60 64	Specifies the number of lines that print on each page Notes: <ul style="list-style-type: none"> • 60 is the US factory default setting. 64 is the international default setting. • The printer sets the amount of space between each line based on the Lines per Page, Paper Size, and Orientation settings. Select the desired Paper Size and Orientation before setting Lines per Page.
PCL Emulation Settings A4 Width 198 mm 203 mm	Sets the printer to print on A4-size paper Notes: <ul style="list-style-type: none"> • 198 mm is the factory default setting. • The 203-mm setting sets the width of the page to allow the printing of eighty 10-pitch characters.
PCL Emulation Settings Auto CR after LF On Off	Specifies whether the printer automatically performs a carriage return (CR) after a line feed (LF) control command Note: Off is the factory default setting.
PCL Emulation Settings Auto LF after CR On Off	Specifies whether the printer automatically performs a line feed (LF) after a carriage return (CR) control command Note: Off is the factory default setting.
Tray Renumber Assign MP Feeder Off None 0–199 Assign Tray <x> Off None 0–199 Assign Manual Paper Off None 0–199 Assign Man Env Off None 0–199	Configures the printer to work with printer software or programs that use different source assignments for trays, drawers, and feeders Notes: <ul style="list-style-type: none"> • Off is the factory default setting. • None is not an available selection. It is displayed only when it is selected by the PCL 5 interpreter. • None ignores the Select Paper Feed command. • 0–199 allows a custom setting to be assigned.

Menu item	Description
Tray Renumber View Factory Def None	Displays the factory default setting assigned to each tray, drawer, or feeder
Tray Renumber Restore Defaults Yes No	Returns all tray, drawer, and feeder assignments to the factory default settings

Image menu

Menu item	Description
Auto Fit On Off	Selects the optimal paper size, scaling, and orientation Notes: <ul style="list-style-type: none"> On is the factory default setting. The On setting overrides scaling and orientation settings for some images.
Invert On Off	Inverts bi-tonal monochrome images Notes: <ul style="list-style-type: none"> Off is the factory default setting. The font size can be increased in 1-point increments. This setting does not apply to GIF or JPEG images.
Scaling Anchor Top Left Best Fit Anchor Center Fit Height/Width Fit Height Fit Width	Scales the image to fit the selected paper size Note: Best Fit is the factory default setting.
Orientation Portrait Landscape Rev Portrait Rev Landscape	Sets the image orientation Note: Portrait is the factory default setting.

Set Date and Time

Menu item	Description
View Date/Time	Displays the time in YYYY-MM-DD HH:MM format Note: This is a view only screen.

Menu item	Description
Set Date/Time Yes No	Instructs the printer to run the setup wizard Notes: <ul style="list-style-type: none"> • Yes is the factory default setting. • After completing the setup wizard by selecting Done at the Country/Region select screen, the default becomes No.
Time Zone (North, Central, and South America) Hawaii * Alaska Tijuana (PST) USA/Canada PST USA/Canada MST USA/Canada CST USA/Canada EST Canada AST Caracas (VET) Newfoundland (NST) Brasilia (BRT)	Specifies the time zone for the fax Note: * indicates that this value <i>does not</i> have pre-programmed Daylight Savings Time Start and End times.
Time Zone (Europe and Africa) Azores (AZOT) Praia (CVT) * GMT (*) Dublin, Ireland London (BST) Western Europe Central Europe Eastern Europe Cairo (EET) Pretoria (SAST) * Moscow (MSK)	Specifies the time zone for the fax Note: * indicates that this value <i>does not</i> have pre-programmed Daylight Savings Time Start and End times.
Time Zone (Asia) Jerusalem (IST) Abu Dhabi GIST)* Kabul (AFT) * Islamabad (PKT) * New Delhi (IST) * Kathmandu (NPT) * Astana (ALMT) * Yangon (MMT) * Bangkok (ICT) * Beijing (CST) * Seoul (KST) * Tokyo (JST) *	Specifies the time zone for the fax Note: * indicates that this value <i>does not</i> have pre-programmed Daylight Savings Time Start and End times.

Menu item	Description
Time Zone (Australia and the Pacific region) Australia WST Australia CST Darwin (CST) * Australia EST Queensland (EST) * Tasmania (EST) Wellington (NZST) Not Listed	Specifies the time zone for the fax Note: * indicates that this value <i>does not</i> have pre-programmed Daylight Savings Time Start and End times.
Observe DST On Off	Accommodates Daylight Savings Time changes Note: On is the factory default setting.
Enable NTP On Off	Lets the printer clock synchronize with the Network Time Protocol (NTP) server Note: On is the factory default setting.

Maintaining the printer

Cleaning the exterior of the printer

- 1 Make sure that the printer is turned off and unplugged from the wall outlet.

⚠ CAUTION—SHOCK HAZARD: To avoid the risk of electric shock when cleaning the exterior of the printer, unplug the power cord from the wall outlet and disconnect all cables to the printer before proceeding.

- 2 Remove all paper from the printer.
- 3 Dampen a clean, lint-free cloth with water.

Warning—Potential Damage: Do not use household cleaners or detergents, as they may damage the finish of the printer.

- 4 Wipe only the outside of the printer.

Warning—Potential Damage: Using a damp cloth to clean the interior may cause damage to your printer.

- 5 Make sure all areas of the printer are dry before beginning a new print job.

Cleaning the scanner glass

If you encounter print quality problems, such as streaks on copied or scanned images, clean the areas shown.

- 1 Slightly dampen a soft, lint-free cloth or paper towel with water.
- 2 Open the scanner cover.

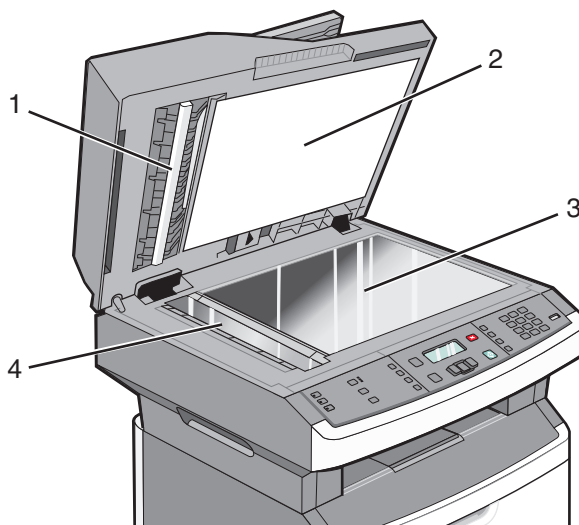

1	White underside of the ADF cover
2	White underside of the scanner cover
3	Scanner glass
4	ADF glass

- 3 Wipe the areas shown and let them dry.
- 4 Close the scanner cover.

Cleaning the ADF separator rollers

After you have copied over 50,000 copies using the ADF, clean the ADF separator rollers.

- 1 Open the ADF cover.

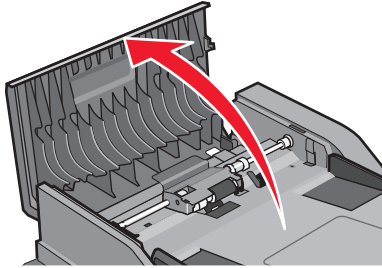

- 2 Unlock the separator roll.

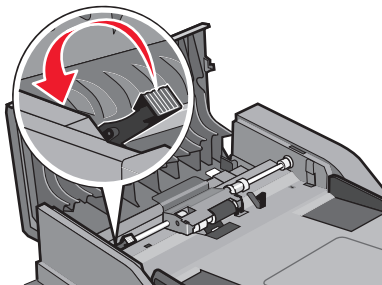

- 3 Remove the separator roll.

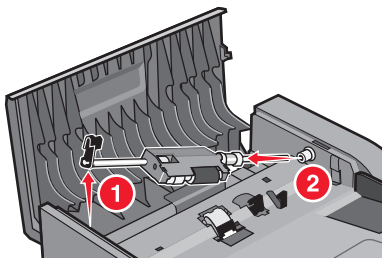

- 4 Use a clean, lint-free cloth dampened with water to wipe the separator rollers.

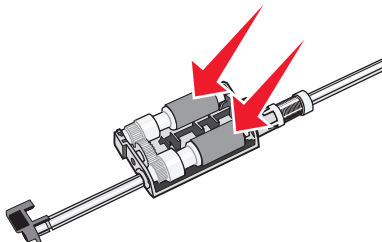

5 Reinstall the separator roll.

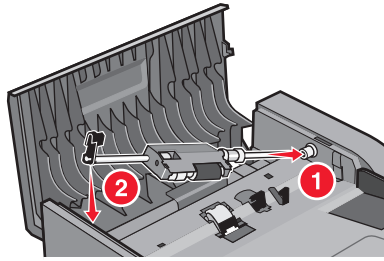

6 Lock the separator roll.

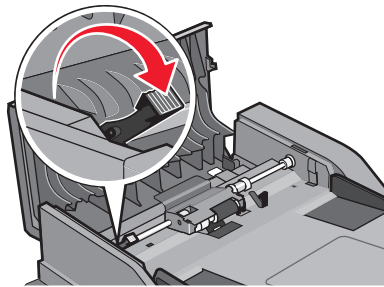

7 Close the ADF cover.

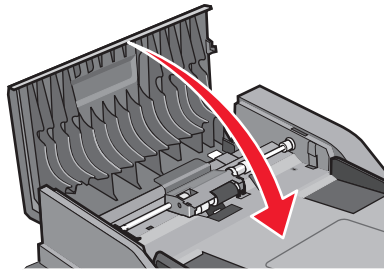

Storing supplies

Choose a cool, clean storage area for the printer supplies. Store supplies right side up in their original packing until you are ready to use them.

Do not expose supplies to:

- Direct sunlight
- Temperatures above 35°C (95°F)
- High humidity above 80%
- Salty air
- Corrosive gases
- Heavy dust

Checking the status of supplies from a network computer

Note: The computer must be connected to the same network as the printer.

- 1 Type the printer IP address into the address field of your Web browser.

Note: If you do not know the IP address of the printer, print a network setup page and locate the IP address in the TCP/IP section.

- 2 Click **Device Status**. The Device Status page appears, displaying a summary of supply levels.

Moving the printer to another location

Warning—Potential Damage: Damage to the printer caused by improper moving is not covered by the printer warranty.



CAUTION—POTENTIAL INJURY: Follow these guidelines to avoid personal injury or printer damage:

- Turn the printer off using the power switch, and then unplug the power cord from the wall outlet.
- Disconnect all cords and cables from the printer before moving it.
- Use the handholds located on both sides of the printer to lift it.
- Make sure your fingers are not under the printer when you set it down.
- Before setting up the printer, make sure there is adequate clearance around it. For more information, see “Selecting a location for the printer” on page 9.

The printer and options can be safely moved to another location by following these precautions:

- Any cart used to move the printer must be able to support its weight and have a large enough surface to support the full footprint of the printer.
- Keep the printer in an upright position.
- Avoid severe jarring movements.

Shipping the printer

When shipping the printer, use the original packaging or call the place of purchase for a relocation kit.

Ordering supplies

To order supplies in the U.S., contact Lexmark at 1-800-539-6275 for information about Lexmark authorized supplies dealers in your area. In other countries or regions, visit the Lexmark Web Site at www.lexmark.com or contact the place where you purchased the printer.

Warning—Potential Damage: Damage caused by the use of a supply or replacement item not produced by the manufacturer of this printer is not covered under warranty. Degraded print quality may result from using supplies or replacement items not produced by the manufacturer of this printer.

Note: All life estimates for printer supplies assume printing on letter- or A4-size plain paper.

Ordering toner cartridges

When **88 Cartridge Low** appears or when the print becomes faded:

- 1 Remove the toner cartridge.
- 2 Firmly shake the cartridge side-to-side and front-to-back several times to redistribute toner.

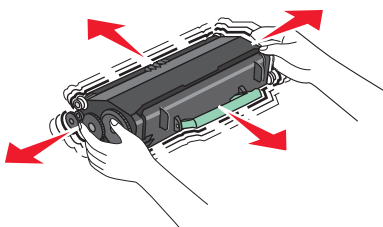

- 3 Reinsert the cartridge and continue printing.

Note: Repeat this procedure multiple times until the print remains faded, and then replace the cartridge.

Recommended toner cartridges and part numbers

Part Name	Regular Cartridge	Lexmark Return Program Cartridge
Toner Cartridge	X264A21G	X264A11G
High Yield Toner Cartridge	X264H21G	X264H11G

Ordering a photoconductor kit

The printer issues a message to let you know the photoconductor kit is near its end of life. At this time, order a photoconductor kit. You can also see the status of the photoconductor kit by printing a network setup page.

Part name	Part number
Photoconductor kit	E260X22G

Ordering ADF replacement parts

Order ADF replacement parts if you experience problems with paper double-feeding or failing to feed through the Automatic Document Feeder.

Part name	Part number
ADF input tray	40X5470
ADF separator pad	40X5472
ADF separator roll	40X5471

Replacing supplies

Replacing the toner cartridge

When **88 Cartridge is low** appears, or when you experience faded print, remove the toner cartridge. Firmly shake it side-to-side and front-to-back several times to redistribute the toner, and then reinsert it and continue printing. When shaking the cartridge no longer improves the print quality, replace the toner cartridge.

Note: You can check to see approximately how much toner is left in your cartridge by printing a menu settings page.

To replace the toner cartridge:

- 1 Open the front door by pressing the button on the left side of the printer and lowering the door.

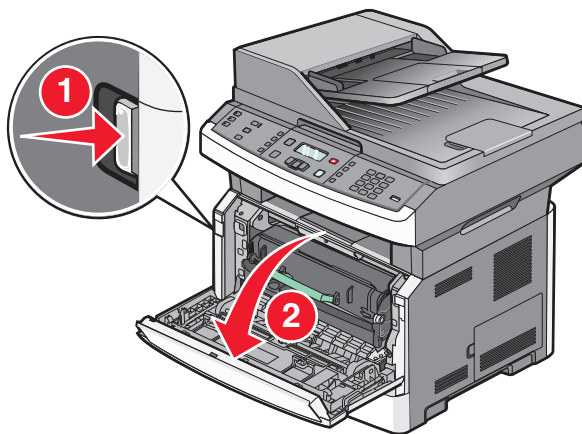

2 Press the button on the base of the photoconductor kit, and then pull the toner cartridge out using the handle.

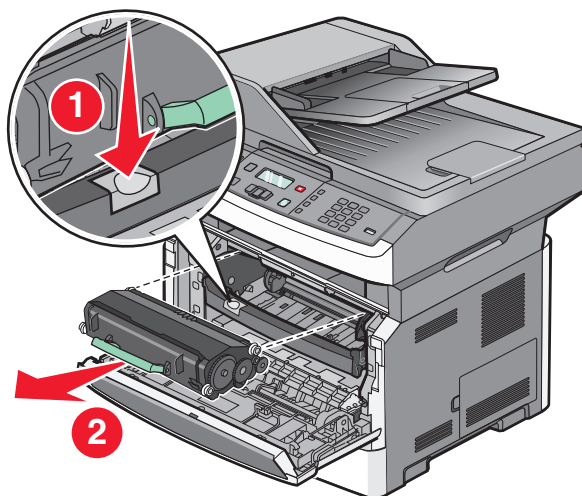

3 Unpack the new toner cartridge.

4 Shake the cartridge in all directions to distribute the toner.

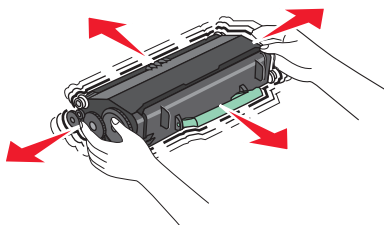

- 5 Install the new toner cartridge by aligning the rollers on the toner cartridge with the arrows on the tracks of the photoconductor kit. Push the toner cartridge in as far as it will go. The cartridge *clicks* into place when correctly installed.

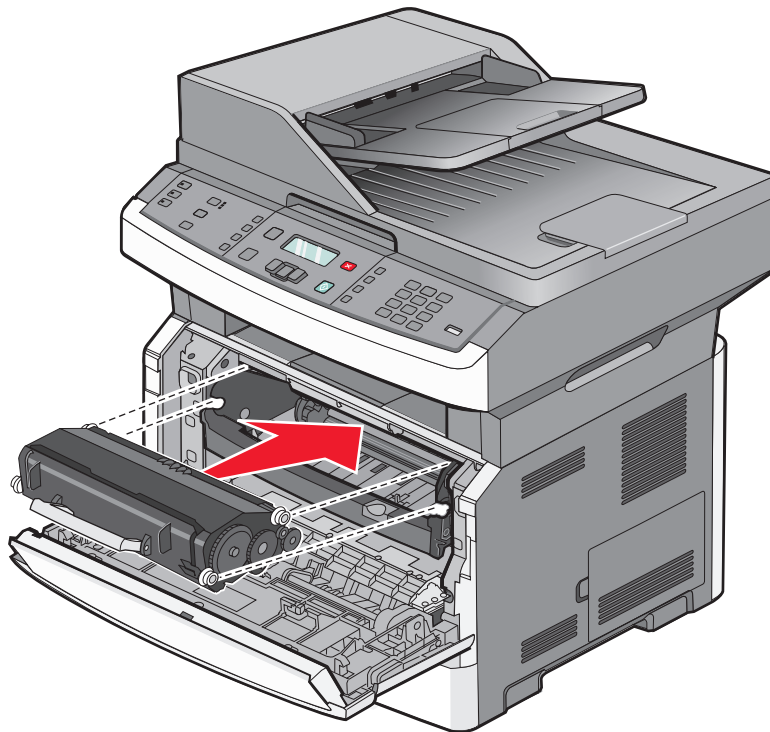

- 6 Close the front door.

Replacing the photoconductor kit

The printer automatically notifies you before the photoconductor kit reaches a page maximum by showing **84 PC Kit life warning** or **84 Replace PC Kit** on the display. You can also see the status of the photoconductor kit by printing a menu settings page.

When **84 PC Kit life warning** or **84 Replace PC Kit** first appears, you should immediately order a new photoconductor kit. While the printer may continue to function properly after the photoconductor kit has reached its official end-of-life, print quality significantly decreases.

Note: The photoconductor kit is one item only.

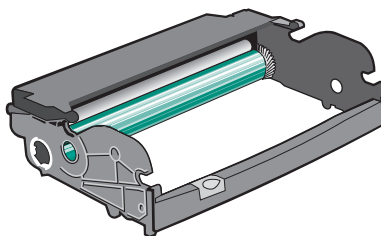

To replace the photoconductor kit:

- 1 Open the front door by pressing the button on the left side of the printer and lowering the front door.
- 2 Pull the photoconductor kit and toner cartridge out of the printer as a unit by pulling on the toner cartridge handle.

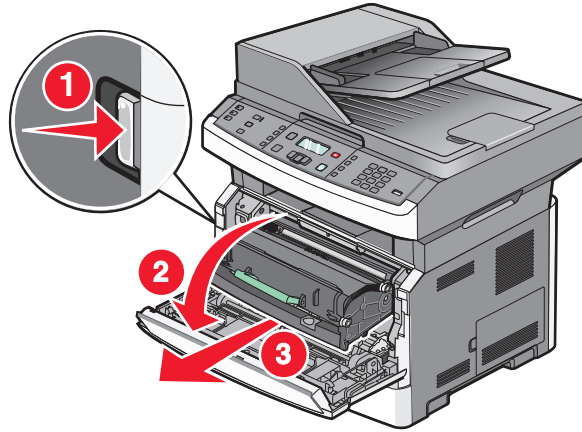

- 3 Place the unit on a flat, clean surface.

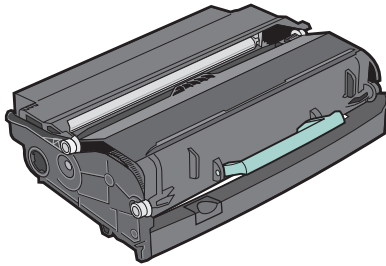

- 4 Press the button on the base of the photoconductor kit. Pull the toner cartridge up and out using the handle.

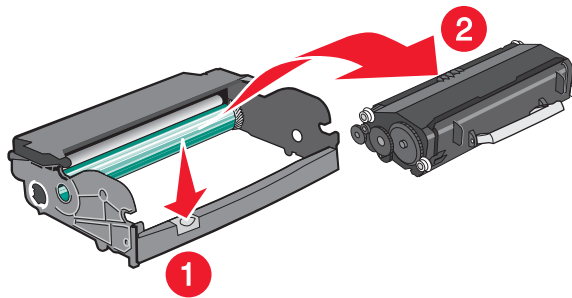

- 5 Unpack the new photoconductor kit. Be careful not to touch the photoconductor drum.

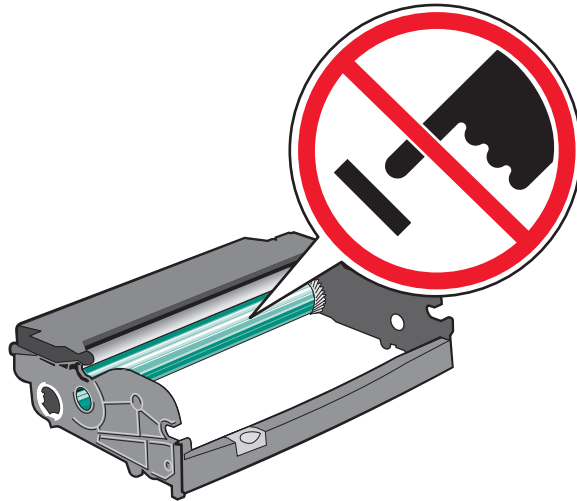

Warning—Potential Damage: When replacing a photoconductor kit, do not leave it exposed to direct light for an extended period of time. Extended light exposure can cause print quality problems.

- 6 Insert the toner cartridge into the photoconductor kit by aligning the rollers on the toner cartridge with the tracks. Push the toner cartridge until it *clicks* into place.

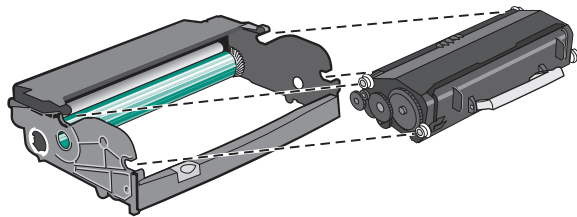

- 7 Install the unit into the printer by aligning the arrows on the guides of the unit with the arrows in the printer. Push the unit as far as it will go.

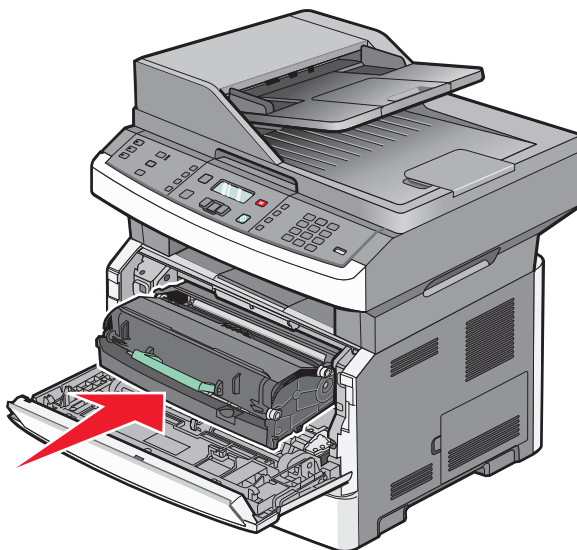

- 8 After you replace the photoconductor kit, reset the photoconductor counter. To reset the counter, see the instruction sheet that came with the new photoconductor kit.

Warning—Potential Damage: Resetting the photoconductor counter without replacing the photoconductor may damage your printer and void your warranty.





- 9 Close the front door.

Administrative support

Finding advanced networking and administrator information

This chapter covers basic administrative support tasks. For more advanced system support tasks, see the *Networking Guide* on the *Software and Documentation* CD and the *Embedded Web Server Administrator's Guide* on the Lexmark Web site at www.lexmark.com.

Restoring the factory default settings

- 1 From the printer control panel, press .
- 2 Press the arrow buttons until **Settings** appears, and then press .
- 3 Press the arrow buttons until **General Settings** appears, and then press .
- 4 Press the arrow buttons until **Factory Defaults** appears, and then press .
- 5 Press the arrow buttons until **Restore Now** appears, and then press .

Wait for **Submitting Changes** to appear momentarily, followed by **Restoring Factory Defaults**, before the printer returns to **Ready**.

Warning—Potential Damage: Restore Now returns all printer settings to the factory default settings except Network/Port menu settings. All downloads stored in RAM are deleted. Downloads stored in flash memory are not affected.

Using the Embedded Web Server

If the printer is installed on a network, the Embedded Web Server is available for a range of functions including:

- Viewing a virtual display of the printer control panel
- Checking the status of the printer supplies
- Configuring printer settings
- Configuring network settings
- Viewing reports

To access the Embedded Web Server, type the printer IP address into the address field of your Web browser.

Notes:

- If you do not know the IP address of the printer, then print a network setup page and locate the IP address in the TCP/IP section.
- For more information, see the *Networking Guide* on the *Software and Documentation* CD and the *Embedded Web Server Administrator's Guide* on the Lexmark™ Web site at www.lexmark.com.

Viewing reports

You can view some reports from the Embedded Web Server. These reports are useful for assessing the status of the printer, the network, logs, and supplies. To view reports from a network printer:

- 1 Type the printer IP address into the address field of your Web browser.

Note: If you do not know the IP address of the printer, then print a network setup page and locate the IP address in the TCP/IP section.

- 2 Click **Reports**.

Checking the device status

From the Device Status page of the Embedded Web Server, it is possible to see tray settings, the level of toner in the toner cartridge, the percentage of life remaining in the photoconductor kit, and capacity measurements of certain printer parts. To access the device status:

- 1 Type the printer IP address in the address field of your Web browser.

Note: If you do not know the IP address of the printer, print a network setup page and locate the IP address in the TCP/IP section.

- 2 Click the **Device Status** tab.

Restricting access to printer menus

You can safeguard entry to menus by creating passwords and choosing specific menus to protect. Each time a protected menu is selected, the user will be prompted to enter the correct password.

To protect printer menus using the Embedded Web Server:

- 1 Type the printer IP address into the address field of your Web browser.

Note: If you do not know the IP address of the printer, then print a network setup page and locate the IP address in the TCP/IP section.

- 2 Click **Settings**.

- 3 Under Other Settings, click **Security**.

- 4 Click **Web Page Password Protect**. It is possible to protect entry to the Paper, Reports, Settings, and Network/Ports menus.

- 5 From this screen, you may set a User Password and an Advanced Password. Determine which password will access each menu. You may also choose not to protect a menu.

Note: The Security menu is always password-protected when either an Advanced Password or a User Password has been set. If both passwords have been set, then only the Advanced Password is valid for access to the Security menu mode.

- 6 Click **Submit** to save your settings.

Setting up e-mail alerts

You can have the printer send you an e-mail when the supplies are getting low or when the paper needs to be changed, added, or unjammed.

To set up e-mail alerts:

- 1 Type the printer IP address into the address field of your Web browser.
Note: If you do not know the IP address of the printer, then print a network setup page and locate the IP address in the TCP/IP section.
- 2 Click **Settings**.
- 3 Under Other Settings, click **E-mail Alert Setup**.
- 4 Select the items for notification and type in the e-mail addresses that you want to receive e-mail alerts.
- 5 Click **Submit**.

Note: See your system support person to set up the e-mail server.

Configuring supply notifications

You can determine how you would like to be notified when supplies run low or reach their end-of-life.

To configure supply notifications using the Embedded Web Server:

- 1 Type the printer IP address into the address field of your Web browser.
Note: If you do not know the IP address of the printer, then print a network setup page and locate the IP address in the TCP/IP section.
- 2 Click **Settings**.
- 3 Click **Print Settings**.
- 4 Click **Supply Notifications**.
- 5 From the drop-down box for each supply, select among the options for notification. Explanations for each option are provided.
- 6 Click **Submit** to save your selections.

Copying printer settings to other printers

Using the Embedded Web Server, you can copy printer settings to up to 15 other network printers. To copy printer settings:

- 1 Type the printer IP address into the address field of your Web browser.
Note: If you do not know the IP address of the printer, then print a network setup page and locate the IP address in the TCP/IP section.
- 2 Click **Copy Printer Settings**.
- 3 To change the language, select a language from the drop-down list, and then click **Click here to submit language**.
- 4 Click **Printer Settings**.

5 Enter the IP addresses of the source and target printers.

Note: To add additional target printers, click the **Add Target IP** button.

6 Click **Copy Printer Settings**.

Clearing jams

Clearing jams

To clear a jam message and resume printing, clear the entire paper path, and then press . If Jam Recovery is set to On, then the printer prints a new copy of the page that jammed. If Jam Recovery is set to Auto, then the printer reprints the jammed page if enough printer memory is available.

Understanding jam messages and locations

Note: To resolve any message, all paper or specialty media must be cleared from the entire paper path.

Open doors and covers, and remove trays to access jam locations. The following illustration and table indicate these locations. See “Jam message numbers and how to access each jam” on page 162 for a list of jam numbers and instructions for how to access each jam.

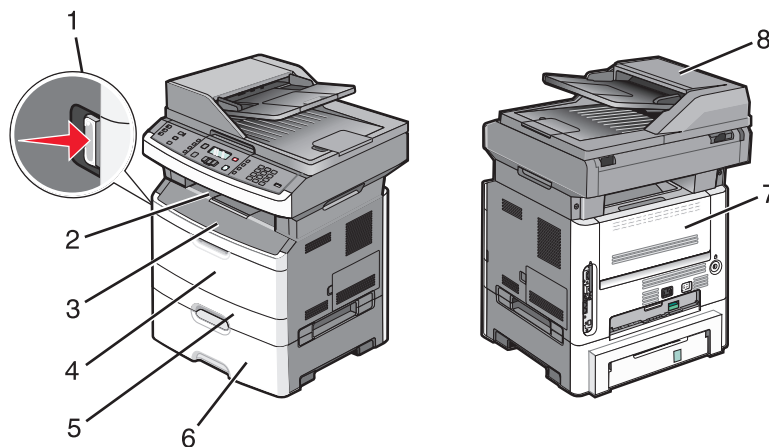

1	Push the button to open the front door. Inside are the toner cartridge and photoconductor kit.
2	Standard exit bin
3	Front door
4	Multipurpose or manual feeder door Note: Some printer models have a multipurpose feeder and some have a manual feeder
5	Tray 1
6	Optional 250- or 550-sheet tray (Tray 2)
7	Rear door
8	ADF

Jam message numbers and how to access each jam

Jam number	To access the jam
200-201	Try one or more of the following: <ul style="list-style-type: none"> • Remove Tray 1. • Open the front door, and then remove the photoconductor kit.
202	Open the front door, and then open the rear door.
231	Open the front door, and then open the rear door.
233	Remove Tray 1, and then depress the lever. Note: For alternative access to the jam, open the front door, and then open the rear door.
234	Try one or more of the following: <ul style="list-style-type: none"> • Open the front door, and then open the rear door. • Remove Tray 1, and then depress the lever.
235	Remove the jam from the standard exit bin.
242	Remove Tray 2.
251	Open the multipurpose feeder door.
290-294	Try one or more of the following: <ul style="list-style-type: none"> • Open the ADF cover, and then remove the separator roll. • Open the scanner cover. • Remove the ADF paper tray.

200-201 paper jams

CAUTION—HOT SURFACE: The fuser and the inside of the printer near the fuser may be hot. To reduce the risk of injury from a hot component, allow the surface to cool before removing paper from this area.

- 1 Pull the tray completely out.

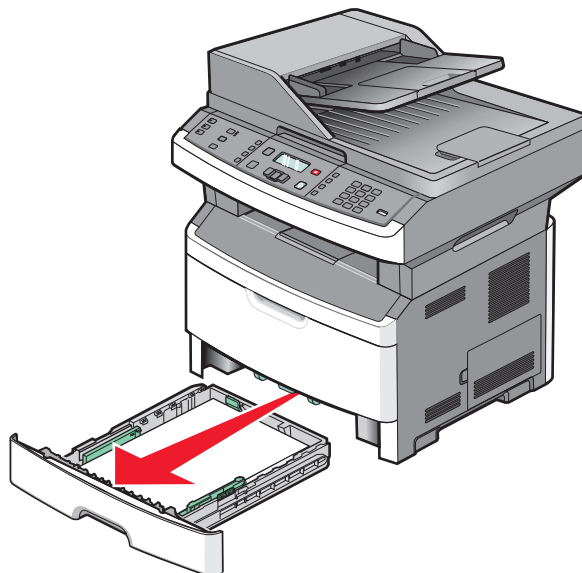

2 Remove the jam if you see it here.



3 If you do not see the jam, open the front door, and then remove the photoconductor kit and toner cartridge.

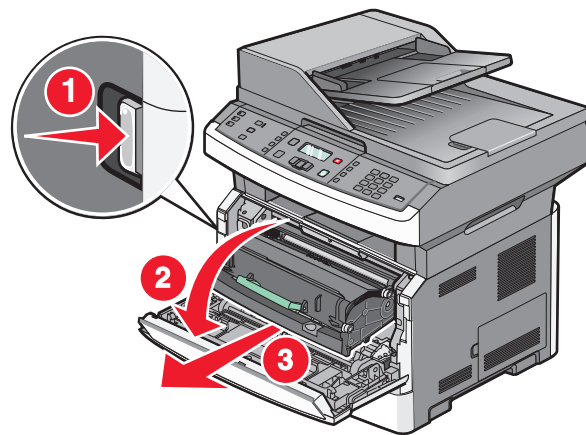

4 Lift the flap at the front of the printer, and then remove any jammed sheets.

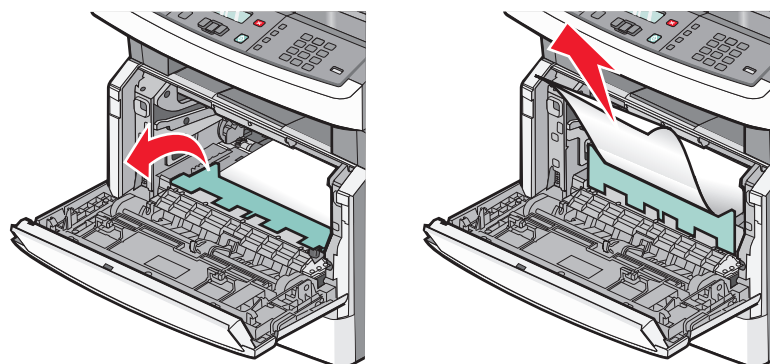

5 Insert the photoconductor kit and toner cartridge.

6 Close the front door.

7 Press .

202 paper jam

 **CAUTION—HOT SURFACE:** The fuser and the inside of the printer near the fuser may be hot. To reduce the risk of injury from a hot component, allow the surface to cool before removing paper from this area.

1 Open the front door, and then remove the photoconductor kit and toner cartridge.

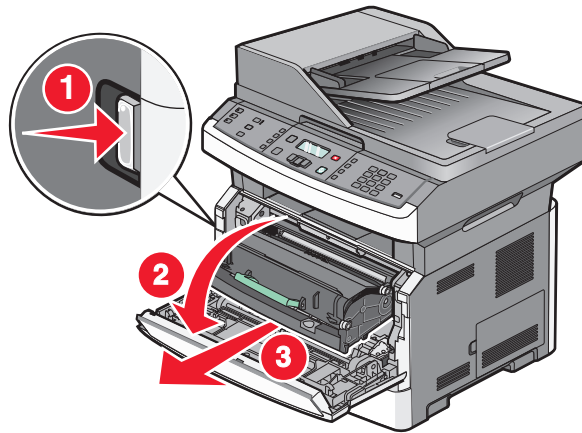

2 Lift the flap in front of the printer, and then remove any jammed sheets.

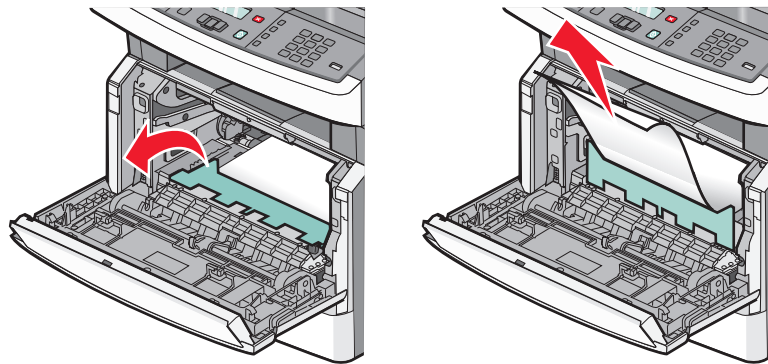

3 If you do not see any jammed sheets, open the rear door.

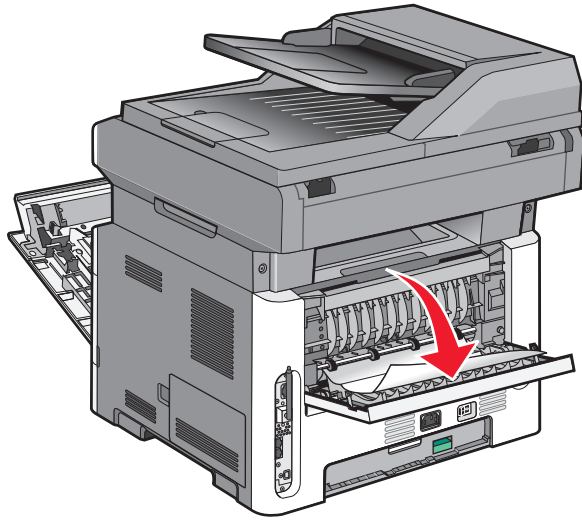

4 Remove the jam.

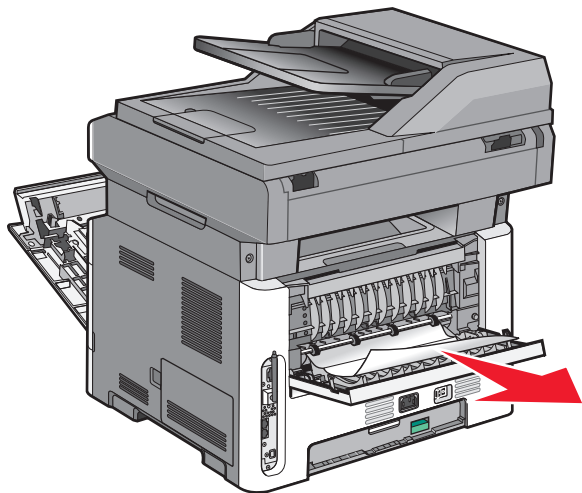

5 Close the rear door.

6 Insert the photoconductor kit and toner cartridge.

7 Close the front door.

8 Press .

231 paper jam

CAUTION—HOT SURFACE: The fuser and the inside of the printer near the fuser may be hot. To reduce the risk of injury from a hot component, allow the surface to cool before removing paper from this area.

- 1 Open the front door.

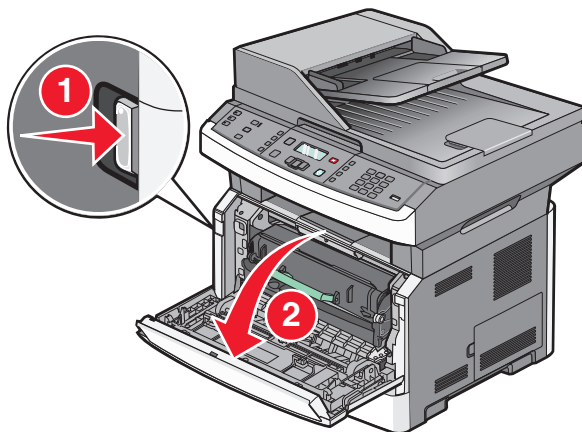

- 2 Open the rear door.
- 3 Remove the jam.

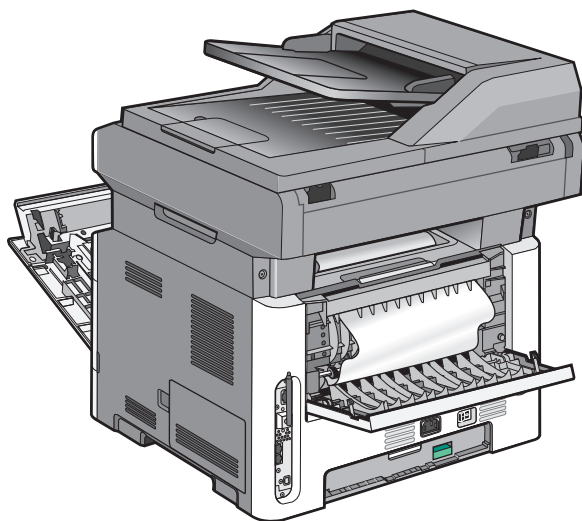

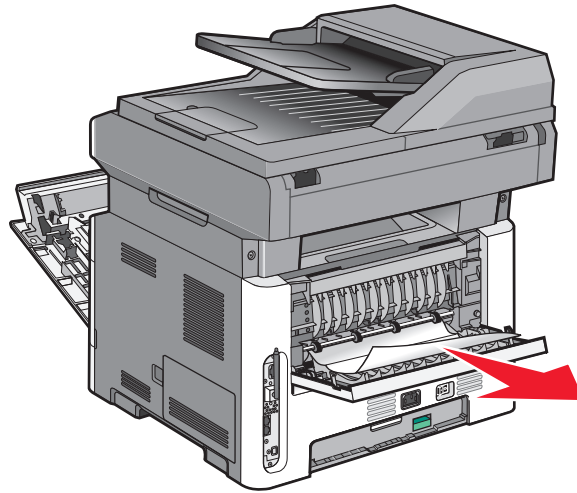

- 4 Close the rear door.
- 5 Close the front door.
- 6 Press .

233 paper jam

- 1 Remove the tray from the printer.

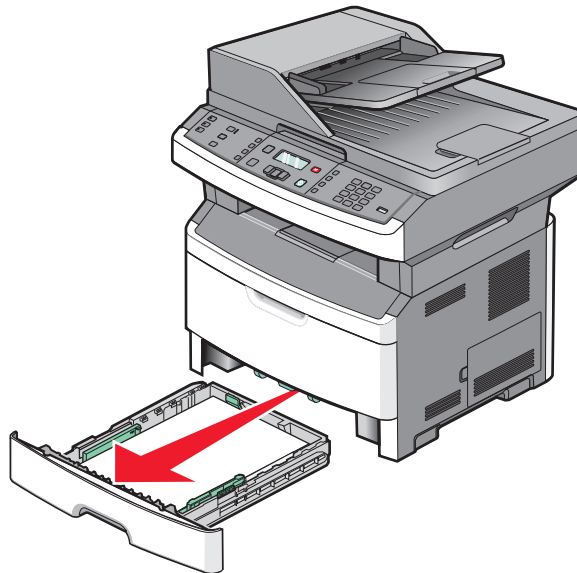

- 2 Locate the lever shown, and then pull it down to release and remove the jammed sheets.

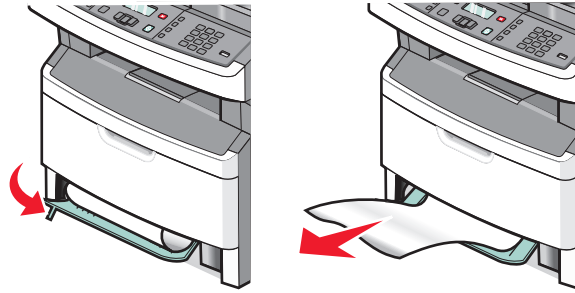

- 3 Insert the tray.

- 4 Press .

If this does not clear the jam, complete the steps in “231 paper jam” on page 166.

234 paper jam

A single jam or multiple jams are in the duplex area of the printer. To locate and remove the jammed sheets, complete all the steps in:

- “231 paper jam” on page 166
- “233 paper jam” on page 167

235 paper jam

- 1 Gently pull the jammed sheet out of the standard exit bin.

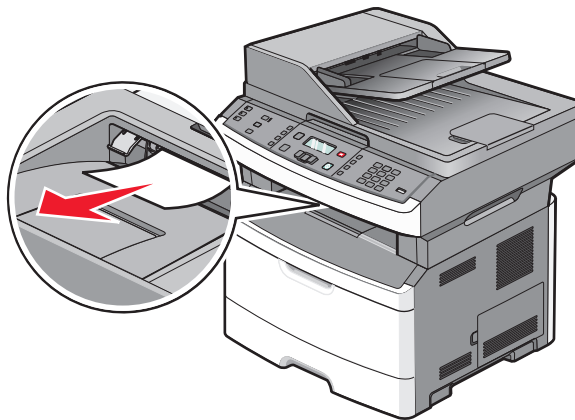

- 2 Press .

242 paper jam

- 1 Remove the optional tray from the printer.

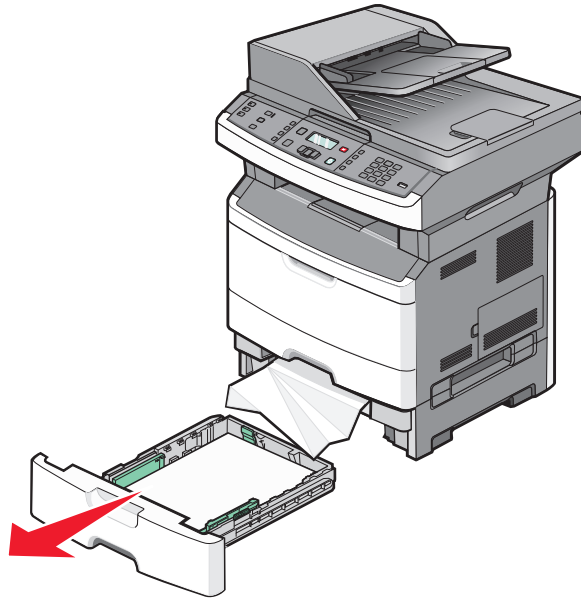

- 2 Remove the jam.



- 3 Insert the tray.

- 4 Press .

251 paper jam

A sheet of paper failed to feed from the multipurpose feeder. If it is visible, gently pull the jammed sheet out.

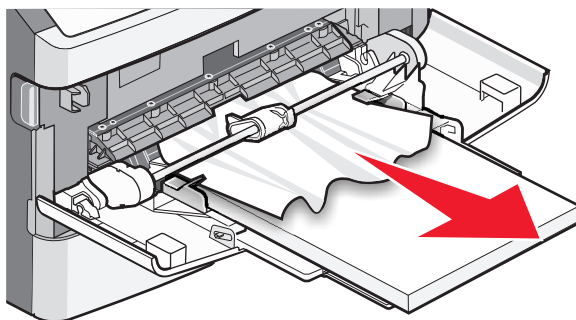

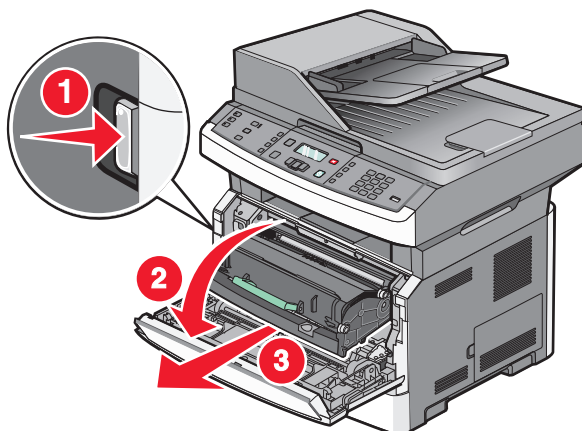

If the sheet is not visible, complete the following steps:

- 1 Open the front door, and then remove the photoconductor kit and toner cartridge.

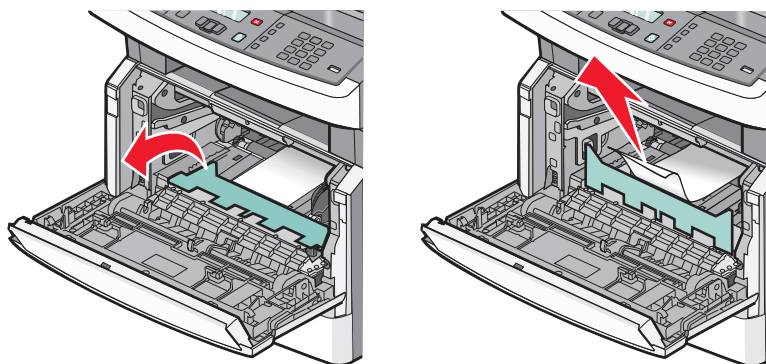

- 2 Lift the flap at the front of the printer, and then remove any jams.



- 3 Reinsert the photoconductor kit and toner cartridge.
- 4 Close the front door.
- 5 Press .

290–294 paper jams

Clearing jams under the ADF cover

- 1 Remove all original documents from the ADF.
- 2 Open the ADF cover.

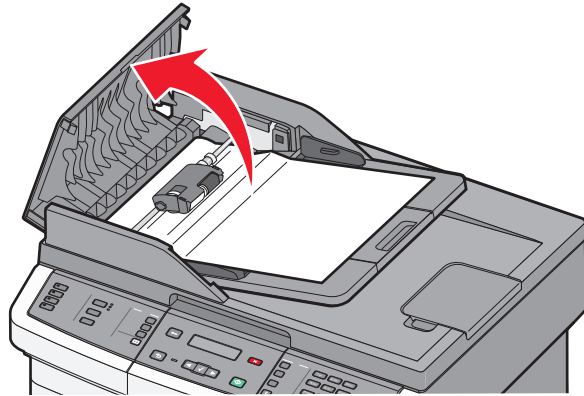

- 3 Unlock the separator roll.

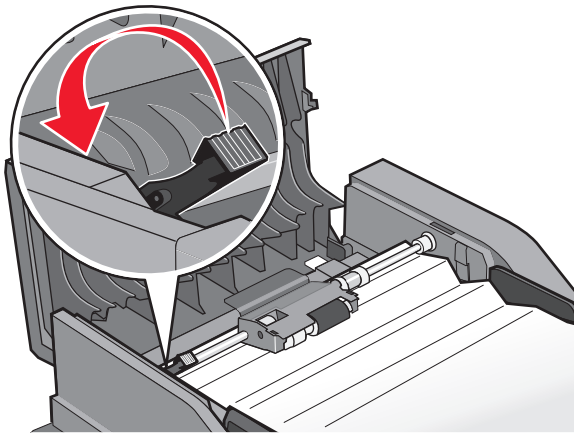

4 Remove the separator roll.

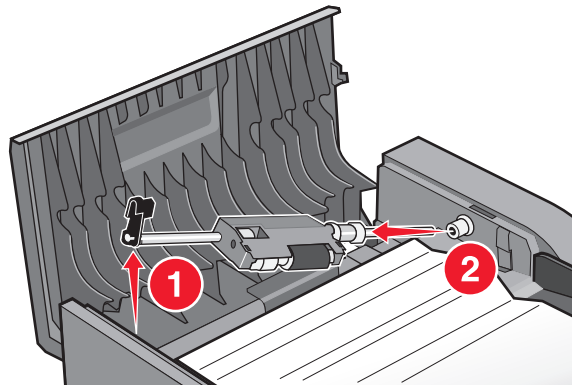

5 Remove the jammed paper.

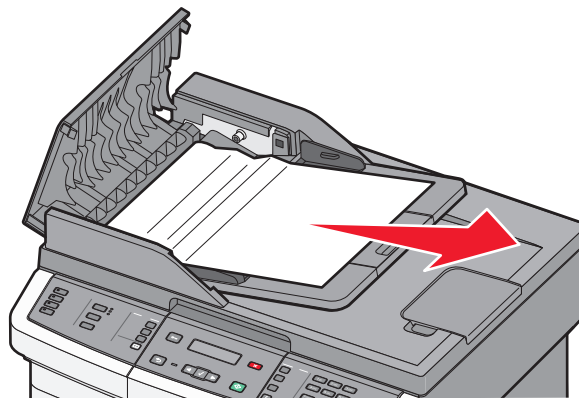

6 Reinstall the separator roll.

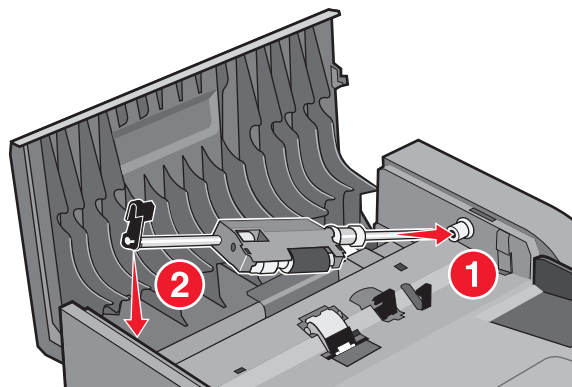

7 Lock the separator roll.

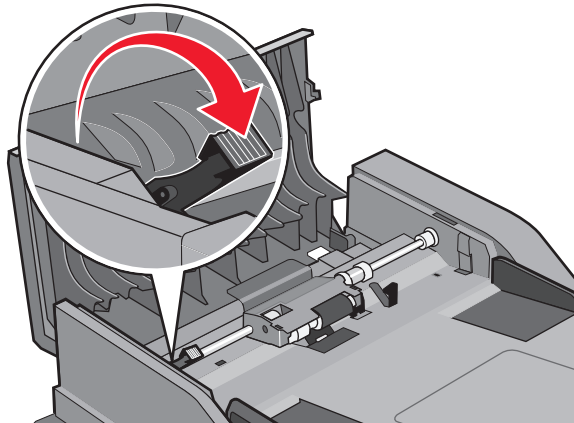

8 Close the ADF cover.

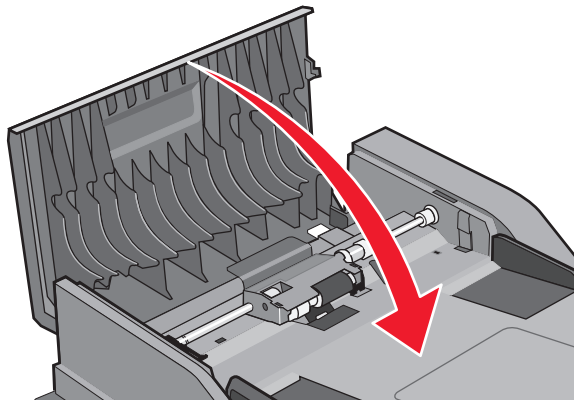

9 Press .

Clearing ADF jams by lifting the scanner cover

- 1 Open the scanner cover, and then remove any jammed pages.

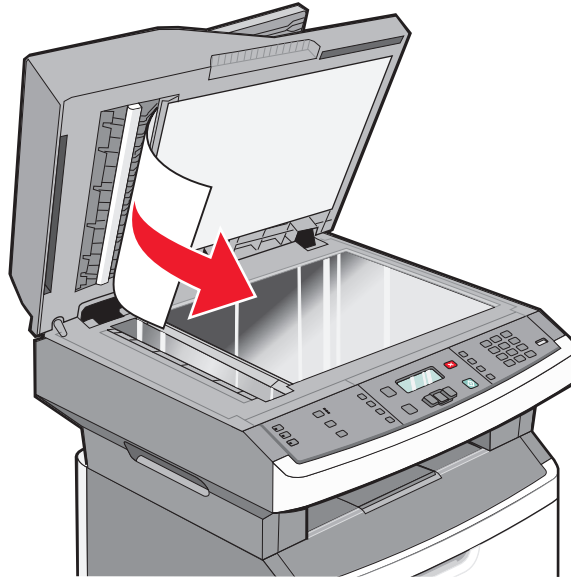

- 2 Press .

Clearing ADF duplex jams

If you are making a two-sided copy in the ADF, and your original document jams, it may be necessary to perform the following steps to clear the jam:

- 1 Remove the ADF tray.

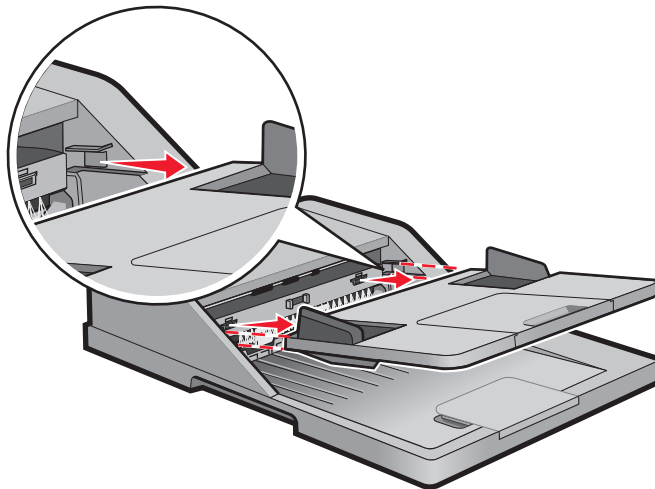

- 2 Remove the jammed paper by pulling the lower edge of the sheet exiting the ADF.

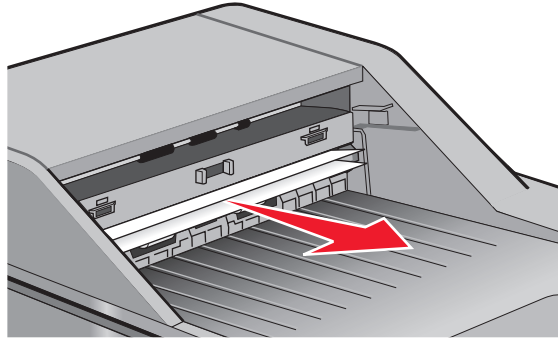

- 3 Reinstall the ADF tray.

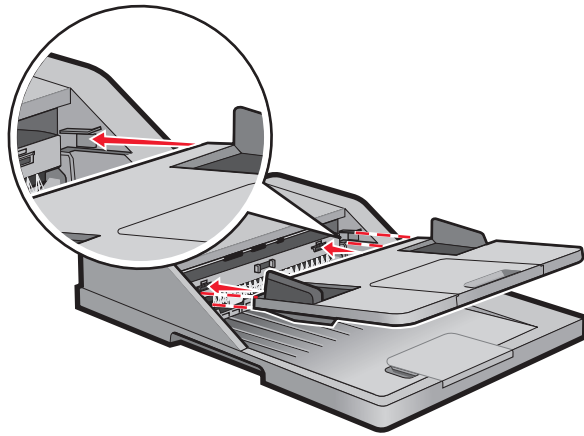

- 4 Press .

Troubleshooting

Solving basic printer problems

If there are basic printer problems, or the printer is unresponsive, make sure:

- The power cord is plugged into the printer and a properly grounded electrical outlet.
- The electrical outlet is not turned off by any switch or breaker.
- The printer is not plugged into any surge protectors, uninterruptible power supplies, or extension cords.
- Other electronic equipment plugged into the outlet is working.
- The printer is turned on. Check the printer power switch.
- The printer cable is securely attached to the printer and the host computer, print server, option, or other network device.
- All options are properly installed.
- The printer driver settings are correct.

Once you have checked each of these possibilities, turn the printer off, wait for about 10 seconds, and then turn the printer back on. This often fixes the problem.

Printer control panel display is blank or displays only diamonds

The printer self test failed. Turn the printer off, wait about 10 seconds, and then turn the printer back on.

If **Performing Self Test** and **Ready** do not appear, turn the printer off and contact Customer Support.

Understanding printer messages

Answering

The printer is answering a fax call. Wait for the message to clear.

Call complete

A fax call is completed. Wait for the message to clear.

Close front door

Close the front door of the printer.

Defragmenting Flash DO NOT POWER OFF

Wait for the message to clear.

Warning—Potential Damage: Do not turn the printer off while this message appears on the display.

DO NOT TOUCH Reading flash data DO NOT POWER OFF

As a part of this message, a bar graphic appears on one line of the display, indicating the percentage of processing time completed.

Wait for the message to clear. The message displays until all code is received and the processing is complete.

Warning—Potential Damage: If your printer is connected to a computer by a USB cable, do not touch the printer control panel while this message appears on the display. Do not turn the printer off while this message appears.

Fax failed

The fax failed to be sent. Wait for the message to clear.

Fax Station Name not set up

The Fax Station Name has not been entered. Sending and receiving faxes is disabled until fax is configured properly.

Try one or more of the following:

- Press the arrow buttons until **Continue** appears, and then press  to clear the message.
- Enter the Fax Station Name, which can be done in the Settings menu under General Fax Settings or Analog Fax Setup. If the message appears again, then contact your system support person.

Fax Station Number not set up

The Fax Station Number has not been entered. Sending and receiving faxes is disabled until fax is configured properly.

Try one or more of the following:

- Press the arrow buttons until **Continue** appears, and then press  to clear the message.
- Complete the Analog Fax Setup. If the message appears again, contact your system support person.

Formatting Flash DO NOT POWER OFF

Wait for the message to clear.

Warning—Potential Damage: Do not power off while the printer is formatting the flash memory.

Hex Trace

The printer is in Hex Trace mode.

Invalid Engine Code

You need to download valid engine code for the printer.

Note: Engine code may be downloaded while this message appears on the display.

Invalid Network Code

You need to download valid network printing code for the internal print server. The internal print server is a hardware option installed inside the printer.

Note: Network code may be downloaded while this message appears on the display.

Line busy

A fax number is dialed, but the fax line is busy. Wait for the message to clear.

Load manual feeder with <x>

Try one or more of the following:

- Load the specified paper in the multipurpose feeder.
- Cancel the current job.

Load <src> with <x>

Try one or more of the following:

- Load the tray or other source with the correct paper type and size.
- Cancel the current job.

Memory full, cannot send faxes

The printer fax memory is full. Press  to clear the message and cancel the fax.

- Reduce the fax resolution and try to send the fax again.
- Reduce the number of pages in the fax and try to send the fax again.

Network/Network <x>

The printer is connected to the network.

Network indicates that the printer is using the standard network port built into the printer system board. **Network <x>** indicates that an internal print server is installed inside the printer or that the printer is connected to an external print server.

No analog phone line

The analog phone line was not detected; the fax is disabled. Connect the printer to an analog phone line.

No answer

A fax number is dialed, but no connection is made. Wait for the message to clear.

No dial tone

The printer does not have a dial tone. Wait for the message to clear.

Power Saver

The printer is saving power while it waits for the next print job. Send a job to print to take the printer out of Power Saver mode.

Programming Engine Code DO NOT POWER OFF

Wait for the message to clear.

Warning—Potential Damage: Do not turn the printer power off while **Programming Engine Code** appears on the display.

Programming flash DO NOT POWER OFF

Wait for the message to clear.

Warning—Potential Damage: Do not turn the printer power off while **Programming flash** appears on the display.

Programming System Code DO NOT POWER OFF

Wait for the message to clear.

Warning—Potential Damage: Do not turn the printer power off while **Programming System Code** appears on the display.

Queued for sending

The scanning process of a fax job completed, but the job is not sent yet because another fax job is being sent or received. Wait for the message to clear.

Remove packaging material, check <x>

Remove any remaining packaging material from the specified location.

Remove paper from standard output bin

Remove the stack of paper from the standard exit bin.

Scanner ADF Cover Open

The ADF cover is open. The message clears when the cover is closed.

Scanner Jam Access Cover Open

Close the bottom ADF door to clear the message.

Toner is low

Try one or more of the following:

- Replace the toner cartridge.
- Press  to clear the message and continue printing.

Unsupported USB device, please remove

Remove the unrecognized USB device.

Unsupported USB hub, please remove

Remove the unrecognized USB hub.

Some USB flash drives have a built-in USB hub, and these flash drives are not supported.

USB/USB <x>

The printer is using a USB cable connection. The USB port is the active communication link.

Waiting

The printer has received data to print, but is waiting for an End-of-Job command, a Form Feed command, or additional data.

- Press  to print the contents of the buffer.
- Cancel the current print job.

Waiting for redial

The printer is waiting to redial the fax number. Wait for the message to clear.

31.yy Replace defective or missing cartridge

The toner cartridge is either missing or not functioning properly.



Try one or more of the following:

- Remove the toner cartridge, and then reinstall it.
- Remove the toner cartridge, and then install a new one.

34 Short paper

The printer paper size setting did not match the length of the paper that entered the printer.

Try one or more of the following:

- Press  to clear the message and continue printing.
- Press , and then press  to cancel printing.
- Make sure the paper size setting matches the size of the paper in the tray.

35 Insufficient memory to support Resource Save feature

The printer lacks sufficient memory to save settings. Install additional memory, or press  to disable Resource Save and continue printing.

37 Insufficient memory for Flash Memory Defragment operation

Try one or more of the following:

- Press the arrow buttons until **Continue** appears, and then press  to stop the defragment operation and continue printing.
- Delete fonts, macros, and other data in printer memory.
- Install additional printer memory.

37 Insufficient memory to collate job

Try one or more of the following:

- Press the arrow buttons until **Continue** appears, and then press  to print the portion of the job already stored and begin collating the rest of the print job.
- Cancel the current print job.

38 Memory full

Try one or more of the following:

- Press the arrow buttons until **Continue** appears, and then press  to clear the message.
- Cancel the current print job.

39 Complex page, some data may not have printed

Try one or more of the following:

- Press the arrow buttons until **Continue** appears, and then press  to clear the message and continue printing.
- Cancel the current print job.

51 Defective flash detected

Try one or more of the following:

- Replace the defective flash memory card.
- Press the arrow buttons until **Continue** appears, and then press  to clear the message and continue printing.

52 Not enough free space in flash memory for resources

Try one or more of the following:

- Press the arrow buttons until **Continue** appears, and then press  to stop the defragment operation and continue printing.
Downloaded fonts and macros not previously stored in flash memory are deleted.
- Delete fonts, macros, and other data stored in flash memory.
- Upgrade to a larger capacity flash memory card.

53 Unformatted flash detected

Try one or more of the following:

- Press the arrow buttons until **Continue** appears, and then press  to continue printing.
- Format the flash memory. If the error message remains, the flash memory may be defective and require replacing.

54 Network <x> software error

The printer detects that a network port is installed, but cannot communicate with it. The printer disables all communication to the associated network interface.

Try one or more of the following:

- Press  to clear the message and continue printing.
- Turn the power off and then back on to reset the printer.
- Upgrade (flash) the network firmware in the printer or print server.

54 Standard network software error

Try one or more of the following:

- Press the arrow buttons until **Continue** appears, and then press  to continue printing.
- Turn the printer off and then back on to reset the printer.
- Upgrade (flash) the network firmware in the printer or print server.

56 Standard USB port disabled

Try one or more of the following:

- The printer discards any data received through the USB port. Press  to clear the message and continue printing.
- Make sure the USB Buffer menu item is not set to Disabled.

58 Too many flash options installed

Try one or more of the following:

- Turn the printer off, and then remove extra flash options:
 - 1 Turn the printer off.
 - 2 Unplug the power cord from the wall outlet.

- 3 Remove the excess flash memory.
 - 4 Connect the power cord to a properly grounded outlet.
 - 5 Turn the printer back on.
- Press  to clear the message and continue printing.

58 Too many trays attached

- 1 Turn the printer off.
- 2 Unplug the power cord from the wall outlet.
- 3 Remove the additional trays.
- 4 Connect the power cord to a properly grounded outlet.
- 5 Turn the printer back on.

84 PC Kit life warning

The photoconductor kit is near exhaustion.

Try one or more of the following:

- Replace the photoconductor kit.
- Press  to clear the message and continue printing.

84 Replace PC Kit

The photoconductor kit is exhausted. Install a new photoconductor kit.

88.yy Cartridge is low

Replace the toner cartridge, and then press  to clear the message and continue printing.

200.yy Paper jam

The message indicates either where the paper is jammed or the number of pages jammed.

- 1 To access the jam, try one or more of the following:
 - Remove Tray 1.
 - Open the front door, and then remove the photoconductor kit and toner cartridge.
- 2 Remove the jam.
- 3 Replace the photoconductor kit and toner cartridge if you removed it.
- 4 Close any open doors or trays.
- 5 Press  to continue printing.

201.yy Paper jam

The message indicates either where the paper is jammed or the number of pages jammed.

- 1 Open the front door, and then remove the photoconductor kit and toner cartridge unit.
- 2 Remove the jam.
- 3 Replace the photoconductor kit and toner cartridge unit.
- 4 Close the front door.
- 5 Press  to continue printing.

202.yy Paper jam

The message indicates either where the paper is jammed or the number of pages jammed.

- 1 Open the front door.
- 2 Open the rear door.
- 3 Remove the jam.
- 4 Close both doors.
- 5 Press  to continue printing.

231.yy Paper jam

The message indicates either where the paper is jammed or the number of pages jammed.

- 1 Open the front door.
- 2 Open the rear door.
- 3 Remove the jam.
- 4 Close both doors.
- 5 Press  to continue printing.

233.yy Paper jam

The message indicates either where the paper is jammed or the number of pages jammed.

- 1 To access the jam, try one or more of the following:
 - Remove Tray 1, and then depress the lever.
 - Open the front door, and then open the rear door.
- 2 Remove the jam.
- 3 Close any open doors or trays.
- 4 Press  to continue printing.

234.yy Paper jam

The message indicates either where the paper is jammed or the number of pages jammed.

- 1 To access the jam, try one or more of the following:
 - Open the front door, and then open the rear door.
 - Remove Tray 1, and then depress the lever.
- 2 Remove the jam.
- 3 Close any open doors or trays.
- 4 Press  to continue printing.

235.yy Paper jam

The message indicates either where the paper is jammed or the number of pages jammed.

- 1 Remove the jam from the standard exit bin.
- 2 Check the paper size to ensure that it is supported by the printer.
- 3 Press  to continue printing.

24x.yy Paper jam

The message indicates either where the paper is jammed or the number of pages jammed.

- 1 To access the jam, try one or more of the following:
 - Remove Tray 1.
 - Open the front door, and then remove the photoconductor kit and toner cartridge.
 - Remove Tray 2.
- 2 Remove the jam.
- 3 Replace the photoconductor kit and toner cartridge if you removed them.
- 4 Close any open doors or trays.
- 5 Press  to continue printing.

251.yy Paper jam

The message indicates either where the paper is jammed or the number of pages jammed.

- 1 Remove the jam from the multipurpose feeder.
- 2 Press  to continue printing.

290–292 ADF Scanning Jams

The scanner failed to feed one or more pages through the ADF.

- 1 Remove all pages from the ADF.

Note: The message clears when the pages are removed from the ADF.

- 2 Flex and fan the pages.
- 3 Place the pages in the ADF.
- 4 Adjust the ADF guides.
- 5 From the printer control panel, press .

293 Paper Missing

The scanner was instructed to scan using the ADF, but there is no paper in the ADF.

Note: The message clears when the pages are placed in the ADF.

- 1 Flex and fan the pages.
- 2 Place the pages in the ADF.
- 3 Adjust the ADF guides.
- 4 From the printer control panel, press .

293.02 Flatbed Cover Open

Close the scanner cover.

294 ADF Jam

This jam location may also be identified as **294.04 Duplex Sensor Off Jam**, **294.05 Scan Sensor Off Jam**, or **294.06 ADF Backfeed Jam**. To clear this jam:

- 1 Remove all pages from the ADF.

Note: The message clears when the pages are removed from the ADF.

- 2 Flex and fan the pages.
- 3 Place the pages in the ADF.
- 4 Adjust the ADF guides.
- 5 From the printer control panel, press .

840.01 Scanner Disabled

This message indicates that the scanner has been disabled by the system support person.

840.02 Scanner Auto Disabled

This message indicates the printer identified a problem with the scanner and automatically disabled it.

- 1 Remove all pages from the ADF.
- 2 Turn the printer off.
- 3 Wait 15 seconds, and then turn the printer on.
- 4 Place the document in the ADF.
- 5 Press .

Note: If turning the printer off and then on again does not clear the message, then contact your system support person.

Solving printing problems

Jobs do not print

These are possible solutions. Try one or more of the following:

MAKE SURE THE PRINTER IS READY TO PRINT

Make sure **Ready** or **Power Saver** appears on the display before sending a job to print.

CHECK TO SEE IF THE STANDARD EXIT BIN IS FULL

Remove the stack of paper from the standard exit bin.

CHECK TO SEE IF THE PAPER TRAY IS EMPTY

Load paper in the tray.

MAKE SURE THE CORRECT PRINTER SOFTWARE IS INSTALLED

- Verify that you are using the correct printer software.
- If you are using a USB port, make sure you are running a supported operating system and using compatible printer software.

MAKE SURE THE INTERNAL PRINT SERVER IS INSTALLED PROPERLY AND WORKING

- Make sure the internal print server is properly installed and that the printer is connected to the network. For more information about installing a network printer, click **View User's Guide and Documentation** on the *Software and Documentation* CD.
- Print a network setup page and check that the status shows **Connected**. If the status is **Not Connected**, check the network cables, and then try printing the network setup page again. Contact your system support person to make sure the network is functioning correctly.

Copies of the printer software are also available on the Lexmark Web site at www.lexmark.com.

MAKE SURE YOU ARE USING A RECOMMENDED PRINTER CABLE

For more information, visit the Lexmark Web site at www.lexmark.com.

MAKE SURE PRINTER CABLES ARE SECURELY CONNECTED

Check the cable connections to the printer and print server to make sure they are secure.

For more information, see the setup documentation that came with the printer.

Multiple-language PDFs do not print

The documents contain unavailable fonts.

- 1 Open the document you want to print in Adobe Acrobat.
- 2 Click the printer icon.
The Print dialog appears.
- 3 Click **Advanced**.
- 4 Select **Print as image**.
- 5 Click **OK** twice.







Job takes longer than expected to print

These are possible solutions. Try one or more of the following:

REDUCE THE COMPLEXITY OF THE PRINT JOB

Reduce the number and size of fonts, the number and complexity of images, and the number of pages in the job.

CHANGE THE PAGE PROTECT SETTING TO OFF

- 1 From the printer control panel, press .
- 2 Press the arrow buttons until **Settings** appears, and then press .
- 3 Press the arrow buttons until **General Settings** appears, and then press .
- 4 Press the arrow buttons until **Print Recovery** appears, and then press .
- 5 Press the arrow buttons until **Page Protect** appears, and then press .
- 6 Press the arrow buttons until **Off** appears, and then press .

CHANGE ENVIRONMENTAL SETTINGS

When using Eco-Mode or Quiet Mode settings, you may notice a short delay before the first page is printed. If you want to change the settings and need more information, then see “Using Eco-Mode” on page 35 or “Reducing printer noise” on page 37.

Job prints from the wrong tray or on the wrong paper

CHECK THE PAPER TYPE SETTING

Make sure the Paper Type setting matches the paper loaded in the tray.

Incorrect characters print

Make sure the printer is not in Hex Trace mode. If **Ready Hex** appears on the display, you must exit Hex Trace mode before you can print your job. Turn the printer off and back on to exit Hex Trace mode.

Tray linking does not work

LOAD THE SAME SIZE AND TYPE OF PAPER IN EACH TRAY

- 1 Load the same size and type of paper in each tray.
- 2 Move the paper guides to the correct positions for the paper size loaded in each tray.

MAKE SURE THE PAPER SIZE AND PAPER TYPE SETTINGS ARE THE SAME FOR EACH TRAY

- 1 Print a menu settings page and compare the settings for each tray.
- 2 If necessary, adjust the settings from the Paper Size/Type menu.

Note: None of the paper sources, trays, or feeders automatically sense the paper size. You must set the size from the Paper Size/Type menu on the printer control panel or from the Embedded Web Server.

Large jobs do not collate

These are possible solutions. Try one or more of the following:

MAKE SURE COLLATE IS SET TO ON

From Print Properties or the printer control panel Finishing menu, set Collate to On.



Note: Setting Collate to Off in the software overrides the setting in the Finishing menu.

REDUCE THE COMPLEXITY OF THE PRINT JOB

Reduce the complexity of the print job by reducing the number and size of fonts, the number and complexity of images, and the number of pages in the job.

Unexpected page breaks occur

Increase the Print Timeout value:

- 1 From the printer control panel, press .
- 2 Press the arrow buttons until **Settings** appears, and then press .

- 3 Press the arrow buttons until **General Settings** appears, and then press ✓.
- 4 Press the arrow buttons until **Timeouts** appears, and then press ✓.
- 5 Press the arrow buttons until **Print Timeout** appears, and then press ✓.
- 6 Press the arrow buttons until the value you want appears, and then press ✓.

Solving copy problems

Copier does not respond

These are possible solutions. Try one or more of the following:

CHECK THE DISPLAY FOR ERROR MESSAGES

Clear any error messages.

CHECK THE POWER

Make sure the printer is plugged in, the power is on, and **Ready** appears.

Scanner unit does not close

Make sure there are no obstructions:

- 1 Open the scanner cover.
- 2 Remove any obstruction keeping the scanner unit open.
- 3 Close the scanner cover.

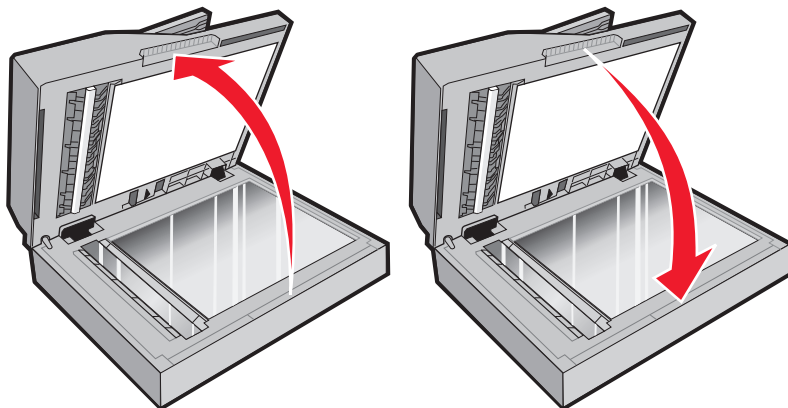

Poor copy quality

These are some examples of poor copy quality:

- Blank pages
- Checkerboard pattern

- Distorted graphics or pictures
- Missing characters
- Faded print
- Dark print
- Skewed lines
- Smudges
- Streaks
- Unexpected characters
- White lines in print

These are possible solutions. Try one or more of the following:

CHECK THE DISPLAY FOR ERROR MESSAGES

Clear any error messages.

THE TONER MAY BE LOW

When **88 Cartridge low** appears or when the print becomes faded, replace the toner cartridge.

THE SCANNER GLASS MAY BE DIRTY

Clean the scanner glass with a clean, lint-free cloth dampened with water. If your printer has an ADF, be sure to clean the ADF scanner glass as well. For more information, see: "Cleaning the scanner glass" on page 146.

THE COPY IS TOO LIGHT OR TOO DARK

Adjust the copy darkness setting.

CHECK THE QUALITY OF THE ORIGINAL DOCUMENT

Make sure the quality of the original document is satisfactory.

CHECK THE DOCUMENT PLACEMENT

- Make sure the document or photo is loaded facedown on the scanner glass in the upper left corner.
- If you previously loaded your original document into the ADF, try loading it on the scanner glass.

UNWANTED TONER IS IN THE BACKGROUND

- Adjust the darkness to a lighter setting.
- Change the **Background Removal** setting in the **Copy Settings** menu.

PATTERNS (MOIRÉ) APPEAR IN THE OUTPUT

- From the printer control panel, press the **Content** button until the light comes on next to Text/Photo.
- Rotate the original document on the scanner glass.
- From the printer control panel, press the **Scale** button and adjust the setting.

TEXT IS LIGHT OR DISAPPEARING

From the printer control panel, press the **Content** button until the light comes on next to Text or Text/Photo.

THE OUTPUT APPEARS WASHED OUT OR OVEREXPOSED

- From the printer control panel, press the **Content** button until the light comes on next to Text/Photo or Photo.
- From the printer control panel, press the **Darkness** button and change to a darker setting.

THE PRINT IS SKEWED

Notes:

- If you are loading your original document in the ADF, adjust the ADF paper guides so they touch the edges of the pages to be scanned.
- Check the paper trays to make sure the guides touch the edges of the loaded paper.

Partial document or photo copies

These are possible solutions. Try one or more of the following:

CHECK THE DOCUMENT PLACEMENT

Make sure the document or photo is loaded facedown on the scanner glass in the upper left corner.

CHECK THE PAPER SIZE SETTING

Make sure the Paper Size setting matches the paper loaded in the tray.

Unable to pause print job to make copies

Make sure "Allow priority copies" is set to On in the Copy Settings menu.

Solving scanner problems

Checking an unresponsive scanner

If your scanner is not responding, then make sure:

- The printer is turned on.
- The printer cable is securely attached to the printer and the host computer, print server, option, or other network device.
- The power cord is plugged into the printer and a properly grounded electrical outlet.
- The electrical outlet is not turned off by any switch or breaker.
- The printer is not plugged into any surge protectors, uninterrupted power supplies, or extension cords.
- Other electrical equipment plugged into the outlet is working.

Once you have checked each of these possibilities, turn the printer off and then back on. This often fixes the problem with the scanner.

Scan was not successful

These are possible solutions. Try one or more of the following:

CHECK THE CABLE CONNECTIONS

Make sure the network or USB cable is securely connected to the computer and the printer.

AN ERROR MAY HAVE OCCURRED IN THE PROGRAM

Turn off and then restart the computer.

Scanning takes too long or freezes the computer

These are possible solutions. Try one or more of the following:

OTHER SOFTWARE PROGRAMS MAY BE INTERFERING WITH SCANNING

Close all programs not being used.

THE SCAN RESOLUTION MAY BE SET TOO HIGH

Select a lower scan resolution.

Poor scanned image quality

These are possible solutions. Try one or more of the following:

CHECK THE DISPLAY FOR ERROR MESSAGES

Clear any error messages.

THE SCANNER GLASS MAY BE DIRTY

Clean the scanner glass with a clean, lint-free cloth dampened with water. For more information, see “Cleaning the scanner glass” on page 146.

ADJUST THE SCAN RESOLUTION

Increase the resolution of the scan for a higher quality output.

CHECK THE QUALITY OF THE ORIGINAL DOCUMENT

Make sure the quality of the original document is satisfactory.

CHECK THE DOCUMENT PLACEMENT

Make sure the document or photo is loaded facedown on the scanner glass in the upper left corner.

Partial document or photo scans

These are possible solutions. Try one or more of the following:

CHECK THE DOCUMENT PLACEMENT

Make sure the document or photo is loaded facedown on the scanner glass in the upper left corner.

CHECK THE PAPER SIZE SETTING

Make sure the paper size setting matches the paper loaded in the tray:

- 1 From the printer control panel Paper menu, check the Paper Size setting.
- 2 Before sending the job to print, specify the correct size setting:
 - For Windows users, specify the size from Print Properties.
 - For Macintosh users, specify the size from the Page Setup or Print dialog.

Cannot scan from a computer

These are possible solutions. Try one or more of the following:

CHECK THE DISPLAY FOR ERROR MESSAGES

Clear any error messages.

CHECK THE POWER

Make sure the printer is plugged in, the power is on, and **Ready** appears.

CHECK THE CABLE CONNECTIONS

Make sure the network or USB cable is securely connected to the computer and the printer.

Solving fax problems

Caller ID is not shown

Contact your telecommunications company to verify that your telephone line is subscribed to the caller ID service.

If your region supports multiple caller ID patterns, you may have to change the default setting. There are two settings available: FSK (pattern 1) and DTMF (pattern 2). The availability of these settings by way of the Fax menu depends on whether your country or region supports multiple caller ID patterns. Contact your telecommunications company to determine which pattern or switch setting to use.

Cannot send or receive a fax

These are possible solutions. Try one or more of the following:

CHECK THE DISPLAY FOR ERROR MESSAGES

Clear any error messages.

CHECK THE POWER

Make sure the printer is plugged in, the power is on, and **Ready** appears.

CHECK THE PRINTER CONNECTIONS

Make sure the cable connections for the following hardware are secure, if applicable:

- Telephone
- Handset
- Answering machine

CHECK THE TELEPHONE WALL JACK

- 1 Plug a telephone into the wall jack.
- 2 Listen for a dial tone.
- 3 If you do not hear a dial tone, then plug a different telephone into the wall jack.
- 4 If you still do not hear a dial tone, then plug a telephone into a different wall jack.
- 5 If you hear a dial tone, then connect the printer to that wall jack.

REVIEW THIS DIGITAL PHONE SERVICE CHECKLIST

The fax modem is an analog device. Certain devices can be connected to the printer so that digital telephone services can be used.

- If you are using an ISDN telephone service, then connect the printer to an analog telephone port (an R-interface port) on an ISDN terminal adapter. For more information and to request an R-interface port, contact your ISDN provider.
- If you are using DSL, then connect to a DSL filter or router that will support analog use. For more information, contact your DSL provider.
- If you are using a PBX telephone service, then make sure you are connecting to an analog connection on the PBX. If none exists, consider installing an analog telephone line for the fax machine.

CHECK FOR A DIAL TONE

- Place a test call to the telephone number to which you want to send a fax to make sure that it is working correctly.
- If the telephone line is being used by another device, then wait until the other device is finished before sending a fax.
- If you are using the On Hook Dial feature, then turn up the volume to verify a dial tone.

TEMPORARILY DISCONNECT OTHER EQUIPMENT

To ensure the printer is working correctly, connect it directly to the telephone line. Disconnect any answering machines, computers with modems, or telephone line splitters.

CHECK FOR JAMS

Clear any jams, and then make sure that **Ready** appears.

TEMPORARILY DISABLE CALL WAITING

Call Waiting can disrupt fax transmissions. Disable this feature before sending or receiving a fax. Call your telephone company to obtain the keypad sequence for temporarily disabling Call Waiting.

VOICE MAIL SERVICE MAY BE INTERFERING WITH THE FAX TRANSMISSION

Voice Mail offered through your local telephone company may disrupt fax transmissions. To enable both Voice Mail and the printer to answer calls, you may want to consider adding a second telephone line for the printer.

THE PRINTER MEMORY MAY BE FULL

- 1 Dial the fax number.
- 2 Scan the original document one page at a time.

Can send but not receive faxes

These are possible solutions. Try one or more of the following:

CHECK TO SEE IF THE PAPER TRAY IS EMPTY

Load paper in the tray.

CHECK THE RING COUNT DELAY SETTINGS

The ring count delay sets the number of times the phone line rings before the printer answers. If you have extension phones on the same line as the printer, or subscribe to the telephone company's Distinctive Ring service, then keep the Ring Delay setting at 4.

- 1 Type the printer IP address into the address field of your Web browser.
Note: If you do not know the IP address of the printer, then print a network setup page and locate the IP address in the TCP/IP section.
- 2 Click **Settings**.
- 3 Click **Fax Settings**.
- 4 Click **Analog Fax Setup**.
- 5 In the Rings to Answer box, enter the number of times you want the phone to ring before answering.
- 6 Click **Submit**.

THE TONER MAY BE LOW

88 Cartridge low appears when the toner is low.

Can receive but not send faxes

These are possible solutions. Try one or more of the following:

MAKE SURE THE PRINTER IS IN FAX MODE

From the printer control panel, press the **Fax** button to put the printer in Fax mode.

MAKE SURE THE DOCUMENT IS LOADED PROPERLY

Load the original document faceup, short edge first into the ADF or facedown on the scanner glass in the upper left corner.

Note: Do not load postcards, photos, small items, transparencies, photo paper, or thin media (such as magazine clippings) into the ADF. Place these items on the scanner glass.

MAKE SURE THE SHORTCUT NUMBER IS SET UP PROPERLY

- Check to make sure the shortcut number has been programmed for the number that you want to dial.
- As an alternative, dial the telephone number manually.

Received fax has poor print quality

These are possible solutions. Try one or more of the following:

RE-SEND THE DOCUMENT

Ask the person who sent you the fax to:

- Check that the quality of the original document is satisfactory.
- Resend the fax. There may have been a problem with the quality of the telephone line connection.
- Increase the fax scan resolution, if possible.

THE TONER MAY BE LOW

When **88 Cartridge low** appears or when you experience faded print, replace the cartridge.

MAKE SURE THE FAX TRANSMISSION SPEED IS NOT SET TOO HIGH

Decrease the incoming fax transmission speed:

- 1 Type the printer IP address into the address field of your Web browser.

Note: If you do not know the IP address of the printer, then print a network setup page and locate the IP address in the TCP/IP section.

- 2 Click **Settings**.
- 3 Click **Fax Settings**.

- 4 Click **Analog Fax Setup**.
- 5 In the Max Speed box, click on one of the following:
 - 2400**
 - 4800**
 - 9600**
 - 14400**
 - 33600**
- 6 Click **Submit**.

Solving option problems

Option does not operate correctly or quits after it is installed

These are possible solutions. Try one or more of the following:

RESET THE PRINTER

Turn the printer off, wait for about 10 seconds, and then turn the printer on.

CHECK TO SEE IF THE OPTION IS CONNECTED TO THE PRINTER

- 1 Turn the printer off.
- 2 Unplug the printer.
- 3 Check the connection between the option and the printer.

MAKE SURE THE OPTION IS INSTALLED

Print a menu settings page and check to see if the option is listed in the Installed Options list. If the option is not listed, reinstall it.

MAKE SURE THE OPTION IS SELECTED

From the program you are using, select the option. Mac OS 9 users should make sure the printer is set up in the Chooser.

Drawers

These are possible solutions. Try one or more of the following:

MAKE SURE THE PAPER IS LOADED CORRECTLY

- 1 Pull the tray completely out.
- 2 Check for paper jams or misfeeds.

- 3 Make sure the guides are aligned against the edges of the paper.
- 4 Insert the tray.

RESET THE PRINTER

Turn the printer off, wait about 10 seconds, and then turn the printer on.

Flash memory card

Make sure the flash memory card is securely connected to the printer system board.

Solving paper feed problems

Paper frequently jams

These are possible solutions. Try one or more of the following:

CHECK THE PAPER

Use recommended paper and other specialty media. For more information, see “Paper and specialty media guidelines” on page 53.

MAKE SURE THERE IS NOT TOO MUCH PAPER IN THE TRAY OR FEEDER

Make sure the stack of paper you load does not exceed the maximum stack height indicated in the tray or on the multipurpose feeder.

CHECK THE GUIDES

Move the guides in the tray to the correct positions for the paper size loaded.

THE PAPER ABSORBED MOISTURE DUE TO HIGH HUMIDITY

- Load paper from a fresh package.
- Store paper in its original wrapper until you use it.

Paper jam message remains after jam is cleared

The paper path is not clear. Clear jammed paper from the entire paper path, and then press .

Page that jammed does not reprint after you clear the jam

In the Settings menu, Jam Recovery is set to Off. Set Jam Recovery to Auto or On:

- 1 Press .
- 2 Press the arrow buttons until **Settings** appears, and then press .

- 3 Press the arrow buttons until **General Settings** appears, and then press ✓.
- 4 Press the arrow buttons until **Print Recovery** appears, and then press ✓.
- 5 Press the arrow buttons until **Jam Recovery** appears, and then press ✓.
- 6 Press the arrow buttons until **On** or **Auto** appears, and then press ✓.

Solving print quality problems

The information in the following topics may help you solve print quality problems. If these suggestions still do not correct the problem, then contact Customer Support. You may have a printer part that requires adjustment or replacement.

Isolating print quality problems

To help isolate print quality problems, print the print quality test pages:

- 1 Turn the printer off.
- 2 Load paper.
- 3 From the printer control panel, hold down ✓ and the right arrow button while turning the printer on.
- 4 Release the buttons when **CONFIG MENU** appears.
- 5 Press the arrow buttons until **Prt Quality Pgs** appears, and then press ✓.
The print quality test pages print.
- 6 Press the arrow buttons until **Exit Config Menu** appears, and then press ✓.
Resetting the Printer appears briefly, and then **Ready** appears.

Blank pages

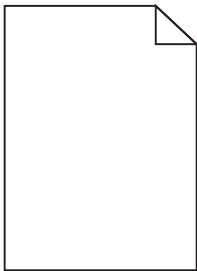

These are possible solutions. Try one or more of the following:

PACKING MATERIAL MAY BE ON THE TONER CARTRIDGE

Remove the toner cartridge and make sure the packing material is properly removed. Reinstall the toner cartridge.

THE TONER MAY BE LOW

When **88 Cartridge low** appears, order a new toner cartridge.

If the problem continues, the printer may need to be serviced. For more information, contact Customer Support.

Characters have jagged or uneven edges

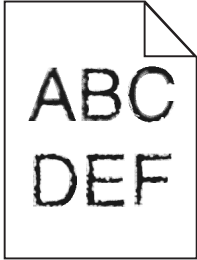

These are possible solutions. Try one or more of the following:

CHECK THE PRINT QUALITY SETTINGS

- Change the Print Resolution setting in the Quality menu to 600 dpi, 1200 Image Q, 1200 dpi, or 2400 Image Q.
- Enable Enhance Fine Lines in the Quality menu.

MAKE SURE DOWNLOADED FONTS ARE SUPPORTED

If you are using downloaded fonts, then verify that the fonts are supported by the printer, the host computer, and the software program.

Clipped images

These are possible solutions. Try one or more of the following:

CHECK THE GUIDES

Move the width and length guides in the tray to the correct positions for the paper size loaded.

CHECK THE PAPER SIZE SETTING

Make sure the paper size setting matches the paper loaded in the tray:

- 1 From the printer control panel Paper menu, check the Paper Size setting.
- 2 Before sending the job to print, specify the correct size setting:
 - For Windows users, specify the size from Print Properties.
 - For Macintosh users, specify the size from the Page Setup or Print dialog.

Gray background

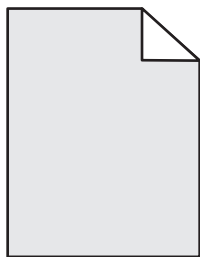

- For Windows users: From Print Properties, select a different Toner Darkness setting before sending the job to print.
- For Macintosh users: From the print options, Copies & Pages, or General pop-up menu, choose Printer Features, and then choose the setting needed from the Toner Darkness pop-up menu.
- From the printer control panel Quality menu, select a different Toner Darkness setting before sending the job to print.

Ghost images



These are possible solutions. Try one or more of the following:

THE PHOTOCONDUCTOR KIT IS DEFECTIVE

Replace the photoconductor kit.

CHECK THE MEDIA TYPE SETTING

- For Windows users: From Print Properties, make sure the Media Type setting matches the paper loaded in the tray.
- For Macintosh users: From the Print dialog, make sure the Paper Type setting matches the paper loaded in the tray.
- From the printer control panel Paper menu, make sure the Paper Type setting matches the paper loaded in the tray.

Incorrect margins

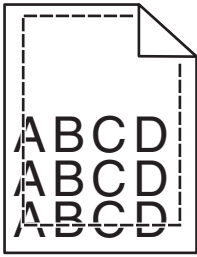

These are possible solutions. Try one or more of the following:

CHECK THE GUIDES

Move the width and length guides in the tray to the correct positions for the paper size loaded.

CHECK THE PAPER SIZE SETTING

Make sure the Paper Size setting matches the paper loaded in the tray.

CHECK THE PAGE SIZE SETTING

Before sending the job to print, specify the correct page size in Print Properties, the Print dialog, or the software program.

Paper curl

These are possible solutions. Try one or more of the following:

CHECK THE PAPER TYPE SETTING

- For Windows users: From Print Properties, make sure the Media Type setting matches the paper loaded in the tray.
- For Macintosh users: From the Print dialog, make sure the Paper Type setting matches the paper loaded in the tray.
- From the printer control panel Paper menu, make sure the Paper Type setting matches the paper loaded in the tray.

THE PAPER HAS ABSORBED MOISTURE DUE TO HIGH HUMIDITY

- Load paper from a fresh package.
- Store paper in its original wrapper until you use it.

Print is too dark

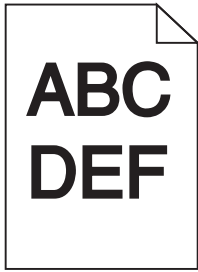

These are possible solutions. Try one or more of the following:

CHECK THE DARKNESS, BRIGHTNESS, AND CONTRAST SETTINGS

The Toner Darkness setting is too dark, the Brightness setting is too dark, or the Contrast setting is too high.

- For Windows users: From Print Properties, change these settings.
- For Macintosh users:
 - 1 Choose **File > Print**.
 - 2 Locate the drop-down box under the Orientation pictures, and then click the down button.
 - 3 Click **Printer Features**.
 - 4 Change the settings for Toner Darkness, Brightness, and Contrast.
- From the printer control panel Quality menu, change these settings.

THE PAPER HAS ABSORBED MOISTURE DUE TO HIGH HUMIDITY

- Load paper from a fresh package.
- Store paper in its original wrapper until you use it.

CHECK THE PAPER

Avoid textured paper with rough finishes.

CHECK THE PAPER TYPE SETTING

- For Windows users: From Print Properties, make sure the Media Type setting matches the paper loaded in the tray.
- For Macintosh users: From the Print dialog, make sure the Paper Type setting matches the paper loaded in the tray.
- From the printer control panel Paper menu, make sure the Paper Type setting matches the paper loaded in the tray.

THE TONER CARTRIDGE MAY BE DEFECTIVE

Replace the toner cartridge.

Print is too light

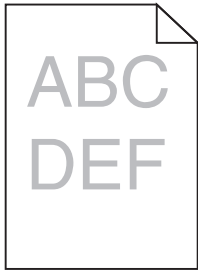

These are possible solutions. Try one or more of the following:

CHECK THE DARKNESS, BRIGHTNESS, AND CONTRAST SETTINGS

The Toner Darkness setting is too light, the Brightness setting is too light, or the Contrast setting is too low.

- For Windows users: From Print Properties, change these settings.
- For Macintosh users:
 - 1 Choose **File > Print**.
 - 2 Locate the drop-down box under the Orientation pictures, and then click the down button.
 - 3 Click **Printer Features**.
 - 4 Change the settings for Toner Darkness, Brightness, and Contrast.
- From the printer control panel Quality menu, change these settings.

THE PAPER HAS ABSORBED MOISTURE DUE TO HIGH HUMIDITY

- Load paper from a fresh package.
- Store paper in its original wrapper until you use it.

CHECK THE PAPER

Avoid textured paper with rough finishes.

CHECK THE PAPER TYPE SETTING

- For Windows users: From Print Properties, make sure the Media Type setting matches the paper loaded in the tray.
- For Macintosh users: From the Print dialog, make sure the Paper Type setting matches the paper loaded in the tray.
- From the printer control panel Paper menu, make sure the Paper Type setting matches the paper loaded in the tray.

THE TONER IS LOW

When **88 Cartridge low** appears, order a new toner cartridge.

THE TONER CARTRIDGE MAY BE DEFECTIVE

Replace the toner cartridge.

Skewed print

CHECK THE PAPER GUIDES

Move the guides in the tray to the correct positions for the paper size loaded.

CHECK THE PAPER

Make sure you are using paper that meets the printer specifications.

Toner fog or background shading appears on the page

These are possible solutions. Try one or more of the following:

THE TONER CARTRIDGE MAY BE DEFECTIVE

Replace the toner cartridge.

THERE IS TONER IN THE PAPER PATH

Contact Customer Support.

Toner rubs off

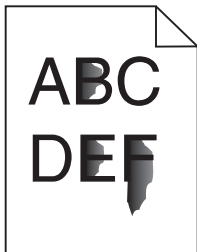

These are possible solutions. Try one or more of the following:

CHECK THE PAPER TYPE SETTING

Make sure the Paper Type setting matches the paper loaded in the tray.

CHECK THE PAPER TEXTURE SETTING

Make sure the Paper Texture setting matches the paper loaded in the tray.

Toner specks

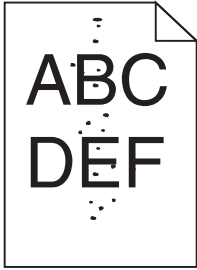

These are possible solutions. Try one or more of the following:

THE TONER CARTRIDGE MAY BE DEFECTIVE

Replace the toner cartridge.

THERE IS TONER IN THE PAPER PATH

Contact Customer Support.

Transparency print quality is poor

CHECK THE TRANSPARENCIES

Use only transparencies recommended by the printer manufacturer.

CHECK THE PAPER TYPE SETTING

Load transparencies, and make sure the Paper Type setting is set to Transparency.

Streaked horizontal lines

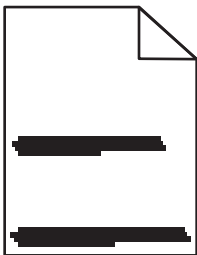

These are possible solutions. Try one or more of the following:

THE TONER MAY SMEAR WHEN PAPER IS FED FROM A SPECIFIC SOURCE

From Print Properties, the print dialog, or the printer control panel, select another tray or feeder to feed the paper for the job.

THE TONER CARTRIDGE MAY BE DEFECTIVE

Replace the toner cartridge.

MAKE SURE THE PAPER PATH IS CLEAR

Paper could be caught between the photoconductor kit and the fuser. Check the paper path around the fuser area.



CAUTION—HOT SURFACE: The inside of the printer might be hot. To reduce the risk of injury from a hot component, allow the surface to cool before touching.

Clear any paper you see.

THERE MAY BE EXCESS TONER IN THE PAPER PATH

Contact Customer Support.

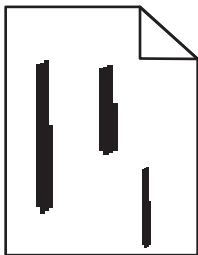
Streaked vertical lines

These are possible solutions. Try one or more of the following:

THE TONER MAY SMEAR WHEN PAPER IS FED FROM A SPECIFIC SOURCE

From Print Properties, the Print dialog, or the printer control panel, select another tray or feeder to feed paper for the job.

THE TONER CARTRIDGE IS DEFECTIVE

Replace the toner cartridge.

MAKE SURE THE PAPER PATH IS CLEAR

Paper could be caught between the photoconductor kit and the fuser. Check the paper path around the fuser area.

Warning—Potential Damage: Do not touch the photoconductor on the underside of the photoconductor kit. Use the cartridge handle whenever you are holding the cartridge.



CAUTION—HOT SURFACE: The inside of the printer might be hot. To reduce the risk of injury from a hot component, allow the surface to cool before touching.

Clear any paper you see.

THERE MAY BE EXCESS TONER IN THE PAPER PATH

Contact Customer Support.

Solid black or white streaks appear on transparencies or paper

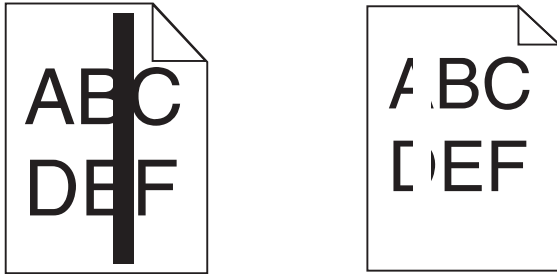

These are possible solutions. Try one or more of the following:

MAKE SURE THE FILL PATTERN IS CORRECT

If the fill pattern is incorrect, choose a different fill pattern from your software program.

CHECK THE PAPER TYPE

- Try a different type of paper.
- For transparencies, use only ones recommended by the printer manufacturer.
- Make sure the Paper Type setting matches what is loaded in the tray or feeder.
- Make sure the Paper Texture setting is correct for the type of paper or specialty media loaded in the tray or feeder.

MAKE SURE THE TONER IS DISTRIBUTED EVENLY IN THE TONER CARTRIDGE

Remove the toner cartridge and shake it from side to side to redistribute the toner to extend the life of the cartridge, and then reinstall it.

THE TONER CARTRIDGE MAY BE DEFECTIVE OR LOW ON TONER

Replace the used toner cartridge with a new one.

Embedded Web Server does not open

These are possible solutions. Try one or more of the following:

CHECK THE NETWORK CONNECTIONS

Make sure the printer and computer are turned on and connected to the same network.

CHECK THE NETWORK SETTINGS

Depending on the network settings, you may need to type `https://` instead of `http://` before the printer IP address to access the Embedded Web Server. For more information, see your system administrator.

Contacting Customer Support

When you call Customer Support, describe the problem you are experiencing, the message on the display, and the troubleshooting steps you have already taken to find a solution.

You need to know your printer model type and serial number. For more information, see the label on the inside of the front door of the printer. The serial number is also listed on the menu settings page.

In the U.S. or Canada, call (1-800-539-6275). For other countries/regions, visit the Lexmark Web site at **www.lexmark.com**.

Notices

Product information

Product name:

Lexmark X264dn, Lexmark X363dn, Lexmark X364dn, Lexmark X364dw

Machine type:

7013

Model(s):

231, 235, 432, 436, 43W, d01, d02, gd1, gd2, dn1, dn2, gd1, gd2

Edition notice

August 2011

The following paragraph does not apply to any country where such provisions are inconsistent with local law:

LEXMARK INTERNATIONAL, INC., PROVIDES THIS PUBLICATION "AS IS" WITHOUT WARRANTY OF ANY KIND, EITHER EXPRESS OR IMPLIED, INCLUDING, BUT NOT LIMITED TO, THE IMPLIED WARRANTIES OF MERCHANTABILITY OR FITNESS FOR A PARTICULAR PURPOSE. Some states do not allow disclaimer of express or implied warranties in certain transactions; therefore, this statement may not apply to you.

This publication could include technical inaccuracies or typographical errors. Changes are periodically made to the information herein; these changes will be incorporated in later editions. Improvements or changes in the products or the programs described may be made at any time.

References in this publication to products, programs, or services do not imply that the manufacturer intends to make these available in all countries in which it operates. Any reference to a product, program, or service is not intended to state or imply that only that product, program, or service may be used. Any functionally equivalent product, program, or service that does not infringe any existing intellectual property right may be used instead. Evaluation and verification of operation in conjunction with other products, programs, or services, except those expressly designated by the manufacturer, are the user's responsibility.

For Lexmark technical support, visit support.lexmark.com.

For information on supplies and downloads, visit www.lexmark.com.

If you don't have access to the Internet, you can contact Lexmark by mail:

Lexmark International, Inc.
Bldg 004-2/CSC
740 New Circle Road NW
Lexington, KY 40550
USA

© 2009 Lexmark International, Inc.

All rights reserved.

UNITED STATES GOVERNMENT RIGHTS

This software and any accompanying documentation provided under this agreement are commercial computer software and documentation developed exclusively at private expense.

Trademarks

Lexmark and Lexmark with diamond design are trademarks of Lexmark International, Inc., registered in the United States and/or other countries.

PCL® is a registered trademark of the Hewlett-Packard Company.

All other trademarks are the property of their respective owners.

Federal Communications Commission (FCC) compliance information statement

This product has been tested and found to comply with the limits for a Class B digital device, pursuant to Part 15 of the FCC Rules. Operation is subject to the following two conditions: (1) this device may not cause harmful interference, and (2) this device must accept any interference received, including interference that may cause undesired operation.

The FCC Class B limits are designed to provide reasonable protection against harmful interference when the equipment is operated in a residential installation. This equipment generates, uses, and can radiate radio frequency energy and, if not installed and used in accordance with the instructions, may cause harmful interference to radio communications. However, there is no guarantee that interference will not occur in a particular installation. If this equipment does cause harmful interference to radio or television reception, which can be determined by turning the equipment off and on, the user is encouraged to try to correct the interference by one or more of the following measures:

- Reorient or relocate the receiving antenna.
- Increase the separation between the equipment and receiver.
- Connect the equipment into an outlet on a circuit different from that to which the receiver is connected.
- Consult your point of purchase or service representative for additional suggestions.

The manufacturer is not responsible for radio or television interference caused by using other than recommended cables or by unauthorized changes or modifications to this equipment. Unauthorized changes or modifications could void the user's authority to operate this equipment.

Note: To assure compliance with FCC regulations on electromagnetic interference for a Class B computing device, use a properly shielded and grounded cable such as Lexmark part number 1021231 for parallel attach or 1021294 for USB attach. Use of a substitute cable not properly shielded and grounded may result in a violation of FCC regulations.

Any questions regarding this compliance information statement should be directed to:

Director of Lexmark Technology & Services
Lexmark International, Inc.
740 West New Circle Road
Lexington, KY 40550
(859) 232-3000

Noise emission levels

The following measurements were made in accordance with ISO 7779 and reported in conformance with ISO 9296.

Note: Some modes may not apply to your product.

1-meter average sound pressure, dBA	
Printing	53 dBA
Scanning	49 dBA
Copying	53 dBA
Ready	N/A

Values are subject to change. See www.lexmark.com for current values.

Temperature information

Ambient temperature	15.6C° – 32.2C°
Shipping and storage temperature	-40.0C° – 60.0C°

Waste from Electrical and Electronic Equipment (WEEE) directive



The WEEE logo signifies specific recycling programs and procedures for electronic products in countries of the European Union. We encourage the recycling of our products. If you have further questions about recycling options, visit the Lexmark Web site at www.lexmark.com for your local sales office phone number.

Static sensitivity notice

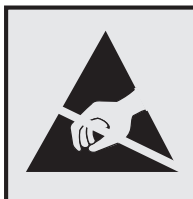

This symbol identifies static-sensitive parts. Do not touch in the areas near these symbols without first touching the metal frame of the printer.

ENERGY STAR

Any Lexmark product bearing the ENERGY STAR emblem on the product or on a start-up screen is certified to comply with Environmental Protection Agency (EPA) ENERGY STAR requirements as configured when shipped by Lexmark.



Mercury statement

This product contains mercury in the lamp (<5mg Hg). Disposal of mercury may be regulated due to environmental considerations. For disposal or recycling information, contact your local authorities or the Electronic Industries Alliance: www.eiae.org.

Laser notice

The printer is certified in the U.S. to conform to the requirements of DHHS 21 CFR Subchapter J for Class I (1) laser products, and elsewhere is certified as a Class I laser product conforming to the requirements of IEC 60825-1.

Class I laser products are not considered to be hazardous. The printer contains internally a Class IIIb (3b) laser that is nominally a 7 milliwatt gallium arsenide laser operating in the wavelength of 655-675 nanometers. The laser system and printer are designed so there is never any human access to laser radiation above a Class I level during normal operation, user maintenance, or prescribed service condition.

Laser advisory label

A laser notice label may be affixed to this printer as shown:

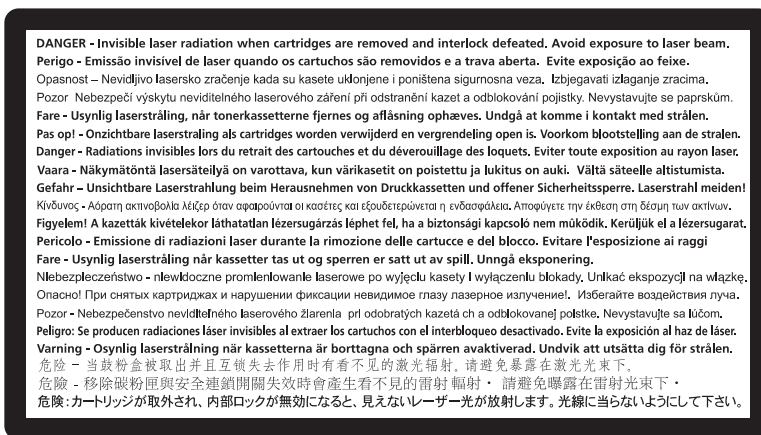

Power consumption

Product power consumption

The following table documents the power consumption characteristics of the product.

Note: Some modes may not apply to your product.

Mode	Description	Power consumption (Watts)
Printing	The product is generating hard-copy output from electronic inputs.	440 W, 480 W
Copying	The product is generating hard-copy output from hard-copy original documents.	440 W
Scanning	The product is scanning hard-copy documents.	29 W, 32 W
Ready	The product is waiting for a print job.	20 W, 22 W
Power Saver	The product is in energy-saving mode.	14 W, 16 W
Off	The product is plugged into a wall outlet, but the power switch is turned off.	0 W

The power consumption levels listed in the previous table represent time-averaged measurements. Instantaneous power draws may be substantially higher than the average.

Values are subject to change. See www.lexmark.com for current values.

Power Saver

This product is designed with an energy-saving mode called Power Saver. The Power Saver Mode is equivalent to the Sleep Mode. The Power Saver Mode saves energy by lowering power consumption during extended periods of inactivity. The Power Saver Mode is automatically engaged after this product is not used for a specified period of time, called the Power Saver Timeout.

Factory default Power Saver Timeout for this product (in minutes):	30
--	----

By using the configuration menus, the Power Saver Timeout can be modified between 1 minute and 240 minutes. Setting the Power Saver Timeout to a low value reduces energy consumption, but may increase the response time of the product. Setting the Power Saver Timeout to a high value maintains a fast response, but uses more energy.

Off mode

If this product has an off mode which still consumes a small amount of power, then to completely stop product power consumption, disconnect the power supply cord from the wall outlet.

Total energy usage

It is sometimes helpful to calculate the total product energy usage. Since power consumption claims are provided in power units of Watts, the power consumption should be multiplied by the time the product spends in each mode in order to calculate energy usage. The total product energy usage is the sum of each mode's energy usage.

European Community (EC) directives conformity

This product is in conformity with the protection requirements of EC Council directives 2004/108/EC and 2006/95/EC on the approximation and harmonization of the laws of the Member States relating to electromagnetic compatibility and safety of electrical equipment designed for use within certain voltage limits.

A declaration of conformity with the requirements of the directives has been signed by the Director of Manufacturing and Technical Support, Lexmark International, Inc., S.A., Boigny, France.

This product satisfies the Class B limits of EN 55022 and safety requirements of EN 60950.

Industry Canada compliance statement

This Class B digital apparatus meets all requirements of the Canadian Interference-Causing Equipment Standard ICES-003.

Avis de conformité aux normes de l'industrie du Canada

Cet appareil numérique de classe B est conforme aux exigences de la norme canadienne relative aux équipements pouvant causer des interférences NMB-003.

Regulatory notices for telecommunication terminal equipment

This section contains regulatory information pertaining to products that contain telecommunication terminal equipment such as facsimile.

Notice to users of the US telephone network: FCC requirements

This equipment complies with Part 68 of the FCC rules and the requirements adopted by the Administrative Council for Terminal Attachments (ACTA). On the back of this equipment is a label that contains, among other information, a product identifier in the format US:AAAEQ##TXXXX. If requested, this number must be provided to your telephone company.

This equipment uses the RJ-11C Universal Service Order Code (USOC) jack.

A plug and jack used to connect this equipment to the premises' wiring and telephone network must comply with the applicable FCC Part 68 rules and requirements adopted by the ACTA. A compliant telephone cord and modular plug is provided with this product. It is designed to be connected to a compatible modular jack that is also compliant. See your setup documentation for more information.

The Ringer Equivalence Number (REN) is used to determine the number of devices that may be connected to a telephone line. Excessive RENs on a telephone line may result in the devices not ringing in response to an incoming call. In most but not all areas, the sum of RENs should not exceed five (5.0). To be certain of the number of devices that may be connected to a line, as determined by the total RENs, contact your local telephone company. For products approved after July 23, 2001, the REN for this product is part of the product identifier that has the format US:AAAEQ##TXXXX. The digits represented by ## are the REN without a decimal point (for example, 03 is a REN of 0.3). For earlier products, the REN is shown separately on the label.

If this equipment causes harm to the telephone network, the telephone company will notify you in advance that temporary discontinuance of service may be required. If advance notice is not practical, the telephone company will notify the customer as soon as possible. You will also be advised of your right to file a complaint with the FCC.

The telephone company may make changes in its facilities, equipment, operations or procedures that could affect the operation of this equipment. If this happens, the telephone company will provide advance notice in order for you to make necessary modifications to maintain uninterrupted service.

If you experience trouble with this equipment, for repair or warranty information, contact Lexmark International, Inc. at www.lexmark.com or your Lexmark representative. If the equipment is causing harm to the telephone network, the telephone company may request that you disconnect the equipment until the problem is resolved.

This equipment contains no user serviceable parts. For repair and warranty information, contact Lexmark International, Inc. See the previous paragraph for contact information.

Connection to party line service is subject to state tariffs. Contact the state public utility commission, public service commission, or corporation commission for information.

If your home has specially wired alarm equipment connected to the telephone line, ensure the installation of this equipment does not disable your alarm equipment. If you have questions about what will disable alarm equipment, consult your telephone company or a qualified installer.

Telephone companies report that electrical surges, typically lightning transients, are very destructive to customer terminal equipment connected to AC power sources. This has been identified as a major nationwide problem. It is recommended that the customer install an appropriate AC surge arrester in the AC outlet to which this device is connected. An appropriate AC surge arrester is defined as one that is suitably rated, and certified by UL (Underwriter's Laboratories), another NRTL (Nationally Recognized Testing Laboratory), or a recognized safety certification body in the country/region of use. This is to avoid damage to the equipment caused by local lightning strikes and other electrical surges.

The Telephone Consumer Protection Act of 1991 makes it unlawful for any person to use a computer or other electronic device, including fax machines, to send any message unless said message clearly contains in a margin at the top or bottom of each transmitted page or on the first page of the transmission, the date and time it is sent and an identification of the business or other entity, or other individual sending the message, and the telephone number of the sending machine or such business, other entity, or individual. (The telephone number provided may not be a 900 number or any other number for which charges exceed local or long-distance transmission charges.)

See your user documentation in order to program this information into your fax machine.

South Africa telecommunications notice

This modem must be used in conjunction with an approved surge protection device when connected to the PSTN.

Notice to users of the Canadian telephone network

This product meets the applicable Industry Canada technical specifications. The Ringer Equivalence Number (REN) is an indication of the maximum number of terminals allowed to be connected to a telephone interface. The terminus of an interface may consist of any combination of devices, subject only to the requirement that the sum of the RENs of all the devices does not exceed five. The modem REN is located on the rear of the equipment on the product labeling.

Telephone companies report that electrical surges, typically lightning transients, are very destructive to customer terminal equipment connected to AC power sources. This has been identified as a major nationwide problem. It is recommended that the customer install an appropriate AC surge arrester in the AC outlet to which this device is connected. An appropriate AC surge arrester is defined as one that is suitably rated, and certified by UL (Underwriter's Laboratories), another NRTL (Nationally Recognized Testing Laboratory), or a recognized safety certification body in the country/region of use. This is to avoid damage to the equipment caused by local lightning strikes and other electrical surges.

This equipment uses CA11A telephone jacks.

Avis réservé aux utilisateurs du réseau téléphonique du Canada

Ce produit est conforme aux spécifications techniques d'Industrie Canada. Le numéro REN (ringer equivalence number : numéro d'équivalence de sonnerie) fournit une indication du nombre maximum de terminaux pouvant être connectés à l'interface téléphonique. En bout de ligne, le nombre d'appareils qui peuvent être connectés n'est pas directement limité, mais la somme des REN de ces appareils ne doit pas dépasser cinq. Le numéro REN du modem est indiqué sur l'étiquette produit située à l'arrière de l'équipement.

Les compagnies de téléphone constatent que les surtensions électriques, en particulier celles dues à la foudre, entraînent d'importants dégâts sur les terminaux privés connectés à des sources d'alimentation CA. Il s'agit-là d'un problème majeur d'échelle nationale. En conséquence, il vous est recommandé de brancher un parasurtenseur dans la prise de courant à laquelle l'équipement est connecté. Utilisez un parasurtenseur répondant à des caractéristiques nominales satisfaisantes et certifié par le laboratoire d'assureurs UL (Underwriter's Laboratories), un autre laboratoire agréé de type NRTL (Nationally Recognized Testing Laboratory) ou un organisme de certification agréé dans votre région ou pays. Ceci prévient tout endommagement de l'équipement causé par les orages et autres surtensions électriques.

Cet équipement utilise des prises de téléphone CA11A.

Notice to users of the New Zealand telephone network

The following are special conditions for the Facsimile User Instructions. The grant of a telepermit for any item of terminal equipment indicates only that Telecom has accepted that the item complies with minimum conditions for connection to its network. It indicates no endorsement of the product by Telecom, nor does it provide any sort of warranty. Above all, it provides no assurance that any item will work correctly in all respects with another item of telepermitted equipment of a different make or model, nor does it imply that any product is compatible with all of Telecom's network services.

This equipment shall not be set up to make automatic calls to the Telecom's 111 Emergency Service.

This equipment may not provide for the effective hand-over of a call to another device connected to the same line.

This equipment should not be used under any circumstances that may constitute a nuisance to other Telecom customers.

Some parameters required for compliance with Telecom's telepermit requirements are dependent on the equipment associated with this device. The associated equipment shall be set to operate within the following limits for compliance to Telecom's specifications:

- There shall be no more than 10 call attempts to the same number within any 30 minute period for any single manual call initiation, and
- The equipment shall go on-hook for a period of not less than 30 seconds between the end of one attempt and the beginning of the next call attempt.
- The equipment shall be set to ensure that automatic calls to different numbers are spaced such that there is not less than 5 seconds between the end of one call attempt and the beginning of another.

Using this product in Switzerland

This product requires a Swiss billing tone filter (Lexmark part number 14B5109 or 80D1877) to be installed on any line which receives metering pulses in Switzerland. The Lexmark filter must be used, as metering pulses are present on all analog telephone lines in Switzerland.

Utilisation de ce produit en Suisse

Cet appareil nécessite l'utilisation d'un filtre de tonalité de facturation suisse (n° de référence Lexmark : 14B5109 ou 80D1877) devant être installé sur toute ligne recevant des impulsions de comptage en Suisse. Ce filtre doit être utilisé pour toute installation car ces impulsions existent sur toutes les lignes téléphoniques suisses.

Verwendung dieses Produkts in der Schweiz

Für dieses Produkt muss ein schweizerischer Billing Tone Filter zur Zählzeichenübertragung (Lexmark Teilenummer 14B5109 oder 80D1877) für jede Leitung installiert werden, über die in der Schweiz Zeitsteuertakte übertragen werden. Die Verwendung des Lexmark Filters ist obligatorisch, da in allen analogen Telefonleitungen in der Schweiz Zeitsteuertakte vorhanden sind.

Uso del prodotto in Svizzera

Questo prodotto richiede un filtro toni Billing svizzero, (codice Lexmark 14B5109 o 80D1877) da installare su tutte le linee che ricevono impulsi remoti in Svizzera. È necessario utilizzare il filtro Lexmark poiché gli impulsi remoti sono presenti su tutte le linee analogiche in Svizzera.

Notice to Users in the European Union

Products bearing the CE mark are in conformity with the protection requirements of EC Council directives 2004/108/EC, 2006/95/EC, and 1999/5/EC on the approximation and harmonization of the laws of the Member States relating to electromagnetic compatibility, safety of electrical equipment designed for use within certain voltage limits and on radio equipment and telecommunications terminal equipment.

Compliance is indicated by the CE marking.



A declaration of conformity with the requirements of the directives is available from the Director of Manufacturing and Technical Support, Lexmark International, S. A., Boigny, France.

Refer to the table at the end of the Notices section for further compliance information.

Regulatory notices for wireless products

This section contains the following regulatory information pertaining to wireless products.

Exposure to radio frequency radiation

The following notice is applicable if your printer has a wireless network card installed: The radiated output power of this device is far below the radio frequency exposure limits of the FCC and other regulatory agencies. A minimum separation of 20 cm (8 inches) must be maintained between the antenna and any persons for this device to satisfy the RF exposure requirements of the FCC and other regulatory agencies.

Notice to users in Brazil

Este equipamento opera em caráter secundário, isto é, não tem direito a proteção contra interferência prejudicial, mesmo de estações do mesmo tipo, e não pode causar interferência a sistemas operando em caráter primário. (Res. ANATEL 282/2001).

Industry Canada (Canada)

This device complies with Industry Canada specification RSS-210. Operation is subject to the following two conditions: (1) this device may not cause interference, and (2) this device must accept any interference, including interference that may cause undesired operation of the device.

This device has been designed to operate only with the antenna provided. Use of any other antenna is strictly prohibited per regulations of Industry Canada.

To prevent radio interference to the licensed service, this device is intended to be operated indoors and away from windows to provide maximum shielding. Equipment (or its transmit antenna) that is installed outdoors is subject to licensing.

The installer of this radio equipment must ensure that the antenna is located or pointed such that it does not emit RF fields in excess of Health Canada limits for the general population; consult Safety Code 6, obtainable from Health Canada's Web site www.hc-sc.gc.ca/rpb.

The term "IC:" before the certification/registration number only signifies that the Industry Canada technical specifications were met.

Industry Canada (Canada)

Cet appareil est conforme à la norme RSS-210 d'Industry Canada. Son fonctionnement est soumis aux deux conditions suivantes :

(1) cet appareil ne doit pas provoquer d'interférences et (2) il doit accepter toute interférence reçue, y compris celles risquant d'altérer son fonctionnement.

Cet appareil a été conçu pour fonctionner uniquement avec l'antenne fournie. L'utilisation de toute autre antenne est strictement interdite par la réglementation d'Industry Canada.

En application des réglementations d'Industry Canada, l'utilisation d'une antenne de gain supérieur est strictement interdite.

Pour empêcher toute interférence radio au service faisant l'objet d'une licence, cet appareil doit être utilisé à l'intérieur et loin des fenêtres afin de garantir une protection optimale.

Si le matériel (ou son antenne d'émission) est installé à l'extérieur, il doit faire l'objet d'une licence.

L'installateur de cet équipement radio doit veiller à ce que l'antenne soit implantée et dirigée de manière à n'émettre aucun champ HF dépassant les limites fixées pour l'ensemble de la population par Santé Canada. Reportez-vous au Code de sécurité 6 que vous pouvez consulter sur le site Web de Santé Canada www.hc-sc.gc.ca/rpb.

Le terme « IC » précédant le numéro de d'accréditation/inscription signifie simplement que le produit est conforme aux spécifications techniques d'Industry Canada.

Taiwan NCC RF notice statement

NCC型式認證設備注意事項 台灣低功率射頻電機設備之使用注意事項

經型式認證合格之低功率射頻電機，非經許可，公司、商號或使用者均不得擅自變更頻率、加大功率或變更原設計之特性及功能。

低功率射頻電機之使用不得影響飛航安全及干擾合法通信；經發現有干擾現象時，應立即停用，並改善至無干擾時方得繼續使用。前項合法通信，指依電信規定作業之無線電信。低功率射頻電機須忍受合法通信或工業、科學及醫療用電波輻射性電機設備之干擾。

Notice to users in the European Union

Products bearing the CE mark are in conformity with the protection requirements of EC Council directives 2004/108/EC, 2006/95/EC, and 1999/5/EC on the approximation and harmonization of the laws of the Member States relating to electromagnetic compatibility, safety of electrical equipment designed for use within certain voltage limits and on radio equipment and telecommunications terminal equipment.

Compliance is indicated by the CE marking.



A declaration of conformity with the requirements of the directives is available from the Director of Manufacturing and Technical Support, Lexmark International, S. A., Boigny, France. Refer to the table at the end of the Notices section for further compliance information.

Products equipped with 2.4GHz Wireless LAN option are in conformity with the protection requirements of EC Council directives 2004/108/EC, 2006/95/EC, and 1999/5/EC on the approximation and harmonization of the laws of the Member States relating to electromagnetic compatibility, safety of electrical equipment designed for use within certain voltage limits and on radio equipment and telecommunications terminal equipment.

Compliance is indicated by the CE marking.



Operation is allowed in all EU and EFTA countries, but is restricted to indoor use only.

A declaration of conformity with the requirements of the directives is available from the Director of Manufacturing and Technical Support, Lexmark International, S. A., Boigny, France. Refer to the table at the end of the Notices section for further compliance information.

Česky	Společnost Lexmark International, Inc. tímto prohlašuje, že výrobek tento výrobek je ve shodě se základními požadavky a dalšími příslušnými ustanoveními směrnice 1999/5/ES.
Dansk	Lexmark International, Inc. erklærer herved, at dette produkt overholder de væsentlige krav og øvrige relevante krav i direktiv 1999/5/EF.
Deutsch	Hiermit erklärt Lexmark International, Inc., dass sich das Gerät dieses Gerät in Übereinstimmung mit den grundlegenden Anforderungen und den übrigen einschlägigen Bestimmungen der Richtlinie 1999/5/EG befindet.

Ελληνική	ΜΕ ΤΗΝ ΠΑΡΟΥΣΑ Η LEXMARK INTERNATIONAL, INC. ΔΗΛΩΝΕΙ ΟΤΙ ΑΥΤΟ ΤΟ ΠΡΟΪΟΝ ΣΥΜΜΟΡΦΩΝΕΤΑΙ ΠΡΟΣ ΤΙΣ ΟΥΣΙΩΔΕΙΣ ΑΠΑΙΤΗΣΕΙΣ ΚΑΙ ΤΙΣ ΛΟΙΠΕΣ ΣΧΕΤΙΚΕΣ ΔΙΑΤΑΞΕΙΣ ΤΗΣ ΟΔΗΓΙΑΣ 1999/5/ΕΚ.
English	Hereby, Lexmark International, Inc., declares that this type of equipment is in compliance with the essential requirements and other relevant provisions of Directive 1999/5/EC.
Español	Por medio de la presente, Lexmark International, Inc. declara que este producto cumple con los requisitos esenciales y cualesquiera otras disposiciones aplicables o exigibles de la Directiva 1999/5/CE.
Eesti	Käesolevaga kinnitab Lexmark International, Inc., et seade see toode vastab direktiivi 1999/5/EÜ põhinõuetele ja nimetatud direktiivist tulenevatele muudele asjakohastele sätetele.
Suomi	Lexmark International, Inc. vakuuttaa täten, että tämä tuote on direktiivin 1999/5/EY oleellisten vaatimusten ja muiden sitä koskevien direktiivin ehtojen mukainen.
Français	Par la présente, Lexmark International, Inc. déclare que l'appareil ce produit est conforme aux exigences fondamentales et autres dispositions pertinentes de la directive 1999/5/CE.
Magyar	Alulírott, Lexmark International, Inc. nyilatkozom, hogy a termék megfelel a vonatkozó alapvető követelményeknek és az 1999/5/EC irányelv egyéb előírásainak.
Íslenska	Hér með lýsir Lexmark International, Inc. yfir því að þessi vara er í samræmi við grunnkröfur og aðrar kröfur, sem gerðar eru í tilskipun 1999/5/EC.
Italiano	Con la presente Lexmark International, Inc. dichiara che questo questo prodotto è conforme ai requisiti essenziali ed alle altre disposizioni pertinenti stabilite dalla direttiva 1999/5/CE.
Latviski	Ar šo Lexmark International, Inc. deklarē, ka šis izstrādājums atbilst Direktīvas 1999/5/EK būtiskajām prasībām un citiem ar to saistītajiem noteikumiem.
Lietuvių	Šiuo Lexmark International, Inc. deklaruoja, kad šis produktas atitinka esminius reikalavimus ir kitas 1999/5/EB direktyvos nuostatas.
Malti	Bil-preżenti, Lexmark International, Inc., jiddikjara li dan il-prodott huwa konformi mal-ħtiġijiet essenzjali u ma dispozizzjonijiet oħrajn relevanti li jinsabu fid-Direttiva 1999/5/KE.
Nederlands	Hierbij verklaart Lexmark International, Inc. dat het toestel dit product in overeenstemming is met de essentiële eisen en de andere relevante bepalingen van richtlijn 1999/5/EG.
Norsk	Lexmark International, Inc. erklærer herved at dette produktet er i samsvar med de grunnleggende krav og øvrige relevante krav i direktiv 1999/5/EF.
Polski	Niniejszym Lexmark International, Inc. oświadcza, że niniejszy produkt jest zgodny z zasadniczymi wymogami oraz pozostałymi stosownymi postanowieniami Dyrektywy 1999/5/EC.
Português	A Lexmark International Inc. declara que este este produto está conforme com os requisitos essenciais e outras disposições da Diretiva 1999/5/CE.
Slovensky	Lexmark International, Inc. týmto vyhlasuje, že tento produkt spĺňa základné požiadavky a všetky príslušné ustanovenia smernice 1999/5/ES.
Slovensko	Lexmark International, Inc. izjavlja, da je ta izdelek v skladu z bistvenimi zahtevami in ostalimi relevantnimi določili direktive 1999/5/ES.
Svenska	Härmed intygar Lexmark International, Inc. att denna produkt står i överensstämmelse med de väsentliga egenskapskrav och övriga relevanta bestämmelser som framgår av direktiv 1999/5/EG.

Statement of Limited Warranty

Lexmark X264dn, Lexmark X363dn, Lexmark X364dn, Lexmark X364dw

Lexmark International, Inc., Lexington, KY

This limited warranty applies to the United States and Canada. For customers outside the U.S., refer to the country-specific warranty information that came with your product.

This limited warranty applies to this product only if it was originally purchased for your use, and not for resale, from Lexmark or a Lexmark Remarketer, referred to in this statement as "Remarketer."

Limited warranty

Lexmark warrants that this product:

- Is manufactured from new parts, or new and serviceable used parts, which perform like new parts
- Is, during normal use, free from defects in material and workmanship

If this product does not function as warranted during the warranty period, contact a Remarketer or Lexmark for repair or replacement (at Lexmark's option).

If this product is a feature or option, this statement applies only when that feature or option is used with the product for which it was intended. To obtain warranty service, you may be required to present the feature or option with the product.

If you transfer this product to another user, warranty service under the terms of this statement is available to that user for the remainder of the warranty period. You should transfer proof of original purchase and this statement to that user.

Limited warranty service

The warranty period starts on the date of original purchase as shown on the purchase receipt and ends 12 months later provided that the warranty period for any supplies and for any maintenance items included with the printer shall end earlier if it, or its original contents, are substantially used up, depleted, or consumed.

To obtain warranty service you may be required to present proof of original purchase. You may be required to deliver your product to the Remarketer or Lexmark, or ship it prepaid and suitably packaged to a Lexmark designated location. You are responsible for loss of, or damage to, a product in transit to the Remarketer or the Lexmark designated location.

When warranty service involves the exchange of a product or part, the item replaced becomes the property of the Remarketer or Lexmark. The replacement may be a new or repaired item.

The replacement item assumes the remaining warranty period of the original product.

Replacement is not available to you if the product you present for exchange is defaced, altered, in need of a repair not included in warranty service, damaged beyond repair, or if the product is not free of all legal obligations, restrictions, liens, and encumbrances.

Before you present this product for warranty service, remove all print cartridges, programs, data, and removable storage media (unless directed otherwise by Lexmark).

For further explanation of your warranty alternatives and the nearest Lexmark authorized servicer in your area contact Lexmark on the World Wide Web at www.lexmark.com/support.

Remote technical support is provided for this product throughout its warranty period. For products no longer covered by a Lexmark warranty, technical support may not be available or only be available for a fee.

Extent of limited warranty

Lexmark does not warrant uninterrupted or error-free operation of any product or the durability or longevity of prints produced by any product.

Warranty service does not include repair of failures caused by:

- Modification or unauthorized attachments
- Accidents, misuse, abuse or use inconsistent with Lexmark user's guides, manuals, instructions or guidance
- Unsuitable physical or operating environment
- Maintenance by anyone other than Lexmark or a Lexmark authorized servicer
- Operation of a product beyond the limit of its duty cycle
- Use of printing media outside of Lexmark specifications
- Refurbishment, repair, refilling or remanufacture by a third party of products, supplies or parts
- Products, supplies, parts, materials (such as toners and inks), software, or interfaces not furnished by Lexmark

TO THE EXTENT PERMITTED BY APPLICABLE LAW, NEITHER LEXMARK NOR ITS THIRD PARTY SUPPLIERS OR REMARKETERS MAKE ANY OTHER WARRANTY OR CONDITION OF ANY KIND, WHETHER EXPRESS OR IMPLIED, WITH RESPECT TO THIS PRODUCT, AND SPECIFICALLY DISCLAIM THE IMPLIED WARRANTIES OR CONDITIONS OF MERCHANTABILITY, FITNESS FOR A PARTICULAR PURPOSE, AND SATISFACTORY QUALITY. ANY WARRANTIES THAT MAY NOT BE DISCLAIMED UNDER APPLICABLE LAW ARE LIMITED IN DURATION TO THE WARRANTY PERIOD. NO WARRANTIES, EXPRESS OR IMPLIED, WILL APPLY AFTER THIS PERIOD. ALL INFORMATION, SPECIFICATIONS, PRICES, AND SERVICES ARE SUBJECT TO CHANGE AT ANY TIME WITHOUT NOTICE.

Limitation of liability

Your sole remedy under this limited warranty is set forth in this document. For any claim concerning performance or nonperformance of Lexmark or a Remarketer for this product under this limited warranty, you may recover actual damages up to the limit set forth in the following paragraph.

Lexmark's liability for actual damages from any cause whatsoever will be limited to the amount you paid for the product that caused the damages. This limitation of liability will not apply to claims by you for bodily injury or damage to real property or tangible personal property for which Lexmark is legally liable. **IN NO EVENT WILL LEXMARK BE LIABLE FOR ANY LOST PROFITS, LOST SAVINGS, INCIDENTAL DAMAGE, OR OTHER ECONOMIC OR CONSEQUENTIAL DAMAGES.**

This is true even if you advise Lexmark or a Remarketer of the possibility of such damages. Lexmark is not liable for any claim by you based on a third party claim.

This limitation of remedies also applies to claims against any Suppliers and Remarketers of Lexmark. Lexmark's and its Suppliers' and Remarketers' limitations of remedies are not cumulative. Such Suppliers and Remarketers are intended beneficiaries of this limitation.

Additional rights

Some states do not allow limitations on how long an implied warranty lasts, or do not allow the exclusion or limitation of incidental or consequential damages, so the limitations or exclusions contained above may not apply to you.

This limited warranty gives you specific legal rights. You may also have other rights that vary from state to state.

LEXMARK SOFTWARE LIMITED WARRANTY AND LICENSE AGREEMENTS

PLEASE READ CAREFULLY BEFORE USING THIS PRODUCT: BY USING THIS PRODUCT, YOU AGREE TO BE BOUND BY ALL THE TERMS AND CONDITIONS OF THIS SOFTWARE LIMITED WARRANTY AND LICENSE AGREEMENTS. IF YOU DO NOT AGREE WITH THE TERMS OF THIS SOFTWARE LIMITED WARRANTY AND LICENSE AGREEMENTS, PROMPTLY RETURN THE PRODUCT UNUSED AND REQUEST A REFUND OF THE AMOUNT YOU PAID. IF YOU ARE INSTALLING THIS PRODUCT FOR USE BY OTHER PARTIES, YOU AGREE TO INFORM THE USERS THAT USE OF THE PRODUCT INDICATES ACCEPTANCE OF THESE TERMS.

DEVICE LICENSE AGREEMENT

The patented printer is licensed for, and designed to work with only genuine Lexmark toner cartridges and developer components for the life of the patented printer. Under this patent license, you agree to: (1) use only genuine Lexmark toner cartridges and developer components with this printer except as otherwise provided below, and (2) pass this license/agreement to any subsequent user of this printer. The patented Lexmark toner cartridges and developer components inside are licensed subject to a restriction that they may be used only once. Following their initial use, you agree to return them only to Lexmark for recycling. Lexmark toner cartridges are designed to stop working after a delivering a fixed amount of toner. A variable amount of toner may remain in them when replacement is required. Replacement toner cartridge(s) sold without these terms are available through www.lexmark.com, may be refilled by you, or a third party, as the only cartridge alternative to be used with the licensed printer.

LEXMARK SOFTWARE LICENSE AGREEMENT

This Software License Agreement (“Software License Agreement”) is a legal agreement between you (either an individual or a single entity) and Lexmark International, Inc. (“Lexmark”) that, to the extent your Lexmark product or Software Program is not otherwise subject to a written software license agreement between you and Lexmark or its suppliers, governs your use of any Software Program installed on or provided by Lexmark for use in connection with your Lexmark product. The term “Software Program” includes machine-readable instructions, audio/visual content (such as images and recordings), and associated media, printed materials and electronic documentation, whether incorporated into, distributed with or for use with your Lexmark product.

- 1 STATEMENT OF SOFTWARE LIMITED WARRANTY.** Lexmark warrants that the media (e.g., diskette or compact disk) on which the Software Program (if any) is furnished is free from defects in materials and workmanship under normal use during the warranty period. The warranty period is ninety (90) days and commences on the date the Software Program is delivered to the original end-user. This limited warranty applies only to Software Program media purchased new from Lexmark or an Authorized Lexmark Reseller or Distributor. Lexmark will replace the Software Program should it be determined that the media does not conform to this limited warranty.
- 2 DISCLAIMER AND LIMITATION OF WARRANTIES.** EXCEPT AS PROVIDED IN THIS SOFTWARE LICENSE AGREEMENT AND TO THE MAXIMUM EXTENT PERMITTED BY APPLICABLE LAW, LEXMARK AND ITS SUPPLIERS PROVIDE THE SOFTWARE PROGRAM "AS IS" AND HEREBY DISCLAIM ALL OTHER WARRANTIES AND CONDITIONS, EITHER EXPRESS OR IMPLIED, INCLUDING, BUT NOT LIMITED TO, TITLE, NON-INFRINGEMENT, MERCHANTABILITY AND FITNESS FOR A PARTICULAR PURPOSE, AND ABSENCE OF VIRUSES, ALL WITH REGARD TO THE SOFTWARE PROGRAM. TO THE EXTENT LEXMARK CANNOT BY LAW DISCLAIM ANY COMPONENT OF THE IMPLIED WARRANTIES OF MERCHANTABILITY OR FITNESS FOR A PARTICULAR PURPOSE, LEXMARK LIMITS THE DURATION OF SUCH WARRANTIES TO THE 90-DAY TERM OF THE EXPRESS SOFTWARE LIMITED WARRANTY.

This Agreement is to be read in conjunction with certain statutory provisions, as that may be in force from time to time, that imply warranties or conditions or impose obligations on Lexmark that cannot be excluded or modified. If any such provisions apply, then to the extent Lexmark is able, Lexmark hereby limits its liability for breach of those provisions to one of the following: providing you a replacement copy of the Software Program or reimbursement of the price paid for the Software Program.

The Software Program may include internet links to other software applications and/or internet web pages hosted and operated by third parties unaffiliated with Lexmark. You acknowledge and agree that Lexmark is not responsible in any way for the hosting, performance, operation, maintenance, or content of, such software applications and/or internet web pages.

3 LIMITATION OF REMEDY. TO THE MAXIMUM EXTENT PERMITTED BY APPLICABLE LAW, ANY AND ALL LIABILITY OF LEXMARK UNDER THIS SOFTWARE LICENSE AGREEMENT IS EXPRESSLY LIMITED TO THE GREATER OF THE PRICE PAID FOR THE SOFTWARE PROGRAM AND FIVE U.S. DOLLARS (OR THE EQUIVALENT IN LOCAL CURRENCY). YOUR SOLE REMEDY AGAINST LEXMARK IN ANY DISPUTE UNDER THIS SOFTWARE LICENSE AGREEMENT SHALL BE TO SEEK TO RECOVER ONE OF THESE AMOUNTS, UPON PAYMENT OF WHICH LEXMARK SHALL BE RELEASED AND DISCHARGED OF ALL FURTHER OBLIGATIONS AND LIABILITY TO YOU.

IN NO EVENT WILL LEXMARK, ITS SUPPLIERS, SUBSIDIARIES, OR RESELLERS BE LIABLE FOR ANY SPECIAL, INCIDENTAL, INDIRECT, EXEMPLARY, PUNITIVE, OR CONSEQUENTIAL DAMAGES (INCLUDING BUT NOT LIMITED TO LOST PROFITS OR REVENUES, LOST SAVINGS, INTERRUPTION OF USE OR ANY LOSS OF, INACCURACY IN, OR DAMAGE TO, DATA OR RECORDS, FOR CLAIMS OF THIRD PARTIES, OR DAMAGE TO REAL OR TANGIBLE PROPERTY, FOR LOSS OF PRIVACY ARISING OUT OR IN ANY WAY RELATED TO THE USE OF OR INABILITY TO USE THE SOFTWARE PROGRAM, OR OTHERWISE IN CONNECTION WITH ANY PROVISION OF THIS SOFTWARE LICENCE AGREEMENT), REGARDLESS OF THE NATURE OF THE CLAIM, INCLUDING BUT NOT LIMITED TO BREACH OF WARRANTY OR CONTRACT, TORT (INCLUDING NEGLIGENCE OR STRICT LIABILITY), AND EVEN IF LEXMARK, OR ITS SUPPLIERS, AFFILIATES, OR REMARKETERS HAVE BEEN ADVISED OF THE POSSIBILITY OF SUCH DAMAGES, OR FOR ANY CLAIM BY YOU BASED ON A THIRD-PARTY CLAIM, EXCEPT TO THE EXTENT THIS EXCLUSION OF DAMAGES IS DETERMINED LEGALLY INVALID. THE FOREGOING LIMITATIONS APPLY EVEN IF THE ABOVE-STATED REMEDIES FAIL OF THEIR ESSENTIAL PURPOSE.

4 U.S.A. STATE LAWS. This Software Limited Warranty gives you specific legal rights. You may also have other rights that vary from state to state. Some states do not allow limitations on how long an implied warranty lasts or the exclusion of limitation of incidental or consequential damages, so the above limitations may not apply to you.

5 LICENSE GRANT. Lexmark grants you the following rights provided you comply with all terms and conditions of this Software License Agreement:

- a Use.** You may Use one (1) copy of the Software Program. The term "Use" means storing, loading, installing, executing, or displaying the Software Program. If Lexmark has licensed the Software Program to you for concurrent use, you must limit the number of authorized users to the number specified in your agreement with Lexmark. You may not separate the components of the Software Program for use on more than one computer. You agree that you will not Use the Software Program, in whole or in part, in any manner that has the effect of overriding, modifying, eliminating, obscuring, altering or de-emphasizing the visual appearance of any trademark, trade name, trade dress or intellectual property notice that appears on any computer display screens normally generated by, or as a result of, the Software Program.
- b Copying.** You may make one (1) copy of the Software Program solely for purposes of backup, archiving, or installation, provided the copy contains all of the original Software Program's proprietary notices. You may not copy the Software Program to any public or distributed network.
- c Reservation of Rights.** The Software Program, including all fonts, is copyrighted and owned by Lexmark International, Inc. and/or its suppliers. Lexmark reserves all rights not expressly granted to you in this Software License Agreement.
- d Freeware.** Notwithstanding the terms and conditions of this Software License Agreement, all or any portion of the Software Program that constitutes software provided under public license by third parties ("Freeware") is licensed to you subject to the terms and conditions of the software license agreement accompanying such Freeware, whether in the form of a discrete agreement, shrink-wrap license, or electronic license terms at the time of download or installation. Use of the Freeware by you shall be governed entirely by the terms and conditions of such license.

6 TRANSFER. You may transfer the Software Program to another end-user. Any transfer must include all software components, media, printed materials, and this Software License Agreement and you may not retain copies of the Software Program or components thereof. The transfer may not be an indirect transfer, such as a consignment. Prior to the transfer, the end-user receiving the transferred Software Program must agree to all these Software

License Agreement terms. Upon transfer of the Software Program, your license is automatically terminated. You may not rent, sublicense, or assign the Software Program except to the extent provided in this Software License Agreement.

- 7 UPGRADES.** To Use a Software Program identified as an upgrade, you must first be licensed to the original Software Program identified by Lexmark as eligible for the upgrade. After upgrading, you may no longer use the original Software Program that formed the basis for your upgrade eligibility.
- 8 LIMITATION ON REVERSE ENGINEERING.** You may not alter, decrypt, reverse engineer, reverse assemble, reverse compile or otherwise translate the Software Program or assist or otherwise facilitate others to do so, except as and to the extent expressly permitted to do so by applicable law for the purposes of inter-operability, error correction, and security testing. If you have such statutory rights, you will notify Lexmark in writing of any intended reverse engineering, reverse assembly, or reverse compilation. You may not decrypt the Software Program unless necessary for the legitimate Use of the Software Program.
- 9 ADDITIONAL SOFTWARE.** This Software License Agreement applies to updates or supplements to the original Software Program provided by Lexmark unless Lexmark provides other terms along with the update or supplement.
- 10 TERM.** This Software License Agreement is effective unless terminated or rejected. You may reject or terminate this license at any time by destroying all copies of the Software Program, together with all modifications, documentation, and merged portions in any form, or as otherwise described herein. Lexmark may terminate your license upon notice if you fail to comply with any of the terms of this Software License Agreement. Upon such termination, you agree to destroy all copies of the Software Program together with all modifications, documentation, and merged portions in any form.
- 11 TAXES.** You agree that you are responsible for payment of any taxes including, without limitation, any goods and services and personal property taxes, resulting from this Software License Agreement or your Use of the Software Program.
- 12 LIMITATION ON ACTIONS.** No action, regardless of form, arising out of this Software License Agreement may be brought by either party more than two years after the cause of action has arisen, except as provided under applicable law.
- 13 APPLICABLE LAW.** This Software License Agreement is governed by the laws of the Commonwealth of Kentucky, United States of America. No choice of law rules in any jurisdiction shall apply. The UN Convention on Contracts for the International Sale of Goods shall not apply.
- 14 UNITED STATES GOVERNMENT RESTRICTED RIGHTS.** The Software Program has been developed entirely at private expense. Rights of the United States Government to use the Software Program are as set forth in this Software License Agreement and as restricted in DFARS 252.227-7014 and in similar FAR provisions (or any equivalent agency regulation or contract clause).
- 15 CONSENT TO USE OF DATA.** You agree that Lexmark, its affiliates, and agents may collect and use information you provide in relation to support services performed with respect to the Software Program and requested by you. Lexmark agrees not to use this information in a form that personally identifies you except to the extent necessary to provide such services.
- 16 EXPORT RESTRICTIONS.** You may not (a) acquire, ship, transfer, or reexport, directly or indirectly, the Software Program or any direct product therefrom, in violation of any applicable export laws or (b) permit the Software Program to be used for any purpose prohibited by such export laws, including, without limitation, nuclear, chemical, or biological weapons proliferation.
- 17 AGREEMENT TO CONTRACT ELECTRONICALLY.** You and Lexmark agree to form this Software License Agreement electronically. This means that when you click the “Agree” or “I accept” button on this page or use this product, you acknowledge your agreement to these Software License Agreement terms and conditions and that you are doing so with the intent to “sign” a contract with Lexmark.

- 18 CAPACITY AND AUTHORITY TO CONTRACT.** You represent that you are of the legal age of majority in the place you sign this Software License Agreement and, if applicable, you are duly authorized by your employer or principal to enter into this contract.
- 19 ENTIRE AGREEMENT.** This Software License Agreement (including any addendum or amendment to this Software License Agreement that is included with the Software Program) is the entire agreement between you and Lexmark relating to the Software Program. Except as otherwise provided for herein, these terms and conditions supersede all prior or contemporaneous oral or written communications, proposals, and representations with respect to the Software Program or any other subject matter covered by this Software License Agreement (except to the extent such extraneous terms do not conflict with the terms of this Software License Agreement, any other written agreement signed by you and Lexmark relating to your Use of the Software Program). To the extent any Lexmark policies or programs for support services conflict with the terms of this Software License Agreement, the terms of this Software License Agreement shall control.

Index

Numerics

200.yy Paper jam 183
 201.yy Paper jam 184
 202.yy Paper jam 184
 231.yy Paper jam 184
 233.yy Paper jam 184
 234.yy Paper jam 185
 235.yy Paper jam 185
 24x.yy Paper jam 185
 250-sheet drawer
 installing 21
 251.yy Paper jam 185
 290–292 ADF Scanning Jams 186
 293 Paper Missing 186
 293.02 Flatbed Cover Open 186
 294 ADF Jam 186
 31.yy Replace defective or missing cartridge 180
 34 Short paper 180
 35 Insufficient memory to support Resource Save feature 181
 37 Insufficient memory for Flash Memory Defragment operation 181
 37 Insufficient memory to collate job 181
 38 Memory full 181
 39 Complex page, some data may not have printed 181
 51 Defective flash detected 181
 52 Not enough free space in flash memory for resources 182
 53 Unformatted flash detected 182
 54 Network <x> software error 182
 54 Standard network software error 182
 550-sheet drawer
 installing 21
 56 Standard USB port disabled 182
 58 Too many flash options installed 182
 58 Too many trays attached 183
 84 PC Kit life warning 183
 84 Replace PC Kit 183
 840.01 Scanner Disabled 186
 840.02 Scanner Auto Disabled 187
 88.yy Cartridge is low 183

A

Active NIC menu 116
 address book, e-mail
 setting up 78
 address book, fax
 using 98
 ADF
 copying using 68
 ADF pick assembly
 ordering 151
 ADF separator roll
 ordering 151
 ADF separator rollers, cleaning 147
 adjusting Power Saver
 using the Embedded Web Server 36
 using the printer control panel 36
 Answering 176
 AppleTalk menu 120
 attaching cables 22

B

buttons, printer control panel 15

C

cables
 Ethernet 22
 fax 22
 USB 22
 Call complete 176
 calling Customer Support 210
 canceling a job
 from Macintosh 66
 from Windows 66
 canceling print jobs
 from printer control panel 66
 card stock
 loading 45
 tips 64
 checking an unresponsive printer 176
 checking an unresponsive scanner 192
 checking device status
 on Embedded Web Server 158
 cleaning
 ADF separator rollers 147
 exterior of the printer 146
 scanner glass 146
 Close front door 176
 collating copies 73
 configuration information
 wireless network 26
 configurations
 printer 10
 Configure MP menu 111
 configuring
 multiple printers 159
 configuring supply notifications 159
 connecting the printer to
 answering machine 85
 computer modem 90
 regional adapters 86
 telephone 85
 conservation settings
 Eco-Mode 35
 Power Saver 36
 Quiet Mode 37
 conserving supplies 34
 contacting Customer Support 210
 control panel, printer 15
 factory defaults, restoring 157
 copy quality
 adjusting 73
 improving 76
 Copy Settings menu 125
 copy troubleshooting
 copier does not respond 190
 partial document or photo
 copies 192
 poor copy quality 190
 poor scanned image quality 193
 scanner unit does not close 190
 unable to pause print job to make
 copies 192
 copying
 adding an overlay message 75
 adjusting quality 73
 canceling a copy job 76
 collating copies 73
 enlarging 72
 from one size to another 70
 improving copy quality 76
 making a copy lighter or darker 72
 multiple pages on one sheet 74

- on both sides of the paper (duplexing) 71
- pausing a print job to make copies 75
- photos 69
- placing separator sheets between copies 74
- quick copy 68
- reducing 72
- selecting a tray 71
- to letterhead 70
- to transparencies 69
- using the ADF 68
- using the scanner glass 69
- custom paper type
 - assigning 51
- Custom Scan Sizes menu 114
- Custom Type <x>
 - changing name 52
- Custom Types menu 113

D

- date and time
 - setting 92
- Default Source menu 108
- Defragmenting Flash 176
- directory list
 - printing 65
- display troubleshooting
 - display is blank 176
 - display shows only diamonds 176
- display, printer control panel 15
- distinctive ring service
 - connecting to 84
- DO NOT TOUCH Reading flash data
- DO NOT POWER OFF 177
- documents, printing
 - from Macintosh 59
 - from Windows 59
- duplexing
 - copy jobs 71
 - incoming faxes 98
 - print jobs 61

E

- Eco-Mode setting 35
- Embedded Web Server 157
 - administrator settings 157
 - copying settings to other printers 159
 - does not open 209

- networking settings 157
- restricting access to printer menus 158
- setting up e-mail alerts 159
- Embedded Web Server Administrator's Guide 157
- emission
- notices 212, 213, 216, 219, 220, 221
- enlarging a copy 72
- envelopes
 - loading 45, 49
 - tips 63
- environmental settings
 - Eco-Mode 35
 - Power Saver 36
 - Quiet Mode 37
- Ethernet networking
 - Macintosh 31
 - Windows 31
- Ethernet port 22
- exterior of the printer
 - cleaning 146
- e-mail
 - canceling 80
 - notice of low supply level 159
 - notice of paper jam 159
 - notice of paper needed 159
 - notice that different paper is needed 159
- e-mail function
 - setting up 77
- e-mailing
 - creating shortcuts using the Embedded Web Server 78
 - setting up address book 78
 - setting up e-mail function 77
 - using shortcut numbers 79
 - using the address book 80
 - using the keypad 78

F

- factory defaults, restoring
 - printer control panel menus 157
- fax
 - canceling 100
 - options 101
- fax connection
 - connecting the printer to the wall jack 83
 - connecting to a distinctive ring service 84

- connecting to a DSL line 83
- connecting to a PBX or ISDN 84
- fax connections
 - answering machine 85
 - computer modem 90
 - regional adapters 86
 - telephone 85
- Fax failed 177
- fax ports 22
- fax quality, improving 102
- Fax Settings menu 127
- Fax Station Name not set up 177
- Fax Station Number not set up 177
- fax troubleshooting
 - blocking junk faxes 100
 - caller ID is not shown 194
 - can receive but not send faxes 197
 - can send but not receive faxes 196
 - cannot send or receive a fax 195
 - received fax has poor print quality 197
- faxes
 - printed on both sides of the paper 98
- faxing
 - changing resolution 98
 - choosing a fax connection 82
 - creating shortcuts using the Embedded Web Server 96
 - creating shortcuts using the printer control panel 97
 - fax setup 81
 - forwarding faxes 99
 - improving fax quality 102
 - making a fax lighter or darker 98
 - sending a fax at a scheduled time 99
 - sending using the computer 94, 95
 - sending using the printer control panel 93
 - setting the date and time 92
 - setting the outgoing fax name and number 92
 - turning daylight saving time on or off 93
 - using shortcuts 97
 - using the address book 98
 - viewing a fax log 100
- FCC notices 212, 216, 219

- features
 - Scan Center 104
 - fiber optic
 - network setup 31
 - finding
 - information 8
 - publications 8
 - Web site 8
 - Finishing menu 136
 - flash drive 59
 - Flash Drive menu 132
 - flash memory card
 - installing 19
 - troubleshooting 199
 - font sample list
 - printing 65
 - Formatting Flash 177
 - forwarding faxes 99
- G**
- green settings
 - Eco-Mode 35
 - Power Saver 36
 - Quiet Mode 37
- H**
- Hex Trace 177
- I**
- Image menu 143
 - information, finding 8
 - installation
 - wireless network 27, 28
 - installing
 - options in driver 25
 - printer software 24, 94
 - installing printer software
 - adding options 25
 - Invalid Engine Code 177
 - Invalid Network Code 178
 - IPv6 menu 119
- J**
- jams
 - accessing 161
 - avoiding 40
 - understanding messages 161
 - jams, avoiding
 - cutting paper and specialty media 54
 - selecting paper and specialty media 54
- K**
- jams, clearing
 - 200-201 162
 - 202 164
 - 231 166
 - 233 167
 - 234 168
 - 235 168
 - 242 169
 - 251 170
 - 290-294 171
- L**
- labels, paper
 - tips 63
 - letterhead
 - copying to 70
 - loading 45
 - tips 61
 - light, indicator 15
 - Line busy 178
 - linking trays 51
 - Load <src> with <x> 178
 - Load manual feeder with <x> 178
 - loading
 - envelopes 49
 - manual feeder 49
 - multipurpose feeder 45
 - trays 41
- M**
- Macintosh
 - wireless network installation 28
 - manual feeder
 - loading 49
 - Memory full, cannot send faxes 178
 - menu settings
 - loading on multiple printers 159
 - menu settings page
 - printing 24
 - menus
 - Active NIC 116
 - AppleTalk 120
 - Configure MP 111
 - Copy Settings 125
 - Custom Scan Sizes 114
 - Custom Types 113
 - Default Source 108
 - diagram of 108
- N**
- Fax Settings 127
 - Finishing 136
 - Flash Drive 132
 - Image 143
 - IPv6 119
 - Network 116
 - Network Card 118
 - Network Reports 117
 - Paper Loading 112
 - Paper Texture 111
 - Paper Weight 112
 - PCL Emul 141
 - PDF 140
 - PostScript 140
 - Quality 138
 - Reports 115
 - Set Date and Time 143
 - Settings 122
 - Setup 135
 - Size/Type 109
 - TCP/IP 118
 - Universal Setup 114
 - USB 121
 - Utilities 139
 - Wireless 119
 - moving the printer 149
 - multiple pages on one sheet 74
 - multipurpose feeder
 - loading 45
- O**
- options
 - 250-sheet drawer 21
 - 550-sheet drawer 21
 - fax 101
 - flash memory card 19

- ordering
 - ADF pick assembly 151
 - ADF separator roll 151
 - toner cartridges 150
- P**
- paper
 - characteristics 53
 - letterhead 54
 - loading, multipurpose feeder 45
 - preprinted forms 54
 - recommended print side 54
 - recycled 34, 55
 - selecting 54
 - setting size 39
 - setting type 39
 - storing 55
 - unacceptable 54
 - Universal Paper Size 114
 - Universal size setting 39
- paper capacities
 - trays 50
- paper capacity
 - multipurpose feeder 50
- paper feed troubleshooting
 - message remains after jam is cleared 199
 - page that jammed does not reprint 199
- paper jams
 - avoiding 40
- paper jams, clearing
 - 200-201 162
 - 202 164
 - 231 166
 - 233 167
 - 234 168
 - 235 168
 - 242 169
 - 251 170
 - 290-294 171
- paper labels
 - loading 45
- Paper Loading menu 112
- paper sizes
 - supported by the printer 57
- Paper Texture menu 111
- paper types
 - duplex support 56
 - supported by printer 56
 - where to load 56
- Paper Weight menu 112
- pausing the current print job
 - to make copies 75, 192
- PCL Emul menu 141
- PDF menu 140
- photoconductor kit
 - ordering 150
 - replacing 153
- photos
 - copying 69
- PostScript menu 140
- Power Saver 179
 - adjusting 36
- print job
 - canceling from Macintosh 66
 - canceling from printer control panel 66
 - canceling from Windows 66
- print quality
 - cleaning the scanner glass 146
- print quality test pages
 - printing 65
- print quality troubleshooting
 - blank pages 200
 - characters have jagged edges 201
 - clipped images 201
 - ghost images 202
 - gray background 202
 - poor transparency quality 207
 - print is too dark 204
 - print is too light 205
 - print quality test pages 200
 - skewed print 206
 - solid black streaks 209
 - solid white streaks 209
 - streaked horizontal lines 207
 - streaked vertical lines 208
 - toner fog or background shading 206
 - toner rubs off 206
 - toner specks 207
- print quality, poor
 - avoiding by selecting paper and specialty media 54
- print troubleshooting
 - incorrect characters print 189
 - incorrect margins 203
 - job prints from wrong tray 189
 - job prints on wrong paper 189
 - job takes longer than expected 188
 - jobs do not print 187
 - Large jobs do not collate 189
 - multiple-language PDFs do not print 188
 - paper curl 203
 - paper frequently jams 199
 - tray linking does not work 189
 - unexpected page breaks occur 189
- printer
 - basic model 10
 - configurations 10
 - minimum clearances 9
 - moving 149
 - selecting a location 9
 - shipping 149
- printer control panel
 - factory defaults, restoring 157
- printer messages
 - 200.yy Paper jam 183
 - 201.yy Paper jam 184
 - 202.yy Paper jam 184
 - 231.yy Paper jam 184
 - 233.yy Paper jam 184
 - 234.yy Paper jam 185
 - 235.yy Paper jam 185
 - 24x.yy Paper jam 185
 - 251.yy Paper jam 185
 - 290-292 ADF Scanning Jams 186
 - 293 Paper Missing 186
 - 293.02 Flatbed Cover Open 186
 - 294 ADF Jam 186
 - 31.yy Replace defective or missing cartridge 180
 - 34 Short paper 180
 - 35 Insufficient memory to support Resource Save feature 181
 - 37 Insufficient memory for Flash Memory Defragment operation 181
 - 37 Insufficient memory to collate job 181
 - 38 Memory full 181
 - 39 Complex page, some data may not have printed 181
 - 51 Defective flash detected 181
 - 52 Not enough free space in flash memory for resources 182
 - 53 Unformatted flash detected 182
 - 54 Network <x> software error 182
 - 54 Standard network software error 182

56 Standard USB port
 disabled 182

58 Too many flash options
 installed 182

58 Too many trays attached 183

84 PC Kit life warning 183

84 Replace PC Kit 183

840.01 Scanner Disabled 186

840.02 Scanner Auto
 Disabled 187

88.yy Cartridge is low 183

Answering 176

Call complete 176

Close front door 176

Defragmenting Flash 176

DO NOT TOUCH Reading flash
 data DO NOT POWER OFF 177

Fax failed 177

Fax Station Name not set up 177

Fax Station Number not set
 up 177

Formatting Flash 177

Hex Trace 177

Invalid Engine Code 177

Invalid Network Code 178

Line busy 178

Load <src> with <x> 178

Load manual feeder with <x> 178

Memory full, cannot send
 faxes 178

Network 178

Network <x> 178

No analog phone line 178

No answer 178

No dial tone 179

Power Saver 179

Programing Engine Code 179

Programing flash 179

Programing System Code 179

Queued for sending 179

Remove packaging material, check
 <x> 179

Remove paper from standard
 output bin 179

Scanner ADF Cover Open 179

Scanner Jam Access Cover
 Open 180

Toner is low 180

Unsupported USB device, please
 remove 180

Unsupported USB hub, please
 remove 180

USB/USB <x> 180

Waiting 180

Waiting for redial 180

printer options troubleshooting
 drawers 198

flash memory card 199

option not working 198

printer problems, solving basic 176

printing
 directory list 65

font sample list 65

from flash drive 59

from Macintosh 59

from Windows 59

installing printer software 24, 94

menu settings page 24

network setup page 24

print quality test pages 65

two-sided (duplex) 61

Programing Engine Code 179

Programing flash 179

Programing System Code 179

publications, finding 8

Q

Quality menu 138

Queued for sending 179

Quiet Mode 37

R

recommended print side 54

recycled paper
 using 55

recycling 214

Lexmark packaging 37

Lexmark products 37

toner cartridges 37

WEEE statement 213

reducing a copy 72

Remove packaging material, check
 <x> 179

Remove paper from standard
 output bin 179

replacing
 photoconductor kit 153

toner cartridge 151

reports
 viewing 158

Reports menu 115

resolution, fax
 changing 98

S

safeguarding
 menus 158

safety information 6, 7

Scan Center features 104

Scan Profile options 105, 106

scan profile options 105

scan quality, improving 106

scan to a computer
 options 105, 106

scan troubleshooting
 cannot scan from a computer 194

partial document or photo
 scans 194

scan was not successful 193

scanner unit does not close 190

scanning takes too long or freezes
 the computer 193

scanner
 Automatic Document Feeder
 (ADF) 14

functions 13

scanner glass 14

Scanner ADF Cover Open 179

scanner glass
 cleaning 146

copying using 69

Scanner Jam Access Cover
 Open 180

scanning to a computer 103

improving scan quality 106

scanning to a flash drive 104

security
 protecting menus 158

sending a fax using the
 computer 94

Set Date and Time menu 143

setting
 paper size 39

paper type 39

TCP/IP address 118

Universal Paper Size 39

setting up the printer
 on a wired network
 (Macintosh) 31

on a wired network (Windows) 31

Settings menu 122

Setup menu 135

shipping the printer 149

shortcuts, creating
 e-mail 78

- fax destination 96, 97
- Size/Type menu 109
- specialty media
 - recommended print side 54
 - selecting 54
- status of supplies, checking 148
- storing
 - paper 55
 - supplies 148
- supplies
 - conserving 34
 - status of 148
 - storing 148
 - using recycled paper 34
- supplies, ordering
 - ADF pick assembly 151
 - ADF separator roll 151
 - photoconductor kit 150
 - toner cartridges 150
- supply notifications
 - configuring 159

T

- TCP/IP menu 118
- telecommunication
 - notices 216, 217, 218, 219
- tips
 - card stock 64
 - envelopes 63
 - labels, paper 63
 - letterhead 61
 - transparencies 62
- toner cartridge
 - replacing 151
- toner cartridges
 - ordering 150
 - recycling 37
- Toner is low 180
- transparencies
 - copying to 69
 - loading 45
 - tips 62
- tray linking 51, 52
- tray unlinking 51, 52
- trays
 - linking 51
 - loading 41
 - unlinking 51
- troubleshooting
 - checking an unresponsive printer 176
 - checking an unresponsive scanner 192
 - contacting Customer Support 210
 - solving basic printer problems 176
- troubleshooting, copy
 - copier does not respond 190
 - partial document or photo copies 192
 - poor copy quality 190
 - poor scanned image quality 193
 - scanner unit does not close 190
 - unable to pause print job to make copies 192
- troubleshooting, display
 - display is blank 176
 - display shows only diamonds 176
- troubleshooting, fax
 - blocking junk faxes 100
 - caller ID is not shown 194
 - can receive but not send faxes 197
 - can send but not receive faxes 196
 - cannot send or receive a fax 195
 - received fax has poor print quality 197
- troubleshooting, paper feed
 - message remains after jam is cleared 199
 - page that jammed does not reprint 199
- troubleshooting, print
 - incorrect characters print 189
 - incorrect margins 203
 - job prints from wrong tray 189
 - job prints on wrong paper 189
 - job takes longer than expected 188
 - jobs do not print 187
 - Large jobs do not collate 189
 - multiple-language PDFs do not print 188
 - paper curl 203
 - paper frequently jams 199
 - tray linking does not work 189
 - unexpected page breaks occur 189
- troubleshooting, print quality
 - blank pages 200
 - characters have jagged edges 201
 - clipped images 201

- ghost images 202
- gray background 202
- poor transparency quality 207
- print is too dark 204
- print is too light 205
- print quality test pages 200
- skewed print 206
- solid black streaks 209
- solid white streaks 209
- streaked horizontal lines 207
- streaked vertical lines 208
- toner fog or background shading 206
- toner rubs off 206
- toner specks 207

troubleshooting, printer options

- drawers 198
- flash memory card 199
- option not working 198

troubleshooting, scan

- cannot scan from a computer 194
- partial document or photo scans 194
- scan was not successful 193
- scanner unit does not close 190
- scanning takes too long or freezes the computer 193

U

- Universal Paper Size 114
 - setting 39
- Universal Setup menu 114
- unlinking trays 51
- Unsupported USB device, please remove 180
- Unsupported USB hub, please remove 180
- USB menu 121
- USB port 22
- USB/USB <x> 180
- Utilities menu 139

V

- viewing
 - reports 158

W

- Waiting 180
- Waiting for redial 180
- Web site
 - finding 8

Windows

- wireless network installation 27

wired network setup

- using Windows 31

wired networking

- using Macintosh 31

Wireless menu 119**wireless network**

- configuration information 26

- installation, using Macintosh 28

- installation, using Windows 27