

# Inspiron 23 Owner's Manual

Computer Model: Inspiron 23 Model 5348  
Regulatory Model: W10C  
Regulatory Type: W10C001

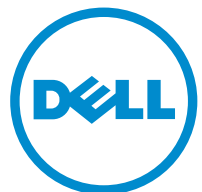

# Notes, Cautions, and Warnings

---



**NOTE:** A NOTE indicates important information that helps you make better use of your computer.



**CAUTION:** A CAUTION indicates either potential damage to hardware or loss of data and tells you how to avoid the problem.



**WARNING:** A WARNING indicates a potential for property damage, personal injury, or death.

---

**Copyright © 2014 Dell Inc. All rights reserved.** This product is protected by U.S. and international copyright and intellectual property laws. Dell™ and the Dell logo are trademarks of Dell Inc. in the United States and/or other jurisdictions. All other marks and names mentioned herein may be trademarks of their respective companies.

2014 - 03

Rev. A00

# Contents

<b>Before Working Inside Your Computer.....</b>	<b>10</b>
Before You Begin .....	10
Safety Instructions.....	10
Recommended Tools.....	11
<b>After Working Inside Your Computer.....</b>	<b>13</b>
<b>Technical Overview.....</b>	<b>14</b>
Inside View of Your Computer.....	14
System Board Components.....	15
<b>Removing the Stand Assembly.....</b>	<b>17</b>
Procedure.....	17
<b>Replacing the Stand Assembly.....</b>	<b>20</b>
Procedure.....	20
<b>Removing the Back Cover.....</b>	<b>21</b>
Prerequisites.....	21
Procedure.....	21
<b>Replacing the Back Cover.....</b>	<b>23</b>
Procedure.....	23
Post-requisites.....	23
<b>Removing the Speaker Cover.....</b>	<b>24</b>
Prerequisites.....	24
Procedure.....	24

<b>Replacing the Speaker Cover</b> .....	<b>25</b>
Procedure.....	25
Post-requisites.....	25
<b>Removing the Speakers</b> .....	<b>26</b>
Prerequisites.....	26
Procedure.....	26
<b>Replacing the Speakers</b> .....	<b>28</b>
Procedure.....	28
Post-requisites.....	28
<b>Removing the Memory Module(s)</b> .....	<b>29</b>
Prerequisites.....	29
Procedure.....	30
<b>Replacing the Memory Module(s)</b> .....	<b>32</b>
Procedure.....	33
Post-requisites.....	34
<b>Removing the System-Board Shield</b> .....	<b>35</b>
Prerequisites.....	35
Procedure.....	35
<b>Replacing the System-Board Shield</b> .....	<b>36</b>
Procedure.....	36
Post-requisites.....	36
<b>Removing the Hard Drive</b> .....	<b>37</b>
Prerequisites.....	37
Procedure.....	38

<b>Replacing the Hard Drive.....</b>	<b>40</b>
Procedure.....	40
Post-requisites.....	40
<b>Removing the VESA-Mount Bracket.....</b>	<b>41</b>
Prerequisites.....	41
Procedure.....	41
<b>Replacing the VESA-Mount Bracket.....</b>	<b>42</b>
Procedure.....	42
Post-requisites.....	42
<b>Removing the Control-Buttons Board.....</b>	<b>43</b>
Prerequisites.....	43
Procedure.....	43
<b>Replacing the Control-Buttons Board.....</b>	<b>45</b>
Procedure.....	45
Post-requisites.....	45
<b>Removing the Converter Board.....</b>	<b>46</b>
Prerequisites.....	46
Procedure.....	46
<b>Replacing the Converter Board.....</b>	<b>48</b>
Procedure.....	48
Post-requisites.....	48
<b>Removing the Power-Supply Diagnostic Board.....</b>	<b>49</b>
Prerequisites.....	49
Procedure.....	49

<b>Replacing the Power-Supply Diagnostic Board.....</b>	<b>51</b>
Procedure.....	51
Post-requisites.....	51
<b>Removing the Microphone.....</b>	<b>52</b>
Prerequisites.....	52
Procedure.....	52
<b>Replacing the Microphone.....</b>	<b>54</b>
Procedure.....	54
Post-requisites.....	54
<b>Removing the Wireless Card.....</b>	<b>55</b>
Prerequisites.....	55
Procedure.....	55
<b>Replacing the Wireless Card.....</b>	<b>56</b>
Procedure.....	56
Post-requisites.....	56
<b>Removing the Coin-Cell Battery.....</b>	<b>57</b>
Prerequisites.....	57
Procedure.....	58
<b>Replacing the Coin-Cell Battery.....</b>	<b>59</b>
Procedure.....	59
Post-requisites.....	59
<b>Removing the I/O Bracket.....</b>	<b>60</b>
Prerequisites.....	60
Procedure.....	61

<b>Replacing the I/O Bracket.....</b>	<b>63</b>
Procedure.....	63
Post-requisites.....	63
<b>Removing the Optical Drive.....</b>	<b>64</b>
Prerequisites.....	64
Procedure.....	65
<b>Replacing the Optical Drive.....</b>	<b>68</b>
Procedure.....	68
Post-requisites.....	68
<b>Removing the Power-Supply Fan.....</b>	<b>69</b>
Prerequisites.....	69
Procedure.....	70
<b>Replacing the Power-Supply Fan.....</b>	<b>72</b>
Procedure.....	72
Post-requisites.....	72
<b>Removing the Power-Supply Unit.....</b>	<b>73</b>
Prerequisites.....	73
Procedure.....	73
<b>Replacing the Power-Supply Unit.....</b>	<b>76</b>
Procedure.....	76
Post-requisites.....	76
<b>Removing the Processor Heat-Sink.....</b>	<b>77</b>
Prerequisites.....	77
Procedure.....	77

<b>Replacing the Processor Heat-Sink.....</b>	<b>79</b>
Procedure.....	79
Post-requisites.....	79
<b>Removing the Processor Fan.....</b>	<b>80</b>
Prerequisites.....	80
Procedure.....	80
<b>Replacing the Processor Fan.....</b>	<b>82</b>
Procedure.....	82
Post-requisites.....	82
<b>Removing the Processor.....</b>	<b>83</b>
Prerequisites.....	83
Procedure.....	83
<b>Replacing the Processor.....</b>	<b>85</b>
Procedure.....	85
Post-requisites.....	86
<b>Removing the System Board.....</b>	<b>87</b>
Prerequisites.....	87
Procedure.....	88
<b>Replacing the System Board.....</b>	<b>91</b>
Procedure.....	91
Post-requisites.....	91
Entering the Service Tag in the BIOS.....	92
<b>Removing the Camera.....</b>	<b>93</b>
Prerequisites.....	93
Procedure.....	94



<b>Replacing the Camera</b> .....	<b>95</b>
Procedure.....	95
Post-requisites.....	95
<b>Removing the Antenna</b> .....	<b>97</b>
Prerequisites.....	97
Procedure.....	97
<b>Replacing the Antenna</b> .....	<b>99</b>
Procedure.....	99
Post-requisites.....	99
<b>Removing the Display Panel</b> .....	<b>101</b>
Prerequisites.....	101
Procedure.....	102
<b>Replacing the Display Panel</b> .....	<b>108</b>
Procedure.....	108
Post-requisites.....	109
<b>Flashing the BIOS</b> .....	<b>110</b>
<b>Getting Help and Contacting Dell</b> .....	<b>111</b>
Self-Help Resources.....	111
Contacting Dell.....	111

# Before Working Inside Your Computer

---

 **CAUTION:** To avoid damaging the components and cards, handle them by their edges and avoid touching pins and contacts.

## Before You Begin

- 1 Save and close all open files and exit all open applications.
- 2 Shut down your computer.
  - Windows 8: Move your mouse pointer to the upper-right or lower-right corner of the screen to open the charms sidebar, and then click or tap **Settings** → **Power** → **Shut down**.
  - Windows 7: Click or tap **Start**  → **Shut down** .



**NOTE:** If you are using a different operating system, see the documentation of your operating system for shut-down instructions.

- 3 Disconnect your computer and all attached devices from their electrical outlets.
- 4 Disconnect all cables such as telephone cables, network cables and so on, from your computer.
- 5 Disconnect all attached devices and peripherals, such as keyboard, mouse, monitor, and so on, from your computer.
- 6 Remove any media card and optical disc from your computer, if applicable.
- 7 After the computer is unplugged, press and hold the power button for 5 seconds to ground the system board.











**CAUTION:** Place the computer on a flat, soft and clean surface to avoid scratching the display.

- 8 Place the computer face down.

## Safety Instructions

Use the following safety guidelines to protect your computer from potential damage and ensure your personal safety.

-  **WARNING:** Before working inside your computer, read the safety information that shipped with your computer. For more safety best practices, see the Regulatory Compliance home page at [dell.com/regulatory\\_compliance](http://dell.com/regulatory_compliance).
-  **WARNING:** Disconnect all power sources before opening the computer cover or panels. After you finish working inside the computer, replace all covers, panels, and screws before connecting to the power source.
-  **CAUTION:** To avoid damaging the computer, make sure that the work surface is flat and clean.
-  **CAUTION:** To avoid damaging the components and cards, handle them by their edges and avoid touching pins and contacts.
-  **CAUTION:** Only a certified service technician is authorized to remove the computer cover and access any of the components inside the computer. See the safety instructions for complete information about safety precautions, working inside your computer, and protecting against electrostatic discharge.
-  **CAUTION:** Before touching anything inside your computer, ground yourself by touching an unpainted metal surface, such as the metal at the back of the computer. While you work, periodically touch an unpainted metal surface to dissipate static electricity, which could harm internal components.
-  **CAUTION:** When you disconnect a cable, pull on its connector or on its pull-tab, not on the cable itself. Some cables have connectors with locking tabs or thumb-screws that you must disengage before disconnecting the cable. When disconnecting cables, keep them evenly aligned to avoid bending any connector pins. When connecting cables, make sure that the ports and connectors are correctly oriented and aligned.
-  **CAUTION:** To disconnect a network cable, first unplug the cable from your computer and then unplug the cable from the network device.
-  **CAUTION:** Press and eject any installed card from the media-card reader.

## Recommended Tools

The procedures in this document may require the following tools:

- Philips screwdriver
- Flat-head screwdriver
- Plastic scribe

# After Working Inside Your Computer

---



**CAUTION: Leaving stray or loose screws inside your computer may severely damage your computer.**

- 1 Replace all screws and make sure that no stray screws remain inside your computer.
- 2 Connect any external devices, peripherals, and cables you removed before working on your computer.
- 3 Replace any media cards, discs, and any other part(s) that you removed before working on your computer.
- 4 Connect your computer and all attached devices to their electrical outlets.
- 5 Turn on your computer.

# Technical Overview

**⚠ WARNING:** Before working inside your computer, read the safety information that shipped with your computer and follow the steps in [Before Working Inside Your Computer](#). After working inside your computer, follow the instructions in [After Working Inside Your Computer](#). For more safety best practices, see the Regulatory Compliance home page at [dell.com/regulatory\\_compliance](http://dell.com/regulatory_compliance).

## Inside View of Your Computer

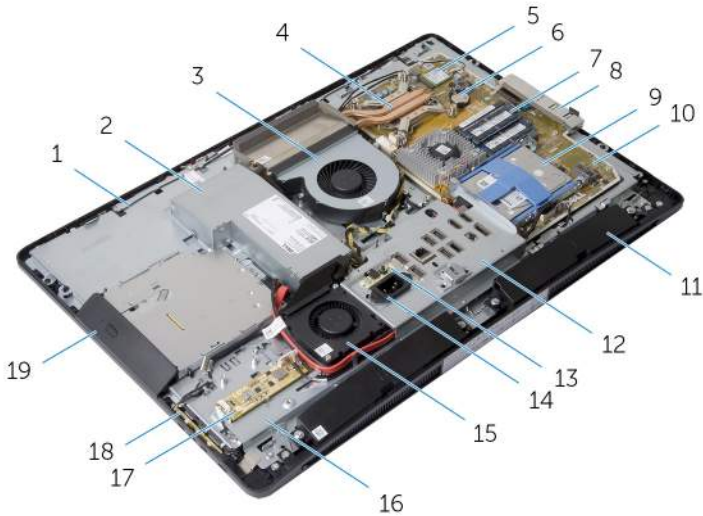

- |    |                               |    |                     |
|----|-------------------------------|----|---------------------|
| 1  | antennas (2)                  | 2  | power-supply unit   |
| 3  | processor fan                 | 4  | processor heat-sink |
| 5  | wireless card                 | 6  | coin-cell battery   |
| 7  | memory modules (2)            | 8  | side I/O bracket    |
| 9  | hard-drive assembly           | 10 | system board        |
| 11 | speakers (2)                  | 12 | I/O bracket         |
| 13 | power-supply diagnostic board | 14 | power port          |
| 15 | power-supply fan              | 16 | display-panel base  |

- 17 converter board
- 19 optical-drive assembly

- 18 control-buttons board

## System Board Components

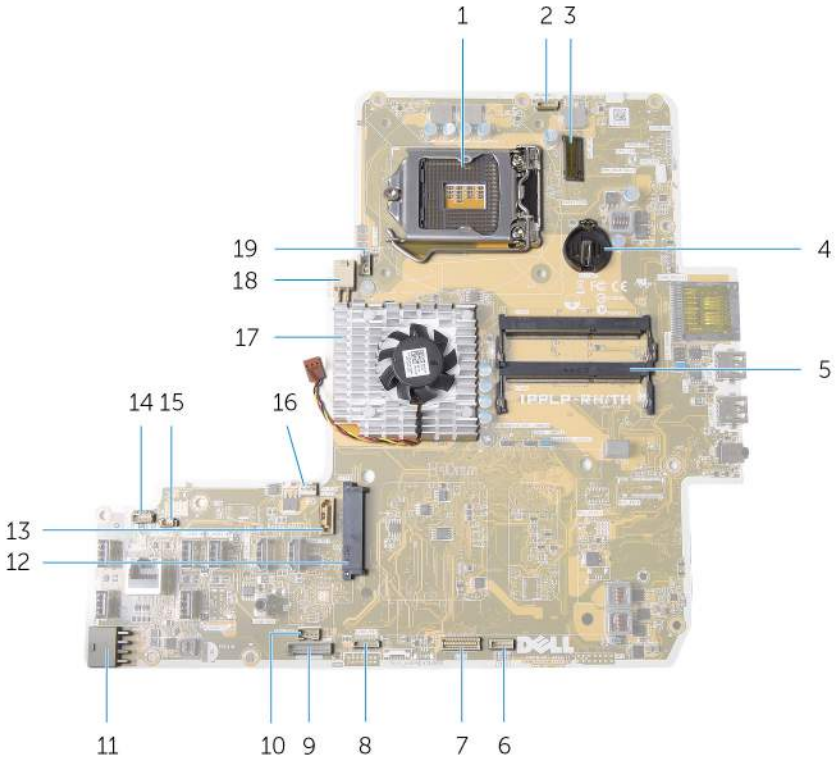

- |    |                                 |    |                                       |
|----|---------------------------------|----|---------------------------------------|
| 1  | processor socket                | 2  | camera-cable connector                |
| 3  | Mini Card slot                  | 4  | coin-cell battery socket              |
| 5  | memory-module connectors (2)    | 6  | speaker-cable connector               |
| 7  | display-cable connector         | 8  | control-buttons board cable connector |
| 9  | converter-board cable connector | 10 | optical-drive power cable connector   |
| 11 | main power-cable connector      | 12 | hard-drive connector                  |

- |    |                                    |    |                                     |
|----|------------------------------------|----|-------------------------------------|
| 13 | optical-drive data cable connector | 14 | touch-control board cable connector |
| 15 | power-supply fan cable connector   | 16 | video-card fan cable connector      |
| 17 | video-card heat sink               | 18 | processor power-cable connector     |
| 19 | processor-fan cable connector      |    |                                     |



# Removing the Stand Assembly

**⚠ WARNING:** Before working inside your computer, read the safety information that shipped with your computer and follow the steps in [Before Working Inside Your Computer](#). After working inside your computer, follow the instructions in [After Working Inside Your Computer](#). For more safety best practices, see the Regulatory Compliance home page at [dell.com/regulatory\\_compliance](http://dell.com/regulatory_compliance).

## Procedure

- 1 Press the stand-release button to release the stand.
- 2 Pivot the stand upward and remove the stand assembly away from the computer.



- 1 stand-release button

If you need to remove either the stand base or stand riser from the stand assembly, follow the steps below:

- 3 Release the screw handle on the stand base.

- 4 Using the screw handle, loosen the captive thumbscrew that secures the stand base to the stand riser.

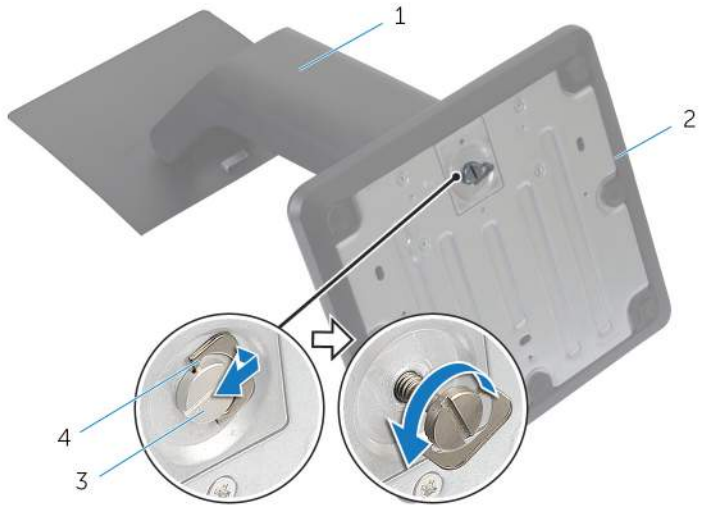

- |   |                    |   |              |
|---|--------------------|---|--------------|
| 1 | stand riser        | 2 | stand base   |
| 3 | captive thumbscrew | 4 | screw handle |

5 Slide the stand base off the stand riser.

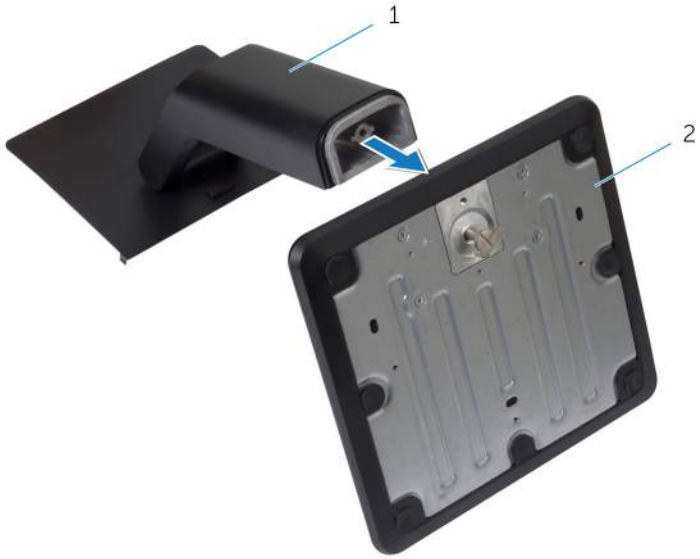

1 stand riser

2 stand base

# Replacing the Stand Assembly

---



**WARNING:** Before working inside your computer, read the safety information that shipped with your computer and follow the steps in [Before Working Inside Your Computer](#). After working inside your computer, follow the instructions in [After Working Inside Your Computer](#). For more safety best practices, see the Regulatory Compliance home page at [dell.com/regulatory\\_compliance](http://dell.com/regulatory_compliance).

## Procedure

- 1 Slide the tabs on the stand assembly into the slots on the back cover.
- 2 Lower the stand assembly to lock it into place.

If you have removed the stand base from the stand riser, follow the steps below:

- 3 Align the captive thumbscrew on the stand base with the screw hole on the stand riser and tighten it.
- 4 Fold the screw handle on the stand base.

# Removing the Back Cover

---

**⚠ WARNING:** Before working inside your computer, read the safety information that shipped with your computer and follow the steps in [Before Working Inside Your Computer](#). After working inside your computer, follow the instructions in [After Working Inside Your Computer](#). For more safety best practices, see the Regulatory Compliance home page at [dell.com/regulatory\\_compliance](http://dell.com/regulatory_compliance).

## Prerequisites

Remove the [stand assembly](#).

## Procedure

**⚠ CAUTION:** Do not remove the computer cover unless you need to install internal accessories for your computer.

- 1 Slide the release latches to the unlocked position indicated by a circle.



1 right release latch

2 left release latch

- 2 Using a plastic scribe, pry the back cover from the display bezel starting from the optical drive area.

3 Lift the back cover off the computer.



1 plastic scribe

2 back cover

# Replacing the Back Cover

---



**WARNING:** Before working inside your computer, read the safety information that shipped with your computer and follow the steps in [Before Working Inside Your Computer](#). After working inside your computer, follow the instructions in [After Working Inside Your Computer](#). For more safety best practices, see the Regulatory Compliance home page at [dell.com/regulatory\\_compliance](http://dell.com/regulatory_compliance).

## Procedure

- 1 Align the tabs on the back cover with the slots on the display bezel and snap the back cover into place.
- 2 Slide the release latches to the locked position.

## Post-requisites

Replace the [stand assembly](#).

# Removing the Speaker Cover

**!** **WARNING:** Before working inside your computer, read the safety information that shipped with your computer and follow the steps in [Before Working Inside Your Computer](#). After working inside your computer, follow the instructions in [After Working Inside Your Computer](#). For more safety best practices, see the Regulatory Compliance home page at [dell.com/regulatory\\_compliance](http://dell.com/regulatory_compliance).

## Prerequisites

- 1 Remove the [stand assembly](#).
- 2 Remove the [back cover](#).

## Procedure

- 1 Remove the screws that secure the speaker cover to the display-panel base.
- 2 Lift the speaker cover off the computer.

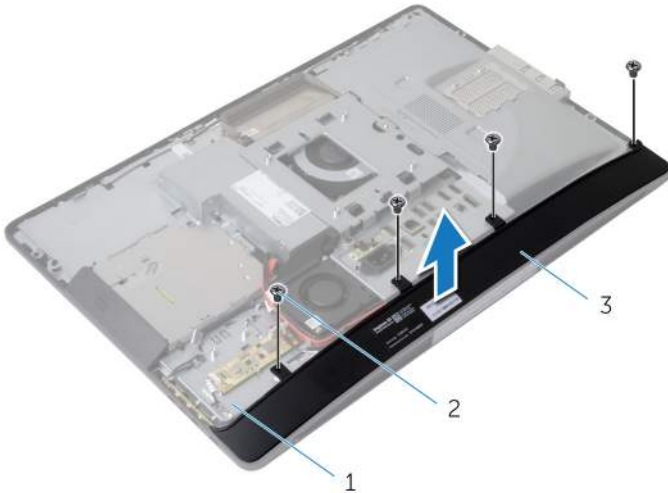

- |   |                    |   |            |
|---|--------------------|---|------------|
| 1 | display-panel base | 2 | screws (4) |
| 3 | speaker cover      |   |            |



# Replacing the Speaker Cover

---



**WARNING:** Before working inside your computer, read the safety information that shipped with your computer and follow the steps in [Before Working Inside Your Computer](#). After working inside your computer, follow the instructions in [After Working Inside Your Computer](#). For more safety best practices, see the Regulatory Compliance home page at [dell.com/regulatory\\_compliance](http://dell.com/regulatory_compliance).

## Procedure

- 1 Align the screw holes on the speaker cover with the screw holes on the display-panel base.
- 2 Replace the screws that secure the speaker cover to the display-panel base.

## Post-requisites

- 1 Replace the [back cover](#).
- 2 Replace the [stand assembly](#).

# Removing the Speakers

---



**WARNING:** Before working inside your computer, read the safety information that shipped with your computer and follow the steps in [Before Working Inside Your Computer](#). After working inside your computer, follow the instructions in [After Working Inside Your Computer](#). For more safety best practices, see the Regulatory Compliance home page at [dell.com/regulatory\\_compliance](http://dell.com/regulatory_compliance).

## Prerequisites

- 1 Remove the [stand assembly](#).
- 2 Remove the [back cover](#).
- 3 Remove the [speaker cover](#).

## Procedure

- 1 Disconnect the speaker cable from the system board.
- 2 Note the speaker-cable routing and remove the cable from the routing guide.
- 3 Remove the screws that secure the speakers to the display-panel base.

4 Lift the speakers off the display-panel base.

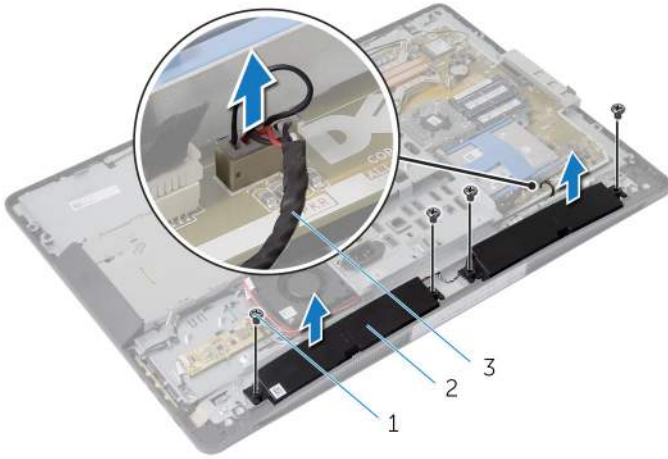

1 screws (4)

2 speakers (2)

3 speaker cable

# Replacing the Speakers

---



**WARNING:** Before working inside your computer, read the safety information that shipped with your computer and follow the steps in [Before Working Inside Your Computer](#). After working inside your computer, follow the instructions in [After Working Inside Your Computer](#). For more safety best practices, see the Regulatory Compliance home page at [dell.com/regulatory\\_compliance](http://dell.com/regulatory_compliance).

## Procedure

- 1 Align the screw holes on the speakers with the screw holes on the display-panel base.
- 2 Replace the screws that secure the speakers to the display-panel base.
- 3 Route the speaker cables through the routing guide on the display-panel base.
- 4 Connect the speaker cable to the system board.

## Post-requisites

- 1 Replace the [speaker cover](#).
- 2 Replace the [back cover](#).
- 3 Replace the [stand assembly](#).

# Removing the Memory Module(s)

---

 **WARNING:** Before working inside your computer, read the safety information that shipped with your computer and follow the steps in [Before Working Inside Your Computer](#). After working inside your computer, follow the instructions in [After Working Inside Your Computer](#). For more safety best practices, see the Regulatory Compliance home page at [dell.com/regulatory\\_compliance](http://dell.com/regulatory_compliance).

## Prerequisites

- 1 Remove the [stand assembly](#).
- 2 Remove the [back cover](#).

# Procedure

- 1 Using the tabs, pry the memory-module shield off the system-board shield.

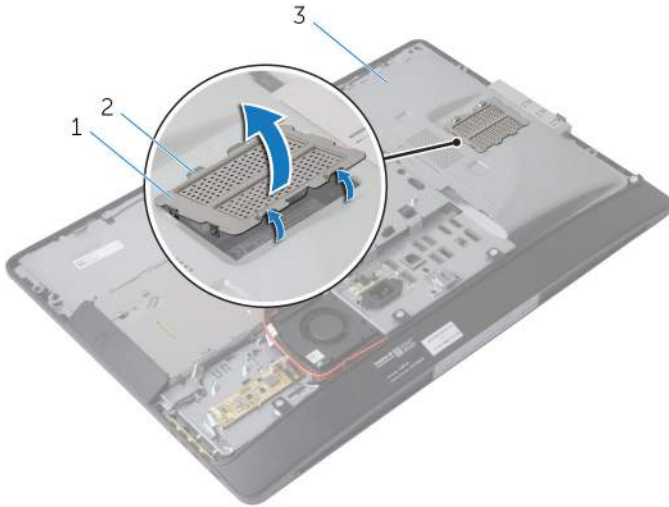

- |   |                      |   |          |
|---|----------------------|---|----------|
| 1 | memory-module shield | 2 | tabs (6) |
| 3 | system-board shield  |   |          |

- 2 Use your fingertips to carefully spread apart the securing clips on each end of the memory-module connector until the memory module pops up.

3 Remove the memory module from the memory-module connector.



- 1 memory-module connector
- 2 memory modules (2)
- 3 securing clips (4)

# Replacing the Memory Module(s)

---

 **WARNING:** Before working inside your computer, read the safety information that shipped with your computer and follow the steps in [Before Working Inside Your Computer](#). After working inside your computer, follow the instructions in [After Working Inside Your Computer](#). For more safety best practices, see the Regulatory Compliance home page at [dell.com/regulatory\\_compliance](http://dell.com/regulatory_compliance).



# Procedure

- 1 Align the notch on the memory module with the tab on the memory-module connector.
- 2 Insert the memory module into the memory-module connector, and press the memory module down until it clicks into place.

 **NOTE:** If you do not hear the click, remove the memory module and reinstall it.

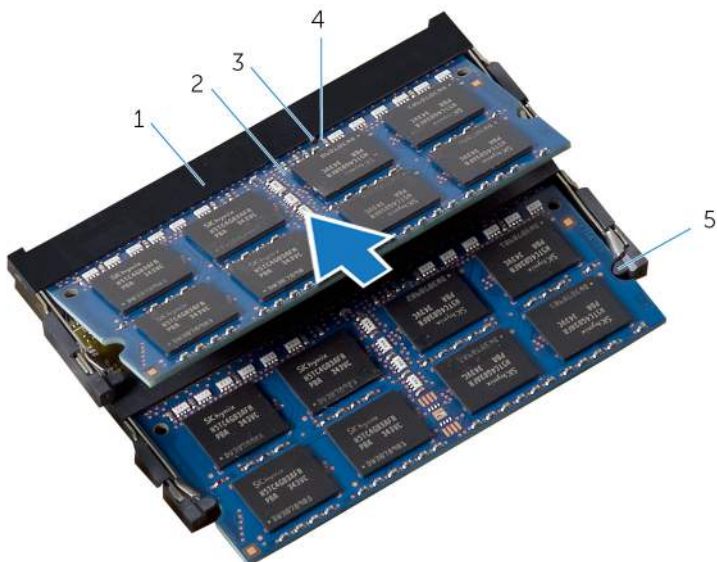

- |   |                         |   |                    |
|---|-------------------------|---|--------------------|
| 1 | memory-module connector | 2 | memory modules (2) |
| 3 | tab                     | 4 | notch              |
| 5 | securing clips (4)      |   |                    |

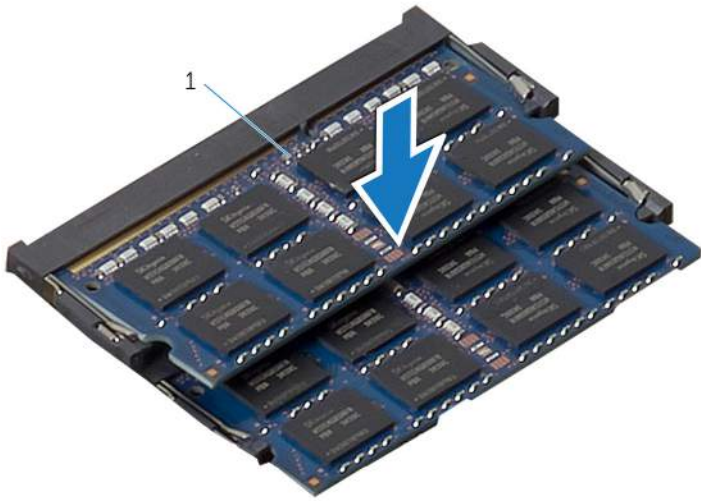

1 memory modules (2)

- 3 Slide the tabs on the memory-module shield under the tabs on the system-board shield until the memory-module shield is fully secured.

## Post-requisites

- 1 Replace the [back cover](#).
- 2 Replace the [stand assembly](#).

# Removing the System-Board Shield

---

**⚠ WARNING:** Before working inside your computer, read the safety information that shipped with your computer and follow the steps in [Before Working Inside Your Computer](#). After working inside your computer, follow the instructions in [After Working Inside Your Computer](#). For more safety best practices, see the Regulatory Compliance home page at [dell.com/regulatory\\_compliance](http://dell.com/regulatory_compliance).

## Prerequisites

- 1 Remove the [stand assembly](#).
- 2 Remove the [back cover](#).

## Procedure

- 1 Press the securing tab down and slide the system-board shield to release it from the slots on the display-panel base.
- 2 Lift the system-board shield off the computer.

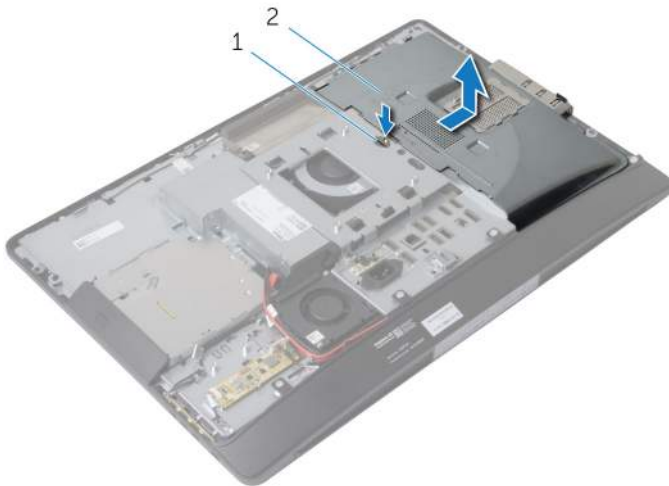

1 securing tab

2 system-board shield

# Replacing the System-Board Shield

---

 **WARNING:** Before working inside your computer, read the safety information that shipped with your computer and follow the steps in [Before Working Inside Your Computer](#). After working inside your computer, follow the instructions in [After Working Inside Your Computer](#). For more safety best practices, see the Regulatory Compliance home page at [dell.com/regulatory\\_compliance](http://dell.com/regulatory_compliance).

## Procedure

- 1 Align and place the system-board shield on the display-panel base.
- 2 Slide the tabs on the system-board shield into the slots on the display-panel base until it snaps into place.

## Post-requisites

- 1 Replace the [back cover](#).
- 2 Replace the [stand assembly](#).

# Removing the Hard Drive

---

 **WARNING:** Before working inside your computer, read the safety information that shipped with your computer and follow the steps in [Before Working Inside Your Computer](#). After working inside your computer, follow the instructions in [After Working Inside Your Computer](#). For more safety best practices, see the Regulatory Compliance home page at [dell.com/regulatory\\_compliance](http://dell.com/regulatory_compliance).

 **CAUTION:** Hard drives are fragile. Exercise care when handling the hard drive.

 **CAUTION:** To avoid data loss, do not remove the hard drive while the computer is in Sleep or On state.

## Prerequisites

- 1 Remove the [stand assembly](#).
- 2 Remove the [back cover](#).
- 3 Remove the [system-board shield](#).

# Procedure

- 1 Press down on the hard-drive bracket and slide the hard-drive assembly to release it from the hard-drive cage.
- 2 Lift the hard-drive assembly off the hard-drive cage.

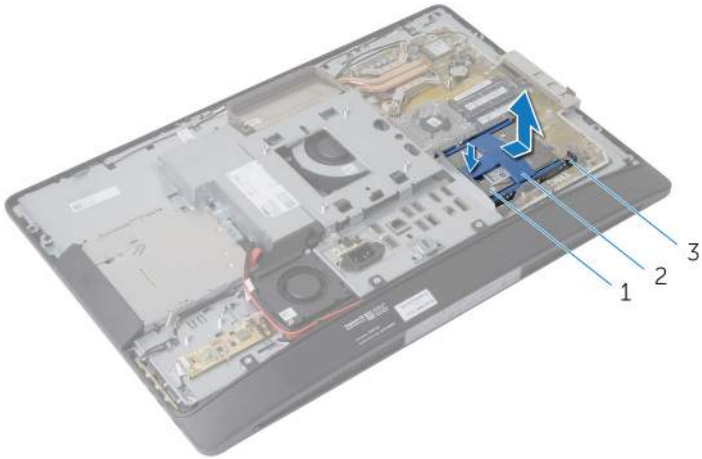

- 1 hard-drive assembly
- 3 hard-drive cage

- 2 hard-drive bracket

- 3** Gently pry the hard-drive bracket off the hard drive.

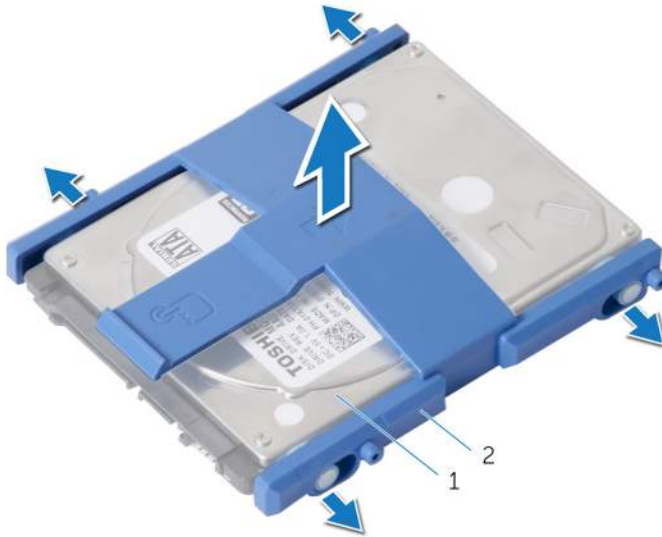

1 hard-drive

2 hard-drive bracket

- 4** Remove the screws that secure the hard-drive cage to the system board.  
**5** Lift the hard-drive cage off the system board.

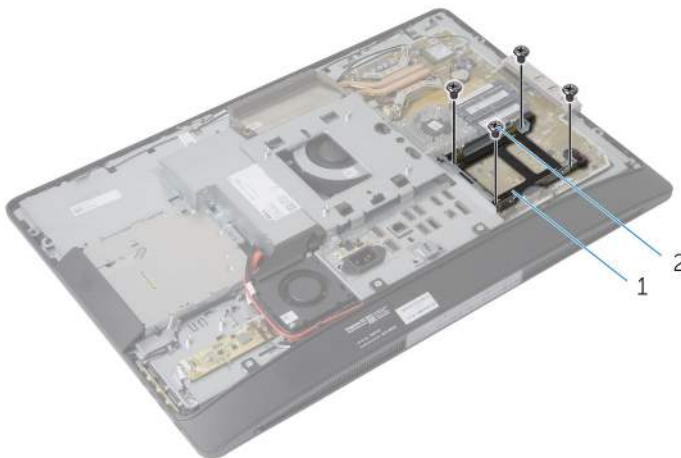



1 hard-drive cage

2 screws (4)

# Replacing the Hard Drive

---

 **WARNING:** Before working inside your computer, read the safety information that shipped with your computer and follow the steps in [Before Working Inside Your Computer](#). After working inside your computer, follow the instructions in [After Working Inside Your Computer](#). For more safety best practices, see the Regulatory Compliance home page at [dell.com/regulatory\\_compliance](http://dell.com/regulatory_compliance).

 **CAUTION:** Hard drives are fragile. Exercise care when handling the hard drive.

## Procedure

- 1 Align the screw holes on the hard-drive cage with the screw holes on the system board.
- 2 Replace the screws that secure the hard-drive cage to the system board.
- 3 Replace the hard-drive bracket to the hard drive.
- 4 Align the tabs on the hard-drive assembly with the slots on the hard-drive cage.
- 5 Slide the hard-drive assembly into the hard-drive cage until it snaps into position.

## Post-requisites

- 1 Replace the [system-board shield](#).
- 2 Replace the [back cover](#).
- 3 Replace the [stand assembly](#).



# Removing the VESA-Mount Bracket

---

**⚠ WARNING:** Before working inside your computer, read the safety information that shipped with your computer and follow the steps in [Before Working Inside Your Computer](#). After working inside your computer, follow the instructions in [After Working Inside Your Computer](#). For more safety best practices, see the Regulatory Compliance home page at [dell.com/regulatory\\_compliance](http://dell.com/regulatory_compliance).

## Prerequisites

- 1 Remove the [stand assembly](#).
- 2 Remove the [back cover](#).
- 3 Remove the [system-board shield](#).

## Procedure

- 1 Remove the screws that secure the VESA-mount bracket to the display-panel base.
- 2 Lift the VESA-mount bracket off the display-panel base.

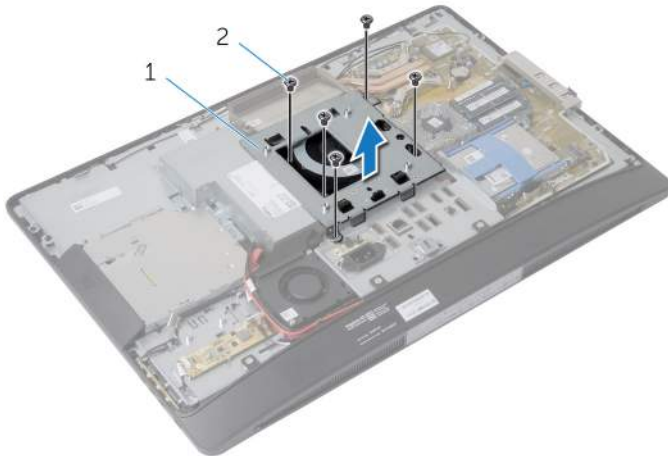

1 VESA-mount bracket

2 screws (5)

# Replacing the VESA-Mount Bracket

---



**WARNING:** Before working inside your computer, read the safety information that shipped with your computer and follow the steps in [Before Working Inside Your Computer](#). After working inside your computer, follow the instructions in [After Working Inside Your Computer](#). For more safety best practices, see the Regulatory Compliance home page at [dell.com/regulatory\\_compliance](http://dell.com/regulatory_compliance).

## Procedure

- 1 Align the screw holes on the VESA-mount bracket with the screw holes on the display-panel base.
- 2 Replace the screws that secure the VESA-mount bracket to the display-panel base.

## Post-requisites

- 1 Replace the [system-board shield](#).
- 2 Replace the [back cover](#).
- 3 Replace the [stand assembly](#).

# Removing the Control-Buttons Board

---



**WARNING:** Before working inside your computer, read the safety information that shipped with your computer and follow the steps in [Before Working Inside Your Computer](#). After working inside your computer, follow the instructions in [After Working Inside Your Computer](#). For more safety best practices, see the Regulatory Compliance home page at [dell.com/regulatory\\_compliance](http://dell.com/regulatory_compliance).

## Prerequisites

- 1 Remove the [stand assembly](#).
- 2 Remove the [back cover](#).

## Procedure

- 1 Remove the screw that connects the ground cable to the display-panel base.
- 2 Carefully pry and lift the control-buttons board off the display bezel.

- 3** Disconnect the control-buttons board cable from the connector on the control-buttons board.

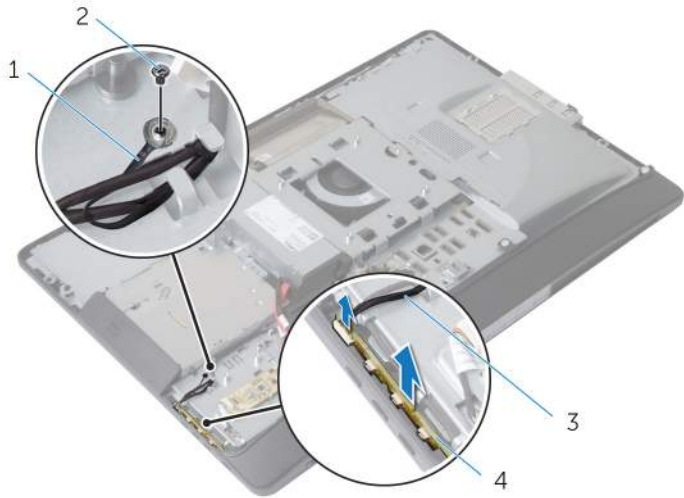

- |   |                             |   |                       |
|---|-----------------------------|---|-----------------------|
| 1 | ground cable                | 2 | screw                 |
| 3 | control-buttons board cable | 4 | control-buttons board |

# Replacing the Control-Buttons Board

---



**WARNING:** Before working inside your computer, read the safety information that shipped with your computer and follow the steps in [Before Working Inside Your Computer](#). After working inside your computer, follow the instructions in [After Working Inside Your Computer](#). For more safety best practices, see the Regulatory Compliance home page at [dell.com/regulatory\\_compliance](http://dell.com/regulatory_compliance).

## Procedure

- 1 Connect the control-buttons board cable to the connector on the control-buttons board.
- 2 Replace the control-buttons board into the slot on the display bezel.
- 3 Align the screw hole on the ground cable with the screw hole on the display-panel base.
- 4 Replace the screw that secures the ground cable to the display-panel base.

## Post-requisites

- 1 Replace the [back cover](#).
- 2 Replace the [stand assembly](#).

# Removing the Converter Board

---

 **WARNING:** Before working inside your computer, read the safety information that shipped with your computer and follow the steps in [Before Working Inside Your Computer](#). After working inside your computer, follow the instructions in [After Working Inside Your Computer](#). For more safety best practices, see the Regulatory Compliance home page at [dell.com/regulatory\\_compliance](http://dell.com/regulatory_compliance).

## Prerequisites

- 1 Remove the [stand assembly](#).
- 2 Remove the [back cover](#).

## Procedure

- 1 Disconnect the converter-board cable and display-backlight cable from the connectors on the convertor board.
- 2 Remove the screws that secure the convertor board to the display-panel base.

**3** Lift the converter board off the display-panel base.

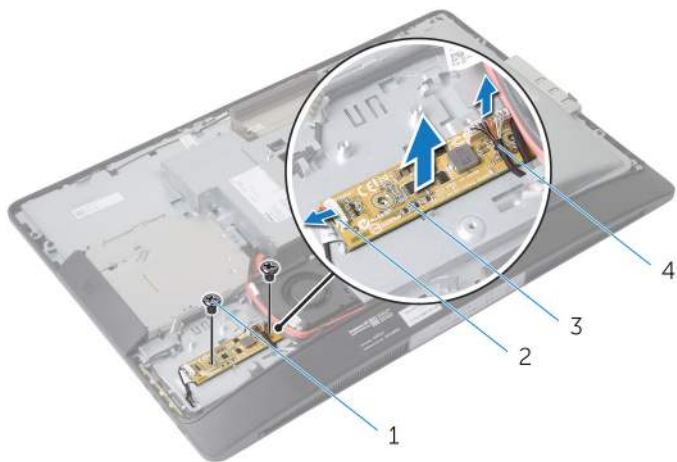

1 screws (2)

3 converter board

2 display-backlight cable

4 converter-board cable

# Replacing the Converter Board

---



**WARNING:** Before working inside your computer, read the safety information that shipped with your computer and follow the steps in [Before Working Inside Your Computer](#). After working inside your computer, follow the instructions in [After Working Inside Your Computer](#). For more safety best practices, see the Regulatory Compliance home page at [dell.com/regulatory\\_compliance](http://dell.com/regulatory_compliance).

## Procedure

- 1 Align the screw holes on the converter board with the screw holes on the display-panel base.
- 2 Replace the screws that secure the converter board to the display-panel base.
- 3 Connect the converter-board cable and display-backlight cable to the connectors on the convertor board.

## Post-requisites

- 1 Replace the [back cover](#).
- 2 Replace the [stand assembly](#).



# Removing the Power-Supply Diagnostic Board

---

 **WARNING:** Before working inside your computer, read the safety information that shipped with your computer and follow the steps in [Before Working Inside Your Computer](#). After working inside your computer, follow the instructions in [After Working Inside Your Computer](#). For more safety best practices, see the Regulatory Compliance home page at [dell.com/regulatory\\_compliance](http://dell.com/regulatory_compliance).

## Prerequisites

- 1 Remove the [stand assembly](#).
- 2 Remove the [back cover](#).
- 3 Remove the [system-board shield](#).
- 4 Remove the [VESA-mount bracket](#).

## Procedure

- 1 Disconnect the power-supply diagnostic board cable from the power-supply diagnostic board.
- 2 Remove the screw that secures the power-supply diagnostic board to the I/O bracket.

3 Lift the power-supply diagnostic board off the I/O bracket.

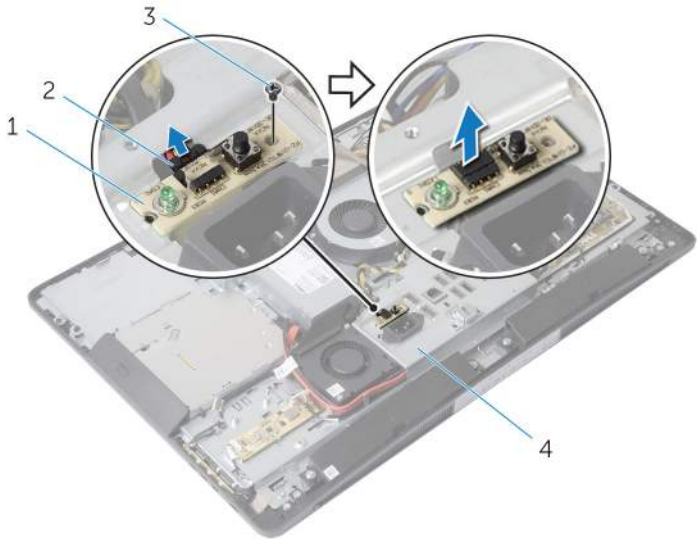

- 1 power-supply diagnostic board
- 3 screw

- 2 power-supply diagnostic board cable
- 4 I/O bracket

# Replacing the Power-Supply Diagnostic Board

---



**WARNING:** Before working inside your computer, read the safety information that shipped with your computer and follow the steps in [Before Working Inside Your Computer](#). After working inside your computer, follow the instructions in [After Working Inside Your Computer](#). For more safety best practices, see the Regulatory Compliance home page at [dell.com/regulatory\\_compliance](http://dell.com/regulatory_compliance).

## Procedure

- 1 Connect the power-supply diagnostic board cable to the connector on the power-supply diagnostic board.
- 2 Align the screw hole on the power-supply diagnostic board with the screw hole on the I/O bracket.
- 3 Replace the screw that secures the power-supply diagnostic board to the I/O bracket.

## Post-requisites

- 1 Replace the [VESA-mount bracket](#).
- 2 Replace the [system-board shield](#).
- 3 Replace the [back cover](#).
- 4 Replace the [stand assembly](#).

# Removing the Microphone

---



**WARNING:** Before working inside your computer, read the safety information that shipped with your computer and follow the steps in [Before Working Inside Your Computer](#). After working inside your computer, follow the instructions in [After Working Inside Your Computer](#). For more safety best practices, see the Regulatory Compliance home page at [dell.com/regulatory\\_compliance](http://dell.com/regulatory_compliance).

## Prerequisites

- 1 Remove the [stand assembly](#).
- 2 Remove the [back cover](#).

## Procedure

- 1 Remove the screws that secure the microphone bracket to the microphones.
- 2 Lift the microphone brackets off the display bezel.
- 3 Press the securing tabs to release the microphones and lift the microphones out of their slots on the display bezel.

4 Disconnect the microphone cables from the microphones.

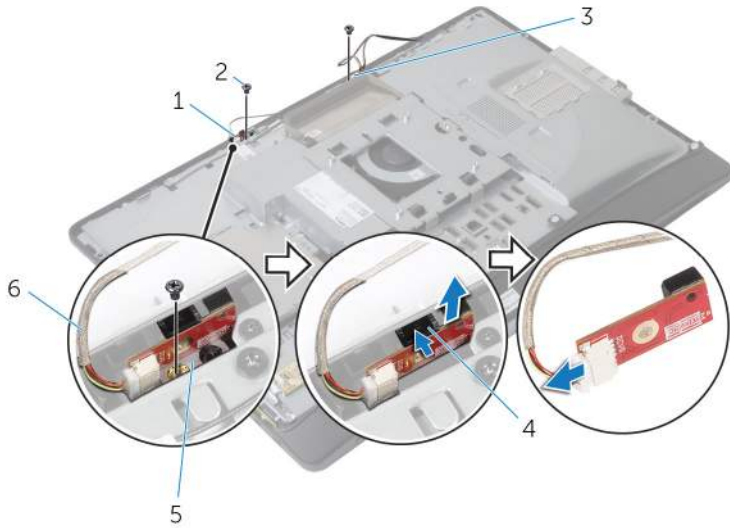

1 right microphone

2 screws (2)

3 left microphone

4 securing tabs (2)

5 microphone brackets (2)

6 microphone cables (2)

# Replacing the Microphone

---



**WARNING:** Before working inside your computer, read the safety information that shipped with your computer and follow the steps in [Before Working Inside Your Computer](#). After working inside your computer, follow the instructions in [After Working Inside Your Computer](#). For more safety best practices, see the Regulatory Compliance home page at [dell.com/regulatory\\_compliance](http://dell.com/regulatory_compliance).

## Procedure

- 1 Connect the microphone cables to the microphones.
- 2 Slide the microphones into the slots on the display bezel and make sure the securing tabs are in position.
- 3 Align the screw holes on the microphone brackets with the screw holes on the display bezel.
- 4 Replace the screws that secure the microphone brackets to the microphones.

## Post-requisites

- 1 Replace the [back cover](#).
- 2 Replace the [stand assembly](#).

# Removing the Wireless Card

**⚠ WARNING:** Before working inside your computer, read the safety information that shipped with your computer and follow the steps in [Before Working Inside Your Computer](#). After working inside your computer, follow the instructions in [After Working Inside Your Computer](#). For more safety best practices, see the Regulatory Compliance home page at [dell.com/regulatory\\_compliance](http://dell.com/regulatory_compliance).

## Prerequisites

- 1 Remove the [stand assembly](#).
- 2 Remove the [back cover](#).
- 3 Remove the [system-board shield](#).

## Procedure

- 1 Disconnect the antenna cables from the connectors on the wireless card.
- 2 Remove the screw that secures the wireless card to the system board.
- 3 Slide and remove the wireless card out of the Mini Card slot on the system board.

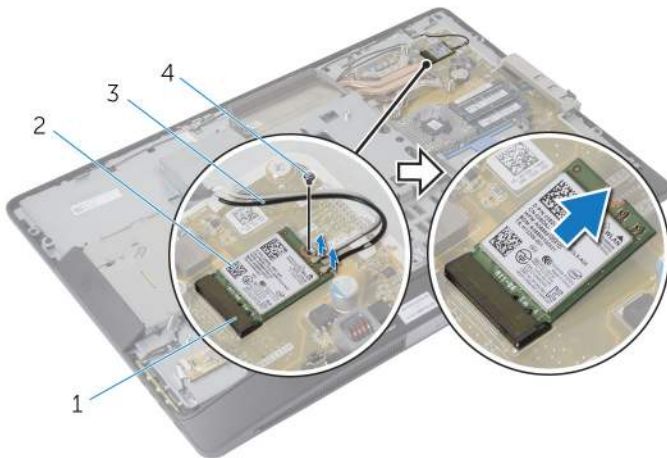

- |   |                |   |               |
|---|----------------|---|---------------|
| 1 | Mini Card slot | 2 | wireless card |
| 3 | antenna cables | 4 | screw         |

# Replacing the Wireless Card

---



**WARNING:** Before working inside your computer, read the safety information that shipped with your computer and follow the steps in [Before Working Inside Your Computer](#). After working inside your computer, follow the instructions in [After Working Inside Your Computer](#). For more safety best practices, see the Regulatory Compliance home page at [dell.com/regulatory\\_compliance](http://dell.com/regulatory_compliance).

## Procedure

- 1 Align the notch on the wireless card with the tab on the Mini Card slot.
- 2 Slide the wireless card at an angle into the Mini Card slot.
- 3 Press the other end of the wireless card down and replace the screw that secures the wireless card to the system board.
- 4 Connect the antenna cables to the wireless card.

The following table provides the antenna-cable color scheme for the wireless card supported by your computer:

Connectors on the wireless card	Antenna-cable color
Main (white triangle)	White
Auxiliary (black triangle)	Black



## Post-requisites

- 1 Replace the [system-board shield](#).
- 2 Replace the [back cover](#).
- 3 Replace the [stand assembly](#).



# Removing the Coin-Cell Battery

---

-  **WARNING:** Before working inside your computer, read the safety information that shipped with your computer and follow the steps in [Before Working Inside Your Computer](#). After working inside your computer, follow the instructions in [After Working Inside Your Computer](#). For more safety best practices, see the Regulatory Compliance home page at [dell.com/regulatory\\_compliance](http://dell.com/regulatory_compliance).
-  **CAUTION:** Removing the coin-cell battery resets the BIOS settings to default. It is recommended that you note the BIOS settings before removing the coin-cell battery.

## Prerequisites

- 1 Replace the [stand assembly](#).
- 2 Replace the [back cover](#).
- 3 Replace the [system-board shield](#).

# Procedure

**⚠ CAUTION:** Removing the coin-cell battery resets the BIOS settings to default. It is recommended that you note the BIOS settings before removing the coin-cell battery.

- 1 Locate the coin-cell battery socket on the system board. For more information, see [System Board Components](#).
- 2 Using a plastic scribe, press the securing clip away from the coin-cell battery until the coin-cell battery pops out.

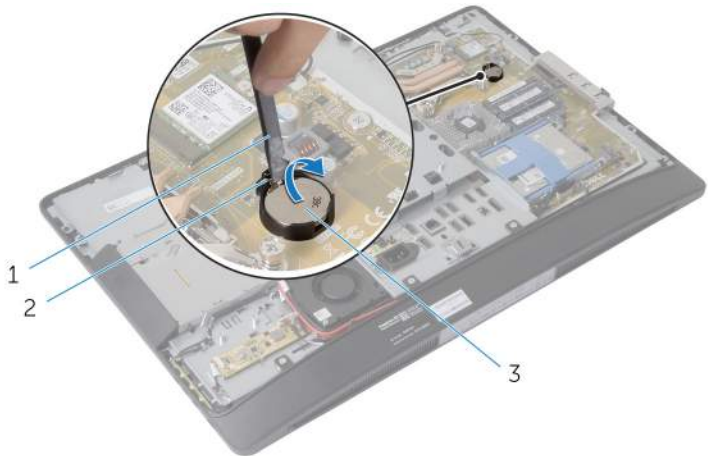

- |   |                   |   |               |
|---|-------------------|---|---------------|
| 1 | plastic scribe    | 2 | securing clip |
| 3 | coin-cell battery |   |               |

# Replacing the Coin-Cell Battery

---



**WARNING:** Before working inside your computer, read the safety information that shipped with your computer and follow the steps in [Before Working Inside Your Computer](#). After working inside your computer, follow the instructions in [After Working Inside Your Computer](#). For more safety best practices, see the Regulatory Compliance home page at [dell.com/regulatory\\_compliance](http://dell.com/regulatory_compliance).

## Procedure

With the positive-side facing up, insert the coin-cell battery into the battery socket and press down the battery into place.

## Post-requisites

- 1 Replace the [system-board shield](#).
- 2 Replace the [back cover](#).
- 3 Replace the [stand assembly](#).

# Removing the I/O Bracket

---



**WARNING:** Before working inside your computer, read the safety information that shipped with your computer and follow the steps in [Before Working Inside Your Computer](#). After working inside your computer, follow the instructions in [After Working Inside Your Computer](#). For more safety best practices, see the Regulatory Compliance home page at [dell.com/regulatory\\_compliance](http://dell.com/regulatory_compliance).

## Prerequisites

- 1 Remove the [stand assembly](#).
- 2 Remove the [back cover](#).
- 3 Remove the [system-board shield](#).
- 4 Remove the [VESA-mount bracket](#).
- 5 Remove the [power-supply diagnostic board](#).

# Procedure

- 1 Remove the screws that secure the power port to the I/O bracket.
- 2 Remove the screws that secure the I/O bracket to the display-panel base.

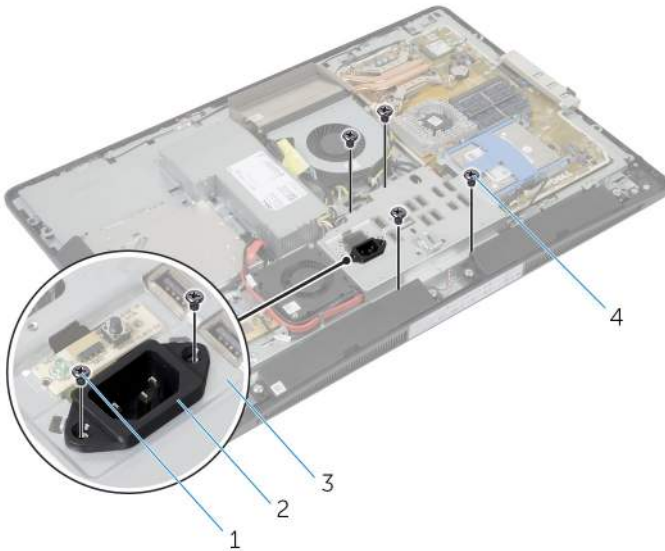

- |   |                       |   |                        |
|---|-----------------------|---|------------------------|
| 1 | power port screws (2) | 2 | power port             |
| 3 | I/O bracket           | 4 | I/O bracket screws (4) |

- 3 Lift the I/O bracket slightly and slide the power port through the I/O bracket.

4 Lift the I/O bracket off the display-panel base.

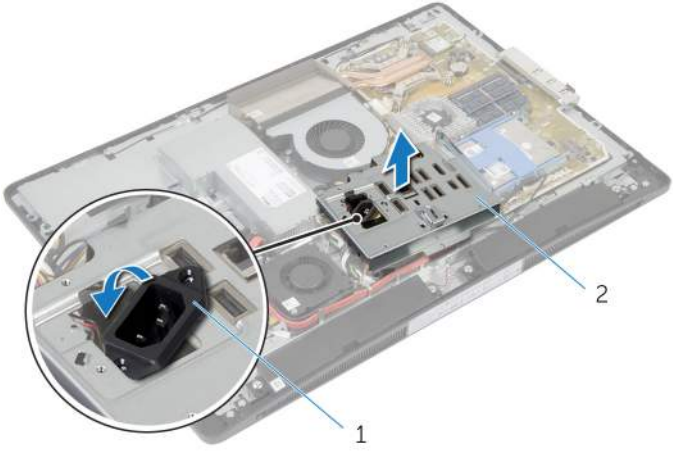

1 power port

2 I/O bracket

# Replacing the I/O Bracket

---



**WARNING:** Before working inside your computer, read the safety information that shipped with your computer and follow the steps in [Before Working Inside Your Computer](#). After working inside your computer, follow the instructions in [After Working Inside Your Computer](#). For more safety best practices, see the Regulatory Compliance home page at [dell.com/regulatory\\_compliance](http://dell.com/regulatory_compliance).

## Procedure

- 1 Slide the power port through the I/O bracket.
- 2 Align the screw holes on the I/O bracket with the screw holes on the display-panel base.
- 3 Replace the screws that secure the I/O bracket to the display-panel base.
- 4 Align the screw holes on the power port with the screw holes on the I/O bracket.
- 5 Replace the screws that secure the power port to the I/O bracket.

## Post-requisites

- 1 Replace the [power-supply diagnostic board](#).
- 2 Replace the [VESA-mount bracket](#).
- 3 Replace the [system-board shield](#).
- 4 Replace the [back cover](#).
- 5 Replace the [stand assembly](#).

# Removing the Optical Drive

---



**WARNING:** Before working inside your computer, read the safety information that shipped with your computer and follow the steps in [Before Working Inside Your Computer](#). After working inside your computer, follow the instructions in [After Working Inside Your Computer](#). For more safety best practices, see the Regulatory Compliance home page at [dell.com/regulatory\\_compliance](http://dell.com/regulatory_compliance).

## Prerequisites

- 1 Remove the [stand assembly](#).
- 2 Remove the [back cover](#).
- 3 Remove the [system-board shield](#).
- 4 Remove the [VESA-mount bracket](#).
- 5 Remove the [power-supply diagnostic board](#).
- 6 Remove the [I/O bracket](#).



# Procedure

- 1 Press the securing tab down and slide the optical-drive assembly to release it from the interposer.

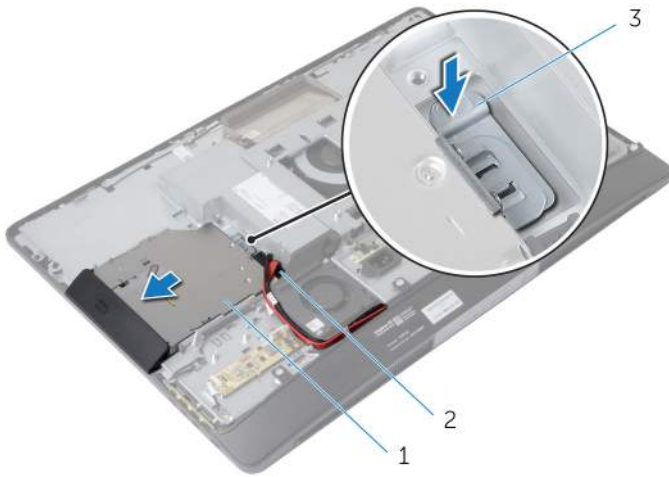

- |   |                        |   |            |
|---|------------------------|---|------------|
| 1 | optical-drive assembly | 2 | interposer |
| 3 | securing tab           |   |            |

- 2 Pivot the optical-drive bezel upward to release it from the optical-drive assembly.
- 3 Remove the screws that secure the optical-drive bracket to the optical drive.

- 4** Remove the optical-drive bracket from the optical drive.

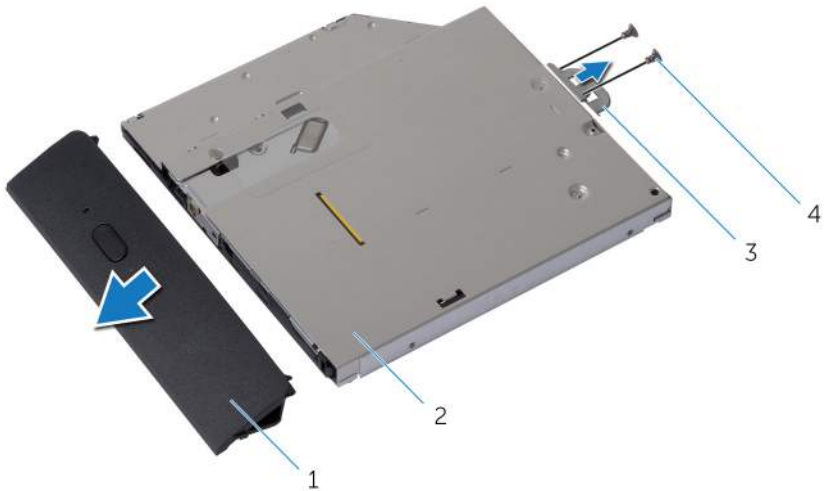

- |   |                       |   |               |
|---|-----------------------|---|---------------|
| 1 | optical-drive bezel   | 2 | optical drive |
| 3 | optical-drive bracket | 4 | screws (2)    |

- 5** Disconnect the power cable and data cable from the system board.
- 6** Remove the screws that secure the interposer to the display-panel base.
- 7** Remove the power cable and date cable from the routing guides on the display-panel base.

**8** Lift the interposer off the display-panel base.

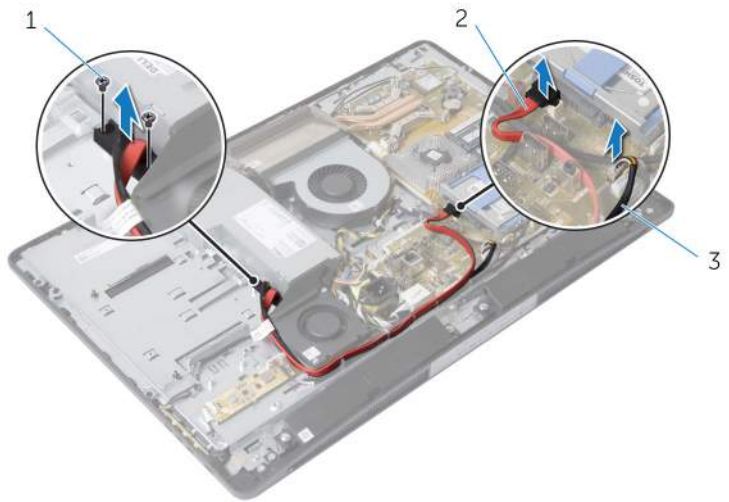

1 screws (2)

2 data cable

3 power cable

# Replacing the Optical Drive

---



**WARNING:** Before working inside your computer, read the safety information that shipped with your computer and follow the steps in [Before Working Inside Your Computer](#). After working inside your computer, follow the instructions in [After Working Inside Your Computer](#). For more safety best practices, see the Regulatory Compliance home page at [dell.com/regulatory\\_compliance](http://dell.com/regulatory_compliance).

## Procedure

- 1 Route the power cable and data cable through the routing guides on the display-panel base.
- 2 Align the screw holes on the interposer with the screw holes on the display-panel base.
- 3 Replace the screws that secure the interposer to the display-panel base.
- 4 Connect the power and data cables to the system board.
- 5 Align the screw holes on the optical-drive bracket with the screw holes on the optical drive.
- 6 Replace the screws that secure the optical-drive bracket to the optical drive.
- 7 Align the tabs on the optical-drive bezel with the slots on the optical-drive assembly and snap it into place.
- 8 Slide the optical-drive assembly into the optical-drive bay until it snaps into position.

## Post-requisites

- 1 Replace the [I/O bracket](#).
- 2 Replace the [power-supply diagnostic board](#).
- 3 Replace the [VESA-mount bracket](#).
- 4 Replace the [system-board shield](#).
- 5 Replace the [back cover](#).
- 6 Replace the [stand assembly](#).

# Removing the Power-Supply Fan

---

 **WARNING:** Before working inside your computer, read the safety information that shipped with your computer and follow the steps in [Before Working Inside Your Computer](#). After working inside your computer, follow the instructions in [After Working Inside Your Computer](#). For more safety best practices, see the Regulatory Compliance home page at [dell.com/regulatory\\_compliance](http://dell.com/regulatory_compliance).

## Prerequisites

- 1 Remove the [stand assembly](#).
- 2 Remove the [back cover](#).
- 3 Remove the [system-board shield](#).
- 4 Remove the [VESA-mount bracket](#).
- 5 Remove the [power-supply diagnostic board](#).
- 6 Remove the [I/O bracket](#).

# Procedure

- 1 Remove the screw that secures the power-supply fan bracket to the display-panel base.
- 2 Lift the power-supply fan bracket off the display-panel base.

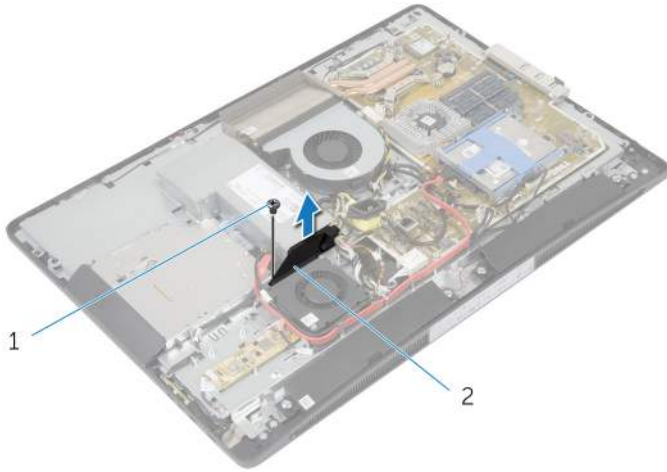

1 screw

2 power-supply fan bracket

- 3 Disconnect the power-supply fan cable from the power-supply unit.

- 4 Remove the screws that secure the power-supply fan to the display-panel base.

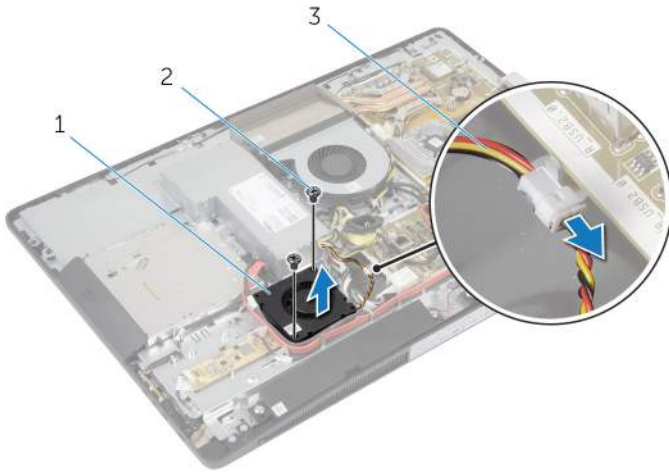

1 power-supply fan

2 screws (2)

3 power-supply fan cable

# Replacing the Power-Supply Fan

---



**WARNING:** Before working inside your computer, read the safety information that shipped with your computer and follow the steps in [Before Working Inside Your Computer](#). After working inside your computer, follow the instructions in [After Working Inside Your Computer](#). For more safety best practices, see the Regulatory Compliance home page at [dell.com/regulatory\\_compliance](http://dell.com/regulatory_compliance).

## Procedure

- 1 Connect the power-supply fan cable to the power-supply unit.
- 2 Align the screw holes on the power-supply fan with the screw holes on the display-panel base.
- 3 Replace the screws that secure the power-supply fan to the display-panel base.
- 4 Align the screw holes on the power-supply fan bracket with the screw holes on the display-panel base.
- 5 Replace the screw that secures the power-supply fan bracket to the display-panel base.

## Post-requisites

- 1 Replace the [I/O bracket](#).
- 2 Replace the [power-supply diagnostic board](#).
- 3 Replace the [VESA-mount bracket](#).
- 4 Replace the [system-board shield](#).
- 5 Replace the [back cover](#).
- 6 Replace the [stand assembly](#).



# Removing the Power-Supply Unit

---

 **WARNING:** Before working inside your computer, read the safety information that shipped with your computer and follow the steps in [Before Working Inside Your Computer](#). After working inside your computer, follow the instructions in [After Working Inside Your Computer](#). For more safety best practices, see the Regulatory Compliance home page at [dell.com/regulatory\\_compliance](http://dell.com/regulatory_compliance).

## Prerequisites

- 1 Remove the [stand assembly](#).
- 2 Remove the [back cover](#).
- 3 Remove the [system-board shield](#).
- 4 Remove the [VESA-mount bracket](#).
- 5 Remove the [power-supply diagnostic board](#).
- 6 Remove the [I/O bracket](#).

## Procedure

- 1 Disconnect the main power cable, processor power cable and power-supply fan cable from the system board.
- 2 Remove the main power cable, processor power cable and power-supply fan cable from the routing guides on the display-panel base.
- 3 Remove the power-port cable from the routing guides on the display-panel base.

- 4 Disconnect the power-supply fan cable from the power-supply unit.

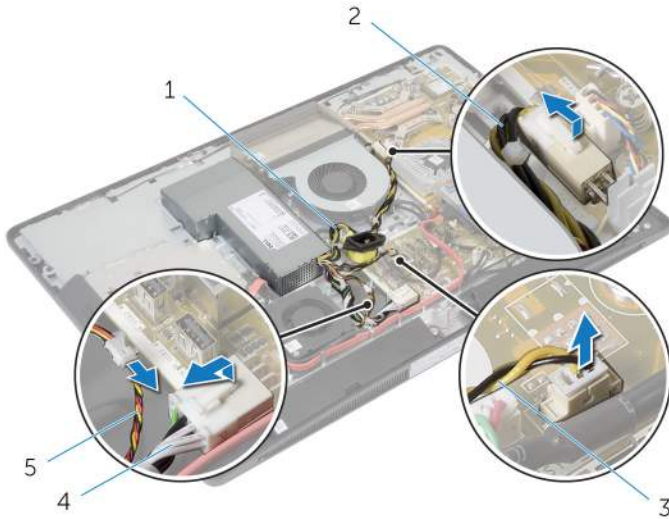

- |   |                        |   |                       |
|---|------------------------|---|-----------------------|
| 1 | power-port cable       | 2 | processor power cable |
| 3 | power-supply fan cable | 4 | main power cable      |
| 5 | power-supply fan cable |   |                       |

- 5 Remove the screw that secures the power-supply unit to the display-panel base.

- 6 Slide and lift the power-supply unit to release it from the display-panel base.

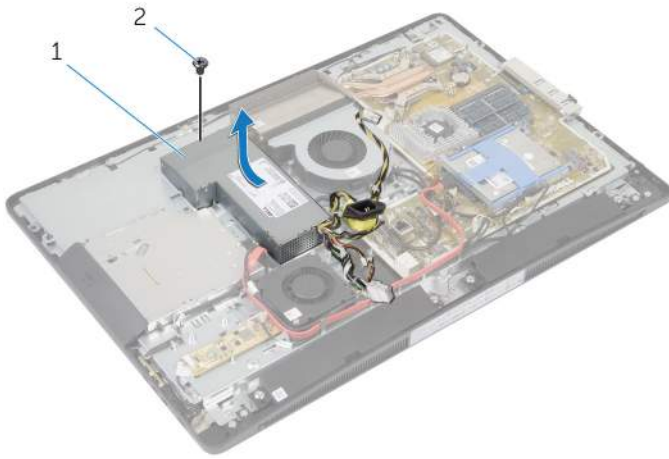

1 power-supply unit

2 screw

# Replacing the Power-Supply Unit

---



**WARNING:** Before working inside your computer, read the safety information that shipped with your computer and follow the steps in [Before Working Inside Your Computer](#). After working inside your computer, follow the instructions in [After Working Inside Your Computer](#). For more safety best practices, see the Regulatory Compliance home page at [dell.com/regulatory\\_compliance](http://dell.com/regulatory_compliance).

## Procedure

- 1 Place the power-supply unit on the display-panel base and slide it into position.
- 2 Align the screw hole and tabs on the power-supply unit with the screw hole and tabs on the display-panel base.
- 3 Replace the screw that secures the power-supply unit to the display-panel base.
- 4 Connect the power-supply fan cable to the power-supply unit.
- 5 Route the power-port cable through the routing guides on the display-panel base.
- 6 Route the main power cable, processor power cable and power-supply fan cable through the routing guides on the display-panel base.
- 7 Connect the main power cable, processor power cable and power-supply fan cable to the system board.

## Post-requisites

- 1 Replace the [I/O bracket](#).
- 2 Replace the [power-supply diagnostic board](#).
- 3 Replace the [VESA-mount bracket](#).
- 4 Replace the [system-board shield](#).
- 5 Replace the [back cover](#).
- 6 Replace the [stand assembly](#).

# Removing the Processor Heat-Sink

---

 **WARNING:** Before working inside your computer, read the safety information that shipped with your computer and follow the steps in [Before Working Inside Your Computer](#). After working inside your computer, follow the instructions in [After Working Inside Your Computer](#). For more safety best practices, see the Regulatory Compliance home page at [dell.com/regulatory\\_compliance](http://dell.com/regulatory_compliance).

## Prerequisites

- 1 Remove the [stand assembly](#).
- 2 Remove the [back cover](#).
- 3 Remove the [system-board shield](#).
- 4 Remove the [VESA-mount bracket](#).

## Procedure

- 1 Loosen the captive screws that secure the processor heat-sink to the system board.
- 2 Remove the screw that secures the processor heat-sink to the display-panel base.
- 3 Peel off the Mylar from the processor heat-sink and fan.

4 Lift the processor heat-sink off the system board.

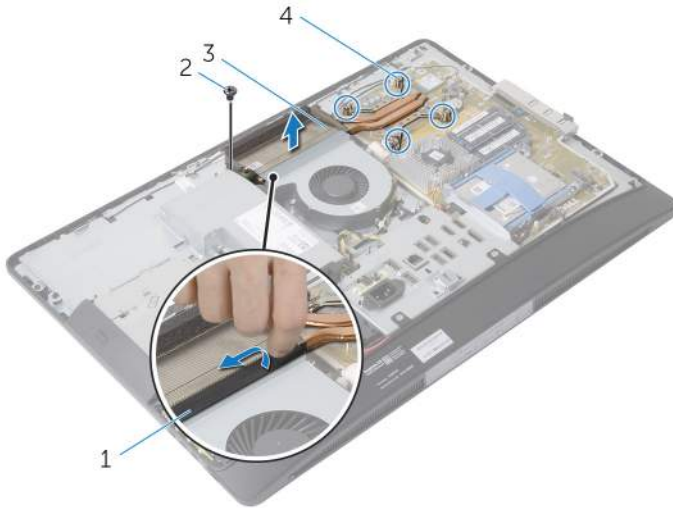

1 Mylar

2 screw

3 processor heat-sink

4 captive screws (4)

# Replacing the Processor Heat-Sink

---

 **WARNING:** Before working inside your computer, read the safety information that shipped with your computer and follow the steps in [Before Working Inside Your Computer](#). After working inside your computer, follow the instructions in [After Working Inside Your Computer](#). For more safety best practices, see the Regulatory Compliance home page at [dell.com/regulatory\\_compliance](http://dell.com/regulatory_compliance).

## Procedure

 **NOTE:** The original thermal grease can be reused, if the original processor and heat sink are reinstalled together. If either the processor or the heat sink is replaced, use the thermal pad provided in the kit to ensure that thermal conductivity is achieved.

- 1 Align the captive screws on the heat sink with the screw holes on the system board.
- 2 Tighten the captive screws that secure the processor heat-sink to the system board.
- 3 Adhere the Mylar to the processor heat-sink and fan.
- 4 Replace the screw that secures the processor heat-sink to the display-panel base.

## Post-requisites

- 1 Replace the [VESA-mount bracket](#).
- 2 Replace the [system-board shield](#).
- 3 Replace the [back cover](#).
- 4 Replace the [stand assembly](#).

# Removing the Processor Fan

---



**WARNING:** Before working inside your computer, read the safety information that shipped with your computer and follow the steps in [Before Working Inside Your Computer](#). After working inside your computer, follow the instructions in [After Working Inside Your Computer](#). For more safety best practices, see the Regulatory Compliance home page at [dell.com/regulatory\\_compliance](http://dell.com/regulatory_compliance).

## Prerequisites

- 1 Remove the [stand assembly](#).
- 2 Remove the [back cover](#).
- 3 Remove the [system-board shield](#).
- 4 Remove the [VESA-mount bracket](#).

## Procedure

- 1 Disconnect the processor-fan cable from the system board.
- 2 Remove the screws that secure the processor fan to the display-panel base.
- 3 Peel off the Mylar from the processor heat-sink and fan.



4 Lift the processor fan off the display-panel base.

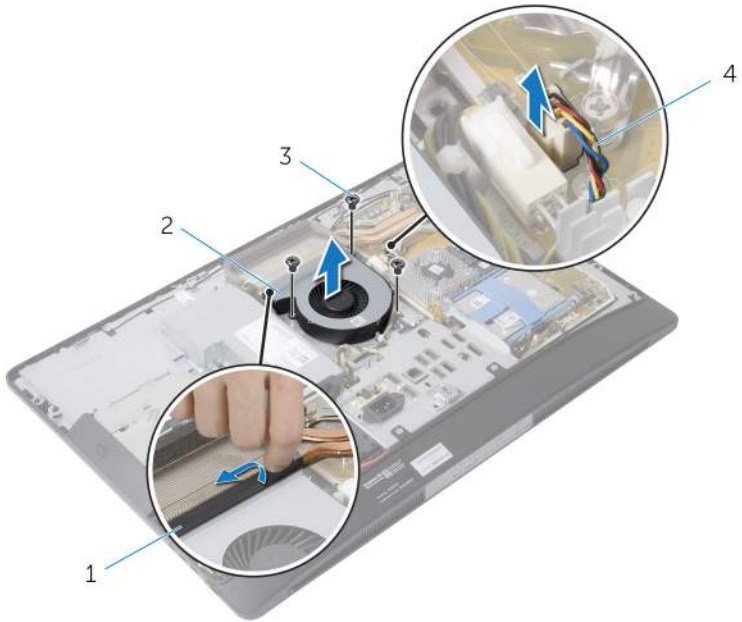

1 Mylar

2 processor fan

3 screws (3)

4 processor-fan cable

# Replacing the Processor Fan

---



**WARNING:** Before working inside your computer, read the safety information that shipped with your computer and follow the steps in [Before Working Inside Your Computer](#). After working inside your computer, follow the instructions in [After Working Inside Your Computer](#). For more safety best practices, see the Regulatory Compliance home page at [dell.com/regulatory\\_compliance](http://dell.com/regulatory_compliance).

## Procedure

- 1 Align the screw holes on the processor fan with the screw holes on the display-panel base.
- 2 Adhere the Mylar on the processor fan and the processor heat-sink.
- 3 Replace the screws that secure the processor fan to the display-panel base.
- 4 Connect the processor-fan cable to the system board.

## Post-requisites

- 1 Replace the [VESA-mount bracket](#).
- 2 Replace the [system-board shield](#).
- 3 Replace the [back cover](#).
- 4 Replace the [stand assembly](#).

# Removing the Processor

---



**WARNING:** Before working inside your computer, read the safety information that shipped with your computer and follow the steps in [Before Working Inside Your Computer](#). After working inside your computer, follow the instructions in [After Working Inside Your Computer](#). For more safety best practices, see the Regulatory Compliance home page at [dell.com/regulatory\\_compliance](http://dell.com/regulatory_compliance).

## Prerequisites

- 1 Remove the [stand assembly](#).
- 2 Remove the [back cover](#).
- 3 Remove the [system-board shield](#).
- 4 Remove the [processor heat-sink](#).
- 5 Remove the [processor fan](#).

## Procedure

- 1 Press the release lever down on the processor cover and then pull it outwards to release it from the tab that secures it.
- 2 Extend the release lever completely to open the processor cover.

3 Gently lift the processor and remove it from the processor socket.

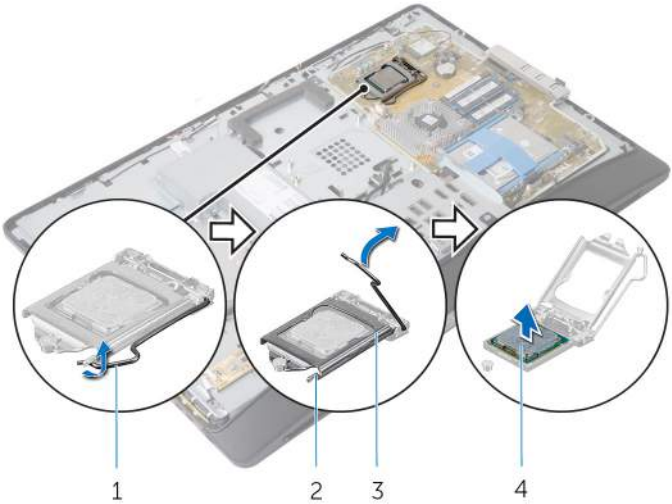



- 1 release lever
- 3 processor cover

- 2 securing tab
- 4 processor

# Replacing the Processor

---

 **WARNING:** Before working inside your computer, read the safety information that shipped with your computer and follow the steps in [Before Working Inside Your Computer](#). After working inside your computer, follow the instructions in [After Working Inside Your Computer](#). For more safety best practices, see the Regulatory Compliance home page at [dell.com/regulatory\\_compliance](http://dell.com/regulatory_compliance).

 **CAUTION:** If either the processor or the heat sink is replaced, use the thermal grease provided in the kit to make sure that thermal conductivity is achieved.

## Procedure

 **NOTE:** The original thermal grease can be reused, if the original processor and heat sink are reinstalled together. If either the processor or the heat sink is replaced, use the thermal pad provided in the kit to ensure that thermal conductivity is achieved.

 **CAUTION:** You must position the processor correctly in the processor socket to avoid permanent damage to the processor.

- 1 If the release lever on the socket is not fully extended, move it to that position.
- 2 Orient the alignment notches on the processor with the alignment tabs on the processor socket.
- 3 Align the pin-1 corner on the processor with the pin-1 corner on the processor socket, and then place the processor in the processor socket.

 **CAUTION:** Ensure that the processor-cover notch is positioned underneath the alignment post.

- 4 When the processor is fully seated in the socket, close the processor cover.

- Pivot the release lever down and place it under the tab on the processor cover.

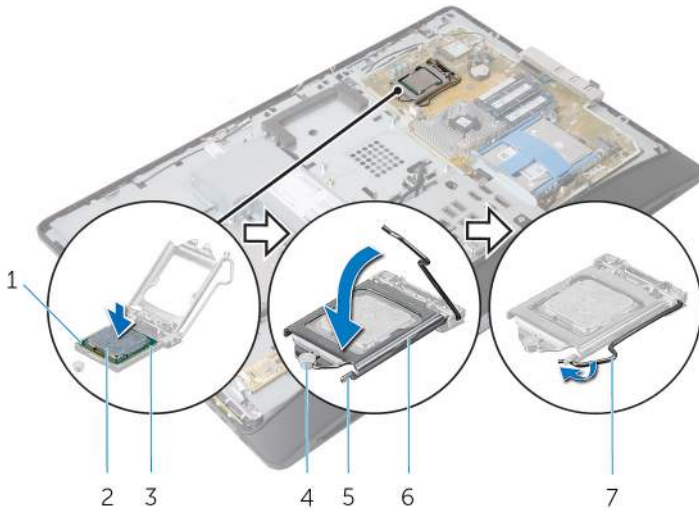

- |   |                           |   |                 |
|---|---------------------------|---|-----------------|
| 1 | processor pin-1 indicator | 2 | processor       |
| 3 | alignment tabs (2)        | 4 | alignment post  |
| 5 | securing tab              | 6 | processor cover |
| 7 | release lever             |   |                 |

## Post-requisites

- Replace the [processor fan](#).
- Replace the [processor heat-sink](#).
- Replace the [system-board shield](#).
- Replace the [back cover](#).
- Replace the [stand assembly](#).

# Removing the System Board

---



**WARNING:** Before working inside your computer, read the safety information that shipped with your computer and follow the steps in [Before Working Inside Your Computer](#). After working inside your computer, follow the instructions in [After Working Inside Your Computer](#). For more safety best practices, see the Regulatory Compliance home page at [dell.com/regulatory\\_compliance](http://dell.com/regulatory_compliance).



**NOTE:** Your computer's Service Tag is stored in the system board. You must enter the Service Tag in the system setup after you replace the system board.



**NOTE:** Replacing the system board removes any changes you have made to the BIOS using System Setup. Enter the Service Tag of your computer in the BIOS and make the desired changes again after you replace the system board.



**NOTE:** Before disconnecting the cables from the system board, note the location of the connectors so that you can reconnect them correctly after you replace the system board.

## Prerequisites

- 1 Remove the [stand assembly](#).
- 2 Remove the [back cover](#).
- 3 Remove the [memory module\(s\)](#).
- 4 Remove the [system-board shield](#).
- 5 Remove the [VESA-mount bracket](#).
- 6 Remove the [power-supply diagnostic board](#).
- 7 Remove the [I/O bracket](#).
- 8 Remove the [processor heat-sink](#).
- 9 Remove the [processor fan](#).
- 10 Remove the [processor](#).
- 11 Remove the [hard drive](#).
- 12 Remove the [wireless card](#).
- 13 Remove the [coin-cell battery](#).

## Procedure



**NOTE:** Your computer's Service Tag is stored in the system board. You must enter the Service Tag in the BIOS after you replace the system board.





**NOTE:** Before disconnecting the cables from the system board, note the location of the connectors and routing of the cables so that you can reconnect them correctly after you replace the system board.

- 1 Disconnect all the cables connected to the system board.

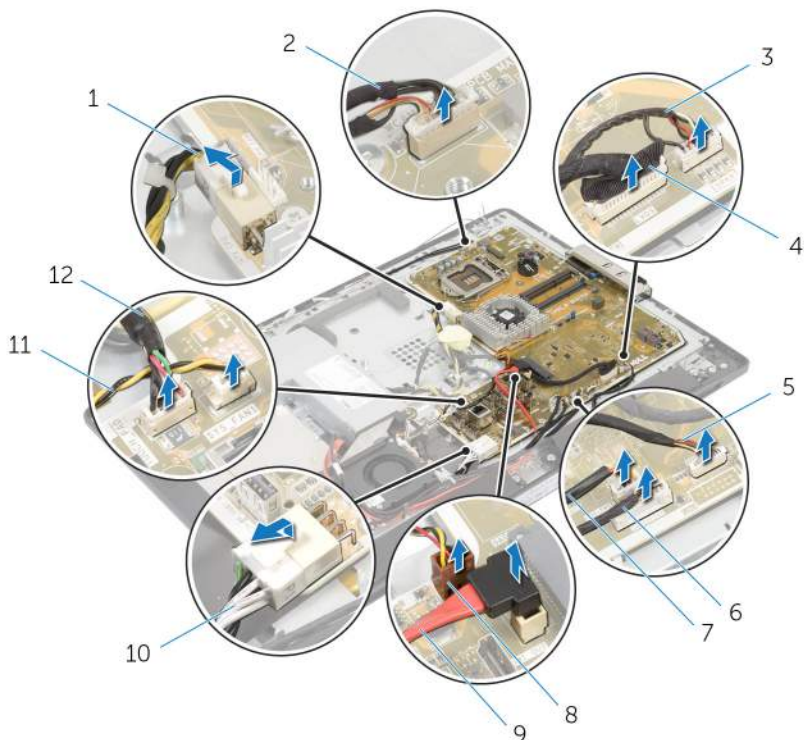

- |                               |                              |
|-------------------------------|------------------------------|
| 1 processor power cable       | 2 camera cable               |
| 3 speaker cable               | 4 display cable              |
| 5 control-buttons board cable | 6 converter-board cable      |
| 7 optical-drive power cable   | 8 video-card fan cable       |
| 9 optical-drive data cable    | 10 main-power cable          |
| 11 power-supply fan cable     | 12 touch-control board cable |

- 2 Remove the screws that secure the system board to the display-panel base.

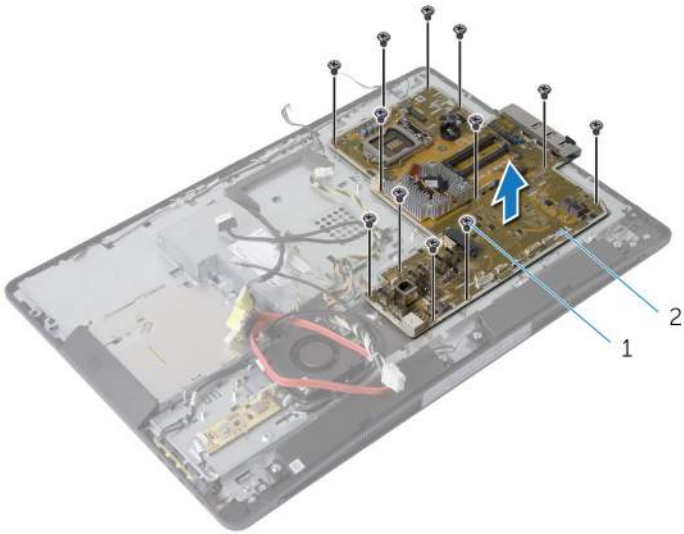

1 screws (12)

2 system board

- 3 Gently lift the system board at an angle and remove the side I/O bracket off the system board.
- 4 Lift the system board off the display-panel bracket.

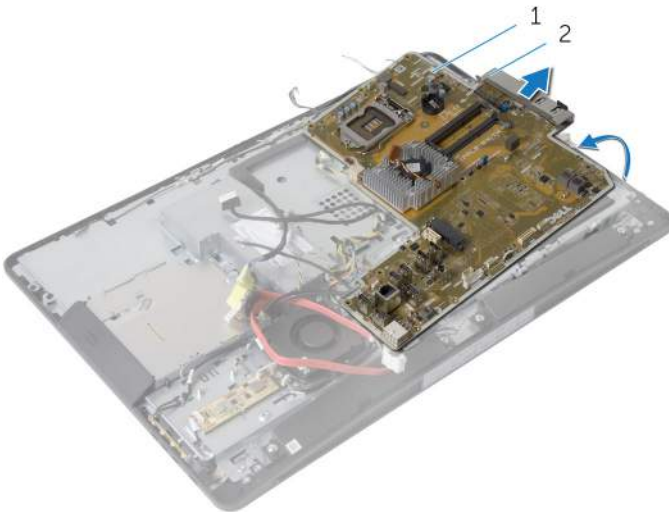

1 system board

2 side I/O bracket

# Replacing the System Board

---



**WARNING:** Before working inside your computer, read the safety information that shipped with your computer and follow the steps in [Before Working Inside Your Computer](#). After working inside your computer, follow the instructions in [After Working Inside Your Computer](#). For more safety best practices, see the Regulatory Compliance home page at [dell.com/regulatory\\_compliance](http://dell.com/regulatory_compliance).



**NOTE:** Your computer's Service Tag is stored in the system board. You must enter the Service Tag in the system setup after you replace the system board.

## Procedure

- 1 Replace the side I/O bracket on the system board.
- 2 Align the screw holes on the system board with the screw holes on the display-panel base.
- 3 Replace the screws that secure the system board to the chassis.
- 4 Route and connect all the cables to the connectors on the system board.

## Post-requisites

- 1 Replace the [coin-cell battery](#).
- 2 Replace the [wireless card](#).
- 3 Replace the [hard drive](#).
- 4 Replace the [processor](#).
- 5 Replace the [processor fan](#).
- 6 Replace the [processor heat-sink](#).
- 7 Replace the [I/O bracket](#).
- 8 Replace the [power-supply diagnostic board](#).
- 9 Replace the [VESA-mount bracket](#).
- 10 Replace the [system-board shield](#).
- 11 Replace the [memory module\(s\)](#).
- 12 Replace the [back cover](#).
- 13 Replace the [stand assembly](#).

# Entering the Service Tag in the BIOS

- 1 Turn on the computer.
- 2 Press <F2> when the DELL logo is displayed to enter the system setup program.
- 3 Navigate to the main tab and enter the Service Tag in the Service Tag Input field.

# Removing the Camera

---



**WARNING:** Before working inside your computer, read the safety information that shipped with your computer and follow the steps in [Before Working Inside Your Computer](#). After working inside your computer, follow the instructions in [After Working Inside Your Computer](#). For more safety best practices, see the Regulatory Compliance home page at [dell.com/regulatory\\_compliance](http://dell.com/regulatory_compliance).

## Prerequisites

- 1 Remove the [stand assembly](#).
- 2 Remove the [back cover](#).
- 3 Remove the [memory module\(s\)](#).
- 4 Remove the [system-board shield](#).
- 5 Remove the [hard drive](#).
- 6 Remove the [VESA-mount bracket](#).
- 7 Remove the [control-buttons board](#).
- 8 Remove the [converter board](#).
- 9 Remove the [power-supply diagnostic board](#).
- 10 Remove the [I/O bracket](#).
- 11 Remove the [optical drive](#).
- 12 Remove the [power-supply fan](#).
- 13 Remove the [power-supply unit](#).
- 14 Remove the [processor heat sink](#).
- 15 Remove the [processor fan](#).
- 16 Remove the [processor](#).
- 17 Remove the [wireless card](#).
- 18 Remove the [coin-cell battery](#).
- 19 Remove the [system board](#).
- 20 Follow the procedure from step 1 to step 6 in "Removing the [Display Panel](#)".

# Procedure

- 1 Remove the screw that secures the ground cable and the camera module to the display bezel.
- 2 Move the ground cable away to access the camera module.
- 3 Carefully lift the camera module out of the display bezel.
- 4 Disconnect the camera cable from the camera module.

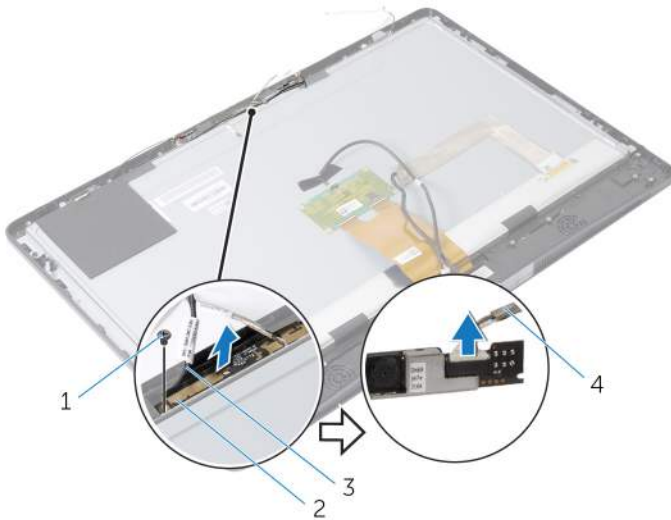

1 screw

3 ground cable

2 camera module

4 camera cable

# Replacing the Camera

---



**WARNING:** Before working inside your computer, read the safety information that shipped with your computer and follow the steps in [Before Working Inside Your Computer](#). After working inside your computer, follow the instructions in [After Working Inside Your Computer](#). For more safety best practices, see the Regulatory Compliance home page at [dell.com/regulatory\\_compliance](http://dell.com/regulatory_compliance).

## Procedure

- 1 Connect the camera cable to the camera module.
- 2 Align the screw hole on the ground cable and the camera module with the screw hole on the display bezel.
- 3 Replace the screw that secures the ground cable and the camera module to the display bezel.

## Post-requisites

- 1 Follow the procedure from step 11 to step 17 in "Replacing the [Display Panel](#)".
- 2 Replace the [system board](#).
- 3 Replace the [coin-cell battery](#).
- 4 Replace the [wireless card](#).
- 5 Replace the [processor](#).
- 6 Replace the [processor fan](#).
- 7 Replace the [processor heat-sink](#).
- 8 Replace the [power-supply unit](#).
- 9 Replace the [power-supply fan](#).
- 10 Replace the [optical drive](#).
- 11 Replace the [I/O bracket](#).
- 12 Replace the [power-supply diagnostic board](#).
- 13 Replace the [converter board](#).
- 14 Replace the [control buttons board](#).
- 15 Replace the [VESA-mount bracket](#).
- 16 Replace the [hard drive](#).
- 17 Replace the [system-board shield](#).

- 18** Replace the [memory module\(s\)](#).
- 19** Replace the [back cover](#).
- 20** Replace the [stand assembly](#).



# Removing the Antenna

---



**WARNING:** Before working inside your computer, read the safety information that shipped with your computer and follow the steps in [Before Working Inside Your Computer](#). After working inside your computer, follow the instructions in [After Working Inside Your Computer](#). For more safety best practices, see the Regulatory Compliance home page at [dell.com/regulatory\\_compliance](http://dell.com/regulatory_compliance).

## Prerequisites

- 1 Remove the [stand assembly](#).
- 2 Remove the [back cover](#).
- 3 Remove the [memory module\(s\)](#).
- 4 Remove the [system-board shield](#).
- 5 Remove the [hard drive](#).
- 6 Remove the [VESA-mount bracket](#).
- 7 Remove the [control-buttons board](#).
- 8 Remove the [converter board](#).
- 9 Remove the [power-supply diagnostic board](#).
- 10 Remove the [I/O bracket](#).
- 11 Remove the [optical drive](#).
- 12 Remove the [power-supply fan](#).
- 13 Remove the [power-supply unit](#).
- 14 Remove the [processor heat sink](#).
- 15 Remove the [processor fan](#).
- 16 Remove the [processor](#).
- 17 Remove the [wireless card](#).
- 18 Remove the [coin-cell battery](#).
- 19 Remove the [system board](#).

## Procedure

- 1 Peel the tape that secures the antenna modules to the display bezel.
- 2 Remove the screws that secure the antenna modules to the display bezel.
- 3 Note the antenna-cable routing and remove the antenna cables from the routing guides on the display-panel base.

4 Lift the antenna modules off the display bezel.

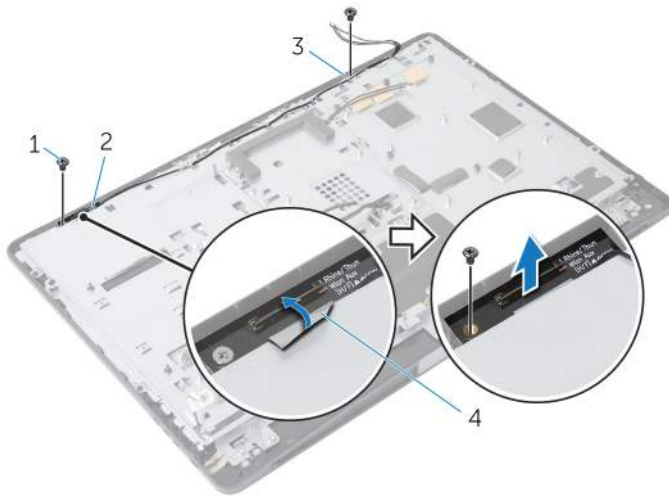

1 screws (2)

2 right antenna module

3 left antenna module

4 securing tape

# Replacing the Antenna

---



**WARNING:** Before working inside your computer, read the safety information that shipped with your computer and follow the steps in [Before Working Inside Your Computer](#). After working inside your computer, follow the instructions in [After Working Inside Your Computer](#). For more safety best practices, see the Regulatory Compliance home page at [dell.com/regulatory\\_compliance](http://dell.com/regulatory_compliance).

## Procedure

- 1 Align the screw holes on the antenna modules with the screw holes on the display bezel.
- 2 Replace the screws that secure the antenna modules to the display bezel.
- 3 Route the antenna cables through the routing guides on the display-panel base.
- 4 Adhere the tape to secure the antenna modules to the display bezel.

## Post-requisites

- 1 Replace the [system board](#).
- 2 Replace the [coin-cell battery](#).
- 3 Replace the [wireless card](#).
- 4 Replace the [processor](#).
- 5 Replace the [processor fan](#).
- 6 Replace the [processor heat-sink](#).
- 7 Replace the [power-supply unit](#).
- 8 Replace the [power-supply fan](#).
- 9 Replace the [optical drive](#).
- 10 Replace the [I/O bracket](#).
- 11 Replace the [power-supply diagnostic board](#).
- 12 Replace the [converter board](#).
- 13 Replace the [control buttons board](#).
- 14 Replace the [VESA-mount bracket](#).
- 15 Replace the [hard drive](#).
- 16 Replace the [system-board shield](#).
- 17 Replace the [memory module\(s\)](#).

- 18** Replace the [back cover](#).
- 19** Replace the [stand assembly](#).

# Removing the Display Panel

---



**WARNING:** Before working inside your computer, read the safety information that shipped with your computer and follow the steps in [Before Working Inside Your Computer](#). After working inside your computer, follow the instructions in [After Working Inside Your Computer](#). For more safety best practices, see the Regulatory Compliance home page at [dell.com/regulatory\\_compliance](http://dell.com/regulatory_compliance).

## Prerequisites

- 1 Remove the [stand assembly](#).
- 2 Remove the [back cover](#).
- 3 Remove the [memory module\(s\)](#).
- 4 Remove the [system-board shield](#).
- 5 Remove the [hard drive](#).
- 6 Remove the [VESA-mount bracket](#).
- 7 Remove the [converter board](#).
- 8 Remove the [power-supply diagnostic board](#).
- 9 Remove the [I/O bracket](#).
- 10 Remove the [optical drive](#).
- 11 Remove the [power-supply fan](#).
- 12 Remove the [power-supply unit](#).
- 13 Remove the [processor heat sink](#).
- 14 Remove the [processor fan](#).
- 15 Remove the [processor](#).
- 16 Remove the [wireless card](#).
- 17 Remove the [coin-cell battery](#).
- 18 Remove the [system board](#).
- 19 Remove the [speaker cover](#).
- 20 Remove the [speakers](#).
- 21 Remove the [camera](#).
- 22 Remove the [antennas](#).

# Procedure

- 1 Remove the screw that secures the ground cable to the display-panel base.
- 2 Remove the screws that secure the release latches to the display-panel base.
- 3 Lift the release latches off the display-panel base.
- 4 Rotate and lift the release-latch brackets off the display-panel base.

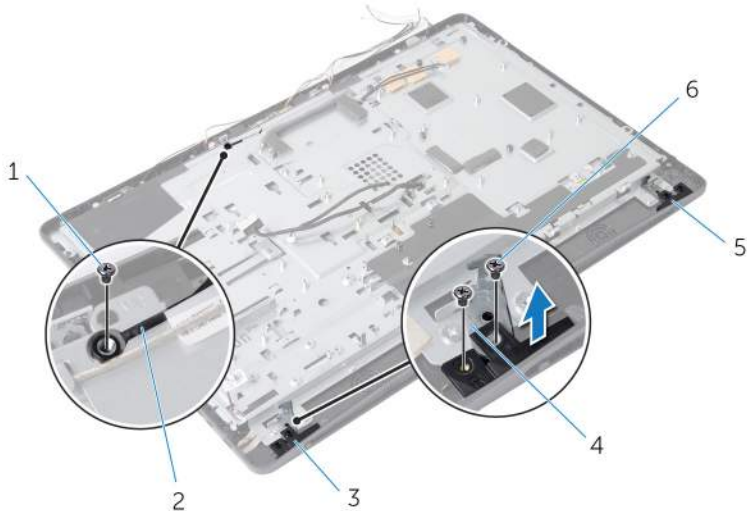

- |   |                     |   |                            |
|---|---------------------|---|----------------------------|
| 1 | ground cable screw  | 2 | ground cable               |
| 3 | right release latch | 4 | release-latch brackets (2) |
| 5 | left release latch  | 6 | release latch screws (4)   |

- 5 Remove the screws that secure the display-panel base to the display bezel.
- 6 Slide all the cables through the slot on the display-panel base.

- 7** Lift the display-panel base off the display bezel.

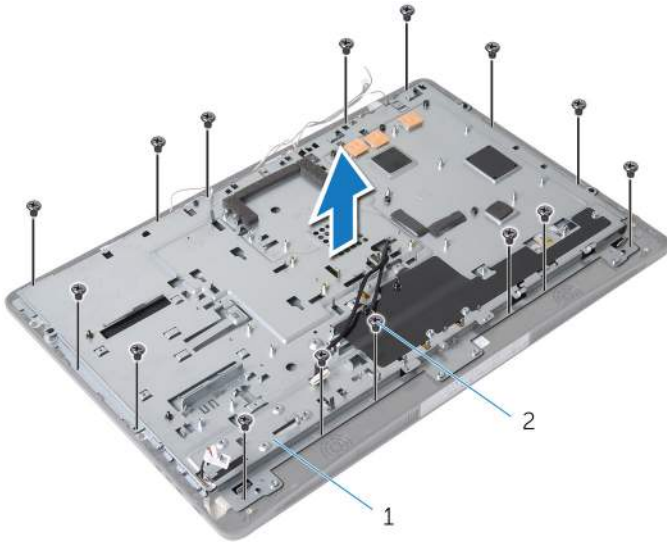

1 display-panel base

2 screws (15)

- 8** Peel the tape that secures the display panel to the display bezel.

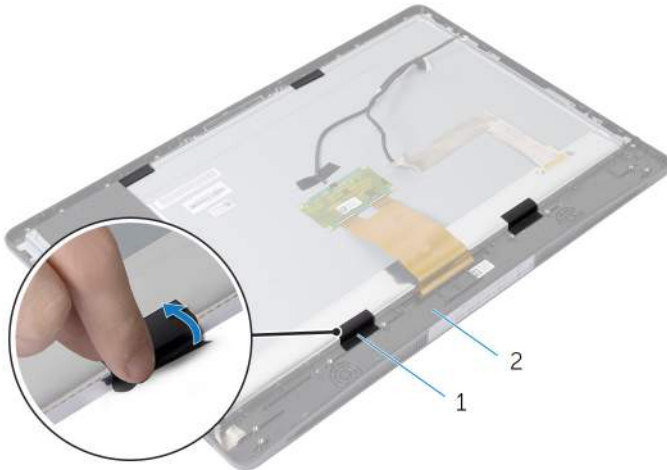

1 tape

2 display bezel

- 9** Press the release latch on either side of the display-cable connector and then pull the display cable to disconnect it from the display panel.

**10** Peel off the display cable from the display panel.

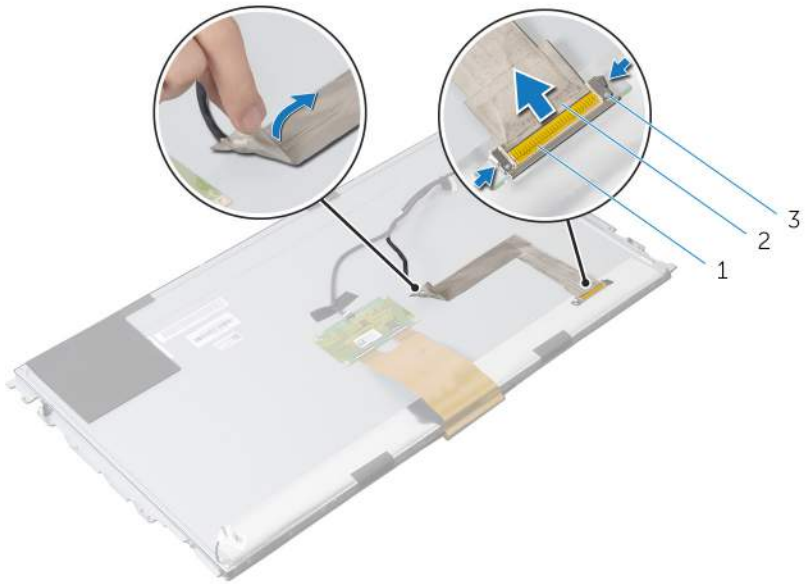

- 1 display-cable connector
- 2 display cable
- 3 release latches (2)

**11** Peel off the Mylar from the touch-control board cable.



**12** Disconnect the touch-control board cable from the touch-control board.

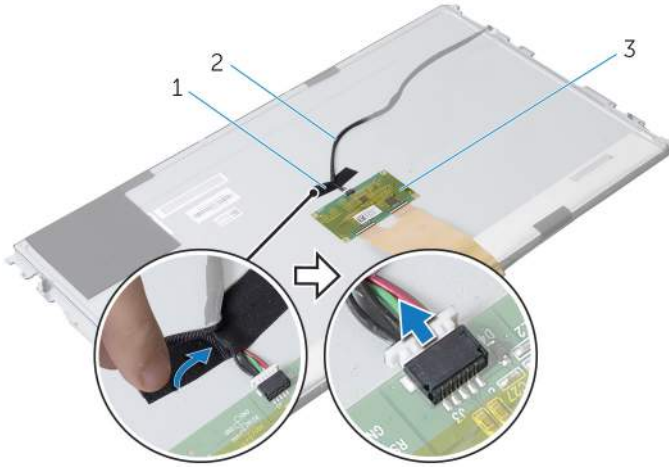

1 Mylar

2 touch-control board cable

3 touch-control board

**13** Lift the latches and disconnect the flex cable from the display panel.

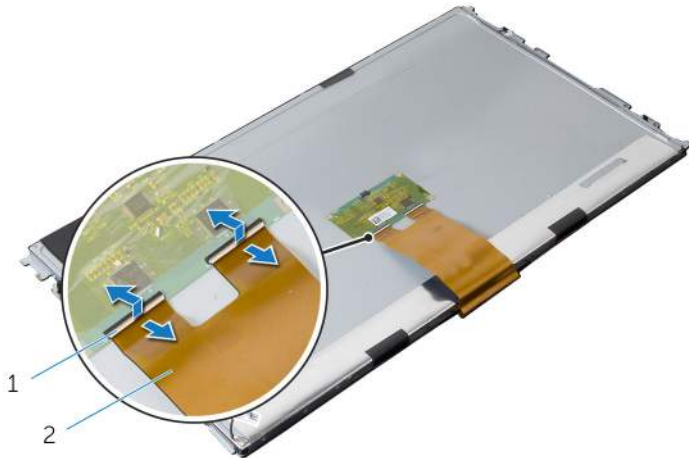

1 connector latches

2 flex cable

**14** Remove the screws that secure the display assembly to the display bezel.

**15** Gently lift the display assembly off the display bezel.

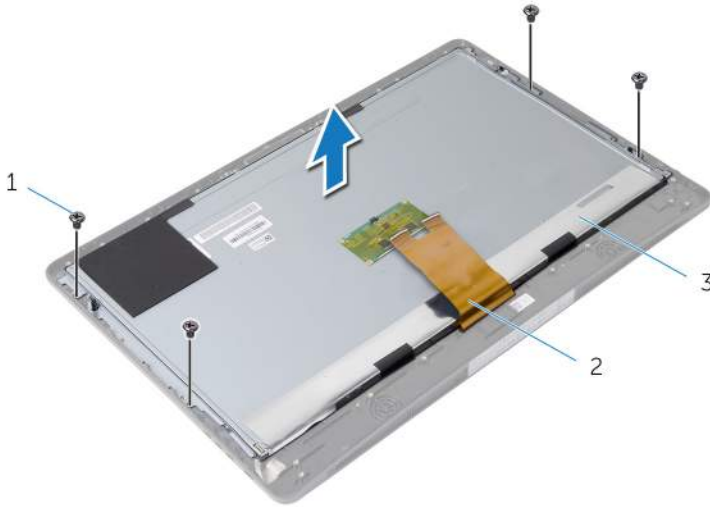

1 screws (4)

2 flex cable

3 display panel

**16** Remove the screws that secure the display-panel brackets to the display panel.

**17** Remove the display-panel brackets off the display panel.

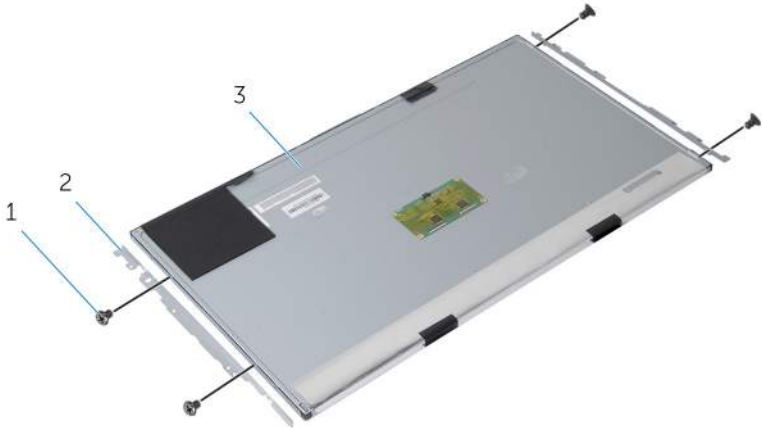

1 screws (4)

2 display-panel brackets (2)

3 display panel

# Replacing the Display Panel

---

 **WARNING:** Before working inside your computer, read the safety information that shipped with your computer and follow the steps in [Before Working Inside Your Computer](#). After working inside your computer, follow the instructions in [After Working Inside Your Computer](#). For more safety best practices, see the Regulatory Compliance home page at [dell.com/regulatory\\_compliance](http://dell.com/regulatory_compliance).

## Procedure

- 1 Align the screw holes on the display-panel brackets with the screw holes on the display panel.
- 2 Replace the screws that secure the display-panel brackets to the display panel.
- 3 Align the screw holes on the display panel with the screw holes on the display bezel and place the display panel on the display bezel.



**NOTE:** Make sure that no cables are under the display panel.

- 4 Replace the screws that secure the display assembly to the display bezel.
- 5 Slide the flex cables into the connectors on the display panel and press down on the connector latches to secure the cables.
- 6 Connect the touch-control board cable to the touch-control board.
- 7 Adhere the Mylar to the touch-control board cable.
- 8 Adhere the display cable to the display panel.
- 9 Connect the display cable to the display panel.
- 10 Adhere the tape that secures the display panel to the display bezel.
- 11 Slide all the cables through the slot on the display-panel base.
- 12 Align the screw holes on the display-panel base with the screw holes on the display bezel.
- 13 Replace the screws that secure the display-panel base to the display bezel.
- 14 Replace the release-latch brackets and lock them in place in the display bezel.
- 15 Replace the release latches on the display bezel.
- 16 Replace the screws that secure the release latches to the display-panel base.
- 17 Replace the screw that secures the ground cable to the display-panel base.

# Post-requisites

- 1 Replace the [antennas](#).
- 2 Replace the [camera](#).
- 3 Replace the [speakers](#).
- 4 Replace the [speaker cover](#).
- 5 Replace the [system board](#).
- 6 Replace the [coin-cell battery](#).
- 7 Replace the [wireless card](#).
- 8 Replace the [processor](#).
- 9 Replace the [processor fan](#).
- 10 Replace the [processor heat-sink](#).
- 11 Replace the [power-supply unit](#).
- 12 Replace the [power-supply fan](#).
- 13 Replace the [optical drive](#).
- 14 Replace the [I/O bracket](#).
- 15 Replace the [power-supply diagnostic board](#).
- 16 Replace the [converter board](#).
- 17 Replace the [VESA-mount bracket](#).
- 18 Replace the [hard drive](#).
- 19 Replace the [system-board shield](#).
- 20 Replace the [memory module\(s\)](#).
- 21 Replace the [back cover](#).
- 22 Replace the [stand assembly](#).

# Flashing the BIOS

---

You may need to flash (update) the BIOS when an update is available or when you replace the system board. To flash the BIOS:



- 1 Turn on the computer.
- 2 Go to **dell.com/support**.
- 3 If you have your computer's Service Tag, type your computer's Service Tag and click **Submit**.  
If you do not have your computer's Service Tag, click **Detect My Product** to allow automatic detection of the Service Tag.  
 **NOTE:** If the Service Tag cannot be detected automatically, select your product under the product categories.
- 4 Click **Get Drivers and Downloads**.
- 5 Click **View All Drivers**.
- 6 In the **Operating System** drop-down, select the operating system installed on your computer.
- 7 Click **BIOS**.
- 8 Click **Download File** to download the latest version of the BIOS for your computer.
- 9 On the next page, select **Single-file download** and click **Continue**.
- 10 Save the file and once the download is complete, navigate to the folder where you saved the BIOS update file.
- 11 Double-click the BIOS update file icon and follow the instructions on the screen.

# Getting Help and Contacting Dell

---

## Self-Help Resources

You can get information and help on Dell products and services using these online self-help resources:

Self-Help Information	Self-Help Options
Accessing Windows Help	<b>Windows 8</b> — Open the Search charm, type <b>Help</b> and <b>Support</b> in the search box and press <Enter>. <b>Windows 7</b> — Click <b>Start</b>  → <b>Help and Support</b> .
Information about Dell products and services	See <b>dell.com</b>
Troubleshooting information, user manuals, setup instructions, product specifications, technical help blogs, drivers, software updates, and so on	See <b>dell.com/support</b>
Information about Microsoft Windows 8	See <b>dell.com/windows8</b>
Information about Microsoft Windows 7	Click <b>Start</b>  → <b>All Programs</b> → <b>Dell Help Documentation</b>
Learn about your operating system, setting up and using your computer, data backup, diagnostics, and so on.	See <i>Me and My Dell</i> at <b>dell.com/support/manuals</b> .

## Contacting Dell

To contact Dell for sales, technical support, or customer service issues, see **dell.com/contactdell**.

 **NOTE:** Availability varies by country and product, and some services may not be available in your country.



**NOTE:** If you do not have an active internet connection, you can find contact information on your purchase invoice, packing slip, bill, or Dell product catalog.