

SAMSUNG



User Manual



SHOOT WOW! SHARE NOW!
NX1100

This user manual includes detailed usage instructions for your camera.
Please read this manual thoroughly.

ENG

Copyright information

- Microsoft Windows and the Windows logo are registered trademarks of the Microsoft Corporation.
- Mac and Apple App Store are registered trademarks of the Apple Corporation.
- Google Play Store is a registered trademark of Google, Inc.
- microSD™, microSDHC™, and microSDXC™ are registered trademarks of the SD Association.
- HDMI, the HDMI logo, and the term “High Definition Multimedia Interface” are trademarks or registered trademarks of HDMI Licensing LLC.
- Wi-Fi®, the Wi-Fi CERTIFIED logo, and the Wi-Fi logo are registered trademarks of the Wi-Fi Alliance.
- Trademarks and trade names used in this manual are the property of their respective owners.



- Camera specifications or contents of this manual may be changed without prior notice due to upgrade of camera functions.
- You are not allowed to reuse or distribute any part of this manual without prior permission.
- We recommend using your camera within the country where you purchase it.
- Use this camera responsibly and adhere to all laws and regulations concerning its use.
- For Open Source License information, refer to the “OpenSourceInfo.pdf” in the provided CD-ROM.



PlanetFirst represents Samsung Electronics' commitment to sustainable development and social responsibility through eco-driven business and management activities.

Health and safety information

Always comply with the following precautions and usage tips to avoid dangerous situations and ensure peak performance of your camera.



Warning—situations that could cause injury to yourself or others

Do not disassemble or attempt to repair your camera.

This may result in electric shock or damage to the camera.

Do not use your camera near flammable or explosive gases and liquids.

This may cause a fire or explosion.

Do not insert flammable materials into the camera or store these materials near the camera.

This may cause a fire or electric shock.

Do not handle your camera with wet hands.

This may result in electric shock.

Prevent damage to subjects' eyesight.

Do not use the flash in close proximity (closer than 1 m/3 ft) to people or animals. If you use the flash too close to your subject's eyes, this can cause temporary or permanent eyesight damage.

Keep your camera away from small children and pets.

Keep your camera and all accessories out of the reach of small children and animals. Small parts may cause choking or serious injury if swallowed. Moving parts and accessories may present physical dangers as well.

Do not expose the camera to direct sunlight or high temperatures for an extended period of time.

Prolonged exposure to sunlight or extreme temperatures can cause permanent damage to your camera's internal components.

Avoid covering the camera with blankets or clothes.

The camera may overheat, which may distort the camera or cause a fire.

Do not handle the power supply cord or go near the charger during a thunderstorm.

This may result in electric shock.

If liquid or foreign objects enter your camera, immediately disconnect all power sources, such as the battery, and then contact a Samsung service center.

Comply with any regulations that restrict the use of a camera in a certain area.

- Avoid interference with other electronic devices.
- Turn off the camera when in an aircraft. Your camera can cause interference with aircraft equipment. Follow all airline regulations and turn off your camera when directed by airline personnel.
- Turn off the camera near medical equipment. Your camera can interfere with medical equipment in hospitals or health care facilities. Follow all regulations, posted warnings, and directions from medical personnel.

Avoid interference with pacemakers.

Maintain a minimum of 15 cm between this camera and all pacemakers to avoid potential interference, as recommended by the manufacturer and the independent research group, Wireless Technology Research. If you have any reason to suspect that your camera is interfering with a pacemaker or other medical device, turn off the camera immediately and contact the manufacturer of the pacemaker or medical device for guidance.



Caution—situations that could cause damage to your camera or other equipment

Remove the batteries from your camera when storing it for an extended period of time.

Installed batteries may leak or corrode over time and cause serious damage to your camera.

Use only authentic, manufacturer-recommended, Lithium-ion replacement batteries. Do not damage or heat the battery.

Inauthentic, damaged, or heated batteries may cause a fire or personal injury.

Use only Samsung-approved batteries, chargers, cables and accessories.

- Using unauthorized batteries, chargers, cables or accessories can cause batteries to explode, damage your camera, or cause injury.
- Samsung is not responsible for damage or injuries caused by unapproved batteries, chargers, cables or accessories.

Use the battery only for its intended purpose.

Misusing the battery may cause a fire or electric shock.

Do not touch the flash while it fires.

The flash is very hot when fired and may burn your skin.

Do not use a damaged power supply cord, plug, or loose outlet when you charge batteries.

This may cause a fire or electric shock.

Do not force the camera's parts or apply pressure to the camera.

This may cause your camera to malfunction.

Exercise caution when you connect cables and install batteries and memory cards.

If you force the connectors, improperly connect cables, or improperly install batteries and memory cards, you can damage ports, connectors, and accessories.

Keep cards with magnetic strips away from the camera case.

Information stored on the card may be damaged or erased.

Never use a damaged battery, or memory card.

This may result in electric shock or camera malfunction or cause a fire.

Check that the camera is operating properly before use.

The manufacturer takes no responsibility for any loss of files or damage that may result from camera malfunction or improper use.

You must plug the small end of the USB cable into your camera.

If the cable is reversed, it may damage your files. The manufacturer is not responsible for any loss of data.

Protect your camera's lens.

Do not expose the lens to direct sunlight, as this may discolor the image sensor or cause it to malfunction.

If the camera overheats, remove the battery and allow it to cool down.

- Prolonged usage of the camera may overheat the battery and raise the internal temperature of the camera. If the camera stops operating, remove the battery and allow it to cool down.
- High internal temperatures may result in noise in your photos. This is normal and does not affect your camera's overall performance.

Avoid interference with other electronic devices.

Your camera emits radio frequency (RF) signals that may interfere with unshielded or improperly shielded electronic equipment, such as pacemakers, hearing aids, medical devices, and other electronic devices in homes or vehicles. Consult the manufacturers of your electronic devices to solve any interference problems you experience. To prevent unwanted interference, use only Samsung-approved devices or accessories.

Use your camera in the normal position.

Avoid contact with your camera's internal antenna.







Data transference and your responsibilities

- Data transferred via WLAN could be leaked, so avoid transferring sensitive data in public areas or on open networks.
- The camera manufacturer is not liable for any data transfers that infringe on copyrights, trademarks, intellectual property laws, or public decency ordinances.





Indications used in this manual

Icons used in this manual

Icon	Function
	Additional information
	Safety warnings and precautions
[]	Camera buttons. For example, [Shutter] represents the shutter button.
()	Page number of related information
→	The order of options or menus you must select to perform a step; for example: Select  → Quality (represents select  , and then Quality). The number next to the icon may vary depending on the shooting mode. That is, some options may be located under  or  .This manual is based on Program mode.
*	Annotation

Shooting mode indications

Shooting mode	Indication
Smart Auto	SMART
Program	P
Aperture Priority	A
Shutter Priority	S
Manual	M
Lens Priority	
Magic	
Scene	SCN
Movie	
Wi-Fi	Wi-Fi

Contents

Tips

Concepts in Photography

Shooting postures	13
Holding the camera.....	13
Standing photography.....	13
Crouching photography	14
Aperture	14
Aperture value and the depth of field	15
Shutter speed	16
ISO sensitivity	17
How the aperture setting, shutter speed, and ISO sensitivity control exposure	18
Correlation between focal length, angle, and perspective	19
Depth of field	20
What controls out-of-focus effects?	20
DOF preview	22
Composition	22
Rule of Thirds.....	22
Photos with two subjects	23
Flash	24
Flash guide number.....	24
Bounce Photography	25

Chapter 1

My Camera

Getting started	27
Unpacking.....	27
Camera layout	28
Using the SMART LINK button.....	30
Display icons	31
In Shooting mode.....	31
Capturing photos	31
Recording videos	32
About the level gauge.....	32
In Playback mode.....	33
Viewing photos	33
Playing videos	33
Lenses	34
Lens layout.....	34
Locking or unlocking the lens.....	35
Lens markings.....	37
Accessories	38
External flash layout.....	38
Connecting the flash.....	39
GPS module layout (optional).....	41
Attaching the GPS module	41

Shooting modes	43
SMART Smart Auto mode	43
P Program mode.....	44
Program Shift.....	44
A Aperture Priority mode	45
S Shutter Priority mode	45
M Manual mode.....	46
Framing mode.....	46
Using bulb.....	46
<i>i</i> Lens Priority mode	47
Using the i effect mode	47
Using i-Function in PASM modes	48
Using i zoom	49
★ Magic mode.....	50
SCN Scene mode	51
🎥 Movie mode.....	54
Available functions by shooting mode.....	55

Chapter 2

Shooting Functions

Size	57
Photo size options.....	57
Video size options	58
Quality	59
Photo quality options.....	59
Video quality options	59

ISO sensitivity	60
White Balance (light source)	61
White Balance options.....	61
Customizing preset options.....	62
Picture Wizard (photo styles)	64
AF mode	65
Single AF	65
Continuous AF.....	66
Manual focus.....	66
AF area	67
Selection AF	67
Multi AF	68
Face detection AF	68
Self-portrait AF	69
MF assist	70
Optical Image Stabilization (OIS)	71
OIS options	71
Drive (shooting method)	72
Single	72
Continuous.....	72
Burst	73
Timer.....	73
Auto Exposure Bracketing (AE Bracket)	74
White Balance Bracketing (WB Bracket)	74
Picture Wizard Bracketing (P Wiz Bracket).....	75
Bracketing setting.....	75

Flash	76
Flash options.....	76
Correcting the red-eye effect.....	77
Adjusting the flash intensity.....	77
Metering	79
Multi.....	79
Center-weighted.....	80
Spot.....	80
Measuring the exposure value of the focus area.....	81
Smart Range	82
Selective Color	83
Color space	84
Exposure compensation/lock	85
Exposure compensation.....	85
Exposure lock.....	86
Video functions	87
Movie AE mode.....	87
Multi Motion.....	87
Fader.....	88
Voice.....	88

Chapter 3

Playback/Editing

Searching and managing files	90
Viewing photos.....	90
Viewing image thumbnails.....	90
Viewing files by category.....	91
Viewing files as a folder.....	91
Protecting files.....	92
Deleting files.....	92
Deleting a single file.....	92
Deleting multiple files.....	93
Deleting all files.....	93
Viewing photos	94
Enlarging a photo.....	94
Viewing a slide show.....	94
Auto rotating.....	95
Setting the thumbnail mode.....	95
Playing videos	96
Trimming a video during playback.....	96
Capturing an image during playback.....	97
Editing photos	98
Options.....	98

Chapter 4

Wireless network

Connecting to a WLAN and configuring network settings 101

- Connecting to a WLAN..... 101
 - Setting network options 102
 - Manually setting the IP address 102
- Using the login browser 103
- Network connection tips..... 104
- Entering text 105

Saving files to a smart phone automatically..... 106

Sending photos or videos to a smart phone 107

Using a smart phone as a remote shutter release 109

Using photo or video sharing websites 111

- Accessing a website..... 111
- Uploading photos or videos..... 112

Sending photos or videos via email..... 113

- Changing email settings 113
 - Storing your information 113
 - Setting an email password 114
 - Changing the email password 114
- Sending photos or videos via email..... 115

Using Auto Backup to send photos or videos..... 117

- Installing the program for Auto Backup on your PC 117
- Sending photos or videos to a PC 117

Viewing photos or videos on a TV Link-enabled TV 119

Sending photos using Wi-Fi Direct 121

About the Wake on LAN (WOL) feature..... 122

- Setting the PC to wake up from sleep mode 122
- Setting the PC to turn on 123

Chapter 5

Camera settings menu

User settings	125
ISO Customizing.....	125
ISO Step.....	125
Auto ISO Range.....	125
Noise Reduction.....	125
DMF (Direct Manual Focus).....	125
AF Priority.....	126
Distortion Correct.....	126
iFn Customizing.....	126
User Display.....	127
Key Mapping.....	128
Grid Line.....	128
AF Lamp.....	128
Setting 1.....	129
Setting 2.....	131
Setting 3.....	132
GPS.....	133

Chapter 6

Connecting to external devices

Viewing files on an HDTV or a 3D TV	135
Viewing files on an HDTV.....	135
Viewing files on a 3D TV.....	136
Printing photos.....	137
Printing photos with a PictBridge photo printer.....	137
Configuring print settings.....	138
Creating a print order (DPOF).....	138
DPOF options.....	139
Transferring files to your computer.....	140
Transferring files to your Windows computer.....	140
Connecting the camera as a removable disk.....	140
Disconnecting the camera (for Windows XP).....	141
Transferring files to your Mac computer.....	141
Using programs on a PC.....	142
Installing software.....	142
Programs contained on the CD.....	142
Using Intelli-studio.....	143
Requirements.....	143
Using the Intelli-studio Interface.....	144
Transferring files using Intelli-studio.....	145
Installing Adobe Photoshop Lightroom.....	146
Using Adobe Photoshop Lightroom.....	146

Chapter 7

Appendix

Error messages 148

Maintaining the camera 149

- Cleaning the camera..... 149
 - Camera lens and display 149
 - Image sensor 149
 - Camera body 149
- Using or storing the camera..... 150
 - Inappropriate places to use or store the camera..... 150
 - Using on beaches or shores..... 150
 - Storing for extended period of time 150
 - Using the camera with caution in humid environments 151
 - Other cautions 151
- About memory card..... 152
 - Supported memory card 152
 - Memory card capacity..... 152
 - Cautions when using memory cards 154
- About the battery..... 155
 - Battery specifications 155
 - Battery life..... 156
 - Low battery message..... 156
 - Notes about using the battery 156
 - Notes about charging the battery 156

Before contacting a service center 157

Camera specifications 160

Glossary 165

Optional accessories 171

Index 173

FCC notice..... 176

Declaration sentence in official languages..... 179

Concepts in Photography

Shooting postures

A correct posture for stabilizing the camera is necessary for taking a good photo. Even if you hold a camera correctly, the wrong posture can cause the camera to shake. Stand up straight and remain still to maintain a steady base for your camera. When shooting with a low shutter speed, hold your breath to minimize body movement.

Holding the camera

Hold the camera with your right hand and place your right index finger on the shutter button. Place your left hand under the lens for support.

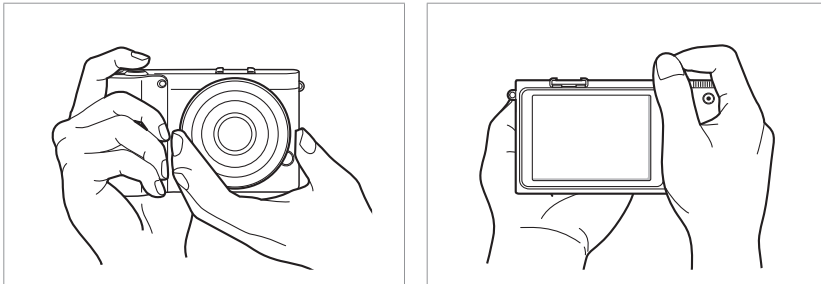

Standing photography

Compose your shot; stand up straight with your feet shoulder-length apart, and keep your elbows pointed down.

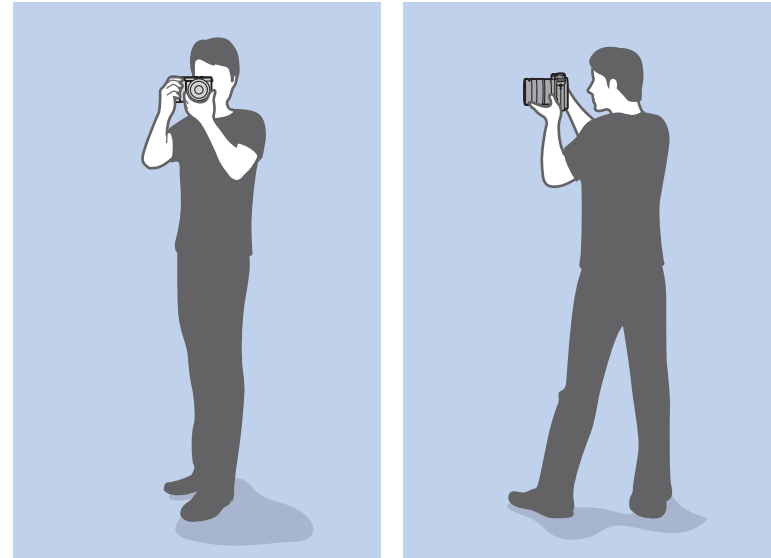

Crouching photography

Compose your shot, crouch with one knee touching the ground, and keep a straight posture.

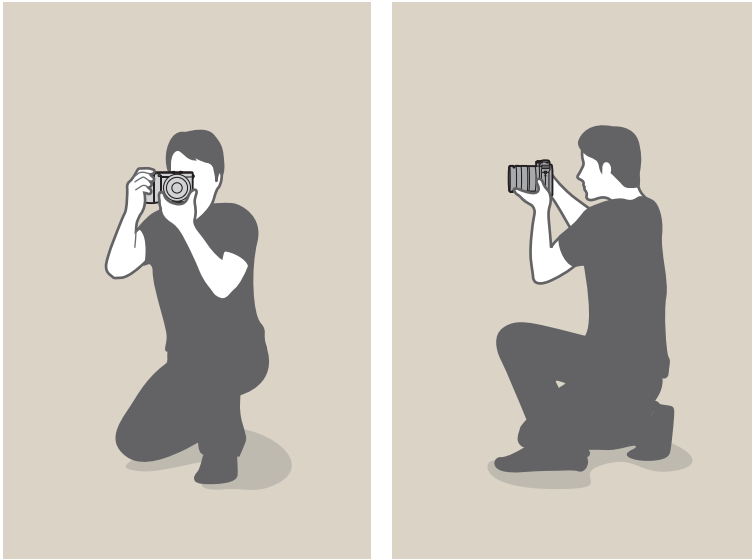

Aperture

The aperture, a hole that controls the amount of light that enters the camera, is one of the three factors that determine the exposure. The aperture housing contains thin, metal plates that open and close to let light through the aperture and into the camera. The size of the aperture is closely related to the brightness of a photo: the larger the aperture, the brighter the photo; the smaller the aperture, the darker the photo.

Aperture sizes

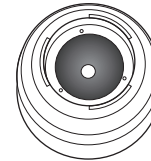

Minimum aperture

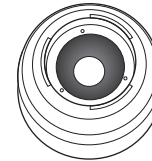

Medium aperture

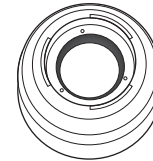

Maximum aperture

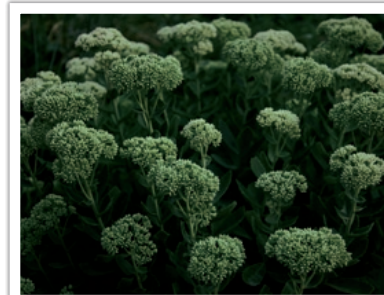

Darker photo
(aperture opened slightly)

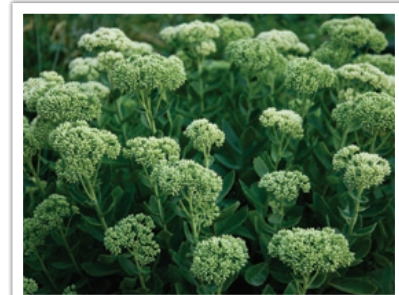

Brighter photo
(aperture opened wide)

The size of the aperture is represented by a value known as an “F-number.” The f-number represents the focal length divided by the diameter of the lens. For example, if a lens with a 50 mm focal length has an f-number of F2, the diameter of the aperture is 25 mm. (50 mm/25 mm=F2) The smaller the f-number, the greater the size of the aperture.

The opening in the aperture is described as the Exposure Value (EV). Increasing the Exposure Value (+1 EV) means the amount of light doubles. Decreasing the Exposure Value (-1 EV) means the amount of light halves. You can also use the exposure compensation feature to fine-tune the amount of light by subdividing exposure values into 1/2, 1/3 EV, and so on.

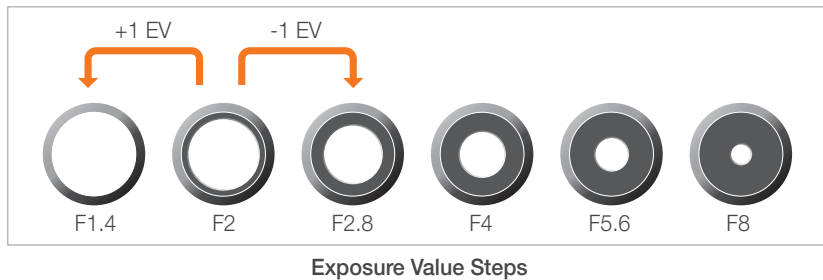

Aperture value and the depth of field

You can blur or sharpen the background of a photo by controlling the aperture. It is closely related to the depth of field (DOF), which can be expressed as small or large.



A photo with a large DOF



A photo with a small DOF



The aperture housing contains several blades. These blades move together and control the amount of light passing through the center of the aperture. The number of blades also affects the shape of light when shooting night scenes. If an aperture has an even number of blades, light divides into an equal number of sections. If the number of blades is odd, the number of sections is double the number of blades.

For example, an aperture with 8 blades divides light into 8 sections and an aperture with 7 blades into 14 sections.

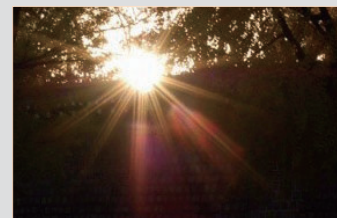

7 blades

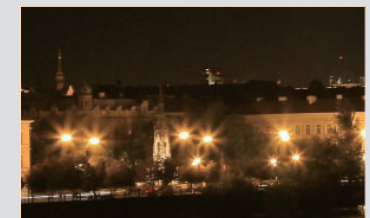

8 blades

Shutter speed

Shutter speed refers to the amount of time it takes to open and close the shutter, and it is an important factor in the brightness of a photo, as it controls the amount of light which passes through the aperture before it reaches the image sensor.

Usually, the shutter speed is manually adjustable. The measurement of the shutter speed is known as the “Exposure Value” (EV), which is marked in intervals of 1 s, 1/2 s, 1/4 s, 1/8 s, 1/15 s, 1/1000 s, 1/2000 s, and so on.

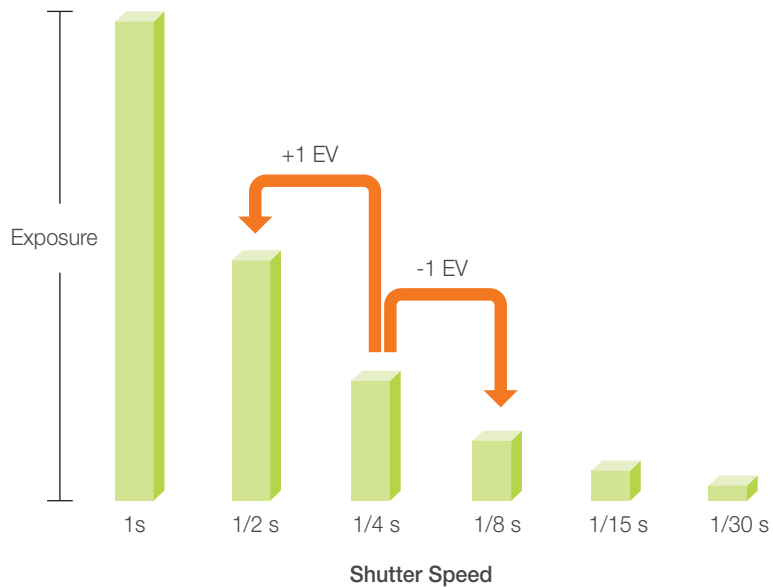

Therefore, the faster the shutter speed, the less light will be let in. Likewise, the slower the shutter speed, the more light will be let in.

As the photos below illustrate, a slow shutter speed allows more time to let light in, so the photo becomes brighter. On the other hand, a fast shutter speed allows less time to let light in and the photo becomes darker and more easily freezes subjects in motion.

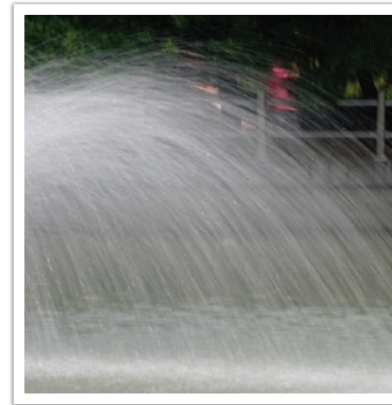

0.8 s



0.004 s

ISO sensitivity

The exposure of an image is determined by the sensitivity of the camera. This sensitivity is based on international film standards, known as ISO standards. On digital cameras, this sensitivity rating is used to represent the sensitivity of the digital mechanism that captures the image.

ISO sensitivity doubles as the number doubles. For example, an ISO 200 setting is capable of capturing images at twice the speed of an ISO 100 setting. However, higher ISO settings can result in “noise” — small specks, spots, and other phenomena in a photo that give the shot a noisy or dirty appearance. As a general rule, it is best to use a low ISO setting to prevent noise in your photos, unless you are shooting in darkened environments or at night.

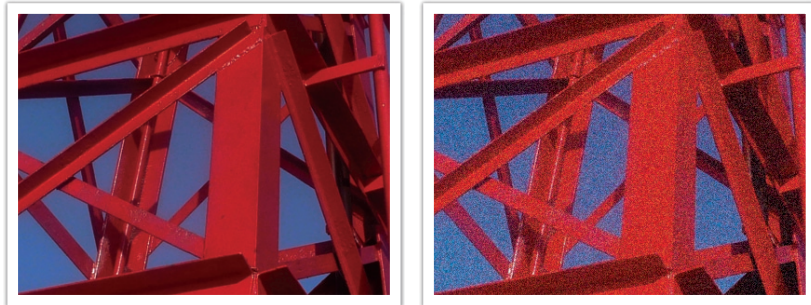

Changes in the quality and brightness according to ISO sensitivity

Because a low ISO sensitivity means the camera will be less sensitive to light, you need more light to have an optimal exposure. When using a low ISO sensitivity, open the aperture more or reduce the shutter speed to allow more light to enter the camera. For example, on a sunny day when light is abundant, a low ISO sensitivity does not require a low shutter speed. However, in a dark place or at night, a low ISO sensitivity and a fast shutter speed will result in a blurry photo.



A photo captured with a tripod and high sensitivity





A blurred photo with a low ISO sensitivity

How the aperture setting, shutter speed, and ISO sensitivity control exposure

The aperture setting, shutter speed, and ISO sensitivity are closely interconnected in photography. The aperture setting controls the opening that regulates the light that enters the camera, while the shutter speed determines the length of time that light is allowed to enter. ISO sensitivity determines the speed at which the film reacts to light. Together, these three aspects are described as the triangle of exposure.

A change in shutter speed, aperture value, or ISO sensitivity can be offset by adjustments to the others to maintain the amount of light. The results, however, change according to the settings. For example, shutter speed is useful in expressing movement, aperture can control the depth of field, and ISO sensitivity can control the graininess of a photo.

	Settings	Results
Aperture	Wide aperture = more light Narrow aperture = less light	 <p>Wide = small depth of field Narrow = large depth of field</p>

	Settings	Results
Shutter speed	Fast speed = less light Slow speed = more light	 <p>Fast = still Slow = blurry</p>
ISO sensitivity	High sensitivity = more sensitive to light Low sensitivity = less sensitive to light	 <p>High = more grainy Low = less grainy</p>

Correlation between focal length, angle, and perspective

Focal length, which is measured in millimeters, is the distance between the middle of the lens to its focal point. It affects the angle and perspective of captured images. A short focal length translates into a wide angle, which allows you to capture a wide shot. A long focal length translates into a narrow angle, which allows you to capture telephoto shots.

Short focal length

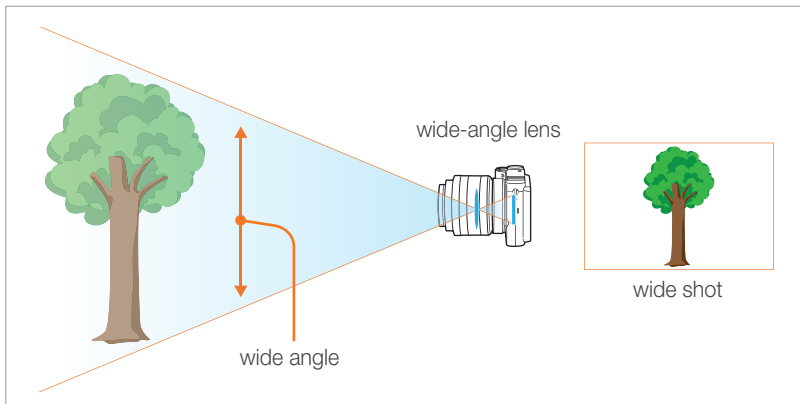

Long focal length

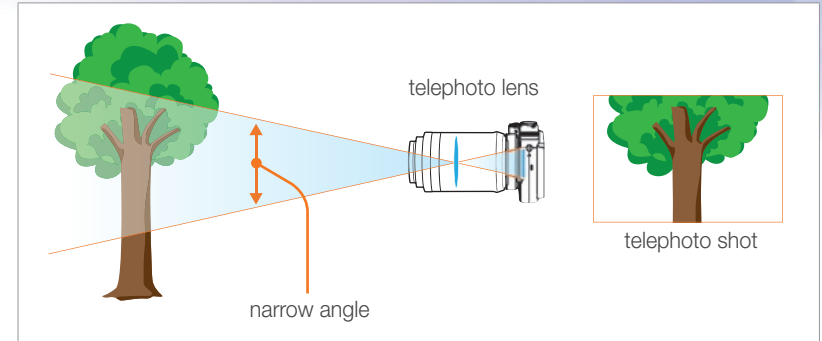

Look at these photos below and compare the changes.



20 mm angle

50 mm angle

200 mm angle



Normally, a lens with a wide angle is suitable for shooting landscapes and a lens with a narrow angle is recommended for shooting sports events or portraits.

Depth of field

Portraits or still-life photos mostly acclaimed by people are the ones on which the background is out of focus so the subject looks pronounced. Depending on the focused areas, a photo can be blurred or sharpened. This is called 'a low DOF' or 'a high DOF'.

The depth of field is the focused area around the subject. Therefore, a small DOF signifies that the focused area is narrow and a large DOF means the focused area is wide.

A photo with a small DOF, which stresses the subject and makes the rest of it blurred, can be obtained by using a telescope lens or selecting a low aperture value. Conversely, a photo with a large DOF which shows all the elements on the photo sharply focused can be achieved by using a wide angle lens or selecting a high aperture value.



Small Depth of Field

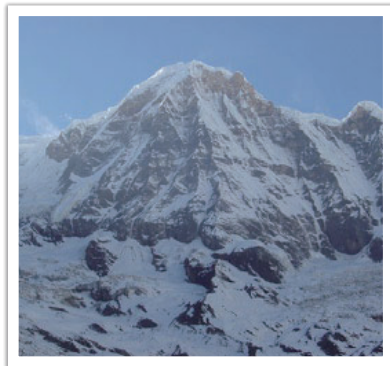

Large Depth of Field

What controls out-of-focus effects?

DOF depends on aperture value

The wider the aperture is (namely the lower the aperture value), the lower the DOF becomes. Under the condition where the other values including shutter speed and ISO sensitivity are equal, a low aperture value leads to a photo with a low DOF.



20 mm F5.7



50 mm F22

DOF depends on focal length

The longer the focal length is, the lower the DOF gets. A telescope lens with a longer focal length than a telescope lens with a short focal length is better to capture a photo of a low DOF.

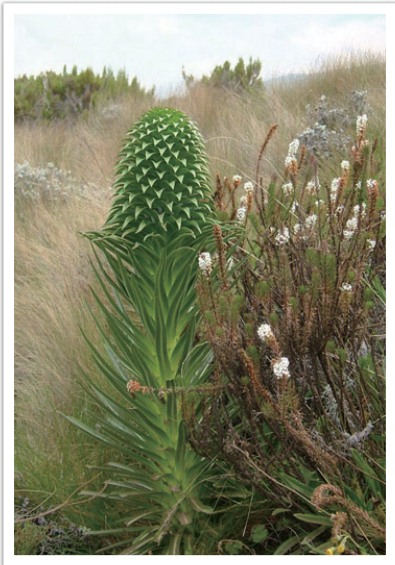

A photo captured with a 20 mm telescope lens



A photo captured with a 100 mm telescope lens

DOF depends on the distance between the subject and the camera

The shorter the distance between the subject and the camera is, the lower the DOF gets. Therefore, taking a photo close to a subject can result in a photo of low DOF.



A photo captured with a 100 mm telescope lens

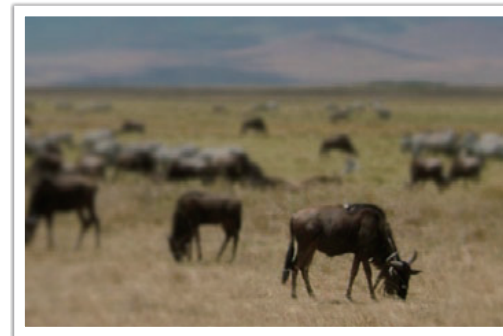

A photo captured close to the subject

DOF preview

You can use the Custom button to get an idea of what your shot will look like before shooting. When you press the button, the camera adjusts the aperture to the predefined settings and shows the results on the screen. Set the function of the Custom button to **Optical Preview**. (p. 128)

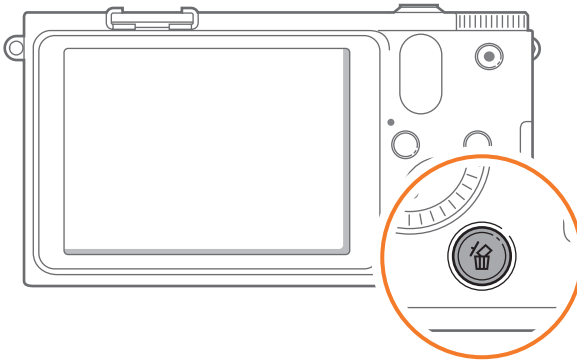

Composition

It is fun to capture a photo of the beauty of world with a camera. No matter how the world is beautiful, however, a poor composition cannot capture the beauty of it.

When it comes to composition, it is very important to prioritize subjects.

Composition in photography means arranging objects in a photo. Usually, abiding by the rule of thirds leads to a good composition.

Rule of Thirds

To use the rule of thirds, divide the image into a 3x3 pattern of equal rectangles.

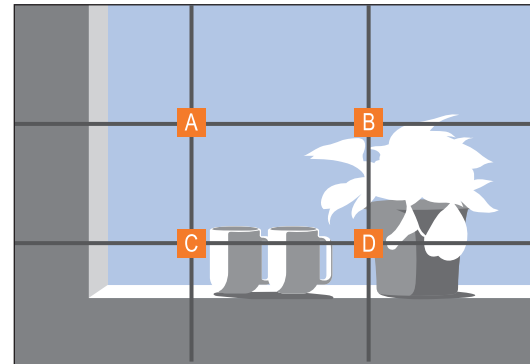

To compose photos that best emphasize the subject, make sure the subject is located at one of the corners of the center rectangle.

Using the rule of thirds will create photos with stable and compelling compositions. Below are a few examples.

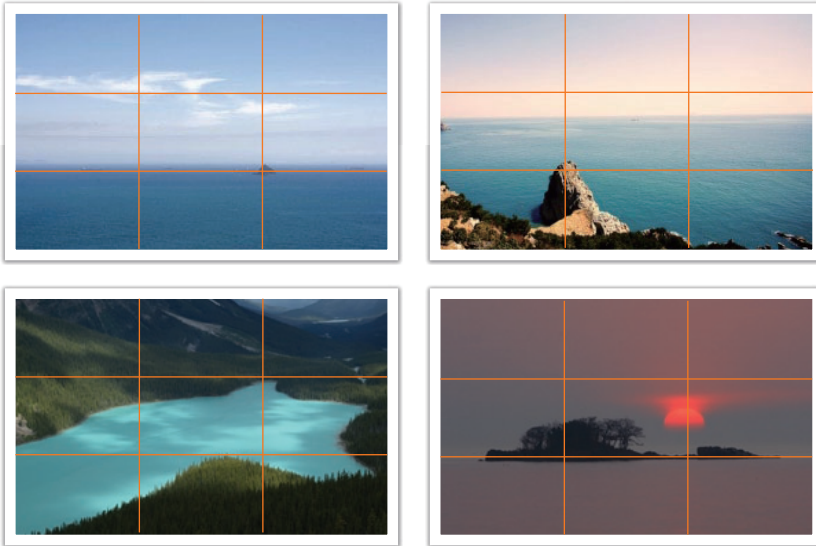

Photos with two subjects

If your subject is in one corner of the photo, it creates an unbalanced composition. You can stabilize the photo by capturing a second subject in the opposite corner to balance the weight of the photo.

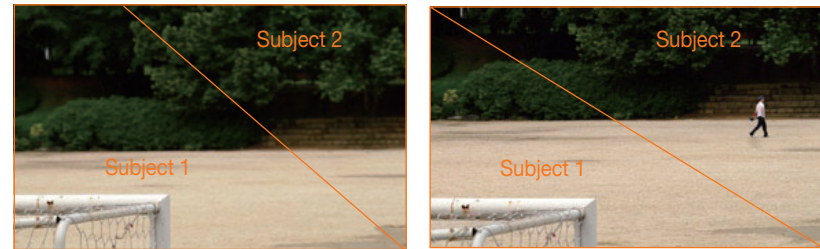

Unstable

Stable

When taking landscape photos, centering the horizon will create an unbalanced effect. Give more weight to the photo by moving the horizon up or down.



Unstable

Stable

Flash

Light is one of the most important components in photography. It's not easy, however, to have an enough amount of light anytime and anywhere. Making use of a flash allows you to optimize light settings and create a variety of effects.

Flash, also known as strobe or speed light, helps to create adequate exposure in low-light conditions. It is also useful in light-abundant situations. For example, flash can be used in compensating the exposure of a subject's shadow or capturing clearly both the subject and the background in backlit conditions.



Before correction



After correction

Flash guide number

The model number of a flash refers to the flash's power, and the maximum amount of light created is represented by a value known as a "guide number." The bigger the guide number, the more light is emitted from the flash. The guide number is achieved by multiplying the distance from the flash to the subject and the aperture value when the ISO sensitivity is set to 100.

Guide number = Flash to Subject Distance X Aperture value

Aperture value = Guide number / Flash to Subject Distance

Flash to Subject Distance = Guide number / Aperture value

Therefore, if you know the guide number of a flash, you can estimate an optimum flash to subject distance when setting the flash manually. For example, if a flash has a guide number of GN 20 and is 4 meters away from the subject, the optimal aperture value is F5.0.

Bounce Photography

Bounce photography refers to the method of bouncing light off of the ceiling or walls so that the light spreads evenly over the subject. Normally, photos captured with flash may appear unnatural and cast shadows. Subjects in photos captured with bounce photography cast no shadows and look smooth due to evenly spread light.





Chapter 1

My Camera

Learn about your camera's layout, display icons, basic functions, supplied lens, and optional accessories.

Getting started

Unpacking

Check your product box for the following items.

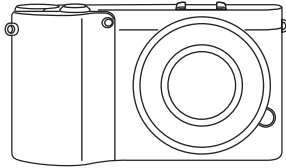

Camera
(including the body cap
and hot-shoe cover)



External flash

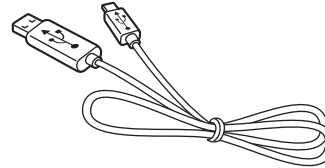

USB cable

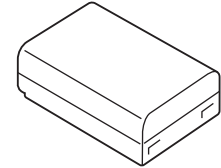

Rechargeable battery

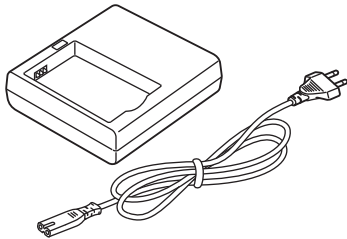

Battery cradle/AC power cable

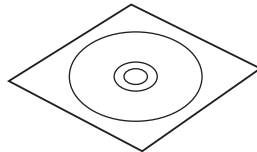

Software CD-ROM
(User manual included)

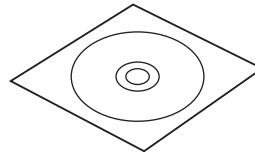

Adobe Photoshop
Lightroom DVD-ROM

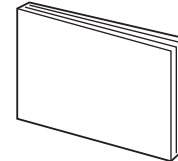

User manual
Basic Operation

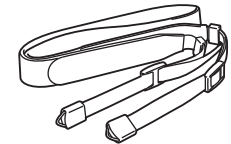

Strap



- The illustrations may differ from your actual items.
- You can purchase optional accessories at a retailer or a Samsung service center. Samsung is not responsible for any problems caused by using unauthorized accessories. For information about accessories, refer to page 171.

Camera layout

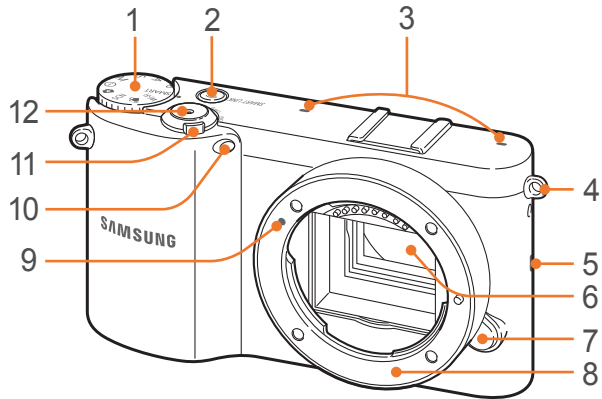

No.	Name
1	Mode dial <ul style="list-style-type: none"> • SMART: Smart Auto mode (p. 43) • P: Program mode (p. 44) • A: Aperture Priority mode (p. 45) • S: Shutter Priority mode (p. 45) • M: Manual mode (p. 46) • ⓘ: Lens Priority Mode (p. 47) • ★: Magic Mode (p. 50) • SCN: Scene mode (p. 51) • 🎥: Movie mode (p. 54) • Wi-Fi: Wi-Fi (p. 100)
2	SMART LINK button Start a desired Wi-Fi function. (p. 30)
3	Microphone
4	Eyelet for camera strap
5	Speaker
6	Image sensor

No.	Name
7	Lens release button
8	Lens mount
9	Lens mount index
10	AF-assist light/Timer lamp
11	Power switch
12	Shutter button

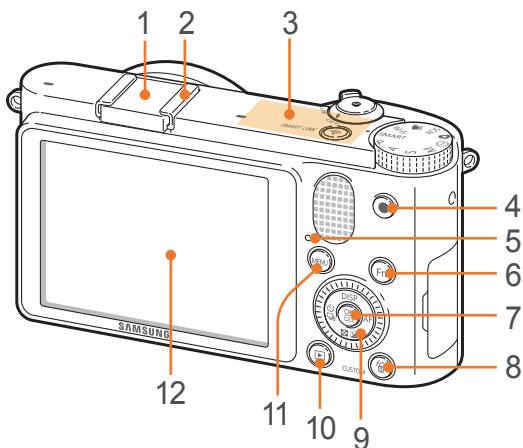

No.	Name
1	Hot-shoe cover
2	Hot-shoe
3	Internal antenna * Avoid contact with the internal antenna while using the wireless network.
4	Video recording button Start recording a video.
5	Status lamp Indicate the status of the camera. <ul style="list-style-type: none"> • Blinking: When saving a photo, shooting a video, sending data to a computer or printer, or connecting to WLAN or sending a photo. • Steady: When there is no data transfer or when data transfer to a computer or printer is complete.
6	Fn button Access major functions and fine-tune some settings.
7	OK button <ul style="list-style-type: none"> • In the Menu screen: Save the selected options. • In Shooting mode: Allow you to select a focus area manually in some shooting modes.

No.	Name
8	Delete/Custom button <ul style="list-style-type: none"> • In Shooting mode: Perform the assigned function. (p. 128) • In Playback mode: Delete files.
9	Navigation button (Smart dial) <ul style="list-style-type: none"> • In Shooting mode <ul style="list-style-type: none"> - DISP: View camera settings and change options - : Adjust the exposure value/In M mode, select an aperture value or shutter speed - : Select a drive option - AF: Select an AF mode • In other situations Move up, down, left, right, respectively. (You can also rotate the navigation button to move through screens or scroll through files.)
10	Playback button Enter Playback mode.
11	MENU button Access options or menus.
12	Display

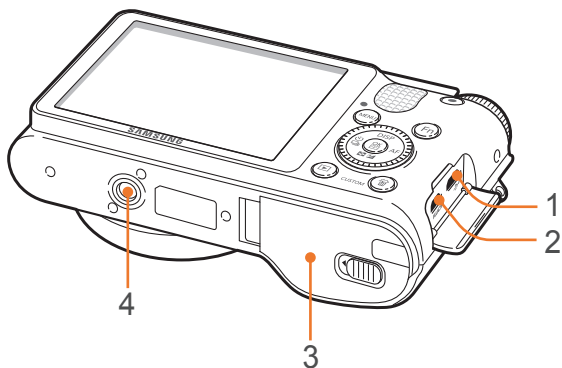

No.	Name
1	USB and shutter release port Connect the camera to a computer or shutter release. Use a shutter release cable with a tripod to minimize camera movement.
2	HDMI port
3	Battery chamber/Memory card cover Insert a memory card and battery.
4	Tripod mount

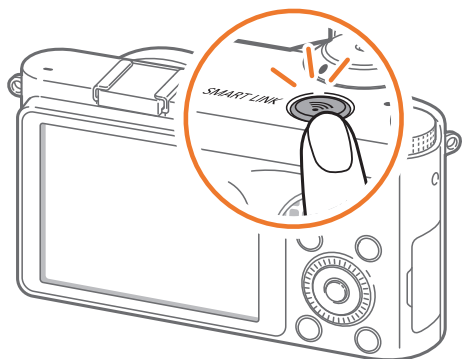

Using the SMART LINK button

You can turn on the Wi-Fi feature conveniently with the SMART LINK button.

Press the SMART LINK button to activate the Wi-Fi function that you have designated. The ring around button will light up and the camera will activate the designated function.

Setting a SMART LINK option

You can select a Wi-Fi function to launch when you press the SMART LINK button.

To set a SMART LINK option,

In Shooting mode, press [MENU] →  → Key Mapping → SMART LINK → an option.

Display icons

In Shooting mode

Capturing photos

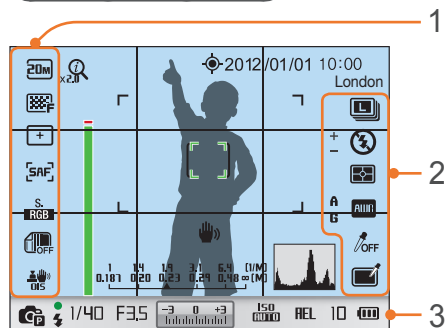

1. Shooting options (left)

Icon	Description
	Photo size
	Photo quality
	Focus area
	Face detection
	AF mode (p. 65)
	Color space
	Smart range (p. 82)
	Optical Image Stabilization (OIS) (p. 71)

2. Shooting options (right)

Icon	Description
	Drive mode

Icon	Description
	Flash option
	Flash intensity
	Metering (p. 79)
	White Balance (p. 61)
	White Balance micro adjustment
	Face tone
	Face retouch
	Picture Wizard (p. 64)
	Smart filter (p. 50)
	Magic frame (p. 50)
	Selective color (p. 83)

3. Shooting information

Icon	Description
	z zoom on
	x2.0 zoom ratio
	AutoShare on
	GPS activated*
	2012/01/01 Date
	10:00 Time
	London Location information*
	Focus aid bar (p. 70)**
	Auto focus frame
	Spot metering area

Icon	Description
	Distance Scale (p. 127)
	Level gauge (p. 32)
	Camera shake
	Histogram (p. 127)
	Shooting mode
	Focus
	Flash indicator
	1/40 Shutter speed
	F3.5 Aperture value
	Exposure value
	ISO AUTO ISO sensitivity (p. 60)
	REL Auto Exposure Lock (p. 86)
	Memory card not inserted***
	10 Available number of photos
	<ul style="list-style-type: none"> : Fully charged : Partially charged (Red): Empty (recharge the battery)

* These icons appear when you attach an optional GPS module.

** This icon appears when you select the FA option of the MF Assist function.

*** Photos that were captured without inserting a memory card cannot be printed, or transferred to a memory card or a computer.



The icons displayed will change according to the mode you select or the options you set.

Recording videos

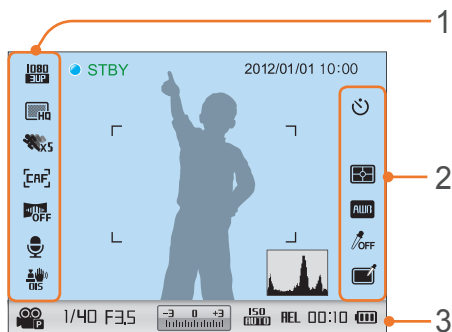

1. Shooting options (left)

Icon	Description
CAF	Auto focus activated
1080 50P	Video size
HQ	Video quality
X5	Multi Motion
CAF	AF mode (p. 65)
OFF	Fader (p. 88)
	Voice recording on (p. 88)
	Optical Image Stabilization (OIS) (p. 71)

2. Shooting options (right)

Icon	Description
	Timer
	Metering (p. 79)
AWB	White Balance (p. 61)
OFF	Picture Wizard (p. 64)
	Selective color (p. 83)

3. Shooting information

Icon	Description
2012/01/01	Date
10:00	Time
	Histogram (p. 127)
	Movie AE mode
1/40	Shutter speed
F3.5	Aperture value
	Exposure value
ISO AUTO	ISO sensitivity
REL	Auto Exposure Lock (p. 86)
	Memory card not inserted

Icon	Description
00:10	Available recording time
	<ul style="list-style-type: none"> : Fully charged : Partially charged : Empty (recharge the battery)



The icons displayed will change according to the mode you select or the options you set.

About the level gauge

The level gauge helps you align the camera with the horizontal and vertical lines on the display. If the level gauge is not level, calibrate the level gauge using the Horizontal Calibration function. (p. 131)

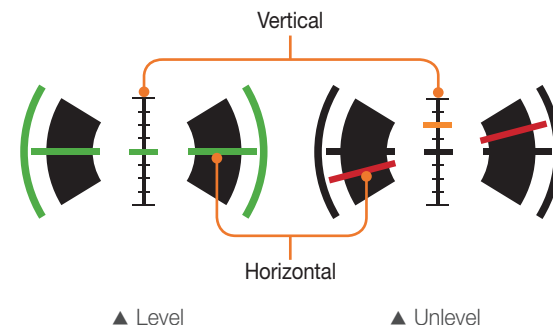

In Playback mode

Viewing photos

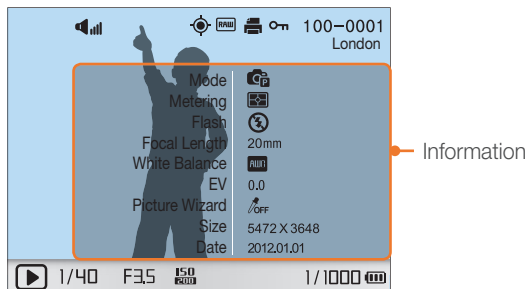

Information

Icon	Description
	Volume
	Continuously captured file
	Location information
	RAW file
	3D file
	Print information added to file (p. 138)
	Protected file
100-0001	Folder number - File number
London	Location information
1/40	Shutter speed
F3.5	Aperture value
ISO 200	ISO value
1/1000	Current file/The total number of files

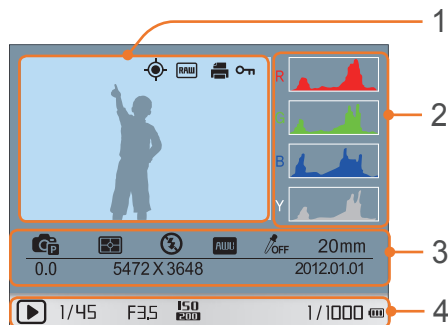

No.	Description
1	Captured photo
2	RGB histogram (p. 127)
3	Shooting mode, Metering, Flash, White Balance, Picture Wizard, Focus range, Exposure value, Photo size, Date
4	Shutter speed, Aperture value, ISO value, Current file/The total number of files

Playing videos

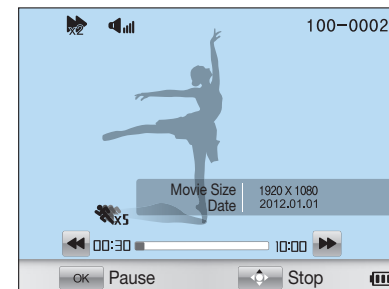

Icon	Description
	Playback speed
	Volume
100-0002	Folder number - File number
	Multi Motion
00:30	Current playback time
10:00	Video length

Lenses

You can purchase optional lenses made exclusively for your NX series camera. Learn about the functions of each lens and select one that suits your needs and preferences.

Lens layout

SAMSUNG 20-50 mm F3.5-5.6 ED II lens (example)

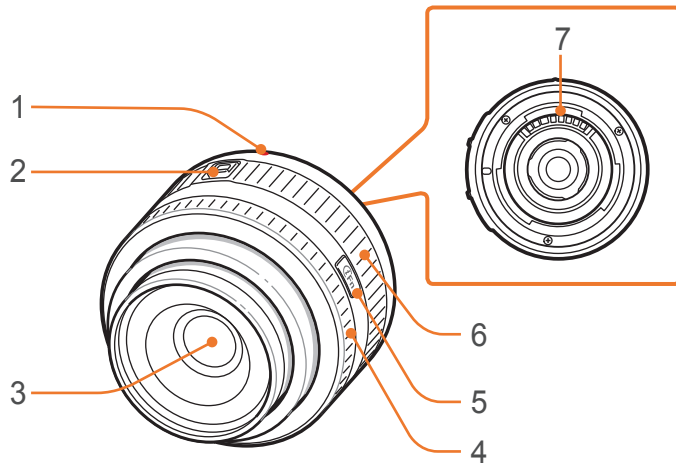

No.	Description
1	Lens mount index
2	Zoom lock switch
3	Lens
4	Focus ring (p. 66)
5	i-Function button (p. 48)
6	Zoom ring
7	Lens contacts



When not using the lens, attach the lens cap and lens mount cover to protect the lens from dust and scratches.

Locking or unlocking the lens

To lock the lens, pull and hold the zoom lock switch away from the camera body and rotate the zoom ring clockwise.

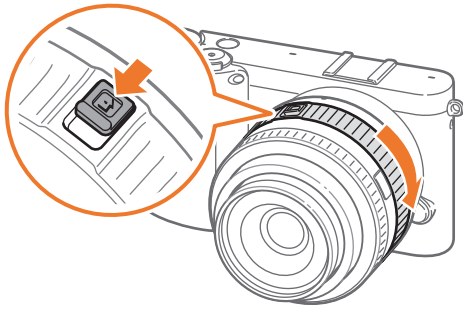

To unlock the lens, rotate the zoom ring counter-clockwise until you hear the click.

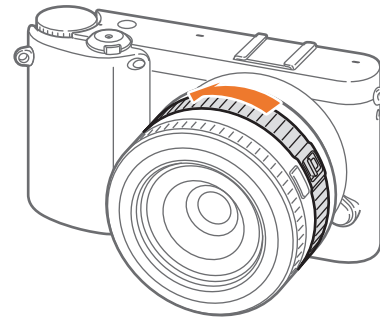

You cannot capture a photo when the lens is locked.

SAMSUNG 18-55 mm F3.5-5.6 OIS III lens (example)

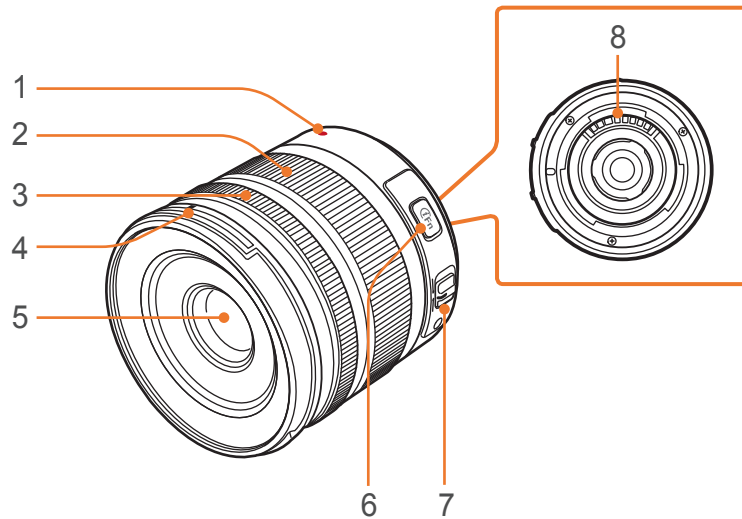

No.	Description
1	Lens mount index
2	Zoom ring
3	Focus ring (p. 66)
4	Lens hood mount index
5	Lens
6	i-Function button (p. 48)
7	AF/MF switch (p. 65)
8	Lens contacts

SAMSUNG 16 mm F2.4 lens (example)

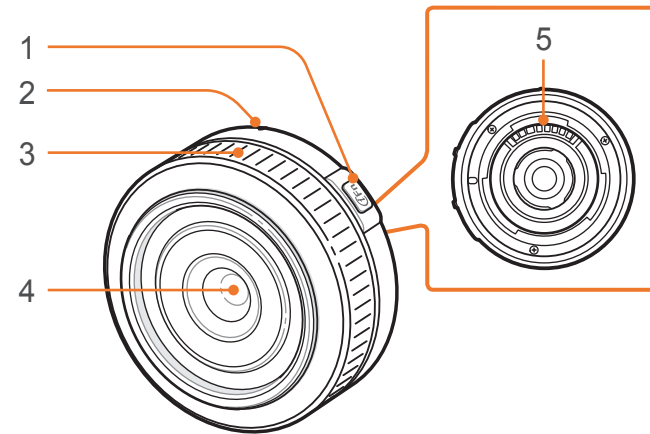

No.	Description
1	i-Function button (p. 48)
2	Lens mount index
3	Focus ring (p. 66)
4	Lens
5	Lens contacts

Lens markings

Find out what the numbers on the lens signify.

SAMSUNG 18-200 mm F3.5-6.3 ED OIS lens (example)

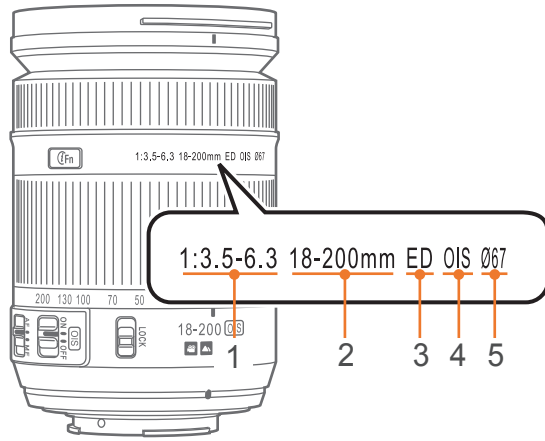

No.	Description
1	Aperture value A range of supported aperture values. For example, 1:3.5-6.3 means the maximum aperture value range from 3.5 to 6.3.
2	Focal length The distance from the middle of the lens to its focal point (in millimeters). This figure is expressed in a range: minimum focal length to maximum focal length of the lens. Longer focal lengths result in narrower angles of view and the subject is magnified. Shorter focal lengths result in wider angles of view.
3	ED ED stands for Extra-low Dispersion. Extra-low dispersion glass is effective in minimizing chromatic aberration (a distortion that occurs when a lens fails to focus all colors to the same convergence point).
4	OIS (p. 71) Optical Image Stabilization. Lenses with this feature can detect camera shake and effectively cancel out the movement inside the camera.
5	Ø The lens diameter. When you attach a filter to the lens, make sure that the diameters of the lens and the filter are the same.

Accessories

You can use accessories including external flash and GPS module that can help you capture better and more convenient photos.

For more information about optional accessories, refer to the manual for each accessory.



- The illustrations may differ from the actual items.
- You can purchase Samsung-approved accessories at a retailer or a Samsung service center. Samsung is not responsible for damage caused by using another manufacturer's accessories.

External flash layout

SEF220A (example) (optional)

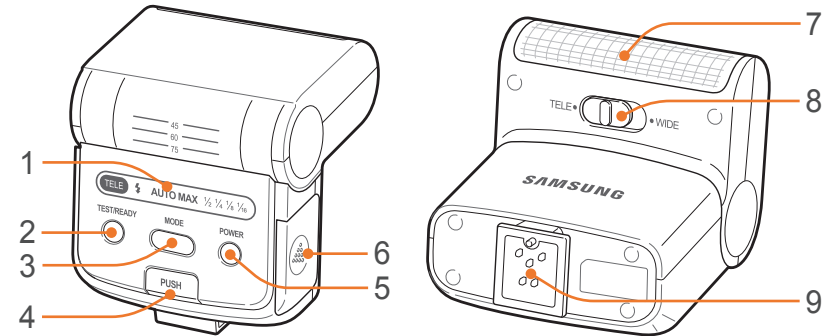

No.	Description
1	Display icons
2	READY lamp/Test button
3	MODE button
4	Flash release button
5	POWER button
6	Battery cover
7	Bulb
8	TELE/WIDE mode switch
9	Hot-shoe connection

SEF8A (example)

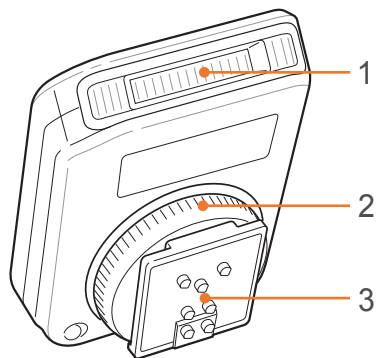

No.	Description
1	Bulb
2	Hot-shoe fastening dial
3	Hot-shoe connection

Connecting the flash

1 Remove the hot-shoe cover from the camera.

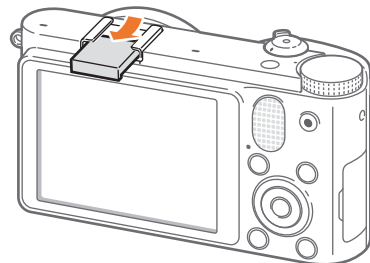

2 Mount the flash by sliding it into the hot-shoe.

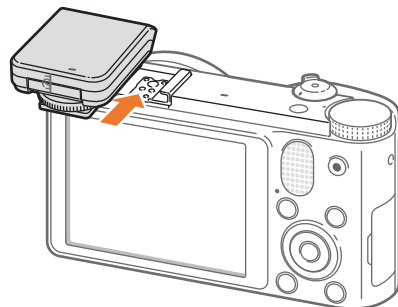

- 3 Lock the flash into place by turning the hot-shoe fastening dial clockwise.

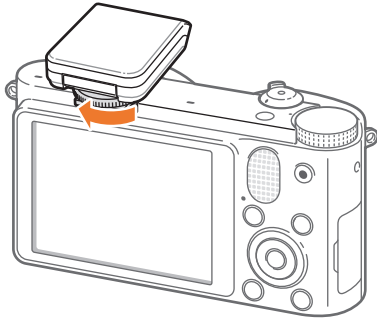

- 4 Lift up the flash for use.

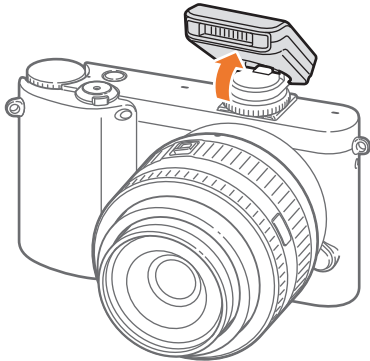

- You can capture a photo with a flash that is not fully charged, but it is recommended to use a fully charged flash.
- Refer to the optional accessories page for available external flashes. (p. 171)
- The available options may differ depending on the shooting mode.
- There is an interval between two bursts of the flash. Do not move until the flash fires a second time.
- SEF8A may not be compatible with other NX series cameras.
- For more details about optional flashes, refer to the user manual for the flash.



Use only Samsung-approved flashes. Using incompatible flashes may damage your camera.

GPS module layout (optional)

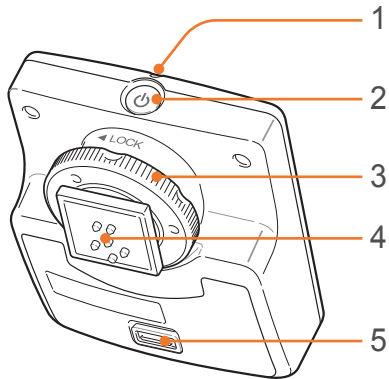

No.	Description
1	Status lamp
2	POWER button
3	Hot-shoe fastening dial
4	Hot-shoe connection
5	Battery cover

Attaching the GPS module

1 Remove the hot-shoe cover from the camera.

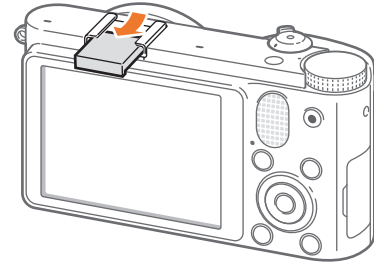

2 Mount the GPS module by sliding in into the hot-shoe.

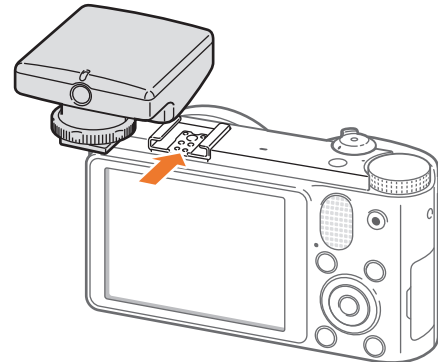

- 3 Lock the GPS module into place by turning the hot-shoe fastening dial towards LOCK.

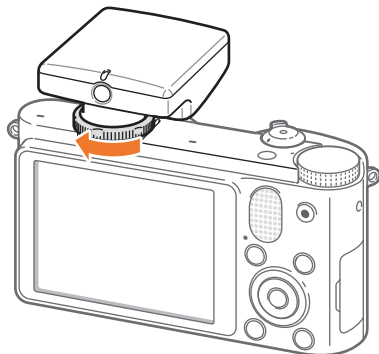

- 4 Press the power button of the GPS module.



Shooting modes

Two simple shooting modes—Smart Auto and Scene mode—help you capture photos with numerous automatic settings. Additional modes allow for greater customization of settings.



Icon	Description
SMART	Smart Auto mode (p. 43)
P	Program mode (p. 44)
A	Aperture Priority mode (p. 45)
S	Shutter Priority mode (p. 45)
M	Manual mode (p. 46)
i	Lens Priority Mode (p. 47)
★	Magic Mode (p. 50)
SCN	Scene mode (p. 51)
🎥	Movie mode (p. 54)
Wi-Fi	Wi-Fi (p. 100)

SMART Smart Auto mode

In Smart Auto mode, the camera recognizes surrounding conditions and automatically adjusts factors that contribute to exposure, including shutter speed, aperture value, metering, White Balance, and exposure compensation. As the camera controls most of the functions, some shooting functions are limited. This mode is useful for capturing quick snapshots with the least amount of adjustment.



The camera may detect different scenes, even the same subjects, depending on external factors such as camera shake, lighting, and distance to the subject.

P Program mode

The camera automatically adjusts shutter speed and aperture value so that an optimal exposure value can be achieved.

This mode is useful when you want to capture shots of constant exposure while being able to adjust other settings.

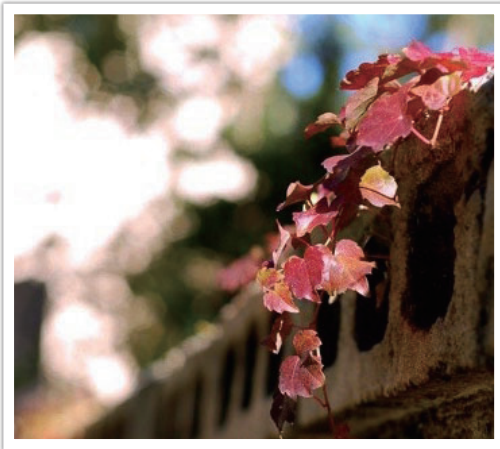

Program Shift

Program Shift function lets you adjust the shutter speed and aperture value while the camera maintains the same exposure. When you rotate the navigation button counter-clockwise, the shutter speed decreases and the aperture value increases. When you rotate the navigation button clockwise, the shutter speed increases and the aperture value decreases.

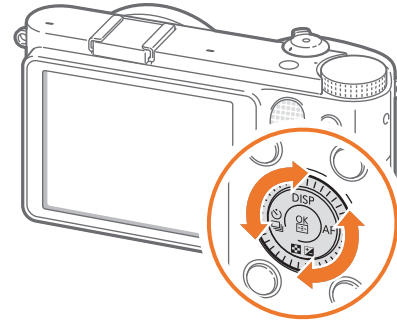

A Aperture Priority mode

In Aperture Priority mode, the camera automatically calculates shutter speed according to the aperture value you choose. You can adjust the depth of field (DOF) by changing the aperture value. This mode is useful for taking portraits and landscape shots.

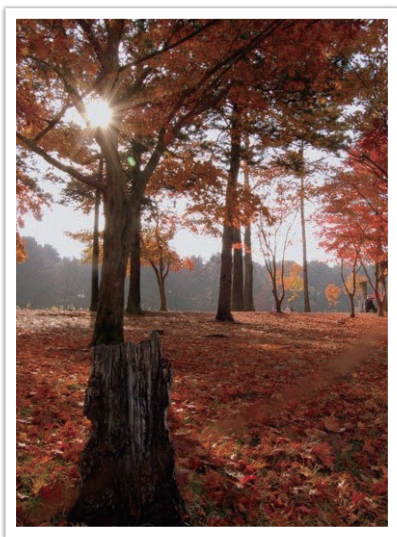

Large Depth of Field

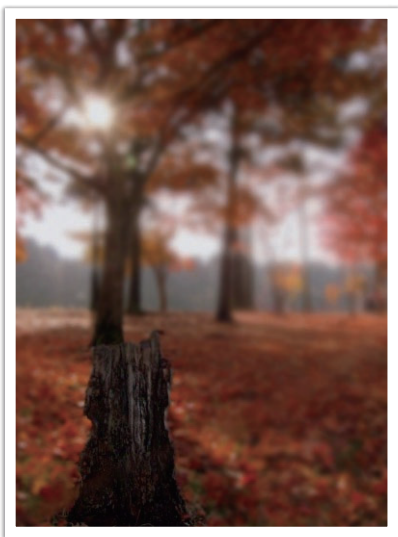

Small Depth of Field



In low-light settings, you may need to increase the ISO sensitivity to prevent blurred photos.

S Shutter Priority mode

In Shutter Priority mode, the camera automatically adjusts the aperture value according to the shutter speed you choose. This mode is useful for capturing photos of fast-moving subjects or for creating tracer effects in a photo.

For example, set the shutter speed to over 1/500 s to freeze the subject. To make the subject appear blurred set the shutter speed to below 1/30 s.



Slow shutter speed

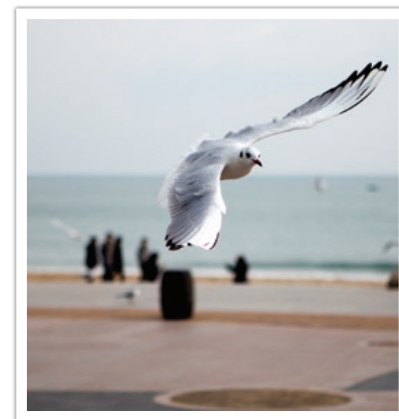

Fast shutter speed



In order to compensate for the reduced amount of light allowed by fast shutter speeds, open the aperture and let in more light. If your photos are still too dark, increase the ISO value.

M Manual mode

Manual mode lets you adjust the shutter speed and aperture value manually. In this mode, you can fully control the exposure of your photos.

This mode is useful in controlled shooting environments, such as a studio, or when it is necessary to fine-tune camera settings. The Manual mode is also recommended for shooting night scenes or fireworks.

Framing mode

When you adjust the aperture value or shutter speed, the exposure changes according to the settings, so the display may darken. With this function on, the brightness of the display is constant regardless of the settings, so you can better frame your shot.



To use Framing Mode,

In Shooting mode, press **[MENU]** →  → **Framing Mode** → an option.

Using bulb

Use a bulb to shoot night scenes or the night sky. While you are pressing **[Shutter]**, the shutter is left open so you can create moving light effects.

To use a bulb,

Press   to select a shutter speed, and then rotate the navigation button counter-clockwise to **Bulb** → Press and hold **[Shutter]** for the desired time.



- If you set a high ISO value or open the shutter for a long time, image noise may increase.
- The continuous shooting function cannot be used with the Bulb function.

Lens Priority mode

Using the effect mode

You can select an appropriate scene (i-Scene) or a filter effect to the lens you attached. Available scenes and filter effects may differ depending on the lens attached.

1 Rotate the mode dial to .

2 Press [**i-Function**] on the lens to select  effect.

- You can also use this function by pressing [**Fn**].

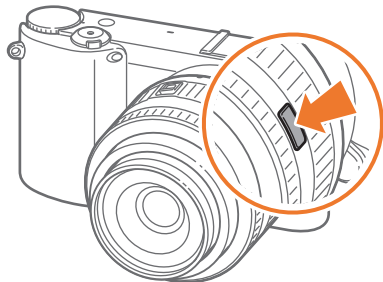

3 Adjust the focus ring to select a scene or filter effect.

- If you pressed [**Fn**] to select  effect, press [**OK**], and then rotate the navigation button or press [**Q/AF**] to select an option.

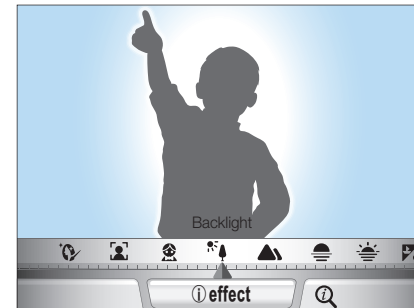
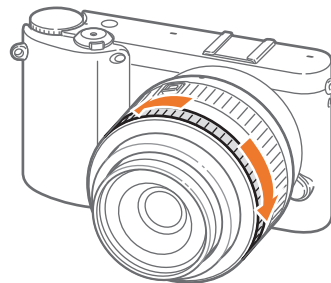

4 Fully press [**Shutter**] to capture the photo.



Available scene modes and filter effects (for SAMSUNG 20-50 mm F3.5-5.6 ED II lens): Beauty Shot, Portrait, Children, Backlight, Landscape, Sunset, Dawn, Beach & Snow, Night, Vignetting, Miniature, Fish Eye, Sketch, Defog, Halftone Dots

Using i-Function in PASM modes

When you use the i-Function button on an i-Function lens, you can manually select and adjust shutter speed, aperture value, exposure value, ISO sensitivity, and White Balance on the lens.

1 Rotate the mode dial to **P**, **A**, **S**, or **M**.

2 Press [**i-Function**] on the lens to select a setting.

- You can also rotate the navigation button or press [**i-Function**]/**AF** to select a setting.

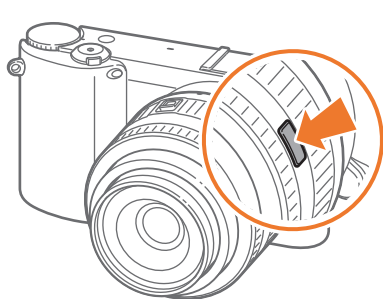

3 Adjust the focus ring to select an option.

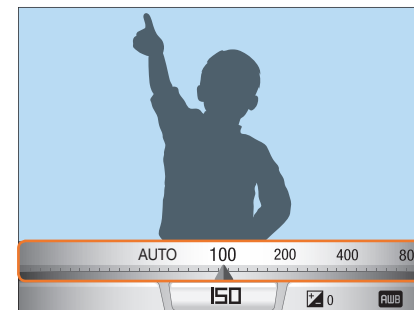
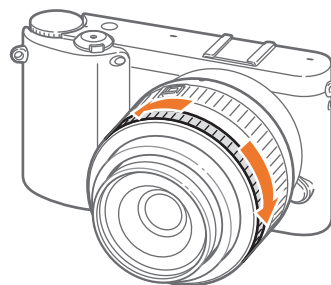

4 Fully press [**Shutter**] to capture the photo.

Available options

Shooting mode	P	A	S	M
Aperture value	-	○	-	○
Shutter speed	-	-	○	○
Exposure value	○	○	○	-
ISO	○	○	○	○
White Balance	○	○	○	○
i zoom	○	○	○	○



To select items to appear when you press [i-Function] on the lens in Shooting mode, press [MENU] → → **iFn Customizing** → an option → [MENU].

Using **i zoom**

The **i zoom** allows you to zoom in on a subject with less degradation of photo quality than the Digital zoom. However, the photo resolution may change compared to when you zoom in by rotating the zoom ring.

1 Rotate the mode dial to **P**, **A**, **S**, **M**, or **i**.

2 Press [i-Function] on the lens to select **i zoom**.

- You can also rotate the navigation button or press [/AF] to select a setting.

3 Adjust the focus ring to select an option.

- Photo resolution varies according to the zoom rate if you use the **i zoom**.

	3:2	16:9	1:1
x1.2	4560X3040 (13.9M)	4560X2568 (11.7M)	3040X3040 (9.2M)
x1.4	3888X2592 (10.1M)	3888X2184 (8.5M)	2592X2592 (6.7M)
x1.7	3264X2176 (7.1M)	3264X1840 (6.0M)	2176X2176 (4.7M)
x2	2736X1824 (5.0M)	2736X1536 (4.2M)	1824X1824 (3.3M)

These figures are based on the maximum resolution at each image ratio.

4 Fully press [Shutter] to capture the photo.



- **i zoom** is not available when you capture burst shots.
- **i zoom** is not available when you capture photos in the RAW file format.
- **i zoom** is deactivated when you record videos by pressing the video recording button.

Magic mode

You can apply various filter effects and frame effects to your photos or videos to create unique images. The shape and the feel of the photos or videos will change according to the effect you select.

To set an effect,

In Shooting mode, press **[Fn]** → **Magic Mode** → **Magic Frame** or **Smart Filter** → a desired effect.



- If you select **Sketch** among filter effects, the photo size will automatically change to 5.9M or below.
- If you set a frame effect, the photo size will be automatically set to 2M.
- You cannot record a video with a frame effect.
- If you set a filter effect, the size of the video will be 640X480 or below.









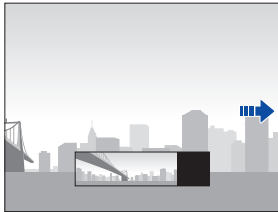





SCN Scene mode







In Scene mode, the camera selects the best settings for each type of scene.





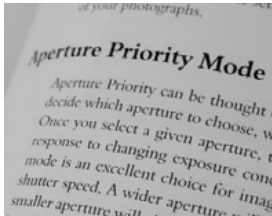

You can select a desired scene by pressing **[Fn]** in Shooting mode.

Icon	Description
	<p>Panorama: Capture a 2D or 3D panoramic photo. Captured 3D panoramic photos can be viewed only on a 3D TV.</p>  <ul style="list-style-type: none"> The maximum size of a 2D panoramic photo is 8000 X 1152 (horizontal) and 1728 X 4752 (vertical). The maximum size of a 3D panoramic photo is 3300 X 768 (horizontal). In Panorama mode, some shooting options are not available. The camera may stop shooting due to the shooting composition or the subject's movement. In Panorama mode, your camera may not capture the entire last scene if you stop moving the camera to improve the photo quality. To capture the entire scene, move your camera slightly beyond the point where you want the scene to end.

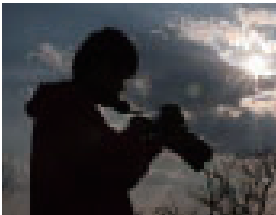
Icon	Description
	<ul style="list-style-type: none"> In 3D Panorama mode, your camera may not capture the very beginning or end of a scene due to the nature of the 3D effect. To capture the entire scene, move slightly beyond the beginning and end points you want to capture. In 3D Panorama mode, photos are captured in both JPEG and MPO file formats. You can view an MPO file that supports the 3D effect only on an MPO-compatible display, such as 3D TV or 3D monitor. On your camera's display, you can view only JPEG files. Use proper 3D glasses when you view an MPO file on a 3D TV or 3D monitor.
	<p>Beauty Shot: Hide facial imperfections.</p> 
	<p>Night: Capture scenes at night or in low lighting. Use a tripod to prevent your camera from shaking that is caused by low shutter speed.</p> 

Icon	Description
	<p>Landscape: Capture still-life scenes and landscapes.</p> 
	<p>Portrait: Automatically detect and focus on human faces so that you can achieve clear, soft portraits.</p> 
	<p>Children: Make children appear more noticeable by capturing their clothes and the background vividly.</p> 
	<p>Sports: Capture fast moving subjects.</p> 

Icon	Description
	<p>Close Up: Capture detailed parts of a subject or small subjects, such as flowers or insects.</p> 
	<p>Text: Clearly capture text from printed or electronic documents.</p> 
	<p>Sunset: Capture scenes at sunset, with natural-looking reds and yellows.</p> 
	<p>Dawn: Capture scenes at sunrise.</p> 

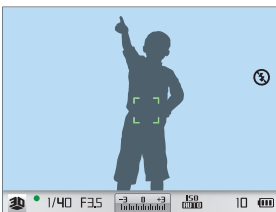
Icon	Description
	<p>Backlight: Capture backlit subjects.</p> 
	<p>Fireworks: Capture colorful fireworks at night. Use a tripod to prevent your camera from shaking.</p> 
	<p>Beach & Snow: Reduce underexposed photos due to sunlight reflected from sand or snow.</p> 
	<p>3D: Captured 3D photos that can be viewed on a 3D TV. (p. 136)</p> 



Movie mode

In Movie mode, you can shoot videos in Full High Definition (1920X1080) and capture sound via the camera's microphone.

In order to adjust the exposure level, you can select **Program** in the **Movie AE Mode** options menu so that the aperture value and shutter speed can be automatically set or select **Aperture Priority** to manually set the aperture value. You can also select **Shutter Priority** to manually set the shutter speed or select **Manual** to manually set both the aperture value and shutter speed. While shooting a video, press **[AF]** to activate or deactivate the AF function.

Select **Fader** to fade in or out a scene. You can also select **Voice** to mute or un-mute voice.

The camera lets you capture video files up to 25 minutes in length at 30 or 24 fps, and saves the files in MP4 (H.264) format. 24 fps is available only with 1920X810.



- H.264 (MPEG-4 part10/AVC) is the latest video coding format established in 2003 collaboratively by ISO-IEC and ITU-T. Since this format uses a high compression rate, more data can be saved in less memory space.
- If you set the image stabilizer option on when shooting a movie, the camera may record the image stabilizer sound.
- The zoom sound or other lens sounds may be recorded if you adjust the lens while recording a video.
- When using an optional video lens, the autofocus noise is not recorded.
- If you remove the camera lens while recording a movie, the recording will be interrupted. Do not change the lens while recording.
- If you attach an external microphone while recording a movie, sound will not be recorded through the external microphone. (The previous settings are maintained.) If you remove the external microphone while recording a movie, sound will not be recorded. Turn off the camera before attaching or removing the external microphone.
- If you change the shooting angle of the camera suddenly while shooting a movie, the camera may not be able to record images accurately. Use a tripod to minimize camera shake.
- In Movie mode, the camera supports only the Multi AF function. You cannot use any other focus area setting functions, such as Face Detection AF.
- When the size of a movie file exceeds 4 GB, the camera automatically stops recording. If this occurs, continue shooting by starting a new movie file.
- If you use a slow writing memory card, the recording of your movie can be interrupted because the card cannot process data at the rate the video is being shot. If this occurs, replace the card with a faster memory card or reduce the image size (for example, from 1280X720 to 640X480).
- When formatting a memory card, always format using the camera. If you format on another camera or a PC, you can lose files on the card or cause a change in the capacity of the card.

Available functions by shooting mode

For details about shooting functions, see Chapter 2.

Function	Available in
Size (p. 57)	P/A/S/M/i/★*/SCN*/ 📷/SMART
Quality (p. 59)	P/A/S/M/i/★*/SCN*/📷
ISO (p. 60)	P/A/S/M*/📷*
White Balance (p. 61)	P/A/S/M/📷
Picture Wizard (p. 64)	P/A/S/M/📷
Selective Color (p. 83)	P/A/S/M/📷
AF Mode (p. 65)	P/A/S/M/i*/★*/SCN*/📷*
AF Area (p. 67)	P/A/S/M/i*/SCN*
MF Assist (p. 70)	P/A/S/M/i/★*/SCN/📷/ SMART
OIS (p. 71)	P/A/S/M/i/★*/SCN/📷/ SMART
Drive (Continuous/Burst/Timer/ Bracketing) (p. 72)	P/A/S/M/i*/★*/SCN*/📷*/ SMART*

Function	Available in
Metering (p. 79)	P/A/S/M/📷
Smart Range (p. 82)	P/A/S/M
Color Space (p. 84)	P/A/S/M/i/★*/SCN/SMART
Flash (p. 76)	P*/A*/S*/M*/★*/SCN*/SMART*
Exposure compensation (p. 85)	P/A/S/i/★*/SCN/📷
Exposure lock (p. 86)	P/A/S/📷*
Noise Reduction (p. 125)	P/A/S/M

* Some functions are limited in these modes.



Chapter 2

Shooting Functions

Learn about the functions you can set in Shooting mode.
You can enjoy more customized photos and videos by using the shooting functions.

Size

As you increase the resolution, your photo or video will include more pixels, so it can be printed on larger paper or displayed on a larger screen. When you use a high resolution, the file size will also increase. Select a low resolution for photos that will be displayed in a digital picture frame or uploaded to the web.







To set the size,

In Shooting mode, press **[Fn]** → **Photo Size** or **Movie Size** → an option.

Photo size options

Icon	Size	Recommended for
	20.0M (5472X3648) (3:2)	Printing on A1 paper.
	10.1M (3888X2592) (3:2)	Printing on A2 paper.
	5.9M (2976X1984) (3:2)	Printing on A3 paper.
	2.0M (1728X1152) (3:2)	Printing on A5 paper.
	16.9M (5472X3080) (16:9)	Printing on A1 paper or viewing on an HDTV.
	7.8M (3712X2088) (16:9)	Printing on A3 paper or viewing on an HDTV.
	4.9M (2944X1656) (16:9)	Printing on A4 paper or viewing on an HDTV.
	2.1M (1920X1080) (16:9)	Printing on A5 paper or viewing on an HDTV.
	13.3M (3648X3648) (1:1)	Printing a square photo on A1 paper.
	7.0M (2640X2640) (1:1)	Printing a square photo on A3 paper.
	4.0M (2000X2000) (1:1)	Printing a square photo on A4 paper.
	1.1M (1024X1024) (1:1)	Attaching to an email.

Video size options

Icon	Size	Recommended for
	1920X1080 (30 FPS) (16:9)	Viewing on a Full HDTV.
	1920X810 (24 FPS) (Approx. 2.35:1)	Viewing on an HDTV.
	1280X720 (30 FPS) (16:9)	Viewing on an HDTV.
	640X480 (30 FPS) (4:3)	Viewing on a TV.
	320X240 (30 FPS) (4:3)	Post on a website using the wireless network (30 seconds maximum).



If you set the Video Out option to **PAL**, the frame rate will be reduced from 30 fps to 25 fps.



Quality

The camera saves photos in either the JPEG or RAW format.

Photos captured by a camera are often transformed to the JPEG format and stored in the memory according to the settings of the camera at the time of shooting. RAW files are not transformed to the JPEG format and are stored in the memory without any changes.



RAW files have the file extension “SRW”. To adjust and calibrate exposures, White Balances, tones, contrasts, and colors of the RAW files, or to convert them into JPEG or TIFF format, use the Adobe Photoshop Lightroom program found on the supplied DVD-ROM.





Ensure you have enough space on the memory card to save photos in the RAW format.

To set the quality,



In Shooting mode, press **[Fn]** → **Quality** → an option.

Photo quality options

Icon	Format	Description
	JPEG	Super Fine: <ul style="list-style-type: none"> Compressed for the best quality. Recommended for printing in large size.
	JPEG	Fine: <ul style="list-style-type: none"> Compressed for better quality. Recommended for printing in normal size.

Icon	Format	Description
	JPEG	Normal: <ul style="list-style-type: none"> Compressed for normal quality. Recommended for printing in small size or uploading to the web.
	RAW	RAW: <ul style="list-style-type: none"> Save a photo without data loss. Recommended for editing after shooting.
	RAW+JPEG	RAW + S.Fine: Save a photo in both the JPEG (S.Fine quality) and RAW format.
	RAW+JPEG	RAW + Fine: Save a photo in both the JPEG (Fine quality) and RAW format.
	RAW+JPEG	RAW + Normal: Save a photo in both the JPEG (Normal quality) and RAW format.

Video quality options

Icon	Extension	Description
	MP4 (H.264)	Normal: Record videos in normal quality.
	MP4 (H.264)	HQ: Record videos in high quality.

ISO sensitivity

The ISO sensitivity value represents the sensitivity of camera to light.

The larger the ISO value, the more sensitive the camera is to light. Consequently, by selecting a higher ISO sensitivity value, you can capture photos in dim or dark places at faster shutter speeds. However, this may increase electronic noise and result in a grainy photo.

To set ISO sensitivity,

In Shooting mode, press **[Fn]** → **ISO** → an option.

Examples



ISO 100



ISO 400



ISO 800



ISO 3200



- Increase the ISO value in places where flash use is prohibited. You can capture a clear photo by setting a high ISO value without having to secure more light.
- Use the High ISO NR function in order to reduce the visual noise that can appear on photos of a high ISO value. (p. 125)





White Balance (light source)





The color of a photo depends on the type and quality of the light source. If you want the color of your photo to be realistic, select an appropriate lighting condition to calibrate the White Balance, such as **Auto WB**, **Daylight**, **Cloudy**, **Tungsten**, or adjust color temperature manually. You can also adjust color for the preset light sources so that the colors of the photo match the actual scene under mixed lighting conditions.

To set the White Balance,

In Shooting mode, press **[Fn]** → **White Balance** → an option.

White Balance options

Icon	Description
	Auto WB *: Use automatic settings depending on the lighting conditions.
	Daylight *: Select when taking outdoor photos on a sunny day. This option results in photos closest to the natural colors of the scene.
	Cloudy *: Select when taking outdoor photos on a cloudy day or in shadows. Photos captured on cloudy days tend to be more bluish than on sunny days. This option offsets that effect.
	Fluorescent White *: Select when shooting under a daylight fluorescent lamp. Especially for white fluorescent light with a color temperature of about 4,200K.

Icon	Description
	Fluorescent NW *: Select when shooting under a daylight fluorescent lamp. Especially for white fluorescent light of very white hues with a temperature of about 5,000K.
	Fluorescent Daylight *: Select when shooting under a daylight fluorescent lamp. Especially for white fluorescent light of slightly bluish hue with a temperature of about 6,500K.
	Tungsten *: Select when taking indoor photos under incandescent bulbs or halogen lamps. Incandescent tungsten bulbs tend to have a reddish hue. This option offsets that effect.
	Flash WB *: Select when using a flash.
	Custom Set : Use your pre-defined settings. You can manually set the White Balance by shooting a white sheet of paper. Fill the spot metering circle with the paper and set the White Balance.

* These options can be customized.

Option	Description
K	<p>Color Temperature: Manually adjust the color temperature of the light source. Color temperature is a measurement in degrees Kelvin that indicates the specific type of light source. As the color temperature increases, the color distribution becomes cooler. Alternatively, as the color temperature decreases, the color distribution becomes warmer.</p> <p>10,000 K — Clear sky</p> <p>8,000 K — Fluorescent H</p> <p>6,000 K — Cloudy</p> <p>5,000 K — Daylight</p> <p>4,000 K — Fluorescent L</p> <p>3,000 K — Halogen lamp</p> <p>2,000 K — Tungsten</p> <p>2,000 K — Candle light</p>

Customizing preset options

You can also customize preset White Balance options.

To customize preset options,

In Shooting mode, press [Fn] → White Balance → an option → [DISP] → rotate the navigation button or press [DISP/⊞/⊞/⊞/AF].

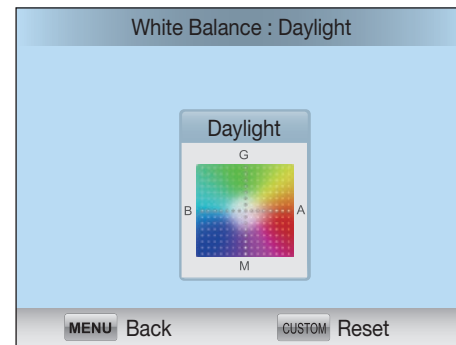

Examples



Auto WB



Daylight



Fluorescent Daylight

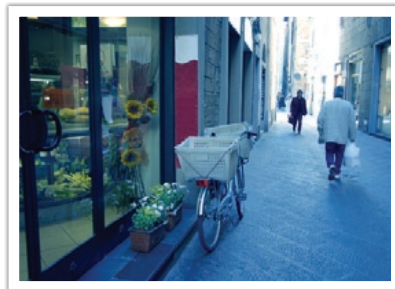

Tungsten



Picture Wizard (photo styles)

Picture Wizard lets you apply different photo styles to your photo to create various looks and emotional moods. You can also create and save your own photo styles by adjusting color, saturation, sharpness, and contrast for each style.

If you select an option, the camera automatically adjusts the photo according to the option. Experiment with different styles and find your own settings.

To set a photo style,

In Shooting mode, press **[Fn]** → **Picture Wizard** → an option.

Examples



Standard



Vivid



Portrait



Landscape



Forest



Retro



Cool



Calm



Classic



You can also adjust the value of the preset style settings. Select a Picture Wizard option, press **[DISP]**, and then adjust color, saturation, sharpness, or contrast.

AF mode

Learn how to adjust the camera's focus according to the subjects.

You can select a focusing mode appropriate to the subject among Single Auto Focus, Continuous Auto Focus, and Manual Focus. The AF function is activated when you press **[Shutter]** halfway. In the MF mode, you have to rotate the focus ring on the lens to focus manually.

In most cases, you can have a focus by selecting **Single AF**. Fast moving subjects or subjects of a color similar to the background are difficult to focus. Select an appropriate focusing mode for such instances.

If your lens has an AF/MF switch, you have to set the switch to select a focusing mode. Set the switch to AF to select Single AF or Continuous AF. Set the switch to MF to adjust the focus manually.

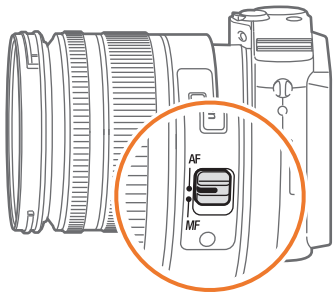

When your lens has no AF/MF switch, press **[AF]** to select a desired AF mode.

To set the auto focus mode,

In Shooting mode, press **[AF]** → an option.

Single AF

Single AF is appropriate for shooting a still subject. When you press **[Shutter]** halfway, the focus fixes in the focus area. The area turns green when the focus is achieved.



Continuous AF

While you are pressing [**Shutter**] halfway, the camera continues to automatic focusing. Once the focus area is fixed on the subject, the subject is always in focus even when moving. This mode is recommended for shooting a person on a bicycle, a running dog, or a car racing scene.



Manual focus

You can manually focus on a subject by rotating the focus ring on the lens. The MF Assist function lets you easily achieve a focus. While you are rotating the focus ring, the focus area is magnified or the focus aid bar appears to help you achieve a clear focus. This mode is recommended for shooting an object similar in color to the background, a night scene, or fireworks.



AF area

The AF area function changes the positions of the focus area.

Generally, cameras focus on the nearest subject. When there are a lot of subjects, however, unwanted subjects can be in focus. In order to prevent unwanted subjects from being in focus, change the focus area so that a desired subject is in focus. You can get a clearer and sharper photo by selecting an appropriate focus area.

To set the auto focus area,

In Shooting mode, press **[Fn]** → **AF Area** → an option.

Selection AF

You can set the focus on an area you want. Apply an out-of-focus effect to make the subject more distinguishable.

The focus on the photo below was repositioned and resized so that it fits the subject's face.

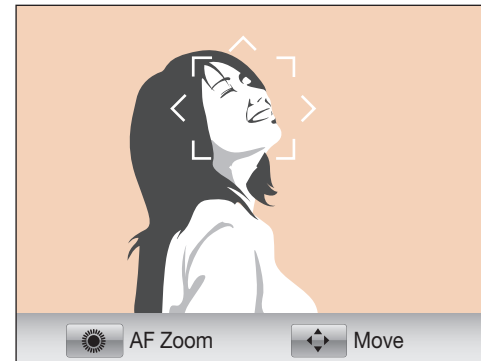

To resize or move the focus area, in Shooting mode, press **[OK]**. Press **[DISP/☐]** **[Z/☐/AF]** to adjust the location of the focus area. Rotate the navigation button to adjust the size of the focus area.

Multi AF

The camera displays a green rectangle in places where focus is set correctly. The photo is divided into multiple areas, and the camera obtains focus points of each area. It is recommended for scenery photos.

When you press [**Shutter**] halfway, the camera displays the focus areas in green as shown in the photo below.



Face detection AF

The camera focuses on human faces preferentially. Faces of up to 10 people can be detected. This setting is recommended for shooting a group of people.

When you press [**Shutter**] halfway, the camera focuses on faces as shown in the photo below. In cases of shooting a group of people, the camera displays the focus on the nearest person's face in white and the rest of the people's faces in gray.

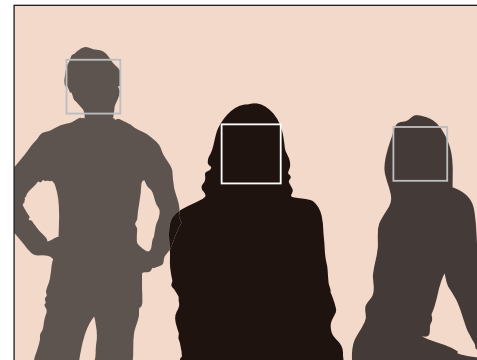

Self-portrait AF

It can be difficult to check whether your face is in focus when you are taking a self-portrait. When this function is on, the beep from the camera gets faster when your face is located at the center of the composition.

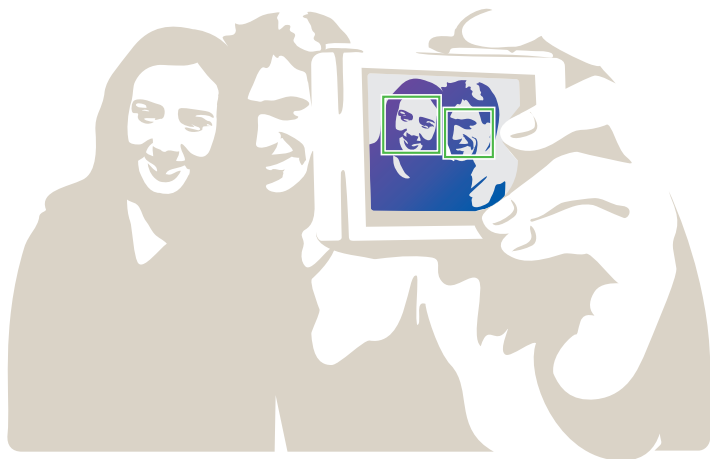

MF assist

In the manual focus (MF) mode, you have to rotate the focus ring on the lens to focus manually. When you set the MF Assist function, you can achieve a clearer focus. This function is only available on a lens that supports manual focus.

To set the manual focus assist,

In Shooting mode, press **[MENU]** →  or  → **MF Assist** → an option.

* Default

Option	Description
Off	Do not use the MF Assist function.
Enlarge x5*	The focus area is magnified by 5 times when you rotate the focus ring. 

* Default

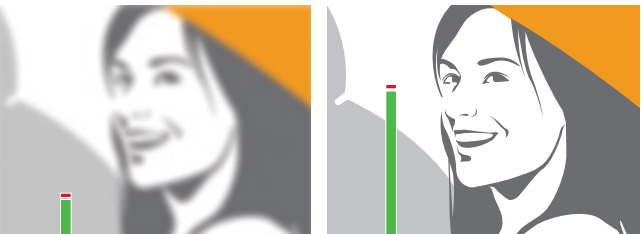
Option	Description
Enlarge x8	The focus area is magnified by 8 times when you rotate the focus ring. 
FA (Focus aid bar)	The focus aid bar rises as the focus improves when you rotate the focus ring. 

Optical Image Stabilization (OIS)

Use the Optical Image Stabilization (OIS) function to minimize camera shake. OIS may not be available with some lenses.

Camera shake tends to occur in dark places or when shooting indoors. In such cases, the camera uses slower shutter speeds in order to increase the amount of light taken in, which can result in a blurry photo. You can prevent this situation by using the OIS function.



If your lens has an OIS switch, you have to set the switch to **ON** to use the OIS function.

To set OIS options,

In Shooting mode, press **[MENU]** →  or  → **OIS** → an option.

OIS options

* Default

Icon	Description
	Mode 1* : The OIS function is applied only when you press [Shutter] in full or halfway.
	Mode 2 : The OIS function is on.
	Off : The OIS function is off. (This option may not be available with some lenses.)

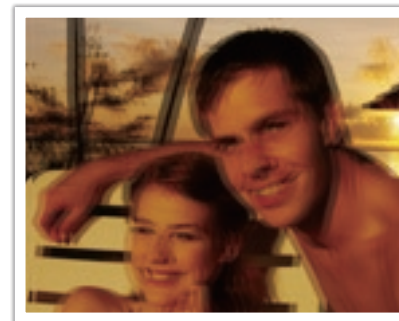

Without OIS correction

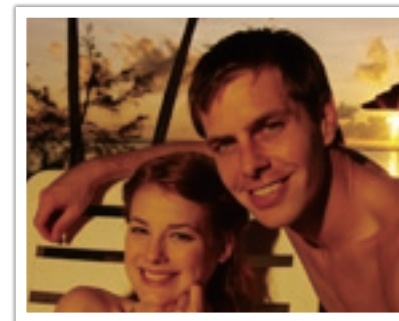

With OIS correction

Drive (shooting method)

You can set the shooting method such as Continuous, Burst, Timer and so on.

Select **Single** to capture one photo at a time. Select **Continuous** or **Burst** to shoot fast moving subjects. Select **AE Bracket**, **WB Bracket**, or **P Wiz Bracket** to adjust exposure, White Balance, or apply Picture Wizard effects. You can also select **Timer** to capture a photo of yourself.

To set the shooting method,

In Shooting mode, press [📷] → an option.

Single

Capture one photo whenever you press [Shutter]. Recommended for general conditions.

Continuous

Continuously capture photos while you are pressing [Shutter]. You can capture up to 3 photos (**Continuous Low (3fps)**) or 8 photos (**Continuous High (8fps)**) per second.



Burst

Consecutively capture up to 10 shots per second (3 seconds), 15 shots per second (2 seconds), or 30 shots per second (1 second) when you press [**Shutter**] once. Recommended for shooting the rapid motion of fast moving subjects such as racing cars.

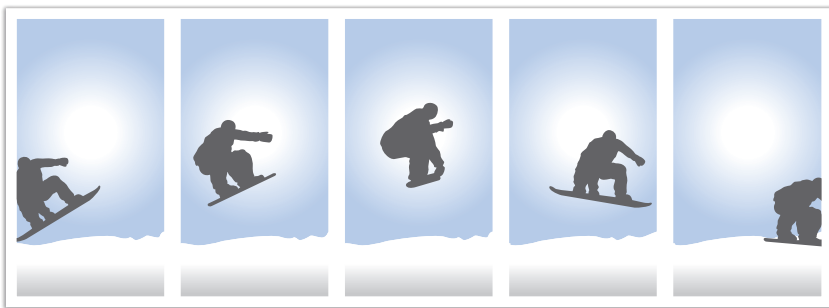

To set the number of shots, in Shooting mode, press [] → **Burst**, and then press [**DISP**].

Timer

Capture a photo with a delay of 2 to 30 seconds. The delay is adjustable in increments of 1 second.

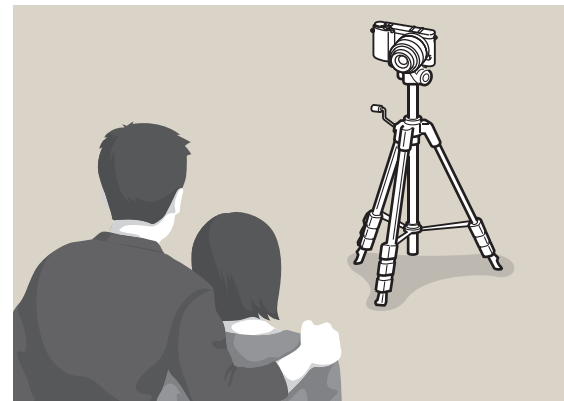

To set the delay, in Shooting mode, press [] → **Timer**, and then press [**DISP**].

Auto Exposure Bracketing (AE Bracket)

When you press [**Shutter**], the camera captures 3 consecutive photos: the original, one a step darker, and one a step lighter. Use a tripod to prevent blurry photos as the camera captures three photos continuously. You can adjust the settings in **Bracket Set** menu.



White Balance Bracketing (WB Bracket)

When you press [**Shutter**], the camera captures 3 consecutive photos: the original and two more with different White Balance settings. The original photo is captured when you press [**Shutter**]. The other two are automatically adjusted according to the White Balance you have set. You can adjust the settings in **Bracket Set** menu.



Picture Wizard Bracketing (P Wiz Bracket)

When you press [**Shutter**], the camera captures three consecutive photos, each with a different Picture Wizard setting. The camera captures a photo and applies the three Picture Wizard options you have set to the image captured. You can select three different settings in **Bracket Set** menu.



Bracketing setting

You can set up the options for AE Bracket, WB Bracket, and P Wiz Bracket.

To set a bracketing option,

In Shooting mode, press [**MENU**] → → **Bracket Set** → an option.

Option	Description
AE Bracket Set	Set the order and the area of bracket. <ul style="list-style-type: none"> • Bracket Order: Set the order in which the camera captures the original, lighter, and darker photo (represented by 0, +, and -). • Bracket Area: Set the exposure range of the 3 bracketed photos.
WB Bracket Set	Adjust the White Balance interval range of the 3 bracketed photos. For example, AB-/ +3 adjusts the Amber value plus or minus three steps. MG-/ +3 adjusts the Magenta value the same amount.
P Wiz Bracket Set	Select 3 Picture Wizard settings the camera uses to capture the 3 bracketed photos.

Flash

In order to capture a realistic photo of a subject, the amount of light should be constant. When the light source varies, you can use a flash and supply a constant amount of light. Select appropriate settings according to a light source and a subject.

To set flash options,

In Shooting mode, press **[Fn]** → **Flash** → an option.

Flash options

Icon	Description
	Off: Do not use the flash.
	Smart Flash: The camera automatically adjusts the brightness of the flash according to the amount of light in the surrounding environment.
	Auto: The flash automatically fires in dark places.
	Auto Red-eye: The flash automatically fires and prevents red-eyes.
	Fill in: The flash fires whenever you capture a photo.
	Fill-in Red: The flash fires whenever you capture a photo and prevents red-eyes.

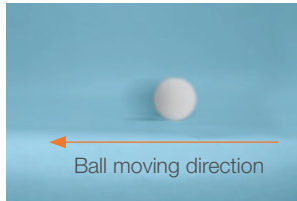
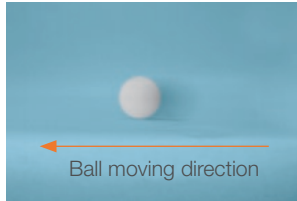
Icon	Description
	<p>1st Curtain: The flash fires immediately after the shutter opens. The camera captures a photo of a subject earlier in an action sequence clearly.</p> 
	<p>2nd Curtain: The flash fires just before the shutter closes. The camera captures a photo of a subject later in an action sequence clearly.</p> 



- The available options may differ depending on the shooting mode.
- There is an interval between two bursts of the flash. Do not move until the flash fires a second time.
- Flash options and the flash intensity adjustment are available only when you use the NX exclusive external flash.
- You can capture a photo with a flash that is not fully charged, but it is recommended to use a fully charged flash.



Use only Samsung-approved flashes. Using incompatible flashes may damage your camera.

Correcting the red-eye effect

If the flash fires when you capture a photo of a person in the dark, a red glow may appear in the eyes. To correct the red-eye effect, select **Auto Red-eye** or **Fill-in Red**.



Without red-eye correction



With red-eye correction



If the subject is too far from the camera or moves when the first flash fires, red-eyes may not be reduced.

Adjusting the flash intensity

Adjust the flash intensity to avoid overexposure or underexposure. You can adjust it ± 2 levels.

To set the flash intensity,

In Shooting mode, press **[Fn]** → **Flash** → an option → **[DISP]** → rotate the navigation button or press **[/AF]**.

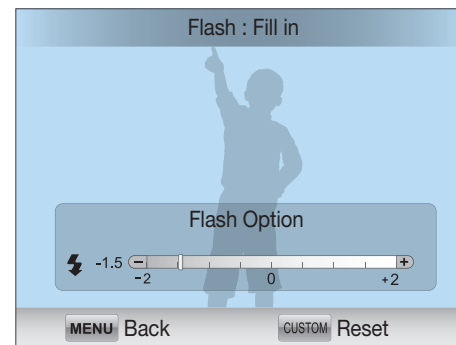



- Adjusting the flash intensity may not be effective when:
 - the subject is too close to the camera
 - you set a high ISO sensitivity
 - the exposure value is too big or too small
- In some shooting modes, you cannot use this function.
- If you attach an intensity-adjustable external flash to the camera, the intensity settings of the flash will be applied.
- If the subject is too close when you use the flash, some light may be blocked, resulting in a dark photo. Ensure that the subject is within the recommended range, which varies by lens.
- When a lens hood is attached, the light from the flash can be blocked by the hood. Remove the hood to use the flash.



Metering

The metering mode refers to the way in which a camera measures the quantity of light.

The camera measures the amount of light in a scene, and in many of its modes, uses the measurement to adjust various settings. For example, if a subject looks darker than its actual color, the camera captures an overexposed photo of it. If a subject looks lighter than its actual color, the camera captures an underexposed photo of it.

The brightness and overall mood of the photo can also be affected by how the camera measures the amount of light. Select an appropriate setting for a shooting condition.

To set a metering option,

In Shooting mode, press **[Fn]** → **Metering** → an option.

Multi

The Multi mode calculates the amount of light in multiple areas. When light is sufficient or insufficient, the camera adjusts the exposure by averaging the overall brightness of the scene. This mode is suitable for general photos.



Center-weighted

The Center-weighted mode calculates a broader area than the Spot mode does. It sums up the amount of light in the center portion of the shot (60 ~ 80 %) and that of the rest of the shot (20 ~ 40 %). It is recommended for situations where there is a slight difference in brightness between a subject and a background or an area of the subject is large compared to the overall composition of the photo.



Spot

The Spot mode calculates the amount of light in the center. When you capture a photo in conditions where there is a strong backlight behind a subject, the camera adjusts the exposure so as to shoot a subject correctly. For example, when you select the Multi mode in a strong backlight condition, the camera calculates that the overall amount of light is abundant, which results in a darker photo. The Spot mode can prevent this situation as it calculates the amount of light in a designated area.



The subject is in bright color while the background is dark. The Spot mode is recommended for a situation like this where a huge difference in the exposure exists between a subject and a background.

Measuring the exposure value of the focus area

When this function is turned on, the camera automatically sets an optimal exposure by calculating the brightness of the focus area. This function is only available when you select **Spot** metering or **Multi** metering, and **Selection AF**.

To set this function,

In Shooting mode, press [MENU] →  → Link AE to AF Point → an option.



Smart Range

This function automatically corrects the loss of bright detail that can occur due to shading differences in the photo.

To set Smart Range options,

In Shooting mode, press **[Fn]** → **Smart Range** → an option.

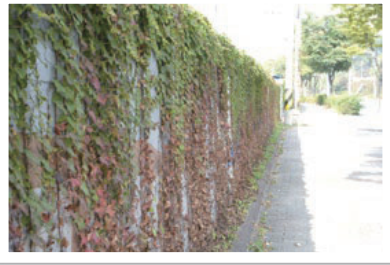

Without Smart Range effect

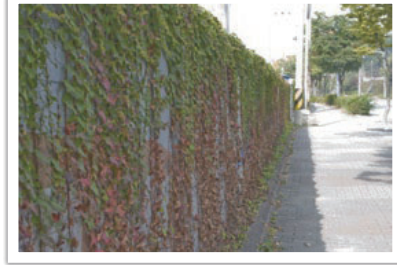

With Smart Range effect



Selective Color

This function lets you select a color that you want to emphasize, and desaturates the others. You can select red, green, blue, or yellow from the menu.

To set Selective Color options,

In Shooting mode, press **[Fn]** → **Selective Color** → an option.

Examples



Original



When red is selected



Color space

Digital imaging devices such as digital cameras, monitors, and printers have their own methods for representing colors, which are called color spaces.

Your camera lets you select two color spaces: **sRGB** or **Adobe RGB**.

sRGB is widely used for creating colors on PC monitors and is also the standard color space for Exif. sRGB is recommended for regular images and images you intend to publish on the Internet.

Adobe RGB is used for commercial printing and has a larger color range than sRGB. Its wider range of colors helps you to easily edit photos on a computer. Note that individual programs are generally compatible with a limited number of color spaces. If you open an image in a program that is not compatible with the image's color space, the colors will appear lighter.

To set the color space,

In Shooting mode, press **[MENU]** →  → **Color Space** → an option.

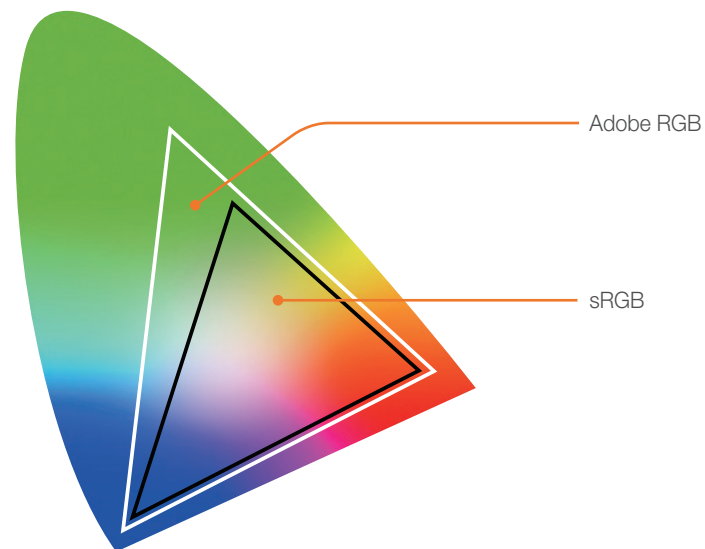

Exposure compensation/lock

Exposure compensation

The camera automatically sets the exposure by measuring the levels of light from the photo's composition and the position of a subject. If the exposure set by the camera is higher or lower than you expected, you can adjust the exposure value manually. The exposure value is adjustable in ± 3 increments. The camera displays the exposure warning in red for each step beyond ± 3 range.

To adjust the exposure value, press **[]**, and then rotate the navigation button. You can also adjust the exposure value by pressing **[Fn]**, and then selecting **EVC (Exposure Value Compensation)**.

You can check the exposure value by the position of the exposure level indicator.

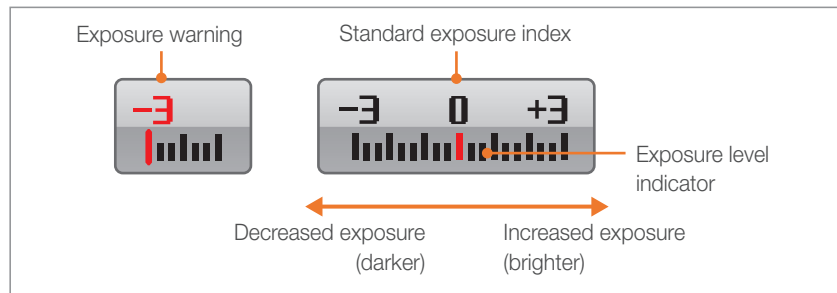

Exposure lock

When you cannot achieve an appropriate exposure because of a strong color contrast, lock the exposure and then capture a photo.

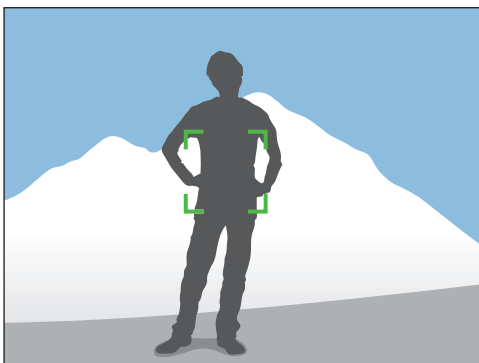

To lock the exposure, adjust the photo's composition on which you want to calculate the exposure, and then press the custom button. (p. 128)

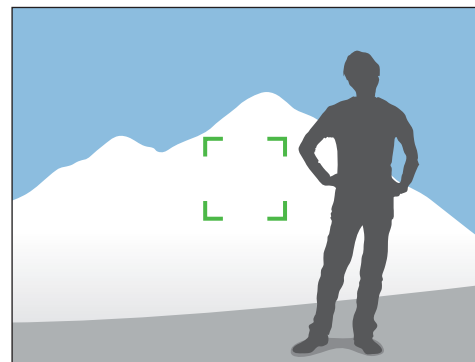

After locking the exposure, aim the lens where you desire, and press **[Shutter]**.

Video functions

The functions available for video are explained below.





Movie AE mode

Set the exposure mode for recording a video.

To set Movie AE options,

In Video Shooting mode, press [Fn] → **Movie AE Mode** → an option.

* Default







Icon	Description
	Program* : The aperture value and shutter speed are adjusted automatically.
	Aperture Priority : Set the aperture value manually before recording a video. Rotate the navigation button to adjust the aperture value.
	Shutter Priority : Set the shutter speed manually before recording a video. Rotate the navigation button to adjust the shutter speed.
	Manual : Set both the aperture value and shutter speed manually before recording a video. Press [M] [Z] to select an aperture value or shutter speed, and then rotate the navigation button to adjust the value.

Multi Motion

Set the playing speed of a video.

To set recording speed options,

In Video Shooting mode, press [MENU] →  → **Multi Motion** → an option.

Icon	Description
	x0.25 : Record a video and play it at 1/4 normal speed.
	x0.5 : Record a video and play it at 1/2 normal speed.
	x1 : Record a video and play it at normal speed.
	x5 : Record a video and play it at 5X normal speed.
	x10 : Record a video and play it at 10X normal speed.
	x20 : Record a video and play it at 20X normal speed.







- If you select an option other than **x1**, sound will not be recorded.
- The available options may differ according to the video size.

Fader

You can fade in or fade out a scene using the fader function on the camera without having to do it on a PC. Use the function appropriately and add dramatic effects on your videos.

To set fader options,

In Video Shooting mode, press **[Fn]** → **Fader** → an option.

Icon	Description
	Off: Fader function not used.
	In: Scene gradually fades in.
	Out: Scene gradually fades out.
	In-out: The fader function is applied at the start and end of the scene.

Voice

Sometimes, a muted video is more appealing than the one with sound. Turn the voice off to record a muted video.

To set voice options,

In Video Shooting mode, press **[Fn]** → **Voice** → an option.



Chapter 3

Playback/Editing

Learn about how to play back and edit photos and videos.
Refer to chapter 6 for editing files on a PC.

Searching and managing files

Learn how to search photos and videos quickly through the thumbnail view and to protect and delete files.

Viewing photos

1 Press [▶].

- The most recent file you captured will be displayed.

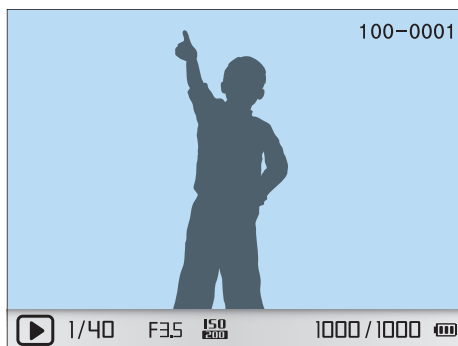

2 Rotate the navigation button or press [◂/AF] to scroll through files.



You may not be able to edit or play back files that were captured with other cameras, due to unsupported sizes or codecs. Use a computer or another device to edit or play back these files.

Viewing image thumbnails

In order to search for photos and videos you want, convert to the thumbnail view. The thumbnail view displays multiple images at a time so that you can easily look through items you wish to find. You can also classify and display files by their type, day recorded, and week recorded.

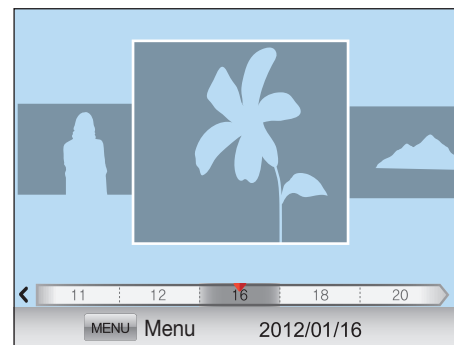

Press [📷] [🔍] to view files as thumbnails.

- Press once to view 3 thumbnails.
- Press twice to view 15 or 40 thumbnails.
(In the single view, press [MENU] → [▶] [🔍] → **Thumbnail Mode** to select the number of files to view. (p. 95))



Alternatively, in the single view, press [MENU] → [▶] [🔍] → **View** → an option.

Viewing files by category

- 1 In the thumbnail view, press **[MENU]**.
- 2 Select **Filter** → a category, and then press **[OK]**.

Option	Description
Type	View files by the file type such as photo or video.
Date*	View files by the date they were saved.
Week	View files by the day of the week they were saved.
Location	View file by the place they were saved. (Only the photos captured with a GPS module have the location information.)

* Default

Viewing files as a folder

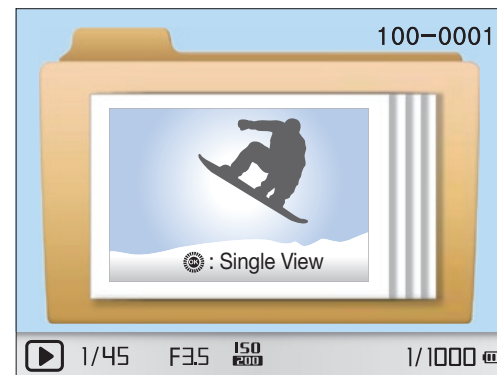

Continuous and burst shots appear as a folder. Deleting a folder will delete all photos in the folder.



If you press **[Z]** in the folder view, the files in the current folder will appear as thumbnail images.

Protecting files

Protect your files from accidental deletion.



- 1 In Playback mode, press **[MENU]** →   → **Protect** → an option. (**Single**, **Select**, **All**)
- 2 Rotate the navigation button or press /**AF** to select a file, and then press .
- 3 Press **[Fn]**.

Deleting files

Delete files in Playback mode and secure more space on your memory card. Protected files will not be deleted.

Deleting a single file

You can select a single file and delete it.

- 1 In Playback mode, select a file, and then press .
 - Alternatively, in Playback mode, press **[MENU]** →   → **Delete** → **Single**.
- 2 When the pop-up message appears, select **Yes**.

Deleting multiple files

You can select multiple files and delete them.

- 1 In Playback mode, press [🗑️] → **Multiple Delete**.
 - Alternatively, in Playback mode, press [MENU] → [▶] [1] → **Delete** → **Select**.
- 2 Select files you want to delete by rotating the navigation button or pressing [👁️/AF], and then press [OK].
 - Press [OK] again to cancel your selection.
- 3 Press [🗑️].
- 4 When the pop-up message appears, select **Yes**.

Deleting all files

You can delete all files on the memory card at once.

- 1 In Playback mode, press [MENU].
- 2 Select [▶] [1] → **Delete** → **All**.
- 3 When the pop-up message appears, select **Yes**.

Auto rotating

With Auto Rotate on, the camera automatically rotates photos you have captured vertically so they fit the screen horizontally.

To set auto rotate options,

In Playback mode, press **[MENU]** →  → **Auto Rotate** → an option.

Setting the thumbnail mode

You can select the number of files to view in the thumbnail mode.

To set thumbnail mode options,

In playback mode, press **[MENU]** →  → **Thumbnail Mode** → an option.



Playing videos

You can play a video, capture an image from a video, or crop a video and save it as a new file.



Video viewing controls

To	Do this
Rewind	Press [⏮]. Scan backward in 2X, 4X, and 8X increments each time you press [⏮].
Pause/Play	Press [⏸].
Fast forward	Press [⏭]. Scan forward in 2X, 4X, and 8X increments each time you press [⏭].
Volume control	Rotate the navigation button to the left or right.
Stop	Press [DISP].

Trimming a video during playback

- 1 Press [OK] at the point where you want the new video to begin.
- 2 When paused, press [⏸].
- 3 Press [OK] at the point where you want the new video to end.
- 4 When paused, press [⏸].
- 5 When the pop-up message appears, select Yes.



The cut file is saved as a separate file under a new name.

Capturing an image during playback

- 1 Press [OK] at the point where you want to save a still image.
- 2 Press [⏏].



- The resolution of the captured image is the same as the video resolution.
- The captured file is saved as a separate file under a new name.







Editing photos

Perform photo editing tasks, such as resizing, rotating, or eliminating red-eye effects. Edited photos are saved as new files under different file names. 3D photos, panoramic photos, and 3D panoramic photos cannot be edited with the Image Edit function.









To set Image Edit options,

In Playback mode, press **[Fn]** → an option.









Options

Icon	Description
	<p>Smart Filter: Apply various filter effects to photos and create unique images. (Off*, Miniature, Soft Focus, Old Film 1, Old Film 2, Halftone Dots, Sketch, Fish Eye, Defog, Negative)</p> <p> The new file may be smaller than the original.</p>
	<p>Red-eye Fix: Remove red-eyes on a photo. (Off*, On)</p> <p> The new file may be smaller than the original.</p>

* Default

Icon	Description
	<p>Backlight: Correct the brightness of an underexposed photo. (Off*, On)</p> <div style="display: flex; justify-content: space-around;">   </div> <p style="text-align: center;">Before correction After correction</p> <p> The new file may be smaller than the original.</p>
	<p>Resize: Resize the size of a photo.</p> <p> The available resolutions may differ depending on the size of the selected photo.</p>
	<p>Rotate: Rotate a photo. (Off*, Right 90°, Left 90°, 180°, Horizontal, Vertical)</p> <p> You cannot rotate protected files or RAW files.</p>

* Default

Icon	Description
	<p>Face Retouch: Hide facial imperfections.</p> <div data-bbox="241 344 942 433">  <p>The new file may be smaller than the original.</p> </div>
	<p>Brightness: Adjust the brightness of a photo.</p> <div data-bbox="241 504 942 594">  <p>The new file may be smaller than the original.</p> </div>
	<p>Contrast: Adjust the sharpness of a photo.</p> <div data-bbox="241 664 942 753">  <p>The new file may be smaller than the original.</p> </div>
	<p>Vignetting: Apply the retro-looking colors, high contrast, and strong vignette effect of Lomo cameras.</p> <div data-bbox="241 842 942 931">  <p>The new file may be smaller than the original.</p> </div>





Chapter 4





Wireless network

Learn how to connect to wireless local area networks (WLANs) and use functions.





Connecting to a WLAN and configuring network settings

Learn to connect via an access point (AP) when you are in a range of a WLAN. You can also configure network settings.

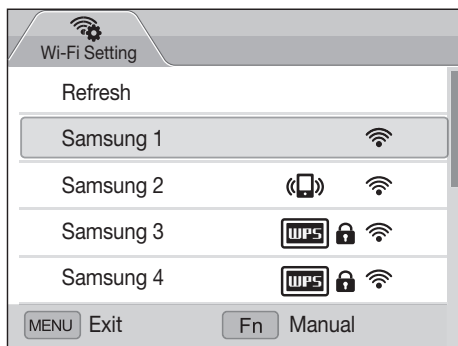
Connecting to a WLAN

- 1 Rotate the mode dial to **Wi-Fi**.
- 2 Select , , , or .
- 3 Press **[MENU]**, and then select **Wi-Fi Setting**.
 - In some modes, press **[MENU]** or follow the on-screen instructions until the Wi-Fi Setting screen appears.
 - The camera automatically searches for available AP devices.
- 4 Select an AP.



Icon/Option	Description
Refresh	Refresh connectable APs.
	Ad hoc AP
	Secured AP
	WPS AP
	Signal strength
WPS button connection	Connect to a WPS AP.
Add wireless network	Add an AP manually.

- Press **[Fn]** to open network setting options.
- When you select a secured AP, a pop-up window appears. Enter the required passwords to connect to the WLAN. For information about entering text, refer to "Entering text". (p. 105)
- When a login page appears, refer to "Using the login browser". (p. 103)
- When you select an unsecured AP, the camera will connect to the WLAN.
- If you select a WPS profile supported AP, select **WPS PIN connection**, and then enter a PIN on the AP device. You can also connect to a WPS profile supported AP by selecting **WPS button connection** on the camera, and then pushing the **WPS** button on the AP device.

Setting network options

- 1 In the Wi-Fi Setting screen, move to an AP, and then press **[Fn]**.
- 2 Select each option and enter the required information.

Option	Description
Authentication	Select a network authentication type.
Data Encryption	Select an encryption type.
Network Key	Enter the network password.
IP Setting	Set the IP address manually.



Manually setting the IP address

- 1 In the Wi-Fi Setting screen, move to an AP, and then press **[Fn]**.
- 2 Select **IP Setting** → **Manual**.
- 3 Select each option, and then enter the required information.

Option	Description
IP	Enter the static IP address.
Subnet Mask	Enter the subnet mask.
Gateway	Enter the gateway.
DNS Server	Enter the DNS address.

Using the login browser

You can enter your login information via the login browser when connecting to some APs, sharing sites, or cloud servers.

Button	Description
[DISP/  /  / AF]	Move to an item or scroll the page.
[OK]	Select an item.
[MENU]	Access the following options: <ul style="list-style-type: none"> • Previous Page: Move to the previous page. • Next Page: Move to the next page. • Reload: Reload the page. • Stop: Stop loading the page. • Exit: Close the login browser.
[]	Close the login browser.



- You cannot select some items depending on the page you connected to. This does not indicate a malfunction.
- The login browser may not close automatically after you log into some pages. If this occurs, close the login browser by pressing [], and then proceed with the desired operation.
- It may take longer to load the login page due to the page size or network speed. If this occurs, wait until the login information input window appears.







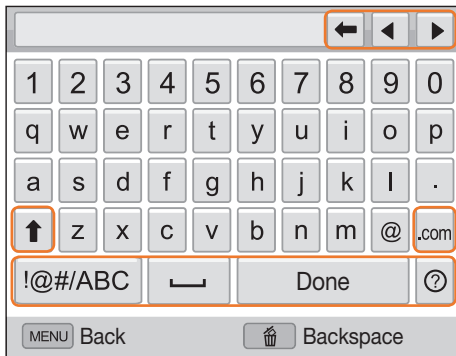

Network connection tips

- You must insert a memory card to use the Wi-Fi features.
- The quality of the network connection will be determined by the AP.
- The further the distance between your camera and the AP, the longer it will take to connect to the network.
- If a nearby device is using the same radio frequency signal as your camera, it may interrupt your connection.
- If your AP name is not in English, the camera may not be able to locate the device or the name may appear incorrectly.
- For network settings or a password, contact your network administrator or network service provider.
- If a WLAN requires authentication from the service provider, you may not be able to connect to it. To connect the WLAN, contact your network service provider.
- Depending on the encryption type, the number of digits in the password may differ.
- A WLAN connection may not be possible in all surroundings.
- The camera may display a WLAN enabled printer on the AP List. You cannot connect to the network via a printer.
- You cannot connect your camera to a network and a TV simultaneously. Also, you cannot view photos or videos on a TV while connected to a network.
- Connecting to a network may incur additional charges. Costs will vary based on the conditions of your contract.
- If you cannot connect to a WLAN, try another AP from the available AP list.
- You can also connect to free WLANs in some foreign countries.
- A login page may appear when you select free WLANs provided by some network service providers. Enter your ID and password to connect to the WLAN. For information about registering or the service, contact the network service providers.
- Be cautious when you enter personal information for an AP connection. Do not enter any payment or credit card information on your camera. The manufacturer is not liable for any problem caused by entering such information.
- Available network connections may differ by country.
- The WLAN feature of your camera must comply with radio transmission laws in your region. To ensure compliance, use the WLAN feature only in the country where you purchased the camera.
- The process for adjusting network settings may differ, depending on network conditions.
- Do not access a network that you are not authorized to use.
- Before you connect to a network, ensure your battery is fully charged.
- When a DHCP server is not available you must make an autoip.txt file and copy it to the inserted memory card to connect to the network using Auto IP.

Entering text

Learn how to enter text. The icons in the table below let you move the cursor, change the case, etc. Use the navigation button to scroll to a desired key, and then press  to enter the key.



Icon	Description
	Delete the last letter.
	Move the cursor.
	In ABC mode, change the case.
.COM	Enter ".com".
!@#/ABC	Switch between Symbol mode and ABC mode.
	Enter a space.
Done	Save the displayed text.
	View the entering text guide.



- You can enter only English alphabets, regardless of the display language.
- To move to **Done** directly, press .
- You can enter up to 64 characters.

Saving files to a smart phone automatically

The camera connects to a smart phone that supports the AutoShare feature via a WLAN. When you capture a photo with your camera, the photo is saved to the smart phone automatically.



- The AutoShare feature is supported by Galaxy series smart phones or Galaxy Tab models with the Android 2.2 OS or higher or iOS devices with the iOS 4.3 or higher. Before using this feature, check the device's firmware and update it if needed.
- You should install Samsung SMART CAMERA App on your phone or device before using this feature. You can download the application from Samsung Apps, the Google Play Store, or the Apple App Store.

1 On the camera, rotate the mode dial to **Wi-Fi**.

2 On the camera, select .

- If the pop-up message that prompts you to download the application appears, select **Next**.

3 On the smart phone, turn on Samsung SMART CAMERA App.

- For iOS devices, turn on the Wi-Fi feature before turning on the application.

4 Select the camera from the list and connect the smart phone to the camera.

- The smart phone can connect to only one camera at a time.

5 On the camera, allow the smart phone to connect to your camera.

- If the smart phone has been connected to your camera before, it is connected automatically.
- An icon that shows the connection status () will appear on the camera's screen.

6 On the camera, capture a photo.

- The captured photo is saved to the camera, and then transferred to the smart phone.
- You cannot record a video while the AutoShare feature is turned on.

Sending photos or videos to a smart phone

The camera connects to a smart phone that supports the MobileLink feature via a WLAN. You can easily send photos or videos to your smart phone.



- The MobileLink feature is supported by Galaxy series smart phones or Galaxy Tab models with the Android 2.2 OS or higher or iOS devices with the iOS 4.3 or higher. Before using this feature, check the device's firmware and update it if needed.
- You should install Samsung SMART CAMERA App on your phone or device before using this feature. You can download the application from Samsung Apps, the Google Play Store, or the Apple App Store.
- When there are no files in the camera memory, you cannot use this feature.
- If you select files from the smart phone, you can view up to 1,000 recent files and send up to 150 files at a time. If you select files from the camera, you can view files that were selected from the camera. The maximum number of files that can be sent varies depending on the storage space of the smart phone.
- You cannot send RAW files.

- 1 On the camera, rotate the mode dial to **Wi-Fi**.
- 2 On the camera, select .
 - If the pop-up message that prompts you to download the application appears, select **Next**.
- 3 On the camera, select a sending option.
 - If you select **Select Files from Smartphone**, you can use your smart phone to view and share files stored on the camera.
 - If you select **Select Files from Camera**, you can select files to send from the camera.
- 4 On the smart phone, turn on Samsung SMART CAMERA App.
 - For iOS devices, turn on the Wi-Fi feature before turning on the application.

- 5 Select the camera from the list and connect the smart phone to the camera.
 - The smart phone can connect to only one camera at a time.
- 6 On the camera, allow the smart phone to connect to your camera.
 - If the smart phone has been connected to your camera before, it is connected automatically.
- 7 On the smart phone or camera, select files to transfer from the camera.
- 8 On the smart phone, touch the copy button or on the camera, select **Share**.
 - The camera will send the files.



Using a smart phone as a remote shutter release

The camera connects to a smart phone via a WLAN. Use the smart phone as a remote shutter release with the Remote Viewfinder feature. The captured photo will display on the smart phone.



- The Remote Viewfinder feature is supported by Galaxy series smart phones or Galaxy Tab models with the Android 2.2 OS or higher or iOS devices with the iOS 4.3 or higher. Before using this feature, check the device's firmware and update it if needed.
- You should install Samsung SMART CAMERA App on your phone or device before using this feature. You can download the application from Samsung Apps, the Google Play Store, or the Apple App Store.

1 On the camera, rotate the mode dial to **Wi-Fi**.

2 On the camera, select .

- If the pop-up message that prompts you to download the application appears, select **Yes**.

3 On the smart phone, turn on Samsung SMART CAMERA App.

- For iOS devices, turn on the Wi-Fi feature before turning on the application.





4 Select the camera from the list and connect the smart phone to the camera.



- The smart phone can connect to only one camera at a time.

5 On the camera, allow the smart phone to connect to your camera.

- If the smart phone has been connected to your camera before, it is connected automatically.

6 On the smart phone, set the following shooting options.



Icon	Description
	Flash option
	Timer option
	Photo size
	Saving location

- While using this feature, some buttons are not available on your camera.
- The zoom button and the shutter button on your smart phone will not function when using this feature.
- Remote Viewfinder mode supports the  and  photo sizes only.

7 On the smart phone, touch and hold to focus.

- The focus is automatically set to multi-AF.

8 Release to capture the photo.

- Photos saved to the smart phone will be resized to 640X424 when shooting in  and to 640X360 when shooting in  resolution.



- When you use this feature, the ideal distance between the camera and the smart phone may vary, depending on your surroundings.
- The smart phone must be within 7 m of the camera to use this feature.
- It will take some time to capture the photo after you release  on the smart phone.
- The Remote Viewfinder function will deactivate when:
 - there is an incoming call on the smart phone
 - either of the camera or the smart phone turn off
 - the memory is full
 - either device loses connection to the WLAN
 - the Wi-Fi connection is poor or unstable

Using photo or video sharing websites

Upload your photos or videos to file sharing websites. Available websites will be displayed on your camera. To upload files to some websites, you must visit the website and register before connecting your camera.

Accessing a website

1 Rotate the mode dial to **Wi-Fi**.

2 Select .

3 Select a website.

- If the pop-up message that prompts you to create an account appears, select **OK**.
- The camera will automatically attempt to connect to a WLAN via the most recently connected AP device.
- If the camera has not previously been connected to a WLAN, it will search for available AP devices. (p. 101)

4 Enter your ID and password, and then select **Login**.

- For information about entering text, refer to "Entering text". (p. 105)
- If you connected to SkyDrive, refer to "Using the login browser". (p. 103)
- To select an ID from the list, select ▼ → an ID.
- If you have previously logged in to the website, you may be logged in automatically.



You must have an existing account on the file sharing website to use this feature.

Uploading photos or videos

1 Access the website with your camera.



2 Scroll to the files you want to upload, and then press .

- You can select up to 20 files. The total size must be 10 MB or less. (On some websites, the total size or number of files may vary.)

3 Select **Upload**.

- If you connected to Facebook, select **Upload** → **Upload**.
- If you connected to Facebook, you can enter your comments by selecting the **Comment** box. For information about entering text, refer to "Entering text". (p. 105)



- You cannot upload RAW files.
- You can upload up to 20 files at a time.
- You cannot upload files if the file size exceeds the limit. The maximum photo resolution you can upload is 2M, and the longest video you can upload is a video recorded using . If the selected photo resolution is higher than 2M, it will be automatically resized to a lower resolution. If you connected to Facebook, the photo resolution will be resized to 1M resolution.
- The method of uploading photos or videos may differ depending on the selected website.
- If you cannot access a website because of firewall or user authentication settings, contact your network administrator or network service provider.
- Uploaded photos or videos may be automatically titled with the date they were captured.
- The speed of your internet connection may affect how quickly photos upload or web pages open.
- When there are no files in the camera memory, you cannot use this feature.
- You can also upload photos or videos to file sharing websites in Playback mode by pressing **[MENU]**, and then selecting  → **Share(Wi-Fi)** → a desired website.
- When you upload photos to SkyDrive, they will be resized to 2M while maintaining their aspect ratios.



Sending photos or videos via email

You can change settings in the email menu, and send photos or videos stored on the camera via email.

Changing email settings

In the email menu, you can change settings for storing your information. You can also set or change the email password. For information about entering text, refer to "Entering text". (p. 105)

Storing your information





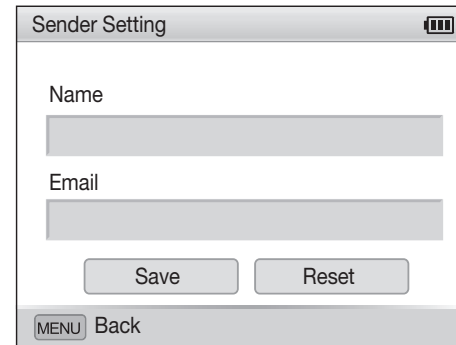

- 1 Rotate the mode dial to **Wi-Fi**.
- 2 Select .
- 3 Press **[MENU]**.
- 4 Select  → **Sender Setting**.

- 5 Select the **Name** box, enter your name, and then select **Done**.



- 6 Select the **Email** box, enter your email address, and then select **Done**.
- 7 Select **Save** to save your changes.
 - To delete your information, select **Reset**.





Setting an email password

- 1 Rotate the mode dial to **Wi-Fi**.
- 2 Select .
- 3 Press [**MENU**].
- 4 Select  → **Setting Password** → **On**.
 - To deactivate the password, select **Off**.
- 5 When the pop-up appears, press [].
 - The pop-up disappears automatically even if you do not press [].
- 6 Enter a 4-digit password.
- 7 Enter the password again.
- 8 When the pop-up appears, press [].
 - The pop-up disappears automatically even if you do not press [].



If you lost your password, you can reset it by selecting **Reset** on the password setting screen. When you reset the information, previously saved user's setting information, email address, and recently sent email list will be deleted.

Changing the email password

- 1 Rotate the mode dial to **Wi-Fi**.
- 2 Select .
- 3 Press [**MENU**].
- 4 Select  → **Change Password**.
- 5 Enter your current 4-digit password.
- 6 Enter a new 4-digit password.
- 7 Enter the new password again.
- 8 When the pop-up appears, press [].
 - The pop-up disappears automatically even if you do not press [].

Sending photos or videos via email

You can send photos or videos stored on the camera via email.
For information about entering text, refer to "Entering text". (p. 105)

- 1 Rotate the mode dial to **Wi-Fi**.
- 2 Select .
- 3 Select the **Sender** box, enter your email address, and then select **Done**.
 - If you have previously saved your information, it will be inserted automatically. (p. 113)
 - To use an address from the list of previous recipients, select ▼ → an address.
- 4 Select the **Receiver** box, enter an email address, and then select **Done**.
 - To use an address from the list of previous recipients, select ▼ → an address.
 - Select **+** to add additional recipients. You can input up to 30 recipients.
 - Select **X** to delete an address from the list.
- 5 Select **Next**.

- 6 Scroll to files to send, and then press [**OK**].
 - You can select up to 20 files. The total size must be 7 MB or less.
- 7 Select **Send**.
- 8 Select the **Comment** box, enter your comments, and then select **Done**.
- 9 Select **Send**.
 - The camera will automatically attempt to connect to a WLAN via the most recently connected AP device and send the email.
 - If the camera has not previously been connected to a WLAN, it will search for available AP devices. (p. 101)



- You cannot send RAW files.
- You can send up to 20 files at a time.
- Even if a photo appears to have transferred successfully, errors with the recipient's email account may cause the photo to be rejected or recognized as spam.
- You may not be able to send an email if no network connection is available or if your email account settings are incorrect.
- You cannot send an email if the file size exceeds the limit. The maximum photo resolution you can send is 2M and the longest video you can send is a video recorded using **240**
MP. If the selected photo resolution is higher than 2M, it will be automatically resized to a lower resolution.
- If you cannot send an email because of firewall or user authentication settings, contact your network administrator or network service provider.
- When there are no files in the camera memory, you cannot use this feature.
- You can also send an email in Playback mode by pressing **[MENU]**, and then selecting **[▶] [1] → Share(Wi-Fi) → Email**.



Using Auto Backup to send photos or videos

You can send photos or videos that you captured with the camera to a PC wirelessly. The Auto Backup feature works only with the Windows OS.



Installing the program for Auto Backup on your PC

- 1 Install Intelli-studio on the PC. (p. 142)
- 2 Connect the camera to the PC with the USB cable.
- 3 Click **OK** on the pop-up window.
 - The Auto Backup program is installed on the PC. Follow the on-screen instructions to complete the installation.
- 4 Remove the USB cable.
- 5 Connect the camera to the PC again with the USB cable.
 - The camera stores information about the PC, so that the camera can send files to the PC.



Before installing program, ensure that the PC is connected to a network. If no internet connection is available, you must install the program from the provided CD.

Sending photos or videos to a PC

- 1 Rotate the mode dial to **Wi-Fi**.
- 2 Select .
 - You must configure the backup PC information to use the Auto Backup feature. For more details, refer to “Installing the program for Auto Backup on your PC”. (p. 117)
- 3 Press [**MENU**] to set options.
 - To turn off your PC automatically after the transfer is complete, select  → **Shut down PC after backup** → **On**.
 - To view the help for the Auto Backup function, select  → **Guide**.
- 4 Press [**OK**] to start the backup.
 - To cancel sending, press [**OK**].
 - You cannot select individual files to backup. This function backs up only new files on the camera.
 - The backup's progress will be shown on the PC monitor.
 - When the transfer is completed, the camera will turn off automatically in approximately 30 seconds. Select **Cancel** to return to the previous screen and prevent the camera from turning off automatically.



- If the PC supports the Wake on LAN (WOL) feature, you can turn on the PC automatically by searching for the PC from your camera. (p. 122)
- When you connect the camera to the WLAN, select the AP that is connected to the PC.
- The camera will search for available access points even if you are connecting to the same access point again.
- If you turn off the camera or remove the battery while sending files, the file transfer will be interrupted.
- While you are using this feature, only **[Power]** is available on your camera.
- You can connect only one camera to the PC at a time for sending files.
- The backup may be canceled due to network conditions.
- Photos or videos can be sent to a PC one time only. Files cannot be sent again even if you reconnect your camera to another PC.
- When there are no files in the camera memory, you cannot use this feature.
- You must turn off Windows Firewall and any other firewalls before using this feature.
- You can send up to 1,000 files.
- On the PC software, the server name must be entered in the Latin alphabet and can contain no more than 48 characters.



Viewing photos or videos on a TV Link-enabled TV

TV Link is a technology for sharing media files between a camera and TV connected to the same AP device. With this technology, you can view your photos or videos on a widescreen TV.

1 Rotate the mode dial to **Wi-Fi**.



2 Select .

- If the guide message appears, press [OK].
- The camera will automatically attempt to connect to a WLAN via the most recently connected AP device.
- If the camera has not previously been connected to a WLAN, it will search for available AP devices. (p. 101)

3 Connect your TV to a wireless network via an AP device.

- Refer to your TV's user manual for more information.

4 On the TV, search for the camera and browse the shared photos or videos.

- For information about searching for the camera and browsing the photos or videos on the TV, refer to the TV's user manual.
- Videos may not play smoothly depending on the type of TV or network condition. If this happens, re-record the video in  or  quality and play it again. If videos do not play smoothly on your TV over the wireless connection, try connecting the camera to the TV with the HDMI cable.

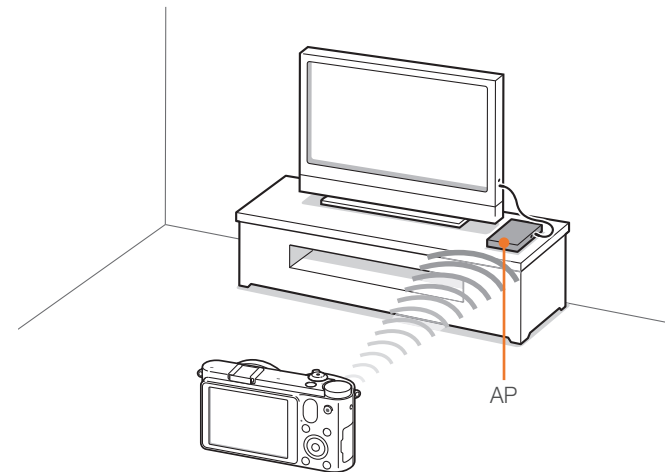





- You cannot share RAW files.
- You can share up to 1,000 photos or videos.
- On a TV screen, you can view only photos or videos captured with your camera.
- The range of the wireless connection between your camera and a TV may vary depending on the specifications of the AP.
- If the camera is connected to 2 TVs, playback may be slower.
- You can use this feature only with TV Link-enabled TVs.
- Photos or videos will be shared in their original sizes.
- Some videos may buffer more slowly than others.
- Shared photos or videos will not be stored on the TV, but they can be stored in the camera to meet the TV's specifications.
- Transferring photos or videos to the TV may take some time depending on the network connection, the number of files to be shared, or sizes of the files.
- If you power off the camera abnormally while viewing photos or videos on a TV (for example, by removing the battery), the TV considers the camera to still be connected.
- The order of photos or videos on the camera may be different than on the TV.
- Depending on the number of photos or videos you want to share, it may take some time to load your photos or videos and complete the initial set-up process.
- While viewing photos or videos on the TV, continuously using the TV remote or performing additional operations on the TV may prevent this feature from working properly.
- If you reorder or sort files on the camera while viewing them on a TV, you must repeat the initial set-up process to update the list of files on the TV.
- When there are no files in the camera memory, you cannot use this feature.
- We recommend you use a network cable to connect your TV to your AP. This will minimize any video 'Stuttering' you may experience when streaming content.



Sending photos using Wi-Fi Direct

When the camera connects via a WLAN to a device that supports the Wi-Fi Direct function, you can send photos to the device. This feature may not be supported on some devices.

- 1 On the device, turn on the Wi-Fi Direct option.
- 2 On the camera, in Playback mode, scroll to a photo.
- 3 Press **[MENU]**, and then select   → **Share(Wi-Fi)** → **Wi-Fi Direct**.
 - When in the single image view, you can send only one photo at a time.
 - When in the thumbnails view, you can select multiple photos by scrolling to thumbnails, and then pressing . Select **Send** when you are finished selecting photos.

- 4 Select the device from the camera's list of Wi-Fi Direct devices.

- Ensure that the device's Wi-Fi Direct option is turned on.
- You can also select your camera from the device's list of Wi-Fi Direct devices.

- 5 On the device, allow the camera to connect to the device.

- The photo will be sent to the device.



- You can send up to 20 files at a time.
- When there are no photos in the camera memory, you cannot use this feature.
- If you cancel the connection attempt before it is complete, the camera may not be able to reconnect to the device. In this case, update your device with the latest firmware.

About the Wake on LAN (WOL) feature

With the WOL feature, you can automatically turn on or wake up a PC with your camera. This feature has been available for Samsung desktop PCs for the last 5 years (not available for all-in-one PCs).



Any changes to your PC's BIOS settings other than the ones described below may damage your PC. The manufacturer is not responsible for damage caused by your changing your PC's BIOS settings.

Setting the PC to wake up from sleep mode

- 1 Click **Start**, and then open the **Control Panel**.
- 2 Configure the network connection.
 - Windows 7:
Click **Network and Internet** → **Network and Sharing Center** → **Change adapter settings**.
 - Windows Vista:
Click **Network and Internet** → **Network and Sharing Center** → **Manage network connections**.
 - Windows XP:
Click **Network and Internet Connection** → **Network Connection**.
- 3 Right click **Local Area**, and then click **Properties**.
- 4 Click **Configure** → the **Power manage** tab → **Allow this device to wake the computer**.
- 5 Click **OK**.
- 6 Restart the PC.

Setting the PC to turn on

- 1 Turn on the PC, and then press F2 while the PC is booting.
 - The BIOS setting menu will appear.
- 2 Select **Advanced** tab → **Power management Setup**.
- 3 Select **Resume on PME** → **Enabled**.
- 4 Press F10 to save your changes, and then continue booting.
- 5 Click **Start**, and then open the **Control Panel**.
- 6 Configure the network connection.
 - Windows 7:
Click **Network and Internet** → **Network and Sharing Center** → **Change adapter settings**.
 - Windows Vista:
Click **Network and Internet** → **Network and Sharing Center** → **Manage network connections**.
 - Windows XP:
Click **Network and Internet Connection** → **Network Connection**.

- 7 Select drivers related to network adapter.

- 8 Click **Advanced** tab, and then set WOL menus.



- You cannot use this feature across a firewall or if a security program has been installed.
- To turn on the PC with the WOL feature, the PC must have an active connection to the LAN. Ensure that the indicator light on the PC's LAN port is on indicating that the LAN connection is active.
- Depending on your PC model, the camera may only be able to wake the PC.
- Depending on your PC's OS or drivers, the names of the WOL setting menu may vary.
 - examples of setting menu names: Enable PME, Wake on LAN, etc.
 - examples of setting menu values: Enable, Magic packet, etc.



Chapter 5

Camera settings menu

Learn about the user settings and general settings menu. You can adjust the settings to better suit your needs and preferences.

User settings

You can set the user environment with these settings.

To set user options,

In Shooting mode, press **[MENU]** →  or  → an option.



Available items and the order of them may differ depending on the shooting mode.

ISO Customizing

ISO Step

You can set the size for the ISO sensitivity by either 1/3 or 1 step.

Auto ISO Range

You can set the maximum ISO value under which each EV step is chosen when you set the ISO Auto.

* Default

Option	Value
1 Step	ISO 200, ISO 400, ISO 800*, ISO 1600, ISO 3200
1/3 Step	ISO 125, ISO 160, ISO 200, ISO 250, ISO 320, ISO 400, ISO 500, ISO 640, ISO 800*, ISO 1000, ISO 1250, ISO 1600, ISO 2000, ISO 2500, ISO 3200

Noise Reduction

Use the Noise Reduction to reduce the visual noise in photos.

* Default

Option	Description
High ISO NR	This function reduces noise that may occur when you set a high ISO sensitivity. (Off , On*)
Long Term NR	This function reduces noise when you set the camera for a long exposure. (Off , On*)

DMF (Direct Manual Focus)

You can adjust the focus manually by rotating the focus ring after achieving the focus by half-pressing **[Shutter]**. This feature may not be available with some lenses.

AF Priority

You can set the camera to capture photos only when the subject is in focus.



When you capture continuous or burst shots, the camera will capture photos even if the AF priority function is turned on and the subject is not in focus.

Distortion Correct

You can correct lens distortion that might occur from lenses. This feature may not be available with some lenses.

iFn Customizing

You can select options that can be adjusted when you press **[i-Function]** on an i-Function lens.



Option	Description
Aperture	Set to adjust the aperture value.
Shutter Speed	Set to adjust the shutter speed.
EV	Set to adjust the exposure value.
ISO	Set to adjust ISO sensitivity.
WB	Set to adjust the white balance.
 zoom	Set to adjust the zoom ratio.

User Display

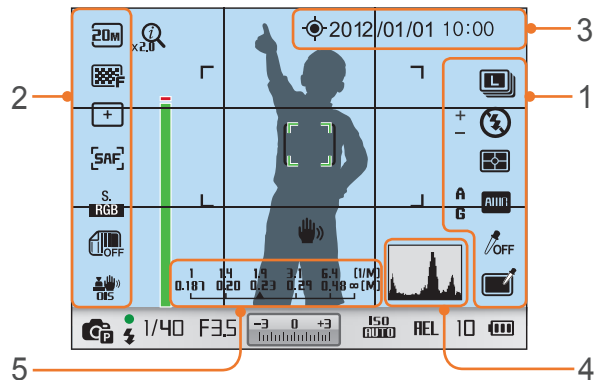
You can add or remove shooting information from the display.

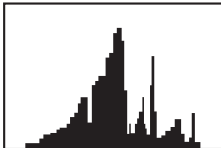
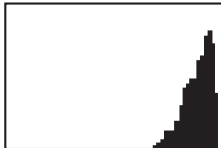

No.	Description
1	Right Icons Set to display icons on the right in Shooting mode.
2	Left Icons Set to display icons on the left in Shooting mode.
3	Date & Time Set to display the date and time.

No.	Description
4	<p>Histogram Set the histogram on the display on or off.</p> <p>About histogram A histogram is a graph that shows the brightness distribution of a photo. A histogram inclined to the left indicates a dark photo. A histogram inclined to the right indicates a bright photo. The height of the graph is related to color information. The graph gets higher if a specific color is more common.</p> <div style="display: flex; justify-content: space-around; align-items: center;">    </div> <p style="text-align: center; margin-top: 5px;"> Insufficient exposure Balanced exposure Excessive exposure </p>
5	<p>Distance Scale Set to display the distance between a subject and the camera when you attach a lens that supports the Distance Scale function. (Off, ft, m*)</p> <div style="border: 1px solid #ccc; padding: 5px; margin-top: 10px;">  This feature is available only when you attach a lens that supports the Distance Scale function. </div>

Key Mapping

You can change the function assigned to the Custom button or SMART LINK button.

* Default

Button	Function
Custom	Set a function of the Custom button. <ul style="list-style-type: none"> • Optical Preview*, which executes the Depth of Field Preview function for the current aperture value. (p. 22) • One Touch WB (White Balance), which executes the Custom White Balance function. • One Touch RAW +, which activates or deactivates the RAW+JPEG feature. • Reset, which resets some settings. • AEL, which executes the auto exposure lock function.
SMART LINK	Set a function of the SMART LINK button. (AutoShare*, MobileLink, Remote Viewfinder, SNS & Cloud, Email, Auto Backup, TV Link)

Grid Line

Select a guide to help you compose a scene.
(Off*, 3 X 3, 2 X 2, Cross, Diagonal)

AF Lamp

When shooting in dark places, turn the AF lamp on in order to have a better auto focus. The Auto Focus functions more accurately in dark places when the AF lamp is on.

Setting 1

Learn about the menu items of the Setting 1.

To set Setting 1 options,

In Shooting or Playback mode, press [MENU] →  → an option.

Item	Description
Language	Set a language the camera shows on the display.
File Name	<p>Set the method of creating file names.</p> <ul style="list-style-type: none"> • Standard*: SAM_XXXX.JPG (sRGB)/_SAMXXXX.JPG (Adobe RGB) • Date: <ul style="list-style-type: none"> - sRGB files - MMDDxxxx.JPG. For example, for a photo captured on Jan. 01, the file name would be 0101xxxx.jpg. - Adobe RGB files - _MDDxxxx.JPG for the months Jan through Sept. For the months Oct through Dec, the month number is replaced by the letters A (Oct.), B (Nov.) and C (Dec.). For example, for a photo captured on Feb. 03, the file name would be _203xxxx.jpg. For a photo captured on Oct. 05, the file name would be _A05xxxx.jpg.

* Default

Item	Description
File Number	<p>Set the method of numbering files and folders.</p> <ul style="list-style-type: none"> • Reset: After using the reset function, the next file name is started at 0001. • Series*: New file numbers continue the existing number sequence, even if you have installed a new memory card, formatted the card, or deleted all photos. <div style="border: 1px solid #ccc; padding: 10px; margin-top: 10px;">  <ul style="list-style-type: none"> • The first folder name is 100PHOTO, if you have selected the sRGB color space and Standard file naming, the first file name is SAM_0001. • File name numbers are increased by 1 from SAM_0001 to SAM_9999. • Folder numbers are increased by 1 from 100PHOTO to 999PHOTO. • The maximum number of files that can be saved in one folder is 9,999. • File numbers are assigned according to DCF (Design rule for Camera File system) specifications. • If you change a file name (for example, on a computer), the camera will not be able to play the file. </div>

* Default

Item	Description
Folder Type	Set the type of folder. <ul style="list-style-type: none">• Standard*: XXXPHOTO• Date: XXX_MMDD
Format	Format the memory card. Formatting prepares a memory card for use in the camera and deletes all existing files including protected files. (Yes, No)  Errors can occur if you use a memory card formatted by another brand of camera, a memory card reader, or a computer. Please format memory cards in the camera before using them to capture photos.
Reset	Reset the setup menu and shooting options to the factory defaults. (Date, time, language, and video output settings do not change.) (Yes, No)





Setting 2

Learn about the menu items of the Setting 2.







To set Setting 2 options,

In Shooting or Playback mode, press [MENU] →  → an option.

Item	Description
Quick View	Set the Quick View time length – the amount of time the camera displays a photo immediately after you captured it. (Off, 1 sec*, 3 sec, 5 sec, Hold)
Display Adjust	<p>Adjust the display brightness, auto brightness setting, display color, or level gauge.</p> <ul style="list-style-type: none"> Display Brightness: You can adjust the display brightness manually. Auto Brightness: Turn auto brightness on or off. (Off, On*) Display Color: You can adjust the display color manually. Horizontal Calibration: Calibrate the level gauge. If the level gauge is not level, position the camera on the level surface, and then follow the on-screen instructions. <p> • You cannot access the Horizontal Calibration option in Playback mode.</p> <p> • You cannot calibrate the level gauge in portrait orientation.</p>

* Default

* Default

Item	Description
Auto Display Off	Set the display off time. The display turns off if you do not use the camera for the time you set. (Off, 30 sec*, 1 min, 3 min, 5 min, 10 min)
Power Save	<p>Set power shut off time. The camera shuts off if you do not use it for the time you set. (30 sec, 1 min*, 3 min, 5 min, 10 min, 30 min)</p> <p> • The camera retains the power-off time setting even if you replace the battery.</p> <p> • Power save may not work if the camera is connected to a computer, TV, or printer, playing a slide show or movie.</p>
Date & Time	<p>Set date, time, date format, time zone and whether to imprint the date on photos. (Time Zone, Date, Time, Type, Imprint)</p> <p> • The date appears on the lower right side of the photo.</p> <p> • When you print a photo, some printers may not print the date appropriately.</p>
Help Guide Display	<p>Set to display help text about menus and functions. (Off, On*)</p> <p> Press [] to hide the help text.</p>

Setting 3



Learn about the menu items of the Setting 3.

To set Setting 3 options,

In Shooting or Playback mode, press [MENU] →  → an option.

Item	Description
Sound	<ul style="list-style-type: none"> • System Volume: Set the sound volume or turn all sound off entirely. (Off, Low, Medium*, High) • AF Sound: Set the sound the camera makes in AF mode on or off. (Off, On*) • Button Sound: Set the sound the camera makes when you press buttons on or off. (Off, On*)
Sensor Cleaning	<ul style="list-style-type: none"> • Sensor Cleaning: Remove dust from the sensor. • Start-Up Action: When on, the camera performs sensor cleaning each time you turn it on. (Off*, On) <div style="border: 1px solid #ccc; padding: 5px; margin-top: 10px;">  As this product uses interchangeable lenses, the sensor can get dust on it when you change lenses. This can lead to dust particles appearing in the photos you capture. It is recommended not to change lenses when you are in a particularly dusty area. Also, make sure to attach the lens cap to the lens when not using it. </div>
Video Out	<p>Set the video signal output appropriate for your country when connecting the camera to an external video device such as a monitor or TV.</p> <ul style="list-style-type: none"> • NTSC*: USA, Canada, Japan, Korea, Taiwan, Mexico, etc • PAL (Supports only PAL B, D, G, H, or I): Australia, Austria, Belgium, China, Denmark, Finland, France, Germany, England, Italy, Kuwait, Malaysia, New Zealand, Singapore, Spain, Sweden, Switzerland, Thailand, Norway, etc

* Default

Item	Description
Anynet+ (HDMI-CEC)	<p>When you connect the camera to an HDTV that supports Anynet+ (HDMI-CEC), you can control the play function of the camera with the TV remote control.</p> <ul style="list-style-type: none"> • Off: You cannot control the play function of camera with the TV remote control. • On*: You can control the play function of camera with the TV remote control.
HDMI Output	<p>When you connect the camera to an HDTV with an HDMI cable, you can change the resolution of the image.</p> <ul style="list-style-type: none"> • NTSC: Auto*, 1080i, 720p, 480p, 576p (activates only when PAL is selected) <div style="border: 1px solid #ccc; padding: 5px; margin-top: 10px;">  If the connected HDTV does not support the resolution you select, the camera sets the resolution one level lower. </div>
Device Information	<p>View the firmware version of the body and the lens, Wi-Fi MAC address, and network certification number, or update the firmware.</p> <ul style="list-style-type: none"> • Firmware Update: Update the firmware of the camera body or lens. (Body Firmware, Lens Firmware) <div style="border: 1px solid #ccc; padding: 5px; margin-top: 10px;">  <ul style="list-style-type: none"> • You can download firmware upgrades from www.samsung.com. • You cannot run a firmware upgrade without a fully charged the battery. Recharge the battery fully before running a firmware upgrade. • If you update the firmware, user settings values will be reset. (Date, time, language, video out will not change.) • Do not turn the camera off while the update is in progress. </div>

GPS

Learn about the menu items of the GPS setting. You should purchase an optional GPS accessory in order to use the GPS function.

To set GPS options,

In Shooting or Playback mode, press [MENU] →  → an option.

* Default

Item	Description
Geotagging	Set to capture photos with location information using the Global Positioning System (GPS). Location information is added to the Exif data associated with the photo. (Off, On*)
GPS Valid Time Settings	Set the time to use the last location information when the camera fails to receive GPS signals. If the camera fails to receive GPS signals after the specified time, the location information will not be recorded onto the photos. (15 sec*, 30 sec, 1 min, 3 min, 10 min, 30 min)
Location Display	Set to display the location information on the top right screen of Shooting mode. The location information will appear in Korean only when you are in Korea and the display language is set to Korean. When another language is set, the location information will appear in English. (Off, On*)
GPS Reset	Set to search for GPS satellites closest to your current position. (Yes, No)



Chapter 6

Connecting to external devices

Make full use of the camera by connecting it to external devices such as a computer, HDTV or photo printer.

Viewing files on an HDTV or a 3D TV

Play back photos or videos by connecting your camera to an HDTV (3D TV) using an optional HDMI cable.

Viewing files on an HDTV

- 1 In Shooting or Playback mode, press **[MENU]** →  → **HDMI Output** → an option. (p. 132)
- 2 Turn off your camera and HDTV.
- 3 Connect the HDTV and the camera using the optional HDMI cable.

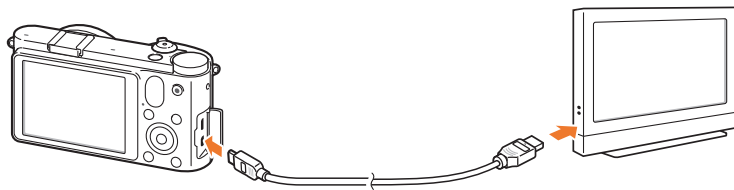

- 4 Make sure that the HDTV and camera are turned on, and then select the HDMI mode on the HDTV.
 - The HDTV screen mirrors the camera's display.
- 5 View the videos and photos using the buttons on the camera.







- When using the HDMI cable, you can connect the camera to an HDTV using the Anynet+(CEC) method.
- The Anynet+(CEC) functions allow you to control connected devices using the TV remote control.
- If the HDTV supports Anynet+(CEC), the TV turns on automatically when used in conjunction with the camera. This feature may not be available on some HDTVs.
- When connected to an HDTV by an HDMI cable, the camera cannot capture a photo or video.
- When connected to an HDTV, some of the camera's playback functions may not be available.
- The length of time after which the camera and an HDTV are connected may vary depending on the memory card that you are using.
- As the main feature of a memory card is to increase the transfer speed, it is not necessarily true to say that a memory card with a faster transfer speed is also fast in using the HDMI function.

Viewing files on a 3D TV

You can view photos captured in 3D mode or 3D Panorama mode on a 3D TV.

- 1 In Shooting or Playback mode, press [MENU] →  → **HDMI Output** → an option.
- 2 Turn off your camera and 3D TV.
- 3 Connect your camera to your 3D TV with the optional HDMI cable.
- 4 Turn on your camera.
 - If you have an Anynet+ compatible Samsung 3D TV and you have turned on your camera's Anynet+ function, the 3D TV turns on automatically and displays the camera screen, while the camera automatically enters Playback mode.
 - If you turn Anynet+ off in your camera, the 3D TV does not turn on automatically.

- 5 Press [ ] on the camera or the mode switching button on the TV to switch to **3D Mode**.
 - Press [ ] or the mode switching button again to switch to **2D Mode**.
- 6 Turn on your TV's 3D function.
 - Refer to your TV's user manual for more details.
- 7 View 3D photos with the buttons on your TV's remote control.



- You cannot view an MPO file in 3D effect on TVs that do not support the file format.
- Use proper 3D glasses when you view an MPO file on a 3D TV.



Do not view the 3D images captured by your camera on a 3D TV or 3D monitor for an extended period of time. It may cause unpleasant symptoms, such as eyestrain, fatigue, nausea, and more.

Printing photos

Print photos on your camera by connecting to printers directly or saving Digital Print Order Format (DPOF) information on a memory card.

Printing photos with a PictBridge photo printer

You can print photos with a PictBridge-compatible printer by connecting your camera directly to the printer.

- 1 With the printer on, connect your camera to the printer with the USB cable.

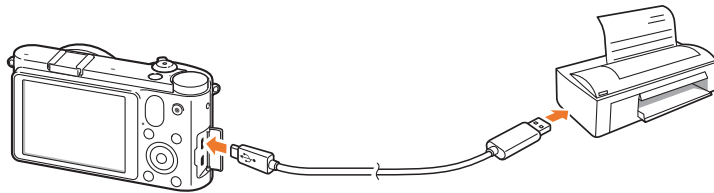

- 2 Turn on your camera.
 - When the pop-up message appears on the camera display, select **Printer**.
- 3 Press [/AF] to select a photo.
 - Press [**MENU**] to set printing options.
- 4 Press [] to print.

Configuring print settings

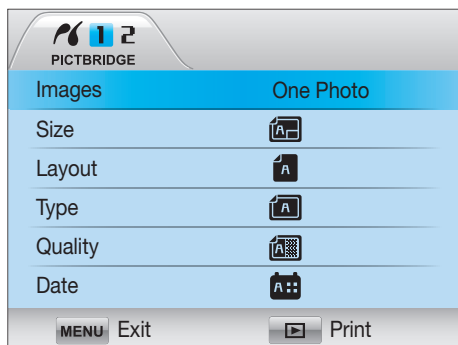

Option	Description
Images	Select whether to print the current photo or all photos.
Size	Specify the size of the print.
Layout	Set the number of photos per page.
Type	Select the type of paper.
Quality	Set the print quality.
Date	Set to print the date.
File Name	Set to print the file name.
Reset	Reset setting to their default values.



Some options may not be supported by some printers.

Creating a print order (DPOF)

DPOF (Digital Print Order Format) lets you set the print size of a photo and the number of copies to be printed. The camera saves the DPOF information in the MISC folder of your memory card. Your camera displays a DPOF indicator when it displays an image with DPOF information. If you have set DPOF information for your images, you can take the memory card to a digital printing shop for printing.

To set DPOF options,

In Playback mode, press **[MENU]** →  → **DPOF** → an item.

DPOF options

Option	Description
Standard	<p>You can select photos to print and the number of copies for photos.</p> <ul style="list-style-type: none"> • Select: Select the number of copies for photos you select. (Scroll to the photos you want to print → Select the number of copies by rotating the navigation button, and then pressing [Fn].) • All: Select the number of copies for all photos. (Select the number of copies by pressing [DISP/☒/☑], and then pressing [OK].) • Reset: Cancel all DPOF printing quantity selections.
Index	<p>This option lets you print all photos set to be printed as thumbnails in a single paper. The print size that you have set is available only with DPOF 1.1-compatible printers.</p>
Size	<p>You can specify the size of the print.</p> <ul style="list-style-type: none"> • Select: Select the print size for photos you choose. (Scroll to the photos you want to print → Select the print size by rotating the navigation button, and then pressing [Fn].) • All: Select the print size of all the photos saved in the memory card. (Select the print size by pressing [DISP/☒/☑], and then pressing [OK].) • Reset: Cancel the DPOF print size for all photos.



Transferring files to your computer

Transfer files on a memory card to your computer by connecting the camera to the PC.

Transferring files to your Windows computer

Connecting the camera as a removable disk

You can connect the camera to your computer as a removable disk.

- 1 Turn off the camera.
- 2 Connect the camera to your computer with the USB cable.

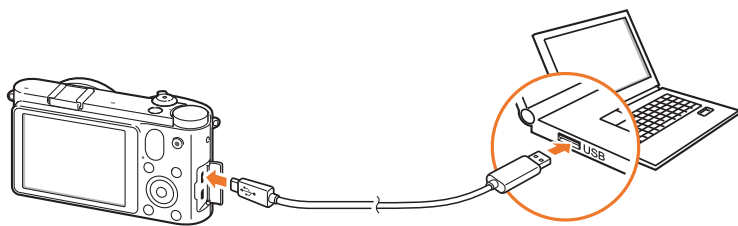

- You must plug the small end of the USB cable into your camera. If the cable is reversed, it may damage your files. The manufacturer is not responsible for any loss of data.
- If you try to plug the USB cable into the HDMI port, the camera may not work properly. If it occurs, restart the camera.

- 3 Turn on the camera.
 - When the pop-up message appears on the camera display, select **Computer**.
- 4 On your computer, select **My Computer** → **Removable Disk** → **DCIM** → **XXXPHOTO** or **XXX_MMDD**.
- 5 Select the files you want, and then drag or save them to your computer.



If the **Folder Type** is set to **Date**, the folder name appears as "XXX_MMDD". For example, if you capture a photo on January 1, the folder name will be "101_0101".

Disconnecting the camera (for Windows XP)

With Windows Vista and Windows 7, the methods for disconnecting the camera are similar.

- 1 Ensure that no data is being transferred between the camera and the computer.
 - If the status lamp on your camera is blinking, it means the data transfer is in progress. Please wait until the status lamp stops blinking.

- 2 Click  on the tool bar at the bottom right of your computer screen.



- 3 Click the pop-up message.
- 4 Click the message box indicating safely removed.
- 5 Remove the USB cable.

Transferring files to your Mac computer

- 1 Turn off the camera.
- 2 Connect your camera to a Macintosh computer with the USB cable.



Mac OS 10.4 or later is supported.



- You must plug the small end of the USB cable into your camera. If the cable is reversed, it may damage your files. The manufacturer is not responsible for any loss of data.
- If you try to plug the USB cable into the HDMI port, the camera may not work properly. If it occurs, restart the camera.

- 3 Turn on the camera.
 - When the pop-up message appears on the camera display, select **Computer**.
- 4 Open the removable disk.
- 5 Transfer photos or videos to the computer.

Using programs on a PC

You can edit files using the provided programs. You can also send the files to a PC wirelessly.

Installing software

- 1 Insert the CD-ROM into your PC.
- 2 When the setting wizard appears, click **Samsung Digital Camera Installer**.
- 3 Select a program you want to install, and then click **Install**.
- 4 Follow the on-screen instructions.
- 5 When the installation is complete, click **Exit**.

Programs contained on the CD

Program	Purpose
Intelli-studio	Edit photos and videos.
PC Auto Backup	Send the recorded files to a connected PC via Wi-Fi.



- If your computer does not meet the requirements, videos may not play correctly or it may take longer to edit videos.
- Install DirectX 9.0c or above before you use the program.
- You must use Windows XP/Vista/7 or Mac OS 10.4 or later to connect the camera as a removable disk.



Using a self-assembled PC or a PC and OS that are not supported may void your warranty.

Using Intelli-studio

Intelli-studio is a built-in program that allows you to play back and edit files. You can also upload files to your favorite websites. For details, select **Help** → **Help** in the program.

Requirements

Item	Requirements
OS*	Windows XP SP2, Windows Vista, or Windows 7 (32-bit editions)
CPU	Intel® Core 2 Duo 1.66 GHz or higher/ AMD Athlon™ X2 Dual-Core 2.2 GHz or higher
RAM	Minimum 512 MB RAM (1 GB or more recommended)
Hard disk capacity	250 MB or more (1 GB and above recommended)
Others	<ul style="list-style-type: none"> • CD-ROM drive • 1024x768 pixels, 16-bit color display compatible monitor (1280x1024 pixels, 32-bit color display recommended) • USB 2.0 port • nVIDIA Geforce 7600GT or higher/ ATI X1600 series or higher • Microsoft DirectX 9.0c or later

* A 32-bit version of Intelli-studio will be installed—even on 64-bit editions of Windows XP, Windows Vista and Windows 7.



- The requirements are recommendation only. It may not work properly even when the computer meets the requirements, depending on the condition of your computer.
- Intelli-studio is compatible only with Windows.
- Intelli-studio supports the following formats:
 - **Videos:** MP4 (Video: H.264, Audio: AAC), WMV (WMV 7/8/9), AVI (MJPEG)
 - **Photos:** JPG, GIF, BMP, PNG, TIFF
- You cannot open the RAW format files with the Intelli-studio program.
- You cannot edit files directly on the camera. Transfer files to a folder on your computer before editing.

Using the Intelli-studio Interface



No.	Description
8	View files of the selected folder on your computer.
9	Show or hide files of the connected camera.
10	View files of the selected folder on the camera.
11	View files as thumbnails or on a map.
12	Browse folders in the connected device.
13	Browse folders in your computer.
14	Move to the previous or next folder.
15	Print files, view files on a map, store files in My Folder, or register faces.

No.	Description
1	Open menus.
2	Display files in the selected folder.
3	Change to the Photo edit mode.
4	Change to the Video edit mode.
5	Change to the Sharing mode. (You can send files by email or upload files to websites, such as Flickr or YouTube.)
6	Enlarge or reduce the thumbnails in the list.
7	Select a file type.

Transferring files using Intelli-studio

You can easily transfer files on your camera to your computer by using Intelli-studio.

- 1 Turn off the camera.
- 2 Connect the camera to your computer with the USB cable.

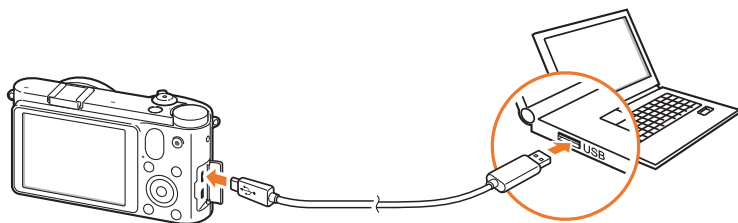

- You must plug the end of the cable with the correct connection plug into your camera. If the cable is reversed, it may damage your files. The manufacturer is not responsible for any loss of data.
- If you try to plug the USB cable into the HDMI port, the camera may not work properly. If it occurs, restart the camera.

- 3 Run Intelli-studio on your computer.
- 4 Turn on the camera.
 - When the pop-up message appears on the camera display, select **Computer**.
- 5 Select a folder on your computer to save new files and select **Yes**.
 - New files will be transferred to the computer.
 - If your camera has no new files, the pop-up window for saving new files will not appear.

Installing Adobe Photoshop Lightroom

- 1 Insert Adobe Photoshop Lightroom DVD-ROM into your PC.
- 2 Select a language.
- 3 Follow the on-screen instructions.

Using Adobe Photoshop Lightroom

Photos captured by a camera are often transformed to JPEG formats and stored in the memory according to the settings of the camera at the time of shooting. RAW files are not transformed to JPEG formats and are stored in the memory without any changes. With Adobe Photoshop Lightroom, you can calibrate exposures, White Balances, tones, contrasts, and colors of photos. You can also edit JPEG or TIFF files as well as RAW files. For more information, refer to the program guide.



Chapter 7

Appendix

Get information about error messages, camera maintenance, trouble shooting tips, specifications, and optional accessories.

Error messages

When the following error messages appear, try these remedies.

Error messages	Suggested remedies
Lens is locked	The lens is locked. Rotate the lens counter-clockwise until you hear a click. (p. 35)
Card Error	<ul style="list-style-type: none"> • Turn off your camera, and then turn it on again. • Remove your memory card and insert it again. • Format your memory card.
Low Battery	Insert a charged battery or recharge the battery.
No Image File	Capture photos or insert a memory card that contains photos.
File Error	Delete the damaged file or contact a service center.
Memory Full	Delete unnecessary files or insert a new memory card.
Card Locked	You can lock SD, SDHC or SDXC card to prevent files from being deleted. Unlock the card when shooting. (p. 152)

Error messages	Suggested remedies
Folder and file number are max values. Replace the card	File names do not match the DCF standard. Transfer the files on the memory card to your computer and format the card. (p. 130)
Error 00	Turn off your camera and remount the lens. If the message still appears, contact a service center.
Error 01/02	Turn off your camera, remove the battery, and insert again. If the message still appears, contact a service center.

Maintaining the camera

Cleaning the camera

Camera lens and display

Use a brush to remove dust and wipe the lens gently with a soft cloth. If any dust remains, apply lens cleaning liquid to a piece of cleaning paper and wipe gently.

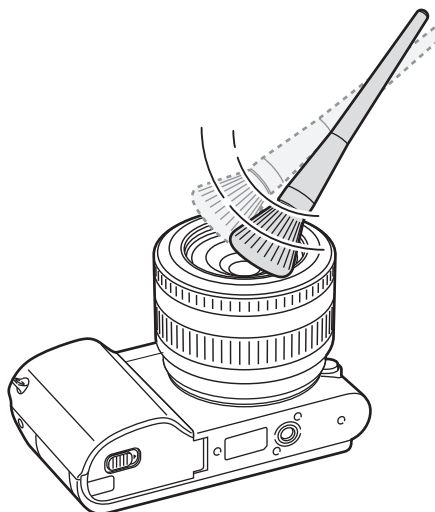

Image sensor

Depending on different shooting conditions, dust may appear in photos because the image sensor is exposed to the external environment. This problem is normal, and the exposure to dust occurs in everyday use of the camera. You can remove dust from the sensor by operating the sensor cleaning function. (p. 132) If dust remains after cleaning the sensor, contact a service center. Do not insert the blower into the mounting opening of the lens.

Camera body

Wipe gently with a soft, dry cloth.



Never use benzene, thinners or alcohol to clean the device. These solutions can damage the camera or cause it to malfunction.

Using or storing the camera

Inappropriate places to use or store the camera

- Avoid exposing the camera to very cold or very hot temperatures.
- Avoid using your camera in areas with extremely high humidity, or where the humidity changes drastically.
- Avoid exposing the camera to direct sunlight and storing it in hot, poorly-ventilated areas, such as in a car during summer time.
- Protect your camera and the display from impact, rough handling, and excessive vibration to avoid serious damage.
- Avoid using or storing your camera in dusty, dirty, humid, or poorly-ventilated areas to prevent damage to moving parts and internal components.
- Do not use your camera near fuels, combustibles, or flammable chemicals. Do not store or carry flammable liquids, gases, or explosive materials in the same compartment as the camera or its accessories.
- Do not store the camera where there are mothballs.

Using on beaches or shores

- Protect your camera from sand and dirt when you use it on beaches or in other similar areas.
- Your camera is not waterproof. Do not handle the battery, or memory card with wet hands. Operating the camera with wet hands may cause damage to your camera.

Storing for extended period of time

- When you store the camera for an extended period, place it in a sealed container with an absorbent material, such as silica gel.
- Remove the batteries from your camera when storing it for an extended period. Installed batteries may leak or corrode over time and cause serious damage to your camera.
- Over time, unused batteries will discharge and must be recharged before use.

Using the camera with caution in humid environments

When you transfer the camera from a cold environment to a warm one, condensation can form on the lens or internal components of the camera. In this situation, turn off the camera and wait for at least 1 hour. If condensation forms on the memory card, remove the memory card from the camera and wait until all moisture has evaporated before reinserting it.

Other cautions

- Do not swing your camera by the strap. This may cause injury to yourself or others or damage to your camera.
- Do not paint your camera, as paint can clog moving parts and prevent proper operation.
- Turn off the camera when not using it.
- Your camera consists of delicate parts. Avoid impacts to the camera.
- Protect the display from external force by keeping it in the case when not in use. Protect the camera from scratches by keeping it away from sand, sharp implements, or loose change.
- Do not use the camera if the screen is cracked or broken. Broken glass or acrylic could cause injury to your hands and face. Take the camera to a Samsung service center to have it repaired.
- Never place cameras, batteries, chargers, or accessories near, on, or in heating devices, such as microwave ovens, stoves, or radiators. These devices may be deformed and can overheat and cause a fire or explosion.
- Do not expose the lens to direct sunlight, as this may discolor the image sensor or cause it to malfunction.
- Protect your lens from fingerprints and scratches. Clean your lens with a soft, clean, debris-free lens cloth.
- The camera may turn off if impacted from the outside. This is to protect the memory card. Turn on the camera to use it again.
- While you use the camera, it may heat up. This is normal and should not affect your camera's lifespan or performance.
- When you use the camera in low temperatures, it may take some time to turn on, the color of the display may be changed temporarily, or after-images may appear. These conditions are not malfunctions and they will correct themselves when the camera is returned to normal temperatures.
- Paint or metal on the outside of the camera may cause allergies, itchy skin, eczema, or swelling for people with sensitive skin. If you experience any of these symptoms, stop using the camera immediately and consult a doctor.

About memory card

Supported memory card

This product supports SD (Secure Digital), SDHC (Secure Digital High Capacity), SDXC (Secure Digital eXtended Capacity), microSD, microSDHC, or microSDXC memory cards.

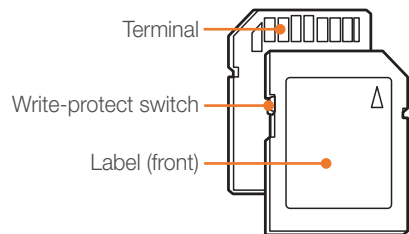

You can prevent files from being deleted by using the write-protect switch on an SD, SDHC or SDXC card. Slide the switch down to lock or slide it up to unlock. Unlock the card when capturing photos and videos.

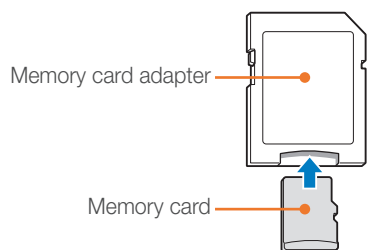

To use micro memory cards with this product, a PC, or a memory card reader, insert the card into an adapter.

Memory card capacity

The memory capacity may differ depending on shooting scenes or shooting conditions. These capacities are based on a 2 GB SD card.

	Size	Quality	
		HQ	Normal
Videos*	1080 SDP 1920X1080 (30 FPS)	Approx. 17' 35"	Approx. 21' 56"
	810 24P 1920X810 (24 FPS)	Approx. 19' 00"	Approx. 23' 43"
	720 SDP 1280X720 (30 FPS)	Approx. 29' 10"	Approx. 36' 20"
	480 30P 640X480 (30 FPS)	Approx. 73' 26"	Approx. 91' 00"
	240 WEB For Sharing (30 FPS)	Approx. 236' 16"	Approx. 287' 12"

* The recordable time may vary if you use the zoom. Several videos were recorded in succession to determine the total recording time.

	Size	Quality						
		Super Fine	Fine	Normal	RAW	RAW + S.Fine	RAW + Fine	RAW + Normal
Photo	20.0M (5472X3648)	186	364	535	53	37	46	51
	10.1M (3888X2592)	378	724	1,043	-	47	53	56
	5.9M (2976X1984)	626	1,168	1,642	-	52	57	58
	2.0M (1728X1152)	1,627	2,742	3,553	-	58	60	61
	Burst	731	1,349	1,878	-	-	-	-
	16.9M (5472X3080)	230	448	655	-	40	49	53
	7.8M (3712X2088)	485	919	1,310	-	50	55	57
	4.9M (2944X1656)	747	1,376	1,912	-	54	57	59
	2.1M (1920X1080)	1,573	2,666	3,468	-	58	60	61
	13.3M (3648X3648)	289	560	814	-	44	51	54
	7.0M (2640X2640)	536	1,010	1,432	-	51	56	58
	4.0M (2000X2000)	893	1,621	2,224	-	55	58	59
	1.1M (1024X1024)	2,645	4,057	4,936	-	60	61	61

Cautions when using memory cards

- Avoid memory cards to very cold or very hot temperatures (below 0 °C/32 °F or above 40 °C/104 °F). Extreme temperatures can cause memory cards to malfunction.
- Insert a memory card in the correct direction. Inserting a memory card in the wrong direction may damage your camera and memory card.
- Do not use memory cards that have been formatted by other cameras or by a computer. Reformat the memory card with your camera.
- Turn off the camera when you insert or remove the memory card.
- Do not remove the memory card or turn off your camera while the lamp is blinking, as this may damage your data.
- When the lifespan of a memory card has expired, you cannot store any more photos on the card. Use a new memory card.
- Do not bend, drop, or subject memory cards to heavy impact or pressure.
- Avoid using or storing memory cards near strong magnetic fields.
- Avoid using or keeping memory cards in areas with high temperature, high humidity, or corrosive substances.
- Prevent memory cards from making contact with liquids, dirt, or foreign substances. If dirty, wipe the memory card clean with a soft cloth before you insert the memory card in your camera.
- Do not allow liquids, dirt, or foreign substances to come in contact with memory cards or the memory card slot. Doing so may cause memory cards or the camera to malfunction.
- When you carry a memory card, use a case to protect the card from electrostatic discharges.
- Transfer important data to other media, such as a hard disk, CD, or DVD.
- When you use the camera for an extended period, the memory card may become warm. This is normal and does not indicate a malfunction.
- Use a memory card that meets the standard requirements.



The manufacturer is not responsible for any loss of data.

About the battery

Use only Samsung-approved batteries.

Battery specifications

Item	Description
Model	BP1030
Type	Lithium-ion battery
Cell capacity	1,030 mAh
Voltage	7.4 V
Charging time (When the battery is completely discharged)	Approx. 140 min



Personal injury or death can occur if the battery is handled carelessly or improperly. For your safety, follow these instructions for proper battery handling:

- The battery can ignite or explode if not handled properly. If you notice any deformities, cracks, or other abnormalities in the battery, immediately discontinue use of the battery and contact your manufacturer.
- Use only authentic, manufacturer-recommended battery chargers and charge the battery only by the method described in this user manual.
- Do not place the battery near heating devices or expose to excessively warm environments, such as the inside of an enclosed car in the summertime.
- Do not place the battery in a microwave oven.
- Avoid storing or using the battery in hot, humid places, such as spas or shower enclosures.

- Do not rest the device on flammable surfaces, such as bedding, carpets, or electric blankets for a prolonged period.
- When the device is switched on, do not leave it in any confined space for a prolonged period.
- Do not allow battery terminals to come in contact with metallic objects, such as necklaces, coins, keys, or watches.
- Use only authentic, manufacturer-recommended, Lithium-ion replacement batteries.
- Do not disassemble the battery or puncture the battery with any sharp object.
- Avoid exposing the battery to high pressure or crushing forces.
- Avoid exposing the battery to major impacts, such as dropping it from high places.
- Do not expose the battery to temperatures of 60 °C (140 °F) or above.
- Do not allow the battery to come in contact with moisture or liquids.
- Battery shall not be exposed to excessive heat such as sunshine, fire or the like.

Disposal guidelines

- Dispose of the battery with care.
- Do not dispose of the battery in a fire.
- Disposal regulations may differ by country or region. Dispose of the battery in accordance with all local and federal regulations.

Guidelines for charging the battery

Charge the battery only by the method described in this user manual. The battery can ignite or explode if not charged properly.

Battery life

Shooting mode	Average time / Number of photos
Photos	Approx. 160 min/Approx. 320 photos
Videos	Approx. 110 min (Record videos at 1920X1080 resolution and 30 FPS.)

- The figures above are based on Samsung's test standards. Your results may differ depending on your actual usage.
- Available shooting time differs depending on background, shooting interval, and use conditions.
- Several videos were recorded in succession to determine the total recording time.

Low battery message

When the battery has fully discharged, the battery icon will turn red and the "Low Battery" message will appear.

Notes about using the battery

- In temperatures below 0 °C/32 °F, battery capacity and battery life may decrease.
- Battery capacity may decrease in low temperatures but will return to normal in milder temperatures.
- When you use the camera for an extended period, the area around the battery chamber may become warm. This does not affect the normal use of the camera.

Notes about charging the battery

- If the indicator light is off, make sure that the battery is inserted correctly.
- Do not pull on the power supply cord to disconnect the plug from the power outlet. This may cause a fire or electric shock.
- When the battery is completely discharged, charge it at least 10 minutes before using it with your camera.
- If the indicator light blinks orange or does not illuminate, reconnect the cable, or remove the battery and insert it again.
- If you charge the battery when the cable is overheated or the temperature is too high, the indicator light may turn orange. Charging will start when the battery cools down.
- Do not bend or place heavy objects on the AC cable. Doing so may damage the cable.

Before contacting a service center

If you are having trouble with your device, try these troubleshooting solutions before contacting a service professional.



When you leave your camera at a service center, be sure to also leave the other components that may have contributed to the malfunction, such as the memory card and battery.



Situation	Suggested remedies
Cannot turn on the camera	<ul style="list-style-type: none"> • Ensure that the battery is inserted. • Ensure that the battery is inserted correctly. • Charge the battery.
The power turns off suddenly	<ul style="list-style-type: none"> • Charge the battery. • Your camera may be in Power save mode or the display turns off automatically. (p. 131) • The camera may be turned off automatically to prevent the memory card from being damaged due to excessive heat. Turn on your camera again.
The camera is losing battery power quickly	<ul style="list-style-type: none"> • The battery may lose power more quickly in low temperatures (below 0 °C/32 °F). Keep the battery warm by putting it into your pocket. • Using the flash or recording videos depletes the battery quickly. Recharge if needed. • Batteries are consumable parts that must be replaced over time. Get a new battery if the battery life is diminishing quickly.

Situation	Suggested remedies
Cannot capture photos	<ul style="list-style-type: none"> • There is no space on the memory card. Delete unnecessary files or insert a new card. • When the AF Priority function is turned on, you cannot capture a photo unless the focus is set correctly. Set AF Priority to Off or focus on the subject correctly. (p. 126) • Format the memory card. • The memory card is defective. Get a new memory card. • The memory card is locked. Unlock the card. (p. 152) • Ensure that the camera is switched on. • Charge the battery. • Ensure that the battery is inserted correctly.
The camera freezes	Remove the battery and insert it again.
The camera heats up	While using the camera, it may heat up. This is normal and should not affect your camera's lifespan or performance.
The flash fires unexpectedly	The flash may fire due to static electricity. The camera is not malfunctioning.
The flash does not work	<ul style="list-style-type: none"> • The flash option may be set to Off. (p. 76) • You cannot use the flash in some modes.
The date and time are incorrect	Set the date and time under the  menu. (p. 131)

Situation	Suggested remedies
The display or buttons do not work	Remove the battery and insert it again.
The memory card has an error	<ul style="list-style-type: none"> • Turn off your camera, and then turn it on again. • Remove your memory card, and then insert it again. • Format your memory card. See "Cautions when using memory cards" for more details. (p. 154)
Your TV or computer cannot display photos and videos that are stored on an SDXC memory card.	SDXC memory cards use the exFAT file system. Ensure that the external device is compatible with the exFAT file system before connecting the camera to the device.
Your computer does not recognize an SDXC memory card.	SDXC memory cards use the exFAT file system. To use SDXC memory cards on a Windows XP computer, download and update the exFAT file system driver from the Microsoft website.
Cannot display files	If you change the name of a file, your camera may not play the file (the name of the file should meet the DCF standard). If you encounter this situation, display files on your computer.

Situation	Suggested remedies
The photo is blurry	<ul style="list-style-type: none"> • Ensure that the focus option you set is suitable for the kind of shot you are capturing. • Use a tripod to prevent your camera from shaking. • Ensure that the lens is clean. If not, clean the lens. (p. 149)
The colors in the photo do not match the actual scene	An incorrect White Balance can create unrealistic color. Select the proper White Balance option to suit the light source. (p. 61)
The photo is too bright	Your photo is overexposed. <ul style="list-style-type: none"> • Adjust the aperture value or the shutter speed. • Adjust the ISO sensitivity. (p. 60) • Turn off the flash. (p. 76) • Adjust the exposure value. (p. 85)
The photo is too dark	Your photo is underexposed. <ul style="list-style-type: none"> • Adjust the aperture value or the shutter speed. • Adjust the ISO sensitivity. (p. 60) • Turn on the flash. (p. 76) • Adjust the exposure value. (p. 85)

Situation	Suggested remedies
Photos are distorted	This camera can have minute distortion when using a wide-angle lens that enables shooting with a wide angle of view. This is normal, and does not cause malfunction.
Playback screen does not appear on the connected external device	<ul style="list-style-type: none"> • Ensure that HDMI cable is properly connected to the external monitor. • Ensure that the memory card is properly recorded.
Your computer does not recognize your camera	<ul style="list-style-type: none"> • Ensure that the USB cable is connected correctly. • Ensure that your camera is switched on. • Ensure that you are using a supported operating system.
Your computer disconnects the camera while transferring files	The file transfer may be interrupted by static electricity. Disconnect the USB cable and connect it again.
Your computer cannot play videos	Depending on the software you use, video files may not play. To play video files captured with your camera, install and use the Intelli-studio program on your computer. (p. 142)
Intelli-studio is not functioning properly	<ul style="list-style-type: none"> • End Intelli-studio and restart the program. • You cannot use Intelli-studio on Macintosh computers.

Situation	Suggested remedies
Cannot set the DPOF for RAW files	You cannot set the DPOF for RAW files.
Auto Focus does not work	<ul style="list-style-type: none"> • Subject is not in focus. When the subject is outside the AF area, shoot by moving the subject inside the AF area and half pressing [Shutter]. • Subject is too close. Step back from the subject and shoot. • The focus mode is set to MF. Switch the mode to AF.
AEL feature does not work	AEL feature does not work in SMART , M ,  ,  and SCN modes. Select another mode to use this feature.
Lens does not work	<ul style="list-style-type: none"> • Ensure that the lens is properly mounted. • Remove the lens from the camera and re-mount it.
External flash or GPS does not work	Ensure that the external device is properly mounted and turned on.
The date & time settings screen appears when you power on the camera	<ul style="list-style-type: none"> • Set the date and time again. • This screen appears when the camera's internal power source is completely discharged. Insert a fully charged battery and wait at least 72 hours in power off status for the internal power source to be recharged.

Camera specifications

Image Sensor	
Type	CMOS
Sensor size	23.5 X 15.7 mm
Effective pixels	Approx. 20.3 mega-pixels
Total pixels	Approx. 21.6 mega-pixels
Color filter	RGB primary color filter
Lens Mount	
Type	Samsung NX Mount
Available lens	Samsung lenses
Image Stabilization	
Type	Lens shift (depends on lens)
Mode	Mode 1/Mode 2/Off
Distortion Correct	
Lens Distortion Correct on/off (depends on lens)	
i-Function	
<i>i</i> effect (depends on lens), <i>i</i> zoom (X1.2, 1.4, 1.7, 2.0)	
Dust Reduction	
Type	Super sonic drive

Display	
Type	TFT LCD
Size	3.0" (Approx. 7.6 cm)
Resolution	VGA (640X480) Approx. 921 k dots
Field of view	Approx. 100 %
User display	Grid Line, Icons, Histogram, Distance Scale, Level gauge
Focusing	
Type	Contrast AF
Focusing point	<ul style="list-style-type: none"> • Selection: 1 point (free selection) • Multi: Normal 15 points, Close up 35 points • Face detection: Max. 10 faces
Mode	Single AF, Continuous AF, Manual Focus
AF Assist Lamp	Included (Green LED)
Shutter	
Type	Electronically controlled vertical-run focal plane shutter
Speed	<ul style="list-style-type: none"> • Auto: 1/4,000–30 sec. • Manual: 1/4,000–30 sec. (1/3 EV Step) • Bulb (time limit: 4 min.)

Exposure	
	TTL 221 (17 X 13) Block segment
Metering system	Metering: Multi, Center-weighted, Spot Metering range: EV 0–18 (ISO100 · 30 mm, F2)
Compensation	±3 EV (1/3 EV Step)
AE lock	Custom button
ISO equivalent	<ul style="list-style-type: none"> • 1 Step: Auto, ISO 100, ISO 200, ISO 400, ISO 800, ISO 1600, ISO 3200, ISO 6400, ISO 12800 • 1/3 Step: Auto, ISO 100, ISO 125, ISO 160, ISO 200, ISO 250, ISO 320, ISO 400, ISO 500, ISO 640, ISO 800, ISO 1000, ISO 1250, ISO 1600, ISO 2000, ISO 2500, ISO 3200, ISO 4000, ISO 5000, ISO 6400, ISO 8000, ISO 10000, ISO 12800
Drive Mode	
Mode	Single, Continuous, Burst (5M only), Timer, Bracket (Auto Exposure, White Balance, Picture Wizard)
Continuous shooting	<ul style="list-style-type: none"> • JPEG <ul style="list-style-type: none"> - High (8 fps): up to 11 shots possible - Low (3 fps): up to 15 shots possible • RAW <ul style="list-style-type: none"> - High (8 fps), Low (3 fps): up to 8 shots possible

Burst shooting	<ul style="list-style-type: none"> • 10, 15, or 30 frames per second • Up to 30 shots per shutter-press
Bracket shooting	Auto exposure bracketing (±3 EV), White Balance bracketing, Picture Wizard bracketing
Self-timer	2–30 sec. (1 second interval)
Shutter release	SR2NX02 (via Micro USB port) (optional)
Flash	
Type	External flash only (Bundle with SEF8A)
Mode	Smart Flash, Auto, Auto Red-eye, Fill in, Fill-in Red, 1st Curtain, 2nd Curtain, Off
Guide number	8 (based on ISO 100)
Angle of view	28 mm (35 mm film equivalent)
Sync speed	Less than 1/180 sec.
Flash EV	-2–+2 EV (0.5 EV Step)
External flash	Optional Samsung external flashes: SEF42A, SEF220A
Sync terminal	Hot-shoe
White Balance	
Mode	Auto WB, Daylight, Cloudy, Fluorescent White, Fluorescent NW, Fluorescent Daylight, Tungsten, Flash WB, Custom Set, Color Temperature (Manual)
Micro adjustment	Amber/Blue/Green/Magenta 7 steps respectively

Smart Range	
Smart Range On/Off	
Picture Wizard	
Mode	Standard, Vivid, Portrait, Landscape, Forest, Retro, Cool, Calm, Classic, Custom1, Custom2, Custom3
Parameter	Contrast, Sharpness, Saturation, Color
Shooting	
Mode	Smart Auto, Program, Aperture Priority, Shutter Priority, Manual, Lens Priority, Magic, Scene, Movie, Wi-Fi
Scene mode	Panorama (Live Panorama, 3D), Beauty Shot, Night, Landscape, Portrait, Children, Sports, Close Up, Text, Sunset, Dawn, Backlight, Fireworks, Beach & Snow, 3D
Smart Filter	Vignetting, Miniature, Fish Eye, Sketch, Defog, Halftone Dots, Soft Focus, Old Film 1, Old Film 2, Negative
Magic Frame	Old Album, Old Film, Wave, Full Moon, Old Record, Magazine, Newspaper, Sunny Day, Classic TV, Wall Art, Holiday, Billboard 1, Billboard 2
Selective Color	Red, Green, Blue, Yellow

Size	<ul style="list-style-type: none"> • JPEG (3:2): 20.0M (5472X3648), 10.1M (3888X2592), 5.9M (2976X1984), 5.0M (2736X1824) (Burst mode only), 2.0M (1728X1152) • JPEG (16:9): 16.9M (5472X3080), 7.8M (3712X2088), 4.9M (2944X1656), 2.1M (1920X1080) • JPEG (1:1): 13.3M (3648X3648), 7.0M (2640X2640), 4.0M (2000X2000), 1.1M (1024X1024) • RAW: 20.0M (5472X3648)
Quality	Super Fine, Fine, Normal
RAW standard	SRW
Color space	sRGB, Adobe RGB
Video	
Type	MP4 (H.264)
Format	Movie: H.264, Sound: AAC
Movie AE mode	Program, Aperture Priority, Shutter Priority, Manual

Movie clip	Audio on/off (Shooting time: up to 25 min)
Smart Filter	Vignetting, Miniature, Fish Eye, Sketch, Defog, Halftone Dots, Soft Focus, Old Film 1, Old Film 2, Negative
Size	1920X1080, 1920X810, 1280X720, 640X480, 320X240 (For Sharing)
Frame rate	24 or 30 frames per second (24 fps is available only with 1920X810.)
Multi Motion	x0.25 (640X480, 320X240 only), x0.5 (1280X720, 640X480, 320X240 only), x1, x5, x10, x20
Quality	HQ, Normal
Sound	Stereo
Edit	Still image capture, Time trimming
Playback	
Type	Single image, Thumbnails (3/15/40), Slide show, Movie
Edit	Smart Filter, Red-eye Fix, Backlight, Resize, Rotate, Face Retouch, Brightness, Contrast, Vignetting

Smart filter	Miniature, Soft Focus, Old Film 1, Old Film 2, Halftone Dots, Sketch, Fish Eye, Defog, Negative
Smart filter size	<ul style="list-style-type: none"> • JPEG (3:2): 5.9M (2976X1984), 5.0M (2736X1824), 2.0M (1728X1152) • JPEG (16:9): 6.2M (3328X1872), 4.9M (2944X1656), 2.1M (1920X1080) • JPEG (1:1): 6.0M (2448X2448), 4.0M (2000X2000), 1.1M (1024X1024)
Storage	
Media	External memory (optional): SD card (up to 1–2 GB guaranteed), SDHC card (up to 32 GB guaranteed), SDXC card (up to 128 GB guaranteed)
File format	RAW (SRW), JPEG (EXIF 2.21), DCF, DPOF 1.1, PictBridge 1.0
Direct Printing	
PictBridge	
GPS	
Type	Geo-tagging with optional GPS Module (WGS 84)
Feature	<ul style="list-style-type: none"> • Location name (English and Korean only) • Google Map link (with Intelli-studio)

Wireless network	
Type	IEEE 802.11n supported
Function	SNS & Cloud, Email, MobileLink, Remote Viewfinder, Auto Backup, TV Link, Wi-Fi Direct, AutoShare
Interface	
Digital output	USB 2.0 (HI-SPEED) (micro USB jack)
Video output	NTSC, PAL (selectable) HDMI 1.4b: (1080i, 720p, 576p/480p)
External release	Yes (micro USB)
External microphone	Yes
Power Source	
Type	<ul style="list-style-type: none"> • Rechargeable battery: BP1030 (1,030 mAh) • Charger: BC1030 * The power source may differ depending on your region.

Dimensions (W X H X D)
114 X 62.5 X 37.5 mm (without protrusions)
Weight
222 g (without battery and memory card)
Operating Temperature
0–40 °C
Operating Humidity
5–85 %
Software
Intelli-studio, Adobe Photoshop Lightroom, PC Auto Backup

* This specifications can change without notice to upgrade a performance.
 * Other brands and products names are trademarks of respective owners.

Glossary

AP (Access Point)

An access point is a device that allows wireless devices to connect to a wired network.

Ad-Hoc network

An ad-hoc network is a temporary connection for sharing files or an internet connection and between computers and devices.

AdobeRGB

Adobe RGB is used for commercial printing and has a larger color range than sRGB. Its wider range of colors helps you to easily edit photos on a computer.

AEB (Auto Exposure Bracket)

This feature automatically captures several images at different exposures to help you capture a properly-exposed image.

AEL (Auto Exposure Lock)

This feature helps you lock the exposure on which you want to calculate the exposure.

AF (Auto Focus)

A system that automatically focuses the camera lens on the subject. Your camera uses the contrast to focus automatically.

AMOLED (Active-matrix organic light-emitting diode) / LCD (Liquid Crystal Display)

AMOLED is a visual display that is very thin and light, as it does not need backlighting. LCD is a visual display commonly used in consumer electronics. This display needs a separate backlight, such as CCFL or LED, to reproduce colors.

Aperture

The aperture controls the amount of light that reaches the camera's sensor.

Camera shake (Blur)

If the camera is moved while the shutter is open, the entire image may appear blurred. This occurs more often when the shutter speed is slow. Prevent camera shake by raising the sensitivity, using the flash, or using a faster shutter speed. Alternatively, use a tripod or the OIS function to stabilize the camera.

Cloud Computing

Cloud computing is a technology that allows you to store data on remote servers and to use them from a device with internet access.

Color space

The range of colors that the camera can see.

Color temperature

Color Temperature is a measurement in degrees Kelvin (K) that indicates the hue of a specific type of light source. As the color temperature increases, the color of the light source has a more bluish quality. As the color temperature decreases, the color of the light source has a more reddish quality. At 5,500 degrees Kelvin, the color of the light source is similar to the sun at midday.

Composition

Composition in photography means arranging objects in a photo. Usually, abiding by the rule of thirds leads to a good composition.

DCF (Design rule for Camera File system)

A specification to define a file format and file system for digital cameras created by the Japan Electronics and Information Technology Industries Association (JEITA).

Depth of field

The distance between the nearest and farthest points that can be acceptably focused in a photograph. Depth of field varies with lens aperture, focal length, and distance from the camera to the subject. Selecting a smaller aperture, for example, will increase the depth of field and blur the background of a composition.

DPOF (Digital Print Order Format)

A format for writing printing information, such as selected images and number of prints, on a memory card. DPOF-compatible printers, sometimes available at photo shops, can read the information from the card for convenient printing.

EV (Exposure Value)

All the combinations of the camera's shutter speed and lens aperture that result in the same exposure.

EV Compensation

This feature allows you to quickly adjust the exposure value measured by the camera, in limited increments, to improve the exposure of your photos.

Exif (Exchangeable Image File Format)

A specification to define an image file format for digital cameras created by the Japan Electronic Industries Development Association (JEIDA).

Exposure

The amount of light allowed to reach the camera's sensor. Exposure is controlled by a combination of the shutter speed, the aperture value, and ISO sensitivity.

Flash

A speed light that helps to create adequate exposure in low-light conditions.

Focal length

The distance from the middle of the lens to its focal point(in millimeters). Longer focal lengths result in narrower angles of view and the subject is magnified. Shorter focal lengths result in wider angles of view.

Histogram

A graphical representation of the brightness of an image. The horizontal axis represents the brightness and the vertical axis represents the number of pixels. High points at the left (too dark) and right (too bright) on the histogram indicate a photo that is improperly exposed.

H.264/MPEG-4

A high-compression video format established by international standard organizations ISO-IEC and ITU-T. This codec is capable of providing good video quality at low bit rates developed by the Joint Video Team (JVT).

Image sensor

The physical part of a digital camera that contains a photosite for each pixel in the image. Each photosite records the brightness of the light that strikes it during an exposure. Common sensor types are CCD (Charge-coupled Device) and CMOS (Complementary Metal Oxide Semiconductor).

IP (Internet protocol) address

An IP address is a unique number that is assigned to every device that is connected to the internet.

ISO sensitivity

The sensitivity of the camera to light, based on the equivalent film speed used in a film camera. At higher ISO sensitivity settings, the camera uses a higher shutter speed, which can reduce blur caused by camera shake and low light. However, images with high sensitivity are more susceptible to noise.

JPEG (Joint Photographic Experts Group)

A lossy method of compression for digital images. JPEG images are compressed to reduce their overall file size with minimal deterioration of the image resolution.

Metering

The metering refers to the way in which the camera measures the quantity of light to set the exposure.

MF (Manual Focus)

A system that manually focuses the camera lens on the subject. You can use the focus ring to focus on a subject.

MJPEG (Motion JPEG)

A video format which is compressed as a JPEG image.

MPO (Multi Picture Object)

An image file format that contains multiple images in a file. An MPO file provides a 3D effect on MPO-compatible displays, such as 3D TVs or 3D monitors.

Noise

Misinterpreted pixels in a digital image that may appear as misplaced or random, bright pixels. Noise usually occurs when photos are shot with a high sensitivity or when a sensitivity is automatically set in a dark place.

NTSC (National Television System Committee)

A video color encoding standard used most commonly in Japan, North America, the Philippines, South America, South Korea, and Taiwan.

Optical zoom

This is a general zoom which can enlarge images with a lens and does not deteriorate quality of images.

PAL (Phase Alternate Line)

A video color encoding standard used in numerous countries throughout Africa, Asia, Europe, and the Middle East.

Quality

An expression of the rate of compression used in a digital image. Higher quality images have a lower rate of compression, which usually results in a larger file size.

RAW (Sensor raw data)

The original, unprocessed data, collected directly from the camera's image sensor. White Balance, contrast, saturation, sharpness, and other data can be manipulated with editing software before the image is compressed into a standard file format.

Resolution

The number of pixels present in a digital image. High resolution images contain more pixels and typically show more detail than low resolution images.

Shutter speed

Shutter speed refers to the amount of time it takes to open and close the shutter, and it is an important factor in the brightness of a photo, as it controls the amount of light which passes through the aperture before it reaches the image sensor. A fast shutter speed allows less time to let light in and the photo becomes darker and more easily freezes subjects in motion.

sRGB (Standard RGB)

International standard of color space established by the IEC (International Electrotechnical Commission). This is defined from color space for PC monitors and is also used as the standard color space for Exif.

Vignetting

A reduction of an image's brightness or saturation at the periphery (outer edges) compared to the center of the image. Vignetting can draw interest to subjects positioned in the center of an image.

White Balance (Color balance)

An adjustment of the intensities of colors (typically the primary colors red, green, and blue), in an image. The goal of adjusting the White Balance, or color balance, is to correctly render the colors in an image.

Wi-Fi

Wi-Fi is a technology that allows electronic devices to exchange data wirelessly over a network.

WPS (Wi-Fi Protected Setup)

WPS is a technology that secures wireless home networks.

Optional accessories

Lens



SAMSUNG 18-55 mm
F3.5-5.6 OIS III



SAMSUNG 20-50 mm
F3.5-5.6 ED II

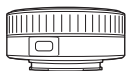

SAMSUNG 16 mm F2.4

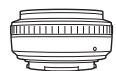

SAMSUNG 20 mm F2.8

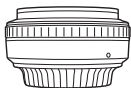

SAMSUNG 30 mm F2

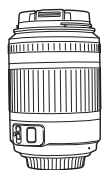

SAMSUNG 50-200 mm
F4-5.6 ED OIS II



SAMSUNG 60 mm F2.8
Macro ED OIS SSA

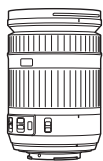

SAMSUNG 18-200 mm
F3.5-6.3 ED OIS

Lens

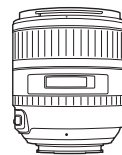

SAMSUNG 85 mm F1.4 ED SSA

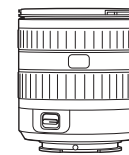

SAMSUNG 12-24 mm F4-5.6 ED



SAMSUNG 45 mm F1.8

External flash

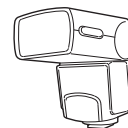

SEF42A

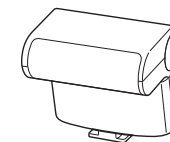



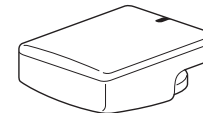

SEF220A

GPS

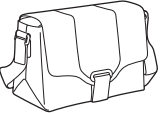

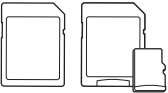
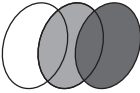
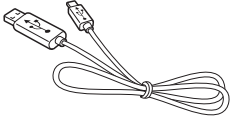
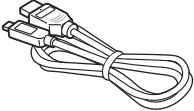
GPS10

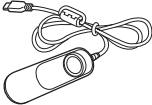
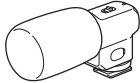
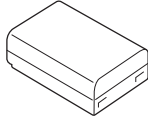
Other accessories	
	<p>Camera bag You can purchase the camera bag separately.</p>
	<p>Camera case You can purchase the camera case separately.</p>
	<p>Memory card This product supports SD (Secure Digital), SDHC (Secure Digital High Capacity), SDXC (Secure Digital eXtended Capacity), microSD, microSDHC, or microSDXC memory cards.</p>
	<p>Filter You can create different colored effects by attaching filters to your lens.</p>
	<p>USB cable You can purchase additional USB cables.</p>
	<p>HDMI cable You can view high-definition photos and videos by connecting the camera to an HDMI-compatible monitor with the HDMI (HDMI type D) cable.</p>

Other accessories	
	<p>Shutter release (micro USB type) Shutter release reduces shakiness when used with a tripod.</p>
	<p>Microphone Microphone picks up the subject's sound more clearly when you record a video with the zoom function.</p>
	<p>Strap You can additionally purchase the straps.</p>
	<p>Battery pack You can purchase additional battery packs.</p>
	<p>Quick battery charger You can purchase an optional quick battery charger.</p>



- These illustrations may differ from your actual items. Refer to the user manuals of these optional accessories for details.
- Use only Samsung-approved accessories. Samsung is not responsible for damage caused by using another manufacturer's accessories.

A

- Adobe Photoshop Lightroom 146
- Aperture 14, 18
- Auto Backup 117
- Auto focus 65
- AutoShare 106

B

- Battery
 - Life 156
 - Specifications 155
- Bracketing 72, 74

C

- Camera
 - Connecting as removable disk 140
 - Connecting to PC 140
 - Disconnecting (Windows) 141
 - Layout 28
- Color space 84
- Custom button 128

D

- Depth of Field (DOF) 15, 20
- Digital Print Order Format (DPOF) 138
- Drive (see Shooting method) 72

E

- E-mail 113
- Exposure Value (EV) 15, 85

F

- Fader 88
- Files
 - Deleting 92
 - Photo format 59
 - Protecting 92
 - Transferring to Mac 141
 - Transferring to PC 140
 - Video format 59

Flash

- Bounce photography 25
- Flash options 76
- Guide number 24
- Intensity 77

- F-number 15

- Focal length 19

G

- Glossary 165

I

- i-Function 48
- Intelli-Studio 143
- ISO sensitivity 17, 18, 60
- i-Zoom 49

L

- Lenses

- Locking 35
- Markings 37
- Unlocking 35

M

- Maintenance 149
- Memory card 152
- Metering 79
- MF assist 70

O

- Optical Image Stabilization (OIS) 71
- Optional accessories
 - Attach the GPS module 41
 - Flash layout 38
 - GPS module layout 41

P

Photos

- Editing 98
- Enlarging 94
- Shooting options 57
- Viewing on 3D TV 136
- Viewing on camera 90
- Viewing on HDTV 135

Photo styles 64

PictBridge 137

Picture Wizard 64

Posture 13

R

Red-eye effect 77

Remote Viewfinder 109

Rule of thirds 22

S

Shooting method 72

Shooting modes

- Aperture Priority 45
- Lens Priority 47
- Manual 46
- Movie 54
- Program 44
- Scene 51
- Shutter Priority 45
- Smart Auto 43

Shutter speed 16, 18

Slide show 94

SMART LINK button 30

Smart Range 82

T

Timer 73

TV Link 119

V

Videos

- Options 87
- Viewing 96

W

Wireless network 101

3

3D Shot 53



**Correct Disposal of This Product
(Waste Electrical & Electronic Equipment)**

(Applicable in the European Union and other European countries with separate collection systems)

This marking on the product, accessories or literature indicates that the product and its electronic accessories (e.g. charger, headset, USB cable) should not be disposed of with other household waste at the end of their working life. To prevent possible harm to the environment or human health from uncontrolled waste disposal, please separate these items from other types of waste and recycle them responsibly to promote the sustainable reuse of material resources. Household users should contact either the retailer where they purchased this product, or their local government office, for details of where and how they can take these items for environmentally safe recycling. Business users should contact their supplier and check the terms and conditions of the purchase contract. This product and its electronic accessories should not be mixed with other commercial wastes for disposal.



Correct disposal of batteries in this product

(Applicable in the European Union and other European countries with separate battery return systems)

This marking on the battery, manual or packaging indicates that the batteries in this product should not be disposed of with other household waste at the end of their working life. Where marked, the chemical symbols Hg, Cd or Pb indicate that the battery contains mercury, cadmium or lead above the reference levels in EC Directive 2006/66. If batteries are not properly disposed of, these substances can cause harm to human health or the environment.

To protect natural resources and to promote material reuse, please separate batteries from other types of waste and recycle them through your local, free battery return system.

CAN ICES-3 (B)/NMB-3(B)

Dispose unwanted electronics through an approved recycler.
To find the nearest recycling location, go to our website:
www.samsung.com/recyclingdirect Or call, (877) 278 - 0799

FCC notice

Caution:

Any changes or modifications in construction of this device which are not expressly approved by the party responsible for compliance could void the user's authority to operate the equipment.

NOTE:

This equipment has been tested and found to comply with the limits for a Class B digital device, pursuant to part 15 of the FCC Rules. These limits are designed to provide reasonable protection against harmful interference in a residential installation. This equipment generates, uses and can radiate radio frequency energy and, if not installed and used in accordance with the instructions, may cause harmful interference to radio communications. However, there is no guarantee that interference will not occur in a particular installation. If this equipment does cause harmful interference to radio or television reception, which can be determined by turning the equipment off and on, the user is encouraged to try to correct the interference by one or more of the following measures:

- Reorientate, or relocate, the receiving antenna.
- Increase the distance between the equipment and receiver.
- Connect the equipment into an outlet on a circuit different from that to which the receiver is connected.
- Consult the dealer or an experienced radio/TV technician for help.

Declaration of Conformity

Trade Name : Samsung Electronics America, Inc.

Model No. : Samsung NX1100

Responsible Party : Samsung Electronics America, Inc.

Address : 85 Challenger Road, Ridgefield Park, NJ 07660

Telephone No. : 1-800-SAMSUNG (726-7864)

This device complies with Part 15 of the FCC Rules.

Operation is subject to the following two conditions:

(1) This device may not cause harmful interference, and (2) this device must accept any interference received, including interference that may cause undesired operation.



FCC ID:A3LNX1100

This device complies with part 15 of the FCC Rules. Operation is subject to the following two conditions: (1) This device may not cause harmful interference, and (2) this device must accept any interference received, including interference that may cause undesired operation.

RF exposure statements:

This device is for handheld operation only. The antenna(s) used for this transmitter must be installed to provide a separation distance of at least 20 cm from all persons and must not be co-located or operating in conjunction with any other antenna or transmitter.

CAUTION

RISK OF EXPLOSION IF BATTERY IS REPLACED BY
AN INCORRECT TYPE.
DISPOSE OF USED BATTERIES ACCORDING
TO THE INSTRUCTIONS

Operation is subject to the following two conditions:

- (1) This device may not cause harmful interference, and
- (2) This device must accept any interference received, including interference that may cause undesired operation.

Caution:

Any changes or modifications to the equipment not expressly approved by the party responsible for compliance could void user's authority to operate the equipment.

IC: 649E-NX1100

This equipment may be operated in all EU countries.
In France, this equipment may only be used indoors.



Declaration of Conformity

Product details

For the following

Product : DIGITAL CAMERA

Model(s) : NX1100

CE 0678

and the Directive (2011/65/EU) on the restriction of the use of certain hazardous substances in electrical and electronic equipment and the Eco-Design Directive (2009/125/EC) implemented by Regulations (EC) No 278/2009 for external power supplies.

Declaration & Applicable standards

We hereby declare, that the product above is in compliance with the essential requirements of the R&TTE Directive (1999/5/EC) by application of:

EN 60950-1:2006+A11:2009+A1:2010+A12:2011	EN 55024:1998+A1:2001+A2:2003
EN 55022:2006+A1 :2007	EN 61000-3-2:2006 +A1:2009 +A2:2009
EN 61000-3-3:2008	EN 300 328 v1.7.1
EN 301 489-1 v1.8.1	EN 301 489-17 V2.1.1
EN62311 :2008	

Representative in the EU

Samsung Electronics Euro QA Lab. (YEAR TO BEGIN AFFIXING CE MARKING 2013)
Blackbushe Business Park
Saxony Way, Yateley, Hampshire
GU46 6GG, UK

8 February 2013
(Place and date of issue)

Joong-Hoon Choi / Lab. Manager
(Name and signature of authorized person)

* This is not the address of Samsung Service Centre. For the address or the phone number of Samsung Service Centre, see the warranty card or contact the retailer where you purchased your product.

Declaration sentence in official languages

Nation	Declaration
Cesky	Samsung Electronics tímto prohlašuje, že tento digitální fotoaparát je ve shodě se základními požadavky a dalšími příslušnými ustanoveními směrnice 1999/5/ES.
Dansk	Samsung Electronics erklærer herved, at digitale kameraer overholder de væsentlige krav og øvrige relevante krav i direktiv 1999/5/EF.
Deutsch	Hiermit erklärt Samsung Electronic, dass sich die Digitalkamera in Übereinstimmung mit den grundlegenden Anforderungen und den übrigen einschlägigen Bestimmungen der Richtlinie 1999/5/EG befindet.
Eesti	Käesolevaga kinnitab Samsung Electronics digitaalkamera vastavust direktiivi 1999/5/EÜ põhinõuetele ja nimetatud direktiivist tulenevatele teistele asjakohastele sätetele.
English	Hereby, Samsung Electronics declares that this digital camera is in compliance with the essential requirements and other relevant provisions of Directive 1999/5/EC.
Español	Por medio de la presente Samsung Electronics declara que la cámara digital cumple con los requisitos esenciales y cualesquiera otras disposiciones aplicables o exigibles de la Directiva 1999/5/CE.
Ελληνική	ΜΕ ΤΗΝ ΠΑΡΟΥΣΑ η Samsung Electronics ΔΗΛΩΝΕΙ ΟΤΙ η ψηφιακή φωτογραφική μηχανή ΣΥΜΜΟΡΦΩΝΕΤΑΙ ΠΡΟΣ ΤΙΣ ΟΥΣΙΩΔΕΙΣ ΑΠΑΙΤΗΣΕΙΣ ΚΑΙ ΤΙΣ ΛΟΙΠΕΣ ΣΧΕΤΙΚΕΣ ΔΙΑΤΑΞΕΙΣ ΤΗΣ ΟΔΗΓΙΑΣ 1999/5/EK.
Français	Par la présente Samsung Electronic déclare que l'appareil photo numérique est conforme aux exigences essentielles et aux autres dispositions pertinentes de la directive 1999/5/CE.
Italiano	Con la presente Samsung Electronicsdichiara che questa fotocamera digitale è conforme ai requisiti essenziali e alle altre disposizioni stabilite dalla Direttiva 1999/5/CE.
Latviski	Ar šo Samsung Electronics deklarē, ka digitālā kamera atbilst Direktīvas 1999/5/EK būtiskajām prasībām un citiem ar to saistītajiem noteikumiem.
Lietuvių	Šiuo Samsung Electronics deklaruoja, kad šis skaitmeninis fotoaparatas, atitinka esminius reikalavimus ir kitas 1999/5/EB Direktyvos nuostatas.
Nederlands	Hierbij verklaart Samsung Electronics dat de digitale camera in overeenstemming is met de essentiële eisen en de andere relevante bepalingen van richtlijn 1999/5/EG.
Malti	Hawnhekk, Samsung Electronics, tiddikjara li din il-kamera digitali hi konformi mar-reqwiżiti essenzjali u ma' dispożizzjonijiet rilevanti oħrajn ta' Direttiva 1999/5/KE.

Nation	Declaration
Magyar	A Samsung Electronics kijelenti, hogy ez a digitális fényképezőgép megfelel az 1999/5/EK irányelv alapvető követelményeinek és egyéb vonatkozó előírásainak.
Polski	Niniejszym firma Samsung Electronics oświadcza, że ten aparat cyfrowy jest zgodny z zasadniczymi wymogami oraz pozostałymi stosownymi postanowieniami Dyrektywy 1999/5/WE.
Português	Samsung Electronics declara que esta câmara digital está conforme os requisitos essenciais e outras disposições da Directiva 1999/5/CE.
Slovensko	Samsung Electronics izjavlja, da je ta digitalni fotoaparát v skladu z bistvenimi zahtevami in ostalimi relevantnimi določili direktive 1999/5/ES.
Slovensky	Samsung Electronics týmto vyhlasuje, že tento digitálny fotoaparát spĺňa základné požiadavky a všetky príslušné ustanovenia Smernice 1999/5/ES.
Suomi	Samsung Electronics vakuuttaa täten että tämä digitaalikamera on direktiivin 1999/5/EY oleellisten vaatimusten ja sitä koskevien direktiivin muiden ehtojen mukainen.
Svenska	Härmed intygar Samsung Electronicsatt dessa digitalkameror står i överensstämmelse med de väsentliga egenskapskrav och övriga relevanta bestämmelser som framgår av direktiv 1999/5/EG.
Български	С настоящото Samsung Electronics декларира, че този цифров фотоапарат е в съответствие със съществените изисквания и другите приложими разпоредби на Директива 1999/5/EK.
Română	Prin prezenta, Samsung Electronics, declară că această cameră foto digitală este în conformitate cu cerințele esențiale și alte prevederi relevante ale Directivei 1999/5/CE.
Norsk	Samsung Electronicserklærer herved at dette digitalkameraet er i samsvar med de grunnleggende krav og øvrige relevante krav i direktiv 1999/5/EF.
Türkiye	Bu belge ile, Samsung Electronics bu dijital kameranın 1999/5/EC Yönetmeliğinin temel gerekliliklerine ve ilgili hükümlerine uygun olduğunu beyan eder.
Íslenska	Hér með lýsir Samsung Electronics því yfir að þessi stafræna myndavél sé í samræmi við grunnkröfur og önnur ákvæði tilskipunar 1999/5/EB.



Please refer to the warranty that came with your product
or visit our website www.samsung.com for after-sales service or inquiries.

CE 0678