

ideapad 510S-13ISK

User Guide



Read the safety notices and important tips in the included manuals before using your computer.

Lenovo™

Notes

- Before using the product, be sure to read *Lenovo Safety and General Information Guide* first.
- The latest electronic compliance and environmental information are available from the Lenovo compliance information Web sites.
 - To view compliance information go to: <http://www.lenovo.com/compliance>
 - To download environmental information go to: <http://www.lenovo.com/ecodeclaration>
- Some instructions in this guide may assume that you are using Windows® 10. If you are using another Windows operating system, some operations may be slightly different. If you are using other operating systems, some operations may not apply to you.
- The features described in this guide are common to most models. Some features may not be available on your computer or your computer may include features that are not described in this user guide.
- The illustrations in this manual may differ from the actual product. Please refer to the actual product.

Regulatory Notice

- For details, refer to **Guides & Manuals** at <http://support.lenovo.com>.

First Edition (April 2016)

© Copyright Lenovo 2016.

LIMITED AND RESTRICTED RIGHTS NOTICE: If data or software is delivered pursuant to a General Services Administration "GSA" contract, use, reproduction, or disclosure is subject to restrictions set forth in Contract No. GS-35F-05925.

Contents

Chapter 1. Getting to know your computer	1
Top view.....	1
Left-side view.....	5
Right-side view.....	8
Bottom view.....	11
Chapter 2. Starting to use Windows 10	12
Configuring the operating system for the first time.....	12
Operating system interfaces.....	12
Putting the computer to sleep or shutting it down.....	15
Connecting to a wireless network.....	17
Get help from Windows.....	18
Chapter 3. Lenovo OneKey Recovery system	19
Chapter 4. Troubleshooting	20
Frequently asked questions.....	20
Troubleshooting.....	22
Trademarks	25

Chapter 1. Getting to know your computer

■ ■ Top view

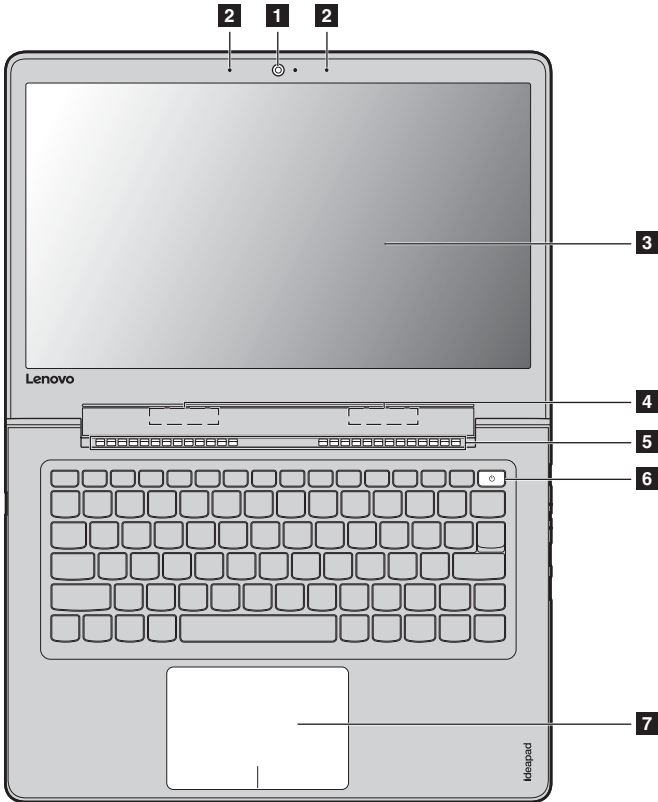

Note: The dashed areas indicate parts that are not visible externally.

⊙ Attention:

- Do not open the display panel beyond 180 degrees. When closing the display panel, be careful *not* to leave pens or any other objects in between the display panel and the keyboard. Otherwise, the display panel may be damaged.

Chapter 1. Getting to know your computer

- 1 Integrated camera** Use the camera for video communication.
- 2 Built-in microphone** Captures sound which can be used for video conferencing, voice narration, or audio recording.
- 3 Computer display** The computer display with LED backlight provides brilliant visual output.
- 4 Wireless LAN antennas** Connect to a wireless LAN adapter to send and receive wireless radio signals.
- 5 Ventilation slots** Dissipate internal heat.

Note: Make sure that the ventilation slots are not blocked or else the computer may overheat.

- 6 Power key** Press this Key to turn on the computer.
- 7 Touchpad** The touchpad functions as a conventional mouse.

Touchpad: To move the pointer on the screen, slide your fingertip over the pad in the direction in which you want the pointer to move.

Touchpad buttons: The functions of the left/right side correspond to that of the left/right mouse button on a conventional mouse.

Note: You can enable/disable the touchpad by pressing **F6** ()

■ Using the keyboard

Function key combinations

Through the use of the function keys, you can change operational features instantly. To use this function, press and hold **Fn** **1**; then press one of the function keys **2**.

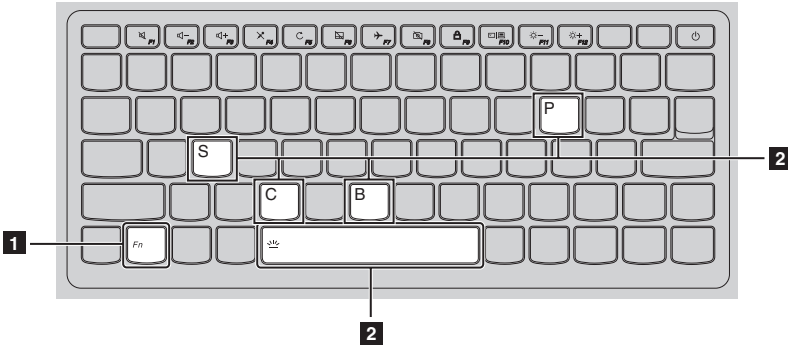

The following describes the features of each function key.

Fn + B: Activates the break function.

Fn + P: Activates the pause function.

Fn + C: Enables/disables the scroll lock.

Fn + S: Activate the system request.

Fn + Space
(on select models): Adjusts the keyboard backlight.

Default status: off

Operation	Backlight status	Backlight brightness
Press for the first time	On	The backlight brightness range reaches 50%.
Press for the second time	On	The backlight brightness range reaches 100%.
Press for the third time	Off	

Chapter 1. Getting to know your computer

Hotkeys

You can access certain system settings quickly by pressing the appropriate hotkeys.

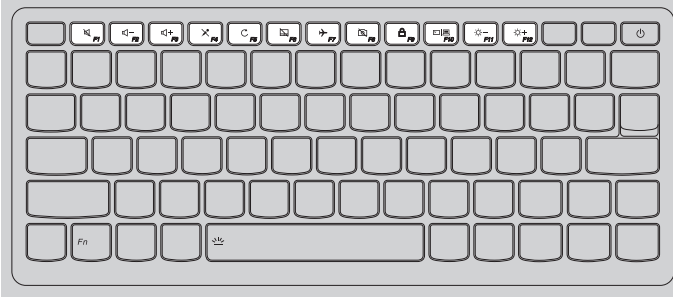

: Mutes/unmutes the sound.



: Enables/disables Airplane mode.



: Decreases the volume level.



: Enables/disables the camera.



: Increases the volume level.



: Locks/unlocks the currently active window.



: Enables/disables the microphone.



: Toggles the display between the computer and an external device.



: Refreshes the desktop or the currently active window.



: Decreases the display brightness.



: Enables/disables the touchpad.



: Increases the display brightness.

Setting hotkey mode

By default, the hotkey functions are accessible by pressing the appropriate hotkey. However, you can disable the hotkey mode in the BIOS setup utility.

To disable the hotkey mode:

- 1 Shut down the computer.
- 2 Press the Novo button and then select **BIOS Setup**.
- 3 In the BIOS setup utility, open the **Configuration** menu, and change the setting of **HotKey Mode** from **Enabled** to **Disabled**.
- 4 Open the **Exit** menu, and select **Exit Saving Changes**.

Note: When hotkey mode is disabled, press the **Fn** key and the appropriate hotkey to access the corresponding hotkey function.

Left-side view

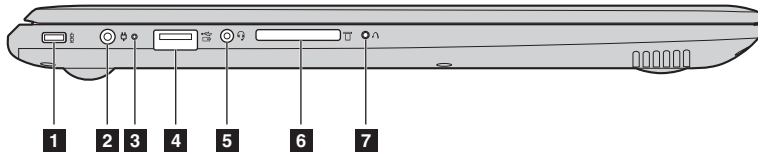

- 1 Kensington Mini Security slot** For attaching a Kensington MiniSaver™ Mobile (or compatible) lock. Attach a security lock (not supplied) here to help protect your computer from theft and unauthorized use. You can attach a security lock to your computer to help prevent it from being removed without your permission. For details on installing the security lock, please refer to the instructions shipped with the security lock that you have purchased.

Notes:

- Lock is not supplied. When purchasing a lock, choose one that utilizes the Cleat™ locking mechanism and verify its compatibility with the slot before purchase. A lock utilizing the T-Bar™ locking mechanism is not compatible with the Kensington Mini Security slot.
- Before purchasing any security product, verify that it is compatible with this type of security keyhole.
- You are responsible for evaluating, selecting, and implementing the locking devices and security features. Lenovo offers no comment, judgment, or warranty regarding the function, quality, or performance of locking devices and security features.

- 2 AC power adapter jack** Connects to the AC power adapter.

- 3 Battery/Charging status indicator**

AC power adapter status	Indicator status	Meaning
Disconnected	Off	The computer is in sleep mode or turned off; The battery has more than 20% charge.
	Solid amber	The battery has between 5% and 20% charge.
	Fast blinking amber	The battery has between 1% and 5% charge.
Connected	Slow blinking amber	The battery is being charged. When battery charge reaches 20%, the blinking color changes to white.
	Slow blinking white	The battery has between 20% and 80% charge and is still charging. When the battery reaches 80% charge the light will stop blinking.
	Solid white	The battery has more than 80% charge, charging will continue until the battery is fully charged.

Chapter 1. Getting to know your computer

4 USB 2.0 port Connects to USB devices.

Notes:

- If the battery charge is more than 20%, the USB port with a  mark supports charging of an external USB device, even when the computer is not connected to power.
- For details, see “Connecting USB device” on page 9.

5 Combo audio jack Connects to headsets.

Notes:

- The combo audio jack does not support conventional microphones.
- The recording function might not be supported if third-party headphones or headsets are connected, due to different industry standards.

6 Memory card slot Insert memory cards (not supplied) here.

Note: For details, see “Using memory cards (not supplied)” on page 7.

7 Novo button When the computer is off, press this button to start the Lenovo OneKey Recovery system or the BIOS setup utility, or to enter the boot menu.

Notes:

- You can use the tip of an unfolded paper clip (or similar object without a sharp tip) to gently press the Novo button.
- For details, see “Lenovo OneKey Recovery system” on page 19.

■ Using memory cards (not supplied)

Your computer supports the following types of memory cards:

- Secure Digital (SD) card
- Secure Digital High Capacity (SDHC) card
- Secure Digital eXtended Capacity (SDXC) card
- MultiMediaCard (MMC)

Notes:

- Insert *only* one card in the slot at a time.
- This card reader does not support SDIO devices (e.g., SDIO Bluetooth, etc.).

Inserting a memory card

Insert the memory card until it touches the bottom of the slot.

Removing a memory card

Gently pull the memory card out of the memory card slot.

Note: Before removing the memory card, disable it by using the Windows safely remove hardware and eject media utility to avoid data corruption.

Right-side view

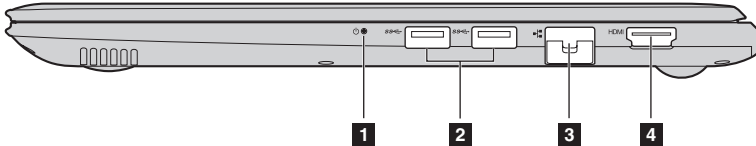

1 Power status indicator

Indicator	Indicator status	Meaning
Power status indicator	On (solid white)	The computer is powered on.
	Blinking	The computer is in sleep mode.
	Off	The computer is powered off.

2 USB 3.0 port Connect to USB devices.

Notes:

- When the computer is on, the USB port supports charging function.
- For details, see “Connecting USB device” on page 9.

3 RJ-45 port Connects the computer to an Ethernet network.

Note: For details, see “Connecting network cables” on page 10.

4 HDMI port Connects to devices with HDMI input such as a TV or an external display.

■ Connecting USB device

Your computer comes with three USB ports compatible with USB devices.

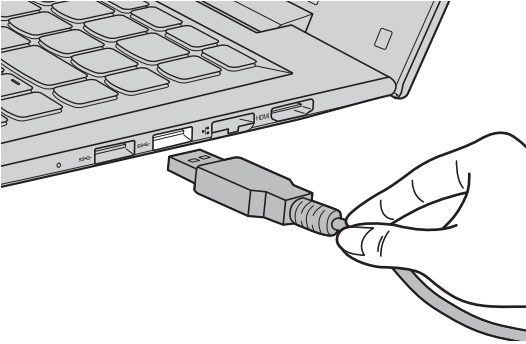

The first time you plug a USB device into a particular USB port on your computer, Windows automatically installs a driver for that device. After the driver has been installed, you can disconnect and reconnect the device without performing any additional steps.

Note: Typically, Windows detects a new device after it has been connected, and then installs the driver automatically. However, some devices may require you to install the driver before connecting. Check the documentation provided by the device's manufacturer before connecting the device.

Before disconnecting a USB storage device, make sure your computer has finished transferring data to that device. Click the **Safely Remove Hardware and Eject Media** icon in the Windows notification area to remove the device before disconnecting.

Note: If your USB device uses a power cord, connect the device to a power source before connecting it. Otherwise, the device may not be recognized.

Chapter 1. Getting to know your computer

■ Connecting network cables

To insert a network cable, do the following:

- 1 Hold one connector of the network cable to press the RJ-45 cover down gently **1**.
- 2 Insert the connector into the RJ-45 port **2**.

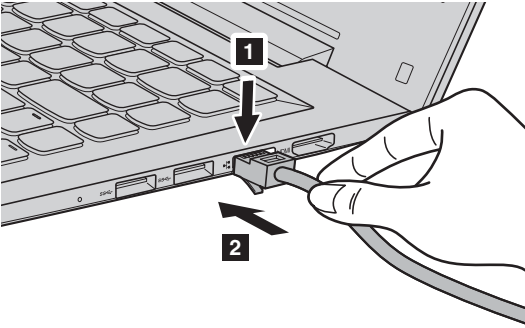

Software configuration

Consult your Internet Service Provider (ISP) for details on how to configure your computer.

■ ■ Bottom view

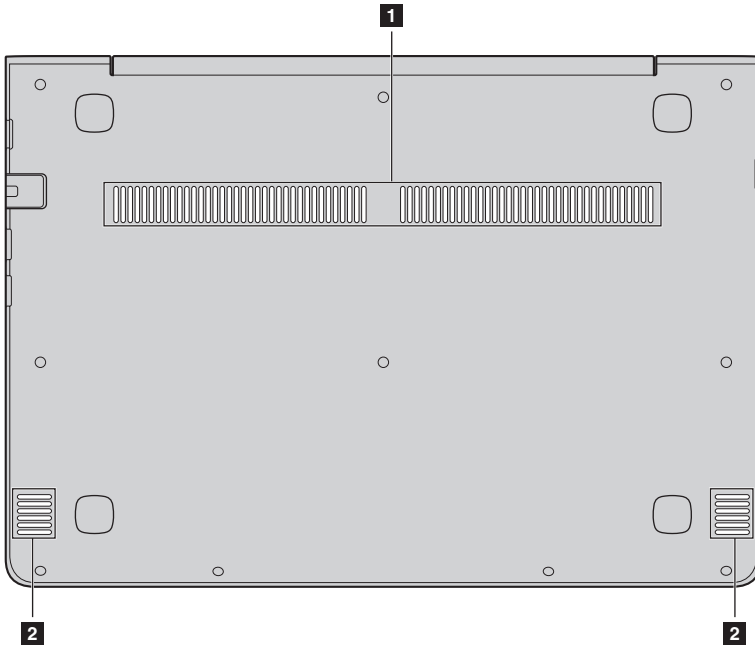

1 Louvers

Allow air to enter the computer for cooling.

2 Speakers

Provide audio output.

Chapter 2. Starting to use Windows 10

■ ■ Configuring the operating system for the first time

You may need to configure the operating system when it is first used. The configuration process may include the procedures below:

- Accepting the end user license agreement
- Configuring the Internet connection
- Registering the operating system
- Creating a user account

■ ■ Operating system interfaces

The return of the Start menu

If you click the Start button in the lower-left corner, the Start menu is displayed. To open the start menu, do one of the following:

- Select the Start button in the lower-left corner, the Start menu is displayed.
- Press the Windows button.
- Press the Windows key  on the keyboard.

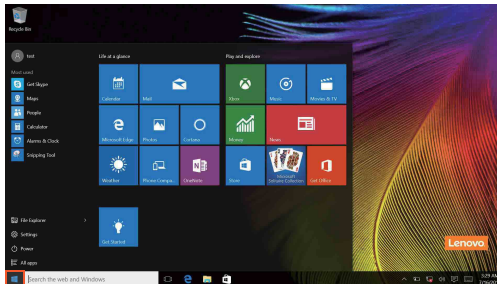

The power button is on the Start menu, select it you can choose to shut down or restart the computer, or put the computer into sleep mode.

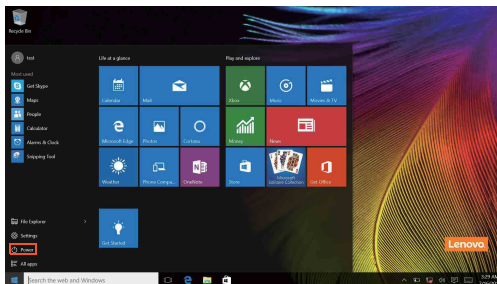

Through the Start menu, you can locate all the installed apps or view the frequently used apps.

The ACTION CENTER

Select the ACTION CENTER icon  on the taskbar and the ACTION CENTER is displayed.

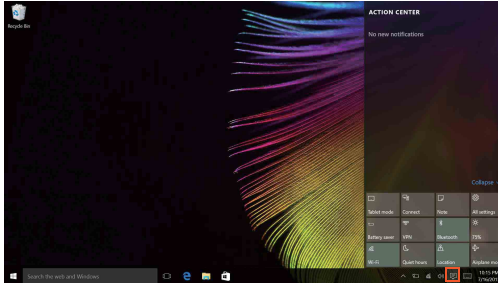

From the ACTION CENTER, you can examine important notifications from Windows and your apps. Moreover, you can change common settings quickly.

Task View in taskbar

In Windows 10, you can add a new desktop and switch between different desktops. To add a new desktop, do the following:

- Select the Task View icon  in the taskbar area.

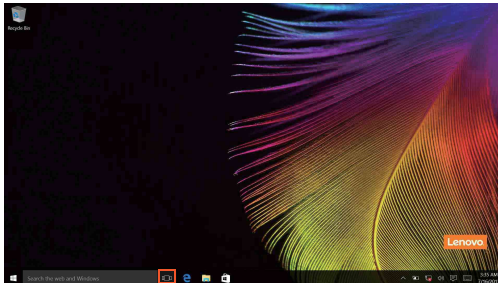

Chapter 2. Starting to use Windows 10

- Select **New desktop**.

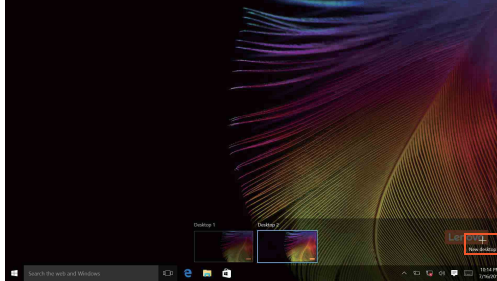

To switch between desktops, select the Task View icon , then select your desired desktop.

Also, you can manage apps in the multi-tasking view:

- 1 Select the Task View button to display all apps in use on the screen.
- 2 Select to enter the apps or close the apps.

■ ■ Putting the computer to sleep or shutting it down

When you have finished working with your computer, you can put it to sleep or shut it down.

■ Putting your computer to sleep

If you will be away from your computer for only a short time, put the computer to sleep. When the computer is in sleep mode, you can quickly wake it to resume use, bypassing the startup process.

To put the computer to sleep, do one of the following:

- Close the display lid.
- Press the power button.
- Select the Start button, then select **Power**  → **Sleep**.

Note: Put your computer to sleep before you move it. Moving your computer while the hard disk drive is spinning can damage the hard disk, causing loss of data.

To wake the computer, do one of the following:

- Press any key on the keyboard.
- Press the power button.
- Press the Windows button.

■ Shutting down the computer

If you are not going to use your computer for a long time, shut it down.

To shut down your computer, do one of the following:

- Select the Start button, then select **Power**  → **Shut down**.



Chapter 2. Starting to use Windows 10

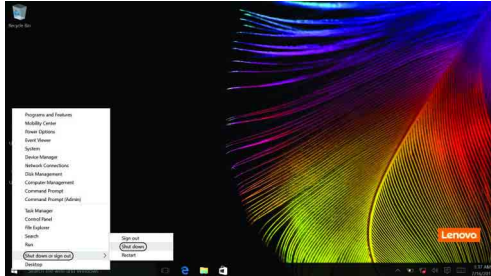

- Right-click or press the Start button in the lower-left corner and select **Shut down or sign out** → **Shut down**.



■ ■ Connecting to a wireless network

Enabling wireless connection

To enable wireless functions, do one of the following:

- Click the ACTION CENTER icon  in the notification area, and then deselect **Airplane mode**.
- Press  to disable airplane mode.
- Click **Settings**  → **Network & Internet** → **Airplane mode** to open the network configuration page. Then toggle the airplane mode switch to **Off**.

Connecting to a wireless network

After wireless has been enabled, the computer will automatically scan for available wireless networks and display them in the wireless network list. To connect to a wireless network, click the network name in the list, and then click **Connect**.

Note: Some networks require a network security key or passphrase for connection. To connect to one of those networks, ask the network administrator or the Internet service provider (ISP) for the security key or passphrase.

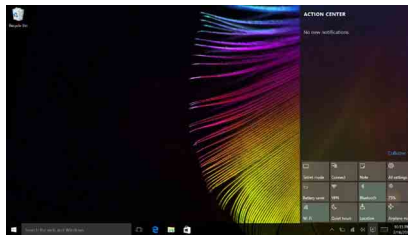

■ ■ Get help from Windows

If you have a problem with the operating system, see the Windows Get Started app. To open it, do the following:

- Move the cursor to the lower-left corner, and then select the Start button. Select **Get Started** from **All apps**.

Chapter 3. Lenovo OneKey Recovery system

The Lenovo OneKey Recovery system is software designed to back up and restore your computer. You can use it to restore the system partition to its original status in case of a system failure. You can also create user backups for easy restoration as required.

Notes:

- If your computer is preinstalled with a GNU/Linux operating system, OneKey Recovery system is not available.
- To utilize the features of the OneKey Recovery system, your hard disk already includes a hidden partition by default to store the system image file and the OneKey Recovery system program files. This default partition is hidden for security reasons, which explains why the available disk space is less than the stated capacity.

■ Backing up the system partition

You can back up the system partition to an image file. This image file can be used to restore the system partition. To back up the system partition:

- ① In Windows, press the Novo button or double-click OneKey Recovery icon to start the Lenovo OneKey Recovery system.
- ② Click **System Backup**.
- ③ Select a back-up location and click **Next** to start the backup.

Notes:

- You can choose a back-up location on the local hard disk drive or an external storage device.
- Remove the removable hard disk drive before starting the Lenovo OneKey Recovery system. Otherwise, data from the removable hard disk drive might be lost.
- The back-up process may take a while.
- The back-up process is only available when Windows can be started normally.

■ Restoring

You can choose to restore the system partition to its original status or to a previously created back-up point. To restore the system partition:

- ① In Windows, press the Novo button or double-click OneKey Recovery icon to start the Lenovo OneKey Recovery system.
- ② Click **System Recovery**. The computer will restart to the recovery environment.
- ③ Follow the on-screen instructions to restore the system partition to its original status or to a previously created back-up point.

Notes:

- The recovery process is irreversible. Make sure to back up any data you wish to save on the system partition before starting the recovery process.
- The recovery process may take a while. So be sure to connect the AC power adapter to your computer during the recovery process.
- The above instructions should be followed when Windows can be started normally.

If Windows cannot be started, then follow the steps below to start the Lenovo OneKey Recovery system:

- ① Shut down the computer.
- ② Press the Novo button. From **Novo Button Menu**, select **System Recovery** and press Enter.

Chapter 4. Troubleshooting

■ ■ Frequently asked questions

This section lists frequently asked questions by category.

■ Finding information

What safety precautions should I follow when using my computer?

The Lenovo *Safety and General Information Guide* which came with your computer contains safety precautions for using your computer. Read and follow all the precautions when using your computer.

Where can I find the hardware specifications for my computer?

You can find the hardware specification for your computer on the printed flyers which came with your computer.

Where can I find warranty information?

For detailed warranty information on this machine, please visit below website to check out: support.lenovo.com/warrantystatus.

■ Drivers and preinstalled software

Where are the installation discs for Lenovo preinstalled software (desktop software)?

Your computer did not come with installation discs for Lenovo preinstalled software. If you need to reinstall any preinstalled software, you can find the installation program on the D partition of your hard disk (for select models, on the C partition). If you cannot find the installation program there, you can also download it from the Lenovo consumer support website.

Where can I find drivers for the various hardware devices of my computer?

If your computer is preinstalled with a Windows operating system, Lenovo provides drivers for all the hardware devices that you need on the D partition of your hard disk (for select models, on the C partition). You can also download the latest device drivers from the Lenovo consumer support website.

■ Lenovo OneKey Recovery system

Where are the recovery discs?

Your computer did not come with any recovery discs. Use the Lenovo OneKey Recovery system if you need to restore the system to its original factory status.

What can I do if the back-up process fails?

If you can start the backup but it fails during the back-up process, try the following steps:

- 1 Close all open programs, and then restart the back-up process.
- 2 Check to see if the destination media is damaged. Select another path and then try again.

When do I need to restore the system to its factory status?

Use this feature when the operating system fails to start up. If there is critical data on the system partition, back it up before starting recovery.

■ BIOS setup utility

What is the BIOS setup utility?

The BIOS setup utility is a ROM-based software. It displays basic computer information and provides options for setting boot devices, security, hardware mode, and other preferences.

How can I start the BIOS setup utility?

To start the BIOS setup utility:

- ❶ Shut down the computer.
- ❷ Press the Novo button and then select **BIOS Setup**.

How can I change the boot mode?

There are two boot modes: **UEFI** and **Legacy Support**. To change the boot mode, start the BIOS setup utility and set boot mode to **UEFI** or **Legacy Support** on the boot menu.

When do I need to change the boot mode?

The default boot mode for your computer is **UEFI** mode. If you need to install a legacy operating system, such as Windows, Linux or Dos, etc. (that is, any operating system before Windows 8) on your computer, you must change the boot mode to **Legacy Support**. The legacy operating system, such as Windows, Linux or Dos, etc. cannot be installed if you don't change the boot mode.

■ Getting help

How can I contact the customer support center?

See “Chapter 3. Getting help and service” in the *Lenovo Safety and General Information Guide*.

■ ■ Troubleshooting

Display problems

When I turn on the computer, nothing appears on the screen.

- If the screen is blank, make sure that:
 - The AC power adapter is connected to the computer, and the power cord is plugged into a working electrical outlet.
 - The computer power is on. Press the Power button again for confirmation.
- If these items are properly set, and the screen remains blank, have the computer serviced.

When I turn on the computer, only a white cursor appears on a blank screen.

- Restore backed-up files to your Windows environment or the entire contents of your hard disk to its original factory contents using the Lenovo OneKey Recovery system. If you still see only the cursor on the screen, have the computer serviced.

The screen goes blank while the computer is on.

- Your screen saver or power management may be enabled. Do one of the following to resume from sleep mode:
 - Press any key on the keyboard.
 - Press the Power button.

Sleep problems

The critical low-battery error message appears, and the computer immediately turns off.

- The battery power is getting low. Connect the AC power adapter to the computer.

The computer enters sleep mode immediately after Power-on self-test (POST).

- Make sure that:
 - The battery pack is charged.
 - The operating temperature is within the acceptable range. See “Chapter 2. Use and care Information” in the *Lenovo Safety and General Information Guide*.

Note: If the battery pack is charged and the temperature is within range, have the computer serviced.

The computer does not return from sleep mode, and the computer does not work.

- If your computer is in sleep mode, connect the AC power adapter to the computer, then press the Power button.
- If the system still does not return from sleep mode, stops responding, or cannot be turned off, reset the computer. Unsaved data may be lost. To reset the computer, press and hold the Power button for five seconds or more. If the computer is still not reset, remove the AC power adapter.

Display panel problems

The screen is blank.

- Do the following:
 - If you are using the AC power adapter or the battery pack, and the battery status indicator is on, press **F12** () to make the screen brighter.
 - If the power indicator is blinking, press the Power button to resume from sleep mode.
 - If the problem persists, follow the solution in the next problem "The screen is unreadable or distorted."

The screen is unreadable or distorted.

- Make sure that:
 - The screen resolution and color quality are correctly set.
 - The monitor type is correct.

Incorrect characters appear on the screen.

- Is the operating system or programs installed correctly? If they are installed and configured correctly, have the computer serviced.

Sound problems

No sound can be heard from the speakers even when the volume is turned up.

- Make sure that:
 - The Mute function is off.
 - The combo audio jack is not being used.
 - Speakers are selected as the playback device.

Chapter 4. Troubleshooting

Battery pack problems

Your computer shuts down before the battery status indicator shows empty.

-or-

Your computer operates after the battery status indicator shows empty.

- Recharge the battery.

Other problems

Your computer does not respond.

- To turn off your computer, press and hold the Power button for five seconds or more. If the computer still does not respond, remove the AC power adapter.
- Your computer might lock when it enters sleep mode during a communication operation. Disable the sleep timer when you are working on the network.

The connected external device does not work.

- Do *not* connect or disconnect any external device cables other than USB while the computer power is on. Otherwise, you might damage your computer.
- When using high power consumption external devices such as an external USB optical disk drive, use an external device power adapter. Otherwise, the device may not be recognized, or the system may shut down as a result.

Trademarks

The following terms are trademarks or registered trademarks of Lenovo in the United States, other countries, or both.

Lenovo
OneKey

Microsoft and Windows are trademarks of Microsoft Corporation in the United States, other countries, or both.

Other company, products, or service names may be trademarks or service marks of others.

