

User Guide



HP OfficeJet Pro 8210



HP OfficeJet Pro 8210 series

User Guide

Copyright information

© 2016 HP Development Company, L.P.

Edition 1, 5/2016

HP Company notices

The information contained in this document is subject to change without notice.

All rights reserved. Reproduction, adaptation, or translation of this material is prohibited without prior written permission of HP, except as allowed under copyright laws.

The only warranties for HP products and services are set forth in the express warranty statements accompanying such products and services. Nothing herein should be construed as constituting an additional warranty. HP shall not be liable for technical or editorial errors or omissions contained herein.

Acknowledgements

Microsoft and Windows are either registered trademarks or trademarks of Microsoft Corporation in the United States and/or other countries.

ENERGY STAR and the ENERGY STAR mark are registered trademarks owned by the U.S. Environmental Protection Agency.

Mac, OS X, and AirPrint are trademarks of Apple Inc., registered in the U.S. and other countries.

Safety information



Always follow basic safety precautions when using this product to reduce risk of injury from fire or electric shock.

1. Read and understand all instructions in the documentation that comes with the printer.
2. Observe all warnings and instructions marked on the product.
3. Unplug this product from wall outlets before cleaning.
4. Do not install or use this product near water, or when you are wet.
5. Install the product securely on a stable surface.
6. Install the product in a protected location where no one can step on or trip over the line cord, and the line cord cannot be damaged.
7. If the product does not operate normally, see [Solve a problem](#).
8. There are no user-serviceable parts inside. Refer servicing to qualified service personnel.

Table of contents

1 How do I?	1
2 Get started	2
Accessibility	2
HP EcoSolutions (HP and the Environment)	2
Manage Power	3
Quiet Mode	3
Optimize Printing Supplies	5
Understand the printer parts	5
Front view	5
Printing supplies area	6
Back view	6
Use the printer control panel	7
Overview of buttons	7
Change printer settings	8
Paper basics	8
Recommended papers for printing	9
Order HP paper supplies	10
Tips for selecting and using paper	10
Load paper	11
Set up and use accessories	20
Install and use Tray 2	21
Work with trays	21
Update the printer	22
Open the HP printer software (Windows)	23
3 Print	24
Print documents	24
Print brochures	25
Print on envelopes	26
Print photos	27
Print on special and custom-size paper	29
Print on both sides (duplexing)	30
Print from mobile device	30
Print with AirPrint™	31
Tips for print success	31

4 Web Services	34
What are Web Services?	34
Set up Web Services	34
Use Web Services	35
Print with HP ePrint	35
Remove Web Services	36
5 Work with cartridges	37
Information on cartridges and the printhead	37
Some color ink is used even when printing with black cartridge only	38
Check the estimated ink levels	38
Replace the cartridges	38
Order cartridges	41
Store printing supplies	41
Anonymous usage information storage	41
Cartridge warranty information	42
6 Network setup	43
Set up the printer for wireless communication	43
Before you begin	43
Set up the printer on your wireless network	44
Change the connection type	44
Test the wireless connection	45
Turn on or off the wireless capability of the printer	45
Change network settings	45
Use Wi-Fi Direct	47
7 Printer management tools	50
Toolbox (Windows)	50
HP Utility (OS X)	50
Embedded web server	50
About cookies	51
Open the embedded web server	51
Embedded web server cannot be opened	52
HP Web Jetadmin software	53
8 Solve a problem	54
Jams issues	54
Clear a paper jam	54
Read general instructions in the Help for clearing paper jams	54

Clear a print carriage jam	57
Read general instructions in the Help for clearing a print carriage jams	57
Learn how to avoid paper jams	57
Solve paper-feed problems	58
Printing issues	59
Fix problems with page not printing (unable to print)	59
Read general instructions in the Help for unable to print issues	59
Fix print quality issues	63
Read general instructions in the Help for resolving print quality issues	63
Network and connection issues	66
Fix wireless connection	66
Find network settings for wireless connection	66
Fix Wi-Fi Direct connection	66
Fix Ethernet connection	67
Printer hardware issues	67
Get help from the printer control panel	68
Understand printer reports	68
Printer status report	68
Network configuration page	68
Print quality report	68
Wireless test report	69
Solve problems using Web Services	69
Maintain the printer	69
Clean the exterior	70
Maintain the printhead and cartridges	70
Restore defaults and settings	70
HP support	71
Appendix A Technical information	73
Specifications	73
Regulatory information	74
Regulatory Model Number	75
FCC statement	75
VCCI (Class B) compliance statement for users in Japan	76
Notice to users in Japan about the power cord	76
Notice to users in Korea	76
Noise emission statement for Germany	76
European Union Regulatory Notice	76
Products with wireless functionality	77
Visual display workplaces statement for Germany	77
Declaration of conformity	78

Regulatory information for wireless products	79
Exposure to radio frequency radiation	79
Notice to users in Brazil	79
Notice to users in Canada	80
Notice to users in Taiwan	80
Notice to users in Mexico	81
Notice to users in Japan	81
Notice to users in Korea	81
Environmental product stewardship program	81
Eco-Tips	82
European Union Commission Regulation 1275/2008	82
Paper	82
Plastics	82
Material safety data sheets	82
Recycling program	82
HP inkjet supplies recycling program	82
Power consumption	83
Disposal of waste equipment by users	83
Chemical substances	83
Restriction of hazardous substance (Ukraine)	83
Restriction of hazardous substance (India)	83
China SEPA Eco Label User Information	84
China Energy Label for Printer, Fax and Copier	84
The Table of Hazardous Substances/Elements and their Content (China)	85
EPEAT	85
Battery disposal in Taiwan	85
California Perchlorate Material Notice	86
EU Battery Directive	87
Battery notice for Brazil	88
Index	89

1 How do I?

- [Get started](#)
- [Print](#)
- [Web Services](#)
- [Work with cartridges](#)
- [Solve a problem](#)

2 Get started

This guide provides details about how to use the printer and how to resolve problems.

- [Accessibility](#)
- [HP EcoSolutions \(HP and the Environment\)](#)
- [Understand the printer parts](#)
- [Use the printer control panel](#)
- [Paper basics](#)
- [Load paper](#)
- [Set up and use accessories](#)
- [Update the printer](#)
- [Open the HP printer software \(Windows\)](#)

Accessibility

The printer provides a number of features that make it accessible for people with disabilities.

Visual

The HP software provided with the printer is accessible for users with visual impairments or low vision by using your operating system's accessibility options and features. The software also supports most assistive technology such as screen readers, Braille readers, and voice-to-text applications. For users who are color blind, colored buttons and tabs used in the HP software have simple text or icon labels that convey the appropriate action.

Mobility

For users with mobility impairments, the HP software functions can be executed through keyboard commands. The HP software also supports Windows accessibility options such as StickyKeys, ToggleKeys, FilterKeys, and MouseKeys. The printer doors, buttons, paper trays, and paper-width guides can be operated by users with limited strength and reach.

Support

For more information about accessibility solutions for HP products, visit the HP Accessibility and Aging website (www.hp.com/accessibility).

For accessibility information for OS X, visit the Apple website at www.apple.com/accessibility.

HP EcoSolutions (HP and the Environment)

HP is committed to helping you optimize your environmental footprint and empowering you to print responsibly—at home or in the office.

For more detailed information about environmental guidelines that HP follows during the manufacturing process, see [Environmental product stewardship program](#). For more information about HP's environmental initiatives, visit www.hp.com/ecosolutions.

- [Manage Power](#)
- [Quiet Mode](#)
- [Optimize Printing Supplies](#)

Manage Power

Use **Sleep Mode** and **Schedule Printer On/Off** to conserve electricity.

Sleep mode

Power usage is reduced while in Sleep mode. After initial setup of printer, the printer will enter Sleep mode after a selected period of inactivity. The default time is 5 minutes.

To change the period of inactivity before the printer sleeps:

1. On the printer control panel, from the Home screen, select **Setup** , and then press OK .
2. Select **Printer Settings** , and then press OK .
3. Select **Power Management** , and then press OK .
4. Select **Sleep Mode**, and then press OK .
5. Select the desired option, and then press OK .

Schedule On and Off

Use this feature to automatically turn the printer on or off on selected days. For example, you can schedule the printer to turn on at 8 a.m. and turn off at 8 p.m. from Monday to Friday. In this way, you save energy during the night and weekends.

Use the following instructions to schedule the day and time for On and Off.

1. On the printer control panel, from the Home screen, select **Setup** , and then press OK .
2. Select **Printer Settings** , and then press OK .
3. Select **Power Management** , and then press OK .
4. Select **Schedule On/Off**, and then press OK .
5. Select the desired option, and follow the on-screen messages to set the day and time to turn the printer off and on.

⚠ CAUTION: Always turn the printer off properly, using either **Schedule Off** or  (the Power button) located on the front left side of the printer.

If you improperly turn the printer off, the print carriage might not return to the correct position, causing problems with the cartridges and print quality issues.

Never turn off the printer when cartridges are missing. HP recommends that you replace any missing cartridges as soon as possible to avoid print quality issues, possible extra ink usage from the remaining cartridges, or damage to the ink system.

Quiet Mode

Quiet Mode slows down printing to reduce overall noise without affecting print quality. It only works when printing on plain paper. Additionally, Quiet Mode is disabled if you are printing using the best or presentation print quality. To reduce printing noise, turn on Quiet Mode. To print at normal speed, turn Quiet Mode off. Quiet Mode is off by default.



NOTE: Quiet Mode does not work if you print photos or envelopes.

You can create a schedule by selecting the time when the printer prints in Quiet Mode. For example, you can schedule the printer to be in Quiet Mode from 10 p.m. to 8 a.m. everyday.

To turn on Quiet Mode from the printer control panel

1. From the Home screen on the printer control panel, select **Setup** , and then press **OK** .
2. Select **Printer Settings** , and then press **OK** .
3. Select **Quiet Mode** , and then press **OK** .
4. Select **On**, and then press **OK** .

To create a schedule for Quiet Mode from the printer control panel

1. From the Home screen on the printer control panel, select **Setup** , and then press **OK** .
2. Select **Printer Settings** , and then press **OK** .
3. Select **Quiet Mode** , and then press **OK** .
4. Select **Schedule**, and then press **OK** .
5. Set the start time of the schedule.

To change the hour, select the hour (selected by default), and then press the arrow buttons to increase or decrease the value.

To change the minute, press **⏪** to select the minute, and then press the arrow buttons to increase or decrease the value.

When you have finished setting the start time, press **OK** .

6. Set the end time of the schedule. See the previous step for instructions on changing the time.

When you have finished setting the end time, press **OK** .

To turn on Quiet Mode while the printer is printing

- ▲ On the printing screen, press **OK** next to **⏪** (Quiet Mode) to turn it on.



NOTE: Quiet Mode is turned on after a moment and is only active for the current print job.

To turn Quiet Mode on or off from the printer software (Windows)

1. Open the HP printer software. For more information, see [Open the HP printer software \(Windows\)](#).
2. Click **Quiet Mode** .
3. Select **On** or **Off** .
4. Click **Save Settings**.

To turn Quiet Mode on or off from the printer software (OS X)

1. Open HP Utility. For more information, see [HP Utility \(OS X\)](#).
2. Select the printer.
3. Click **Quiet Mode** .

4. Select **On** or **Off** .
5. Click **Apply Now**.

To turn Quiet Mode on or off from the Embedded Web Server (EWS)

1. Open the EWS. For more information, see [Open the embedded web server](#).
2. Click the **Settings** tab.
3. In the **Preferences** section, select **Quiet Mode** , and then select **On** or **Off** .
4. Click **Apply**.

Optimize Printing Supplies

To optimize printing supplies such as ink and paper, try the following:

- Recycle used original HP cartridges through HP Planet Partners. For more information, visit www.hp.com/recycle.
- Optimize paper usage by printing on both sides of the paper.
- Change the print quality in the printer driver to a draft setting. The draft setting uses less ink.
- Do not clean the printhead unnecessarily. Doing so wastes ink and shortens the life of the cartridges.

Understand the printer parts

This section contains the following topics:

- [Front view](#)
- [Printing supplies area](#)
- [Back view](#)

Front view

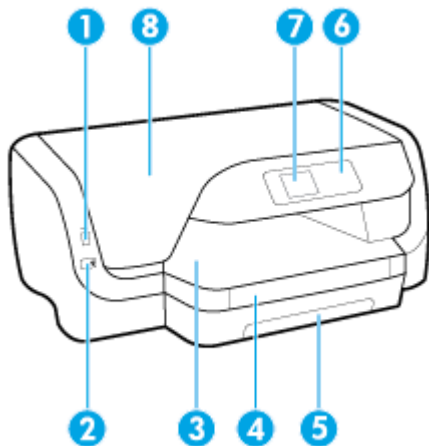

1	Front USB port
2	Power button
3	Output tray

4	Output tray extension
5	Input tray
6	Control panel
7	Control panel display
8	Cartridge access door

Printing supplies area

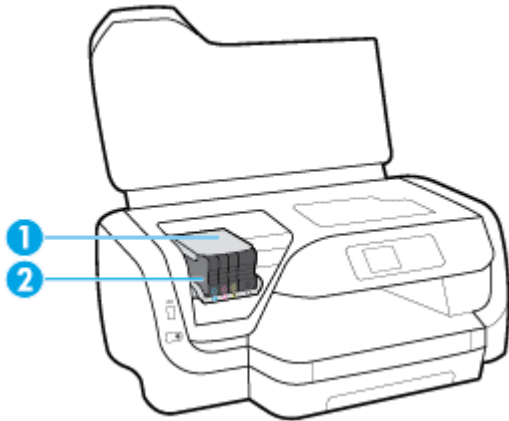

1	Printhead
2	Cartridges

 **NOTE:** Cartridges should be kept in the printer to prevent possible print quality issues or printhead damage. Avoid removing supplies for extended periods of time. Do not turn the printer off when a cartridge is missing.

Back view

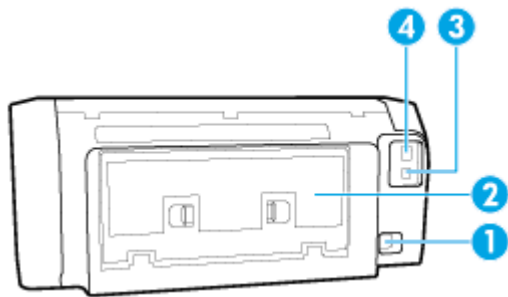

1	Power input
2	Rear access panel
3	Rear USB port
4	Ethernet network port

Use the printer control panel

This section contains the following topics:

- [Overview of buttons](#)
- [Change printer settings](#)

Overview of buttons

The following provides a quick reference to the printer control panel features.

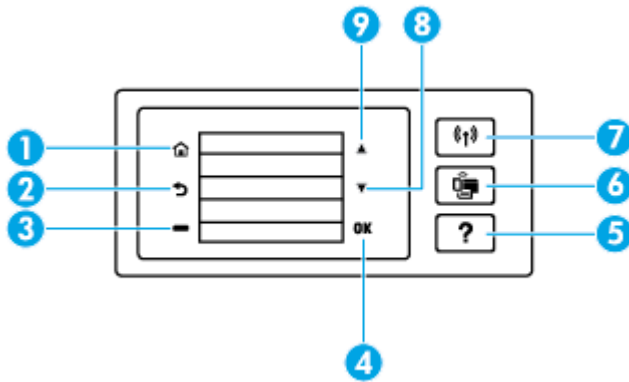

Label	Name and Description
1	Home button: Returns to the Home screen from any other screen.
2	Back button: Returns to the previous screen.
3	Cancel button or Selection button: Changes according to what is displayed on the screen.
4	OK button: Confirms your selection.
5	Help button: Opens Help menu when on Home screen; displays the help for a selected menu option; or provides more information about current screen.
6	Wi-Fi Direct button: Displays the Wi-Fi Direct connection status and settings. The light next to the Wi-Fi Direct button is : <ul style="list-style-type: none">• On when Wi-Fi Direct is turned on.• Off when Wi-Fi Direct is turned off.
7	Wireless button: Displays the wireless status and settings. For more information, see Set up the printer for wireless communication . The light next to the Wireless button is : <ul style="list-style-type: none">• On when the printer is connected to a wireless network.• Blinking when the wireless feature is turned on but the printer is not connected to a wireless network.• Off when the wireless feature is turned off.
8	Down arrow button: Select the next menu option or scroll down the screen.
9	Up arrow button: Select the previous menu option or scroll up the screen.

Change printer settings

Use the control panel to change the printer function and settings, print reports, or get help for the printer.



 **TIP:** If the printer is connected to a computer, you can also change the printer settings using the printer management tools in computer.

For more information about these tools, see [Printer management tools](#).

To change settings for a function

The Home screen of the control panel display shows the available functions for the printer.



1. From the control panel, use the arrow buttons to select a desired option, and then press the OK button to confirm your selection.
2. Scroll to see the available settings. Select the setting you want to change, and then press the OK button.
3. Follow the prompts on the control panel display to change the settings.

 **NOTE:** Press the Home button () to return to the Home screen.

To change the printer settings

To change the printer settings or print reports, use the options available on the **Setup Menu** screen.

1. On the printer control panel, from the Home screen, select **Setup**, and then press OK.
2. Select **Printer Settings**, and then press OK.
3. Scroll to see the available settings. Select the setting you want to change, and then press the OK button.
4. Follow the prompts on the control panel display to change the settings.

 **NOTE:** Press the Home button () to return to the Home screen.

Paper basics

The printer is designed to work well with most types of office paper. It is best to test a variety of print paper types before buying large quantities. Use HP paper for optimum print quality. Visit the HP website at www.hp.com for more information about HP paper.



HP recommends plain papers with the ColorLok logo for printing everyday documents. All papers with the ColorLok logo are independently tested to meet high standards of reliability and print quality, and produce documents with crisp, vivid color, bolder blacks, and that dry faster than ordinary plain papers. Look for papers with the ColorLok logo in a variety of weights and sizes from major paper manufacturers.

This section contains the following topics:

- [Recommended papers for printing](#)
- [Order HP paper supplies](#)
- [Tips for selecting and using paper](#)

Recommended papers for printing

If you want the best print quality, HP recommends using HP papers that are specifically designed for the type of project you are printing.

Depending on your country/region, some of these papers might not be available.

Photo printing

- **HP Premium Plus Photo Paper**

HP Premium Plus Photo Paper is HP's highest-quality photo paper for your best photos. With HP Premium Plus Photo Paper, you can print beautiful photos that are instant-dry so you can share them right off the printer. The printer supports several sizes, including A4, 8.5 x 11 inches, 4 x 6 inches (10 x 15 cm), and 5 x 7 inches (13 x 18 cm) in two finishes - glossy or soft gloss (semi-gloss). Ideal for framing, displaying, or gifting your best photos and special photo projects. HP Premium Plus Photo Paper delivers exceptional results with professional quality and durability.

- **HP Advanced Photo Paper**

This glossy photo paper features an instant-dry finish for easy handling without smudging. It resists water, smears, fingerprints, and humidity. Your prints have a look and feel comparable to a store-processed photo. It is available in several sizes, including A4, 8.5 x 11 inches, 10 x 15 cm (4 x 6 inches), 13 x 18 cm (5 x 7 inches). It is acid-free for longer lasting documents.

- **HP Everyday Photo Paper**

Print colorful, everyday snapshots at a low cost, using paper designed for casual photo printing. This affordable photo paper dries quickly for easy handling. Get sharp, crisp images when you use this paper with any inkjet printer. It is available in glossy finish in several sizes, including A4, 8.5 x 11 inches, 5 x 7 inches and 4 x 6 inches (10 x 15 cm). It is acid-free for longer lasting documents.

Business documents

- **HP Premium Presentation Paper 120g Matte or HP Professional Paper 120 Matt**

This paper is a heavy two-sided matte paper perfect for presentation, proposals, reports, and newsletters. It is heavyweight for an impressive look and feel.

- **HP Brochure Paper 180g Glossy or HP Professional Paper 180 Glossy**

These papers are glossy-coated on both sides for two-sided use. They are the perfect choice for near-photographic reproductions and business graphics for report covers, special presentations, brochures, mailers, and calendars.

- **HP Brochure Paper 180g Matte or HP Professional Paper 180 Matt**

These papers are matte-coated on both sides for two-sided use. They are the perfect choice for near-photographic reproductions and business graphics for report covers, special presentations, brochures, mailers, and calendars.

Everyday printing

All the papers listed for everyday printing feature ColorLok Technology for less smearing, bolder blacks, and vivid colors.

- **HP Bright White Inkjet Paper**

HP Bright White Inkjet Paper delivers high-contrast colors and sharp text. It is opaque enough for two-sided color usage with no show-through, which makes it ideal for newsletters, reports, and flyers.

- **HP Printing Paper**

HP Printing Paper is a high-quality multifunction paper. It produces documents that look and feel more substantial than documents printed on standard multipurpose or copy paper. It is acid-free for longer lasting documents.

- **HP Office Paper**

HP Office Paper is a high-quality multifunction paper. It is suitable for copies, drafts, memos, and other everyday documents. It is acid-free for longer lasting documents.

Order HP paper supplies

The printer is designed to work well with most types of office paper. Use HP paper for optimum print quality.

To order HP papers and other supplies, go to www.hp.com. At this time, some portions of the HP website are available in English only.

HP recommends plain papers with the ColorLok logo for printing and copying of everyday documents. All papers with the ColorLok logo are independently tested to meet high standards of reliability and print quality, and produce documents with crisp, vivid color, bolder blacks and shorter dry-time than ordinary plain papers. Look for papers with the ColorLok logo in a variety of weights and sizes from major paper manufacturers.

Tips for selecting and using paper

For the best results, observe the following guidelines.

- Load only one type (and one size) of paper at a time into the input tray.
- Make sure the paper is loaded correctly in the input tray.
- Do not overload the input tray or the output tray.
- To prevent jams, poor print quality, and other printing problems, avoid loading the following paper in the input tray:
 - Multipart forms
 - Media that is damaged, curled, or wrinkled
 - Media with cutouts or perforations
 - Media that is heavily textured, embossed, or does not accept ink well
 - Media that is too lightweight or stretches easily
 - Media that contains staples or clips

Load paper

To load standard-size paper

1. Pull out the input tray completely.

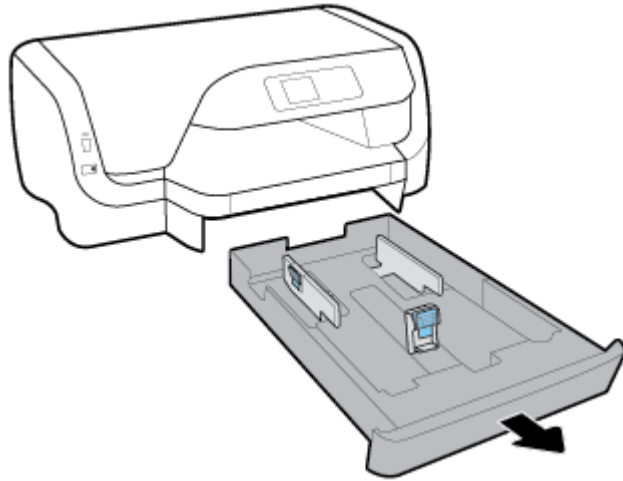

2. Slide the paper guides towards the edges of the tray as far as possible.
 - To slide the paper-width guides, press the button on the left paper-width guide and slide the guide at the same time.
 - To slide the paper-length guide, press the button on the paper-length guide and slide the guide at the same time.

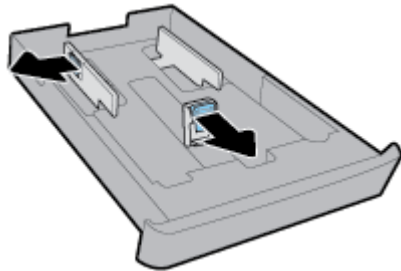

3. Insert the paper in portrait orientation and with the side to be printed facing down.

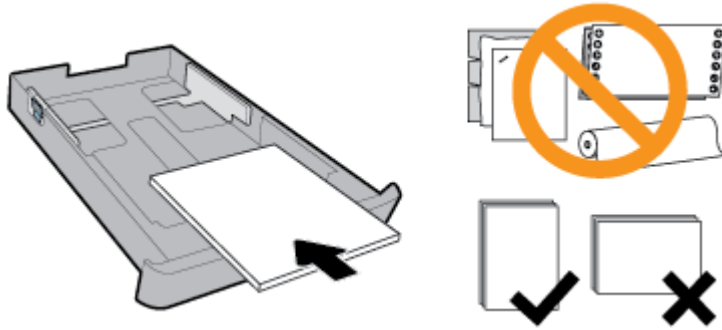

Make sure the stack of paper is aligned with the appropriate paper size lines on the front of the tray. Besides, make sure the stack of paper does not exceed the stack height marking on the right edge of the tray.

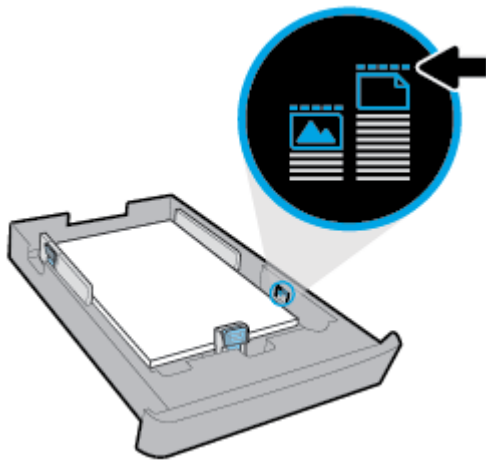

 **NOTE:** Do not load paper while the printer is printing.

4. Adjust the paper-width guides and the paper-length guide until they touch the edge of the stack of paper.

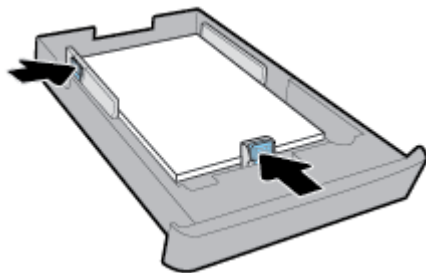

5. Reinsert the input tray back into the printer.

6. Pull out the output tray extension.

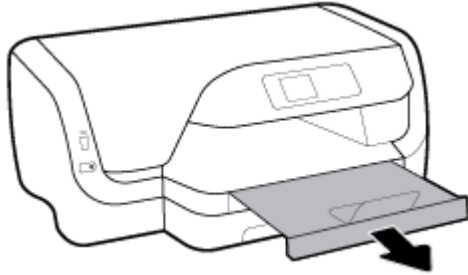

To load envelopes



NOTE:

- Do not load paper while the printer is printing.
- If you have a Tray 2, note that it supports only A4, Letter, or Legal sized plain paper.

1. Pull out the input tray completely.

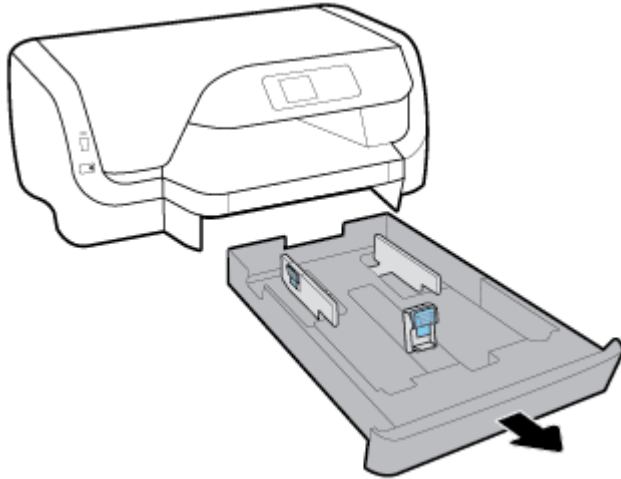

2. If there is other paper in the input tray, remove the paper.
3. Slide the paper guides towards the edges of the tray as far as possible.
 - To slide the paper-width guides, press the button on the left paper-width guide and slide the guide at the same time.
 - To slide the paper-length guide, press the button on the paper-length guide and slide the guide at the same time.

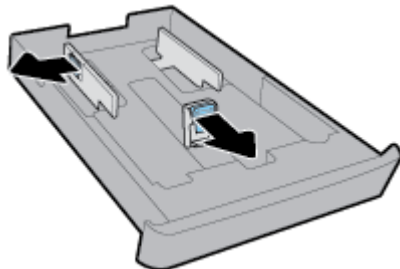

4. Insert the envelopes print-side down in portrait orientation according to the graphic below.

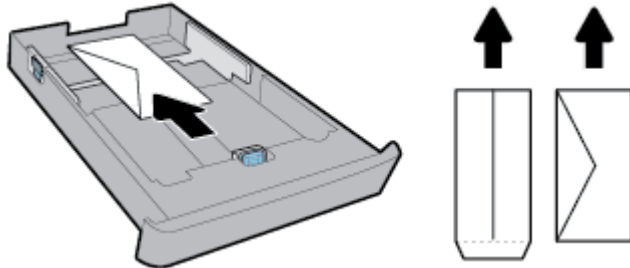

 **NOTE:** Do not load envelopes while the printer is printing.

5. Adjust the paper-width guides until they touch the edge of the stack of envelopes.

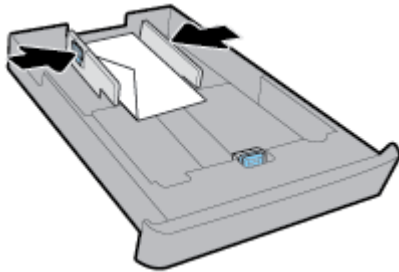

6. Make sure the stack of envelopes does not exceed the stack height marking on the left paper-width guide.

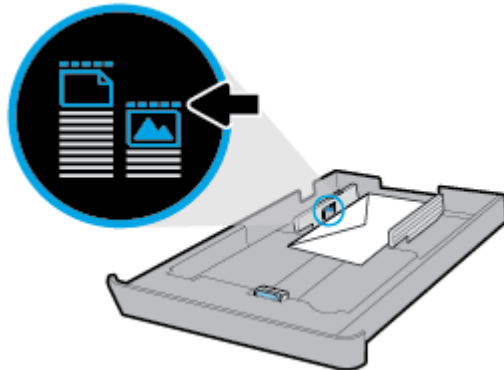

7. Adjust the paper-length guide until it touches the edge of the stack of envelopes.

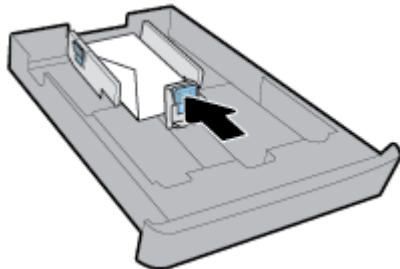

8. Reinsert the input tray back into the printer.

9. Pull out the output tray extension.

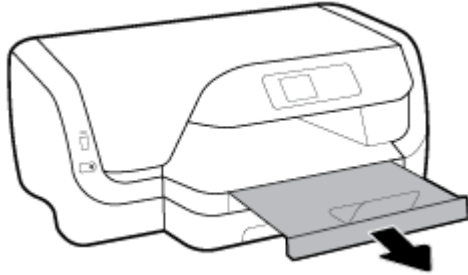

To load cards and photo paper



NOTE:

- Do not load paper while the printer is printing.
- If you have a Tray 2, note that it supports only A4, Letter, or Legal sized plain paper.

1. Pull out the input tray completely.

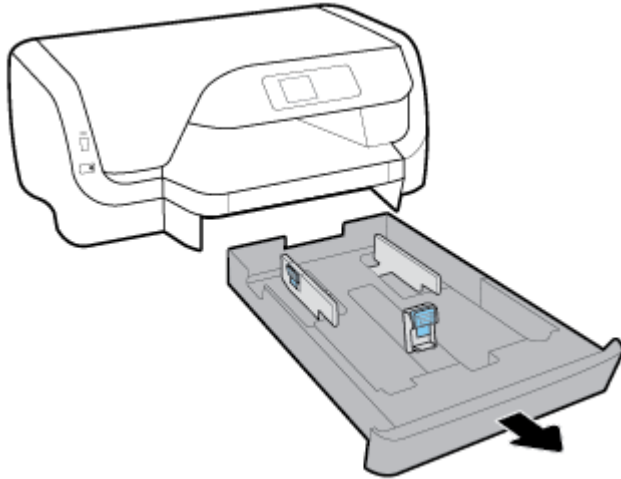

2. If there is other paper in the input tray, remove the paper.
3. Slide the paper guides towards the edges of the tray as far as possible.
 - To slide the paper-width guides, press the button on the left paper-width guide and slide the guide at the same time.
 - To slide the paper-length guide, press the button on the paper-length guide and slide the guide at the same time.

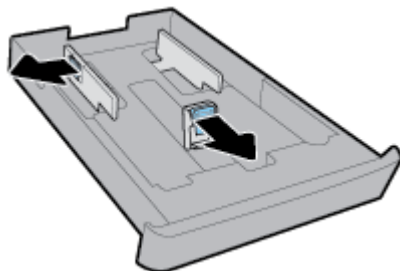

4. Insert the cards or photo paper print-side down in portrait orientation.

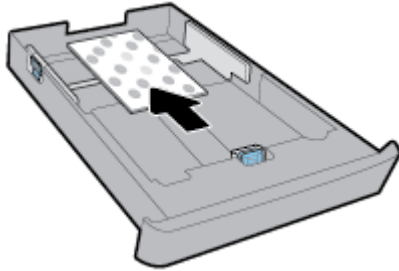

 **NOTE:** Do not load paper while the printer is printing.

5. Adjust the paper-width guides until they touch the edge of the stack of paper.

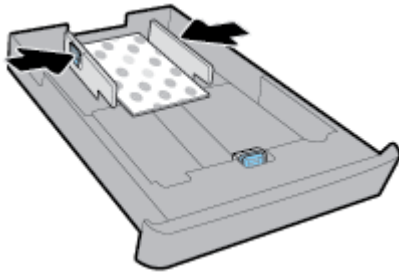

6. Make sure the stack of paper does not exceed the stack height marking on the left paper-width guide.

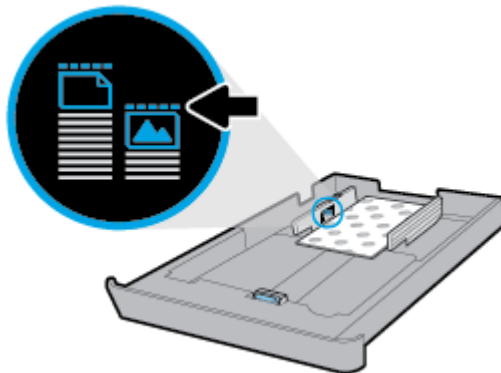

7. Adjust the paper-length guide until it touches the edge of the stack of paper.

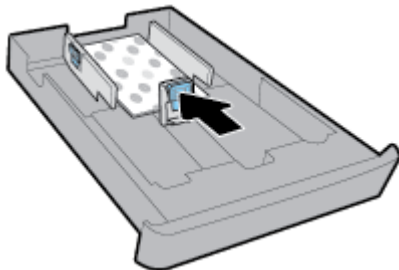

8. Reinsert the input tray back into the printer.

9. Pull out the output tray extension.

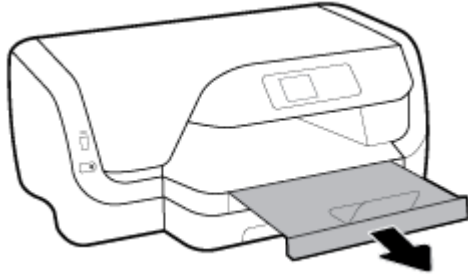

To load legal-size paper



NOTE:

- Do not load paper while the printer is printing.
- If you have a Tray 2, note that it supports only A4, Letter, or Legal sized plain paper.

1. Pull out the input tray completely.

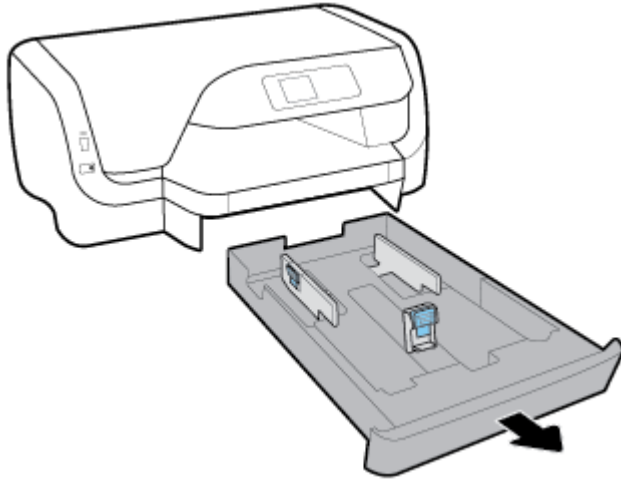

2. If there is other paper in the input tray, remove the paper.
3. Slide the paper guides towards the edges of the tray as far as possible.
 - To slide the paper-width guides, press the button on the left paper-width guide and slide the guide at the same time.
 - To slide the paper-length guide, press the button on the paper-length guide and slide the guide at the same time.

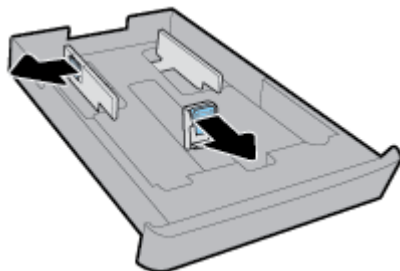

4. Extend the input tray. To do this, press the button near the tray's front-left corner and at the same time, pull out the front of the tray.

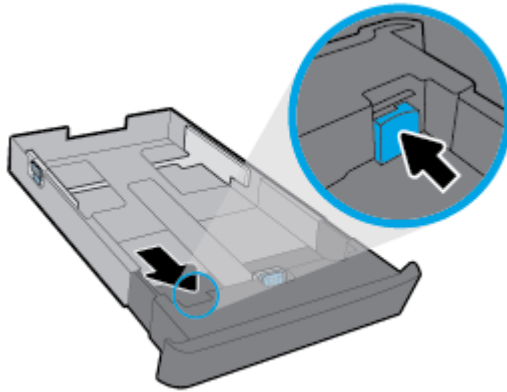

5. Insert the paper in portrait orientation and with the side to be printed facing down.

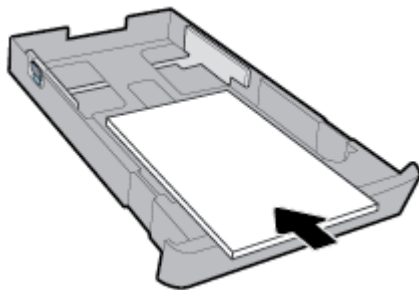

Make sure the stack of paper is aligned with the appropriate paper size lines on the front of the tray. Besides, make sure the stack of paper does not exceed the stack height marking on the right edge of the tray.

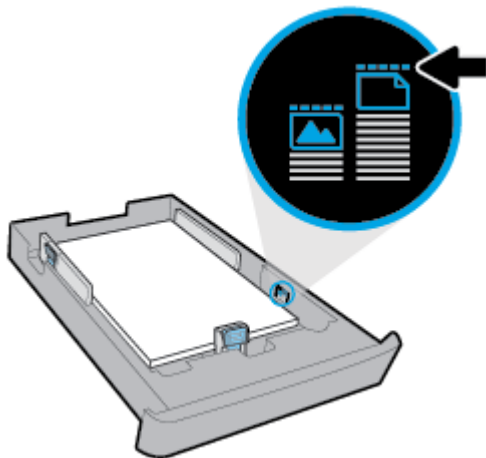

 **NOTE:** Do not load paper while the printer is printing.

6. Adjust the paper-width guides and the paper-length guide until they touch the edge of the stack of paper.

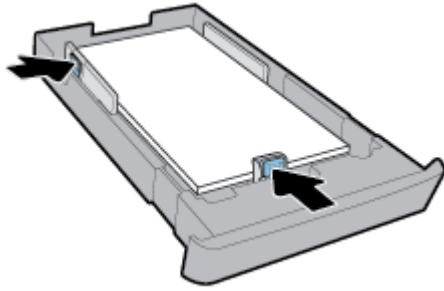

7. Reinsert the input tray back into the printer.
8. Pull out the output tray extension.

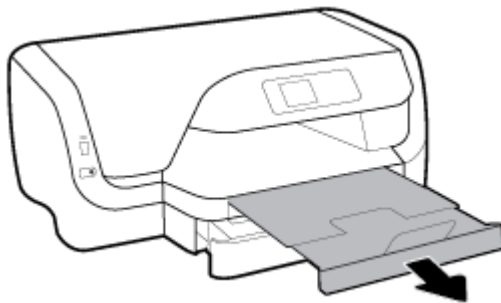

To load paper in Tray 2

 **NOTE:** Tray 2 is available with some models of the printer.

 **NOTE:** Tray 2 supports only plain paper in A4, Letter, or Legal size.

To learn how to set up and use Tray 2, see [Set up and use accessories](#).

1. Pull out Tray 2 completely from the printer.
2. Slide the paper guides towards the edges of the tray as far as possible.
 - To slide the paper-width guides, press the button on the left paper-width guide and slide the guide at the same time.
 - To slide the paper-length guide, press the button on the paper-length guide and slide the guide at the same time.

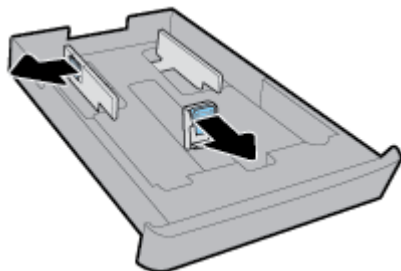

3. Insert the paper in portrait orientation and with the side to be printed facing down.

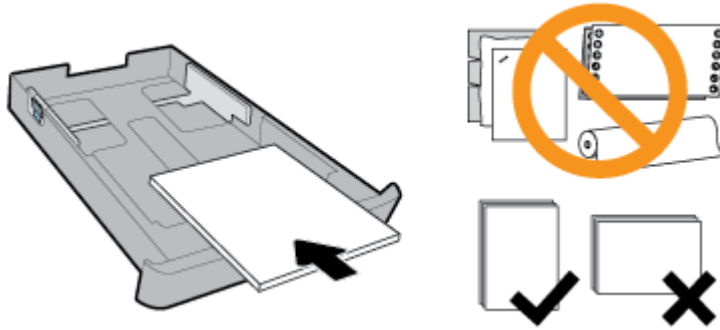

Make sure the stack of paper is aligned with the appropriate paper size lines on the front of the tray. Besides, make sure the stack of paper does not exceed the stack height marking on the right edge of the tray.

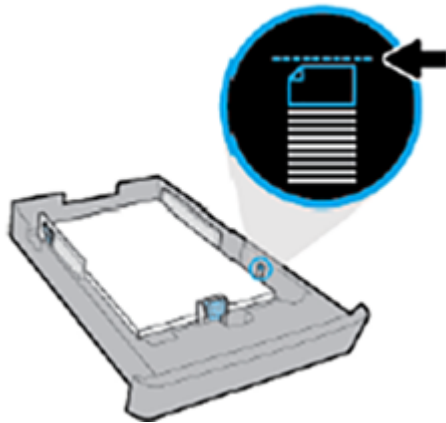

 **NOTE:** Do not load paper while the printer is printing.

4. Adjust the paper-width guides and the paper-length guide until they touch the edge of the stack of paper.

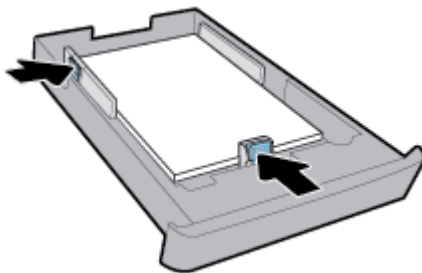

5. Check the Tray 2 area underneath the printer. If there is paper, remove the paper.
6. Reinsert Tray 2 into the printer.

Set up and use accessories

If you want to install and set up accessories (such as a second tray), see the following sections.

When using more than one tray, you can make use of the tray features provided to achieve a better experience.



NOTE: Tray 2 is available with some models of the printer. You can purchase accessories online at www.hp.com.

Install and use Tray 2

To install Tray 2

1. Unpack the tray, remove the packing tapes and materials, and move the tray to the prepared location. The surface must be sturdy and level.
2. Turn off the printer and unplug the power cord from the electrical socket.
3. Set the printer on top of the tray.



CAUTION: Be careful to keep your fingers and hands clear of the bottom of the printer.

4. Connect the power cord and turn on the printer.

Work with trays

By default, the printer draws paper from Tray 1. If Tray 1 is empty and Tray 2 is installed and contains paper, the printer draws paper from Tray 2.

You can change the behaviors using the following features:

- **Default Tray:** Set the default tray from which the printer draws paper first when paper of the same size is loaded in both Tray 1 and Tray 2.
- **Tray Lock:** Lock a tray to prevent it from accidental use; for example, when you have loaded special paper (such as letterhead or preprinted paper).

The printer will not use a locked tray even when the other tray is empty.



NOTE: For better experience, load only one type of paper in a tray.



NOTE: Tray 2 supports only plain paper.

To achieve this	Follow these steps
Have paper loaded in both trays and use paper from one tray if the other tray is empty.	<ul style="list-style-type: none"> • Load paper in both trays. For more information, see Load paper. • Turn off tray lock.
Have paper loaded in both trays and use paper from one of the trays first.	<ul style="list-style-type: none"> • Load paper of the same size in both trays. • Set the desired tray as the default tray.
Be able to choose from plain paper and another paper type that you use occasionally.	<ul style="list-style-type: none"> • Load special paper in main input tray and plain paper in Tray 2.
NOTE: For better experience, load only one type of paper in a tray.	<ul style="list-style-type: none"> • Lock the main input tray and set Tray 2 as the default tray.

To change tray settings



NOTE: You can also change the tray settings from the HP printer software or EWS.

To access EWS and the printer software, see [Embedded web server](#) and [Open the HP printer software \(Windows\)](#).

1. Make sure the printer is turned on.
2. On the printer control panel, from the Home screen, select **Setup** , and then press OK .
3. Select **Printer Settings** , and then press OK .
4. Select **Paper Settings** , and then press OK .
5. Select **Default Tray** or **Tray Lock**, and then press OK .
6. Select the desired option, and then press OK .

To turn on automatic selection of tray or paper source (Windows)

1. Open the HP printer software. For more information, see [Open the HP printer software \(Windows\)](#).
2. Click **Set Preferences** under **Print** .
3. In the **Printing preferences** dialog box, click the **Printing Shortcuts** tab.
4. From the **Paper Source** drop-down list, select one of the auto selection options.
5. Click **OK** twice to close the dialog box and accept changes.

To turn on automatic selection of tray or paper source (OS X)

1. From the **File** menu in your software, choose **Print**.
2. Make sure your printer is selected.
3. Select **Automatically Select** from the **Source** drop-down list.
4. Click **Show Details** to access the print options.

Update the printer

By default, if the printer is connected to a network and Web Services has been enabled, the printer automatically checks for updates.

To update the printer using the printer control panel

1. On the printer control panel, from the Home screen, select **Setup** , and then press OK .
2. Select **Tools**, and then press OK .
3. Select **Update the Printer** , and then press OK .
4. Select **Check Updates**, and then press OK .

To enable the printer to automatically check for updates

1. On the printer control panel, from the Home screen, select **Setup** , and then press OK .
2. Select **Tools**, and then press OK .
3. Select **Update the Printer** , and then press OK .

4. Select **Auto Update**, and then press OK .
5. Select **Automatically**, and then press OK .

To update the printer using the embedded web server

1. Open the EWS.
For more information, see [Embedded web server](#).
2. Click the **Tools** tab.
3. In the **Printer Updates** section, click **Firmware Updates**, and then follow the on-screen instructions.

 **NOTE:** If a printer update is available, the printer downloads and installs the update, and then restarts.

 **NOTE:** If prompted for proxy settings and if your network uses proxy settings, follow the on-screen instructions to set up a proxy server. If you do not have the details, contact your network administrator or the person who set up the network.

Open the HP printer software (Windows)

After installing the HP printer software, depending on your operating system, do one of the following.

- **Windows 10:** From the computer desktop, click the Start button, click **All apps**, select **HP**, and then select the icon with the printer name.
- **Windows 8.1:** Click the down arrow in lower left corner of the **Start** screen, and then select the icon with the printer name.
- **Windows 8:** On the **Start** screen, right-click an empty area on the screen, click **All Apps** on the app bar, and then select the icon with the printer name.
- **Windows 7, Windows Vista, and Windows XP:** From the computer desktop, click the Start button, select **All Programs**, select **HP**, select the folder for the printer, and then select the icon with the printer name.

3 Print

Most print settings are automatically handled by the software application. Change the settings manually only when you want to change print quality, print on specific types of paper, or use special features.

 **TIP:** This printer includes **HP ePrint**, a free service from HP that allows you to print documents on your HP ePrint-enabled printer anytime, from any location, without any additional software or printer drivers.

TIP: You can use this printer to print documents and photos on your mobile device (such as a smartphone or tablet). For more information, visit the HP Mobile Printing website at www.hp.com/go/mobileprinting. If a local version of this website is not available in your country/region or language, you might be directed to the HP Mobile Printing site in another country/region or language.

- [Print documents](#)
- [Print brochures](#)
- [Print on envelopes](#)
- [Print photos](#)
- [Print on special and custom-size paper](#)
- [Print on both sides \(duplexing\)](#)
- [Print from mobile device](#)
- [Print with AirPrint™](#)
- [Tips for print success](#)

Print documents

To print documents (Windows)

1. Load paper in the tray. For more information, see [Load paper](#).
2. From your software, select **Print**.
3. Make sure your printer is selected.
4. Click the button that opens the **Properties** dialog box.

Depending on your software application, this button might be called **Properties**, **Options**, **Printer Setup**, **Printer Properties**, **Printer**, or **Preferences**.

 **NOTE:** To set print settings for all print jobs, make the changes in the HP software provided with the printer. For more information on the HP software, see [Printer management tools](#).

5. Select the appropriate options on the **Printing Shortcuts** tab.

To change other print settings, click the other tabs.

For more printing tips, see [Tips for print success](#).

 **NOTE:** If you change the paper size, be sure to load the correct paper in the input tray and set the paper size on the printer control panel.

6. Click **OK** to close the **Properties** dialog box.
7. Click **Print** or **OK** to begin printing.

To print documents (OS X)

1. From the **File** menu in your software, choose **Print**.
2. Make sure your printer is selected.
3. Specify the page properties.

If you do not see options on the Print dialog, click **Show Details**.

- Choose the appropriate paper size in the **Paper Size** pop-up menu.



NOTE: If you change the paper size ensure that you have loaded the correct paper.

- Select the orientation.
 - Enter the scaling percentage.
4. Click **Print**.

To print documents from a USB flash drive

1. Insert a USB flash drive into the front USB port.

Wait for the files and folders in the USB flash drive to appear on the control panel display.



NOTE: The printer does not support encrypted USB flash drives.

2. From the control panel, find and select a document that you want to print. Press **OK** to confirm your selection.

You can use the filter, sort, or search feature to find a document. To use these features, select **Find** by pressing the Selection button (≡) on the bottom-left corner of the control panel.

3. From the Image Print screen, set the printing preferences as needed, such as the number of copies to print and the printing quality.
4. To begin printing, select **Start Black Print** or **Start Color Print** and then press **OK**.

Print brochures

To print brochures (Windows)

1. Load paper in the tray. For more information, see [Load paper](#).
2. On the **File** menu in your software application, click **Print**.
3. Make sure your printer is selected.
4. To change settings, click the button that opens the **Properties** dialog box.

Depending on your software application, this button might be called **Properties**, **Options**, **Printer Settings**, **Printer**, or **Preferences**.



NOTE: To set print settings for all print jobs, make the changes in the HP software provided with the printer. For more information on the HP software, see [Printer management tools](#).

5. Select the appropriate options on the **Printing Shortcuts** tab.

To change other print settings, click the other tabs.

For more printing tips, see [Tips for print success](#).



NOTE: If you change the paper size, be sure to load the correct paper in the input tray and set the paper size on the printer control panel.

6. Click **OK** to close the **Properties** dialog box.
7. Click **Print** or OK to begin printing.

To print brochures (OS X)

1. From the **File** menu in your software, choose **Print**.
2. Make sure your printer is selected.
3. Set the print options.

If you do not see options on the Print dialog, click **Show Details**.

- a. Choose the appropriate paper size in the **Paper Size** pop-up menu.



NOTE: If you change the paper size, ensure that you have loaded the correct paper.

- b. From the pop-up menu, choose **Paper Type/Quality**, and then choose the option that provides the best quality or maximum dpi.
4. Click **Print**.

Print on envelopes

Avoid envelopes with the following characteristics:

- Very slick finish
- Self-stick adhesives, clasps, or windows
- Thick, irregular, or curled edges
- Areas that are wrinkled, torn, or otherwise damaged

Make sure the folds of envelopes you load in the printer are sharply creased.



NOTE: For more information about printing on envelopes, see the documentation available with the software program you are using.

To print envelopes (Windows)

1. Load envelopes in the tray. For more information, see [Load paper](#).
2. On the **File** menu in your software, click **Print**.
3. Make sure your printer is selected.
4. Click the button that opens the **Properties** dialog box.

Depending on your software application, this button might be called **Properties**, **Options**, **Printer Setup**, **Printer Properties**, **Printer**, or **Preferences**.

 **NOTE:** To set print settings for all print jobs, make the changes in the HP software provided with the printer. For more information on the HP software, see [Printer management tools](#).

5. Select the appropriate options on the **Printing Shortcuts** tab.

To change other print settings, click the other tabs.

For more printing tips, see [Tips for print success](#).

 **NOTE:** If you change the paper size, be sure to load the correct paper in the input tray and set the paper size on the printer control panel.

6. Click **OK** to close the **Properties** dialog box.
7. Click **Print** or **OK** to begin printing.

To print envelopes (OS X)

1. From the **File** menu in your software, choose **Print**.
2. Make sure your printer is selected.
3. Select the appropriate envelope size from the **Paper Size** pop-up menu.

If you do not see options on the Print dialog, click **Show Details**.

 **NOTE:** If you change the **Paper Size** ensure that you have loaded the correct paper.

4. From the pop-up menu, choose **Paper Type/Quality**, and verify the paper type setting is set to **Plain Paper**.
5. Click **Print**.

Print photos

You can print a photo from either a computer or a USB flash drive.

 **NOTE:** The printer does not support encrypted USB flash drives.

Do not leave unused photo paper in the input tray. The paper might start to curl, which could impair the quality of your printout. Photo paper should be flat before printing.

 **TIP:** You can use this printer to print documents and photos on your mobile device (such as a smartphone or tablet). For more information, visit the HP Mobile Printing website at www.hp.com/go/mobileprinting. If a local version of this website is not available in your country/region or language, you might be directed to the HP Mobile Printing site in another country/region or language.

To print a photo from the computer (Windows)

1. Load paper in the tray. For more information, see [Load paper](#).
2. From your software, select **Print**.
3. Make sure your printer is selected.
4. Click the button that opens the **Properties** dialog box.

Depending on your software application, this button might be called **Properties**, **Options**, **Printer Setup**, **Printer Properties**, **Printer**, or **Preferences**.

5. Select the appropriate options on the **Printing Shortcuts** tab.

To change other print settings, click the other tabs.

For more printing tips, see [Tips for print success](#).



NOTE: If you change the paper size, be sure to load the correct paper in the input tray and set the paper size on the printer control panel.

6. Click **OK** to close the **Properties** dialog box.
7. Click **Print** or **OK** to begin printing.



NOTE: After the printing is finished, remove unused photo paper from the input tray. Store the photo paper so it does not start to curl, which could reduce the quality of your printout.

To print a photo from the computer (OS X)

1. From the **File** menu in your software, choose **Print**.
2. Make sure your printer is selected.
3. Set the print options.

If you do not see options on the Print dialog, click **Show Details**.

- Choose the appropriate paper size in the **Paper Size** pop-up menu.



NOTE: If you change the paper size ensure that you have loaded the correct paper.

- Select the orientation.
4. From the pop-up menu, choose **Paper Type/Quality**, and then choose the following settings:
 - **Paper Type:** The appropriate photo paper type
 - **Quality:** Select the option that provides the best quality or maximum dpi.
 - Click the **Color Options** disclosure triangle, and then choose the appropriate **Photo Fix** option.
 - **Off:** applies no changes to the image.
 - **On:** automatically focuses the image; moderately adjusts image sharpness.
 5. Select any other print settings you want, and then click **Print**.

To print photos from a USB flash drive

1. Insert a USB flash drive into the front USB port.

Wait for the files and folders in the USB flash drive to appear on the control panel display.



NOTE: The printer does not support encrypted USB flash drives.

2. From the control panel, find and select a photo that you want to print. Press **OK** to confirm your selection.

You can use the filter, sort, or search feature to find a photo. To use these features, select **Find** by pressing the Selection button (▢) on the bottom-left corner of the control panel.
3. From the Image Print screen, set the printing preferences as needed, such as the number of copies to print and the printing quality.
4. To begin printing, select **Start Black Print** or **Start Color Print** and then press **OK**.

Print on special and custom-size paper

If your application supports custom-size paper, set the size in the application before printing the document. If not, set the size in the printer driver. You might need to reformat existing documents to print them correctly on custom-size paper.

To set up custom sizes (Windows)

1. Open the HP printer software. For more information, see [Open the HP printer software \(Windows\)](#).
2. Click **Print**, and then click **Set Preferences**.
3. Click the **Paper/Quality** tab.
4. On the **Paper/Quality** tab, click the **Custom** button.
5. In the **Custom** dialog box, click **New**.
Enter the name of the new custom size. Enter the dimensions of the new custom size.
6. Click **Add**, and then click **OK**.

To print on special or custom-size paper (Windows)



NOTE: Before you can print on custom-size paper, you must set up the custom size in the HP printer software.

1. Load the appropriate paper in the tray. For more information, see [Load paper](#).
2. From the **File** menu in your software application, click **Print**.
3. Make sure your printer is selected.
4. Click the button that opens the **Properties** dialog box.

Depending on your software application, this button might be called **Properties**, **Options**, **Printer Setup**, **Printer Properties**, **Printer**, or **Preferences**.



NOTE: To set print settings for all print jobs, make the changes in the HP software provided with the printer. For more information on the HP software, see [Printer management tools](#).

5. Click the **Paper/Quality** tab.
6. On the **Paper/Quality** tab, select the custom size from the **Paper Size** drop-down list.



NOTE: If you change the paper size, be sure to load the correct paper in the input tray and set the paper size on the printer control panel.

7. Select any other print settings that you want, and then click **OK**.
8. Click **Print** or **OK** to begin printing.

To print on special or custom-size paper (OS X)

Before you can print on custom-size paper, you must set up the custom size in the HP software.

1. Load the appropriate paper in the tray.
2. Create the new custom paper size.
 - a. In the software you want to print from, click **File**, and then click **Print**.
 - b. Make sure your printer is selected.

- c. Click **Manage Custom Sizes** in the **Paper Size** pop-up menu.
If you do not see options on the Print dialog, click **Show Details**.
 - d. Click **+**, and then select the new item in the list and type a name for the custom paper size.
 - e. Enter the height and width for your custom paper.
 - f. Click **Done** or **OK**, and then click **Save**.
3. Use the created custom paper size to print.
 - a. From the **File** menu in your software application, click **Print**.
 - b. Make sure your printer is selected.
 - c. Choose the custom paper size name you created in the **Paper Size** pop-up menu.
 - d. Select any other print settings you want, and then click **Print**.

Print on both sides (duplexing)

To print on both sides of the page (Windows)

1. Load paper in the tray. For more information, see [Load paper](#).
2. From your software, select **Print**.
3. Make sure your printer is selected.
4. Click the button that opens the **Properties** dialog box.
Depending on your software application, this button might be called **Properties**, **Options**, **Printer Setup**, **Printer Properties**, **Printer**, or **Preferences**.



NOTE: To set print settings for all print jobs, make the changes in the HP software provided with the printer. For more information on the HP software, see [Printer management tools](#).

5. Select the appropriate options on the **Printing Shortcuts** tab.

To change other print settings, click the other tabs.

For more printing tips, see [Tips for print success](#).



NOTE: If you change the paper size, be sure to load the correct paper in the input tray and set the paper size on the printer control panel.

6. Click **OK** to close the **Properties** dialog box.
7. Click **Print** or **OK** to begin printing.

To print on both sides of the page (OS X)

1. From the **File** menu in your software, choose **Print**.
2. In the Print dialog, choose **Layout** from the pop-up menu.
3. Choose the type of binding you want for your two-sided pages, and then click **Print**.

Print from mobile device

You can use your printer to print documents and photos directly from your mobile devices such as a smartphone or tablet.

- **iOS:** Use the Print option from the Share menu. No setup is required since iOS AirPrint is preinstalled. For more information about AirPrint, see [Print with AirPrint™](#).
- **Android:** Download and enable the HP Print Service Plugin (supported by most Android devices) from the Google Play Store.

You can also use the HP All-in-One Printer Remote app to set up and use your HP printer for printing and sharing documents. Install it from the app store for your mobile device.

For help enabling mobile printing, visit the HP Mobile Printing website at www.hp.com/go/mobileprinting . If a local version of this website is not available in your country/region or language, you might be directed to the HP Mobile Printing website in another country/region or language.

Print with AirPrint™

Printing using Apple's AirPrint is supported for iOS 4.2 and Mac OS X 10.7 or later. Use AirPrint to print wirelessly to the printer from an iPad (iOS 4.2), iPhone (3GS or later), or iPod touch (third generation or later) in the following mobile applications:

- Mail
- Photos
- Safari
- Supported third-party applications, for example Evernote

To use AirPrint, ensure the following:

- The printer must be connected to the same network as your AirPrint enabled device. For more information about using AirPrint and about which HP products are compatible with AirPrint, visit the HP Mobile Printing website at www.hp.com/go/mobileprinting . If a local version of this website is not available in your country/region or language, you might be directed to the HP Mobile Printing site in another country/region or language.
- Load paper that matches the paper settings of the printer (see [Load paper](#) for more information). Accurately setting the paper size for the paper that is loaded, enables a mobile device to know what paper size it is printing.

Tips for print success

You can print your document on both sides of the paper. For more information, see [Print on both sides \(duplexing\)](#).

Ink tips

- If the print quality is not acceptable, see [Printing issues](#) for more information.
- Use Original HP cartridges.

Original HP cartridges are designed and tested with HP printers and papers to help you easily produce great results, time after time.



NOTE: HP cannot guarantee the quality or reliability of non-HP supplies. Product service or repairs required as a result of using a non-HP supply will not be covered under warranty.

If you believe you purchased Original HP cartridges, go to www.hp.com/go/anticounterfeit.

- Install both the black and color cartridges correctly.

For more information, see [Replace the cartridges](#).

- Check the estimated ink levels in the cartridges to make sure there is sufficient ink.

Ink level warnings and indicators provide estimates for planning purposes only.

For more information, see [Check the estimated ink levels](#).



NOTE: When you receive a low-ink warning message, consider having a replacement cartridge available to avoid possible printing delays. You do not need to replace the cartridges until print quality becomes unacceptable.

- Always turn off the printer with  (the Power button) to allow the printer to protect the nozzles.

Paper loading tips

For more information, also see [Load paper](#).

- Ensure the paper is loaded in the input tray properly, and set the correct media size and media type. Upon loading paper in input tray, you will be prompted to set the media size and media type.
- Load a stack of paper (not just one page). All the paper in the stack should be of the same size and type to avoid a paper jam.
- Load paper with the print-side down.
- Ensure that paper loaded in the input tray lays flat and the edges are not bent or torn.
- Adjust the paper-width guides in the input tray to fit snugly against all paper. Make sure the guides do not bend the paper in the tray.
- Ensure that the input tray is fully inserted into the printer before you start printing.

Printer settings tips (Windows)

- To change default print settings, click **Print**, and then click **Set Preferences** in the HP printer software.

To open the HP printer software, see [Open the HP printer software \(Windows\)](#) for more information.

- To select the number of pages to print per sheet, on the **Finishing** tab of the printer driver, select the appropriate option from the **Pages per sheet** drop-down list.
- If you want to change the page orientation, on the **Finishing** tab of the printer driver, select the appropriate option from the **Orientation** area.
- You can use printing shortcut to save time setting printing preferences. A printing shortcut stores the setting values that are appropriate for a particular kind of job, so that you can set all the options with a single click.

To use it, go to the **Printing Shortcuts** tab, select a printing shortcut, and then click **OK**.

To add a new printing shortcut, after making settings, click **Save As** and enter a name, and then click **OK**.

To delete a printing shortcut, select it, and then click **Delete**.



NOTE: You cannot delete the default printing shortcuts.

Printer settings tips (OS X)

- On the Print dialog, use the **Paper Size** pop-up menu to select the size of paper loaded in the printer.
- On the Print dialog, choose the **Media & Quality (Paper Type/Quality** in OS X v10.8 Mountain Lion) pop-up menu and select the appropriate paper type and quality.

Notes

- Original HP cartridges are designed and tested with HP printers and papers to help you easily produce great results, time after time.



NOTE: HP cannot guarantee the quality or reliability of non-HP supplies. Product service or repairs required as a result of using a non-HP supply will not be covered under warranty.

If you believe you purchased Original HP cartridges, go to www.hp.com/go/anticounterfeit.

- Ink level warnings and indicators provide estimates for planning purposes only.



NOTE: When you receive a low-ink warning message, consider having a replacement cartridge available to avoid possible printing delays. You do not need to replace the cartridges until print quality becomes unacceptable.

4 Web Services

The printer offers innovative, web-enabled solutions that can help you quickly access the Internet, obtain documents, and print them faster and with less hassle—and all without using a computer.

 **NOTE:** To use these web features, the printer must be connected to the Internet (either using an Ethernet cable or wireless connection). You cannot use these web features if the printer is connected using a USB cable.

This section contains the following topics:

- [What are Web Services?](#)
- [Set up Web Services](#)
- [Use Web Services](#)
- [Remove Web Services](#)

What are Web Services?

HP ePrint

- **HP ePrint** is a free service from HP that allows you to print to your HP ePrint-enabled printer anytime, from any location. It's as simple as sending an email to the email address assigned to your printer when you enable Web Services on the printer. No special drivers or software are needed. If you can send an email, you can print from anywhere, using **HP ePrint** .

 **NOTE:** You can sign up for an account on [HP Connected](#) (This site might not be available in all countries/regions.), and sign in to configure the ePrint settings.

Once you have signed up for an account on [HP Connected](#) (This site might not be available in all countries/regions.), you can sign in to view your **HP ePrint** job status, manage your **HP ePrint** printer queue, control who can use your printer's **HP ePrint** email address to print, and get help for **HP ePrint** .

Set up Web Services

Before you set up Web Services, make sure your printer is connected to the Internet using either an Ethernet or wireless connection.

To set up Web Services, use one of the following methods.

To set up Web Services using the printer control panel

1. On the printer control panel, from the Home screen, select **Setup** , and then press OK .
2. Select **Web Services**, and then press OK .
3. Press the OK button to accept the HP Connected Terms of Use and set up Web Services.
4. If you are prompted to allow the printer to check for updates automatically, press OK . In the **Printer Update** screen, select **Automatically**, and then press OK .

 **NOTE:** When updates are available, follow the on-screen instructions to update the printer.

To set up Web Services using the embedded web server

1. Open the EWS. For more information, see [Embedded web server](#).
2. Click the **Web Services** tab.
3. In the **Web Services Settings** section, click **Setup** , click **Continue**, and follow the on-screen instructions to accept the terms of use.
4. If prompted, choose to allow the printer to check for and install printer updates.

 **NOTE:** When updates are available, they are automatically downloaded and installed, and then the printer restarts.

 **NOTE:** If prompted for proxy settings and if your network uses proxy settings, follow the on-screen instructions to set up a proxy server. If you do not have the proxy details, contact your network administrator or the person who set up the network.

5. When the printer is connected to the server, the printer prints an information page. Follow the instructions on the information page to finish the setup.

Use Web Services

- [Print with HP ePrint](#)

Print with HP ePrint

HP ePrint allows you to print to your HP ePrint-enabled printer anytime, from any location.

Before you can use **HP ePrint** , make sure the printer is connected to an active network providing Internet access.

To print a document using HP ePrint

1. Make sure Web Services have been set up successfully.
For more information, see [Set up Web Services](#).
2. On the printer control panel, from the Home screen, scroll down to select **HP ePrint** , and then press OK . Find the **HP ePrint** email address on the screen.
3. Email your document to the printer.

- a. On your computer or mobile device, open your email application.

 **NOTE:** For information about using the email application on your computer or mobile device, see the documentation provided with the application.

- b. Create a new email and attach the document to print.
- c. Send the email to the printer email address.

The printer prints the attached document.

 **NOTE:** Enter only the **HP ePrint** email address in the "To" field. Do not enter any additional email addresses in the other fields. The **HP ePrint** server does not accept email print jobs if there are multiple addresses in the "To" field or any address in the "Cc" field."

 **NOTE:** The email will be printed once it is received. As with any email, there is no guarantee when or whether it will be received. You can check the print status on [HP Connected](#) (This site might not be available in all countries/regions.).

 **NOTE:** Documents printed with **HP ePrint** may appear different from the original. Style, formatting, and text flow may differ from the original document. For documents that need to be printed with a higher quality (such as legal documents), we recommend that you print from the software application on your computer, where you will have more control over what your printout looks like.

Remove Web Services

Use the following instructions to remove Web Services.

To remove Web Services using the printer control panel

1. On the printer control panel, from the Home screen, select **Setup** , and then press OK .
2. Select **Web Services**, and then press OK .
3. From the **Web Services Settings** screen, select **Remove Web Services**, and then press OK .



5 Work with cartridges

This section contains the following topics:

- [Information on cartridges and the printhead](#)
- [Some color ink is used even when printing with black cartridge only](#)
- [Check the estimated ink levels](#)
- [Replace the cartridges](#)
- [Order cartridges](#)
- [Store printing supplies](#)
- [Anonymous usage information storage](#)
- [Cartridge warranty information](#)

Information on cartridges and the printhead

The following tips help maintain HP cartridges and ensure consistent print quality.

- The instructions in this user guide are for replacing cartridges, and are not intended for first time installation. For the first time installation, follow the instructions in the setup poster provided with the printer.
- When you turn the printer off, always use  (the Power button). This allows the printer to cap the printhead and protect it from damage.
- Do not clean the printhead unnecessarily. This wastes ink and shortens the life of the cartridges.
- Handle cartridges carefully. Dropping, jarring, or rough handling during installation can cause temporary printing problems.
- If you are transporting the printer, do the following to prevent ink leaking from the printer or other damage from occurring to the printer:
 - Make sure you turn off the printer by pressing  (the Power button). Wait until all sounds of internal motion stop before unplugging the printer.
 - The printer must be transported sitting flat; it should not be placed on its side, back, front, or top.

 **CAUTION:** HP recommends that you replace any missing cartridges as soon as possible to avoid print quality issues and possible extra ink usage or damage to the ink system. Never turn off the printer when cartridges are missing.

 **NOTE:** This printer is not designed to use continuous ink systems. To resume printing, remove continuous ink system and install original HP (or compatible) cartridges.

 **NOTE:** This printer is designed for ink cartridges to be used until they are empty. Refilling cartridges prior to depletion might cause your printer to fail. If this happens, insert a new cartridge (either genuine HP or compatible) to continue printing.

Some color ink is used even when printing with black cartridge only

Ink is used in a number of ways throughout the inkjet printing process. In general, ink in a cartridge is used for printing documents, photographs and other such materials. Some ink, however, must be used to maintain the health of the printhead; some ink is residual; and some ink evaporates. For more information on ink usage, visit www.hp.com/go/learnaboutsupplies and click **HP Ink**. (You might need to select your country/region using the **Select Country** button on the page.)

Check the estimated ink levels

You can check the estimated ink levels from the printer software or from the printer control panel.

To check the estimated ink levels from the printer control panel

1. From the Home screen, select **Ink Information**, and then press OK.
2. Select **Estimated Levels** (selected by default), and then press OK.

To check the estimated ink levels from the HP printer software (Windows)

1. Open the HP printer software.
2. In the printer software, from the main menu on the top, click **Estimated Cartridge Levels**.

To check the ink levels from the HP printer software (OS X)

1. Open HP Utility.
HP Utility is located in the **Hewlett-Packard** folder in the **Applications** folder at the top level of the hard disk.
2. Select the HP OfficeJet Pro 8210 from the list of devices at the left of the window.
3. Click **Supplies Status**.
The estimated ink levels appear.
4. Click **All Settings** to return to the **Information and Support** pane.

 **NOTE:** If you have installed a refilled or remanufactured cartridge, or a cartridge that has been used in another printer, the ink level indicator might be inaccurate or unavailable.

 **NOTE:** Ink level alerts and indicators provide estimates for planning purposes only. When you receive a low-ink alert, consider having a replacement cartridge available to avoid possible printing delays. You do not have to replace the cartridges until you are prompted to.

 **NOTE:** Ink from the cartridges is used in the printing process in a number of different ways, including in the initialization process, which prepares the printer and cartridges for printing, and in printhead servicing, which keeps print nozzles clear and ink flowing smoothly. In addition, some residual ink is left in the cartridge after it is used. For more information, see www.hp.com/go/inkusage.

Replace the cartridges

If you do not already have replacement cartridges for the printer, see [Order cartridges](#). Not all cartridges are available in all countries/regions.

⚠ CAUTION: HP recommends that you replace any missing cartridges as soon as possible to avoid print quality issues and possible extra ink usage or damage to the ink system. Never turn off the printer when cartridges are missing.

For information on recycling used ink supplies, see [HP inkjet supplies recycling program](#).

To replace the cartridges

1. Make sure the printer is turned on.
2. Open the cartridge access door.

📝 NOTE: Wait until the print carriage stops moving before proceeding.

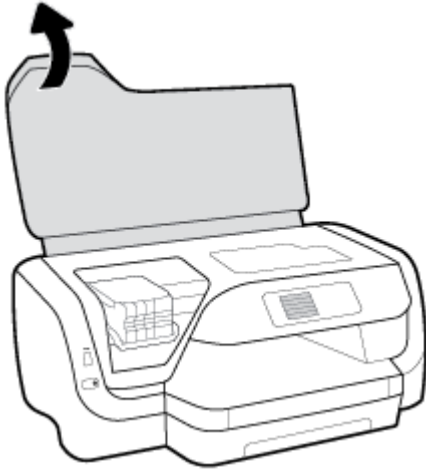

3. Press the front of the cartridge to release it, and then remove it from the slot.

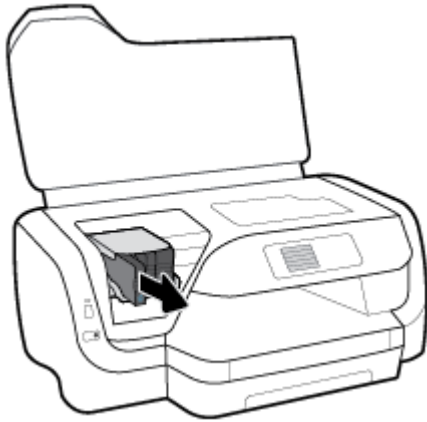
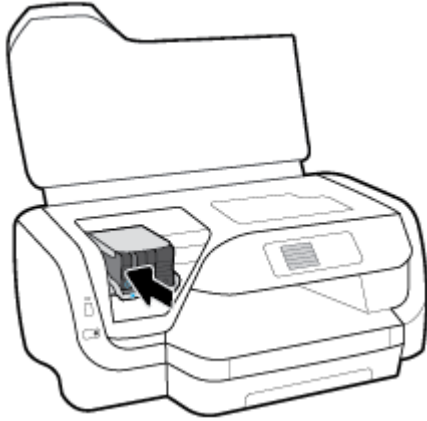

4. Remove the new cartridge from its packaging.
5. Slide the cartridge into the empty slot until it clicks securely into the slot.

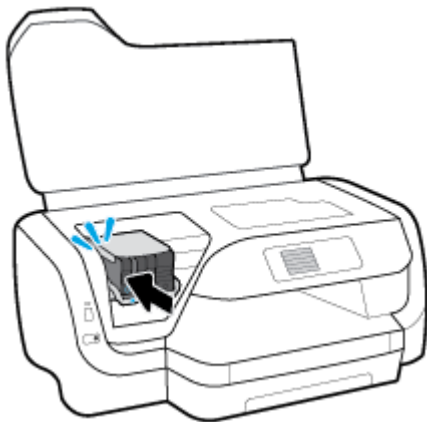

Make sure that the color on the cartridge matches the color on the slot.

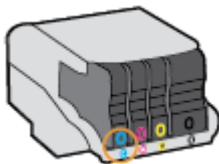

6. Repeat steps 3 through 5 for each cartridge you are replacing.
7. Close the cartridge access door.

Order cartridges

To order cartridges, go to www.hp.com. (At this time, some portions of the HP website are available in English only.) Ordering cartridges online is not supported in all countries/regions. However, many countries have information on ordering by telephone, locating a local store and printing a shopping list. In addition, you can visit the www.hp.com/buy/supplies page to obtain information about purchasing HP products in your country.

Use only the replacement cartridges that have the same cartridge number as the cartridge you are replacing. You can find the cartridge number in the following places:

- On the label of the cartridge you are replacing.
- On a sticker inside the printer. Open the cartridge access door to locate the sticker.
- In the embedded web server, by clicking the **Tools** tab, and then, under **Product Information** clicking **Ink Gauge**. For more information, see [Embedded web server](#).

 **NOTE:** The **Setup** cartridge that comes with the printer is not available for separate purchase.

Store printing supplies

- Keep all cartridges in the original sealed packages until they are needed.
- Cartridges can be left in the printer for extended periods of time. However, to assure optimal cartridge health, be sure to turn off the printer properly by pressing  (the Power button).
- Store cartridges at room temperature (15-35° C or 59-95° F).

Anonymous usage information storage

The HP cartridges used with this printer contain a memory chip that assists in the operation of the printer. In addition, this memory chip stores a limited set of anonymous information about the usage of the printer, which might include the following: the number of pages printed using the cartridge, the page coverage, frequency of printing, and the printing modes used.

This information helps HP design future printers to meet our customers' printing needs. The data collected from the cartridge memory chip does not contain information that can be used to identify a customer or user of the cartridge or their printer.

HP collects a sampling of the memory chips from cartridges returned to HP's free return and recycling program (HP Planet Partners: www.hp.com/recycle). The memory chips from this sampling are read and studied in order to improve future HP printers. HP partners who assist in recycling this cartridge might have access to this data, as well.

Any third party possessing the cartridge might have access to the anonymous information on the memory chip. If you prefer to not allow access to this information, you can render the chip inoperable. However, after you render the memory chip inoperable, the cartridge cannot be used in an HP printer.

If you are concerned about providing this anonymous information, you can make this information inaccessible by turning off the memory chip's ability to collect the printer's usage information.

To turn off the collecting usage information function

1. On the printer control panel, from the Home screen, select **Setup** , and then press OK .
2. Select **Printer Settings** , and then press OK .
3. Select **Preferences** , and then press OK .
4. Scroll down to select **Store Anonymous Usage Information**, and then press OK .
5. Select **Off** , and then press OK .

 **NOTE:** You can continue to use the cartridge in the HP printer if you turn off the memory chip's ability to collect the printer's usage information.

Cartridge warranty information

The HP cartridge warranty is applicable when the product is used in its designated HP printing device. This warranty does not cover HP ink products that have been refilled, remanufactured, refurbished, misused, or tampered with.

During the warranty period, the product is covered as long as the HP ink is not depleted and the end of warranty date has not been reached. The end of warranty date, in YYYY/MM format, can be found on the product.

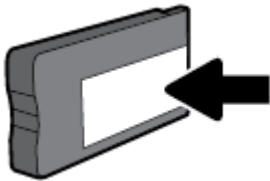

6 Network setup

Additional advanced settings are available from the printer's home page (embedded web server or EWS). For more information, see [Embedded web server](#).

This section contains the following topics:

- [Set up the printer for wireless communication](#)
- [Change network settings](#)
- [Use Wi-Fi Direct](#)

Set up the printer for wireless communication

- [Before you begin](#)
- [Set up the printer on your wireless network](#)
- [Change the connection type](#)
- [Test the wireless connection](#)
- [Turn on or off the wireless capability of the printer](#)



NOTE: If you encounter problems connecting the printer, see [Network and connection issues](#).



TIP: For more information about setting up and using the printer wirelessly, visit the HP Wireless Printing Center (www.hp.com/go/wirelessprinting).

Before you begin

Ensure the following:

- The printer is not connected to the network using an Ethernet cable.
- The wireless network is set up and working properly.
- The printer and the computers that use the printer are on the same network (subnet).

While connecting the printer, you might be prompted to enter the wireless network name (SSID) and a wireless password.

- The wireless network name is the name of your wireless network.
- The wireless password prevents other people from connecting to your wireless network without your permission. Depending on the level of security required, your wireless network might use either a WPA passphrase or WEP key.



If you have not changed the network name or the security passkey since setting up your wireless network, you can sometimes find them on the back or side of the wireless router.

If you cannot find the network name or the security password or cannot remember this information, see the documentation provided with your computer or with the wireless router. If you still cannot find this information, contact your network administrator or the person who set up the wireless network.

Set up the printer on your wireless network

Use the Wireless Setup Wizard from the printer control panel display to set up wireless communication.

 **NOTE:** Before you proceed, go through the list at [Before you begin](#).

1. From the printer control panel, press  (the **Wireless** button).
2. Press  (the Selection button) to select **Settings**.
3. Select **Wireless Settings**, and then press OK .
4. Select **Wireless Setup Wizard**, and then press OK .
5. Follow the display instructions to complete the setup.

If you are already using the printer with a different type of connection, such as a USB connection, follow the instructions in [Change the connection type](#) to set up the printer on your wireless network.

Change the connection type

After you have installed the HP printer software and connected the printer to your computer or to a network, you can use the software to change the connection type (for example, from a USB connection to a wireless connection).

 **NOTE:** Connecting an Ethernet cable turns off the wireless capability of the printer.

To change from an Ethernet connection to a wireless connection (Windows)

1. Remove the Ethernet cable from the printer.
2. Open the printer software after the installation.

Run the Wireless Setup Wizard to make the wireless connection. For more information, see [Set up the printer on your wireless network](#).

To change from a USB connection to a wireless network (Windows)

Before you proceed, go through the list at [Before you begin](#).

1. Open the HP printer software. For more information, see [Open the HP printer software \(Windows\)](#).
2. Click **Tools**.
3. Click **Device Setup & Software**.
4. Select **Convert a USB connected printer to wireless**. Follow the onscreen instructions.

To change from a USB connection to a wireless network (OS X)

1. Connect the printer to your wireless network.
2. Use 123.hp.com to change the software connection to wireless for this printer.



Learn more about how to change from a USB to wireless connection. [Click here to go online for more information](#). At this time, this website might not be available in all languages.

To change from a wireless connection to a USB or Ethernet connection (Windows)

- Connect the USB or Ethernet cable to the printer.

To change from a wireless connection to a USB or Ethernet connection (OS X)



Add the printer to the print queue.

1. Open **System Preferences** .
2. Depending on your operating system, click **Printers & Scanners** .
3. Select your printer in the left pane and click - at the bottom of the list. Do the same for the fax entry, if there is one for the current connection.
4. Open HP Utility.
HP Utility is located in the **HP** folder in the **Applications** folder at the top level of the hard disk.
5. Choose **Devices > Setup New Device** and follow the prompts.

Test the wireless connection

Print the wireless test report for information about the printer wireless connection. The wireless test report provides information about the printer status, hardware (MAC) address, and IP address. If there is a problem with the wireless connection or if a wireless connection attempt failed, the wireless test report also provides diagnostic information. If the printer is connected to a network, the test report displays details about the network settings.

To print the wireless test report

1. From the printer control panel,press  (the **Wireless** button).
2. Press  (the Selection button) to select **Settings**.
3. Select **Print Reports**, and then press OK .
4. Select **Test Report**, and then press OK .



Turn on or off the wireless capability of the printer

The blue Wireless light on the printer control panel is lit when the wireless capability of the printer is on.



NOTE: Connecting an Ethernet cable to the printer automatically turns off the wireless capability and the Wireless light.

If the printer has never been connected to a wireless network, turning on the wireless capability will trigger the Wireless Setup Wizard to automatically run.

1. From the printer control panel,press  (the **Wireless** button).
2. Press  (the Selection button) to select **Settings**.
3. Select **Wireless Settings**, and then press OK .
4. Select **Wireless** (selected by default) and then press OK .
5. Select **On** or **Off**, and then press OK .

Change network settings

From the printer control panel, you can set up and manage your printer' wireless connection and perform a variety of network management tasks. This includes viewing and changing network settings, restoring network defaults, and turning the wireless function on or off.

 **CAUTION:** Network settings are provided for your convenience. However, unless you are an advanced user, you should not change some of these settings (such as the link speed, IP settings, default gateway, and firewall settings).

To print network settings

Use one of the following ways:

- From the printer control panel, press  (the **Wireless** button). The network status screen is displayed. Select **Print Info** by pressing the OK button to print the network configuration page.
- From the printer control panel, from the Home screen, select **Setup** and then press OK . Select **Printer Reports**, and then press OK . Select **Network Configuration Page**, and then press OK .

To set the link speed

You can change the speed at which data is transmitted over the network. The default is **Automatic**.

1. From the printer control panel, from the Home screen, select **Network**, and then press OK .
2. Select **Ethernet Settings** (selected by default), and then press OK .
3. Select **Advanced Settings**, and then press OK .
4. Scroll down to select **Link Speed**, and then press OK .
5. Select the appropriate option that matches your network hardware, and then press OK .

To change IP settings

The default IP setting for the IP settings is **Automatic**, which sets the IP settings automatically. If you are an advanced user and want to use different settings (such as the IP address, subnet mask, or the default gateway), you can change them manually.

 **TIP:** Before setting a manual IP address, it is recommended to first connect the printer to the network using Automatic mode. This allows the router to configure the printer with other needed settings like subnet mask, default gateway and DNS address.

 **CAUTION:** Be careful when manually assigning an IP address. If you enter an invalid IP address during the installation, your network components cannot connect with the printer.

1. From the printer control panel, from the Home screen, select **Network**, and then press OK .
2. Select **Ethernet Settings** or **Wireless Settings**, and then press OK .
3. Select **Advanced Settings**, and then press OK .
4. Select **IP Settings** (selected by default), and then press OK .
5. If a warning message that indicates changing the IP address removes the printer from the network appears, press OK to continue.
6. **Automatic** is selected by default. To change the settings manually, select **Manual**, and then press OK . Enter the appropriate information for the following settings:
 - **IP Address**
 - **Subnet Mask**
 - **Default Gateway**
 - **DNS Address**

- To enter the information of a setting, select the desired setting, and then press OK .
7. After entering your changes, select **Apply** by pressing **—** (the Selection).
 8. Press OK .

Use Wi-Fi Direct

With Wi-Fi Direct, you can print wirelessly from a computer, smart phone, tablet, or other wireless-capable device—without connecting to an existing wireless network.

Guidelines for using Wi-Fi Direct

- Make sure your computer or mobile device has the necessary software.
 - If you are using a computer, make sure you have installed the printer software provided with the printer.

If you have not installed the HP printer software on the computer, connect to Wi-Fi Direct first and then install the printer software. Select **Wireless** when prompted by the printer software for a connection type.
 - If you are using a mobile device, make sure you have installed a compatible printing app. For more information about mobile printing, visit www.hp.com/global/us/en/eprint/mobile_printing_apps.html.
- Make sure Wi-Fi Direct for your printer is turned on.
- Up to five computers and mobile devices can use the same Wi-Fi Direct connection.
- Wi-Fi Direct can be used while the printer is also connected either to a computer using a USB cable or to a network using a wireless connection.
- Wi-Fi Direct cannot be used to connect a computer, mobile device, or printer to the Internet.
- Wi-Fi Direct password: If the connection method of Wi-Fi Direct on the printer is set to **Automatic**, the password will always be '12345678'. If the connection method of Wi-Fi Direct on the printer is set to **Manual**, the password will be a randomly generated 8-digit code.

To obtain the Wi-Fi Direct password of the printer, from the printer control panel, press  (the Wi-Fi Direct button). The Wi-Fi Direct password will be displayed on the control panel display.

To turn on Wi-Fi Direct

1. Do either of the following:
 - From the printer control panel, press  (the Wi-Fi Direct button).
 - From the printer control panel, from the Home screen, scroll down to select Wi-Fi Direct, and then press OK .
2. Press **—** (the Selection button) to select **Settings**.
3. Select Wi-Fi Direct (selected by default) and then press OK .
4. Select **On** and then press OK .

To print from a wireless-capable mobile device that supports Wi-Fi Direct

Make sure you have installed the latest version of HP Print Service Plugin on your mobile device. You can download this plugin from the Google Play application store.

1. Make sure you have turned on Wi-Fi Direct on the printer.
2. Turn on Wi-Fi Direct on your mobile device. For more information, see the documentation provided with the mobile device.
3. From your mobile device, select a document from a print enabled application, and then select the option to print the document.

The list of available printers appears.

4. From the list of available printers, choose the Wi-Fi Direct name shown such as **DIRECT-**-HP OfficeJet Pro XXXX** (where ** are the unique characters to identify your printer and XXXX is the printer model located on the printer) to connect your mobile device.

If the mobile device is not automatically connected to the printer, follow the instructions on the printer control panel to connect to the printer. If a PIN code is displayed on the printer control panel, enter the PIN code on your mobile device.

When the mobile device is successfully connected to the printer, the printer starts printing.

To print from a wireless-capable mobile device that does not support Wi-Fi Direct

Make sure you have installed a compatible printing app on your mobile device. For more information, visit the HP Mobile Printing website at www.hp.com/go/mobileprinting. If a local version of this website is not available in your country/region or language, you might be directed to the HP Mobile Printing site in another country/region or language.

1. Make sure you have turned on Wi-Fi Direct on the printer.
2. Turn on the Wi-Fi connection on your mobile device. For more information, see the documentation provided with the mobile device.



NOTE: If your mobile device does not support Wi-Fi, you are not able to use Wi-Fi Direct.

3. From the mobile device, connect to a new network. Use the process you normally use to connect to a new wireless network or hotspot. Choose the Wi-Fi Direct name from the list of wireless networks shown such as **DIRECT-**-HP OfficeJet Pro XXXX** (where ** are the unique characters to identify your printer and XXXX is the printer model located on the printer).

Enter the Wi-Fi Direct password when prompted.

4. Print your document.

To print from a wireless-capable computer (Windows)

1. Make sure you have turned on Wi-Fi Direct on the printer.
2. Turn on the computer's Wi-Fi connection. For more information, see the documentation provided with the computer.



NOTE: If your computer does not support Wi-Fi, you are not able to use Wi-Fi Direct.

3. From the computer, connect to a new network. Use the process you normally use to connect to a new wireless network or hotspot. Choose the Wi-Fi Direct name from the list of wireless networks shown

such as **DIRECT-**-HP OfficeJet Pro XXXX** (where ** are the unique characters to identify your printer and XXXX is the printer model located on the printer).

Enter the Wi-Fi Direct password when prompted.

4. Proceed to step 5 if the printer has been installed and connected to the computer over a wireless network. If the printer has been installed and connected to your computer with a USB cable, follow the steps below to install the printer software using the Wi-Fi Direct connection.
 - a. Open the HP printer software. For more information, see [Open the HP printer software \(Windows\)](#).
 - b. Click **Tools**.
 - c. Click **Device Setup & Software**, and then select **Connect a new printer**.

 **NOTE:** If you have previously installed the printer over USB and want to convert to Wi-Fi Direct, do not select the **Convert a USB connected printer to wireless** option.

 - d. When the **Connection Options** software screen appears, select **Wireless**.
 - e. Select your HP printer from the detected printer list.
 - f. Follow the onscreen instructions.
5. Print your document.

To print from a wireless-capable computer (OS X)

1. Make sure you have turned on Wi-Fi Direct on the printer.
2. Turn on Wi-Fi on the computer.

For more information, see the documentation provided by Apple.
3. Click the Wi-Fi icon and choose the Wi-Fi Direct name, such as **DIRECT-**-HP OfficeJet Pro XXXX** (where ** are the unique characters to identify your printer and XXXX is the printer model located on the printer).

If Wi-Fi Direct is turned on with security, enter the password when prompted.
4. Add the printer.
 - a. Open **System Preferences**.
 - b. Click **Printers & Scanners**.
 - c. Click + below the list of printers at the left.
 - d. Select the printer from the list of detected printers (the word “Bonjour” is listed the right column beside the printer name), and click **Add**.



[Click here](#) for online troubleshooting for Wi-Fi Direct, or for more help with setting up Wi-Fi Direct. At this time, this website might not be available in all languages.

7 Printer management tools

This section contains the following topics:

- [Toolbox \(Windows\)](#)
- [HP Utility \(OS X\)](#)
- [Embedded web server](#)
- [HP Web Jetadmin software](#)

Toolbox (Windows)

The Toolbox provides maintenance information about the printer.

 **NOTE:** The Toolbox can be installed from the HP Software CD if the computer meets the system requirements. System requirements can be found in the Readme file, which is available on the HP printer software CD provided with your printer.

To open the Toolbox

1. Open the HP printer software. For more information, see [Open the HP printer software \(Windows\)](#).
2. Click **Print**.
3. Click **Maintain Your Printer**.

HP Utility (OS X)

HP Utility contains tools to configure print settings, calibrate the printer, order supplies online, and find website support information.

 **NOTE:** The features available in HP Utility vary depending on the selected printer.

Ink level warnings and indicators provide estimates for planning purposes only. When you receive a low-ink warning message, consider having a replacement cartridge available to avoid possible printing delays. You do not need to replace cartridges until the print quality becomes unacceptable.

Double-click HP Utility in the **HP** folder in the **Applications** folder.

Embedded web server

When the printer is connected to a network, you can use the printer's embedded web server (EWS) to view status information, change settings, and manage it from your computer.

 **NOTE:** To view or change some settings, you might need a password.

 **NOTE:** You can open and use the embedded web server without being connected to the Internet. However, some features are not available.

- [About cookies](#)
- [Open the embedded web server](#)

- Embedded web server cannot be opened

About cookies

The embedded Web server (EWS) places very small text files (cookies) on your hard drive when you are browsing. These files let the EWS recognize your computer the next time you visit. For example, if you have configured the EWS language, a cookie helps remember which language you have selected so that the next time you access the EWS, the pages are displayed in that language. Some cookies (such as the cookie that stores customer-specific preferences) are stored on the computer until you clear them manually.

You can configure your browser to accept all cookies, or you can configure it to alert you every time a cookie is offered, which allows you to decide which cookies to accept or refuse. You can also use your browser to remove unwanted cookies.

Depending on your printer, if you disable cookies, you also disable one or more of the following features:

- Using some setup wizards
- Remembering the EWS browser language setting
- Personalizing the EWS Home page

For information about how to change your privacy and cookie settings and how to view or delete cookies, see the documentation available with your Web browser.

Open the embedded web server

You can access the embedded web server through either a network or Wi-Fi Direct.

To open the embedded web server through a network

1. Find out the IP address or hostname of the printer by pressing  (the **Wireless** button) on the printer control panel or by printing a network configuration page.



NOTE: The printer must be on a network and must have an IP address.

2. In a supported web browser on your computer, type the IP address or hostname assigned to the printer.

For example, if the IP address is 123.123.123.123, type the following address into the web browser:
`http://123.123.123.123.`

To open the embedded web server through Wi-Fi Direct

1. From the printer control panel, from the Home screen, scroll down to select Wi-Fi Direct, and then press OK.
2. If the **Wi-Fi Direct Settings** shows that Wi-Fi Direct is **Off**, you need to turn it on.

To turn on Wi-Fi Direct

- a. Press  (the Selection button) to select **Settings**.
- b. Select Wi-Fi Direct (selected by default) and then press OK.
- c. Select **On** and then press OK.

3. From your wireless computer, turn wireless on, search for and connect to the Wi-Fi Direct name, for example: **DIRECT-**-HP OfficeJet Pro XXXX** (where ** are the unique characters to identify your printer and XXXX is the printer model located on the printer).

Enter the Wi-Fi Direct password when prompted.

4. In a supported web browser on your computer, type the following address: `http://192.168.223.1`.

Embedded web server cannot be opened

Check your network setup

- Make sure you are not using a phone cord or a crossover cable to connect the printer to the network.
- Make sure the network cable is securely connected to the printer.
- Make sure the network hub, switch, or router is turned on and working correctly.
- If the printer is connected to a wireless network, make sure the wireless connection is good by printing the wireless test report.
- Sometimes power cycling the router can help restore the ability to connect to the Embedded Web Server.

Check the computer

- Make sure the computer that you are using is connected to the same network as the printer.

Check your web browser

- Make sure the web browser meets the minimum system requirements.
- If your web browser uses any proxy settings to connect to the Internet, try turning off these settings. For more information, see the documentation available with your web browser.
- Make sure JavaScript and cookies are enabled in your web browser. For more information, see the documentation available with your web browser.

Check the printer IP address

- Make sure the printer IP address is correct.

To find out the printer IP address, from the printer control panel, press  (the **Wireless** button). You can see the printer IP address on the control panel display. If you see an IP address similar to 169.254.xxx.xxx, try power cycle the router and the printer as this is an invalid IP address.

To obtain the IP address by printing a network configuration page: From the printer control panel, from the Home screen, select **Setup** and then press OK . Select **Printer Reports**, and then press OK . Select **Network Configuration Page**, and then press OK .

- Ping the printer using the IP address from the command prompt (Windows) or from Network Utility (OS X).



NOTE: OS X Lion and OS X Mountain Lion: Network Utility is located in the **Utilities** folder in the **Applications** folder at the top level of the hard disk.

OS X Mavericks: Open **Finder**, hold down the Option key and choose **System Information** from the **Apple** () menu. Choose **Window > Network Utility**.

For example, if the IP address is 123.123.123.123, type the following at the command prompt (Windows):

```
C:\ping 123.123.123.123
```

Or

In Network Utility (OS X), click the **Ping** tab, type the 123.123.123.123 in the box, and then click **Ping**.

If a reply appears, the IP address is correct. If a time-out response appears, the IP address is incorrect.

 **TIP:** If you are using a computer running Windows, you can visit the HP online support website at www.support.hp.com. This website provides information and utilities that can help you correct many common printer problems.

HP Web Jetadmin software

HP Web Jetadmin is an award-winning, industry-leading tool for efficiently managing a wide variety of networked HP devices, including printers, multifunction products, and digital senders. This single solution allows you to remotely install, monitor, maintain, troubleshoot, and secure your printing and imaging environment — ultimately increasing business productivity by helping you save time, control costs, and protect your investment.

HP Web Jetadmin updates are periodically made available to provide support for specific product features. Visit www.hp.com/go/webjetadmin to learn more about updates, release notes, or support documents.

8 Solve a problem

The information in this section suggests solutions to common problems. If your printer is not operating correctly and these suggestions did not solve your problem, try using one of the support services listed in [HP support](#) to obtain assistance.

This section contains the following topics:

- [Jams issues](#)
- [Printing issues](#)
- [Network and connection issues](#)
- [Printer hardware issues](#)
- [Get help from the printer control panel](#)
- [Understand printer reports](#)
- [Solve problems using Web Services](#)
- [Maintain the printer](#)
- [Restore defaults and settings](#)
- [HP support](#)

Jams issues

What do you want to do?

Clear a paper jam

[Solve paper jam issues.](#)

Use an HP online troubleshooting wizard

Instructions for clearing paper jams and resolving issues with paper or the paper feed.



NOTE: The HP online troubleshooting wizards may not be available in all languages.

Read general instructions in the Help for clearing paper jams

Paper jams can occur in several locations.



CAUTION: To prevent possible damage to the printhead, clear paper jams as soon as possible.

To clear a paper jam from Tray 1

1. Pull Tray 1 out of the printer completely.

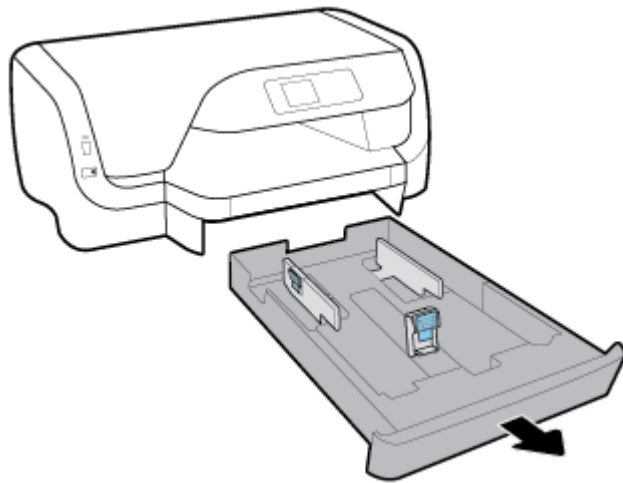

2. Check the gap under the printer where the input tray was. Reach into the gap and remove the jammed paper.

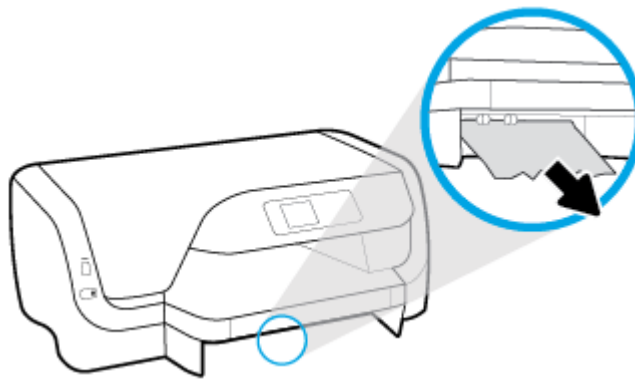

3. Insert the input tray back into the printer.

To clear a paper jam from Tray 2

 **NOTE:** Tray 2 is available with some models of the printer.

- ▲ Pull Tray 2 out of the printer completely, and then remove any jammed paper if possible. If the jam cannot be cleared in this way, do the following:
 - a. Lift the printer off Tray 2.
 - b. Remove any jammed paper from the bottom of the printer or from the input tray.
 - c. Reposition the printer on the top of the input tray.

To clear a paper jam from the print carriage area

1. Open the cartridge access door.

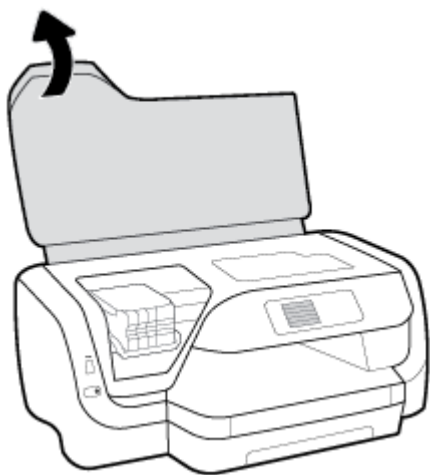

2. If the print carriage is not obstructed, move the print carriage to the rightmost end, and remove the jammed paper with both hands.

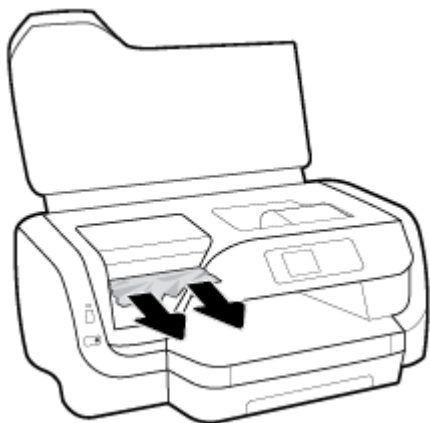

3. If need, move the print carriage to the leftmost end, and remove any jammed or torn pieces of paper.
4. Close the cartridge access door.

To clear a paper jam from the rear of the printer

1. Turn to the rear of the printer.
2. Press the two buttons on the rear access panel and at the same time pull the panel to open it.

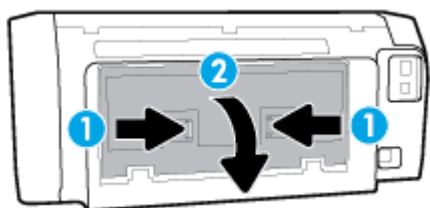

3. Remove any jammed paper.

4. Press the two buttons on the paper path cover, and pull the cover out of the printer completely.

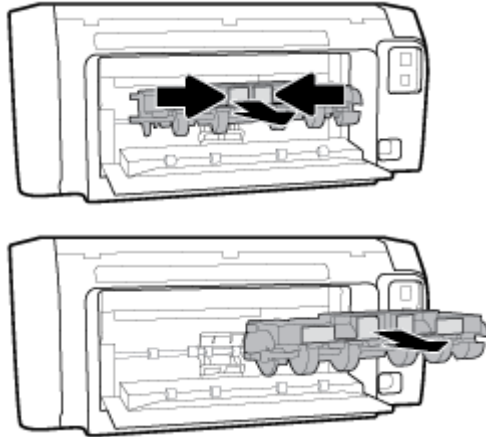

5. Remove any jammed paper.
6. Insert the paper path cover back into the printer.

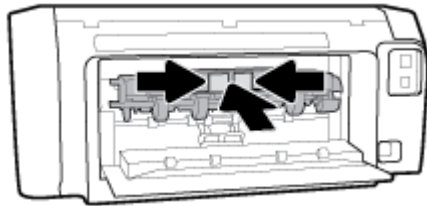

7. Close the rear access panel.
8. Turn to the front of the printer.

Clear a print carriage jam

Resolve a print carriage jam.	Use an HP online troubleshooting wizard If something is blocking the print carriage or it does not move easily, get step-by-step instructions.
---	---

 **NOTE:** The HP online troubleshooting wizards may not be available in all languages.

Read general instructions in the Help for clearing a print carriage jams

To clear a print carriage jam

- ▲ Remove any objects, such as paper, that are blocking the print carriage.

 **NOTE:** Do not use any tools or other devices to remove jammed paper. Always use caution when removing jammed paper from inside the printer.

Learn how to avoid paper jams

To help avoid paper jams, follow these guidelines.

- Remove printed papers from the output tray frequently.
- Make sure that you are printing with paper that is not wrinkled, folded, or damaged.

- Prevent curled or wrinkled paper by storing all unused paper flat in a resealable bag.
- Do not use paper that is too thick or too thin for the printer.
- Make sure that the trays are loaded correctly and are not too full. For more information, see [Load paper](#).
- Ensure that paper loaded in the input tray lays flat and the edges are not bent or torn.
- Do not combine different paper types and paper sizes in the input tray; the entire stack of paper in the input tray must be the same size and type.
- Adjust the paper-width guides in the input tray to fit snugly against all paper. Make sure the paper-width guides do not bend the paper in the input tray.
- Use paper types that are recommended for the printer.
- If the printer is about to run out of paper, allow the printer to run out of paper first, and then add paper. Do not load paper when the printer is printing.
- When removing the input tray, it is recommended to remove the tray completely from the printer to make sure no paper is stuck at the rear of the tray.

Solve paper-feed problems

What kind of problem are you having?

- **Paper is not picked up from a tray**
 - Make sure paper is loaded in the tray. For more information, see [Load paper](#). Fan the paper before loading.
 - Make sure the paper-width guides are set to the correct markings in the tray for the paper size you are loading. Also make sure the paper guides are snug, but not tight, against the stack.
 - Ensure that the stack of paper is aligned with the appropriate paper size lines on the bottom of the input tray, and does not exceed the stack height indicated by one or more label on the side or paper-width guide of the input tray.
 - Make sure paper in the tray is not curled. Uncurl paper by bending it in the opposite direction of the curl.
- **Pages are skewing**
 - Make sure the paper loaded in the input tray is aligned to the paper-width guides. If needed, pull out the input tray from the printer and reload the paper correctly, making sure that the paper guides are aligned correctly.
 - Load paper into the printer only when it is not printing.
- **Multiple pages are being picked up**
 - Make sure the paper-width guides are set to the correct markings in the tray for the paper size you are loading. Also make sure the paper-width guides are snug, but not tight, against the stack.
 - Ensure that the stack of paper is aligned with the appropriate paper size lines on the bottom of the input tray, and does not exceed the stack height indicated by one or more label on the side or paper-width guide of the input tray.
 - Make sure the tray is not overloaded with paper.
 - Use HP paper for optimum performance and efficiency.

Printing issues

What do you want to do?

Fix problems with page not printing (unable to print)

HP Print and Scan Doctor	The HP Print and Scan Doctor is a utility that will try to diagnose and fix the issue automatically. NOTE: This utility is only available for Windows operating system.
Troubleshoot problems with print jobs not printing.	Use an HP online troubleshooting wizard Get step-by-step instructions if the printer is not responding or printing.



NOTE: The HP Print and Scan Doctor and the HP online troubleshooting wizards may not be available in all languages.

Read general instructions in the Help for unable to print issues

To resolve print issues (Windows)



NOTE: Make sure that the printer is turned on and that there is paper in the tray. If you are still unable to print, try the following in order:

1. Check for error messages from the printer control panel and resolve them by following the onscreen instructions.
2. If your computer is connected to the printer with a USB cable, disconnect and reconnect the USB cable. If your computer is connected to the printer with a wireless connection, confirm that the connection is working.
3. Verify that the printer is not paused or offline.

To verify that the printer is not paused or offline

- a. Depending on your operating system, do one of the following:
 - **Windows 10:** From the Windows **Start** menu, click **All apps**, click **Windows System**, click **Control Panel**, and then click **View devices and printers** under **Hardware and Sound** menu.
 - **Windows 8.1 and Windows 8:** Point to or tap the upper-right corner of the screen to open the Charms bar, click the **Settings** icon, click or tap **Control Panel**, and then click or tap **View devices and printers**.
 - **Windows 7:** From the Windows **Start** menu, click **Devices and Printers**.
 - **Windows Vista:** From the Windows **Start** menu, click **Control Panel**, and then click **Printers**.
 - **Windows XP:** From the Windows **Start** menu, click **Control Panel**, and then click **Printers and Faxes**.
- b. Either double-click the icon for your printer or right-click the icon for your printer and select **See what's printing** to open the print queue.
- c. On the **Printer** menu, make sure there are no check marks next to **Pause Printing** or **Use Printer Offline**.
- d. If you made any changes, try to print again.

4. Verify that the printer is set as the default printer.

To verify that the printer is set as the default printer

- a. Depending on your operating system, do one of the following:
 - **Windows 10:** From the Windows **Start** menu, click **All apps**, click **Windows System**, click **Control Panel**, and then click **View devices and printers** under **Hardware and Sound** menu.
 - **Windows 8.1 and Windows 8:** Point to or tap the upper-right corner of the screen to open the Charms bar, click the **Settings** icon, click or tap **Control Panel**, and then click or tap **View devices and printers**.
 - **Windows 7:** From the Windows **Start** menu, click **Devices and Printers**.
 - **Windows Vista:** From the Windows **Start** menu, click **Control Panel**, and then click **Printers**.
 - **Windows XP:** From the Windows **Start** menu, click **Control Panel**, and then click **Printers and Faxes**.
- b. Make sure the correct printer is set as the default printer.

The default printer has a check mark in a black or green circle next to it.
- c. If the wrong printer is set as the default printer, right-click the correct printer and select **Set as Default Printer**.
- d. Try using your printer again.

5. Restart the print spooler.

To restart the print spooler

- a. Depending on your operating system, do one of the following:

Windows 10

- i. From the Windows **Start** menu, click **All apps**, and then click **Windows System**.
- ii. Click **Control Panel**, click **System and Security**, and then click **Administrative Tools**.
- iii. Double-click **Services**.
- iv. Right-click the **Print Spooler**, and then click **Properties**.
- v. On the **General** tab, next to **Startup type**, make sure that **Automatic** is selected.
- vi. If the service is not already running, under **Service status**, click **Start**, and then click **OK**.

Windows 8.1 and Windows 8

- i. Point to or tap the upper-right corner of the screen to open the Charms bar, and then click the **Settings** icon.
- ii. Click or tap **Control Panel**, and then click or tap **System and Security**.
- iii. Click or tap **Administrative Tools**, and then double-click or double-tap **Services**.
- iv. Right-click or touch and hold **Print Spooler**, and then click **Properties**.
- v. On the **General** tab, next to **Startup type**, make sure that **Automatic** is selected.
- vi. If the service is not already running, under **Service status**, click or tap **Start**, and then click or tap **OK**.

Windows 7

- i. From the Windows **Start** menu, click **Control Panel, System and Security**, and then **Administrative Tools**.
- ii. Double-click **Services**.
- iii. Right-click the **Print Spooler**, and then click **Properties**.
- iv. On the **General** tab, next to **Startup type**, make sure that **Automatic** is selected.
- v. If the service is not already running, under **Service status**, click **Start**, and then click **OK**.

Windows Vista

- i. From the Windows **Start** menu, click **Control Panel, System and Maintenance, Administrative Tools**.
- ii. Double-click **Services**.
- iii. Right-click the **Print Spooler service**, and then click **Properties**.
- iv. On the **General** tab, next to **Startup type**, make sure that **Automatic** is selected.
- v. If the service is not already running, under **Service status**, click **Start**, and then click **OK**.

Windows XP

- i. From the Windows **Start** menu, right click **My Computer**.
 - ii. Click **Manage**, and then click **Services and Applications**.
 - iii. Double-click **Services**, and then select **Print Spooler**.
 - iv. Right-click **Print Spooler**, and click **Restart** to restart the service.
- b. Make sure the correct printer is set as the default printer.
The default printer has a check mark in a black or green circle next to it.
- c. If the wrong printer is set as the default printer, right-click the correct printer and select **Set as Default Printer**.
 - d. Try using your printer again.
6. Restart the computer.
 7. Clear the print queue.

To clear the print queue

- a. Depending on your operating system, do one of the following:
 - **Windows 10:** From the Windows **Start** menu, click **All apps**, click **Windows System**, click **Control Panel**, and then click **View devices and printers** under **Hardware and Sound** menu.
 - **Windows 8.1 and Windows 8:** Point to or tap the upper-right corner of the screen to open the Charms bar, click the **Settings** icon, click or tap **Control Panel**, and then click or tap **View devices and printers**.
 - **Windows 7:** From the Windows **Start** menu, click **Devices and Printers**.

- **Windows Vista:** From the Windows **Start** menu, click **Control Panel**, and then click **Printers**.
 - **Windows XP:** From the Windows **Start** menu, click **Control Panel**, and then click **Printers and Faxes**.
- b. Double-click the icon for your printer to open the print queue.
 - c. On the **Printer** menu, click **Cancel all documents** or **Purge Print Document**, and then click **Yes** to confirm.
 - d. If there are still documents in the queue, restart the computer and try printing again after the computer has restarted.
 - e. Check the print queue again to make sure it is clear, and then try to print again.

To check the power connection and reset the printer

1. Make sure the power cord is firmly connected to the printer.
2. Look at the Power button located on the printer. If it is not lit, the printer is turned off. Press the Power button to turn on the printer.



NOTE: If the printer is not receiving electrical power, connect it to another power outlet.

3. With the printer turned on, disconnect the power cord from the side of the printer.
4. Unplug the power cord from the wall outlet.
5. Wait at least 15 seconds.
6. Plug the power cord back into the wall outlet.
7. Reconnect the power cord to the side of the printer.
8. If the printer does not turn on by itself, press the Power button to turn on the printer.
9. Try using the printer again.

To resolve print issues (OS X)

1. Check for error messages and resolve.
2. Disconnect and reconnect the USB cable.
3. Verify that the product is not paused or offline.

To verify that the product is not paused or offline

- a. In **System Preferences**, click **Print & Fax**.
- b. Click the **Open Print Queue** button.
- c. Click a print job to select it.

Use the following buttons to manage the print job:

- **Delete:** Cancel the selected print job.
- **Hold:** Pause the selected print job.

- **Resume:** Continue a paused print job.
 - **Pause Printer:** Pause all print jobs in the print queue.
- d. If you made any changes, try to print again.
4. Restart the computer.

Fix print quality issues

[Step-by-step instructions for resolving most print quality issues.](#)

[Troubleshoot print quality issues online](#)

Read general instructions in the Help for resolving print quality issues

 **NOTE:** To avoid print quality problems, always turn the printer off using the Power button, and wait until the Power button light goes out before you pull the plug or turn off a power strip. This allows the printer to move the cartridges to a capped position, where they are protected from drying out.

To improve print quality

1. Make sure you are using original HP cartridges.
2. Make sure you are using an appropriate paper type.

Always make sure the paper you are printing on is flat and is not damaged, curled, or wrinkled. For more information, see [Tips for selecting and using paper](#).

For best print quality, use high quality HP paper, or papers that adhere to the ColorLok® standard. For more information, see [Paper basics](#).

For best results when printing images, use HP Advanced Photo Paper.

Store specialty paper in its original packaging inside a resealable plastic bag on a flat surface in a cool, dry place.

When you are ready to print, remove only the paper you plan to use immediately. When you have finished printing, return any unused photo paper to the plastic bag. This prevents the photo paper from curling.

3. Make sure you have selected the appropriate paper type and print resolution in the software print settings.

 **NOTE:** Selecting a higher print quality can result in a printout with higher definition but could use more ink and take longer to print.

4. Check the estimated ink levels to determine if the cartridges are low on ink. For more information, see [Check the estimated ink levels](#). If the cartridges are low on ink, consider replacing them.
5. Print a diagnostics page if the cartridges are not low on ink.

To do this, you must:

- Load Letter, A4, or Legal unused plain white paper into the paper tray.
- Print out the page either using the printer software or the control panel.

To print a diagnostics page from the printer software (Windows)

- a. Open the HP printer software. For more information, see [Open the HP printer software \(Windows\)](#).
- b. In the printer software, click **Print > Maintain Your Printer** to access the printer toolbox.
- c. Click **Print Diagnostic Information** on the **Device Reports** tab to print a diagnostics page.

To print a diagnostics page from the printer software (OS X)

- a. Open HP Utility.



NOTE: HP Utility is located in the **HP** folder in the **Applications** folder at the top level of the hard disk.

- b. Select your printer from the **Devices** list.
- c. Click **Test Page**.
- d. Click the **Print Test Page** button, and follow the onscreen instructions.

To print a diagnostics page from the printer control panel

- a. On the printer control panel, from the Home screen, select **Setup** , and then press OK .
 - b. Select **Printer Reports**, and then press OK .
 - c. Select **Print Quality Report**, and then press OK .
6. If the diagnostic page shows streaks or missing portions of the color and black boxes, perform auto-cleaning of the cartridges or printhead.

To do this, you must:

- Load Letter, A4, or Legal unused plain white paper into the paper tray.
- Perform the cleaning either using the printer software or the control panel.

To clean the cartridges or printhead from the printer software (Windows)

- a. Open the HP printer software. For more information, see [Open the HP printer software \(Windows\)](#).
- b. In the printer software, click **Print > Maintain Your Printer** to access the printer toolbox.
- c. From the **Device Services** tab, click the option to clean, and then follow the onscreen instructions.

To clean the cartridges or printhead from the printer software (OS X)

- a. Open HP Utility.



NOTE: HP Utility is located in the **HP** folder in the **Applications** folder at the top level of the hard disk.

- b. Select your printer from the **Devices** list.
- c. Click **Clean Printheads**.
- d. Click **Clean**, and follow the onscreen instructions.

To clean the cartridges or printhead from the printer control panel

- a. On the printer control panel, from the Home screen, select **Setup** , and then press OK .
- b. Select **Tools**, and then press OK .
- c. Select the option to clean, press OK , then follow the onscreen instructions.

If cleaning the cartridges or printhead does not solve the problem, contact HP support. Go to www.support.hp.com . This website provides information and utilities that can help you correct many common printer problems. If prompted, select your country/region, and then click **All HP Contacts** for information on calling for technical support.

 **CAUTION:** Clean the cartridges or printhead only when necessary. Unnecessary cleaning wastes ink and shortens the life of the printhead.

7. Align the cartridges or printhead.

 **NOTE:** Aligning the cartridges or printhead ensures high-quality output. The printer prompts you to align the cartridges or printhead every time you install a new cartridge. If you remove and reinstall the same cartridge, it will not prompt you to align as the printer remembers the alignment values for that cartridge.

To do this, you must:

- Load Letter, A4, or Legal unused plain white paper into the paper tray.
- Perform the alignment either using the printer software or the control panel.

To align the cartridges or printhead from the printer software (Windows)

- a. Open the HP printer software. For more information, see [Open the HP printer software \(Windows\)](#).
- b. In the printer software, click **Print > Maintain Your Printer** to access the printer toolbox window.
- c. From the **Device Services** tab, click the option to align.
The printer prints an alignment sheet.
- d. Follow the instructions on the printer screen to align the cartridges.

To align the cartridges or printhead from the printer software (OS X)

- a. Open HP Utility.

 **NOTE:** HP Utility is located in the **HP** folder in the **Applications** folder at the top level of the hard disk.

- b. Select your printer from the **Devices** list.
- c. Click **Align** and follow the onscreen instructions.

To align the cartridges or printhead from the printer control panel

- a. On the printer control panel, from the Home screen, select **Setup** , and then press OK .
- b. Select **Tools**, and then press OK .
- c. Select the option to align, press OK , then follow the onscreen instructions.

Network and connection issues

What do you want to do?

Fix wireless connection

Choose one of the following troubleshooting options.

HP Print and Scan Doctor	The HP Print and Scan Doctor is a utility that will try to diagnose and fix the issue automatically. NOTE: This utility is only available for Windows operating system.
Use an HP online troubleshooting wizard	Troubleshoot a firewall or antivirus issue , if you suspect that it is preventing your computer from connecting to the printer. <ul style="list-style-type: none">• Troubleshoot your wireless problem, whether your printer has never been connected or it was connected and is no longer working.• Troubleshoot a firewall or antivirus issue, if you suspect that it is preventing your computer from connecting to the printer.



NOTE: The HP Print and Scan Doctor and the HP online troubleshooting wizards may not be available in all languages.

Read general instructions in the Help for wireless troubleshooting

Check the network configuration or print the wireless test report to assist in diagnosing network connection issues.

1. From the printer control panel, from the Home screen, select **Network**, and then press OK .
2. Select **Print Reports**, and then press OK .
3. Select **Configuration Page** or **Test Report**, and then press OK .

Find network settings for wireless connection

Choose one of the following troubleshooting options.

HP Print and Scan Doctor	The HP Print and Scan Doctor is a utility that can tell you the network name (SSID) and password (network key). NOTE: This utility is only available for Windows operating system. To check the wireless settings, open the HP Print and Scan Doctor, click the Network tab at the top, select Show Advanced Info , and then select Show Wireless Info . You can also find the wireless settings information by selecting Open router web page on the Network tab.
Use an HP online troubleshooting wizard	Learn how to find your network name (SSID) and wireless password.



NOTE: The HP Print and Scan Doctor and the HP online troubleshooting wizards may not be available in all languages.

Fix Wi-Fi Direct connection

Use an HP online troubleshooting wizard	Troubleshoot your Wi-Fi Direct problem or learn how to configure Wi-Fi Direct.
---	--



NOTE: The HP online troubleshooting wizards may not be available in all languages.

Read general instructions in the Help for Wi-Fi Direct troubleshooting

1. Check the printer to confirm that Wi-Fi Direct is turned on:
 - ▲ From the printer control panel, from the Home screen, scroll down to select Wi-Fi Direct, and then press OK .
2. From your wireless computer or mobile device, turn on the Wi-Fi connection, and then search for and connect to the Wi-Fi Direct name of your printer.
3. Enter the Wi-Fi Direct password when prompted.
4. If you are using a mobile device, make sure you have installed a compatible printing app. For more information about mobile printing, visit www.hp.com/global/us/en/eprint/mobile_printing_apps.html.

Fix Ethernet connection

Check the following:

- The network is operational and the network hub, switch, or router is turned on.
- The Ethernet cable is plugged into the printer properly and the Ethernet light near the connector is turned on.
- Antivirus programs, including spyware protection programs, are not impacting your network connection to the printer. If you know that antivirus or firewall software is preventing your computer from connecting to the printer, [use the HP online firewall troubleshooter](#) to help solve the problem.
- [HP Print and Scan Doctor](#)

Run the HP Print and Scan Doctor to troubleshoot the issue automatically. The utility will try to diagnose and fix the issue. The HP Print and Scan Doctor may not be available in all languages.

Printer hardware issues



TIP: Run the [HP Print and Scan Doctor](#) to diagnose and automatically fix printing, scanning, and copying issues. The application is only available in some languages.

The printer shuts down unexpectedly



- Check the power and power connections.
- Make sure the printer's power cord is connected firmly to a functioning power outlet.

Printhead alignment fails

- If the alignment process fails, make sure you have loaded unused, plain white paper into the input tray. If you have colored paper loaded in the input tray when you align the cartridges, the alignment fails.
- If the alignment process fails repeatedly, you may need to clean the printhead, or you might have a defective sensor. To clean the printhead, see [Maintain the printhead and cartridges](#).
- If cleaning the printhead does not solve the problem, contact HP support. Go to www.support.hp.com . This website provides information and utilities that can help you correct many common printer problems. If prompted, select your country/region, and then click **All HP Contacts** for information on calling for technical support.

Resolve printer failure

Complete the following steps to resolve such problems.

1. Press  (the Power button) to turn off the printer.
2. Unplug the power cord, and then plug in the power cord again.
3. Press  (the Power button) to turn on the printer.

If this problem persists, write down the error code provided in the message, and then contact HP support. For more information about contacting HP support, see [HP support](#).

Get help from the printer control panel

You can use the printer's help topics to learn more about the printer, and some help topics include animations that guide you through procedures, such as clearing jams.

To access the Help Menu from the Home screen or contextual help for a screen, press  (the **Help** button) on the printer control panel.

Understand printer reports

You can print the following reports to help troubleshoot problems with the printer.

- [Printer status report](#)
- [Network configuration page](#)
- [Print quality report](#)
- [Wireless test report](#)

Printer status report

Use the printer status report to view current printer information and cartridge status. Also use the printer status report to help you troubleshoot problems with the printer.

The printer status report also contains a log of recent events.

If you need to call HP, it is often useful to print the printer status report before calling.

Network configuration page

If the printer is connected to a network, you can print a network configuration page to view the network settings for the printer and a list of networks detected by your printer. The last page of the report includes a list of all detectable wireless networks in the area, along with signal strength and the channels being used. This might help you select a channel for your network which is not heavily used by other networks (which will improve network performance).

You can use the network configuration page to help troubleshoot network connectivity problems. If you need to call HP, it is often useful to print this page before calling.

Print quality report

Print quality problems can have many causes—software settings, a poor image file, or the printing system itself. If you are unhappy with the quality of your prints, a Print Quality Diagnostic page can help you determine if the printing system is working correctly.

Wireless test report

When you print the Wireless Test Report, a number of tests are run to check various conditions of the printer wireless connection. The report shows the results of the tests. If an issue is discovered, message along with how to fix it is provided at the top of the report. Some key wireless configuration details are provided at the bottom section of the report.

Solve problems using Web Services

If you are having problems using Web Services, such as **HP ePrint**, check the following:

- Make sure the printer is connected to the Internet using an Ethernet or wireless connection.



NOTE: You cannot use these web features if the printer is connected using a USB cable.

- Make sure the latest product updates have been installed on the printer.
- Make sure Web Services is enabled on the printer. For more information, see [Set up Web Services](#).
- Make sure the network hub, switch, or router is turned on and working correctly.
- If you are connecting the printer using an Ethernet cable, make sure you are not using a phone cord or a crossover cable to connect the printer to the network, and that the Ethernet cable is securely connected to the printer. For more information, see [Network and connection issues](#).
- If you are connecting the printer using a wireless connection, make sure the wireless network is functioning properly. For more information, see [Network and connection issues](#).
- If you are using **HP ePrint**, check the following:
 - Make sure the printer's email address is correct.
 - Make sure that the printer's email address is the only address listed in the "To" line of the email message. If other email addresses are listed in the "To" line, the attachments you are sending might not print.
 - Make sure you are sending documents that meet the **HP ePrint** requirements. For more information, visit [HP Connected](#) (This site might not be available in all countries/regions.).
- If your network uses proxy settings when connecting to the Internet, make sure the proxy settings you are entering are valid:
 - Check the settings being used by the web browser you are using (such as Internet Explorer, Firefox, or Safari).
 - Check with the IT administrator or person who set up your firewall.

If the proxy settings used by your firewall have changed, you must update these settings in either the printer control panel or the embedded web server. If these settings are not updated, you will not be able to use Web Services.

For more information, see [Set up Web Services](#).



TIP: For additional help on setting up and using Web Services, visit [HP Connected](#) (This site might not be available in all countries/regions.).

Maintain the printer

What do you want to do?

Clean the exterior

 **WARNING!** Before cleaning the printer, turn the printer off by pressing  (the Power button) and unplug the power cord from the electrical socket.

Use a soft, damp, lint-free cloth to wipe dust, smudges, and stains off of the case. Keep fluids away from the interior of the printer, as well as from the printer control panel.

Maintain the printhead and cartridges

If you are experiencing problems with printing, you might have a problem with the printhead. You should perform the procedures in the following sections only when directed to do so for resolving print quality issues.

Performing the aligning and cleaning procedures unnecessarily can waste ink and shorten the life of the cartridges.

- Clean the printhead if your printed output is streaked or has any incorrect or missing colors.

There are three stages of cleaning. Each stage lasts about two minutes, uses one sheet of paper, and uses an increasing amount of ink. After each stage, review the quality of the printed page. You should only initiate the next phase of cleaning if the print quality is poor.

If print quality still seems poor after you complete all stages of cleaning, try aligning the printer. If print quality problems persist after cleaning and aligning, contact HP support. For more information, see [HP support](#).

- Align the printer when the printer status page shows streaking or white lines through any of the blocks of color, or if you are having print quality issues with your printouts.

The printer automatically aligns the printhead during the initial setup.

 **NOTE:** Cleaning uses ink, so clean the printhead only when necessary. The cleaning process takes a few minutes. Some noise might be generated in the process.

Always use the power button to turn off the printer. Turning the printer off improperly can cause print quality problems.

To clean or align the cartridges or printhead

1. Load Letter, A4, or legal unused plain white paper into the input tray.
2. On the printer control panel, from the Home screen, select **Setup**, and then press OK.
3. Select **Tools**, and then press OK.
4. Select the desired option and then press OK. Then follow the onscreen instructions.

 **NOTE:** You can also do the same from the HP printer software or embedded web server (EWS). To access the software or EWS, see [Open the HP printer software \(Windows\)](#) or [Open the embedded web server](#).

Restore defaults and settings

If you disable some functions or change some settings and want to change them back, you can restore the printer to the original factory settings or network settings.

To restore the printer to the original factory defaults

1. From the printer control panel, from the Home screen, select **Setup** , and then press OK .
2. Select **Tools**, and then press OK .
3. Select **Restore**, and then press OK .
4. A warning message appears which indicates all configured settings will be deleted and the original factory settings will be restored. Press the OK button to continue.

To restore the printer to the original network settings

1. From the printer control panel, from the Home screen, select **Network**, and then press OK .
2. Select **Restore Network Settings**, and then press OK .
A message appears stating that the network defaults will be restored.
3. Select **Yes** by pressing **=** (the Selection button).
4. Print the network configuration page and verify that the network settings have been reset.

 **NOTE:** Previously configured wireless settings are removed when you reset the printer network settings.

 **TIP:** You can visit the HP online support website at www.support.hp.com for information and utilities that can help you correct many common printer problems.

(Windows) Run the **HP Print and Scan Doctor** to diagnose and automatically fix printing, scanning, and copying issues. The application is only available in some languages.

HP support

For the latest product updates and support information, visit the printer support website at www.support.hp.com . HP online support provides a variety of options for help with your printer:



Drivers & downloads: Download software drivers and updates, as well as product manuals and documentation that came in the box with your printer.



HP support forums: Visit HP Support Forums for answers to common questions and issues. You can view questions posted by other HP customers, or sign in and post your own questions and comments.



Troubleshooting: Use HP online tools to detect your printer and find recommended solutions.

Contact HP

If you need help from an HP technical support representative to solve a problem, visit the [Contact Support website](#). The following contact options are available at no cost for in-warranty customers (HP agent-assisted support for out-of-warranty customers may require a fee):



Chat with an HP support agent online.



Call an HP support agent.

When contacting HP support, be prepared to provide the following information:

- Product name (Located on the printer, such as HP OfficeJet Pro 8210)
- Product number (located near the cartridge access area)

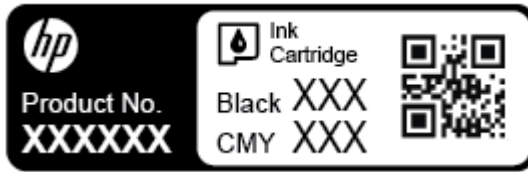

- Serial number (located on the back or bottom of the printer)

Register printer

By taking just a few quick minutes to register, you can enjoy quicker service, more efficient support, and product support alerts. If you did not register your printer while installing the software, you can register now at <http://www.register.hp.com>.

Additional warranty options

Extended service plans are available for the printer at additional costs. Go to www.support.hp.com, select your country/region and language, then explore the extended warranty options available for your printer.

A Technical information

This section contains the following topics:

- [Specifications](#)
- [Regulatory information](#)
- [Environmental product stewardship program](#)

Specifications

For more information, visit www.support.hp.com . Select your country or region. Click **Product Support & Troubleshooting**. Enter the name shown on the front of the printer, and then select **Search**. Click **Product information**, and then click **Product specifications**.

System requirements

- System requirements for Windows systems can be found in the Readme file, which is available on the HP printer software CD provided with your printer. System requirements for Mac OS X can be found at www.support.hp.com .
- For information about future operating system releases and support, visit the HP online support website at www.support.hp.com .

Environmental specifications

- Operating temperature: 5° to 40° C (41° to 104° F)
- Operating humidity: 15 to 80% RH non-condensing
- Recommended operating conditions: 15° to 32° C (59° to 90° F)
- Recommended relative humidity: 20 to 80% noncondensing

Input tray capacity

- Plain paper sheets (60 to 105 g/m² [16 to 28 lb]): Up to 250
- Envelopes: Up to 30
- Index cards: Up to 50
- Photo paper sheets: Up to 50

Output tray capacity

- Plain paper sheets (60 to 105 g/m² [16 to 28 lb]): Up to 150
- Envelopes: Up to 30
- Index cards: Up to 80
- Photo paper sheets: Up to 100

Paper size and weights

For the list of supported paper sizes, see the HP printer software.

- Plain paper: 60 to 105 g/m² (16 to 28 lb)
- Envelopes: 75 to 90 g/m² (20 to 24 lb)
- Cards: Up to 200 g/m² (110 lb index maximum)
- Photo paper: 300 g/m² (80 lb)

Print specifications

- Print speeds vary according to the complexity of the document and printer model
- Method: drop-on-demand thermal officejet
- Language: PCL 6, PCL 5, PDF, PostScript
- Print resolution:

For a list of supported print resolutions, visit the [printer support website](#).

- Print margins:

For margin settings of different media, visit the [printer support website](#).

Cartridge yield

- Visit www.hp.com/go/learnaboutsupplies for more information on estimated cartridge yields.

Regulatory information

The printer meets product requirements from regulatory agencies in your country/region.

This section contains the following topics:

- [Regulatory Model Number](#)
- [FCC statement](#)
- [VCCI \(Class B\) compliance statement for users in Japan](#)
- [Notice to users in Japan about the power cord](#)
- [Notice to users in Korea](#)
- [Noise emission statement for Germany](#)
- [European Union Regulatory Notice](#)
 - [Products with wireless functionality](#)
- [Visual display workplaces statement for Germany](#)
- [Declaration of conformity](#)
- [Regulatory information for wireless products](#)
 - [Exposure to radio frequency radiation](#)
 - [Notice to users in Brazil](#)
 - [Notice to users in Canada](#)

- [Notice to users in Taiwan](#)
- [Notice to users in Mexico](#)
- [Notice to users in Japan](#)
- [Notice to users in Korea](#)

Regulatory Model Number

For regulatory identification purposes, your product is assigned a Regulatory Model Number. The Regulatory Model Number for your product is SNPRC-1603-01. This regulatory number should not be confused with the marketing name (HP OfficeJet Pro 8210 series) or product number (D9L63).

FCC statement

FCC statement

The United States Federal Communications Commission (in 47 CFR 15.105) has specified that the following notice be brought to the attention of users of this product.

This equipment has been tested and found to comply with the limits for a Class B digital device, pursuant to Part 15 of the FCC Rules. These limits are designed to provide reasonable protection against harmful interference in a residential installation. This equipment generates, uses and can radiate radio frequency energy and, if not installed and used in accordance with the instructions, may cause harmful interference to radio communications. However, there is no guarantee that interference will not occur in a particular installation. If this equipment does cause harmful interference to radio or television reception, which can be determined by turning the equipment off and on, the user is encouraged to try to correct the interference by one or more of the following measures:

- Reorient or relocate the receiving antenna.
- Increase the separation between the equipment and the receiver.
- Connect the equipment into an outlet on a circuit different from that to which the receiver is connected.
- Consult the dealer or an experienced radio/TV technician for help.

For further information, contact:

Manager of Corporate Product Regulations
HP Inc. 1501 Page Mill Road,
Palo Alto, CA 94304, U.S.A.

Modifications (part 15.21)

The FCC requires the user to be notified that any changes or modifications made to this device that are not expressly approved by HP may void the user's authority to operate the equipment.

This device complies with Part 15 of the FCC Rules. Operation is subject to the following two conditions: (1) this device may not cause harmful interference, and (2) this device must accept any interference received, including interference that may cause undesired operation.

VCCI (Class B) compliance statement for users in Japan

この装置は、クラスB情報技術装置です。この装置は、家庭環境で使用することを目的としていますが、この装置がラジオやテレビジョン受信機に近接して使用されると、受信障害を引き起こすことがあります。取扱説明書に従って正しい取り扱いをして下さい。

VCCI-B

Notice to users in Japan about the power cord

製品には、同梱された電源コードをお使い下さい。
同梱された電源コードは、他の製品では使用出来ません。

Notice to users in Korea

B 급 기기 (가정용 방송통신기기)	이 기기는 가정용(B급)으로 전자파적합등록을 한 기기로서 주로 가정에서 사용하는 것을 목적으로 하며, 모든 지역에서 사용할 수 있습니다.
------------------------	--

Noise emission statement for Germany

Geräuschemission

LpA < 70 dB am Arbeitsplatz im Normalbetrieb nach DIN 45635 T. 19

European Union Regulatory Notice



Products bearing the CE marking comply with one or more of the following EU Directives as may be applicable: Low Voltage Directive 2006/95/EC, EMC Directive 2004/108/EC, Ecodesign Directive 2009/125/EC, R&TTE Directive 1999/5/EC, RoHS Directive 2011/65/EU. Compliance with these directives is assessed using applicable European Harmonised Standards. The full Declaration of Conformity can be found at the following

website: www.hp.com/go/certificates (Search with the product model name or its Regulatory Model Number (RMN), which may be found on the regulatory label.)

The point of contact for regulatory matters is:

HP GmbH, Dept./MS: HQ-TRE, Herrenberger Strasse 140, 71034 Boeblingen, GERMANY

Products with wireless functionality

EMF

- This product meets international guidelines (ICNIRP) for exposure to radio frequency radiation. If it incorporates a radio transmitting and receiving device that in normal use, a separation distance of 20 cm ensures that radio frequency exposure levels comply with EU requirements.

Wireless functionality in Europe

- This product is designed for use without restrictions in all EU countries plus Iceland, Liechtenstein, Norway and Switzerland.

Visual display workplaces statement for Germany

GS-Erklärung (Deutschland)

Das Gerät ist nicht für die Benutzung im unmittelbaren Gesichtsfeld am Bildschirmarbeitsplatz vorgesehen. Um störende Reflexionen am Bildschirmarbeitsplatz zu vermeiden, darf dieses Produkt nicht im unmittelbaren Gesichtsfeld platziert werden.

Declaration of conformity



DECLARATION OF CONFORMITY

according to ISO/IEC 17050-1 and EN 17050-1

DoC #: SNPRC-1603-01-B

Supplier's Name:	Hewlett Packard Singapore (Pte) Ltd
Supplier's Address:	138 Depot Road, #04-01, Singapore 109683
declares, that the product Product Name and Model:²⁾	HP OfficeJet Managed P25220dw / HP OfficeJet Pro 8210 Printer / HP OfficeJet Pro 8211 Printer
Regulatory Model Number:¹⁾	SNPRC-1603-01
Product Options:	All
Power Adapter:	E3E01-60132 / E3E01-60079 (For China and India only), E3E01-60078 (For Korea only)
Radio Module Number:	SDG0B-1392

conforms to the following Product Specifications and Regulations:

EMC:	CISPR22:2008 / EN55022:2010 Class B CISPR24:2010 / EN55024:2010 EN 61000-3-2:2014 EN 61000-3-3:2013 FCC CFR 47 Part 15 Class B ICES – 003, Issue 5 Class B
Safety:	IEC 60950-1:2005 (2 nd Edition) +A1:2009 +A2:2013 EN 60950-1:2006 +A11:2009 +A1:2010 +A12:2011 +A2:2013 EN 62479:2010
Telecom:	EN 301 489-1 V1.9.2:2011 / EN 301 489-17 V2.2.1:2012 EN 300 328 V1.8.1:2012 EN 62311:2008
Energy:	Regulation (EC) No. 1275/2008 ENERGY STAR® Qualified Imaging Equipment Operational Mode (OM) Test Procedure EN 50564:2011 IEC 62301:2011
RoHS:	EN 50581: 2012

The product herewith complies with the requirements of the Low Voltage Directive 2006/95/EC, the EMC Directive 2004/108/EC, the Machinery Directive 2006/42/EC, the R&TTE Directive 1999/5/EC, the Ecodesign Directive 2009/125/EC, RoHS Directive 2011/65/EU, the Ecodesign Directive 2009/125/EC, the R&TTE Directive 1999/5/EC and carries the  marking accordingly.

This device complies with part 15 of the FCC Rules. Operation is subject to the following two conditions:

(1) This device may not cause harmful interference, and (2) this device must accept any interference received, including interference that may cause undesired operation.

Additional Information:

- 1) This product is assigned a Regulatory Model Number which stays with the regulatory aspects of the design. The Regulatory Model Number is the main product identifier in the regulatory documentation and test reports, this number should not be confused with the marketing name or the product numbers.
- 2) The product was tested in a typical configuration.
- 3) The internal power adapter E3E01-60079 is for India and China market only, while internal power adaptor E3E01-60078 is for Korea market only.
- 4) WIFI module operates only in 2.4 GHz band within this product.

Singapore
7 December 2015

Product Regulations Manager
HP Singapore Inkjet Printing Solutions

Local contact for regulatory topics only:

EU: HP Deutschland GmbH, HQ-TRE, Schickardstrasse 32, 71034 Boeblingen, Germany
U.S.: HP Inc, 1501 Page Mill Road, Palo Alto, CA 94304, U.S.A. 650-857-1501

www.hp.eu/certificates

Regulatory information for wireless products

This section contains the following regulatory information pertaining to wireless products:

- [Exposure to radio frequency radiation](#)
- [Notice to users in Brazil](#)
- [Notice to users in Canada](#)
- [Notice to users in Taiwan](#)
- [Notice to users in Mexico](#)
- [Notice to users in Japan](#)
- [Notice to users in Korea](#)

Exposure to radio frequency radiation

Exposure to radio frequency radiation



Caution The radiated output power of this device is far below the FCC radio frequency exposure limits. Nevertheless, the device shall be used in such a manner that the potential for human contact during normal operation is minimized. This product and any attached external antenna, if supported, shall be placed in such a manner to minimize the potential for human contact during normal operation. In order to avoid the possibility of exceeding the FCC radio frequency exposure limits, human proximity to the antenna shall not be less than 20 cm (8 inches) during normal operation.

Notice to users in Brazil

Aviso aos usuários no Brasil

Este equipamento opera em caráter secundário, isto é, não tem direito à proteção contra interferência prejudicial, mesmo de estações do mesmo tipo, e não pode causar interferência a sistemas operando em caráter primário.

Notice to users in Canada

Notice to users in Canada/Note à l'attention des utilisateurs canadiens

Under Industry Canada regulations, this radio transmitter may only operate using an antenna of a type and maximum (or lesser) gain approved for the transmitter by Industry Canada. To reduce potential radio interference to other users, the antenna type and its gain should be so chosen that the equivalent isotropically radiated power (e.i.r.p.) is not more than that necessary for successful communication.

This device complies with Industry Canada licence-exempt RSS standard(s). Operation is subject to the following two conditions: (1) this device may not cause interference, and (2) this device must accept any interference, including interference that may cause undesired operation of the device.

WARNING! Exposure to Radio Frequency Radiation The radiated output power of this device is below the Industry Canada radio frequency exposure limits. Nevertheless, the device should be used in such a manner that the potential for human contact is minimized during normal operation.

To avoid the possibility of exceeding the Industry Canada radio frequency exposure limits, human proximity to the antennas should not be less than 20 cm (8 inches).

Conformément au Règlement d'Industrie Canada, cet émetteur radioélectrique ne peut fonctionner qu'avec une antenne d'un type et d'un gain maximum (ou moindre) approuvé par Industrie Canada. Afin de réduire le brouillage radioélectrique potentiel pour d'autres utilisateurs, le type d'antenne et son gain doivent être choisis de manière à ce que la puissance isotrope rayonnée équivalente (p.i.r.e.) ne dépasse pas celle nécessaire à une communication réussie.

Cet appareil est conforme aux normes RSS exemptes de licence d'Industrie Canada. Son fonctionnement dépend des deux conditions suivantes : (1) cet appareil ne doit pas provoquer d'interférences nuisibles et (2) doit accepter toutes interférences reçues, y compris des interférences pouvant provoquer un fonctionnement non souhaité de l'appareil.

AVERTISSEMENT relatif à l'exposition aux radiofréquences. La puissance de rayonnement de cet appareil se trouve sous les limites d'exposition de radiofréquences d'Industrie Canada. Néanmoins, cet appareil doit être utilisé de telle sorte qu'il soit mis en contact le moins possible avec le corps humain.

Afin d'éviter le dépassement éventuel des limites d'exposition aux radiofréquences d'Industrie Canada, il est recommandé de maintenir une distance de plus de 20 cm entre les antennes et l'utilisateur.

Notice to users in Taiwan

低功率電波輻射性電機管理辦法

第十二條

經型式認證合格之低功率射頻電機，非經許可，公司、商號或使用者均不得擅自變更頻率、加大功率或變更設計之特性及功能。

第十四條

低功率射頻電機之使用不得影響飛航安全及干擾合法通信；經發現有干擾現象時，應立即停用，並改善至無干擾時方得繼續使用。

前項合法通信，指依電信法規定作業之無線電通信。低功率射頻電機須忍受合法通信或工業、科學及醫藥用電波輻射性電機設備之干擾。

Notice to users in Mexico

Aviso para los usuarios de México

La operación de este equipo está sujeta a las siguientes dos condiciones: (1) es posible que este equipo o dispositivo no cause interferencia perjudicial y (2) este equipo o dispositivo debe aceptar cualquier interferencia, incluyendo la que pueda causar su operación no deseada.
Para saber el modelo de la tarjeta inalámbrica utilizada, revise la etiqueta regulatoria de la impresora.

Notice to users in Japan

この機器は技術基準適合証明又は工事設計認証を受けた無線設備を搭載しています。

Notice to users in Korea

해당 무선설비는 전파혼신 가능성이 있으므로 인명안전과 관련된 서비스는 할 수 없음

Environmental product stewardship program

HP is committed to providing quality products in an environmentally sound manner. Design for recycling has been incorporated into this product. The number of materials has been kept to a minimum while ensuring proper functionality and reliability. Dissimilar materials have been designed to separate easily. Fasteners and other connections are easy to locate, access, and remove using common tools. High priority parts have been designed to access quickly for efficient disassembly and repair. For more information, visit HP's Commitment to the Environment website at:

www.hp.com/hpinfo/globalcitizenship/environment

- [Eco-Tips](#)
- [European Union Commission Regulation 1275/2008](#)
- [Paper](#)
- [Plastics](#)
- [Material safety data sheets](#)
- [Recycling program](#)
- [HP inkjet supplies recycling program](#)
- [Power consumption](#)
- [Disposal of waste equipment by users](#)
- [Chemical substances](#)
- [Restriction of hazardous substance \(Ukraine\)](#)
- [Restriction of hazardous substance \(India\)](#)
- [China SEPA Eco Label User Information](#)

- [China Energy Label for Printer, Fax and Copier](#)
- [The Table of Hazardous Substances/Elements and their Content \(China\)](#)
- [EPEAT](#)
- [Battery disposal in Taiwan](#)
- [California Perchlorate Material Notice](#)
- [EU Battery Directive](#)
- [Battery notice for Brazil](#)

Eco-Tips

HP is committed to helping customers reduce their environmental footprint. Please visit the HP Environmental Programs and Initiatives website for more information on HP's environmental initiatives.

www.hp.com/hpinfo/globalcitizenship/environment/

European Union Commission Regulation 1275/2008

For product power data, including the power consumption of the product in networked standby if all wired network ports are connected and all wireless network ports are activated, please refer to section P14 'Additional Information' of the product IT ECO Declaration at www.hp.com/hpinfo/globalcitizenship/environment/productdata/itecodesktop-pc.html.

Paper

This product is suited for the use of recycled paper according to DIN 19309 and EN 12281:2002.

Plastics

Plastic parts over 25 grams are marked according to international standards that enhance the ability to identify plastics for recycling purposes at the end of product life.

Material safety data sheets

Material safety data sheets (MSDS) can be obtained from the HP website at:

www.hp.com/go/msds

Recycling program

HP offers an increasing number of product return and recycling programs in many countries/regions, and partners with some of the largest electronic recycling centers throughout the world. HP conserves resources by reselling some of its most popular products. For more information regarding recycling of HP products, please visit:

www.hp.com/recycle

HP inkjet supplies recycling program

HP is committed to protecting the environment. The HP Inkjet Supplies Recycling Program is available in many countries/regions, and lets you recycle used print cartridges and ink cartridges free of charge. For more information, go to the following website:

www.hp.com/hpinfo/globalcitizenship/environment/recycle/

Power consumption

HP printing and imaging equipment marked with the ENERGY STAR® logo is certified by the U.S. Environmental Protection Agency. The following mark will appear on ENERGY STAR certified imaging products:



Additional ENERGY STAR certified imaging product model information is listed at: www.hp.com/go/energystar

Disposal of waste equipment by users



This symbol means do not dispose of your product with your other household waste. Instead, you should protect human health and the environment by handing over your waste equipment to a designated collection point for the recycling of waste electrical and electronic equipment. For more information, please contact your household waste disposal service, or go to <http://www.hp.com/recycle>.

Chemical substances

HP is committed to providing our customers with information about the chemical substances in our products as needed to comply with legal requirements such as REACH (*Regulation EC No 1907/2006 of the European Parliament and the Council*). A chemical information report for this product can be found at: www.hp.com/go/reach.

Restriction of hazardous substance (Ukraine)

Технічний регламент щодо обмеження використання небезпечних речовин (Україна)

Обладнання відповідає вимогам Технічного регламенту щодо обмеження використання деяких небезпечних речовин в електричному та електронному обладнанні, затвердженого постановою Кабінету Міністрів України від 3 грудня 2008 № 1057

Restriction of hazardous substance (India)

Restriction of hazardous substances (India)

This product complies with the "India E-waste (Management and Handling) Rule 2011" and prohibits use of lead, mercury, hexavalent chromium, polybrominated biphenyls or polybrominated diphenyl ethers in concentrations exceeding 0.1 weight % and 0.01 weight % for cadmium, except for the exemptions set in Schedule 2 of the Rule.

China SEPA Eco Label User Information

中国环境标识认证产品用户说明

噪声大于63.0Db(A)的办公设备不宜放置于办公室内，请在独立的隔离区域使用。

如需长时间使用本产品或打印大量文件，请确保在通风良好的房间内使用。

如您需要确认本产品处于零能耗状态，请按下电源关闭按钮，并将插头从电源插座断开。

您可以使用再生纸，以减少资源耗费。

China Energy Label for Printer, Fax and Copier

复印机、打印机和传真机能源效率标识 实施规则

依据“复印机、打印机和传真机能源效率标识实施规则”，该打印机具有中国能效标识。标识上显示的能效等级和操作模式值根据“复印机、打印机和传真机能效限定值及能效等级”标准（“GB 21521”）来确定和计算。

1. 能效等级

产品能效等级分为3级，其中1级能效最高。能效限定值根据产品类型和打印速度由标准确定。能效等级则根据基本功耗水平以及网络接口和内存等附加组件和功能的功率因子之和来计算。

2. 能效信息

喷墨打印机

- 操作模式功率

睡眠状态的能耗按照 GB 21521 标准来衡量和计算。该数据以瓦特 (W) 表示。

- 待机功率

待机状态是产品连接到电网电源上功率最低的状态。该状态可以延续无限长时间，且使用者无法改变此状态下产品的功率。对于“成像设备”产品，“待机”状态通常相当于“关闭”状态，但也可能相当于“准备”状态或“睡眠”状态。该数据以瓦特 (W) 表示。

- 睡眠状态预设延迟时间

出厂前由制造商设置的时间决定了该产品在完成主功能后进入低耗模式（例如睡眠、自动关机）的时间。该数据以分钟表示。

- 附加功能功率因子之和

网络接口和内存等附加功能的功率因子之和。该数据以瓦特 (W) 表示。

标识上显示的能耗数据是根据典型配置测量得出的数据，此类配置包含登记备案的打印机依据复印机、打印机和传真机能源效率标识实施规则所选的所有配置。因此，该特定产品型号的实际能耗可能与标识上显示的数据有所不同。

要了解规范的更多详情，请参考最新版的 GB 21521 标准。

The Table of Hazardous Substances/Elements and their Content (China)

产品中有害物质或元素的名称及含量
根据中国《电器电子产品有害物质限制使用管理办法》

部件名称	有害物质					
	铅 (Pb)	汞 (Hg)	镉 (Cd)	六价铬 (Cr(VI))	多溴联苯 (PBB)	多溴二苯醚 (PBDE)
外壳和托盘	0	0	0	0	0	0
电线	0	0	0	0	0	0
印刷电路板	X	0	0	0	0	0
打印系统	X	0	0	0	0	0
显示器	X	0	0	0	0	0
喷墨打印机墨盒	0	0	0	0	0	0
驱动光盘	X	0	0	0	0	0
扫描仪	X	0	0	0	0	0
网络配件	X	0	0	0	0	0
电池板	X	0	0	0	0	0
自动双面打印系统	0	0	0	0	0	0
外部电源	X	0	0	0	0	0

本表格依据SJ/T 11364的规定编制。
 0: 表示该有害物质在该部件所有均质材料中的含量均在GB/T 26572规定的限量要求以下。
 X: 表示该有害物质至少在该部件的某一均质材料中的含量超出GB/T 26572规定的限量要求。

此表中所有名称中含“X”的部件均符合欧盟RoHS立法。

注: 环保使用期限的参考标识取决于产品正常工作的温度和湿度等条件。



EPEAT

EPEAT

Most HP products are designed to meet EPEAT. EPEAT is a comprehensive environmental rating that helps identify greener electronics equipment. For more information on EPEAT go to www.epeat.net. For information on HP's EPEAT registered products go to www.hp.com/hpinfo/globalcitizenship/environment/pdf/epeat_printers.pdf.

Battery disposal in Taiwan



廢電池請回收

California Perchlorate Material Notice

California Perchlorate Material Notice

Perchlorate material - special handling may apply. See:
<http://www.dtsc.ca.gov/hazardouswaste/perchlorate/>

This product's real-time clock battery or coin cell battery may contain perchlorate and may require special handling when recycled or disposed of in California.

EU Battery Directive



English	<p>European Union Battery Directive This product contains a battery that is used to maintain data integrity of real time clock or product settings and is designed to last the life of the product. Any attempt to service or replace this battery should be performed by a qualified service technician.</p>
Français	<p>Directive sur les batteries de l'Union Européenne Ce produit contient une batterie qui permet de maintenir l'intégrité des données pour les paramètres du produit ou l'horloge en temps réel et qui a été conçue pour durer aussi longtemps que le produit. Toute tentative de réparation ou de remplacement de cette batterie doit être effectuée par un technicien qualifié.</p>
Deutsch	<p>Batterie-Richtlinie der Europäischen Union Dieses Produkt enthält eine Batterie, die dazu dient, die Datenintegrität der Echtzeituhr sowie der Produkteinstellungen zu erhalten, und die für die Lebensdauer des Produkts ausreicht. Im Bedarfsfall sollte das Instandhalten bzw. Austauschen der Batterie von einem qualifizierten Servicetechniker durchgeführt werden.</p>
Italiano	<p>Direttiva dell'Unione Europea relativa alla raccolta, al trattamento e allo smaltimento di batterie e accumulatori Questo prodotto contiene una batteria utilizzata per preservare l'integrità dei dati dell'orologio in tempo reale o delle impostazioni del prodotto e la sua durata si intende pari a quella del prodotto. Eventuali interventi di riparazione o sostituzione della batteria devono essere eseguiti da un tecnico dell'assistenza qualificato.</p>
Español	<p>Directiva sobre baterías de la Unión Europea Este producto contiene una batería que se utiliza para conservar la integridad de los datos del reloj de tiempo real o la configuración del producto y está diseñada para durar toda la vida útil del producto. El mantenimiento o la sustitución de dicha batería deberá realizarla un técnico de mantenimiento cualificado.</p>
Čeština	<p>Směrnice Evropské unie pro nakládání s bateriemi Tento výrobek obsahuje baterii, která slouží k uchování správných dat hodin reálného času nebo nastavení výrobku. Baterie je navržena tak, aby vydržela celou životnost výrobku. Jakýkoliv pokus o opravu nebo výměnu baterie by měl provést kvalifikovaný servisní technik.</p>
Dansk	<p>EU's batteridirektiv Produktet indeholder et batteri, som bruges til at vedligeholde dataintegriteten for realtidsur- eller produktindstillinger og er beregnet til at holde i hele produktets levetid. Service på batteriet eller udskiftning bør foretages af en uddannet servicetekniker.</p>
Nederlands	<p>Richtlijn batterijen voor de Europese Unie Dit product bevat een batterij die wordt gebruikt voor een juiste tijdsaanduiding van de klok en het behoud van de productinstellingen. Bovendien is deze ontworpen om gedurende de levensduur van het product mee te gaan. Het onderhoud of de vervanging van deze batterij moet door een gekwalificeerde onderhoudstechnicus worden uitgevoerd.</p>
Eesti	<p>Euroopa Liidu aku direktiiv Toode sisaldab akut, mida kasutatakse reaalaja kella andmeühtsuse või toote sätete säilitamiseks. Aku on valmistatud kestma terve toote kasutusaja. Akut tohib hooldada või vahetada ainult kvalifitseeritud hooldustehnik.</p>
Suomi	<p>Euroopan unionin paristodirektiivi Tämä laite sisältää pariston, jota käytetään reaaliaikaisen kellon tietojen ja laitteen asetusten säilyttämiseen. Pariston on suunniteltu kestävän laitteen koko käyttöajan ajan. Pariston mahdollinen korjaus tai vaihto on jätettävä pätevään huotoherkityn tehtäväksi.</p>
Ελληνικά	<p>Οδηγία της Ευρωπαϊκής Ένωσης για τις ηλεκτρικές στήλες Αυτό το προϊόν περιλαμβάνει μια μπαταρία, η οποία χρησιμοποιείται για τη διατήρηση της ακεραιότητας των δεδομένων ρολογιού πραγματικού χρόνου ή των ρυθμίσεων προϊόντος και έχει σχεδιαστεί έτσι ώστε να διαρκέσει όσο και το προϊόν. Τυχόν απόπειρες επιδιόρθωσης ή αντικατάστασης αυτής της μπαταρίας θα πρέπει να πραγματοποιούνται από κατάλληλα εκπαιδευμένο τεχνικό.</p>
Magyar	<p>Az Európai unió telepek és akkumulátorok direktívája A termék tartalmaz egy elemet, melynek feladata az, hogy biztosítsa a valós idejű óra vagy a termék beállításainak adatintegritását. Az elem úgy van tervezve, hogy végig kitartson a termék használatá során. Az elem bármilyen javítását vagy cseréjét csak képzett szakember végezheti el.</p>
Latvian	<p>Eiropas Savienības Bateriju direktīva Produktam ir baterija, ko izmanto reālā laika pulksteņa vai produkta iestatījumu datu integritātes saglabāšanai, un tā ir paredzēta visam produkta dzīves ciklam. Iebkura apkope vai baterijas nomaiņa ir jāveic atbilstoši kvalificētam darbiniekam.</p>
Lietuvėliškai	<p>Eiropos Sąjungos baterijų ir akumuliatorių direktyva Šiame gaminyje yra baterija, kuri naudojama, kad būtų galima prižiūrėti realaus laiko laikrodžio veikimą arba gaminio nuostatas; ji skirta veikti visą gaminio eksploatavimo laiką. Betkokius šios baterijos aptarnavimo arba keitimo darbus turi atlikti kvalifikuotas aptarnavimo technikas.</p>
Polski	<p>Dyrektywa Unii Europejskiej w sprawie baterii i akumulatorów Produkt zawiera baterię wykorzystywaną do zachowania integralności danych zegara czasu rzeczywistego lub ustawień produktu, która podtrzymuje działanie produktu. Przegląd lub wymiana baterii powinny być wykonywane wyłącznie przez uprawnionego technika serwisu.</p>
Português	<p>Directiva sobre baterias da União Europeia Este produto contém uma bateria que é usada para manter a integridade dos dados do relógio em tempo real ou das configurações do produto e é projetada para ter a mesma duração que este. Qualquer tentativa de consertar ou substituir essa bateria deve ser realizada por um técnico qualificado.</p>
Slovenčina	<p>Smernica Európskej únie pre zaobchádzanie s batériami Tento výrobok obsahuje batériu, ktorá slúži na uchovanie správnych údajov hodín reálneho času alebo nastavení výrobku. Batéria je skonštruovaná tak, aby vydržala celú životnosť výrobku. Akýkoľvek pokus o opravu alebo výmenu batérie by mal vykonať kvalifikovaný servisný technik.</p>
Slovenščina	<p>Direktiva Evropske unije o baterijah in akumulatorjih V tem izdelku je baterija, ki zagotavlja natančnost podatkov ure v realnem času ali nastavitve izdelka v realni življenjski dobi izdelka. Kakršno koli popravilo ali zamenjava te baterije lahko izvede le pooblaščen tehnik.</p>
Svenska	<p>EU:s batteridirektiv Produkten innehåller ett batteri som används för att upprätthålla data i realtidsklockan och produktinställningarna. Batteriet ska räkna produktens hela livslängd. Endast kvalificerade servicetekniker får utföra service på batteriet och byta ut det.</p>
Български	<p>Директива за батерии на Европейския съюз Този продукт съдържа батерия, която се използва за поддържане на целостта на данните на часовника в реално време или настройките за продукта, създадена на издръжи през целия живот на продукта. Сервизът или замената на батерията трябва да се извършва от квалифициран техник.</p>
Română	<p>Directiva Uniunii Europene referitoare la baterii Acest produs conține o baterie care este utilizată pentru a menține integritatea datelor ceasului de timp real sau setările produsului și care este proiectată să funcționeze pe întreaga durată de viață a produsului. Orice lucrare de service sau de înlocuire a acestei baterii trebuie efectuată de un tehnician de service calificat.</p>

Battery notice for Brazil

A bateria deste equipamento não foi projetada para ser removida pelo cliente.

Index

A

accessibility 2
accessories
 setup 20
align printhead 70

B

both sides, print on 30
buttons, control panel 7

C

carriage
 clear carriage jams 57
cartridges 41
clean
 exterior 70
 printhead 70
connectors, locating 6
control panel
 buttons 7
customer support
 warranty 72

D

diagnostic page 68
double-sided printing 30

E

embedded web server
 about 50
 opening 51
 troubleshoot, cannot be opened
 52
environmental specifications 73
environmental sustainability
 program 81
EWS. *See* embedded web server

H

HP Utility (OS X)
 opening 50
humidity specifications 73

I

ink cartridges 6
 check ink levels 38
 locating 6
 part numbers 41
 replace 38
 tips 37
ink levels, check 38
IP address
 checking for printer 52
IP settings 46

J

jams
 clear 54
 paper to avoid 10

L

link speed, setting 46

M

Mac OS 26
maintain
 page smear 70
 printhead 70
maintenance
 align printhead 70
 check ink levels 38
 clean 70
 clean printhead 70
 diagnostic page 68
 printhead 70
 replace cartridges 38

media

 duplexing 30
multi-feeds, troubleshoot 58

N

networks
 connector illustration 6
 IP settings 46
 link speed 46
 settings, change 45
 view and print settings 46

wireless communication setup
 43
wireless settings 68

O

operating systems supported 73
OS X
 HP Utility 50
output tray
 locating 5

P

paper
 clear jams 54
 HP, order 10
 load tray 11
 selecting 10
 skewed pages 58
 specifications 74
 troubleshoot feeding 58
paper-feed problems, troubleshoot
 58
power
 troubleshoot 67
power input, locating 6
print
 diagnostic page 68
 double-sided 30
 troubleshoot 67
Print brochures
 print 26
print quality
 clean page smear 70
print quality report 68
printer control panel
 locating 5
 network settings 45
printer software (Windows)
 about 50
 opening 23, 50
printer status report
 information on 68
printhead 70
 clean 70
printhead, align 70

R

- radio interference
 - regulatory information 79
- rear access panel
 - illustration 6
- recycle
 - ink cartridges 82
- regulatory information 74, 79
- regulatory model number 75
- replace ink cartridges 38
- reports
 - diagnostic 68
 - wireless test 69

S

- second tray
 - use Tray 2 21
- settings
 - network 45
- setup
 - accessories 20
- skew, troubleshoot
 - print 58
- specifications
 - paper 74
 - physical 73
 - system requirements 73
- status
 - network configuration page 68
- system requirements 73

T

- temperature specifications 73
- trays
 - clear paper jams 54
 - load paper 11
 - locating 5
 - paper-width guides illustration 5
 - troubleshoot feeding 58
- troubleshoot
 - control panel help system 68
 - embedded web server 52
 - multiple pages are picked 58
 - network configuration page 68
 - paper not picked up from tray 58
 - paper-feed problems 58
 - power 67
 - print 67

- printer status report 68
- skewed pages 58
- two-sided printing 30

U

- USB connection
 - port, locating 5, 6

V

- view
 - network settings 46

W

- warranty 72
- websites
 - accessibility information 2
 - environmental programs 81
- Windows
 - print brochures 25
 - system requirements 73
- wireless communication
 - regulatory information 79
 - set up 43
- wireless test report 69

