

# DLP Projector

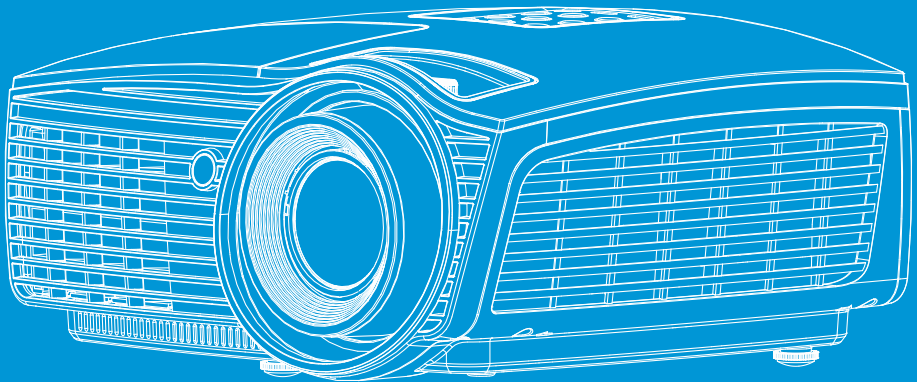

User manual

# Table of contents



+	+	+	Table of contents.....	1
+	+	+	Usage Notice.....	3
			Safety Information.....	3
			Precautions.....	4
			Eye Safety Warnings.....	6
+	+	+	Introduction.....	7
			Package Overview.....	7
			Product Overview.....	8
			Main Unit.....	8
			Connection Ports.....	9
			Remote Control.....	10
+	+	+	Installation.....	11
			Connecting the Projector.....	11
			Connect to Notebook.....	11
			Connect to Video Sources.....	12
			Powering On/Off the Projector.....	13
			Powering On the Projector.....	13
			Powering Off the Projector.....	14
			Warning Indicator.....	14
			Adjusting the Projected Image.....	15
			Adjusting the Projector's Height.....	15
			Adjusting the vertical image position.....	15
			Adjusting Projection Image Size (WXGA).....	16
			Adjusting Projection Image Size (1080p).....	17
			Adjusting Projection Image Size (1080p short throw).....	18
+	+	+	User Controls.....	19
			Remote Control.....	19
			On-screen Display Menus.....	21
			How to operate.....	21
			Menu Tree.....	22
			Image.....	24
			Image   Advanced.....	26
			Image   Advanced   Color Matching.....	28
			Image   Advanced   Signal.....	29
			Display.....	30
			Display   3D.....	32
			Setup.....	33
			Setup   Language.....	35
			Setup   Security.....	36
			Setup   Audio Settings.....	39
			Setup   Advanced.....	40
			Setup   Network.....	41

# Table of contents



Setup   LAN Settings.....	42
Setup   Control Settings .....	43
Options.....	44
Options   Input Source .....	47
Options   Remote Settings .....	48
Options   Advanced.....	49
Options   Lamp Setting .....	51
LAN_RJ45 .....	53
 Appendices.....	63
Troubleshooting.....	63
Image .....	63
Other .....	64
Projector LED Status Indicator.....	65
Remote Control.....	66
Replacing the Lamp.....	67
Compatibility Modes .....	70
Video Compatibility .....	70
Video Timing Detail Describe.....	70
Computer Compatibility - VESA standards .....	71
Input Signal for HDMI/DVI-D .....	72
True 3D Video Compatibility table .....	73
RS232 Commands and Protocol Function List.....	74
RS232 Pin Assignments (projector side) .....	74
RS232 Protocol Function List .....	75
Telnet Commands .....	79
AMX Device Discovery commands .....	79
PJLink™ supported commands.....	80
Trademarks .....	82
Ceiling Mount Installation .....	84
Optoma Global Offices .....	85
Regulation & Safety Notices.....	87

## Safety Information

	The lightning flash with arrow head within an equilateral triangle is intended to alert the user to the presence of uninsulated "dangerous voltage" within the product's enclosure that may be of sufficient magnitude to constitute a risk of electric shock to persons.
	The exclamation point within an equilateral triangle is intended to alert the user to the presence of important operating and maintenance (servicing) instructions in the literature accompanying the appliance.

**WARNING: TO REDUCE THE RISK OF FIRE OR ELECTRIC SHOCK, DO NOT EXPOSE THIS APPLIANCE TO RAIN OR MOISTURE. DANGEROUS HIGH VOLTAGES ARE PRESENT INSIDE THE ENCLOSURE. DO NOT OPEN THE CABINET. REFER SERVICING TO QUALIFIED PERSONNEL ONLY.**

### **Class B emissions limits**

This Class B digital apparatus meets all requirements of the Canadian Interference-Causing Equipment Regulations.

### **Important Safety Instruction**

1. Do not block any ventilation openings. To ensure reliable operation of the projector and to protect from over heating, it is recommended to install the projector in a location that does not block ventilation. As an example, do not place the projector on a crowded coffee table, sofa, bed, etc. Do not put the projector in an enclosure such as a book case or a cabinet that restricts air flow.
2. Do not use the projector near water or moisture. To reduce the risk of fire and/or electric shock, do not expose the projector to rain or moisture.
3. Do not install near heat sources such as radiators, heaters, stoves or any other apparatus such as amplifiers that emits heat.
4. Clean only with dry cloth.
5. Only use attachments/accessories specified by the manufacturer.
6. Do not use the unit if it has been physically damaged or abused.  
Physical damage/abuse would be (but not limited to):
  - Unit has been dropped.
  - Power supply cord or plug has been damaged.
  - Liquid has been spilled on to the projector.
  - Projector has been exposed to rain or moisture.
  - Something has fallen in the projector or something is loose inside.Do not attempt to service the unit yourself. Opening or removing covers may expose you to dangerous voltages or other hazards. Please call Optoma before you send the unit for repair.
7. Do not let objects or liquids enter the projector. They may touch dangerous voltage points and short out parts that could result in fire or electric shock.
8. See projector enclosure for safety related markings.
9. The unit should only be repaired by appropriate service personnel.

# Usage Notice

## Precautions



*Please follow all warnings, precautions and maintenance as recommended in this user's guide.*

- Warning- Do not look into the projector's lens when the lamp is on. The bright light may hurt your eyes.
- Warning- To reduce the risk of fire or electric shock, do not expose this projector to rain or moisture.
- Warning- Please do not open or disassemble the projector as this may cause electric shock.
- Warning- When replacing the lamp, please allow the unit to cool down. Follow instructions as described on page 67.
- Warning- This projector will detect the life of the lamp itself. Please be sure to change the lamp when it shows warning messages.
- Warning- Reset the "Lamp Reset" function from the on-screen display "System|Lamp Setting" menu after replacing the lamp module (refer to pages 51-52).
- Warning- When switching the projector off, please ensure the cooling cycle has been completed before disconnecting power. Allow 90 seconds for the projector to cool down.
- Warning- Do not use lens cap when projector is in operation.
- Warning- When the lamp is approaching to the end of its life time, the message "Replacement suggested" will show on the screen. Please contact your local reseller or service center to change the lamp as soon as possible.

### Note

When the lamp reaches the end of its life, the projector will not turn back on until the lamp module has been replaced. To replace the lamp, follow the procedures listed under "Replacing the Lamp" section on page 67.

# Usage Notice



## **Do:**

- ■ Turn off and unplug the power plug from the AC outlet before cleaning the product.
- ■ Use a soft dry cloth with mild detergent to clean the display housing.
- ■ Disconnect the power plug from AC outlet if the product is not being used for a long period of time.



## **Do not:**

- ■ Block the slots and openings on the unit provided for ventilation.
- ■ Use abrasive cleaners, waxes or solvents to clean the unit.
- ■ Use under the following conditions:
  - In extremely hot, cold or humid environments.
    - ▶ Ensure that the ambient room temperature is within 5 - 40°C
    - ▶ Relative Humidity is 10 - 85% (Max.), non-condensing
  - In areas susceptible to excessive dust and dirt.
  - Near any appliance generating a strong magnetic field.
  - In direct sunlight.

# Usage Notice

## Eye Safety Warnings



- Avoid staring/facing directly into the projector beam at all times. Keep your back to the beam as much as possible.
- When projector is used in a classroom, adequately supervise students when they are asked to point out something on the screen.
- In order to minimize the lamp power, use room blinds to reduce ambient light levels.

### Note

Keep this manual for future reference..

# Introduction

## Package Overview

*Unpack and inspect the box contents to ensure all parts listed below are in the box. If something is missing, please contact Optoma customer service.*



Projector with lens cap

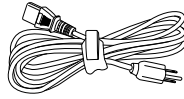

Power Cord 1.8m

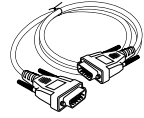

15 pin D-sub VGA Cable

### Note

Due to different applications in each Country, some regions may have different accessories.



Remote Control

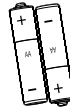

2 x AAA Batteries

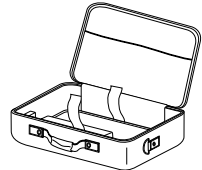

Carrying Case

### Documentation :

- User's Manual
- Warranty Card
- Basic User's Manual



# Introduction

## Product Overview

### Main Unit

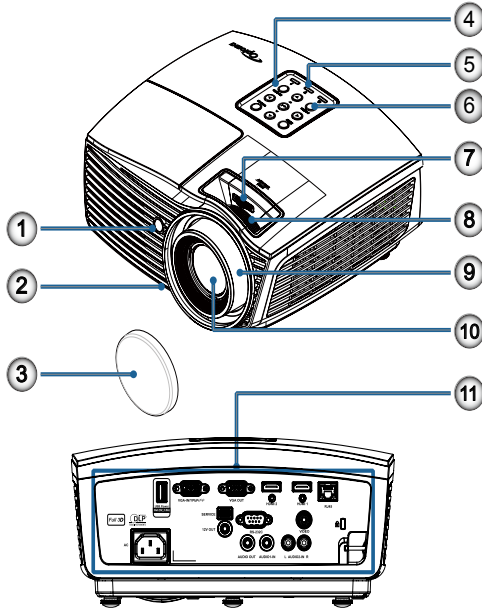

1. IR Receiver
2. Tilt-Adjustment Feet
3. Lens Cap
4. Function Keys
5. LED Indicators
6. Power Button
7. LENS SHIFT(Not available in 1080p short throw)
8. Zoom(Not available in 1080p short throw)
9. Focus
10. Lens
11. Connection Ports

# Introduction

## Connection Ports

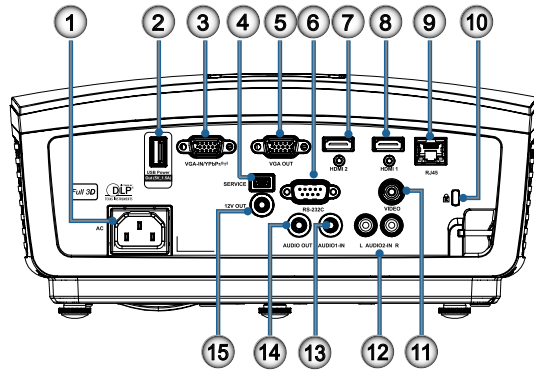

1. Power Socket
2. USB Power Out(5V\_1.5A)
3. VGA-IN/YPbPr/ (4)
4. SERVICE
5. VGA-OUT
6. RS-232C
7. HDMI2
8. HDMI1
9. RJ-45
10. Kensington Microsaver™ Lock Port
11. VIDEO
12. AUDIO2-IN (L and R)
13. AUDIO1 IN
14. AUDIO OUT
15. 12V OUT

# Introduction

## Remote Control







### CAUTION

Use of controls, adjustments or performance of procedures other than those specified herein may result in hazardous laser light exposure.

Complies with FDA performance standards for laser products except for deviations pursuant to Laser Notice No. 50, dated June 24, 2007.



Due to generic remote, function is model dependent.

1. Power On/Off
2. 
3. Freeze
4. USB mouse Left click
5. Four Directional Select Keys
6. Enter
7. Laser (DO NOT POINT IN EYES)
8. Page-
9. V Keystone +/-
10. /1 (Number Button for password input)
11. HDMI/4
12. User1/7
13. Source
14. Menu/2
15. VGA/5
16. Switch
17. 
18. USB mouse Right click
19. Page+
20. Volume +/-
21. 3D/3
22. Video/6
23. User3/9
24. Resync
25. User2/8
26. /0

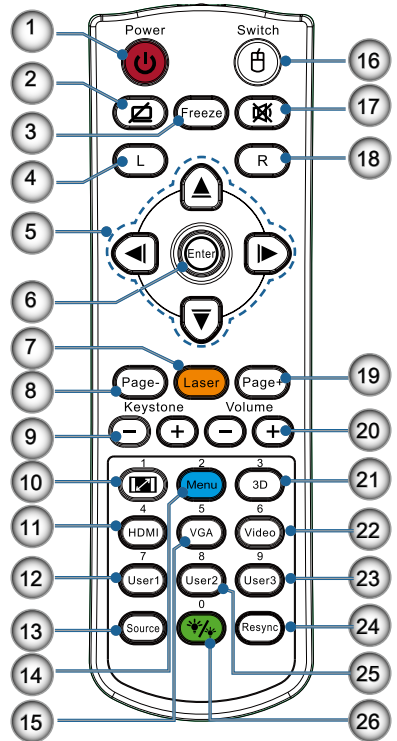

## Connecting the Projector

### Connect to Notebook

#### Note

Due to the difference in applications for each country, some regions may have different accessories.

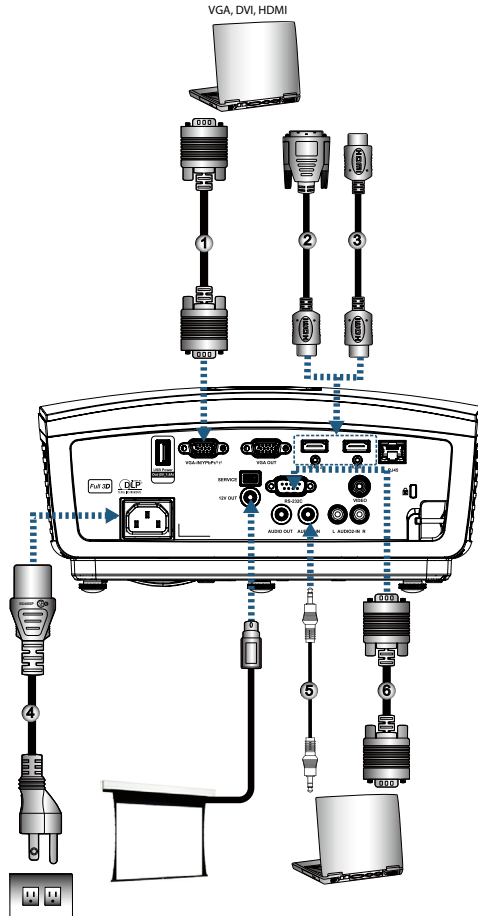

- 1.....VGA Input Cable
- 2.....DVI/HDMI Cable (Optional Accessory)
- 3.....HDMI Cable (Optional Accessory)
- 4.....Power Cord
- 5.....Audio Cable (Optional Accessory)
- 6.....RS232 Cable (Optional Accessory)

# Installation

## Connect to Video Sources

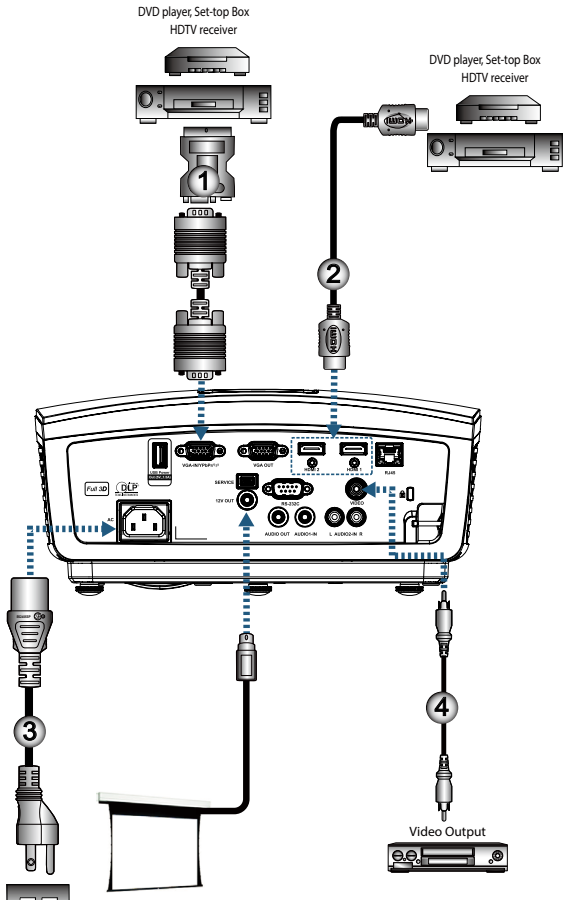

### Note

Due to the difference in applications for each country, some regions may have different accessories.

### Note

12V OUT is a programmable trigger.

- 1..... SCART RGB/S-Video Adapter (Optional Accessory)
- 2..... HDMI Cable (Optional Accessory)
- 3..... Power Cord
- 4..... Composite Video Cable (Optional Accessory)

## Powering On/Off the Projector

### Powering On the Projector

1. Remove the lens cover.
2. Connect the power cord to the projector.
3. Turn On the connected devices.
4. Ensure the Power LED is flashing and then press the power button to turn On the projector.

#### Note

Turn on the projector first and then select the signal sources.

The projector's startup logo screen displays and connected devices are detected. If the connected device is a laptop, press the appropriate keys on the computer keyboard to switch the display output to the projector. (Check the user manual of the laptop to determine the appropriate Fn key combination to change display output.)

See Security Settings on page 36 if security lock is enabled.



#### Note

Due to the difference in applications for each country, some regions may have different accessories.

5. If more than one input device is connected, press the "Source" button sequentially to switch between devices. For direct source selection, see page 20.

#### Note

12V OUT is a programmable trigger.

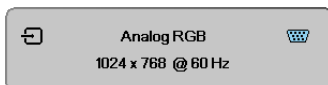

# Installation

## Powering Off the Projector

1. Press the "⏻" button on the remote control or "**POWER**" button on the panel of the projector to turn off the projector. First push of button will display the following message on the screen.

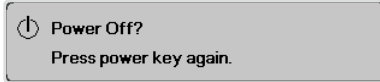

Press the button again to confirm the shut down. If the button is not pressed, the message will disappear in 5 seconds.

2. The Power LED flashes green (1 sec on, 1sec off) and the fans will speed up during shut down cooling cycle. The projector reaches stand-by mode as soon as the Power LED flashes green (2 sec on, 2 sec off).

If you wish to turn the projector back on, you must wait until the projector has completed the cooling cycle and has entered standby mode. Once in standby mode, simply press "**POWER**" button on the rear of the projector or "⏻" on the remote control to restart the projector.

3. Disconnect the power cord from the electrical outlet and the projector only when the projector is in stand-by mode.

## Warning Indicator

- When the Lamp LED indicator lights red, the projector will automatically shut itself down. Please contact your local reseller or service center. See page 65.
- When the Temp LED is on a steady (not flashing) red, the projector will automatically shut itself down. Under normal conditions, the projector can be switched on again after it has cooled down. If the problem persists, you should contact your local dealer or our service center. See page 65.



Contact the nearest service center if the projector displays these symptoms. See page 85 for more information.

## Adjusting the Projected Image

### Adjusting the Projector's Height

The projector is equipped with tilt-adjuster feet for adjusting the image height.

#### Note

- The projector table or stand should be level and sturdy.
- Position the projector so that it is perpendicular to the screen.
- For personal safety, please secure the cables properly.

To adjust the angle of the picture, turn the tilt-adjuster right or left until the desired angle has been achieved.

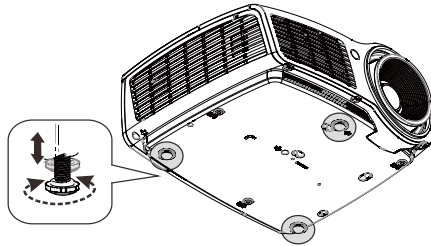

### Adjusting the vertical image position

The Lens Shift function can be used to adjust the position of the vertically.

Lens shift adjustment for WXGA

The display position can be shifted upward up to 7% and down to 4.5% elevation of the display.

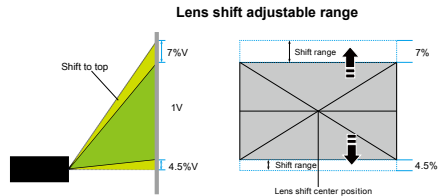

Lens shift adjustment for 1080P

The display position can be shifted upward up to 9% and down to 5% elevation of the display.

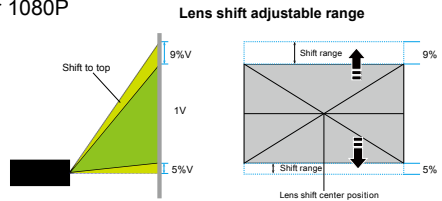

#### Note

Lens Shift is not available in 1080p short throw.



# Installation

## Adjusting Projection Image Size (WXGA)

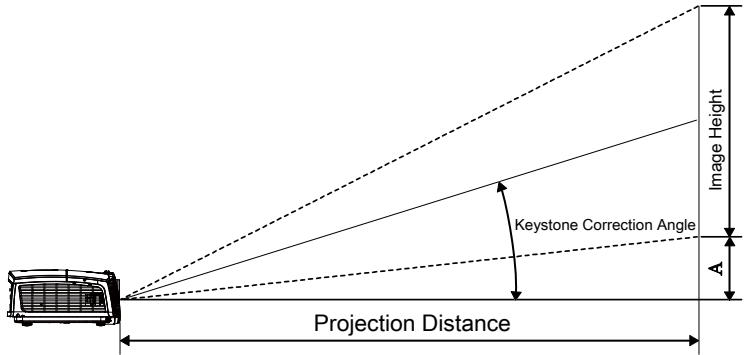

Diagonal length (inch) size of 16:10 Screen	Screen Size W X H (16:10)				Projection distance (D)				Offset (A)	
	(m)		(feet)		(m)		(feet)		(m)	(feet)
	Width	Height	Width	Height	wide	tele	wide	tele		
30	0.65	0.40	2.12	1.32	0.94	1.42	3.10	4.66	0.05	0.15
40	0.86	0.54	2.83	1.77	1.26	1.90	4.13	6.22	0.06	0.20
60	1.29	0.81	4.24	2.65	1.89	2.84	6.19	9.33	0.09	0.30
80	1.72	1.08	5.65	3.53	2.52	3.79	8.25	12.44	0.12	0.41
100	2.15	1.35	7.07	4.42	3.14	4.74	10.32	15.55	0.15	0.51
120	2.58	1.62	8.48	5.30	3.77	5.69	12.38	18.66	0.19	0.61
140	3.02	1.88	9.89	6.18	4.40	6.63	14.44	21.77	0.22	0.71
160	3.45	2.15	11.31	7.07	5.03	7.58	16.51	24.87	0.25	0.81
190	4.09	2.56	13.43	8.39	5.97	9.00	19.60	29.54	0.29	0.97
230	4.95	3.10	16.25	10.16	7.23	10.90	23.73	35.76	0.36	1.17
280	6.03	3.77	19.79	12.37	8.81	13.27	28.89	43.53	0.43	1.42
300	6.46	4.04	21.20	13.25	9.43	14.22	30.95	46.64	0.46	1.52



300" (overdrive) for Asia.

# Installation

## Adjusting Projection Image Size (1080p)

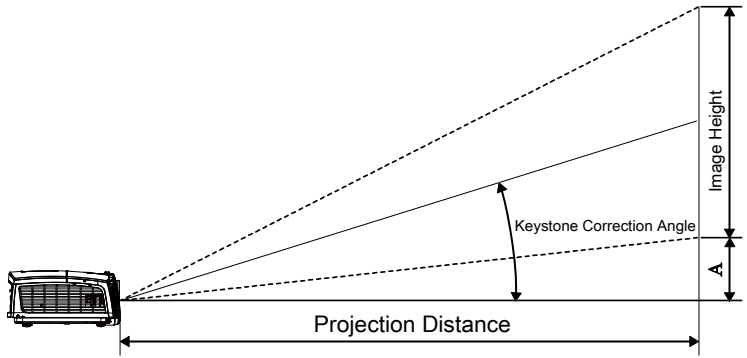

English

Diagonal length (inch) size of 16:9 Screen	Screen Size W X H (16:9)				Projection distance (D)				Offset (A)	
	(m)		(feet)		(m)		(feet)		(m)	(feet)
	Width	Height	Width	Height	wide	tele	wide	tele		
30	0.66	0.37	2.18	1.23	0.92	1.39	3.03	4.55	0.06	0.18
40	0.89	0.50	2.91	1.63	1.23	1.85	4.04	6.07	0.07	0.25
60	1.33	0.75	4.36	2.45	1.85	2.78	6.06	9.11	0.11	0.37
80	1.77	1.00	5.81	3.27	2.46	3.70	8.08	12.14	0.15	0.49
100	2.21	1.25	7.26	4.09	3.08	4.63	10.10	15.18	0.19	0.61
120	2.66	1.49	8.72	4.90	3.69	5.55	12.11	18.22	0.22	0.74
140	3.10	1.74	10.17	5.72	4.31	6.48	14.13	21.25	0.26	0.86
160	3.54	1.99	11.62	6.54	4.92	7.40	16.15	24.29	0.30	0.98
190	4.21	2.37	13.80	7.76	5.85	8.79	19.18	28.84	0.35	1.16
230	5.09	2.86	16.71	9.40	7.08	10.64	23.22	34.91	0.43	1.41
280	6.20	3.49	20.34	11.44	8.62	12.96	28.27	42.50	0.52	1.72
300	6.64	3.74	21.79	12.26	9.23	13.88	30.29	45.54	0.56	1.84

# Installation

## Adjusting Projection Image Size (1080p short throw)

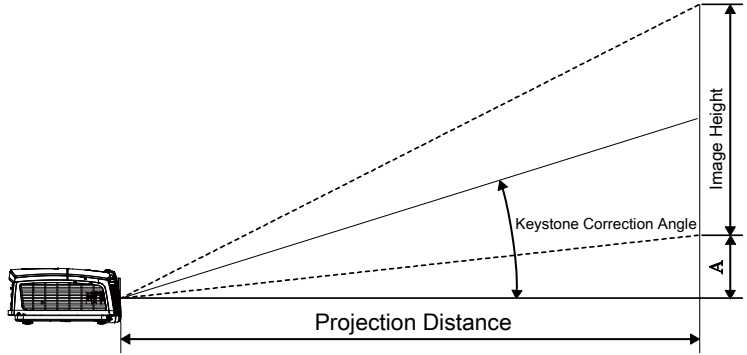

Diagonal length (inch) size of 16:9 Screen	Screen Size W X H (16:9)				Projection distance (D)		Offset (A)	
	(m)		(feet)		(m)	(feet)		
	Width	Height	Width	Height	wide	wide	(m)	(feet)
60	1.33	0.75	4.36	2.45	0.66	2.18	0.11	0.37
80	1.77	1.00	5.81	3.27	0.89	2.91	0.15	0.49
100	2.21	1.25	7.26	4.09	1.11	3.63	0.19	0.61
120	2.66	1.49	8.72	4.90	1.33	4.36	0.22	0.74
140	3.10	1.74	10.17	5.72	1.55	5.08	0.26	0.86
153	3.39	1.91	11.11	6.25	1.69	5.56	0.29	0.94

# User Controls

## Remote Control

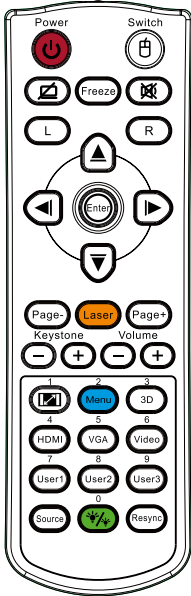

### Using the Remote Control

<b>Power On/Off</b>	Refer to the "Powering Off the Projector" on page 14. Refer to the "Powering On the Projector" on page 13.
<b>/Switch</b>	When connecting your PC to the projector through USB, press "Mouse Switch" to activate/ inactivate the mouse mode and control your PC using the remote.
<b>Display blank &amp; Audio mute</b>	Display blank & Audio mute
<b>Freeze</b>	Freeze
<b>Mute</b>	Mute
<b>L</b>	USB mouse Left click
<b>R</b>	USB mouse Right click
<b>Four Directional Select Keys</b>	<ol style="list-style-type: none"> <li>Use ▲▼◀▶ to select items or make adjustments to your selection.</li> <li>In the mouse mode, use ▲▼◀▶ as emulation of directional keys.</li> </ol>
<b>Enter</b>	<ol style="list-style-type: none"> <li>Confirm your item selection.</li> <li>In the mouse mode, as emulation keyboard enter key.</li> </ol>
<b>Page-</b>	Page Down key for emulation of USB keyboard via USB when OSD off
<b>Laser</b>	Press Laser to operate the on-screen pointer. <b>DO NOT POINT IN EYES.</b>
<b>Page+</b>	Page Up key for emulation of USB keyboard via USB when OSD off
<b>V Keystone +/-</b>	Adjusts image distortion caused by tilting the projector. (±40 degrees for WXGA/1080P, ±20 degrees for 1080p short throw)
<b>Volume +/-</b>	Press "Volume +/-" to adjust volume.

### Note

Due to the difference in applications for each country, some regions may have different accessories.

### Note

Due to generic remote, function is model dependent.

# User Controls

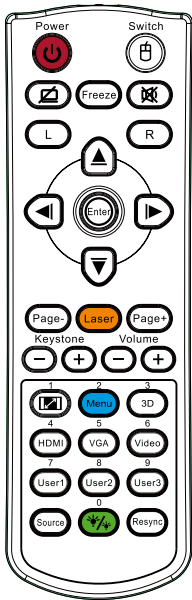

## Using the Remote Control

/1	Refer to the  "Format" on page 30.
<b>Menu/2</b>	Press "Menu" to launch the on-screen display (OSD) menu. To exit OSD, press "Menu" again.
<b>3D/3</b>	Press "3D" to turn on/off 3D menu.
<b>HDMI/4</b>	Press "HDMI" to choose HDMI source.
<b>VGA/5</b>	Press "VGA" to choose source from VGA- IN connector.
<b>Video/6</b>	Press "Video" to choose Composite video source.
<b>User 1/7</b>	Refer to the "User 1" on page 48
<b>User 2/8</b>	Refer to the "User 2" on page 48
<b>User 3/9</b>	Refer to the "User 3" on page 48
/0	Brightness mode menu on/off
<b>Source</b>	Press "Source" to search for source.
<b>Re-sync</b>	Automatically synchronizes the projector to the input source.

### Note

Due to the difference in applications for each country, some regions may have different accessories.

### Note

Due to generic remote, function is model dependent.

### Note

Remote control number is for password used.

## On-screen Display Menus

*The Projector has multilingual On-screen Display menus that allow you to make image adjustments and change a variety of settings. The projector will automatically detect the source.*

### How to operate

1. To open the OSD menu, press “Menu” on the Remote Control or Control Panel.
2. When OSD is displayed, use ◀▶ keys to select any item in the main menu. While making a selection on a particular page, press ▲▼ or “ENTER” key on the Remote Control or “Enter” on the Control Panel to enter sub menu.
3. Use ▲▼ keys to select the desired item and adjust the settings by ◀▶ key.
4. Select the next item to be adjusted in the sub menu and adjust as described above.
5. Press “ENTER” key on the Remote Control or “Enter” on the Control Panel or “Menu” to confirm, and the screen will return to the main menu.
6. To exit, press “Menu” again. The OSD menu will close and the projector will automatically save the new settings.

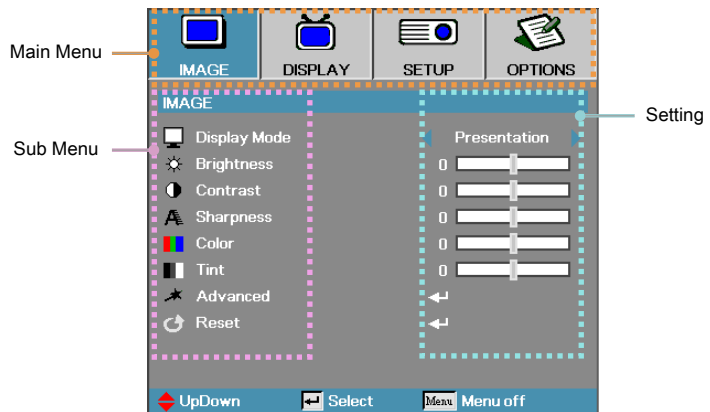

# User Controls

## Menu Tree

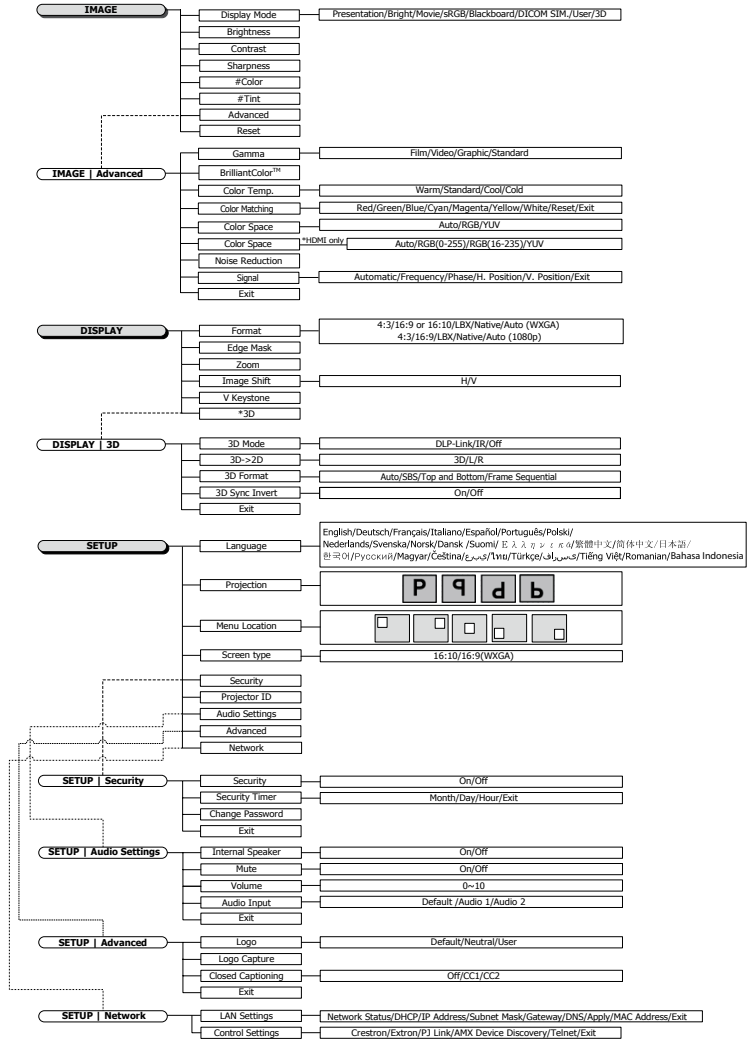

### Note

- (#) "Color" and "Tint" is only supported in for YUV video sources.
- (\*) "3D" is only available when a compatible signal is supplied.

# User Controls

<b>OPTIONS</b>	Input Source	HDMI-1/HDMI-2/VGA/Video
	Source Lock	On/Off
	High Altitude	On/Off
	Information Hide	On/Off
	Keypad Lock	On/Off
	Test Pattern	None/Grid/White
	12V Trigger	On/Off/Auto 3D
	Background Color	Blue/Black/Red/Green/White
	Remote Setting	
	Advanced	
	Lamp Settings	
Reset	Current/All	
<b>OPTIONS   Remote Setting</b>	User1	LAN/Brightness/Contrast/Sleep Timer/ Color Matching/ Color Temp/Gamma/ Source Lock /Projection/Lamp Settings/ Zoom/Test Pattern/Freeze/ HDMI1/HDMI2
	User2	LAN/Brightness/Contrast/Sleep Timer/ Color Matching /Color Temp/Gamma/ Source Lock /Projection/Lamp Settings/ Zoom/Test Pattern/Freeze/ HDMI1/HDMI2
	User3	LAN/Brightness/Contrast/Sleep Timer/ Color Matching/ Color Temp/Gamma/ Source Lock /Projection/Lamp Settings/ Zoom/Test Pattern/Freeze/ HDMI1/HDMI2
	IR Function	On/Off
<b>OPTIONS   Advanced</b>	Direct Power On	On/Off
	Signal Power On	On/Off
	Auto Power Off (min)	
	Sleep Timer (min)	
	Power Mode (Standby)	Active/ECO
	Quick Resume	On/Off
	OSD Time-Out	5 sec./15 sec./30 sec./60 sec./Never
	Exit	
<b>OPTIONS   Lamp Setting</b>	Lamp Hour	
	Lamp Reminder	On/Off
	Brightness Mode	Bright/Eco.
	DynamicBlack	On/Off**
	Lamp Reset	Yes/No
	Exit	

## Note

- (\*\*) When DynamicBlack is On, and Brightness Mode is set to Bright, the Dynamic range is 100%~30%. When brightness mode is on Eco. Mode, the dynamic range is 80%~30%



# User Controls

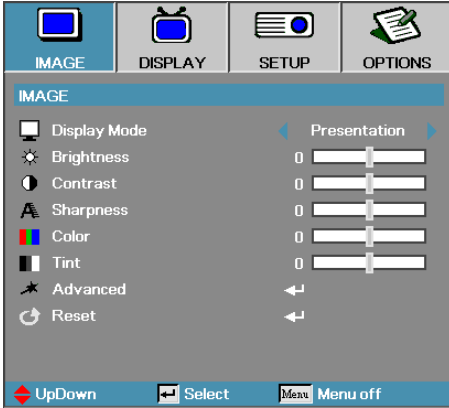

## Image

### Display Mode

There are many factory presets optimized for various types of images.

- ▶ Presentation: Good color and brightness from PC input.
- ▶ Bright: Maximum brightness from PC input.
- ▶ Movie: For home theater.
- ▶ sRGB: Standardised accurate color.
- ▶ Blackboard: This mode should be selected to achieve optimum color settings when projecting onto a blackboard (green).
- ▶ DICOM SIM: This display mode simulates the grayscale/gamma performance of equipment used for "Digital Imaging and Communications in Medicine" (DICOM).

Important: This mode should NEVER be used for medical diagnosis, it is for education/training purposes only.

- ▶ User: User's own settings.
- ▶ 3D: User adjustable setting for 3D viewing.

### Brightness

Adjust the brightness of the image.

- ▶ Press ◀ to darken image.
- ▶ Press ▶ to lighten the image.

# User Controls

## Contrast

The contrast controls the degree of difference between the lightest and darkest parts of the picture.

- ▶ Press ◀ to decrease the contrast.
- ▶ Press ▶ to increase the contrast.

## Sharpness

Adjusts the sharpness of the image.

- ▶ Press ◀ to decrease the sharpness.
- ▶ Press ▶ to increase the sharpness.

## Color

Adjusts a video image from black and white to full color saturation.

- ▶ Press ◀ to decrease the amount of color in the image.
- ▶ Press ▶ to increase the amount of color in the image.

## Tint

Adjusts the color balance of red and green.

- ▶ Press ◀ to increase the amount of green in the image.
- ▶ Press ▶ to increase the amount of red in the image.

## Advanced

Enter the Advanced menu. Select advanced display options such as Gamma, BrilliantColor™, Color Temp., Color Matching, Color Space, Noise Reduction, Signal, and Exit. See page 26 for more information.

# User Controls

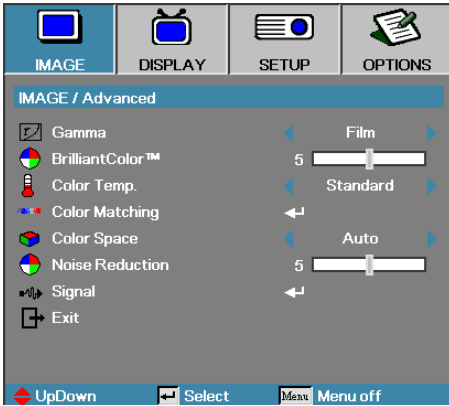

## *Image / Advanced*

### Gamma

Choose the Gamma type from Film, Video, Standard.

### BrilliantColor™

This adjustable item utilizes a new color-processing algorithm and system level enhancements to enable higher brightness while providing true, more vibrant colors in picture. The range is from 1 to 10. If you prefer a stronger enhanced image, adjust toward the maximum setting. For a smoother, more natural image, adjust toward the minimum setting.

### Color Temp

Adjust the color temperature. Cold temperature, the screen looks colder; with Warm temperature, the screen looks warmer.

### Color Matching

Enter the Color Matching menu. See page 28 for more details.

### Color Space

Select an appropriate color matrix type from AUTO, RGB, YUV.

- ▶ For HDMI only: Select color matrix from Auto, RGB (0-255), RGB (16-235), YUV.

# User Controls

## Noise Reduction

The motion Adaptive Noise Reduction reduces the amount of visible noise in interlaced signals. The range is from “0” to “10”. (0=Off)

## Signal

Enter the Signal menu. Set projector signal properties. The function is available when input source is support VGA See page 29 for more information.

# User Controls



## Image / Advanced / Color Matching

### Colors (Except White)

Press ▲▼ to select a color and press “ENTER” to adjust the hue, saturation, and gain settings.

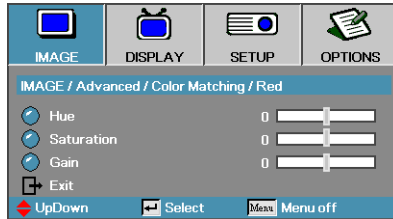

### Note

- Green, Blue, Cyan, Yellow, Magenta can be separate adjust by each color HSG.
- White can be adjust Red, Green, Blue color by each.

Press ▲▼ to select Hue, Saturation, or Gain and press ◀▶ to adjust the settings.

### White

Press ▲▼ to select White and press “ENTER”.

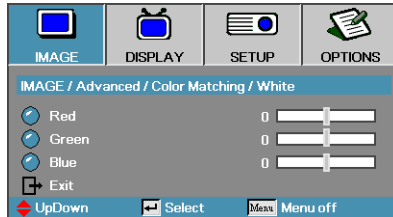

Press ▲▼ to select Red, Green, or Blue and press ◀▶ to adjust the settings.

### Reset

Reset all Color Setting values to the factory default.

# User Controls

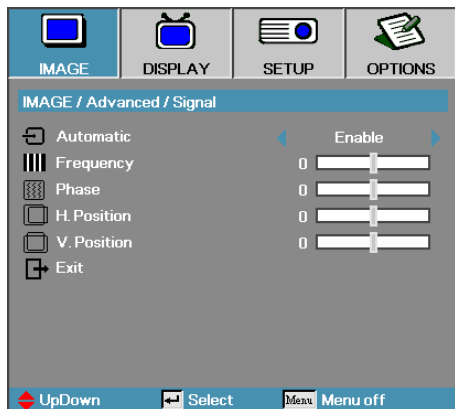

## Image / Advanced / Signal

### Automatic

Set Automatic to On or Off to lock or unlock the Phase and Frequency features.

- ▶ Disable—Off auto lock.
- ▶ Enable—On auto lock.

### Frequency

Change the display data frequency to match the frequency of your computer's graphics card. If you experience a vertical flickering bar, use this function to make an adjustment.

### Phase

Phase synchronizes the signal timing of the display with the graphics card. If you experience an unstable or flickering image, use this function to correct it.

### H. Position

- ▶ Press ◀ to move the image left.
- ▶ Press ▶ to move the image right.

### V. Position

- ▶ Press ◀ to move the image down.
- ▶ Press ▶ to move the image up.

# User Controls

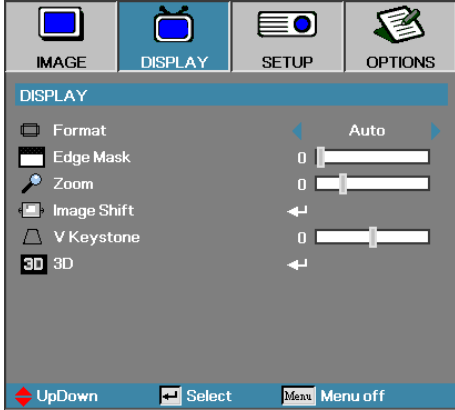

## Display

### Format

Use this function to choose your desired aspect ratio.

- ▶ 4:3: This format is for 4x3 input sources not enhanced for Wide screen TV.
- ▶ 16:9/16:10: This format is for 16x9 input sources, like HDTV and DVD enhanced for Wide screen TV.
- ▶ LBX: This format is for non-16x9, letterbox source and for users who use an external 16x9 lens to display 2.35:1 aspect ratio using full resolution.
- ▶ Native: Depends on the resolution of the input source – No scaling is performed.
- ▶ Auto: Automatically selects the appropriate format.

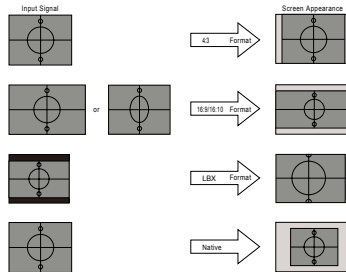

WXGA/1080P

## Edge Mask

Edge Mask function removes the noise in a video image. Edge Mask the image to remove video encoding noise on the edge of video source.

## Zoom

- ▶ Press ◀ to reduce the size of the image.
- ▶ Press ▶ to magnify an image on the projected screen.

## Image Shift

Shifts the projected image position horizontally or vertically.

- ▶ Press ◀▶ to move the image horizontally on the projected screen.
- ▶ Press ▲▼ to move the image vertically on the projected screen.

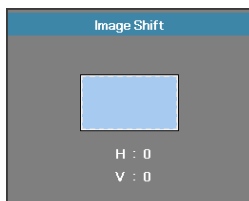

When Zoom  $\leq$  0

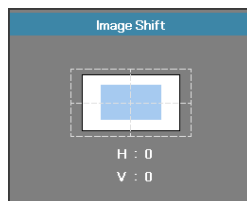

When Zoom  $>$  0

## V Keystone

Press ◀ or ▶ to compensate for vertical images distortion when the projector is positioned at an angle to the screen.

## 3D

Enter the 3D menu. Select 3D options such as 3D Mode, 3D→2D, 3D Format, and 3D Sync Invert. See page 32 for more information.



# User Controls

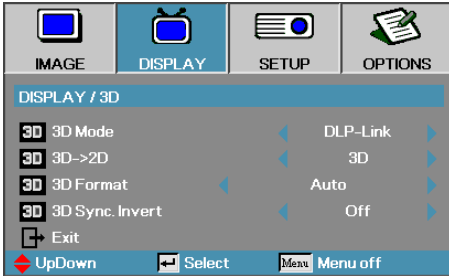

## Display / 3D

### 3D Mode

- ▶ DLP Link: Select DLP Link to use optimized settings for DLP Link 3D Glasses.
- ▶ IR: Select IR to use optimized settings for IR-based 3D images.

### 3D→2D

Press ◀ or ▶ to select projector display 3D content in 2D (Left) or 2D(Right) without using 3D glasses to enjoy 3D content. This setting can also be used for dual projector passive 3D installations.

### 3D Format

- ▶ Auto: When a 3D identification signal is detected, the 3D format is selected automatically. (For HDMI 1.4 3D sources only)
- ▶ SBS: Display 3D signal in Side-by-Side format.
- ▶ Top and Bottom: Display 3D signal in Top and Bottom format.
- ▶ Frame Sequential: Display 3D signal in Frame Sequential format.

### 3D Sync. Invert

Press ◀ or ▶ to enable or disable the 3D Sync invert function to invert images.



3D settings would be saved after adjustment.

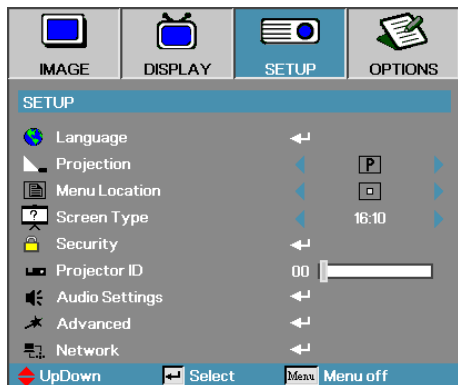

## Setup

### Language

Enter the Language menu. Select the multilingual OSD menu. See page 35 for more information.

### Projection

Select projection method:

- ▶ **[P]** Front Desktop  
The factory default setting.
- ▶ **[R]** Rear Desktop  
When you select this function, the projector reverses the image so you can project from behind a translucent screen.
- ▶ **[d]** Front Ceiling  
When you select this function, the projector turns the image upside down for ceiling-mounted projection.
- ▶ **[b]** Rear Ceiling  
When you select this function, the projector reverses and turns the image upside down at same time. You can project from behind a translucent screen with ceiling mounted projection.

### Menu Location

Choose the menu location on the display screen.

### Screen Type

Press ◀▶ to set the aspect ratio to 16:9 or 16:10. This function is only available for WXGA.

# User Controls

## Security

Enter the Security menu. Access the projector's security features. See pages 36-38 for more information.

## Projector ID

Select a two digit projector ID from 00 through 99.

## Audio Settings

Enter the Audio menu. Set audio level properties. See page 39 for more information.

## Advanced

Enter the Advanced menu. Select the screen display during startup. See page 40 for more information.

## Network

Allows access to controls for web, PJ-Link, and IP commands. See page 41 for more information.

# User Controls



## Setup / Language

### Language

Choose the multilingual OSD menu. Press “ENTER” into the sub menu and then use the Left (◀) or Right (▶) key to select your preferred language.

# User Controls



## *Setup / Security*

### Security

Enable or disable the security password.

- ▶ On—the current password is required to power on the projector and access the Security menu.
- ▶ Off—no password is required after system power up.



The default password:  
1, 2, 3, 4, 5.

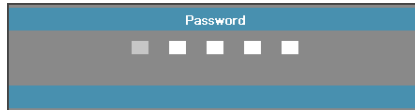

# User Controls

## Security Timer

Enter the Security Timer sub menu.

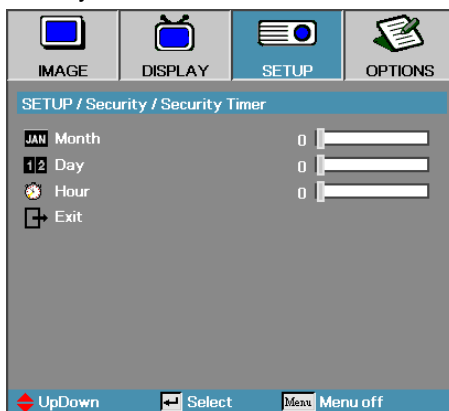

Enter the Months, Days, and hours that the projector can be used without entering the password. Exiting to the Setup menu activates the Security Timer.

Once activated, the projector requires a password on the specified dates and times to allow power on and access to the security menu.

If the projector is in use and the Security Timer is active, the following screen displays 60 seconds before the password is required.



# User Controls

## Change Password

Use this submenu to change the security password for the projector.

1. Select Change Password from the Security submenu. The Confirm Change Password dialog box displays.
2. Select Yes.

### Note

If the incorrect password is entered three times, the device auto shutdowns after 10 seconds.

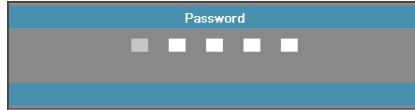

3. Enter the default password <1> <2> <3> <4> <5>. A second password screen displays.

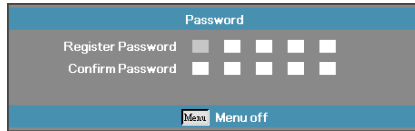

4. Enter the new password twice for verification.

### Note

If the new passwords do not match, the password screen redisplay.

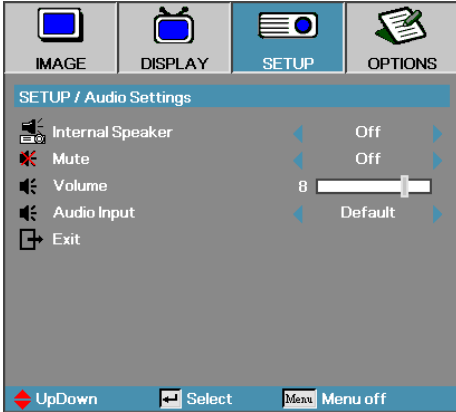

## Setup / Audio Settings

### Internal Speaker

- ▶ Off—turn off the internal speaker.
- ▶ On—turn on the internal speaker.

### Mute

Toggle the audio on or off.

- ▶ Off—the speaker volume and audio out are turned on.
- ▶ On—the speaker volume and audio out are turned off.

### Volume

Press ◀ to decrease the volume.

Press ▶ to increase the volume.

### Audio Input

Press ◀▶ to select audio source input.



# User Controls

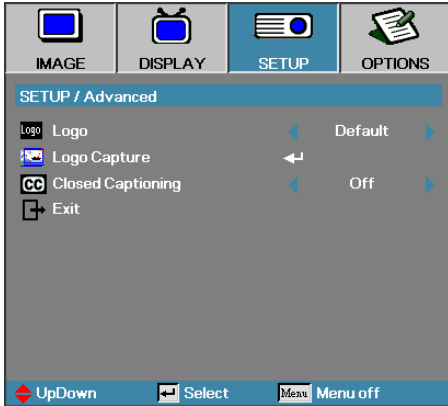

## *Setup / Advanced*

### Logo

Select the screen to display during startup.

- ▶ Default—the supplied default startup screen.
- ▶ Neutral—is Background Color.
- ▶ User—customized screen capture using the Logo Capture function.

### Logo Capture

Capture a displayed screen to use as the startup screen.

1. Display the desired screen on the projector.
2. Select Logo Capture from the Advanced menu.

A confirmation screen displays.

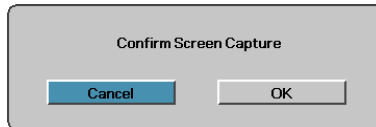

3. Select OK. Screen capture in progress will display.  
When finished, Screen capture Succeeded will display.  
The captured screen is saved as User in the logo menu.

### Closed Captioning

Select the screen to display closed captioning

- ▶ Off—the supplied default setting.
- ▶ CC1/CC2—closed captioning type select.

### **Note**

Only one startup screen can be saved at once. Subsequent captures overwrite previous files limited in 1920 x 1200 (Refer Appendices Timing Table)

# User Controls

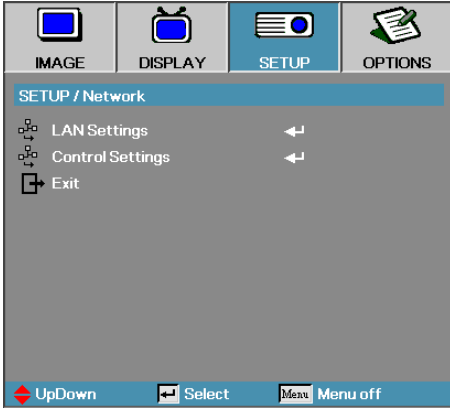

## Setup / Network

### LAN Settings

Enter the LAN Settings menu. See page 42 for more information.

### Control Settings

Enter the Control Settings menu. See page 43 for more information.

# User Controls

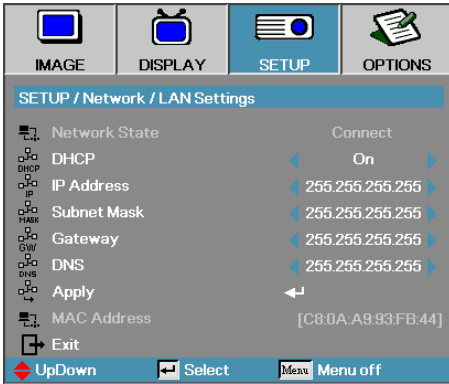

## Setup / LAN Settings

If the connection is successful, the OSD display will show the following dialogue box.

- ▶ Network State—to display network information.
- ▶ DHCP:
  - On: Assign an IP address to the projector from the DHCP server automatically.
  - Off: Assign an IP address manually.
- ▶ IP Address—Select an IP address
- ▶ Subnet Mask—Select subnet mask number.
- ▶ Gateway—Select the default gateway of the network connected to the projector.
- ▶ DNS—Select DNS number.
- ▶ Apply—Press “ENTER” to apply the selection.
- ▶ MAC Address—Read only.

### Note

Network sub-menu can only be accessed if a network cable is connected.

# User Controls

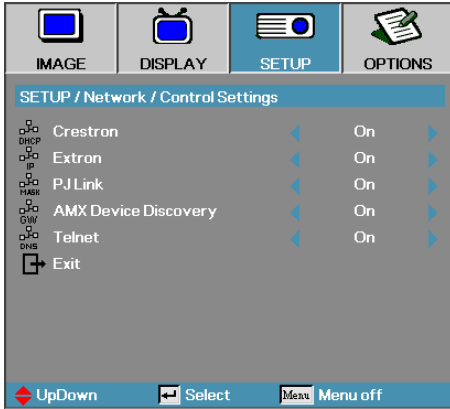

## Setup / Control Settings

### Crestron

Press ◀▶ to check to enable/disable Crestron.

### Extron

Press ◀▶ to check to enable/disable Extron.

### PJ Link

Press ◀▶ to check to enable/disable PJ Link.

### AMX Device Discovery

Press ◀▶ to check to enable/disable AMX Device Discovery.

### Telnet

Press ◀▶ to check to enable/disable Telnet.

# User Controls

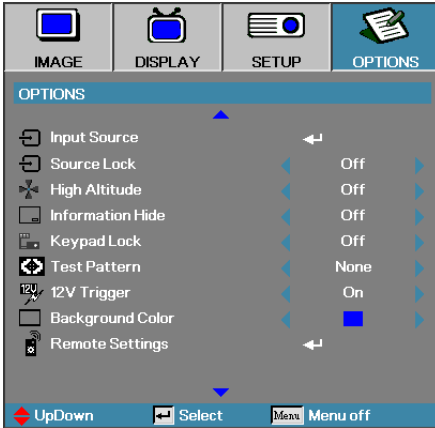

## Options

### Input Source

Enter the Input Source submenu. Select the sources to scan for at startup. See page 47 for more information.

### Source Lock

Lock the current source as the only available source, even if the cable is unplugged.

- ▶ On—only the current source is recognized as an input source.
- ▶ Off—all sources selected in Options | Input Source are recognized as an input source.

### High Altitude

Adjust the fan speed to reflect the environment.

- ▶ On—increases fan speed for high temperature, humidity, or altitude.
- ▶ Off—regular fan speed for normal conditions.

### Information Hide

Suppress informational messages on the projected screen.

- ▶ On—no status messages appear on screen during operation.
- ▶ Off—status messages appear as normal on screen during operation.

## Keypad Lock

Lock the buttons on the projector top panel.

- ▶ On—a warning message displays to confirm keypad lock.



- ▶ Off—projector keypad functions as normal.

## Test Pattern

Display a test pattern. There are Grid, White and None.

## 12V Trigger

Press ◀▶ to select 12V Trigger whether output or not.

## Background Color

Select the desired background color for the projected image when no source is detected.

## Remote Settings

Enter the Remote settings. See page 48 for more information.



Hold "ENTER" key on keypad for 10 seconds to unlock keypad

# User Controls

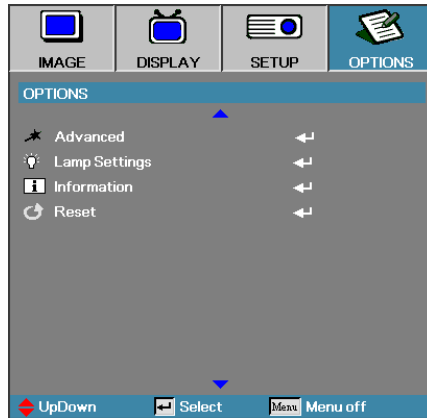

## Advanced

Enter the Advanced menu. See pages 49-50 for more details.

## Lamp Setting

Enter the Lamp Setting menu. See pages 51-52 for more details.

## Information

Show the projector information.

## Reset

Reset all Options to default factory settings.

## Options / Input Source

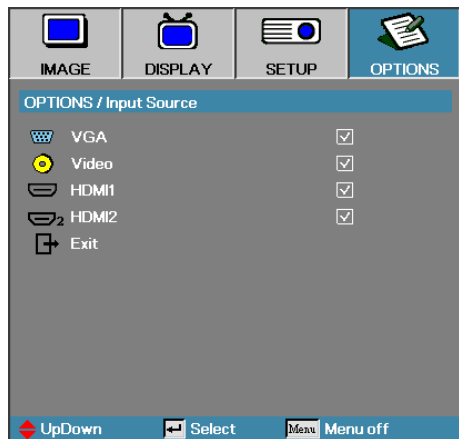

### Note

If all sources are deselected, the projector cannot display any images. Always leave at least one source selected.

### Input Source

Use this option to enable / disable input sources. Press ▲ or ▼ to select a source, then press ◀ or ▶ to enable / disable it. Press “ENTER” to finalize the selection. The projector will not search inputs that are de-selected.



# User Controls

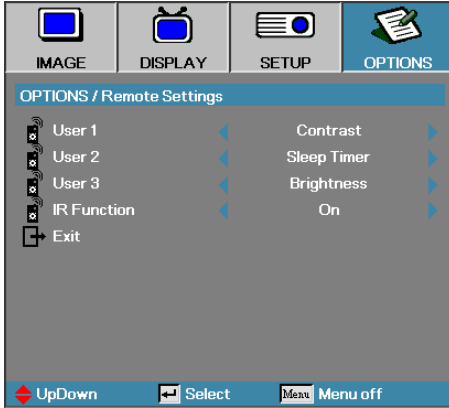

## *Options / Remote Settings*

### User1

Set User1 key as a hotkey for LAN, Brightness, Contrast, Sleep Timer, Color Matching, Color Temp, Gamma, Source Lock, Projection, Lamp Settings, Zoom, Test Pattern, Freeze, HDMI1, HDMI2 function.

### User2

Set User2 key as a hotkey for LAN, Brightness, Contrast, Sleep Timer, Color Matching, Color Temp, Gamma, Source Lock, Projection, Lamp Settings, Zoom, Test Pattern, Freeze, HDMI1, HDMI2 function.

### User3

Set User3 key as a hotkey for LAN, Brightness, Contrast, Sleep Timer, Color Matching, Color Temp, Gamma, Source Lock, Projection, Lamp Settings, Zoom, Test Pattern, Freeze, HDMI1, HDMI2 function.

### IR Function

Enable or Disable projector's IR function.

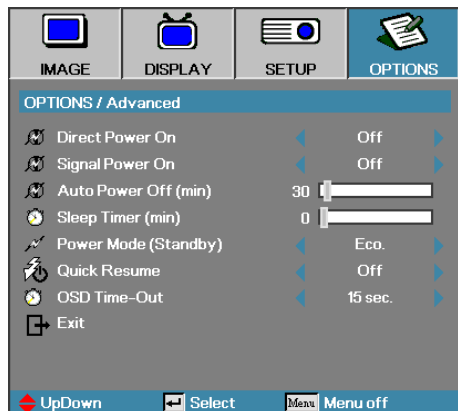

## Options / Advanced

### Direct Power On

Enable or disable Direct Power On.

- ▶ On—the projector powers on automatically when AC power is supplied.
- ▶ Off—the projector must be powered on as normal.

### Signal Power On

Enable or disable Signal Power On.

- ▶ On—the projector powers on automatically when an active signal is detected.
- ▶ Off—disable the power on trigger by active signal is detected.



1. Only available on Standby Mode is Active.
2. If projector is turned off with keeping input the signal source (the last image source showing on screen), it will not re-start unless:
  - a. Terminate the last image source and input any signal source again.
  - b. Unplug and re-plug the projector power again.
3. Signal power on will ignore “source lock” setting.

# User Controls

## Auto Power Off (min)

Set the Auto Power Off interval. The projector powers off the lamp after 30 minutes of no signal by default. The following warning is displayed 60 seconds before power off.

The projector will automatically shutdown after 60 sec.

## Sleep Timer (min)

Set the Sleep Timer interval. The projector powers off after the specified time period of inactivity (regardless of signal). The following warning is displayed 60 seconds before power off.

The projector will automatically shutdown after 60 sec.



When Power Mode(Standby) is set to Eco., the VGA & Audio pass-through and RJ45 would be deactivated. Limited functionality is available on RS232 control.

## Power Mode (Standby)

- ▶ Eco.: Choose "Eco." to save power dissipation further < 0.5W.
- ▶ Active: Choose "Active" to return to normal standby and the VGA out port will be enabled.

## Quick Resume

If Quick Resume is On, the projector can resume operating soon provided the projector is turned back on within 100 seconds of being turned off.

## OSD Time-Out

Set the OSD display time



Projector won't really be 100% turn off unless end-user wait 100sec.

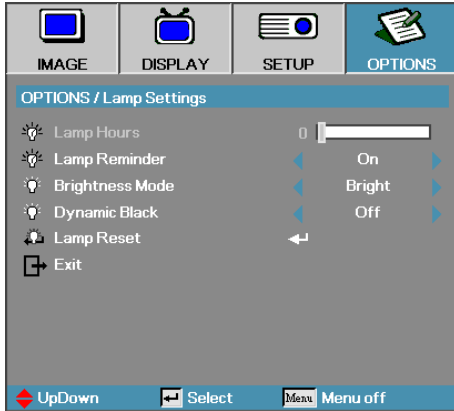

## Options / Lamp Setting

### Lamp Hour

Displays the number of hours the lamp has been active. This item is for display only.

### Lamp Reminder

Enable or disable the lamp life span reminder.

- ▶ On—a warning message displays when remaining lamp life is less than 30 hours.



- ▶ Off—no warning message displays.

### Brightness Mode

Select the lamp brightness mode.

- ▶ Bright—the default setting.
- ▶ Eco.—lower brightness setting to conserve lamp life.

# User Controls

## DynamicBlack

Select the DynamicBlack mode.

## Lamp Reset

After replacing the lamp, reset the lamp counter to accurately reflect the new lamp's life span.

1. Select Lamp Reset.

A confirmation screen displays.



2. Select Yes to reset the lamp counter to zero.



When DynamicBlack is On, and Brightness Mode is set to Bright, the Dynamic range is 100%~30%. When brightness mode is on Eco. Mode, the dynamic range is 80%~30%.

## LAN\_RJ45

### Note

- Projector connects to LAN, please use Ethernet Normal Cable.
- Peer-to-peer (PC connects to Projector directly), please use Ethernet Crossover Cable.

For simplicity and ease of operation, the Optoma projector provides diverse networking and remote management features. The LAN/RJ45 function of the projector through a network, such as remotely manage: Power On/Off, Brightness and Contrast settings. Also, projector status information, such as: Video-Source, Sound-Mute, etc.

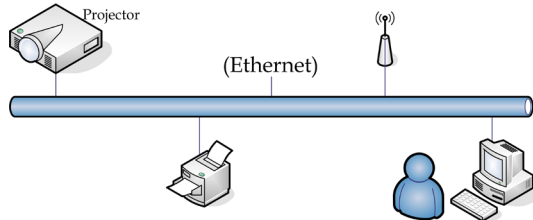

### Wired LAN Terminal functionalities

The projector can be controlled by a PC (Laptop) or other external device via LAN/RJ45 port and compatible with Crestron / Extron / AMX (Device Discovery) / PJLink.

- ▶ Crestron is a registered trademark of Crestron Electronics, Inc. of the United States.
- ▶ Extron is a registered trademark of Extron Electronics, Inc. of the United States.
- ▶ AMX is a registered trademark of AMX LLC of the United States.
- ▶ PJLink applied for trademark and logo registration in Japan, the United States of America, and other countries by JBMIA.

### Supported External Devices

This projector is supported by the specified commands of the Crestron Electronics controller and related software (ex, RoomView®).

<http://www.crestron.com/>

This projector is compliant to support Extron device(s) for reference.

<http://www.extron.com/>

This projector is supported by AMX ( Device Discovery ).

<http://www.amx.com/>

# User Controls

This projector supports all commands of PJLink Class1 (Version 1.00).

<http://pjlink.jbmia.or.jp/english/>

For more detail of information about the diverse types of external devices which can be connected to the LAN/RJ45 port and remote/control the projector, as well as the related control commands supporting for each external device, kindly please get contact with the Support-Service directly.

## LAN RJ45

1. Connect an RJ45 cable to RJ45 ports on the projector and the PC (Laptop).

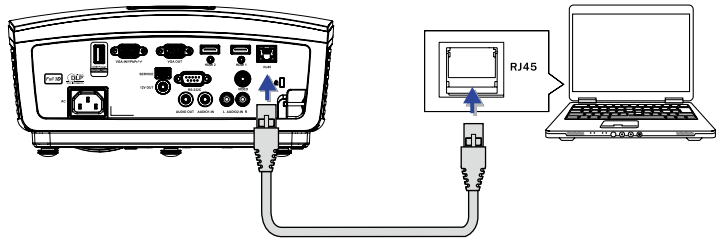

2. On the PC (Laptop), select Start -> Control Panel-> Network Connections.

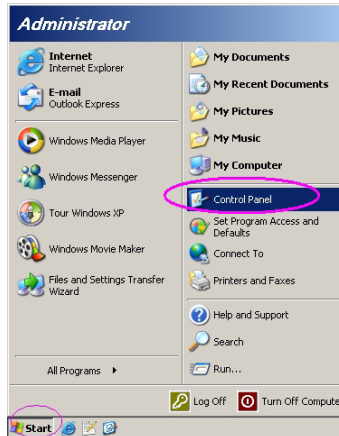

# User Controls

3. Right Click on your Local Area Connection, and select Property.

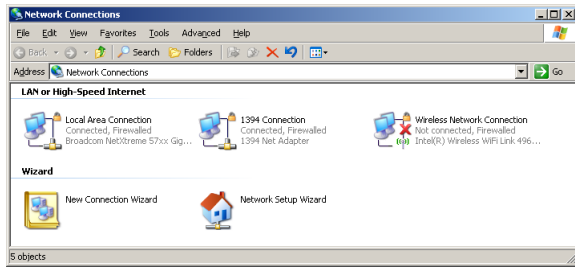

4. In the Properties window, select the General tab, and select Internet Protocol (TCP/IP).

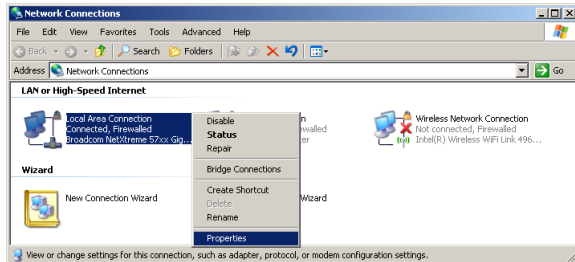

5. Click Properties.

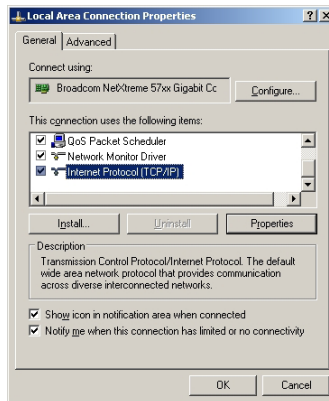



# User Controls

6. Fill in the IP address and Subnet mask, then press OK.

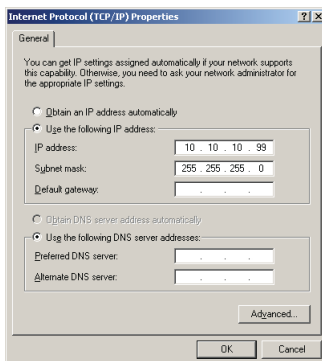

7. Press the Menu button on the projector.
8. Select OSD-> SETUP-> Network Settings-> Lan Settings.
9. After getting into Network Status, input the following:
  - ▶ DHCP: Off
  - ▶ IP Address: 10.10.10.10
  - ▶ Subnet Mask: 255.255.255.0
  - ▶ Gateway: 0.0.0.0
  - ▶ DNS: 0.0.0.0
10. Press "ENTER" / ▶ to confirm settings.
11. Open a web browser (ex, Microsoft Internet Explorer with Adobe Flash Player 9.0 or higher).

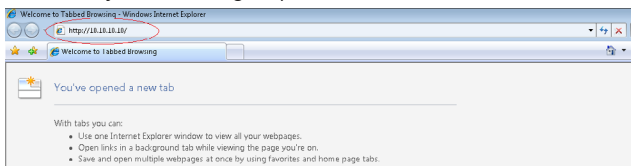

12. In the Address bar, input the IP address: 10.10.10.10.

# User Controls

13. Press “ENTER” / ►.

The projector is setup for remote management. The LAN/RJ45 function displays as follows.



For more information, please visit <http://www.crestron.com>

**Optoma**

Admin > Information

Information	
<b>Alert Settings</b>	
<b>Crestron</b>	
<b>Model Name</b>	
<b>System</b>	
System Status	Power On
Display Source	No Source
Lamp Hours	8
Image	Presentation
Error Status	No Error
<b>LAN Status</b>	
IP address	10.10.10.10
Subnet mask	255.255.255.0
Default gateway	0.0.0.0
DNS Server	0.0.0.0
MAC address	
<b>Version</b>	
LAN Version	
FW Version	

Crestron Copyright © 2013 by Optoma Corp.

Power Vol- Mute Vol+

SourceList

Menu ▲ Auto

◀ Enter ▶

Blank ▼ Source

Freeze Contrast Brightness Color



Expansion Options

Crestron Control	Projector	User Password
IP Address	Projector Name PJ01	<input type="checkbox"/> User Enabled
IP ID	Location FM01	Password
Control Port	Assigned To Sit	Confirmed
<input type="button" value="Control Set"/>	<input type="button" value="Set"/>	<input type="button" value="User Set"/>
	Network Config <input type="checkbox"/> DHCP Enabled	
	IP Address 10.10.10.10	<b>Admin Password</b>
	Subnet Mask 255.255.255.0	<input type="checkbox"/> Adm Enabled
	Default Gateway 0.0.0.0	Password
	DNS Server 0.0.0.0	Confirmed
	<input type="button" value="Net Set"/>	<input type="button" value="Adm Set"/>
	<input type="button" value="Tools Exit"/>	

# User Controls

Category	Item	Input-Length
Crestron Control	IP Address	15
	IP ID	3
	Port	5
Projector	Projector Name	10
	Location	10
	Assigned To	10
Network Configuration	DHCP (Enabled)	(N/A)
	IP Address	15
	Subnet Mask	15
	Default Gateway	15
	DNS Server	15
User Password	Enabled	(N/A)
	New Password	10
	Confirm	10
Admin Password	Enabled	(N/A)
	New Password	10
	Confirm	10

For more information, please visit <http://www.crestron.com>.

## Preparing Email Alerts

1. Make sure that user can access the homepage of LAN RJ45 function by web browser (for ex-ample, Microsoft Internet Explorer v6.01/v8.0).
2. From the Homepage of LAN/RJ45, click Alert Settings.

**Optima**

Admin > Information

- Information
- Alert Settings**
- Crestron

Model Name	
<b>System</b>	
System Status	Power On
Display Source	No Source
Light Hours	0
Image	Presentation
Error Status	No Error
<b>LAN Status</b>	
IP address	10.10.10.10
Subnet mask	255.255.255.0
Default gateway	0.0.0.0
DNS Server	0.0.0.0
MAC address	
<b>Version</b>	
LAN Version	
FW Version	

Crestron Copyright © 2013 by Optima Corp.

# User Controls

3. By default, these input boxes in Alert Settings are blank.

Optoma

Admin - Alert Settings

Information

Alert Settings

Crestron

SMTP setting

Server Address

Server Port 25

User Name

Password

Mail Server Apply

Email Setting

To

Cc

Subject Projector Warning Information!

From

Mail Address Apply

Alert Condition

Fan Error

Lamp Error

High Temp Error

Apply | Send Test Mail

Crestron Copyright 2013 by Optoma Corp.

4. For Sending alert mail, input the following:
- ▶ The SMTP field is the mail server for sending out email (SMTP protocol). This is a required field.
  - ▶ The To field is the recipient's email address (for example, the projector administrator). This is a required field.
  - ▶ The Cc field sends a carbon copy of the alert to the specified email address. This is an optional field (for example, the projector administrator's assistant).
  - ▶ The From field is the sender's email address (for example, the projector administrator). This is a required field.
  - ▶ Select the alert conditions by checking the desired boxes.



**Note**

Fill in all fields as specified. User can click Send Test Mail to test what setting is correct. For successful sending an email alert, you must select alert conditions and enter a correct email address.

Optoma

Admin - Alert Settings

Information

Alert Settings

Crestron

SMTP setting

Server Address mail.comp.com

Server Port 25

User Name Sender US

Password \*\*\*\*

Mail Server Apply

Email Setting

To test@mail.comp.com

Cc test@mail.comp.com

Subject Projector Warning Information!

From send@mail.comp.com

Mail Address Apply

Alert Condition

Fan Error

Lamp Error

High Temp Error

Apply | Send Test Mail

Crestron Copyright 2013 by Optoma Corp.

# User Controls

## RS232 by Telnet Function

Besides projector connected to RS232 interface with “Hyper-Terminal” communication by dedicated RS232 command control, there is alternative RS232 command control way, so called “RS232 by TELNET” for LAN/RJ45 interface.

## Quick Start-Guide for “RS232 by TELNET”

Check and get the IP-Address on OSD of the projector.

Make sure that laptop/PC can access the web-page of the projector.

Make sure that “Windows Firewall” setting to be disabled in case of “TELNET” function filtering out by laptop/PC.



1. Start => All Programs => Accessories => Command Prompt.

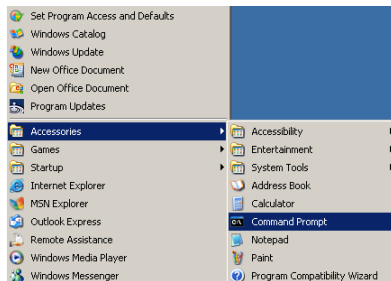

# User Controls

- Input the command format like the below:  
`telnet ttt.xxx.yyy.zzz 23` ("Enter" key pressed)  
`(ttt.xxx.yyy.zzz: IP-Address of the projector)`
- If Telnet-Connection ready, and user can have RS232 command input, then "Enter" key pressed, the RS232 command will be workable.

## How to have TELNET enabled in Windows VISTA / 7

By default installation for Windows VISTA, "TELNET" function is not included. But end-user can have it by way of "Turn Windows features On or Off" to be enabled.

- Open "Control Panel" in Windows VISTA.

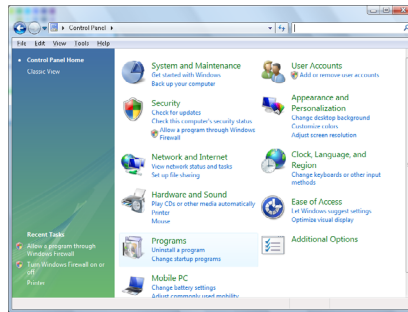

- Open "Programs".

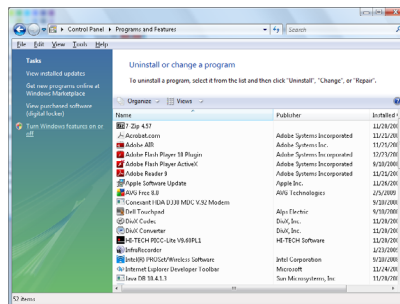

# User Controls

3. Select "Turn Windows features on or off" to open.

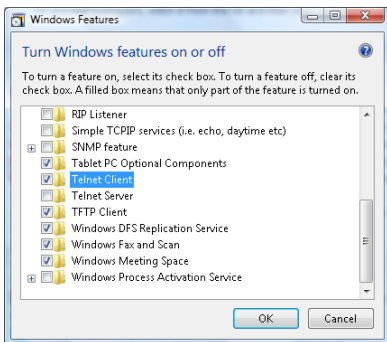

4. Have "Telnet Client" option checked, then press "OK" button.

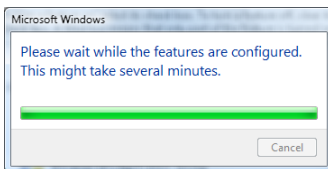

## Specsheet for "RS232 by TELNET" :

1. Telnet: TCP.
2. Telnet port: 23 (for more detail, kindly please get contact with the service agent or team).
3. Telnet utility: Windows "TELNET.exe" (console mode).
4. Disconnection for RS232-by-Telnet control normally: Close Windows Telnet utility directly after TELNET connection ready.

Limitation 1 for Telnet-Control: there is less than 50 bytes for successive network payload for Telnet-Control application.

Limitation 2 for Telnet-Control: there is less than 26 bytes for one complete RS232 command for Telnet-Control.

Limitation 3 for Telnet-Control: Minimum delay for next RS232 command must be more than 200 (ms).

(\* , In Windows XP built-in "TELNET.exe" utility, "Enter" key pressed will have "Carriage-Return" and "New-Line" code.)

## Troubleshooting

*If you experience a problem with your projector, please refer to the following information. If a problem persists, please contact your local reseller or service center.*

### Image

#### **?** No image appears on-screen

- ▶ Ensure all the cables and power connections are correctly and securely connected as described in the "Installation" section.
- ▶ Ensure the pins of connectors are not crooked or broken.
- ▶ Check if the projection lamp has been securely installed. Please refer to the "Replacing the Lamp" section.
- ▶ Make sure you have removed the lens cap and the projector is switched on.

#### **?** Image is out of focus

- ▶ Make sure the Lens cap is removed.
- ▶ Adjust the Focus Ring on the projector lens.
- ▶ Make sure the projection screen is between the required distance from the projector. See pages 16-17.

#### **?** The image is stretched when displaying 16:9 DVD title

- ▶ When you play anamorphic DVD or 16:9 DVD, the projector will show the best image in 16: 9 format on projector side.
- ▶ If you play the LBX format DVD title, please change the format as LBX in projector OSD.
- ▶ If you play 4:3 format DVD title, please change the format as 4:3 in projector OSD.
- ▶ If the image is still stretched, you will also need to adjust the aspect ratio by referring to the following:
- ▶ Please setup the display format as 16:9 (wide) aspect ratio type on your DVD player.



## **? Image is too small or too large**

- ▶ Adjust the zoom lever from the lens.
- ▶ Move the projector closer to or further from the screen.
- ▶ Press [Menu] on the projector panel, go to “Display->Format”. Try the different settings.

## **? Image has slanted sides:**

- ▶ If possible, reposition the projector so that it is centered on the screen and below the bottom of the screen and use PureShift to make adjustments to the image position.
- ▶ Use “Display->V Keystone” from the OSD to make an adjustment.

## **? Image is reversed**

- ▶ Select “System->Projection” from the OSD and adjust the projection direction.

## Other







## **? The projector stops responding to all controls**

- ▶ If possible, turn off the projector, then unplug the power cord and wait at least 20 seconds before reconnecting power.

## **? Lamp burns out or makes a popping sound**

- ▶ When the lamp reaches its end of life, it will burn out and may make a loud popping sound. If this happens, the projector will not turn on until the lamp module has been replaced. To replace the lamp, follow the procedures in the “Replacing the Lamp” section on page 67.

## Projector LED Status Indicator

Message	Power LED  (Green)	Temp LED  (Red)	Lamp LED  (Red)
Standby State (Input power cord)	Slow Flashing 2 sec off 2 sec on	○	○
Power on (Warming)	Flashing 0.5 sec off 0.5 sec on	○	○
Power on & Lamp lighting		○	○
Power off (Cooling)	Flashing 1 sec off 1 sec on	○	○
Error (Lamp fail)	Flashing 0.5 sec off 0.5 sec on	○	
Error (Fan fail)	Flashing 0.5 sec off 0.5 sec on	Flashing 0.5 sec off 0.5 sec on	○
Error (Over Temp)	Flashing 0.5 sec off 0.5 sec on		○
Quick Resume(100 secs)	Flashing 0.25 sec off 0.25 sec on	○	○

**Note**

Steady light =>   
No light => ○

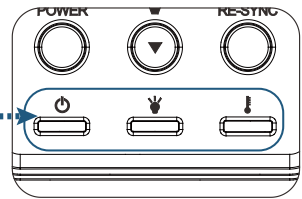
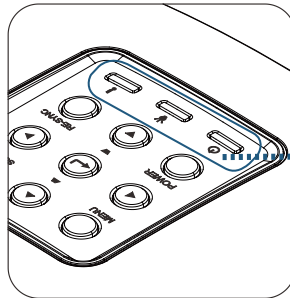

# Appendices

## LED states

### On Screen Messages

- ▶ Fan failed:  
The projector will switch off automatically.
- ▶ Over temperature:  
The projector will switch off automatically.
- ▶ Replacing the lamp:  
Lamp is approaching the end of its rated life.  
Replacement suggested.

 Lamp is approaching the end of its useful life



Warning:

Only use genuine lamps.

## Remote Control

### If the remote control does not work

- ▶ Check the operating angle of the remote control is within  $\pm 15^\circ$  both horizontally and vertically of one of the IR receivers on the projector.
- ▶ Make sure there are no any obstructions between the remote control and the projector. Move to within 7 m (23 ft) of the projector.
- ▶ Make sure batteries are inserted correctly.
- ▶ Replace batteries if they are exhausted.

## Replacing the Lamp

*The projector automatically detects the lamp life. When the lamp life is nearing the end of use, you will receive a warning message.*



Lamp is approaching the end of its useful life

*When you see this message, please contact your local reseller or service center to change the lamp as soon as possible. Make sure the projector has been cooled down for at least 30 minutes before changing the lamp.*



Warning: Lamp compartment is hot! Allow it to cool down before changing lamp!



Warning: To reduce the risk of personal injury, do not drop the lamp module or touch the lamp bulb. The bulb may shatter and cause injury if it is dropped.

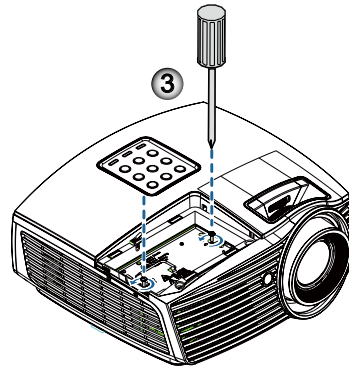
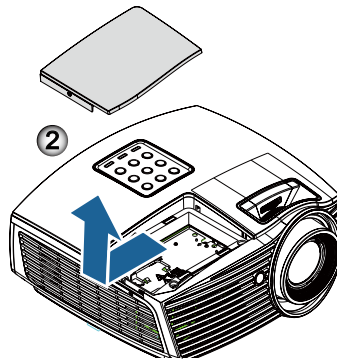
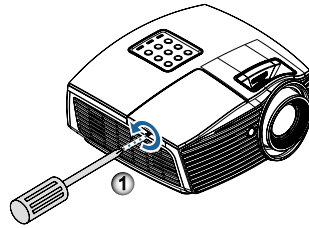

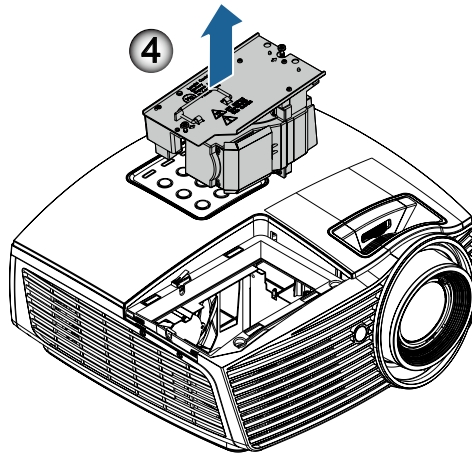

## Lamp Replacing Procedure:

1. Switch off the power to the projector by pressing the Power button.
2. Allow the projector to cool down at least 30 minutes.
3. Disconnect the power cord.
4. Remove the single screw on the lamp compartment cover. ❶
5. Remove the lamp compartment cover. ❷
6. Remove the two screws from the lamp module.  
Lift the module handle up. ❸
7. Pull firmly on the module handle to remove the lamp module. ❹

**To replace the lamp module, reverse the previous steps. While installing, align the lamp module with the connector and ensure it is level to avoid damage.**

8. Turn on the projector and do "Lamp Reset" after the lamp module is replaced.

Lamp Reset: (i) Press "Menu" -> (ii) Select "Options" -> (iii) Select "Lamp Settings" -> (iv) Select "Lamp Reset" -> (v) Select "Yes".

## Compatibility Modes

### Video Compatibility

NTSC	NTSC M/J, 3.58MHz, 4.43MHz
PAL	PAL B/D/G/H/I/M/N, 4.43MHz
SECAM	SECAM B/D/G/K/K1/L, 4.25/4.4 MHz
SDTV	480i/p, 576i/p
HDTV	720p(50/60Hz), 1080i(50/60Hz), 1080P(50/60Hz)

### Video Timing Detail Describe

Signal	Resolution	Refresh Rate(Hz)	Notes
TV(NTSC)	720 x 480	60	For Composite Video /S-video
TV(PAL, SECAM)	720 x 576	50	
SDTV (480I)	720 x 480	60	For Component
SDTV (480P)	720 x 480	60	
SDTV (576I)	720 x 576	50	
SDTV (576P)	720 x 576	50	
HDTV (720p)	1280 x 720	50/60	
HDTV (1080I)	1920 x 1080	50/60	
HDTV (1080p)	1920 x 1080	24/50/60	

## Computer Compatibility - VESA standards

### Computer Signal (Analog RGB Compatible)

Signal	Resolution	Refresh Rate(Hz)	Notes
VGA	640 X 480	60/67/72/85	Mac 60/72/85/
SVGA	800 X 600	56/60 (*2)/72/85/120 (*2)	Mac 60/72/85
XGA	1024 X768	48/50(*4)/60 (*2)/70/75/85/120 (*2)	Mac 60/70/75/85
HDTV (720P)	1280 x 720	50/60 (*2)/120 (*2)	Mac 60
WXGA	1280 x 768	60/75/85	Mac 60/75/85
	1280 x 800	48/50(*4)60	Mac 60
WXGA(*3)	1366 x 768	60	
WXGA+	1440 x 900	60	Mac 60
SXGA	1280 x 1024	60/75/85	Mac 60/75
SXGA+	1400 x 1050	60	
UXGA	1600 x 1200	60	
HDTV (1080p)	1920 x 1080	24/50/60	Mac 60
WUXGA	1920 x 1200 (*1)	60	Mac 60

(\*1) 1920 x 1200 @60Hz only support RB (reduced blanking).

(\*2) 3D timing for 3D Ready projector(STD) and True 3D projector. (Option)

(\*3) Winow 8 standard timing

(\*4) Native resolution must support @50hz



## Input Signal for HDMI/DVI-D

Signal	Resolution	Refresh Rate(Hz)	Notes
VGA	640 x 480	60	Mac 60/72/85
SVGA	800 x 600	60(*2)/72/ 85/120(*2)	Mac 60/72/85
XGA	1024 x 768	48/50 60(*2)/70/75/ 85/120(*2)	Mac 60/70/75/85
SDTV (480i)	720 x 480	60	
SDTV (480p)	720 x 480	60	
SDTV (576i)	720 x 576	50	
SDTV (576p)	720 x 576	50	
WSVGA (1024 x 600)	1024 x 600	60	
HDTV (720p)	1280 x 720	50/60(*2)/ 120(*2)	Mac 60
WXGA	1280 x 768	60/75/85	Mac 75
	1280 x 800	48/60(*2)/ 50	Mac 60
WXGA	1366 x 768	60	
WXGA+	1440 x 900	60	Mac 60
SXGA	1280 x 1024	60/75/85	Mac 60/75
SXGA+	1400 x 1050	60	
UXGA	1600 x 1200	60	
HDTV (1080i)	1920 x 1080	50/60	
HDTV (1080p)	1920 x 1080	24/30/50/60/120	Mac 60
WUXGA	1920 x 1200 (*1)	50/60	Mac 60

(\*1) 1920 x 1200 @60Hz only support RB (reduced blanking).

(\*2) 3D timing for 3D Ready projector(STD) and True 3D projector(Option)

## True 3D Video Compatibility table

Input Resolutions	Input timing		
HDMI 1.4a 3D Input	1280 x 720p @50Hz	Top-and-Bottom	
	1280 x 720p @60Hz	Top-and-Bottom	
	1280 x 720p @50Hz	Frame packing	
	1280 x 720p @60Hz	Frame packing	
	1920 x 1080i @50Hz	Side-by-Side (Half)	
	1920 x 1080i @60Hz	Side-by-Side (Half)	
	1920 x 1080p @24Hz	Top-and-Bottom	
	1920 x 1080p @24Hz	Frame packing	
HDMI 1.3	1920 x 1080i @50Hz	Side-by-Side (Half)	SBS mode is on
	1920 x 1080i @60Hz		
	1280 x 720p @50Hz		
	1280 x 720p @60Hz	Top-and-Bottom	TAB mode is on
	1920 x 1080i @50Hz		
	1920 x 1080i @60Hz		
	1280 x 720p @50Hz		
	1280 x 720p @60Hz	HQFS	3D format is Frame sequential
480i			

- ▶ If 3D input is 1080p @24Hz, the DMD should replay with integral multiple with 3D mode.
- ▶ 1080i @25Hz and 720p @50Hz will run in 100Hz; other 3D timing will run in 120Hz.

## RS232 Commands and Protocol Function List

### RS232 Pin Assignments (projector side)

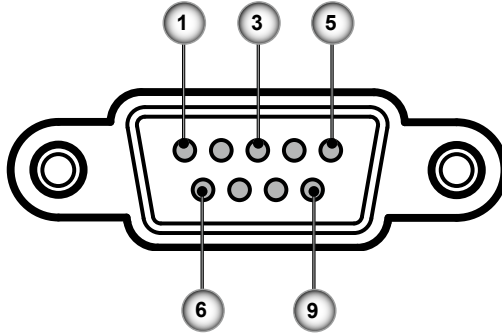

Pin no.	Name	I/O (From Projector Side)
1	NC	—
2	RXD	IN
3	TXD	OUT
4	NC	—
5	NC	—
6	NC	—
7	RS232	RTS
8	RS232	CTS
9	NC	—

## RS232 Protocol Function List

232 ASCII Code	HEX Code	Function	Description
~XX00 1	7E 30 30 30 30 20 31 0D	Power ON	
~XX00 0	7E 30 30 30 30 20 30 0D	Power OFF	(0/2 for backward compatible)
~XX00 1 ~nnnn	7E 30 30 30 30 20 31 20 a 0D	Power ON with Password	~nnnn = ~0000 (a=7E 30 30 30 30 30) ~99999 (a=7E 39 39 39 39 39)
~XX01 1	7E 30 30 30 31 20 31 0D	Resync	
~XX02 1	7E 30 30 30 32 20 31 0D	AV Mute	On
~XX02 0	7E 30 30 30 32 20 30 0D		Off (0/2 for backward compatible)
~XX03 1	7E 30 30 30 33 20 31 0D	Mute	On
~XX03 0	7E 30 30 30 33 20 30 0D		Off (0/2 for backward compatible)
~XX04 1	7E 30 30 30 34 20 31 0D	Freeze	
~XX04 0	7E 30 30 30 34 20 30 0D	Unfreeze	(0/2 for backward compatible)
~XX05 1	7E 30 30 30 35 20 31 0D	Zoom Plus	
~XX06 1	7E 30 30 30 36 20 31 0D	Zoom Minus	
~XX12 1	7E 30 30 31 32 20 31 0D	Direct Source Commands	HDMI1
~XX12 15	7E 30 30 31 32 20 31 35 0D		HDMI2
~XX12 5	7E 30 30 31 32 20 35 0D		VGA
~XX12 10	7E 30 30 31 32 20 31 30 0D		Video
~XX20 1	7E 30 30 32 30 20 31 0D	Display Mode	Presentation
~XX20 2	7E 30 30 32 30 20 32 0D		Bright
~XX20 3	7E 30 30 32 30 20 33 0D		Movie
~XX20 4	7E 30 30 32 30 20 34 0D		sRGB
~XX20 5	7E 30 30 32 30 20 35 0D		User
~XX20 7	7E 30 30 32 30 20 37 0D		Blackboard
~XX20 13	7E 30 30 32 30 21 33 0D		DICOM SIM.
~XX20 9	7E 30 30 32 30 20 39 0D		3D
~XX21 n	7E 30 30 32 31 20 a 0D	Brightness	n = -50 (a=2D 35 30) ~ 50 (a=35 30)
~XX22 n	7E 30 30 32 32 20 a 0D	Contrast	n = -50 (a=2D 35 30) ~ 50 (a=35 30)
~XX23 n	7E 30 30 32 33 20 a 0D	Sharpness	n = 1 (a=30 31) ~ 15 (a=31 35)
~XX327 n	7E 58 58 33 32 37 20 a 0D	Color Matching	Red Hue n = -50 (a=2D 35 30) ~ 50 (a=35 30)
~XX328 n	7E 58 58 33 32 38 20 a 0D		Green Hue n = -50 (a=2D 35 30) ~ 50 (a=35 30)
~XX329 n	7E 58 58 33 32 39 20 a 0D		Blue Hue n = -50 (a=2D 35 30) ~ 50 (a=35 30)
~XX330 n	7E 58 58 33 33 30 20 a 0D		Cyan Hue n = -50 (a=2D 35 30) ~ 50 (a=35 30)
~XX331 n	7E 58 58 33 33 31 20 a 0D		Yellow Hue n = -50 (a=2D 35 30) ~ 50 (a=35 30)
~XX332 n	7E 58 58 33 33 32 20 a 0D		Magenta Hue n = -50 (a=2D 35 30) ~ 50 (a=35 30)
~XX333 n	7E 58 58 33 33 33 20 a 0D		Red Saturation n = -50 (a=2D 35 30) ~ 50 (a=35 30)
~XX334 n	7E 58 58 33 33 34 20 a 0D		Green Saturation n = -50 (a=2D 35 30) ~ 50 (a=35 30)
~XX335 n	7E 58 58 33 33 35 20 a 0D		Blue Saturation n = -50 (a=2D 35 30) ~ 50 (a=35 30)
~XX336 n	7E 58 58 33 33 36 20 a 0D		Cyan Saturation n = -50 (a=2D 35 30) ~ 50 (a=35 30)
~XX337 n	7E 58 58 33 33 37 20 a 0D		Yellow Saturation n = -50 (a=2D 35 30) ~ 50 (a=35 30)
~XX338 n	7E 58 58 33 33 38 20 a 0D		Magenta Saturation n = -50 (a=2D 35 30) ~ 50 (a=35 30)
~XX339 n	7E 58 58 33 33 39 20 a 0D		Red Gain n = -50 (a=2D 35 30) ~ 50 (a=35 30)
~XX340 n	7E 58 58 33 34 30 20 a 0D		Green Gain n = -50 (a=2D 35 30) ~ 50 (a=35 30)
~XX341 n	7E 58 58 33 34 31 20 a 0D		Blue Gain n = -50 (a=2D 35 30) ~ 50 (a=35 30)
~XX342 n	7E 58 58 33 34 32 20 a 0D		Cyan Gain n = -50 (a=2D 35 30) ~ 50 (a=35 30)
~XX343 n	7E 58 58 33 34 33 20 a 0D		Yellow Gain n = -50 (a=2D 35 30) ~ 50 (a=35 30)
~XX344 n	7E 58 58 33 34 34 20 a 0D		Magenta Gain n = -50 (a=2D 35 30) ~ 50 (a=35 30)
~XX345 n	7E 58 58 33 34 35 20 a 0D		White/R n = -50 (a=2D 35 30) ~ 50 (a=35 30)
~XX346 n	7E 58 58 33 34 36 20 a 0D		White/G n = -50 (a=2D 35 30) ~ 50 (a=35 30)
~XX347 n	7E 58 58 33 34 37 20 a 0D		White/B n = -50 (a=2D 35 30) ~ 50 (a=35 30)
~XX34 n	7E 30 30 33 34 20 a 0D	BrilliantColor™	n = 1 (a=30 31) ~ 10 (a=31 30)
~XX35 1	7E 30 30 33 35 20 31 0D	Gamma	Film
~XX35 2	7E 30 30 33 35 20 32 0D		Video
~XX35 3	7E 30 30 33 35 20 33 0D		Graphics
~XX35 4	7E 30 30 33 35 20 34 0D		Standard
~XX36 4	7E 30 30 33 36 20 34 0D	Color Temp.	Warm (D55)
~XX36 1	7E 30 30 33 36 20 31 0D		Standard (D65)
~XX36 2	7E 30 30 33 36 20 32 0D		Cool (D75)
~XX36 3	7E 30 30 33 36 20 33 0D		Cold (D83)
~XX37 1	7E 30 30 33 37 20 31 0D	Color Space	Auto
~XX37 2	7E 30 30 33 37 20 32 0D		RGB (0-255)
~XX37 3	7E 30 30 33 37 20 33 0D		YUV
~XX37 4	7E 30 30 33 37 20 34 0D		RGB(16 - 235)
~XX73 n	7E 30 30 37 33 20 a 0D	Signal	Frequency n = -5 (a=2D 35) ~ 5 (a=35) By signal
~XX91 1	7E 30 30 39 31 20 31 0D		Automatic On
~XX91 0	7E 30 30 39 31 20 30 0D		Off
~XX74 n	7E 30 30 37 34 20 a 0D		Phase n = 0 (a=30) ~ 31 (a=33 31) By signal
~XX75 n	7E 30 30 37 35 20 a 0D		H. Position n = -5 (a=2D 35) ~ 5 (a=35) By timing
~XX76 n	7E 30 30 37 36 20 a 0D		V. Position n = -5 (a=2D 35) ~ 5 (a=35) By timing
~XX45 n	7E 30 30 34 34 20 a 0D	Color (Saturation)	n = -50 (a=2D 35 30) ~ 50 (a=35 30)
~XX44 n	7E 30 30 34 35 20 a 0D	Tint	n = -50 (a=2D 35 30) ~ 50 (a=35 30))
~XX60 1	7E 30 30 36 30 20 31 0D	Format	4:3

# Appendices

~XX60 2	7E 30 30 36 30 20 32 0D		16:9
~XX60 3	7E 30 30 36 30 20 33 0D		16:10(WXGA)
~XX60 5	7E 30 30 36 30 20 35 0D		LBX
~XX60 6	7E 30 30 36 30 20 36 0D		Native
~XX60 7	7E 30 30 36 30 20 37 0D		Auto
~XX61 n	7E 30 30 36 31 20 a 0D	Edge mask	n = 0 (a=30) ~ 10 (a=31 30)
~XX62 n	7E 30 30 36 32 20 a 0D	Zoom	n = -5 (a=2D 35) ~ 25 (a=32 35)
~XX63 n	7E 30 30 36 33 20 a 0D	H Image Shift	n = -100 (a=2D 31 30 30) ~ 100 (a=31 30 30)
~XX64 n	7E 30 30 36 34 20 a 0D	V Image Shift	n = -100 (a=2D 31 30 30) ~ 100 (a=31 30 30)
~XX66 n	7E 30 30 36 36 20 a 0D	V Keystone	n = -40 (a=2D 34 30) ~ 40 (a=34 30)
~XX230 1	7E 30 30 32 33 30 20 31 0D	3D Mode	DLP-Link
~XX230 3	7E 30 30 32 33 30 20 31 0D	3D Mode	IR
~XX400 0	7E 30 30 34 30 30 20 30 0D	3D --2D	3D
~XX400 1	7E 30 30 34 30 30 20 31 0D		L
~XX400 2	7E 30 30 34 30 30 20 32 0D		R
~XX405 0	7E 30 30 34 30 35 20 30 0D	3D Format	Auto
~XX405 1	7E 30 30 34 30 35 20 31 0D		SBS
~XX405 2	7E 30 30 34 30 35 20 32 0D		Top and Bottom
~XX405 3	7E 30 30 34 30 35 20 33 0D		Frame sequential
~XX231 0	7E 30 30 32 33 31 20 30 0D	3D Sync Invert	On
~XX231 1	7E 30 30 32 33 31 20 31 0D	3D Sync Invert	Off
~XX70 1	7E 30 30 37 30 20 31 0D	Language	English
~XX70 2	7E 30 30 37 30 20 32 0D		German
~XX70 3	7E 30 30 37 30 20 33 0D		French
~XX70 4	7E 30 30 37 30 20 34 0D		Italian
~XX70 5	7E 30 30 37 30 20 35 0D		Spanish
~XX70 6	7E 30 30 37 30 20 36 0D		Portuguese
~XX70 7	7E 30 30 37 30 20 37 0D		Polish
~XX70 8	7E 30 30 37 30 20 38 0D		Dutch
~XX70 9	7E 30 30 37 30 20 39 0D		Swedish
~XX70 10	7E 30 30 37 30 20 31 30 0D		Norwegian/Danish
~XX70 11	7E 30 30 37 30 20 31 31 0D		Finnish
~XX70 12	7E 30 30 37 30 20 31 32 0D		Greek
~XX70 13	7E 30 30 37 30 20 31 33 0D		Traditional Chinese
~XX70 14	7E 30 30 37 30 20 31 34 0D		Simplified Chinese
~XX70 15	7E 30 30 37 30 20 31 35 0D		Japanese
~XX70 16	7E 30 30 37 30 20 31 36 0D		Korean
~XX70 17	7E 30 30 37 30 20 31 37 0D		Russian
~XX70 18	7E 30 30 37 30 20 31 38 0D		Hungarian
~XX70 19	7E 30 30 37 30 20 31 39 0D		Czechoslovak
~XX70 20	7E 30 30 37 30 20 32 30 0D		Arabic
~XX70 21	7E 30 30 37 30 20 32 31 0D		Thai
~XX70 22	7E 30 30 37 30 20 32 32 0D		Turkish
~XX70 23	7E 30 30 37 30 20 32 33 0D		Farsi
~XX70 25	7E 30 30 37 30 20 32 35 0D		Vietnamese
~XX70 26	7E 30 30 37 30 20 32 36 0D		Indonesian
~XX70 27	7E 30 30 37 30 20 32 37 0D		Romanian
~XX71 1	7E 30 30 37 31 20 31 0D	Projection	Front-Desktop
~XX71 2	7E 30 30 37 31 20 32 0D		Rear-Desktop
~XX71 3	7E 30 30 37 31 20 33 0D		Front-Ceiling
~XX71 4	7E 30 30 37 31 20 34 0D		Rear-Ceiling
~XX72 1	7E 30 30 37 32 20 31 0D	Menu Location	Top Left
~XX72 2	7E 30 30 37 32 20 32 0D		Top Right
~XX72 3	7E 30 30 37 32 20 33 0D		Centre
~XX72 4	7E 30 30 37 32 20 34 0D		Bottom Left
~XX72 5	7E 30 30 37 32 20 35 0D		Bottom Right
(WXGA)			
~XX90 1	7E 30 30 39 31 20 31 0D	Screen Type	16:10
~XX90 0	7E 30 30 39 31 20 30 0D		16:9
~XX77 n	7E 30 30 37 37 20 aabcc 0D	Security	Security Timer Month/Day/Hour n = mm/dd/hh mm= 00 (aa=30 30) ~ 12 (aa=31 32) dd = 00 (bb=30 30) ~ 30 (bb=33 30) hh= 00 (cc=30 30) ~ 24 (cc=32 34)
~XX78 1	7E 30 30 37 38 20 31 0D	Security Settings	Enable
~XX78 0 ~nnnn	7E 30 30 37 38 20 32 20 a 0D		Disable(O/D for backward compatible) ~nnnn = ~0000 (a=7E 30 30 30 30 30 30) ~99999 (a=7E 39 39 39 39 39)
~XX79 n	7E 30 30 37 39 20 a 0D	Projector ID	n = 00 (a=30 30) ~ 99 (a=39 39)
~XX80 1	7E 30 30 38 30 20 31 0D	Mute	On
~XX80 0	7E 30 30 38 30 20 30 0D		Off (O/D for backward compatible)
~XX310 0	7E 30 33 31 30 20 30 0D	Internal Speaker	Off
~XX310 1	7E 30 33 31 30 20 31 0D		On
~XX81 n	7E 30 30 38 31 20 a 0D	Volume(Audio)	n = 0 (a=30 30) ~ 10 (a=31 30)
~XX89 0	7E 30 30 38 39 20 30 0D	Audio Input	Default
~XX89 1	7E 30 30 38 39 20 31 0D		Audio1
~XX89 3	7E 30 30 38 39 20 33 0D		Audio2
~XX82 1	7E 30 30 38 32 20 31 0D	Logo	Default

# Appendices

~XX82 2	7E 30 30 38 32 20 32 0D	User	
~XX82 3	7E 30 30 38 32 20 33 0D	Neutral	
~XX83 1	7E 30 30 38 33 20 31 0D	Logo Capture	
~XX88 0	7E 30 30 38 38 20 30 0D	Closed Captioning	Off
~XX88 1	7E 30 30 38 38 20 31 0D		cc1
~XX88 2	7E 30 30 38 38 20 32 0D		cc2
~XX454 0	7E 30 30 34 35 34 20 30 0D	Crestron	Off
~XX454 1	7E 30 30 34 35 34 20 31 0D		On
~XX455 0	7E 30 30 34 35 35 20 30 0D	Extron	Off
~XX455 1	7E 30 30 34 35 35 20 31 0D		On
~XX456 0	7E 30 30 34 35 36 20 30 0D	PJLink	Off
~XX456 1	7E 30 30 34 35 36 20 31 0D		On
~XX457 0	7E 30 30 34 35 37 20 30 0D	AMX Device Discovery	Off
~XX457 1	7E 30 30 34 35 37 20 31 0D		On
~XX458 0	7E 30 30 34 35 38 20 30 0D	Telnet	Off
~XX458 1	7E 30 30 34 35 38 20 31 0D		On
~XX100 1	7E 30 30 31 30 30 20 31 0D	Source Lock	On
~XX100 0	7E 30 30 31 30 30 20 30 0D		Off (0/2 for backward compatible)
~XX101 1	7E 30 30 31 30 31 20 31 0D	High Altitude	On
~XX101 0	7E 30 30 31 30 31 20 30 0D		Off (0/2 for backward compatible)
~XX102 1	7E 30 30 31 30 32 20 31 0D	Information Hide	On
~XX102 0	7E 30 30 31 30 32 20 30 0D		Off (0/2 for backward compatible)
~XX103 1	7E 30 30 31 30 33 20 31 0D	Keypad Lock	On
~XX103 0	7E 30 30 31 30 33 20 30 0D		Off (0/2 for backward compatible)
~XX195 0	7E 30 30 31 39 35 20 30 0D	Test Pattern	None
~XX195 1	7E 30 30 31 39 35 20 31 0D		Grid
~XX195 2	7E 30 30 31 39 35 20 32 0D		White Pattern
~XX192 0	7E 30 30 31 39 32 20 30 0D	12V Trigger	Off
~XX192 1	7E 30 30 31 39 32 20 31 0D		On
~XX192 3	7E 30 30 31 39 32 20 33 0D		Auto 3D
~XX11 0	7E 30 30 31 31 20 30 0D	IR Function	Off
~XX11 1	7E 30 30 31 31 20 31 0D		On
~XX104 1	7E 30 30 31 30 34 20 31 0D	Background Color	Blue
~XX104 2	7E 30 30 31 30 34 20 32 0D		Black
~XX104 3	7E 30 30 31 30 34 20 33 0D		Red
~XX104 4	7E 30 30 31 30 34 20 34 0D		Green
~XX104 5	7E 30 30 31 30 34 20 35 0D		White
~XX105	7E 30 30 31 30 35 20 31 0D	Advanced	Direct Power On
~XX105 0	7E 30 30 31 30 35 20 30 0D		On
~XX113 0	7E 30 30 31 31 33 20 30 0D		Off (0/2 for backward compatible)
~XX113 1	7E 30 30 31 31 33 20 31 0D	Signal Power On	Off
~XX106 n	7E 30 30 31 30 36 20 a 0D		On
~XX107 n	7E 30 30 31 30 37 20 a 0D	Auto Power Off (min)	n = 0 (a=30) ~ 180 (a=31 38 30) (5 minutes for each step).
~XX115 1	7E 30 30 31 31 35 20 31 0D	Sleep Timer (min)	n = 0 (a=30) ~ 990 (a=39 39 30) (30 minutes for each step).
~XX115 0	7E 30 30 31 31 35 20 30 0D	Quick Resume	On
~XX114 1	7E 30 30 31 31 34 20 31 0D	Power Mode(Standby)	Off (0/2 for backward compatible)
~XX114 0	7E 30 30 31 31 34 20 30 0D		Eco.(≤0.5W)
			Active (0/2 for backward compatible)
~XX109 1	7E 30 30 31 30 39 20 31 0D	Lamp Reminder	On
~XX109 0	7E 30 30 31 30 39 20 30 0D		Off (0/2 for backward compatible)
~XX110 1	7E 30 30 31 31 30 20 31 0D	Brightness Mode	Bright
~XX110 2	7E 30 30 31 31 30 20 32 0D		Eco.
~XX191 0	7E 30 30 31 39 31 20 30 0D	DynamicBlack	Off
~XX191 1	7E 30 30 31 39 31 20 31 0D		On
~XX111 1	7E 30 30 31 31 31 20 31 0D	Lamp Reset	Yes
~XX111 0	7E 30 30 31 31 31 20 30 0D		No (0/2 for backward compatible)
~XX112 1	7E 30 30 31 31 32 20 31 0D	Reset	Yes
~XX210 n	7E 30 30 32 30 30 20 n 0D	Display message on the OSD	n: 1-30 characters

# Appendices

## SEND to emulate Remote

~XX140 10	7E 30 30 31 34 30 20 31 30 0D		Up
~XX140 11	7E 30 30 31 34 30 20 31 31 0D		Left
~XX140 12	7E 30 30 31 34 30 20 31 32 0D		Enter (for projection MENU)
~XX140 13	7E 30 30 31 34 30 20 31 33 0D		Right
~XX140 14	7E 30 30 31 34 30 20 31 34 0D		Down
~XX140 15	7E 30 30 31 34 30 20 31 35 0D		Keystone +
~XX140 16	7E 30 30 31 34 30 20 31 36 0D		Keystone -
~XX140 17	7E 30 30 31 34 30 20 31 37 0D		Volume -
~XX140 18	7E 30 30 31 34 30 20 31 38 0D		Volume +
~XX140 19	7E 30 30 31 34 30 20 31 39 0D		Brightness
~XX140 20	7E 30 30 31 34 30 20 32 30 0D		Menu
~XX140 21	7E 30 30 31 34 30 20 32 31 0D		Zoom
~XX140 28	7E 30 30 31 34 30 20 32 38 0D		Contrast
~XX140 47	7E 30 30 31 34 30 20 34 37 0D		Source

## SEND from projector automatically

232 ASCII Code	HEX Code	Function	Projector Return	Description
when Standby/Warming/Cooling/Out of Range/Lamp fail/Fan Lock/Over Temperature/Lamp Hours Running Out/Cover Open				
			INFO n	n : 0/1/2/3/4/6/7/8/ = Standby/Warming/Cooling/Out of Range /Lamp fail/Fan Lock/Over Temperature/ Lamp Hours Running Out/Cover Open

## READ from projector

232 ASCII Code	HEX Code	Function	Projector Return	Description
~XX121 1	7E 30 30 31 32 31 30 31 0D	Input Source Commands	OKn	n: 0/2/3/4/5/7/15 = None/VGA1/VGA2/Video/S-Video/HDMI/DisplayPort
~XX122 1	7E 30 30 31 32 32 30 31 0D	Software Version	OKdddd	dddd: FW version
~XX123 1	7E 30 30 31 32 33 30 31 0D	Display Mode	OKn	n : 0/1/2/3/4/5/6/7/8/ None/Presentation/Bright/Movie/sRGB/User/Blackboard/DICOM SIM/3D n : 0/1 = Off/On
~XX124 1	7E 30 30 31 32 34 30 31 0D	Power State	OKn	n : 1/2/3/5/6/7 = 4:3/16:9/16:10/LBx/Native/AUTO
~XX125 1	7E 30 30 31 32 35 30 31 0D	Brightness	OKn	"16:9 or 16:10 depend on Screen Type setting
~XX126 1	7E 30 30 31 32 36 30 31 0D	Contrast	OKn	n :3/0/1/2 = Warm/Standard/Cool/Cold
~XX127 1	7E 30 30 31 32 37 30 31 0D	Format	OKn	n : 0/1/2/3 = Front-Desktop/ Rear-esktop/ Front-Ceiling/ Rear-Ceiling
~XX128 1	7E 30 30 31 32 38 30 31 0D	Color Temperature	OKn	a : 0/1 = Off/On
~XX129 1	7E 30 30 31 32 39 30 31 0D	Projection Mode	OKn	bbbb: LampHour
~XX150 1	7E 30 30 31 35 30 30 31 0D	Information	OKabbbbccddd	cc: source 00/02/03/04/05/07/08/15 = None/VGA1/VGA2/Video/S-Video/HDMI /DisplayPort dddd: FW version e : Display mode 0/1/2/3/4/5/7/12/9 = None/Presentation/Bright/Movie/sRGB/ User/Blackboard/ DICOM SIM /3D n:3/4-WXGA/1080p
~XX151 1	7E 30 30 31 35 31 20 31 0D	Model name	OKn	bbbb: LampHour
~XX108 1	7E 30 30 31 30 38 20 31 0D	Lamp Hours	OKbbbb	bbbbbb: (5 digits) Total Lamp Hours
~XX108 2	7E 30 30 31 30 38 20 31 0D	Cumulative Lamp Hours	OKbbbbbb	n=0/1 Disconnected/Connected
~XX87 1	7E 30 30 38 37 20 31 0D	Network Status	OKn	a=0000-9999
~XX87 3	7E 30 30 38 37 20 33 0D	IP Address	Okaaa_bbb_ccc_ddd	a=000-999
~XX351 0	7E 30 30 33 35 31 20 30 0D	Fan1 speed(blower)	Oka	a=serial number string
~XX352 1	7E 30 30 33 35 32 20 31 0D	System temperature	Oka	a: 0/1/2 = off/cc1/cc2
~XX353 1	7E 30 30 33 35 33 20 31 0D	Serial number	Okaaaaaaaaaaaaaaaa	a : 0/1 = Off/On
~XX354 1	7E 30 30 33 35 34 20 31 0D	Closed Captioning	Oka	a : 0/1 = Off/On
~XX355 1	7E 30 30 33 35 35 20 31 0D	AV Mute	Oka	a : 0/1 = Off/On
~XX356 1	7E 30 30 33 35 36 20 31 0D	Mute	Oka	eeee: LAN FW version
~XX357 1	7E 30 30 33 35 37 20 31 0D	LAN FW version	Okeeeee	a : 0000-9999
~XX358 1	7E 30 30 33 35 38 20 31 0D	Current lamp watt	Okaaaa	

## Telnet Commands

- ▶ Port: support 3 ports of 23/1023/2023
- ▶ Multi-connections: Projector could receive commands from different ports at the same time
- ▶ Command Format: Follow RS232 command format (support both of ASCII and HEX)
- ▶ Command Response: Follow RS232 return message.

Lead Code	Projector ID		Command ID			Space	Variable	Carriage Return
~	x	x	x	x	x		n	CR
Fix code One Digit~	00		Defined by Optoma 2 or 3 Digit. See the Follow content			One Digit	Per item Definition	Fix code One Digit



- For wide screen resolution (WXGA), the compatibility support is dependent on Notebook/PC models.

## AMX Device Discovery commands

- ▶ DP : 239.255.250.250
- ▶ Port No. : 9131
- ▶ Each UDP broadcast information as below are updated around 40 seconds

Command	Description	Remark (Parameter)
Device-UUID	MAC address (Hex value without ':' separator)	12 digits
Device-SKDCClass	The Duet DeviceSdk class name	VideoProjector
Device-Make	Maker name	MakerPXLW
Device-Model	Model name	Projector



# Appendices

Command	Description	Remark (Parameter)
Config-URL	Device's IP address LAN IP address is shown up if LAN IP address is valid. Wireless LAN IP address is shown up if Wireless LAN IP address is valid.	http://xxx.xxx.xxx.xxx/index.html
Revision	The revision must follow a major.minor.micro scheme. The revision is only increased if the command protocol is modified.	1.0.0



- For wide screen resolution (WXGA), the compatibility support is dependent on Notebook/PC models.
- This AMX function is only to support AMX Device Discovery.
- The broadcast information only send out through valid interface.
- Both LAN and Wireless LAN interfaces could be supported at the same time.
- If “Beacon Validator” was used. Please take care below information.

## PJLink™ supported commands

The table below shows commands to control the projector using the PJLink™ protocol.

### Command Description Remark (Parameter)

Command	Description	Remark (Parameter)
POWR	Power control	0 = Standby
		1 = Power on
POWR?	Inquiry about the power state	0 = Standby
		1 = Power on
		2 = Cooling down
		3 = Warming up
INPT	INPT Input switching	11 = VGA1

## Note

This projector is fully compliant to the specifications of JBMIA PJLink™ Class 1. It supports all the commands defined by PJLink™ Class 1, and the compliance has been verified with the PJLink™ standard specifications Version 1.0.

Command	Description	Remark (Parameter)
INPT?	Inquiry about input switching	12 = VGA2
		13 = Component
		14 = BNC
		21 = VIDEO
		22 = S-VIDEO
		31 = HDMI 1
		32 = HDMI 2
AVMT	Mute control	30 = Video and audio mute disable
AVMT?	Inquiry about the mute state	31 = Video and audio mute enable
ERST?	Inquiry about the error state	1st byte: Fan error, 0 or 2
		2nd byte: Lamp error, 0 to 2
		3rd byte: Temperature error, 0 or 2
		4th byte: Cover open error, 0 or 2
		5th byte: Filter error, 0 or 2
		6th byte: Other error, 0 or 2
		0 to 2 mean as follows: 0 = No error detected, 1 = Warning, 2 = Error
LAMP?	Inquiry about the lamp state	1st value (1 to 5 digits): Cumulative LAMP operating time (This item shows a lamp operating time (hour) calculated based on that LAMP MODE is LOW.)
		2nd value: 0 = Lamp off, 1 = Lamp on
INST?	Inquiry about the available inputs	The following value is returned. "11 12 21 22 31 32"
NAME?	Inquiry about the projector name	The projector name set on the NETWORK menu or the ProjectorView Setup window is returned
INF1?	Inquiry about the manufacturer name	"Optoma" is returned.

# Appendices

Command	Description	Remark (Parameter)
INF2?	Inquiry about the model name	“EH7700” is returned.
INF0?	Inquiry about other information	No other information is available. No parameter is returned.
CLSS?	Inquiry about the class information	“1” is returned.

## Trademarks

- ▶ DLP is trademarks of Texas Instruments.
- ▶ IBM is a trademark or registered trademark of International Business Machines Corporation.
- ▶ Macintosh, Mac OS X, iMac, and PowerBook are trademarks of Apple Inc., registered in the U.S. and other countries.
- ▶ Microsoft, Windows, Windows Vista, Internet Explorer and PowerPoint are either a registered trademark or trademark of Microsoft Corporation in the United States and/or other countries.
- ▶ HDMI, the HDMI Logo and High-Definition Multimedia Interface are trademarks or registered trademarks of HDMI Licensing LLC.
- ▶ AMX Device Discovery  
The projector is monitored and controlled by the control system of AMX.
- ▶ Crestron RoomView Connected™  
The projector is monitored and controlled by the control system and software of Crestron Electronics, Inc.
- ▶ PJLink™  
PJLink trademark is a trademark applied for registration or is already registered in Japan, the United States of America and other countries and areas.  
This projector supports standard protocol PJLink™ for projector control and you can control and monitor projector's operations using the same application among projectors of different models and different manufacturers.

# Appendices

- ▶ Other product and company names mentioned in this user's manual may be the trademarks or registered trademarks of their respective holders.
- ▶ About Crestron RoomView Connected™  
Electronics, Inc. to facilitate configuration of the control system of Crestron and its target devices.

For details, see the website of Crestron Electronics, Inc.

URL <http://www.crestron.com>

URL <http://www.crestron.com/getroomview/>

## Ceiling Mount Installation

1. To prevent damage to your projector, please use the Optoma ceiling mount.
2. If you wish to use a third party ceiling mount kit, please ensure the screws used to attached a mount to the projector met the following specifications:
  - ▶ Screw type: M4
  - ▶ Maximum screw length: 11mm
  - ▶ Minimum screw length: 9mm

### Note

Please note that damage resulting from incorrect installation will invalidate the warranty.



### Warning:

1. If you buy ceiling mount from other company, please be sure to use the correct screw size. Screw size will be different on different mounts. It depends on the plate thickness.
2. Be sure to keep at least 10cm gap between the ceiling and the bottom of the projector.
3. Avoid installing the projector near a heat source.

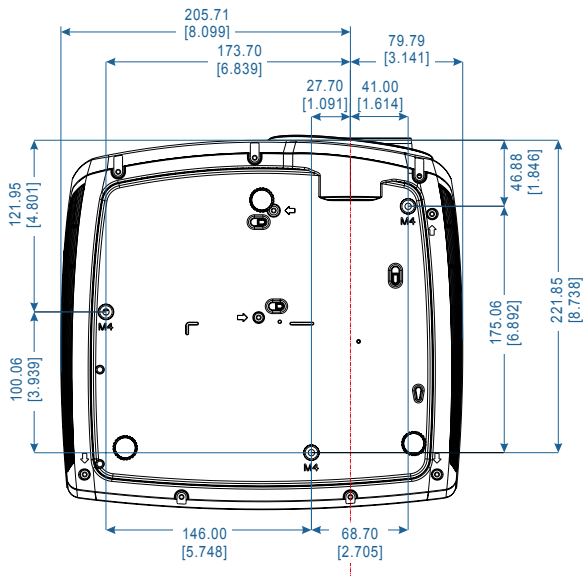
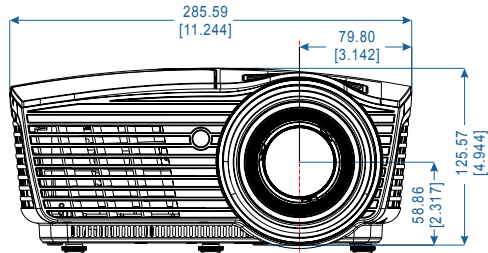

## Optoma Global Offices

For service or support please contact your local office.

### USA

3178 Laurelview Ct.,  
Fremont, CA 94538, USA  
[www.optomausa.com](http://www.optomausa.com)

Tel : 888-289-6786  
Fax : 510-897-8601  
Service : [services@optoma.com](mailto:services@optoma.com)

### Canada

3178 Laurelview Ct.,  
Fremont, CA 94538, USA  
[www.optoma.ca](http://www.optoma.ca)

Tel : 888-289-6786  
Fax : 510-897-8601  
Service : [services@optoma.com](mailto:services@optoma.com)

### Latin America

3178 Laurelview Ct.  
Fremont, CA 94538, USA  
[www.optoma.com.br](http://www.optoma.com.br)

Tel : 888-289-6786  
Fax: 510-897-8601  
[www.optoma.com.mx](http://www.optoma.com.mx)

### Europe

42 Caxton Way, The Watford Business Park  
Watford, Hertfordshire,  
WD18 8QZ, UK  
[www.optoma.eu](http://www.optoma.eu)  
Service Tel : +44 (0)1923 691865

Tel : +44 (0) 1923 691 800  
Fax : +44 (0) 1923 691 888  
Service : [service@tsc-europe.com](mailto:service@tsc-europe.com)

### Benelux BV

Randstad 22-123  
1316 BW Almere  
The Netherlands  
[www.optoma.nl](http://www.optoma.nl)

Tel : +31 (0) 36 820 0252  
Fax : +31 (0) 36 548 9052

### France

Bâtiment E  
81-83 avenue Edouard Vaillant  
92100 Boulogne Billancourt, France

Tel : +33 1 41 46 12 20  
Fax : +33 1 41 46 94 35  
Service : [savoptoma@optoma.fr](mailto:savoptoma@optoma.fr)

### Spain

C/ José Hierro,36 Of. 1C  
28522 Rivas VaciaMadrid,  
Spain

Tel : +34 91 499 06 06  
Fax : +34 91 670 08 32

# Appendices

---

## Deutschland

Wiesenstrasse 21 W  
D40549 Düsseldorf,  
Germany

Tel : +49 (0) 211 506 6670  
Fax : +49 (0) 211 506 66799  
Service : [info@optoma.de](mailto:info@optoma.de)

---

## Scandinavia

Lerpeveien 25  
3040 Drammen  
Norway

Tel : +47 32 98 89 90  
FAX : +47 32 98 89 99  
Service : [info@optoma.no](mailto:info@optoma.no)

---

PO.BOX 9515  
3038 Drammen  
Norway

---

## Taiwan

12F., No.213, Sec. 3, Beixin Rd.,  
Xindian Dist., New Taipei City 231,  
Taiwan, R.O.C.  
[www.optoma.com.tw](http://www.optoma.com.tw)

TEL:+886-2-8911-8600  
FAX: +886-2-8911-6550  
Service :[services@optoma.com.tw](mailto:services@optoma.com.tw)  
[asia.optoma.com](http://asia.optoma.com)

---

## Hong Kong

Unit A, 27/F Dragon Centre, 79 Wing Hong Street,  
Cheung Sha Wan Kowloon, Hong Kong  
Tel : +852-2396-8968  
[www.optoma.com.hk](http://www.optoma.com.hk)

Fax: +852-2370-1222

---

## China

5F, No. 1205, Kaixuan Rd.,  
Changning District  
Shanghai, 200052, China

TEL:+86-21-62947376  
FAX:+86-21-62947375  
[www.optoma.com.cn](http://www.optoma.com.cn)

---

## Japan

東京都足立区綾瀬 3-25-18  
株式会社オーエス

コンタクトセンター:0120-380-495  
Service :[info@os-worldwide.com](mailto:info@os-worldwide.com)  
<http://www.os-worldwide.com/>

---

## Korea

WOOMI TECH.CO.,LTD.  
4F, Minu Bldg.33-14, Kangnam-Ku,  
seoul,135-815, KOREA

Tel : +82+2+34430004  
Fax: +82+2+34430005

---

## Regulation & Safety Notices

*This appendix lists the general notices of your Projector.*

### ***FCC notice***

This device has been tested and found to comply with the limits for a Class B digital device pursuant to Part 15 of the FCC rules. These limits are designed to provide reasonable protection against harmful interference in a residential installation. This device generates, uses and can radiate radio frequency energy and, if not installed and used in accordance with the instructions, may cause harmful interference to radio communications.

However, there is no guarantee that interference will not occur in a particular installation. If this device does cause harmful interference to radio or television reception, which can be determined by turning the device off and on, the user is encouraged to try to correct the interference by one or more of the following measures:

- ■ Reorient or relocate the receiving antenna.
- ■ Increase the separation between the device and receiver.
- ■ Connect the device into an outlet on a circuit different from that to which the receiver is connected.
- ■ Consult the dealer or an experienced radio/television technician for help.

### ***Notice: Shielded cables***

All connections to other computing devices must be made using shielded cables to maintain compliance with FCC regulations.

### ***Caution***

Changes or modifications not expressly approved by the manufacturer could void the user's authority, which is granted by the Federal Communications Commission, to operate this projector.



# Appendices

## ***Operation conditions***

This device complies with Part 15 of the FCC Rules. Operation is subject to the following two conditions:

1. This device may not cause harmful interference and
2. This device must accept any interference received, including interference that may cause undesired operation.

## ***Notice: Canadian users***

This Class B digital apparatus complies with Canadian ICES-003.

## ***Remarque à l'intention des utilisateurs canadiens***

Cet appareil numérique de la classe B est conforme à la norme NMB-003 du Canada.

## ***Declaration of Conformity for EU countries***

- EMC Directive 2004/108/EC (including amendments)
- Low Voltage Directive 2006/95/EC
- R & TTE Directive 1999/5/EC  
(if product has RF function)
- RoHS Directive 2011/65
- Energy Related Products (ErP) Directive 2009/125/EC

## **Disposal instructions**



**Do not throw this electronic device into the trash when discarding. To minimize pollution and ensure utmost protection of the global environment, please recycle it.**