

SONY



BRC Series

PTZ Video Cameras

We've Got Your Scene Covered

From Broadcast studios and remote on-air suites to sport arenas, auditoriums, lecture halls and houses of worship, Sony's superb picture quality and reliable BRC PTZ cameras capture video footage for broadcasting and streaming in detail-packed 4K or Full HD resolution. Designed for unattended operation and easy integration for both indoor and outdoor systems, the BRC camera series is a perfect solution for a variety of remote shooting applications.

Broadcast TV

Our feature-packed remote PTZ cameras deliver impeccable images in 4K or Full HD resolution for broadcast and production applications including internet streaming. With excellent low light sensitivity and discreet, smooth/silent PTZ movements, these cameras are ideal for capturing the action for reality TV shows. Professional features include tally lamps, choice of interfaces, power over ethernet (PoE+) and genlock for easy integration into multi-camera broadcast environments.



Houses of worship

Capture every detail of services, weddings and other ceremonies in any size venue. Our discreet remote cameras are the natural choice for streaming crisp video footage in impressive 4K or Full HD from your house of worship to online audiences and members of the congregation. Remote operation with powerful optical zoom enables close-up details from a discreet distance. High sensitivity delivers exceptional image quality, even in low-light environments.



Auditoriums and Event Halls

From lecture theaters to conference centers, our PTZ cameras ensure presenters and audience members are always clearly visible. Stream lectures, presentations and live performances with broadcast-quality images in 4K or Full HD. Their smooth and silent mechanism enables these PTZ cameras to capture presenter and audience reactions with fluid, professional camera movement. Multiple interfaces, flexible control options and PoE+ makes them easy to integrate into any size venue.



Live sports

Our BRC remote cameras give you and your audience a prime view of live sports action. They're ideal for hard-to-reach locations where there's no space for a full-sized camera and dedicated cameraman - like right by the goal or goal post, by a dangerous bend in a race track or hanging from the roof of a stadium. Grab all the excitement in detail-packed 4K or Full HD, with remote PTZ operation and powerful Clear Image Zoom* to ensure you'll never miss a moment.

*Only BRC-X1000/1 and BRC-H800/1 feature Clear Image Zoom technology



Live shows and exhibitions

Hundreds of different and unique exhibitions at large venues all over the world, showcase everything from the latest automotive advances to high fashion trends to the latest industry technologies. During the shows presentations can be dramatically enhanced by streaming live content in in 4K or HD. With a Sony BRC remote camera, see details of fabrics and materials at fashion shows, or delicate stitching of interior car upholstery - not to mention the rapid and smooth PTZ action to capture each moment.



Product Line-up

	BRC-X1000/1	BRC-H900	BRC-H800/1
	 4K	 HD	 HD
Image sensor	1.0-type Exmor R CMOS Exmor R	1/2-type Exmor CMOS x3 Exmor	1.0-type Exmor R CMOS Exmor R
Signal System	2160/29.97p, 25p, 23.98p* 1080/59.94p, 50p, 59.94i, 50i, 720/59.94p, 50p	1080/59.94i, 50i 720/59.94p, 50p NTSC, PAL	1080/59.94p, 50p, 59.94i, 50i, 720/59.94p, 50p
4K Video Output	Dual link 3G-SDI x2, HDMI	—	—
HD Video Output	3G-SDI x4, HDMI	HD-SDI, Component (Y/Pb/Pr) or RGB	3G-SDI x2, HDMI
SD Video Output	—	SD-SDI, Composite, Y/C	—
Minimum Illumination	1.7 lux (50IRE, F2.8, 1/30s, Max Gain)	4 lux (50IRE, F1.9, Max Gain)	1.7 lux (50IRE, F2.8, 1/30s, Max Gain)
Optical Zoom	12x	14x	12x
Clear Image Zoom	24x(HD), 18x(4K)	—	24x
Horizontal Viewing Angle	64.6 degree (Wide)	59.6 degree (Wide)	64.6 degree (Wide)
Preset positions	16 currently; 100 (V2.0)*	16	16 currently; 100 (V2.0)*
Serial Control	RS-422	RS-422, RS-232C	RS-422
IP Control	Yes	Yes (Option)	Yes
ND filter	Yes*	No	Yes*
External sync	Yes	Yes	Yes
Power	DC10.8V to 13.2V, PoE+	DC10.8V to 13.2V	DC10.8V to 13.2V, PoE+

*Will be supported in Ver 2.0 (Summer 2017)

BRC-X1000/1

Remotely capture broadcast quality 4K/HD images with smooth, silent PTZ operation and excellent low-light sensitivity.

The BRC-X1000 /1 is Sony's first 4K remote camera, combining uncompromising broadcast picture quality and smooth, silent PTZ operation with the flexibility of Power over Ethernet (PoE+), 3G-SDI and HDMI connections. The BRC-X1000/a is a key migration model – it takes you from HD today to 4K tomorrow with its resolution options.



BRC-H800/1

Remotely capture broadcast quality Full HD images with smooth, silent PTZ operation and excellent low-light sensitivity.

The BRC-H800/1 remote camera combines uncompromising broadcast picture quality and smooth, silent PTZ operation with the flexibility of Power over Ethernet (PoE+), 3G-SDI and HDMI connections.



Key Features

Enhanced Pan/Tilt/Zoom (PTZ) operation

Accurately frame shots or track moving subjects with smooth and quiet remote control of P/T/Z functions. These cameras are equipped with enhanced PTZ functions such as low-speed zoom, slow pan/tilt mode and PTZ trace memory* which allows a sequence of camera movements to be memorized and recalled when required, removing the need for a cameraman and reducing costs. These features smoothly blend separate pan, tilt and zoom movements for seamless, professional-looking transitions.

* Will be supported in Ver 2.0 (Summer 2017)

Uncompromising 4K images (BRC-X1000 /1)

The camera's large, back-illuminated 1-inch type Exmor R CMOS sensor delivers uncompromised broadcast quality color images in detail-packed 4K 30p, with four times the resolution of Full HD. Footage can also be captured in Full HD 60p - ideal for fast-moving sports action.

Broadcast quality Full HD 60p images (BRC-H800/1)

The camera's large, back-illuminated 1-inch type Exmor R CMOS sensor delivers uncompromised broadcast quality color pictures in detail-packed Full HD 60p, capable of capturing sports and other fast-moving action.

High quality 12x optical zoom Technology and 18x (4K) or 24x (HD) with Clear Image Zoom

The high quality Zeiss Vario-Sonnar T lens with 12x optical zoom range covers wide angle shots as well as tight close-ups. Clear Image Zoom technology doubles the optical zoom while still delivering exceptional image quality. The optical excellence of this genuine 12x optical zoom lens with Clear Image Zoom extends the zoom capabilities to 18x in 4K* and 24x in HD allowing you to enlarge the image while maintaining its original image quality. The end result is an artistic triumph when shooting in 4K* or HD 24p (cinema-style resolution planned for summer 2017) with a beautiful bokeh for dramatic depth-of-field effects.

* BRC-X1000 only

Excellent low light sensitivity

The cameras can capture crisp, low noise color video images in light levels as low as 1.7lx, making it an ideal choice for low light environments.

Flexible installation

For installation simplicity and flexibility, these cameras supports PoE+ (Power-over-Ethernet) capability that carries IP control and power over a single connection cable. They are also ceiling, desktop or tripod mountable (Ceiling bracket included.)

Remote operation

Pan/tilt/zoom and other camera settings can be controlled using the supplied IR remote commander, or with the optional Sony RM-IP500/1 Remote Control Unit that can control multiple cameras.

Genlock

Genlock simplifies integration with other systems in multi-camera broadcast environments.

Versatile video outputs

Enjoy greater installation flexibility in professional broadcast and AV environments with 3G-SDI, HDMI, Ethernet and RS-422 video outputs.

Front and rear tally lamps

Ideal for on-air broadcast use, the cameras feature dual tally lamps on the front and rear of the camera body. Brightness of the front tally lamp can be adjusted in two steps.

Always up to date

New camera functionality and performance improvements can be added via firmware updates over IP by the end-user directly.

BRC-H900

Remotely capture broadcast quality Full HD images with smooth, silent PTZ operation

The BRC-H900 remote PTZ camera combines uncompromising broadcast picture quality with the flexibility of PTZ operation.

Key Features

Broadcast quality Full HD images

The BRC-H900 delivers uncompromised broadcast quality color images in Full HD, thanks to three 1/2-inch type Exmor CMOS sensors. Advanced picture adjust functions include matrix, color correction, white, detail, knee, gamma, master black, black gamma and flicker cancel.

High quality 14x optical zoom lens

The high quality lens with 14x optical zoom range covers wide angle shots as well as tight close-ups.

Smooth, Silent Pan/Tilt/Zoom (PTZ) Mechanism

Accurately frame shots or track moving subjects with smooth and quiet remote control of P/T/Z functions. Its slow pan/tilt mode allows for precise, jitter-free, low speed camera movements.

Flexible installation

The BRC-H900 is equally suitable for ceiling, desktop or tripod mounting, with an 'Image Flip' function that automatically ensures the correct output orientation in any installation environment. Ceiling bracket included.



Remote operation

Pan/tilt/zoom and other camera settings can be controlled using the supplied IR remote commander, or with the optional Sony RM-IP500/1 Remote Control Unit that can control multiple cameras.

Optional IP control

Large-scale systems of up to 100 BRC-H900 cameras can be controlled over standard IP networks by adding the optional BRBK-IP10 IP remote control board and RM-IP500/1 remote controller.

Wide range of expansion options

The camera can be configured with a choice of optional accessory cards, including the BRBK-HSD2 (HD/SD-SDI output), BRBK-SA1 (Analogue SD output), BRBK-SF1 (HD optical multiplex) and BRBK-IP10 (IP control).

Front and rear tally lamps

Ideal for on-air broadcast use, the BRC-H900 features dual tally lamps on the front and rear of the camera body.

RM-IP500/1

Easy, ergonomic PTZ control of multiple remote cameras for live events, production and content creation

This compact remote controller features a high-quality joystick that allows seamless pan, tilt and zoom adjustments of compatible Sony PTZ remote cameras. Zoom can also be controlled via the joystick or a supplementary seesaw lever; dedicated knobs and control buttons for simplified direct access to frequently-needed camera functions.

High-quality control of PTZF functions

Now you can achieve professional looking productions with joystick adjustments of pan and tilt movements, plus zoom control either via joystick or with the separate seesaw lever. Adjustable speed control of PTZ motions allow for speed control of PTZF allows smooth, accurate camera movements.

Control up to 100 BRC or SRG cameras via IP

The remote controller allows for the control of pan, tilt, zoom and other functions (up to 100 Sony BRC and SRG Series PTZ cameras) over an IP network.

Simple set-up

System set-up is quick and easy, with automatic IP address assignment of connected cameras and auto assignment of camera



numbers.

Store and recall camera presets

Up to 100 presets* (camera angles and settings) can be stored and recalled instantly via the numeric keypad, saving time in multiple camera set-ups.

* Depends on camera specification. Version upgrade may be required.

Tally indicator

Includes Normal Tally/On-Air Tally/Contact Modes.

Adjust camera paint functions

Color related settings - including black levels, white balance, flicker cancel, detail level, knee point, auto exposure level, iris, gain and shutter speed - can be adjusted directly through the controller without going through the camera menus.

System Configuration

Live Broadcast

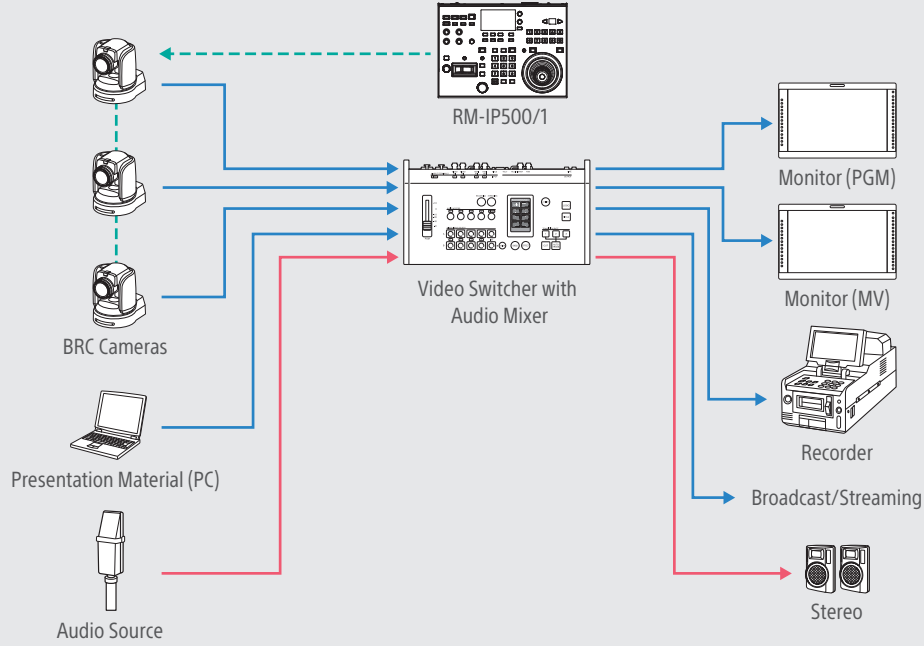

Presentation

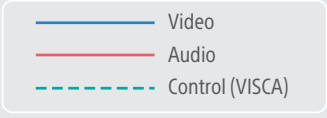
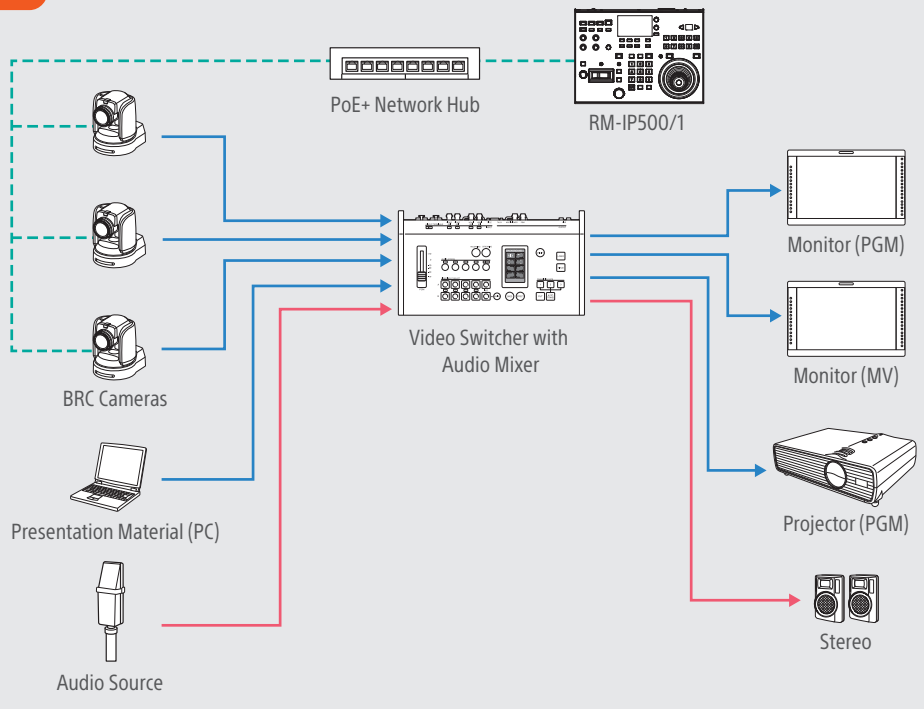

Peripheral Equipment



- MCX-500**
Multi-Camera Live Producer
- Smart controls with configurable LCD Touchscreen
 - Mix between 8 video sources + 1 Title (total 9 inputs)
 - Multi-view monitoring



- RM-IP10**
IP Remote Controller
- Comfortable P/T/Z operation with the optical three-axis joystick
 - Versatile camera adjustment by simple panel operation
 - The use of IP technology allows flexible installation and easy operation
 - Preset feature saves camera settings (up to 16 positions)

Optional Accessories



BRBK-IP10*
IP Control Card



BRBK-HSD2*
HD/SD-SDI Output Card



BRBK-SA1*
Analog SD Output Card



BRU-SF10*
HD Optical Multiplex Unit
(Supports Single-mode optical fiber)



CCFC-S200*
Optical Fiber Cable
2-core Single-mode Optical Fiber Cable (200 m long), Extension Plug Included

BRZ-12CDH
Environmental Dome Housing***

KT-STRUT
Uni Strut Wall/Ceiling Mount Kit

KT-WPM2
Wall/Pole Mount Kit

* For BRC-H900
*** For BRC-H900/X1000/H800

Dimensions

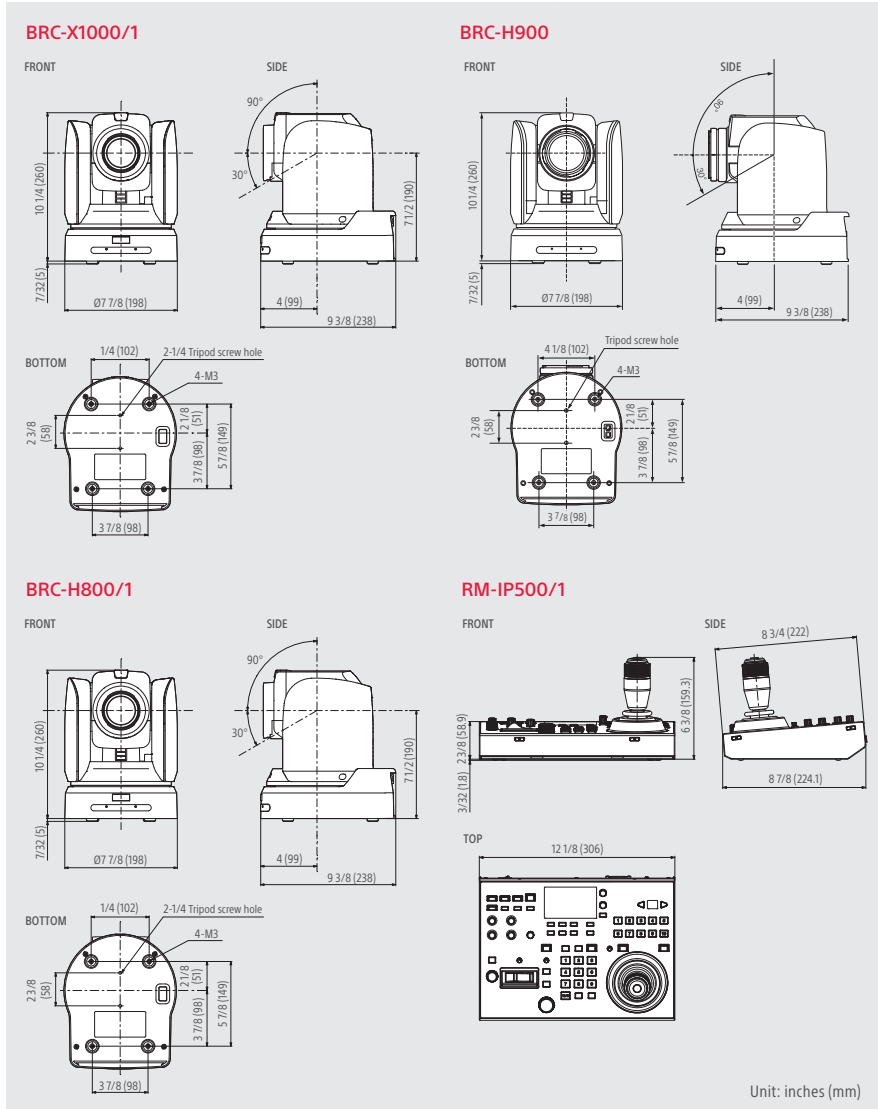

Rear Panels

BRC-X1000/1

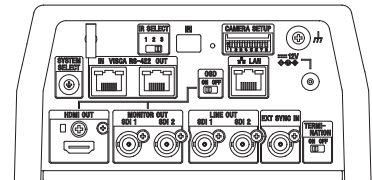

BRC-H900

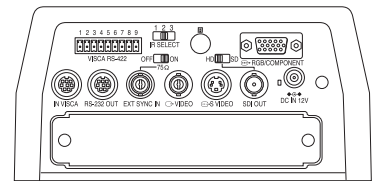

BRC-H800/1

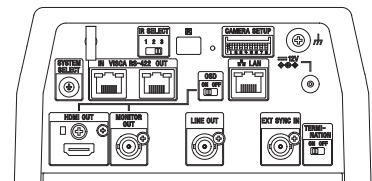

RM-IP500/1

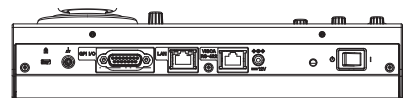

Specifications

	BRC-X1000 /1	BRC-H900	BRC-H800 /1
Camera			
Image Sensor	1.0-type back-illuminated Exmor R CMOS sensor	1/2-type Exmor CMOS x3	1.0-type back-illuminated Exmor R CMOS sensor
Image Sensor (Number of Effective Pixels)	Approx. 14.2 Megapixels	Approx. 2.07 Megapixels	Approx. 14.2 Megapixels
Signal System	2160/29.97p, 1080/59.94p, 1080/59.94i, 720/59.94p, 2160/25p, 1080/50p, 1080/50i, 720/50p	1080/59.94i, 720/59.94p, 1080/50i, 720/50p	1080/59.94p, 1080/59.94i, 720/59.94p, 1080/50p, 1080/50i, 720/50p
Minimum Illumination (50IRE)	1.7 lux (50IRE, F2.8, 1/30s, Max.Gain)	4 lx (50IRE, F1.9, +24 dB)	1.7 lux (50IRE, F2.8, 1/30s, Max.Gain)
Horizontal Resolution	1800 TV line (in 3G-SDI output) (center)	>1,000 TV line (in HD-SDI output) (center)	850 TV line (in 3G-SDI output) (center)
S/N Ratio	50 dB		
Gain	Auto/Manual (-3dB to +33dB)	Auto/Manual (-3 dB to +24 dB)	Auto/Manual (-3dB to +33dB)
Shutter Speed	1/10000s to 1/8 (59.94/29.97) or 1/10000s to 1/6 (50/25)	1/8,000 s to 1/60 s or 1/8,000 s to 1/50 s	1/10000s to 1/8 (59.94/29.97) or 1/10000s to 1/6 (50/25)
Exposure Control	Auto, Manual, Priority mode (shutter priority, iris priority, gain priority), Back light, Spot light	Auto, Manual, Priority mode (shutter priority & iris priority), Back light, Spot light	Auto, Manual, Priority mode (shutter priority, iris priority, gain priority), Back light, Spot light
White Balance	Auto1/Auto2/One Push/Indoor/Outdoor/Manual	Auto/Indoor/Outdoor/One-push/Manual	Auto1/Auto2/One Push/Indoor/Outdoor/Manual
Optical Zoom	12x	14x	12x
Clear Image Zoom	2x *1.5x at 4K resolution	No	2x
Focusing System	Auto/Manual		
Horizontal Viewing Angle	64.6° (Wide-end)	59.6° (Wide-end)	Typ. 64.6° (Wide-end)
Focal Length	f=9.3 mm to 111.6 mm F2.8 (Wide), F4.5 (Tele)	f=5.8 mm to 81.2 mm F1.9 (Wide), F2.8 (Tele)	f=9.3 mm to 111.6 mm F2.8 (Wide), F4.5 (Tele)
Minimum Object Distance	1000 mm (Tele), 80 mm (Wide)	800 mm (Tele), 300 mm (Wide)	1000 mm (Tele), 80 mm (Wide)
Pan/Tilt Angle	Pan: ±170° Tilt: +90°/-30°		
Pan/Tilt Speed	Pan: 0.3° to 60°/s Tilt: 0.3° to 60°/s	Pan: 0.22° to 60°/s Tilt: 0.22° to 60°/s	Pan: 0.3° to 60°/s Tilt: 0.3° to 60°/s
Pan/Tilt Slow Mode	Yes		
Preset Position	100*	16	100*
Day/Night	Yes	No	Yes
Visibility Enhancer	Yes	No	Yes
Image Flip	On/Off		
Gamma	Standard/Straight/Pattern	STD1/STD2/STD3/STD4/CINE1/CINE2/CINE3/CINE4	Standard/Straight/Pattern
Interface			
4K Video Output	Dual Link 3G-SDI(2SI only) x2 and HDMI	No	No
HD Video Output	3G-SDI x4 and HDMI	HD-SDI, Component(Y/Pb/Pr) or RGB	3G-SDI x2 and HDMI
SD Video Output	No	SD-SDI, Composite, Y/C	No
Camera Control Interface	VISCA RS-422, RJ45 (In/Out), VISCA over IP, RJ45	VISCA RS-232C, 8 pin mini-DIN VISCA RS-422, Phoenix connector VISCA over IP (option)	VISCA RS-422, RJ45 (In/Out), VISCA over IP RJ45
External Sync. Input	Yes		
General			
Power Requirements	DC 10.8 V to 13.2 V, PoE+ (IEEE802.3at compliant)	DC 10.8 V to 13.2 V	DC 10.8 V to 13.2 V, PoE+ (IEEE802.3at compliant)
Power Consumption	DC12 V:21.5 W (Max), PoE+:25.5 W (Max)	Max 28.8 W (without optional cards)	DC12 V:19.0 W (Max), PoE+:23.0 W (Max)
Operating Temperature	32 °F to 104 °F (0 °C to 40 °C)		
Storage Temperature	-4 °F to +140 °F (-20 °C to +60 °C)		
Dimensions (W x H x D)	Approx. 7 7/8 x 10 1/4 x 9 3/8 inch (Approx. 198 x 260 x 238 mm) (without projecting object)		
Weight	Approx. 9 lb 7.7oz (Approx. 4.3 kg)	Approx. 11 lb 0.37 oz (Approx. 5.0 kg)	Approx. 9 lb 7.7 oz (Approx. 4.3 kg)
Body Color	Black	Silver	Black
Size of Screw Hole for Tripod	1/4-20UNC x2		
Mountable Angle	<±15 degree		
Ceiling Mount	Yes		
Supplied Accessories	IR Remote Commander Unit (1), Ceiling bracket (2), Wire rope (1), Screws(M3 x 8) (7), Screws(M4 x 8) (1), HDMI cable fixing plate (1)	IR Remote Commander Unit (1), AC power adaptor (1), AC power cord (1), RS-422 connector plug (1), Ceiling bracket (2), Wire rope (1), Screws (M3 x 8) (7), Screws (M4 x 8) (1), Operating instructions (1)	IR Remote Commander Unit (1), Ceiling bracket (2), Wire rope (1), Screws(M3 x 8) (7), Screws(M4 x 8) (1), HDMI cable fixing plate (1)

*Available in Summer 2017 with version up

	RM-IP500 /1
Input/output connectors	
Control signal format	VISCA RS-422: RJ-45 x 1 GPI I/O (Tally In/Contact Out) : D-Sub 15-pin (female) LAN : RJ-45 x 1, 10BASE-T/100BASE-TX automatically detected
Power connector	9,600 bps/38,400 bps , Data : 8 bit, Stop bit : 1 (for RS-422 communication) VISCA over IP communication
Power connector	JEITA type 4 (DC IN 12 V)
General	
Input voltage	12V DC (10.8 to 13.2V DC)
Current consumption	0.2A typ. (2.4 W)
Operating temperature	32°F to 104°F (0°C to 40°C)
Storage temperature	-4°F to 140°F (-20°C to 60°C)
Dimensions (W x H x D)	12 1/8 x 6 3/8 inches x 8 7/8 inches (306 mm x 159.3 mm x 224.1 mm) (without projection)
Weight	Approx. 5 lb 4.7 oz (Approx. 2.4 kg)
Supplied Accessories	None. (Power Supply : Separate Option, Manual : Downloadable from Web site)

	BRBK-IP10	BRBK-HSD2	BRBK-SA1
Video output	BNC x2: HD-SDI or SD-SDI*	BNC x3, HD-SDI or SD-SDI	BNC x1: VIDEO, Mini DIN 4pin x1: S VIDEO, D-sub 9pin x1: RGB/SYNC

* DATA MIX ON/OFF selectable in HD-SDI

	BRU-SF10
Interfaces	
Optical fiber connector	LC Duplex Fiber Connector
Optical cable type	Single-mode
HD video output	D-Sub 15 pin: Component (Y/Pb/Pr) or RGB, HD, VD or SYNC
SD video output	-
External sync input	BNC
External sync output	BNC
Audio line output	Phono jack x2 (L/R)
Camera control	Mini DIN 8 pin: RS-232C (VISCA IN), Mini DIN 8 pin: RS-232C (VISCA OUT), Connector plug 9 pin: RS-422 (VISCA IN/OUT)
Optional card slots	2 slots
General	
Operating temperature	32 °F to 104 °F (0 °C to 40 °C)
Storage temperature	-4 °F to +140 °F (-20 °C to +60 °C)
Power requirements	DC 12 V
Power consumption	Max. 15.6 W (without optional cards)
Dimensions (W x H x D)	8 3/8 x 3 1/2 x 9 1/2 inches (210 x 86 x 240 mm)
Weight	4 lb 7 oz (2.0 kg)
Supplied accessories	AC adapter, Power cord, DC-cord secure connection attachment, RS-232C connecting cable, RS-422 connector plug, Operating Instructions

	BRZ-12CDH
General	
Dimensions	17 3/8x 21 x 27.5 in (441.3 x 533.4 x 689.5 mm)
Weight	52 lbs. (23.58kg)
Optical Dome	Clear Cell Cast Acrylic
Input Power	90 - 305VAC, 47 - 63Hz, 2.5A/115VAC 1.3A/230VAC 1.1A/277VAC
Construction	Aluminum Alloy outer shell, Acrylic / PMMA bubble

Find more

www.sony.com/ptz



©2017 Sony Corporation. All rights reserved.
 Reproduction in whole or in part without written permission is prohibited.
 Features and specifications are subject to change without notice.
 The values for weight and dimension are approximate.
 Some images in this brochure are simulated.
 "SONY" is registered trademark of Sony Corporation.
 All other trademarks are the property of their respective owners.

Sony Electronics Inc.
 1 Sony Drive
 Park Ridge, NJ 07656
sony.com/ptz

IS-1270 (MK20175V1)

Printed in USA (4/17)