

FUJITSU Server PRIMERGY RX2530 M4

Operating Manual

Comments... Suggestions... Corrections...

The User Documentation Department would like to know your opinion of this manual. Your feedback helps us optimize our documentation to suit your individual needs.

Feel free to send us your comments by e-mail to manuals@ts.fujitsu.com.

Certified documentation according to DIN EN ISO 9001:2008

To ensure a consistently high quality standard and user-friendliness, this documentation was created to meet the regulations of a quality management system which complies with the requirements of the standard DIN EN ISO 9001:2008.

cognitas. Gesellschaft für Technik-Dokumentation mbH
www.cognitas.de

Copyright and Trademarks

Copyright 2017 FUJITSU LIMITED

All rights reserved.

Delivery subject to availability; right of technical modifications reserved.

All hardware and software names used are trademarks of their respective manufacturers.

- The contents of this manual may be revised without prior notice.
- Fujitsu assumes no liability for damages to third party copyrights or other rights arising from the use of any information in this manual.
- No part of this manual may be reproduced in any form without the prior written permission of Fujitsu.

Microsoft, Windows, Windows Server, and Hyper V are trademarks or registered trademarks of Microsoft Corporation in the USA and other countries.

Intel and Xeon are trademarks or registered trademarks of Intel Corporation or its subsidiaries in the USA and other countries.

Before reading this manual

For your safety

This manual contains important information for safely and correctly using this product.

Carefully read the manual before using this product. Pay particular attention to the accompanying manual "Safety Notes and Regulations" and ensure these safety notes are understood before using the product. Keep this manual and the manual "Safety Notes and Regulations" in a safe place for easy reference while using this product.

Radio interference

This product is a "Class A" ITE (Information Technology Equipment). In a domestic environment this product may cause radio interference, in which case the user may be required to take appropriate measures. VCCI-A

Aluminum electrolytic capacitors

The aluminum electrolytic capacitors used in the product's printed circuit board assemblies and in the mouse and keyboard are limited-life components. Use of these components beyond their operating life may result in electrolyte leakage or depletion, potentially causing emission of foul odor or smoke.

As a guideline, in a normal office environment (25°C) operating life is not expected to be reached within the maintenance support period (5 years). However, operating life may be reached more quickly if, for example, the product is used in a hot environment. The customer shall bear the cost of replacing replaceable components which have exceeded their operating life. Note that these are only guidelines, and do not constitute a guarantee of trouble-free operation during the maintenance support period.

High safety use

This product has been designed and manufactured to be used in commercial and/or industrial areas as a server.

When used as visual display workplace, it must not be placed in the direct field of view to avoid incommoding reflections (applies only to TX server systems).

The device has not been designed or manufactured for uses which demand an extremely high level of safety and carry a direct and serious risk of life or body if such safety cannot be assured.

These uses include control of nuclear reactions in nuclear power plants, automatic airplane flight control, air traffic control, traffic control in mass transport systems, medical devices for life support, and missile guidance control in weapons systems (hereafter, "high safety use"). Customers should not use this product for high safety use unless measures are in place for ensuring the level of safety demanded of such use. Please consult the sales staff of Fujitsu if intending to use this product for high safety use.

Measures against momentary voltage drop

This product may be affected by a momentary voltage drop in the power supply caused by lightning. To prevent a momentary voltage drop, use of an AC uninterruptible power supply is recommended.

(This notice follows the guidelines of Voltage Dip Immunity of Personal Computer issued by JEITA, the Japan Electronics and Information Technology Industries Association.)

Technology controlled by the Foreign Exchange and Foreign Trade Control Law of Japan

Documents produced by Fujitsu may contain technology controlled by the Foreign Exchange and Foreign Trade Control Law of Japan. Documents which contain such technology should not be exported from Japan or transferred to non-residents of Japan without first obtaining authorization in accordance with the above law.

Harmonic Current Standards

This product conforms to harmonic current standard JIS C 61000-3-2.

Only for Japan: About SATA HDDs

The SATA version of this server supports HDDs with SATA / BC-SATA storage interfaces. Please note that the usage and operation conditions differ depending on the type of HDD used.

Please refer to the following internet address for further information on the usage and operation conditions of each available type of HDD:

<http://jp.fujitsu.com/platform/server/primergy/harddisk/>

Contents

1	Introduction	9
1.1	Concept and target groups for this manual	9
1.2	Documentation overview	10
1.3	Notational conventions	11
2	Functional overview	13
2.1	Features	13
2.2	Server specification	22
3	Installation steps, overview	31
4	Important information	33
4.1	Safety instructions	33
4.2	CE conformity	42
4.3	FCC Class A Compliance Statement	42
4.4	Environmental protection	43
5	Hardware installation	45
5.1	Unpacking the server	46
5.2	Installing/removing the server in/from the rack	47
5.3	Connecting devices to the server	49
5.4	Connecting the server to the mains	52
5.4.1	Connecting the server to the direct current (optional DC PSU)	53
5.4.2	Using the cable clamps (AC PSU)	54
5.5	Notes on connecting/disconnecting cables	55

6	Starting up and operation	57
6.1	Controls and indicators	57
6.1.1	Server front	57
6.1.1.1	Controls on the front panel	57
6.1.1.2	Indicators on the front panel	59
6.1.1.3	Indicators on the accessible drives/components	62
6.1.2	Server rear	64
6.1.2.1	Indicators on the I/O panel	64
6.1.2.2	Indicator on PSU (slide-in unit)	67
6.1.2.3	Indicator on Fujitsu battery unit (FJBU)	68
6.1.3	Indicators of the hot-plug system fans	68
6.2	ID card	69
6.3	Switching the server on and off	70
6.4	Configuring the server	73
6.4.1	Configuring the onboard SATA controller	73
6.4.2	Configuring the SAS/SATA RAID controller	74
6.4.3	Configuring the server and installing the operating system with the ServerView Installation Manager	75
6.4.4	Configuring the server and installing the operating system without the ServerView Installation Manager	76
6.5	Cleaning the server	77
7	Property and data protection	79
7.1	BIOS Setup security functions	79
8	Troubleshooting and tips	81
8.1	Power-on indicator remains unlit	81
8.2	Server switches itself off	82
8.3	Screen remains blank	82
8.4	Flickering stripes on monitor screen	83
8.5	No screen display or display drifts	83
8.6	Incorrect date and time	84
8.7	System will not boot	84

8.8	Drives reported as “dead” when starting system	84
8.9	Added drive reported as defective	85
8.10	Error message on screen	85
8.11	Expansion cards or onboard devices not recognized	85
8.12	Temperature warning	86
8.13	No effect of keyboard or mouse	86
8.14	Optical drive cannot read data	86

Contents

1 Introduction

The FUJITSU Server PRIMERGY RX2530 M4 is a rack server that provides high performance, expandability and energy efficiency in 1U space saving housing. The PRIMERGY RX2530 M4 is ideal for virtualization, scale-out scenarios, and small databases as well as for high performance computing thanks to the high performance of the new Intel® Xeon® P-family CPUs with up to 28 cores, optionally with embedded FPGA-functionality and the latest DDR4 memory technology. Moreover, the RX2530 M4 delivers a great expandability, by supporting up to 3,072 GB of main memory and is future-proof with M.2 device support and the latest iRMC S5 for server management of the next generation. NV-DIMMs will be supported from mid-2018 on. Up to 10 hard disk drives (HDDs) and optionally up to four high-speed PCIe Solid State Drives (SSDs) offer a flexible storage configuration option. OCP 2.0 technology is onboard to ensure future requirements are met and budgets are saved. The limited space of a 1U chassis offers highly efficient power supply units, their redundancy on demand and the optional Advanced Thermal Design, will result in lower operational costs.

1.1 Concept and target groups for this manual

This operating manual describes how to install, set up and operate your server.

This operating manual is intended for those responsible for installing the hardware and ensuring that the system runs smoothly. It contains all the information you need to put your PRIMERGY RX2530 M4 into operation.

To understand the various expansion options, you will need to be familiar with the fields of hardware and data transmission and you will require a basic knowledge of the underlying operating system.

1.2 Documentation overview

More information on your PRIMERGY RX2530 M4 can be found in the following documents:

- "Quick Start Hardware - FUJITSU Server PRIMERGY RX2530 M4"
- "ServerView Quick Start Guide"
- "Safety Notes and Regulations" manual
"安全上のご注意" for Japan
- "Warranty" manual
"保証書" for Japan
- "ServerView Suite Local Service Concept - LSC" manual
- "Returning used devices" manual and "Service Desk" leaflet
"サポート&サービス" for Japan
- "FUJITSU Server PRIMERGY RX2530 M4 Upgrade and Maintenance Manual"
- "D3383 BIOS Setup Utility for FUJITSU Server PRIMERGY RX2530 M4 Reference Manual"
- "iRMC S5 - Concepts and Interfaces" user guide
- "iRMC S5 - Configuration and Maintenance" user guide
- "iRMC S5 - Web Interface" user guide
- "ServerView embedded Lifecycle Management (eLCM)" User Guide
- "Integrated RAID for SAS User Guide"
- "LSI MegaRAID - SAS Software User Guide"
- "Modular RAID Controller / Modular SAS HBA Installation Guide"



All documentation on PRIMERGY hardware and ServerView software is available online from the Fujitsu manuals server at:

<http://manuals.ts.fujitsu.com>

For Japan:

<http://www.fujitsu.com/jp/products/computing/servers/primergy/manual/>

The complete PRIMERGY documentation set can also be downloaded as a DVD ISO image at:

<ftp://ftp.ts.fujitsu.com/images/serverview/manuals>

For Japan:



<http://www.fujitsu.com/jp/products/computing/servers/primergy/downloads/>

Further sources of information:

- ServerView Suite Glossary
- Manual for the monitor
- Documentation for the boards and drives
- Operating system documentation
- Information files in your operating system

1.3 Notational conventions

The following notational conventions are used in this manual:

<i>Text in italics</i>	indicates commands or menu items.
"Quotation marks"	indicate names of chapters and terms that are being emphasized.
▶	describes activities that must be performed in the order shown.
 CAUTION!	pay particular attention to texts marked with this symbol. Failure to observe this warning may endanger your life, destroy the system or lead to the loss of data.
	indicates additional information, notes and tips.

2 Functional overview

This section provides information on the features and technical data of the PRIMERGY RX2530 M4 server.

2.1 Features

Intel® Xeon® P-family CPUs

The server can be equipped with up to two Intel® Xeon® P-family CPUs for high-speed data processing.

Customer Self Service (CSS)

The PRIMERGY Customer Self Service (CSS) concept enables you to identify and replace the affected component yourself in the case of certain error scenarios.

In the CSS concept, you can replace the following components yourself in the event of an error:

- Hot-plug HDD/SSD modules
- Hot-plug PSUs
- Memory modules (not allowed for Japan)
- System fans
- Expansion cards (not allowed for Japan)

For information on replacing these components, see the "FUJITSU Server PRIMERGY RX2530 M4 Upgrade and Maintenance Manual".

CSS indicators on the control panel and on the rear of the PRIMERGY server provide you with information if a CSS event arises.

In addition, CSS errors are displayed in the ServerView Operations Manager, the server management software from Fujitsu.

In the event of errors, the ServerView Operations Manager refers you directly to the affected component and its order information in the Illustrated Spares catalog of the server in question. (This feature is not available for Japan.)



Further information on the CSS concept is provided in the "PRIMERGY ServerView Suite Local Service Concept - LSC" manual on the Fujitsu manuals server.

For the latest information on optional products provided for the RX2530 M4 see the configurator of the server:

http://ts.fujitsu.com/products/standard_servers/index.html

For Japan:

<http://www.fujitsu.com/jp/products/computing/servers/primergy/>

System board

The features of the system board are described in the "FUJITSU Server PRIMERGY RX2530 M4 Upgrade and Maintenance Manual", the setup possibilities are described in the "D3383 BIOS Setup Utility for FUJITSU Server PRIMERGY RX2530 M4 Reference Manual".

Trusted Platform Module (TPM)

A Trusted Platform Module (TPM) for safer storage of keys can be implemented as an option. This module enables programs from third party manufacturers to store key information (e.g. drive encryption using Windows Bitlocker Drive Encryption).

The TPM is activated via the BIOS system (for more information, refer to the "D3383 BIOS Setup Utility for FUJITSU Server PRIMERGY RX2530 M4 Reference Manual").



CAUTION!

- When using the TPM, note the program descriptions provided by the third party manufacturers.
- You must also create a backup of the TPM content. To do this, follow the third party manufacturer's instructions. Without this backup, if the TPM or the system board is faulty you will not be able to access your data.
- If a failure occurs, please inform your service about the TPM activation before it takes any action, and be prepared to provide them with your backup copies of the TPM content.

Slots for expansion cards

The server can be flexibly expanded via four slots (1x PCIe Gen3 x8 and 3x PCIe Gen3 x16). A second CPU is required for slot 4.

The FBU for the 3.5" base-unit variant occupies one additional PCIe slot. Depending on the installed RAID controller, for the 3.5" base-unit variant slot 2 or slot 4 is for FBU option.

One horizontal chassis slot is occupied by the OCP module.

HDDs/SSDs

Depending on the chassis the server can be equipped with 4x 3.5-inch HDD modules (with 1x ODD), 4x 2.5-inch HDD/SSD modules (with 1x ODD), 8x 2.5-inch HDD/SSD modules (with 1x ODD) or 10x 2.5-inch HDD/SSD modules (without ODD).

Each HDD/SSD module can accommodate a SAS/SATA HDD or a SATA SSD with a maximum height of 1 inch. The HDD/SSD module is connected to the SAS/SATA backplane wirelessly. This allows HDD/SSD modules to be plugged in or pulled out easily.

To control SAS HDDs, an additional RAID controller must be installed. To control PCIe SSD modules an additional PCIe controller must be installed.

Mixed configurations of SAS HDDs, SATA HDDs and SSDs within the same logical drive (RAID array) are not supported.

If the server has the corresponding RAID configuration, HDD/SSD modules can also be replaced during operation.

Onboard SATA controller

A SATA controller is integrated on the system board; up to eight SATA HDDs can be connected to the controller.

For more information on configuring the controller, see section ["Configuring the onboard SATA controller" on page 73](#).

SAS/SATA RAID controller

The server is available with the following SAS/SATA RAID controllers for operating the internal SAS/SATA HDDs:

- Modular Host Bus Adapter with "Integrated RAID" (IR). RAID levels 0 and 1 are supported for internal HDD configurations.
- Modular RAID 0/1 controller with "MegaRAID functionality" (integrated MegaRAID). RAID levels 0, 1, 10, 5 and 50 are supported for internal HDD configurations.
- Modular RAID 5/6 controller with "MegaRAID functionality" (MegaRAID). RAID levels 0, 1, 10, 5, 50, 6 and 60 are supported for internal HDD configurations. As an option, a flash backup unit (FBU) can save the memory content even if the power fails. Cache memory size of 1 GB or 2 GB is available.



For more information on configuring the controller, see section ["Configuring the SAS/SATA RAID controller" on page 74](#).

Further information on SAS/SATA RAID controllers is provided in the "Modular RAID Controller Installation Guide" (on the Fujitsu manuals server under *x86 Servers - Expansion Cards - Storage Adapters - LSI SAS / SCSI RAID Controllers*).

Further information on other SAS/SATA RAID controllers (e.g. for operating external SAS/SATA HDDs or tape drives) is available on the Fujitsu manuals server under *x86 Servers - Expansion Cards - Storage Adapters - LSI SAS / SCSI RAID Controllers*.

Optical disk drive (ODD)

An installation slot for an ultra slim ODD (optional) is available.



For the variant with 10x 2.5-inch HDDs there is no slot available for an ultra slim ODD.

USB connectors

4x 3.5-inch HDDs and 8x 2.5-inch HDDs chassis: There are two USB 3.0 connectors on the front and two USB 3.0 connectors at the rear.

10x 2.5-inch HDDs chassis: On the front there is one USB 2.0 connector. At the rear there are two USB 3.0 connectors.

The maximum length of the external cable are three meters.

Power supply unit (PSU)

The server can be equipped with:

- with up to two AC PSUs
In its basic configuration the server has one PSU that adjusts automatically to any mains voltage in the range of 100 - 240 V (PSU Platinum, 450 W) or 200 - 240 V (PSU Titanium, 800 W). Besides the PSU, a second PSU can be installed optionally to serve as a redundant power supply. If one PSU fails, the second PSU in the redundant configuration ensures operation can continue uninterrupted and the defective PSU can be replaced during operation (hot-plug).
- with up to two DC PSUs
In its basic configuration the server has one PSU that adjusts automatically to any mains voltage in the range of -40.5 V to -57 V. Besides the PSU, a second PSU can be installed optionally to serve as a redundant power supply. If one PSU fails, the second PSU in the redundant configuration ensures operation can continue uninterrupted and the defective PSU can be replaced during operation (hot-plug).
- with one AC PSU or DC PSU and one FJBU

Fujitsu battery unit (FJBU)

FJBU behaves as a modular UPS in the server. When power fail happened, the server can operate by FJBU for a while. FJBU supports hot-plugging, and can be replaced during operation.

You can download the management software (FJBU management software) for the following OS:

- Windows Server 2016
- Windows Server 2012 R2, Windows Server 2012
- Windows Server 2008 R2 SP1, Windows Server 2008 SP2



FJBU management software is not available in VMWare ESXi and Red Hat Enterprise Linux environment. Please use the IPMI function at Linux environment.

Advanced Thermal Design

The Advanced Thermal Design option allows you to operate the system with a wider temperature range either of 5 °C to 40 °C or 5 °C to 45 °C, depending on your system and configuration.



This option can only be ordered from the manufacturer and is indicated by the respective logo on the identification rating plate.



CAUTION

In a system that is configured with Advanced Thermal Design, only certain components which support the respectively increased higher operating temperature range may be installed and used. For applicable restrictions, please refer to the official configurator tool.

High level of availability and data security

When memory data is accessed, 1-bit errors are identified in the main memory and automatically corrected with the error correcting code (ECC) method.

ASR&R (Automatic Server Reconfiguration and Restart) restarts the system in the event of an error and automatically "hides" the defective system components.

The PDA (Prefailure Detection and Analysis) technology from Fujitsu analyzes and monitors all components that are critical for system reliability.

A RAID controller supports different RAID levels and increase the availability and data security of the system.

The hot-plug HDD modules provide additional availability.

iRMC S5 with integrated management LAN connector

The iRMC S5 (integrated **R**emote **M**anagement **C**ontroller) is a Baseboard Management Controller (BMC) with integrated management LAN connector and expanded functionality that was previously only available with additional plug-in cards. In this way, the iRMC S5 enables complete control of PRIMERGY servers, regardless of system status, and thus particularly the control of PRIMERGY servers that are in the "out-of-band" system status.

Major functions supported by the iRMC S5 include the following:

- Browser access via iRMC S5's own Web server
- Secure communication (SSH, SSL)
- Power Management for the managed server (depending on its system status)
- Power Consumption Management
- Connecting virtual drives as remote storage
- Text-based and graphic console bypass (Advanced Video Redirection)
- Remote Storage
- Command Line Interface (CLI)
- Simple, interactive or script-based iRMC S5 configuration
- Customer Self Service (CSS)
- iRMC S5's own user management
- Multi-computer, global iRMC S5 user administration using an LDAP Directory Service
- Automatic network configuration via DNS / DHCP
- Power supply of the iRMC S5 via the system standby supply
- Full-coverage alarm management
- System Event Log (SEL) reading and processing
- IPMI support
- CIM / WS-MAN support
- Internal Event Log for user login / logout auditing

Functional overview

More information about the iRMC S5 can be found in the iRMC S5 user guides (on the Fujitsu manuals server under *x86 Servers - Software - ServerView Suite - Out-Of-Band Management*).

Server management

Server management is implemented using the ServerView Operations Manager supplied and the PDA (Prefailure Detection and Analysis) technology from Fujitsu. PDA reports the threat of a system error or overload at an early stage, allowing preventive measures to be taken.

The ServerView Operations Manager enables the management of all PRIMERGY servers in the network via a central console. The ServerView Operations Manager supports the following functions:

- Round-the-clock monitoring, regardless of server status
- High-performance, graphical console bypass (AVR) protected by HTTPS/SSL (128 bit)
- Remote storage via USB
- Remote power on
- Intrusion detection in the floorstand model
- Temperature monitoring of the CPU and the surrounding area
- Detailed status and error reports for CPUs and main memory
- Watchdog timer for Automatic Server Reconfiguration and Restart (ASR&R) in the event that memory modules or CPUs fail
- Power monitoring
- End-of-life monitoring of fans with prompt notification before failure
- Watchdog timer for monitoring the operating system with ASR&R

Further information on the ServerView Operations Manager is provided in the associated documentation.

ServerView Installation Manager

You can configure the PRIMERGY server quickly and precisely with the ServerView Installation Manager software provided. User-guided menus are available for installing the server operating system (for further details see section ["Configuring the server" on page 73](#)).

Service and support

PRIMERGY servers are easy to maintain and modular, thus enabling quick and simple maintenance.

The handles and locks (touch points) used to exchange components are colored green to ensure simple and immediate recognition.

In order to prevent the components from being damaged by incorrect handling when they are being installed and removed, the areas of all components that can be touched without damaging them are also marked green.

PRIMERGY diagnostic LEDs fitted on the system board indicate which component (memory module, CPU, fan or expansion card) is not functioning properly.

The Flash EPROM program supplied with the Fujitsu utilities supports a fast BIOS update.

With the iRMC (integrated Remote Management Controller) on the system board, the PRIMERGY RX2530 M4 server can also be maintained and serviced remotely. This enables remote diagnosis for system analysis, remote configuration and remote restart should the operating system or hardware fail.

ServerView Remote Management

ServerView Remote Management is the remote management solution from Fujitsu for PRIMERGY servers. ServerView Remote Management and the relevant hardware components integrated on the system board allow remote monitoring and maintenance as well as fast restoration of operation in the event of errors.

Remote monitoring and maintenance avoids time-consuming and costly on-site repairs and reduces service costs. This leads to a reduction in the total cost of ownership and an excellent return on investment for the remote management solution.

The administrator can access all system information and information from the sensors such as fan speeds or voltages via the iRMC S5's web interface (see section "[iRMC S5 with integrated management LAN connector](#)" on page 19).

You can also start the text-based or graphic console bypass (Advanced Video Redirection, AVR) and connect virtual drives as remote storage.



More information about the iRMC S5 can be found in the iRMC S5 user guides (on the Fujitsu manuals server under *x86 Servers - Software - ServerView Suite - Out-Of-Band Management*).

2.2 Server specification

This section explains the specifications for the server. The specifications for this server are liable to be updated without any notice. Please be forewarned.

System Board

System board type	D3383
Chipset	Intel® C620

Processor (CPU)

CPU quantity and type	1 or 2 Intel® Xeon® CPUs (Platinum, Gold, Silver, Bronze)
-----------------------	---

Memory Modules Configuration

Memory slots	24 (12 DIMMs per CPU, 6 channels with 2 slots per channel)
Memory slot type	DIMM (DDR4)
Memory capacity (min. - max.)	8 GB - 3072 GB
Memory protection	Advanced ECC; Memory Scrubbing; SDDC; Rank sparing memory support; Memory Mirroring support
Memory notes	Memory modules with 8, 16, 32, 64 or 128 GB and 2666 MHz are available.

Interfaces

USB connectors	USB 3.0 connectors: 4 (2x front, 2x rear)
USB connectors (10 HDD variant)	USB 2.0 connectors: 1 (1x on front panel QRL) USB 3.0 connectors: 2 (2x rear)
Graphics (15-pin)	1x VGA (rear) 1x front VGA as an option (not for 10 HDD variant)
Serial (9-pin)	1 x serial RS-232-C, usable for iRMC S5 or system or shared
LAN / Ethernet	OCP option: <ul style="list-style-type: none"> - 4x 1 Gb - 2x 10 Gb - 2x 10 Gb SFP+ - 4x 10 Gb SFP+
Management LAN (RJ45)	1 x dedicated management LAN connector for iRMC S5 (10/100/1000 Mbit/s). Management LAN traffic can be switched to shared onboard Gbit LAN port.

Onboard or integrated controllers

RAID controller	Modular Host Bus Adapter with "Integrated RAID" (IR). RAID levels 0 and 1 are supported for internal HDD configurations.
SATA controller	Intel® C620, 1 x SATA channel for ODD
LAN controller	OCP based on Emulex XE100 series; PXE-Boot via LAN from PXE server, iSCSI / FCoE boot (also diskless).
Remote Management Controller	Integrated Remote Management Controller (iRMC S5), 256 MB DDR3-800 SRAM for video, IPMI 2.0 compatible
Trusted Platform Module (TPM)	Infineon / separate module; TCG V1.2 or TCG 2.0 compliant (option)

Functional overview

RAID controllers (expansion cards)

RAID controllers	Modular RAID 0/1 controller with "MegaRAID functionality" (integrated MegaRAID). RAID levels 0, 1, 10, 5 and 50 are supported for internal HDD configurations.
	Modular RAID 5/6 controller with "MegaRAID functionality" (integrated MegaRAID). RAID levels 0, 1, 10, 5, 50, 6 and 60 are supported for internal HDD configurations. As an option, a flash backup unit (FBU) can save the memory content even if the power fails. Cache memory size of up to 8GB are available.

Slots

PCI-Express 3.0 x8	1x low profile
PCI-Express 3.0 x16	3x low profile (2nd CPU required for slot 4)
Slot notes	One PCIe Gen3 x8 slot may be occupied with a Modular RAID controller if configured.

Drive bays

Hard disk bay configuration	4x, 8x, 10x 2.5-inch or 4x 3.5-inch
Accessible drive bays	1x 5.25/0.5-inch for DVD/RW-Blu-ray (not for 10 HDD variant)
Notes accessible drives	all possible options described in relevant system configurator

Operating Panel

Operating buttons	On/Off button
	ID button
	Reset button
	NMI button
Status LEDs	Global Error indicator (orange)
	ID indicator (blue)
	HDD/SSD activity indicator (green)
	Power-on indicator (green)
	AC connected indicator (green)
	CSS indicator (orange)
Status LED at system rear side	Global error / CSS / ID indicator (orange / orange / blue)
	LAN connection indicator (green)
	LAN speed indicator (green/yellow)

Dimensions / Weight

Rack (W x D x H)	482.6 mm (bezel) / 435.4 mm (body) x 720.7 mm x 42.85 mm
Mounting depth rack	748.2 mm
Height unit rack	1 U
19" rackmount	Yes
Mounting cable depth rack	200 mm (1000 mm rack recommended)
Weight	8.8 kg - 16.5 kg
Weight notes	actual weight may vary depending on configuration
Rack mounting kit	6.6 kg

Functional overview

Ambient conditions

Environment class 3K2 Environment class 2K2	EN 60721 / IEC 721 Part 3-3 EN 60721 / IEC 721 Part 3-2
Temperature Operation (3K2) Transport (2K2)	5°C ... 40°C (with ATD 40°C) 5°C ... 45°C (with ATD 45°C) 10°C ... 35°C (without ATD) -25°C ... 60°C
Humidity	10% ... 85% (non condensing)

Condensation during operation must be avoided!

Noise level

The acoustic noise values are depending on the system configuration.

	min. configuration 1x PSU 1x CPU	max. configuration 2x PSU 2x CPU
Sound power level $L_{WA,d}$ (ISO 9296)	< 5.1 B (standby) < 6.2 B (operation)	< 5.3 B (standby) < 7.7 B (operation)
Sound pressure level at adjacent workstation L_{pAm} (ISO 9296)	< 34 dB(A) (standby) < 44 dB(A) (operation)	< 36 dB(A) (standby) < 60 dB(A) (operation)

Electrical values of the AC PSU

Rated voltage range	100 V to 240 V (Platinum) 200 V to 240 V (Titanium)
Frequency	50 Hz - 60 Hz
Rated current with min. configuration	4.5 A / 2.0 A
Max. rated current	10.5 A / 5.0 A
Effective power	883 W
Apparent power	892 VA
Heat dissipation	3179 KJ/h (3013 BTU/h)
Main power fuse	16 A
Protection class	I

Electrical values of the DC PSU

Rated voltage	-48 V
Frequency	DC
Max. rated current	20 A
Effective power	800 W
Main power fuse	16 A

Electrical values of the Fujitsu battery unit (FJBU)

Max. output	380 W
Backup duration	Max. 2 seconds (380W), 4 minutes (280W) with FJBU M2
Charge duration	4 hours to 90%, 5 hours to 100%
Battery spec.	Nickel Metal-Hydrite battery
Battery life time	5 years
Input/Output voltage	12 V DC
Weight	1.2 kg

Functional overview

Compliance with standards

Product safety and ergonomics	
International	IEC 60950-1 2ed; am1 + am2
Europe	
Safety	EN 60950-1 2ed; A1 + A2 + A11 + A12 EN 62479
Ergonomics	ISO 9241-3 EN 29241-3 EK1-ITB2000:20xx
USA / Canada	CSA-C22.2 No. 60950-1-07 2ed; am1 + am2 UL 60950-1 2ed; am1 + am2
Australia / New Zealand	AS/NZS 60950-1
Taiwan	CNS 14336-1
China	GB 4943.1
India	IS 13252-1
Electromagnetic compatibility	
International	CISPR 22 + CISPR 32 CISPR 24
Europe	EN 55032 Class A EN 55024 EN 61000-3-2 EN 61000-3-3 ETSI EN 300386 (on demand)
USA / Canada	FCC 47CFR part 15 Class A / ICES-003
Australia / New Zealand	AS/NZS CISPR22 Class A AS/NZS CISPR32 Class A
Taiwan	CNS 13438 Class A
China	GB 9254 / GB 17625.1
Japan	VCCI Class A / JEITA
Korea	KN 32 / KN 35
RoHS Compliance	
Europe	EN 50581
Taiwan	CNS 15336



CAUTION!

This device meets the requirements of Class A CISPR 22/32. This device can cause radio interference in residential areas.

3 Installation steps, overview

This chapter contains an overview of the steps necessary to install your server. Links guide you to sections where you can find more detailed information on the individual steps:

- ▶ First of all, it is essential that you familiarize yourself with the safety information in chapter ["Important information" on page 33](#).
- ▶ Transport the server to the place where you want to set it up.
- ▶ Unpack all parts, check the contents of the package for visible transport damage and check whether the items delivered match the details on the delivery note (see section ["Unpacking the server" on page 46](#)).
- ▶ Make sure that all necessary manuals (see ["Documentation overview" on page 10](#)) are available; print out the PDF files if required.
- ▶ Components that have been ordered additionally may be delivered loose with the server. Install these in the server as described in the supplied documentation.
- ▶ Install the server in the rack (see section ["Installing/removing the server in/from the rack" on page 47](#)).
- ▶ Wire the server. Follow the instructions in sections ["Connecting devices to the server" on page 49](#) and ["Notes on connecting/disconnecting cables" on page 55](#).
- ▶ Connect the server to the mains (see section ["Connecting the server to the mains" on page 52](#)).
- ▶ Familiarize yourself with the controls and indicators on the front and rear of the server (see section ["Controls and indicators" on page 57](#)).

- ▶ Configure the server and install the desired operating system and applications. The following options are available:

- Remote installation with the ServerView Installation Manager:

With the ServerView Suite DVD provided, you can configure the server and install the operating system in a convenient manner.

Details on how to operate the ServerView Installation Manager, as well as some additional information, are included in the "ServerView Suite Installation Manager" user's guide (on the Fujitsu manuals server under *x86 Servers - Software - ServerView Suite - Server Installation and Deployment*).

Configuration information can also be found in section "[Configuring the server and installing the operating system with the ServerView Installation Manager](#)" on page 75.

- Local configuration and installation with or without the ServerView Installation Manager (see section "[Configuring the server and installing the operating system with the ServerView Installation Manager](#)" on page 75 or section "[Configuring the server and installing the operating system without the ServerView Installation Manager](#)" on page 76).



You will find more information on installing the server remotely or locally in the "ServerView Suite Installation Manager" user's guide (on the Fujitsu manuals server under *x86 Servers - Software - ServerView Suite - Server Installation and Deployment*).

4 Important information

In this chapter you will find essential information regarding safety when working on your server.



Depending on your server or the installed options some information is not valid for your server.



CAUTION!

Before installing and starting up a server, please observe the safety instructions listed in the following section. This will help you to avoid making serious errors that could impair your health, damage the server and endanger the data base.

4.1 Safety instructions



The following safety instructions are also provided in the manual "Safety Notes and Regulations" or "安全上のご注意".

This server meets the relevant safety regulations for IT equipment. If you have any questions about whether you can install the server in the intended environment, please contact your sales outlet or our customer service team.

- The actions described in this manual shall be performed by technical specialists. A technical specialist is a person who is trained to install the server including hardware and software.
- Repairs to the server that do not relate to CSS failures shall be performed by service personnel. Please note that unauthorized interference with the server will void the warranty and exempt the manufacturer from all liability.
- Any failure to observe the guidelines in this manual, and any improper repairs could expose the user to risks (electric shock, energy hazards, fire hazards) or damage the equipment.
- Only valid for non hot-plug components
Before installing/removing internal components to/from the server, turn off the server, all peripheral devices, and any other connected devices. Also unplug all power cords from the power outlet. Failure to do so can cause electric shock or damage.

Important information

Before starting up

- During installation and before operating the server, observe the instructions on environmental conditions for your server.
- If the server is brought in from a cold environment, condensation may form both inside and on the outside of the server.

Wait until the server has acclimatized to room temperature and is absolutely dry before starting it up. Material damage may be caused to the server if this requirement is not observed.

- Only transport the server in its original packaging or in packaging that protects it from impacts and jolts.
In Japan and APAC, transporting the server in its original packaging does not apply.

Installation and operation

- This server should not be operated in ambient temperatures above 35 °C. For servers with Advanced Thermal Design the ambient temperature can increase to 40 °C or 45 °C.
- If the server is integrated into an installation that draws power from an industrial power supply network with an IEC309 connector, the power supply's fuse protection must comply with the requirements for non-industrial power supply networks for type A connectors.
- The server automatically adjusts itself to a mains voltage, see the type label of your server. Ensure that the local mains voltage lies within these limits.
- This server must only be connected to properly grounded power outlets or connected to the grounded rack internal power distribution server with tested and approved power cords.
- Ensure that the server is connected to a properly grounded power outlet close to the server.
- Ensure that the power sockets on the server and the properly grounded power outlets are easily accessible.
- The On/Off button or the main power switch (if present) does not isolate the server from the mains power supply. In case of repair or servicing disconnect the server completely from the mains power supply, unplug all power plugs from the properly grounded power outlets.

- Always connect the server and the attached peripheral devices to the same power circuit. Otherwise you run the risk of losing data if, for example, the server is still running but a peripheral device (e.g. memory subsystem) fails during a power outage.
- The adequately shielded data cables must be used.

All data and signal cables must have sufficient shielding. The use of cable type S/FTP Cat5 or higher is recommended.
Use of unshielded or badly shielded cables may lead to increased emission of interference and/or reduced fault-tolerance of the device.
- Ethernet cabling has to comply with EN 50173 and EN 50174-1/2 standards or ISO/IEC 11801 standard respectively. The minimum requirement is a Category 5 shielded cable for 10/100 Ethernet, or a Category 5e cable for Gigabit Ethernet.
- Route the cables in such a way that they do not create a potential hazard (make sure no-one can trip over them) and that they cannot be damaged. When connecting the server, refer to the relevant instructions in this manual.
- Never connect or disconnect data transmission lines during a storm (risk of lightning hazard).
- Make sure that no objects (e.g. jewelry, paperclips etc.) or liquids can get inside the server (risk of electric shock, short circuit).
- In emergencies (e.g. damaged casing, controls or cables, penetration of liquids or foreign bodies), contact the server administrator or your customer service team. Only disconnect the server from the mains power supply if there is no risk of harming yourself.
- Proper operation of the server (in accordance with IEC 60950-1 resp. EN 60950-1) is only ensured if the server is completely assembled and the rear covers for the installation slots have been fitted (electric shock, cooling, fire protection, interference suppression).
- Only install server expansions that satisfy the requirements and rules governing safety and electromagnetic compatibility and those relating to telecommunication terminals. If you install other expansions, they may damage the server or violate the safety regulations. Information on which server expansions are approved for installation can be obtained from our customer service center or your sales outlet.
- The components marked with a warning notice (e.g. lightning symbol) may only be opened, removed or exchanged by authorized, qualified personnel. Exception: CSS components can be replaced.

Important information

- The warranty is void if the server is damaged during installation or replacement of server expansions.
- Only set screen resolutions and refresh rates that are specified in the operating manual for the monitor. Otherwise, you may damage your monitor. If you are in any doubt, contact your sales outlet or customer service center.
- Only valid for non hot-plug components
Before installing/removing internal components to/from the server, turn off the server, all peripheral devices, and any other connected devices. Also unplug all power cords from the power outlet. Failure to do so can cause electric shock or damage.

Internal devices remain hot after shutdown. Wait for a while after shutdown before installing or removing internal options.

- Do not damage or modify internal cables or internal devices. Doing so may cause a server failure, fire, or electric shock and will void the warranty and exempt the manufacturer from all liability.
- The circuit boards and soldered parts of internal options are exposed and can be damaged by static electricity. To ensure reliable protection, you must wear an earthing band on your wrist when working with this type of module and connect it to an unpainted, conducting metal part of the server.
- Do not touch the circuitry on boards or soldered parts. Hold the metallic areas or the edges of the circuit boards.
- Install the screw removed during installation/detaching internal options in former position. To use a screw of the different kind can cause a breakdown of equipment.
- The procedure of installation on this notes might change depending on a configuration of option.

Batteries

- Incorrect replacement of batteries may lead to a risk of explosion. The batteries may only be replaced with identical batteries or with a type recommended by the manufacturer.
- Do not throw batteries into the trash can.

Batteries must be disposed of in accordance with local regulations concerning special waste.

- Make sure that you insert the battery the right way round.

- The battery used in this server may present a fire or chemical burn hazard if mistreated. Do not disassemble, heat about 100 °C (212F), or incinerate the battery.
- Replace the lithium battery on the system board in accordance with the instructions in the corresponding Upgrade and Maintenance Manual, chapter "System board and components" > "CMOS battery".
- All batteries containing pollutants are marked with a symbol (a crossed-out garbage can). In addition, the marking is provided with the chemical symbol of the heavy metal decisive for the classification as a pollutant:

Cd Cadmium

Hg Mercury

Pb Lead

Working with optical disk drives and media

When working with optical disk drives, these instructions must be followed.



CAUTION!

- Only use CDs/DVDs/BDs that are in perfect condition, in order to prevent data loss, equipment damage and injury.
- Check each CD/DVD/BD for damage, cracks, breakages etc. before inserting it in the drive.

Note that any additional labels applied may change the mechanical properties of a CD/DVD/BD and cause imbalance and vibrations.

Damaged and imbalanced CDs/DVDs/BDs can break at high drive speeds (data loss).

Under certain circumstances, sharp CD/DVD/BD fragments can pierce the cover of the optical disk drive (equipment damage) and can fly out of the drive (danger of injury, particularly to uncovered body parts such as the face or neck).

- High humidity and airborne dust levels are to be avoided. Electric shocks and/or server failures may be caused by liquids such as water, or metallic items, such as paper clips, entering a drive.
- Shocks and vibrations are also to be avoided.
- Do not insert any objects other than the specified CDs/DVDs/BDs.

Important information

- Do not pull on, press hard, or otherwise handle the CD/DVD/BD tray roughly.
- Do not disassemble the optical disk drive.
- Before use, clean the optical disk tray using a soft, dry cloth.
- As a precaution, remove disks from the optical disk drive when the drive is not to be used for a long time. Keep the optical disk tray closed to prevent foreign matter, such as dust, from entering the optical disk drive.
- Hold CDs/DVDs/BDs by their edges to avoid contact with the disk surface.
- Do not contaminate the CD/DVD/BD surface with fingerprints, oil, dust, etc. If dirty, clean with a soft, dry cloth, wiping from the center to the edge. Do not use benzene, thinners, water, record sprays, antistatic agents, or silicone-impregnated cloth.
- Be careful not to damage the CD/DVD/BD surface.
- Keep the CDs/DVDs/BDs away from heat sources.
- Do not bend or place heavy objects on CDs/DVDs/BDs.
- Do not write with ballpoint pen or pencil on the label (printed) side.
- Do not attach stickers or similar to the label side. Doing so may cause rotational eccentricity and abnormal vibrations.
- When a CD/DVD/BD is moved from a cold place to a warm place, moisture condensation on the CD/DVD/BD surface can cause data read errors. In this case, wipe the CD/DVD/BD with a soft, dry cloth then let it air dry. Do not dry the CD/DVD/BD using devices such as a hair dryer.
- To avoid dust, damage, and deformation, keep the CD/DVD/BD in its case whenever it is not in use.
- Do not store CDs/DVDs/BDs at high temperatures. Areas exposed to prolonged direct sunlight or near heating appliances are to be avoided.



You can prevent damage from the optical disk drive and the CDs/DVDs/BDs, as well as premature wear of the disks, by observing the following suggestions:

- Only insert disks in the drive when needed and remove them after use.
- Store the disks in suitable sleeves.
- Protect the disks from exposure to heat and direct sunlight.

Laser information

The optical disk drive complies with IEC 60825-1 laser class 1.



CAUTION!

The optical disk drive contains a light-emitting diode (LED), which under certain circumstances produces a laser beam stronger than laser class 1. Looking directly at this beam is dangerous.

Never remove parts of the optical disk drive casing!

Modules with Electrostatic-Sensitive Devices (ESD modules)

Modules with electrostatic-sensitive devices are identified by the following sticker:

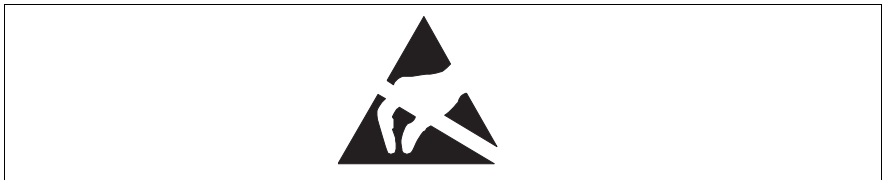

Figure 1: ESD label



The ESD label can be different.

When you handle ESD modules, you must always observe the following points:

- Switch off the server and remove the power plugs from the power outlets before installing or removing ESD modules.

Important information

- The circuit boards and soldered parts of internal options are exposed and can be damaged by static electricity. To ensure reliable protection, you must wear an earthing band on your wrist when working with ESD modules and connect it to an unpainted, conducting metal part of the server.
- Any devices or tools that are used must be free of electrostatic charge.
- Wear a suitable grounding cable that connects you to the external chassis of the server.
- Always hold ESD modules at the edges or at the points marked green (touch points).
- Do not touch any connectors or conduction paths on an ESD module.
- Place all the components on a pad which is free of electrostatic charge.



For a detailed description of how to handle ESD modules, see the relevant European or international standards (EN 61340-5-1, ANSI/ESD S20.20).

Transporting the server



CAUTION!

Only transport the server in its original packaging or in packaging that protects it from impacts and jolts.

In Japan and APAC, transporting the server in its original packaging does not apply.

Do not unpack the server until it is at its installation location.

If you need to lift or transport the server, ask other people to help you.

Never lift or carry the server by the handles or the Quick Release Levers (QRLs) on the front panel.

Notes on installing the server in the rack



CAUTION!

- For safety reasons, at least 2 people are required to install the server in the rack because of its weight and size.

(For the reader in Japan, please refer to "安全上のご注意".)

- Never lift the server into the rack using the QRLs (Quick Release Levers) on the front panel.
- When connecting and disconnecting cables, observe the relevant instructions in the "Important Information" chapter of the technical manual for the corresponding rack. The technical manual is supplied with the corresponding rack.
- When installing the rack, make sure that the anti-tilt mechanism is correctly fitted.
- Do not extend more than one server out of the rack simultaneously even if the tilt protection is in place. If several servers are simultaneously extended from the rack, there is a risk that the rack could tip over. See the safety information of the rack and the warning label.
- If the server/rack is intended for permanent connection to the mains only an authorized specialist (electrician) is allowed to work. Please follow the regulation of each country.
- If the server is integrated into an installation that draws power from an industrial power supply network with an IEC309 type connector, the power supply's fuse protection must comply with the requirements for non-industrial power supply networks for the type A connector.

Other important information

- During cleaning, observe the instructions in the corresponding Operating Manual chapter "Starting up and operation" > "Cleaning the server".
- Keep all manuals close to the server. All documentation must be included if the equipment is passed on to a third party.

4.2 CE conformity



:The system complies with the requirements of European Regulations. Find the CE declaration on certificate portal:
<https://sp.ts.fujitsu.com/sites/certificates/default.aspx>

To open the CE declaration applicable for your system, proceed as follows:

- ▶ Select *Industry Standard Servers*.
- ▶ Select your model, e.g. *Rack server*.
- ▶ Select your system, e.g. *PRIMERGY RX2530 M1*.
- ▶ Select *CE Cert <your system>*.



CAUTION!

This is a Class A product. In a domestic environment this product may cause RF interference, in which case the user may be required to take adequate measures.

4.3 FCC Class A Compliance Statement

If there is an FCC statement on the device, it applies to the products covered in this manual, unless otherwise specified herein. The statement for other products will appear in the accompanying documentation.

NOTE:

This equipment has been tested and found to comply with the limits for a "Class A" digital device, pursuant to Part 15 of the FCC rules and meets all requirements of the Canadian Interference-Causing Equipment Standard ICES-003 for digital apparatus. These limits are designed to provide reasonable protection against harmful interference in a residential installation. This equipment generates, uses and can radiate radio frequency energy and, if not installed and used in strict accordance with the instructions, may cause harmful interference to radio communications. However, there is no warranty that interference will not occur in a particular installation. If this equipment does cause harmful interference to radio or television reception, which can be determined by turning the equipment off and on, the user is encouraged to try to correct the interference by one or more of the following measures:

- Reorient or relocate the receiving antenna.
- Increase the separation between equipment and the receiver.
- Connect the equipment into an outlet on a circuit different from that to which the receiver is connected.
- Consult the dealer or an experienced radio/TV technician for help.

Fujitsu is not responsible for any radio or television interference caused by unauthorized modifications of this equipment or the substitution or attachment of connecting cables and equipment other than those specified by Fujitsu. The correction of interferences caused by such unauthorized modification, substitution or attachment will be the responsibility of the user.

The use of shielded I/O cables is required when connecting this equipment to any and all optional peripheral or host devices. Failure to do so may violate FCC and ICES rules.

4.4 Environmental protection

Environmentally-friendly product design and development

This product has been designed in accordance with the Fujitsu standard for "environmentally friendly product design and development". This means that key factors such as durability, selection and labeling of materials, emissions, packaging, ease of dismantling and recycling have been taken into account. This saves resources and thus reduces the harm done to the environment.

Further information can be found at:

http://ts.fujitsu.com/products/standard_servers/index.html

For the reader in Japan:

<http://jp.fujitsu.com/platform/server/primergy/concept/>

Energy-saving information

Devices that do not need to be constantly switched on should be switched off until they are needed as well as during long breaks and after completion of work.

Packaging information

This packaging information does not apply in Japan and APAC.

Important information

Do not throw away the packaging. You may need it later for transporting the server. If possible, the equipment should only be transported in its original packaging.

Information on handling consumables

Please dispose of printer consumables and batteries in accordance with the applicable national regulations.

In accordance with EU directives, batteries must not be disposed of with unsorted domestic waste. They can be returned free of charge to the manufacturer, dealer or an authorized agent for recycling or disposal.

All batteries containing pollutants are marked with a symbol (a crossed-out garbage can). They are also marked with the chemical symbol for the heavy metal that causes them to be categorized as containing pollutants:

Cd Cadmium

Hg Mercury

Pb Lead

Labels on plastic casing parts

Please avoid sticking your own labels on plastic parts wherever possible, since this makes it difficult to recycle them.

Returns, recycling and disposal

Please handle returns, recycling and disposal in accordance with local regulations.



The device must not be disposed of with domestic waste. This device is labeled in compliance with European directive 2012/19/EU on waste electrical and electronic equipment (WEEE).

This directive sets the framework for returning and recycling used equipment and is valid across the EU. When returning your used device, please use the return and collection systems available to you. Further information can be found at:

<http://ts.fujitsu.com/recycling>

Details regarding the return and recycling of devices and consumables within Europe can also be found in the "Returning used devices" manual, via your local Fujitsu branch, or at:

<http://ts.fujitsu.com/recycling>

5 Hardware installation



CAUTION!

- Follow the safety instructions in the chapter "[Important information](#)" on page 33.
- Do not expose the server to extreme environmental conditions (see "[Ambient conditions](#)" on page 26). Protect the server from dust, humidity and heat.
- Make sure that the server is acclimatized for the time indicated in this table before putting it into operation.

Temperature difference (°C)	Minimum acclimatization time (hours)
5	3
10	5
15	7
20	8
25	9
30	10

Table 1: Acclimatization time

In the [table "Acclimatization time"](#), the temperature difference refers to the difference between the operating environment temperature and the temperature to which the server was exposed previously (outside, transport or storage temperature).

5.1 Unpacking the server



CAUTION!

Follow the safety instructions in ["Important information" on page 33](#).
The server must always be lifted or carried by at least two people.
For Japan:
Please refer to "安全上のご注意".

Do not unpack the server until it is at its installation location.

- ▶ Transport the server to the place where you want to set it up.
- ▶ Unpack all individual parts.
Keep the original packaging in case you want to transport the server again (does not apply to Japan).
- ▶ Check the delivery for any damage during transport.
- ▶ Check whether the items delivered match the details on the delivery note.

The product name and serial number of the product can be found on the ID card (see section ["ID card" on page 69](#)).

- ▶ Notify your supplier immediately should you discover that the items delivered do not correspond to the delivery note.
- ▶ Remove all scratching protection foils from the front panel, HDD frames, and PRIMERGY logo, VGA dummy and ODD dummy in case they are still stucked to the server system.

5.2 Installing/removing the server in/from the rack



CAUTION!

- Please observe the safety information and notes on rack mounting in chapter "Important information" on page 33 and section "Notes on installing the server in the rack" on page 41.
- At least two people are needed to install / remove the server in the rack. (For Japan, please refer to "安全上のご注意".)
- Do not extend more than one unit out of the rack simultaneously even if the tilt protection is in place. If several units are simultaneously extended out of the rack, there is a risk that the rack could tip over.

Fujitsu rack systems

The rack systems from Fujitsu support the installation of PRIMERGY servers:

- PRIMECENTER rack
- PRIMECENTER M1 rack
- DataCenter rack
- 19-inch standard rack (for Japan)
- 19-inch slim rack (for Japan)



For information on mounting the server in the rack please refer to the Mounting Instructions provided with the Rack Mounting Kit. Further information you find in the manual of your rack system.

For Japan, please refer also to the "Rack system structure guide.



Online documentation for rack installation can be found on:

<http://manuals.ts.fujitsu.com/index.php?id=5406-5605-5606>

For Japan:

http://jp.fujitsu.com/platform/server/primergy/manual/peri_rack.html

Hardware installation

To accommodate the ventilation concept and ensure proper ventilation, any unused areas in the rack must be sealed using dummy covers.

The power is supplied via the multiple socket outlets fitted in the rack (not valid for Japan).

The main features of Fujitsu rack systems are as follows:

- rail systems that can be mounted without tools
- support systems having a linear alignment feature to ensure that they can be adjusted to different rack depths

Asymmetrical PRIMECENTER Rack and DataCenter Rack provide an enhanced cable management in the lateral rack area.

3rd party racks



Installation in most current rack systems from other manufacturers (3rd party racks) is also supported. For details please contact your sales representative.

5.3 Connecting devices to the server

The connectors for external devices are on the front and rear of the server. The additional connectors available on your server depend on the expansion cards installed.

i Some of the devices that can be connected may require special software, e.g. drivers (see the documentation for the connected device).

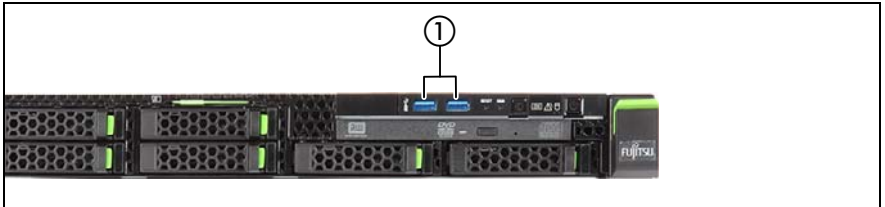

Figure 2: Ports on the front

The following connectors are located on the front of the server:

1	2 x USB 3.0 connectors
---	------------------------

A front VGA connector is available as an option.

10 HDD variant

For the variant with 10 HDDs of the PRIMERGY RX2530 M4 there is an USB 2.0 connector on the front panel on QRL instead of above mentioned USB3.0 connectors.



Figure 3: Front panel on QRL

1	1 x USB 2.0 connector
---	-----------------------

Hardware installation

Some standard connectors are color-coded.

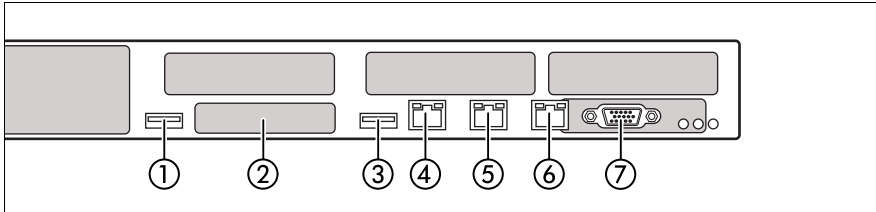

Figure 4: Connectors on the rear

Pos.	Description
1	USB 3.0 connector
2	OCP module (optional, different variants)
3	USB 3.0 connector
4	Management LAN connector (for iRMC S5 server management function)
5	Shared LAN connector (LAN1)
6	LAN connector (LAN2)
7	Video connector (VGA)

i Some of the devices that can be connected may require the installation and setting up of special software (e.g. drivers) (see the documentation for the connected device).

i Shared LAN connector is displayed in the BIOS Setup Utility and on the MAC address label as LAN2. Standard LAN connector is displayed in the BIOS Setup Utility and on the MAC address label as LAN1.

Note for LAN connectors on OCP modules

The LAN connectors on the OCP modules are numbered in ascending order from right to left beginning with “0”.

- ▶ Connect the desired devices to the server.

Connecting the keyboard, mouse and monitor

- ▶ Connect the keyboard and mouse to the USB connectors of the server.
- ▶ Connect the monitor to one of the two video connectors at the front or rear.

 The front video connector is designed for maintenance issues. If you connect a monitor to the video connector at the front, the video connector at the rear is deactivated. A monitor connected to the front must have at least the same resolution as the monitor connected to the rear. A console bypass is not possible via the video connector at the front.

 If a separate graphics card is installed in a slot, the graphic controller on the system board is automatically deactivated. The corresponding video connector can not be used. Plug the video cable of the monitor into the video connector of the graphics card.

- ▶ Connect the power cord of the monitor to the mains socket strip of the rack.

 The rated current for the monitor is indicated on the technical data label on the monitor or in the operating manual for the monitor.

5.4 Connecting the server to the mains

In its basic configuration level the server has one PSU.

A second PSU can be added to ensure a redundant power supply. If one PSU is defective, the other then guarantees unimpaired operation. In this case, the defective PSU can be replaced during operation (see the "PRIMERGY RX2530 M4 Server Upgrade and Maintenance Manual").



CAUTION!

The AC PSU is automatically set to a mains voltage in the range 100 - 240 V (PSU Platinum) or 200 - 240 V (PSU Titanium). You may only operate the server if its rated voltage range corresponds to the local mains voltage.



As an option, the server can be equipped with a DC PSU that adjusts automatically to any power voltage in the range from -40.5 V to -57 V.

- ▶ Connect the power cord to the PSU.
- ▶ Connect the mains connector to an outlet on the rack's socket strip (see also Technical Manual for the rack).



A phase redundancy in the power supply of the server can be set up if two PSUs are installed.

In this case, each of the PSUs is either connected to two different phases or to two separate circuits of the internal power supply network.

5.4.1 Connecting the server to the direct current (optional DC PSU)

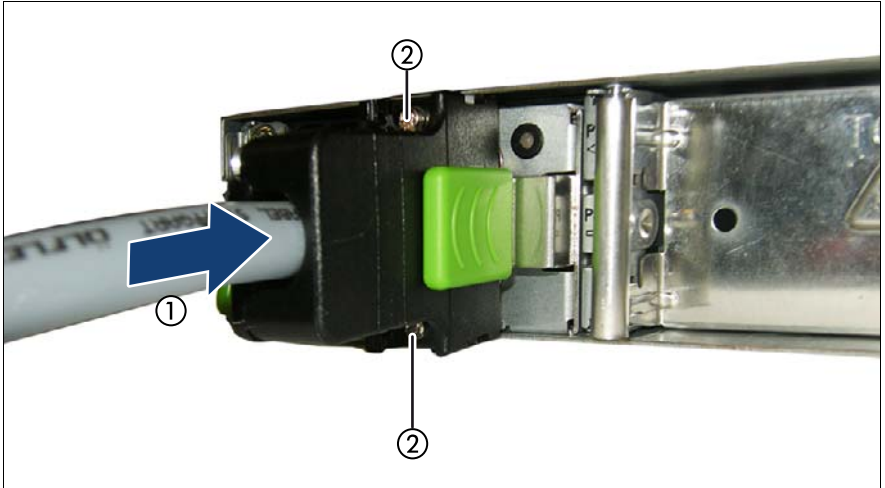

Figure 5: Connecting the server to the dc voltage

- ▶ Connect the power cord with the connector to the PSU of the server (1).
- ▶ Attach the connector with the 2 screws (2).
- ▶ Connect the wire labeled "Ground" to an appropriate earth ground.
- ▶ Connect the other two wires of the power cable to the current bar on the rack (see Technical Manual of the rack).

5.4.2 Using the cable clamps (AC PSU)

You can secure the power cord using a cable clamp to ensure that the insulated connector cannot be disconnected from the server accidentally. The cable clamp is included in the accessories pack that is delivered together with the server.

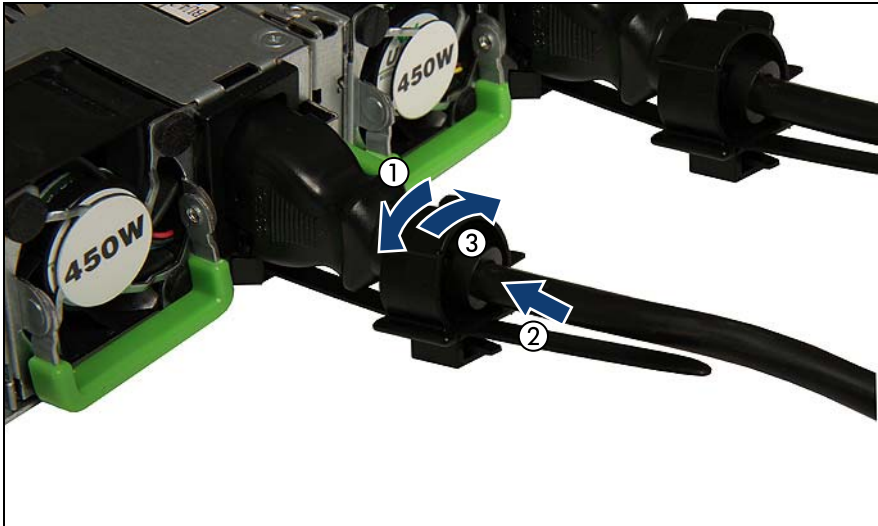

Figure 6: Using cable clamps

- ▶ Pull the cable clamp up (1).
- ▶ Thread the power cord through the cable clamp (2).
- ▶ Press the cable clamp down until it engages to secure the cable (3).

5.5 Notes on connecting/disconnecting cables



CAUTION!

Always read the documentation supplied with the device you wish to connect.

Never connect, or disconnect cables during a thunderstorm.

Never pull on a cable when disconnecting it. Always take hold of the cable by the plug.

Follow the sequence described below to connect or disconnect external devices to or from the server:

Be sure to wait for 10 seconds or more after shutdown before turning the server on.

Connecting cables

- ▶ Turn off all power and equipment switches.
- ▶ Disconnect all power plugs from the properly grounded power outlets.
- ▶ Connect all cables to the server and peripherals.
- ▶ Plug all data communication cables into the utility sockets.
- ▶ Plug all power cords into the properly grounded power outlets.

Disconnecting cables

- ▶ Turn off all power and equipment switches.
- ▶ Disconnect all power plugs from the properly grounded power outlets.
- ▶ Unplug all data communication cables from the utility sockets.
- ▶ Disconnect the relevant cables from the server and all the peripherals.



For connecting or disconnecting LAN cables, the server does not need to be powered off. To avoid loss of data teaming function has to be enabled.

Information for ensuring electromagnetic compatibility

All data and signal cables must have sufficient shielding. The use of cable type S/FTP Cat5 or higher is recommended.

Use of unshielded or badly shielded cables may lead to increased emission of interference and/or reduced fault-tolerance of the device.

6 Starting up and operation



CAUTION!

Follow the safety instructions in chapter "[Important information](#)" on page 33.

6.1 Controls and indicators

6.1.1 Server front

6.1.1.1 Controls on the front panel

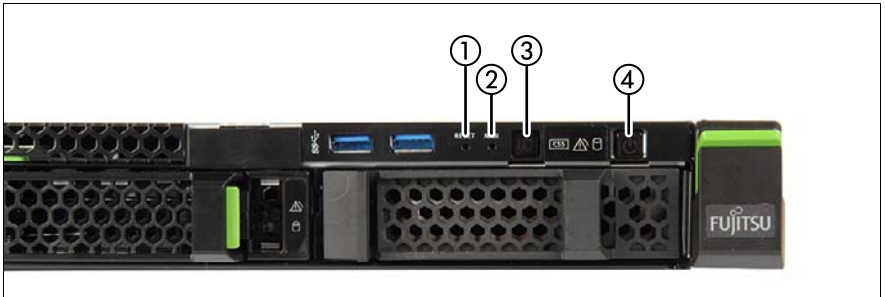

Figure 7: Controls on the front panel module

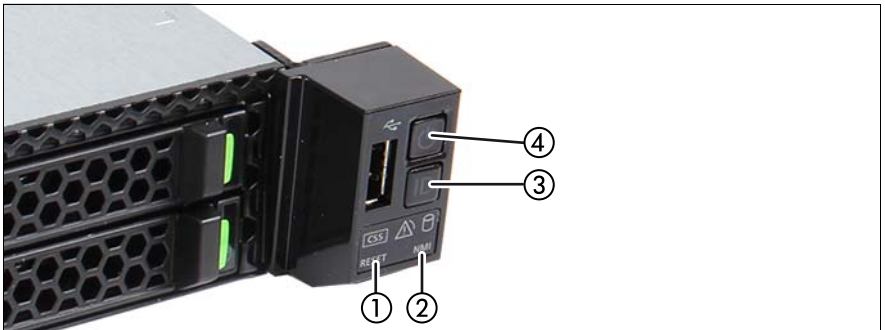





Figure 8: Controls on the front panel on QRL

Starting up and operation

Pos.	Label	Button	Function
1	RESET	Reset button	Reboots the system. Press the reset button with a straightened end of a paper clip.  CAUTION! Risk of data loss!
2	NMI	NMI button	Used to troubleshoot software and device driver errors. Press the NMI button with a straightened end of a paper clip.  CAUTION! Use this button only if directed to do so by qualified certified maintenance personnel!
3	ID	ID button	Highlights the ID indicator on the front and I/O panels for easy server identification.
4		On/Off button	Used to switch the server on or off.  If the system is running an ACPI-compliant operating system, pressing the On/Off button will perform a graceful shutdown.

6.1.1.2 Indicators on the front panel

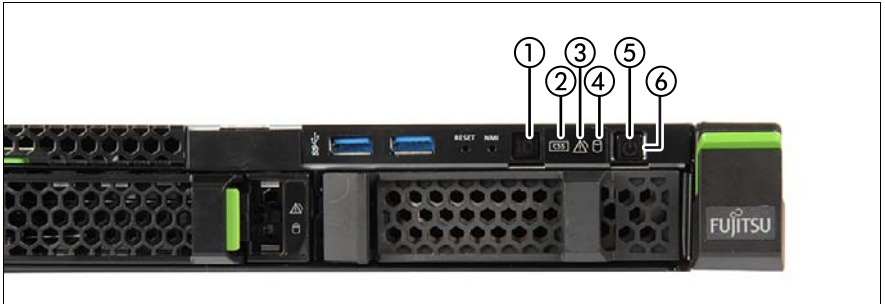

Figure 9: Indicators on the front panel module

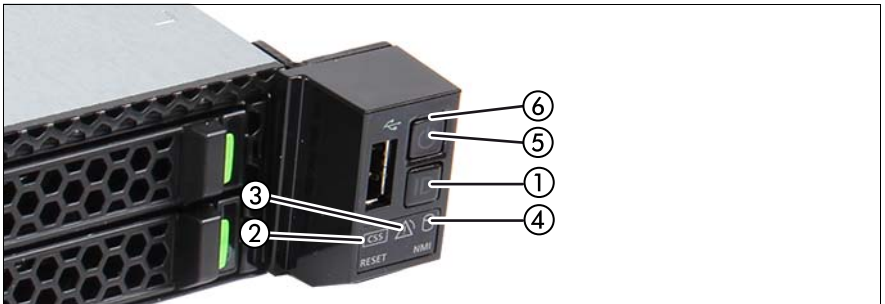







Figure 10: Indicators on the front panel on QRL

Pos.	Label	Indicator	Status	Description
1	ID	ID indicator, see also "iRMC-related status signals" on page 61	blue on	The server has been highlighted using ServerView Operations Manager, iRMC web interface or the ID button on the front panel for easy identification.
			blue flashing	The server has been highlighted for easy identification using the iRMC (AVR) with disabled local VGA output.

Starting up and operation

Pos.	Label	Indicator	Status	Description
2		CSS indicator	off	No critical event detected (CSS component).
			orange on	Prefailure event detected (CSS component).
			orange flashing	CSS component failure detected.
3		Global Error indicator, see also "iRMC-related status signals" on page 61	off	No critical event detected (non CSS component).
			orange on	Prefailure event detected (non CSS component).
			orange flashing	Non CSS component failure detected. Possible causes: <ul style="list-style-type: none"> – System is out of the specified range – Defective sensor – CPU error – Error detected by server management software
4		HDD/SSD activity indicator	green flashing	Data access in progress.
5		Power-on indicator	off	– The server is switched off.
			green on	– The server has been switched on but Power Cycle Delay settings delay it from turning on for a specified time. – The server is switched on and operating normally.
			green flashing slowly	iRMC S5 is not ready.

Pos.	Label	Indicator	Status	Description
6		AC connected indicator	green on	<ul style="list-style-type: none"> The server is switched off and connected to the mains (standby mode). The server has been switched on but Power Cycle Delay settings delay it from turning on for a specified time. <p>i After connecting the server to the mains, it will take about 60 seconds until the server will enter standby mode and can be switched on.</p>
			off	<ul style="list-style-type: none"> The server is switched off and not connected to the mains. The server is switched on and operating normally.

iRMC-related status signals

ID indicator	Global error indicator	Description
blue flashing	off	A remote connection has been established. Local VGA output has been disabled during the remote session.
blue flashing	orange flashing	<p>An emergency flash of the iRMC firmware is in progress.</p> <p>i For further information on the emergency flash of the iRMC firmware, refer to the "FUJITSU Server PRIMERGY RX2530 M4 Upgrade and Maintenance Manual".</p>

6.1.1.3 Indicators on the accessible drives/components

Indicator on the ODD

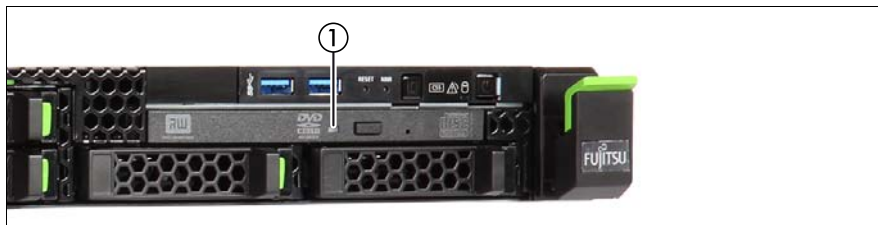

Figure 11: Indicator on the ODD

Pos.	Indicator	Status	Description
1	Activity indicator	off	The ODD is inactive.
		green on	The storage medium is being accessed.



There are also ODDs without activity indicators.

Indicators on the hot-plug HDD/SSD module

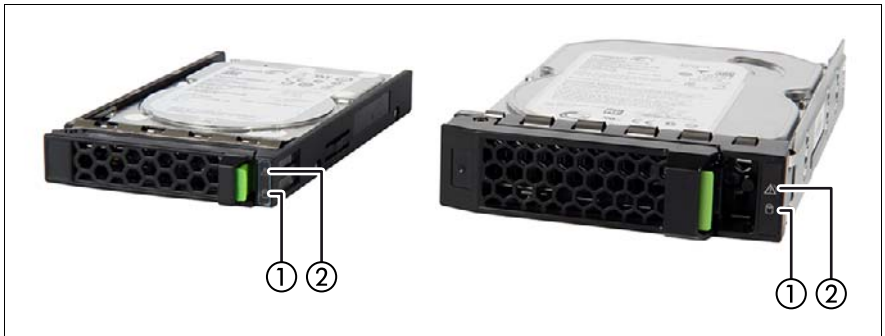



Figure 12: Indicators on the hot-plug HDD/SSD module

Pos.	Label	Indicator	Status	Description
1		Access indicator	off	The HDD/SSD is inactive.
			green on	The HDD/SSD is being accessed.
2		Error indicator	off	No HDD/SSD error detected.
			orange on	An HDD/SSD error has been detected. Possible causes: <ul style="list-style-type: none"> – The drive is defective and needs replacing. – A RAID rebuild process has failed. – The HDD/SSD module has not been inserted correctly.
			orange flashing slowly	RAID rebuild is in progress. Data is being restored after replacing a drive that has been combined into a RAID array.

6.1.2 Server rear

6.1.2.1 Indicators on the I/O panel

ID, CSS and Global Error indicators

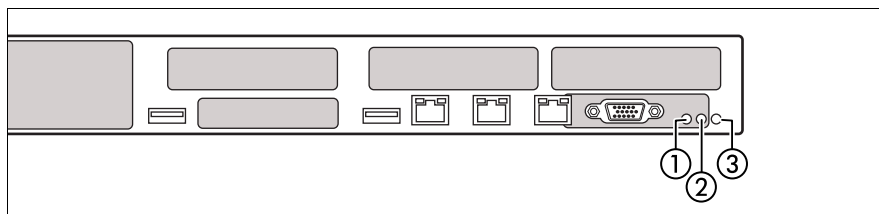

Figure 13: ID, CSS and Global Error indicators

Pos.	Indicator	Status	Description
1	ID indicator, see also "iRMC-related status signals" on page 65	blue on	The server has been highlighted using ServerView Operations Manager, iRMC web interface or the ID button on the front panel for easy identification.
		blue flashing	The server has been highlighted for easy identification using the iRMC (AVR) with disabled local VGA output.
2	Global Error indicator, see also "iRMC-related status signals" on page 65	off	No critical event detected (non CSS component).
		orange on	Prefailure event detected (non CSS component).
		orange flashing	Non CSS component failure detected. Possible causes: <ul style="list-style-type: none"> – System is out of the specified range – Defective sensor – CPU error – Error detected by server management software

Pos.	Indicator	Status	Description
3	CSS indicator	off	No critical event detected (CSS component).
		orange on	Prefailure event detected (CSS component).
		orange flashing	CSS component failure detected.



Note on CSS and Global Error indicators on the I/O panel

If CSS and Global Error indicators are located in the same place on your server's I/O panel, please also check the indicators on the front panel to determine if a CSS or Global Error event has been detected.



For further details on detected errors, refer to the System Event Log (SEL) or use the ServerView Operations Manager or iRMC S5 web interface.

iRMC-related status signals

ID indicator	Global error indicator	Description
blue flashing	off	A remote connection has been established. Local VGA output has been disabled during the remote session.
blue flashing	orange flashing	<p>An emergency flash of the iRMC firmware is in progress.</p>  <p>For further information on the emergency flash of the iRMC firmware, refer to the "FUJITSU Server PRIMERGY RX2530 M4 Upgrade and Maintenance Manual".</p>

LAN indicators

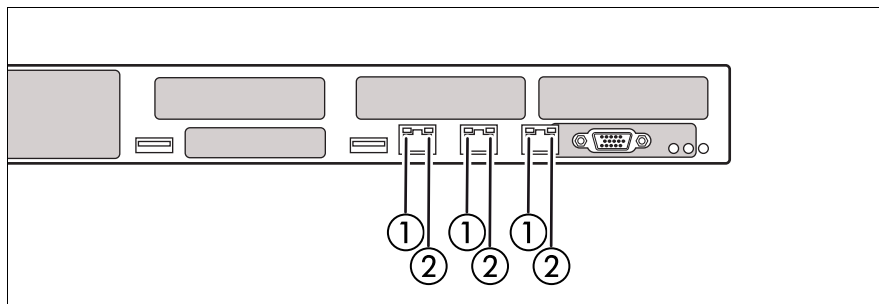

Figure 14: LAN indicators

Pos.	Indicator	Status	Description
1	LAN link/transfer indicator	green on	A LAN connection has been established.
		off	LAN is not connected.
		green flashing	LAN data transfer is in progress.
2	LAN speed indicator	yellow on	Data traffic at a transfer rate of 1 Gbit/s.
		green on	Data traffic at a transfer rate of 100 Mbit/s.
		off	Data traffic at a transfer rate of 10 Mbit/s.



Depending on the BIOS settings, the shared LAN connector may also be used as a management LAN connector. For further information, please refer to the corresponding BIOS Setup Utility reference manual.

6.1.2.2 Indicator on PSU (slide-in unit)



Figure 15: PSU status indicator (AC PSU)

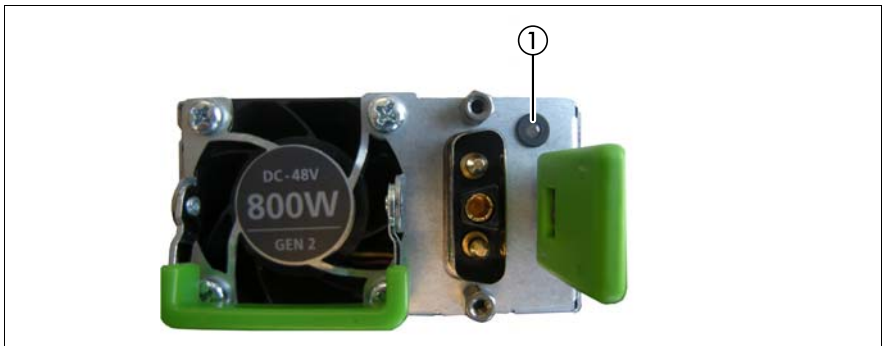

Figure 16: PSU status indicator (DC PSU)

Pos.	Indicator	Status	Description
1	PSU status indicator	green flashing	The server is switched off, but AC voltage / DC voltage is present (standby mode).
		green on	The server is switched on and operating properly.
		orange flashing	An overload has been detected. The PSU is still running, but failure might be imminent.
		orange on	An PSU failure has been detected. Possible causes: <ul style="list-style-type: none"> – Over/under voltage – Overheating – Fan failure

6.1.2.3 Indicator on Fujitsu battery unit (FJBU)

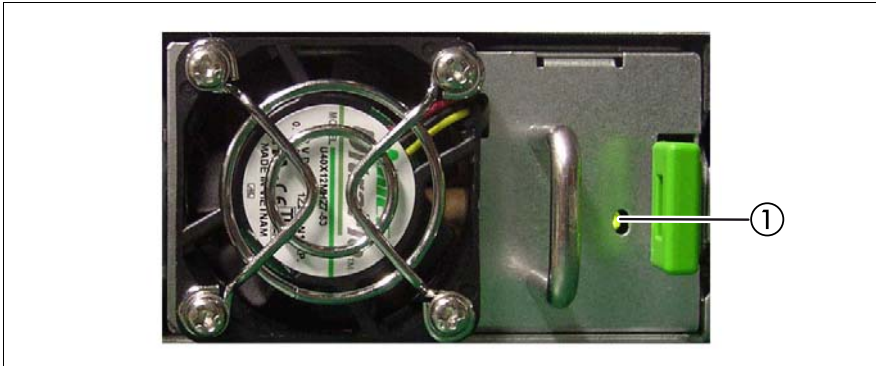

Figure 17: Indicator on FJBU

Pos.	Indicator	Status	Description
1	FJBU status indicator	green flashing	The battery unit is charging.
		green flashing slowly	The battery unit is discharging.
		green on	The battery unit is fully charged.
		orange flashing	A battery unit failure has been detected. Possible causes: <ul style="list-style-type: none">– Capacity failure– Overheating
		orange on	A general battery failure has occurred.

6.1.3 Indicators of the hot-plug system fans

A fan status indicator (LED on the system board) is assigned to each system fan. The status indicators are not visible unless the housing is open. The respective LED is set with commands in Server Management.

LED	Meaning
lights orange	Possible fan failure (rotation speed less than 70% of the original speed) or fan failure

6.2 ID card



Figure 18: ID card

You can pull out the ID card (1) and push it back again.

The ID card contains various system information, such as the product name, serial number, order number, MAC addresses and DNS name (for Japan, only the product name and the serial number).

6.3 Switching the server on and off



CAUTION!

- If nothing appears on the screen but flickering stripes after switching on the server, switch the server off immediately (see chapter "[Troubleshooting and tips](#)" on page 81).
- The On/Off button does not disconnect the server from the mains voltage. To completely disconnect it from the mains voltage, remove all power plug(s) from the socket(s).
- Do not move, strike, or shake the server when it is turned on. This can damage the hard disk in the server and cause data loss.
- Turn the server on when the temperature is in its operating environment range (10–35°C). For details on the operating environment, refer to "Safety Precautions". When operating the device outside of this operating environment, the server may operate improperly and data loss may occur. Furthermore, Fujitsu cannot be held responsible for any related damage, malfunction, or loss of data, etc.
- Be sure to wait for 10 seconds or more after shutdown before turning the server on again.
- After connecting all power cords, wait at least 60 seconds before pressing the On/Off button.

Switching the server on

The AC connected indicator lights up green (standby mode) when the server is connected to the mains.



It takes about 60 seconds until power-on becomes possible.

– Starting up for the first time:

For Japan, please refer to "はじめにお読みください".

- ▶ Press the On/Off button.
- ▶ Insert the ServerView Suite Installation DVD in the ODD.

- ▶ Follow the on-screen instructions (see also section ["Configuring the server and installing the operating system with the ServerView Installation Manager" on page 75](#) or section ["Configuring the server and installing the operating system without the ServerView Installation Manager" on page 76](#)).
 - **System already installed:**
 - ▶ Press the On/Off button.
The server is switched on, performs a system test and boots the operating system.
-  In the case of configurations with a large memory size, the boot process may be prolonged and the screen may remain dark for several minutes.

Switching the server off

The power-on indicator lights up green.

- ▶ Shut down the operating system properly.

The server is switched off automatically and enters standby mode. The AC connected indicator lights up green.

-  If the operating system does not switch off the server automatically, press the On/Off button for at least four seconds and/or send a corresponding control signal for power button override.



CAUTION!

There is a risk that data may be lost.

Other On/Off options

Besides the On/Off button, the server can be switched ON and OFF in the following ways:

- **Timer-controlled switch-on/off**
Using the ServerView Operations Manager or iRMC S5, you can configure that the server is switched on/off controlled by an internal timer.
- **Ring indicator**
The server is switched on by an internal or external modem.
- **Wake up On LAN (WOL)**
The server is switched on by a command via the LAN (Magic Packet™).

- **After power failure**

The server automatically reboots following a power failure (depending on the settings in the BIOS or in iRMC S5).

- **Power button override**

The system can be switched off (hard power off) by keeping the On/Off button (approximately 4 - 5 seconds).



CAUTION!

There is a risk that data may be lost.

- **iRMC S5**

iRMC S5 offers various options for switching the server on and off, e.g. via the *Power On Off* options of the iRMC S5 web interface.



**CAUTION when turning the power off
(Windows Server 2012 or Windows Server 2008)!**

The operation of the power switch can be specified as "Do Nothing", "Stand by", "Hibernate", and "Shutdown" depending on the OS settings. The default is "Shutdown".

On this server, functions corresponding to "Stand by" and "Hibernate" are supported as BIOS and hardware functions. However, some drivers and software installed in the server do not support these functions. For this reason, functions corresponding to "Stand by" and "Hibernate" are unavailable on this server. When the operating mode is set to "Stand by" or "Hibernate", the system may operate improperly or hard disk data may be corrupted.

For details about operating mode settings, refer to the manual supplied with the OS.



6.4 Configuring the server

This section contains information about configuring the server and installing the operating system.

-  Make sure that the power saving functions are disabled in the *Power* menu of the BIOS Setup during operation.

6.4.1 Configuring the onboard SATA controller

A SATA controller is integrated on the system board. You can configure the onboard controller either before or during installation with the ServerView Installation Manager. Using the ServerView Installation Manager is recommended.

-  The controller has its own configuration utility. For further information, refer to the “Embedded MegaRAID Software User’s Guide” (on the Fujitsu manuals server under *x86 Servers - Expansion Cards - Storage Adapters - LSI SAS / SCSI RAID Controllers*).
-  Descriptions of operating systems not covered in the controller manual are provided in the corresponding readme under:
<http://www.fujitsu.com/global/services/computing/server/ia/driver/index.html>
For Japan:
<http://www.fmworld.net/cgi-bin/drviasearch/drviaindex.cgi>
-  In the system BIOS the onboard SATA controller can be configured as "RAID" (default) or "non-RAID".

6.4.2 Configuring the SAS/SATA RAID controller

The server can be populated optional with SAS/SATA RAID PCIe controller with "MegaRAID functionality". You can configure the SAS/SATA RAID controller either before or during installation with the ServerView Installation Manager. Using the ServerView Installation Manager is recommended.

i A separate utility is available to the controller for MegaRAID configuration. For further information, refer to the "SAS Software User's Guide" (on the Fujitsu manuals server under *x86 Servers - Expansion Cards - Storage Adapters - LSI Configuration Software*).

Further information on modular RAID controllers is provided in the "Modular RAID Controller Installation Guide" (on the Fujitsu manuals server under *x86 Servers - Expansion Cards - Storage Adapters - LSI SAS / SCSI RAID Controllers*).

i Descriptions of operating systems not covered in the controller manual are provided in the corresponding readme under:
<http://www.fujitsu.com/global/services/computing/server/ia/driver/index.html>
For Japan:
<http://www.fujitsu.com/jp/products/computing/servers/primergy/downloads/>

6.4.3 Configuring the server and installing the operating system with the ServerView Installation Manager

Using the ServerView Installation Manager on the ServerView Suite DVD provided, you can conveniently configure the server and install the operating system. This includes configuring the server-specific settings using the ServerView Configuration Manager and configuring the RAID controller using the **ServerView RAID Manager**.

Advantages of the ServerView Installation Manager

- Wizard assisted configuration of your server hardware and disk arrays
- Wizard assisted installation of all leading server operating systems
- Wizard-assisted creation of configuration files for unattended installation of several PRIMERGY servers with identical hardware configurations.
- Installation of drivers and additional software.



The software that can be installed depends on your server's hardware configuration. This configuration is detected automatically.



Descriptions of operating systems not covered in the RAID controller manual are provided in the corresponding readme files under:

<http://www.fujitsu.com/global/services/computing/server/ia/driver/index.html>

For Japan:

<http://www.fujitsu.com/jp/products/computing/servers/primergy/downloads/>

To find out how to operate the ServerView Installation Manager and for further information, refer to the associated manual.

If you are using the ServerView Installation Manager, you can skip the following section on how to configure the server and install the operating system.

Continue from section "[Cleaning the server](#)" on page 77.

6.4.4 Configuring the server and installing the operating system without the ServerView Installation Manager

Configuring the onboard SAS/SATA controller

Configure the controller as described in section "[Configuring the onboard SATA controller](#)" on page 73.

Configure SAS/SATA RAID controller with "MegaRAID functionality"

Configure the controller as described in section "[Configuring the SAS/SATA RAID controller](#)" on page 74.

Installing the operating system

- ▶ Insert the DVD for the operating system you want to install.
- ▶ Reboot the server.
- ▶ Follow the instructions on screen and in the manual for the operating system.

6.5 Cleaning the server



CAUTION!

Switch off the server and disconnect the power plugs from the properly grounded power outlets.

Do not clean any interior parts yourself; leave this job to a service technician.

Do not use any cleaning agents that contain abrasives or may corrode plastic.

Ensure that no liquid enters the system. Ensure that the ventilation areas of the server and the monitor are clear.

Do not use any cleaning sprays (including flammable types). It may cause a device failure or a fire.

Clean the keyboard and the mouse with a disinfecting cloth.

Wipe the server and monitor casing with a dry cloth. If particularly dirty, use a cloth that has been moistened in a mild domestic detergent and then carefully wrung out.

7 Property and data protection

The rack model is protected against unauthorized access by a lockable rack door.

To protect your system and data internally against unauthorized access, you can use the BIOS Setup security functions.

7.1 BIOS Setup security functions

The *Security* menu in BIOS Setup offers various options for protecting your data from unauthorized access. By combining these options, you can also achieve optimum protection for your system.



A detailed description of the *Security* menu and how to assign passwords can be found in the "D3383 BIOS Setup Utility for FUJITSU Server PRIMERGY RX2530 M4 Reference Manual".

8 Troubleshooting and tips



CAUTION!

Follow the safety instructions in the "Safety notes and regulations" manual or "安全上のご注意" and in chapter ["Important information" on page 33](#).

If a fault occurs, attempt to resolve it using the measures described:

- in this chapter,
- in the documentation for the connected devices,
- in the help systems of the software used.

If you fail to correct the problem, proceed as follows:

- ▶ Make a list of the steps performed and the circumstances that led to the fault. Also make a list of any error messages that were displayed.
- ▶ Switch off the server.
- ▶ Contact our customer service team.

8.1 Power-on indicator remains unlit

The power-on indicator remains dark after you switch on your device.

Power cable incorrectly connected

- ▶ Make sure that the power cable(s) is/are correctly connected to the server and the grounded power outlet(s).

Power supply overloaded

- ▶ Disconnect the server power plug(s) from the grounded power outlet(s).
- ▶ Wait a few minutes before you plug it/them into the grounded power outlet(s) again.
- ▶ Switch on your server.

8.2 Server switches itself off

Server Management has detected an error

- ▶ Check the error list of System Event Log in ServerView Operations Manager or in the iRMC web interface, and attempt to eliminate the error.

8.3 Screen remains blank

Monitor is switched off

- ▶ Switch on your monitor.

Screen has gone blank

- ▶ Press any key on the keyboard.
or
- ▶ Deactivate screen saver. Enter the appropriate password.

Brightness control is set to dark

- ▶ Set the brightness control on the monitor to light. For detailed information, refer to the operating manual supplied with your monitor.

Power cable or monitor cable not connected

- ▶ Switch off the monitor and the server.
- ▶ Check whether the power cable is properly connected to the monitor and to the grounded power outlet.
- ▶ Check whether the monitor cable is properly connected to the server and monitor (if it is plugged in with a connector). If a separate graphics card is installed in the server, then the monitor cable must be connected to the graphics card.
- ▶ Switch on the monitor and the server.

8.4 Flickering stripes on monitor screen



CAUTION!

Switch off the server immediately. Risk of damaging the server.

Monitor does not support the set horizontal frequency

- ▶ Find out which horizontal frequency your monitor screen supports. You will find the horizontal frequency (also known as line frequency or horizontal deflection frequency) in the documentation for your monitor.
- ▶ Refer to the documentation for your operating system or the software for the screen controller for details of how to set the correct horizontal frequency for your monitor, and follow the procedure accordingly.

8.5 No screen display or display drifts

The wrong horizontal frequency or resolution has been selected for the monitor or for the application program.

- ▶ Find out which horizontal frequency your monitor screen supports. You will find the horizontal frequency (also known as line frequency or horizontal deflection frequency) in the documentation for your monitor.
- ▶ Refer to the documentation for your operating system or the software for the screen controller for details of how to set the correct horizontal frequency for your monitor, and follow the procedure accordingly.

8.6 Incorrect date and time

- ▶ Set the date and time in the operating system or in the BIOS Setup under the Main menu, using System Date and System Time respectively.

i Note that the operating system may affect the system time. For example, the operating system time may deviate from the system time under Linux, and would overwrite the system time in the default setting on shutdown.

If the date and time are still wrong after the server has been switched off and back on again, replace the lithium battery (for a description refer to the "FUJITSU Server PRIMERGY RX2530 M4 Upgrade and Maintenance Manual") or contact our customer service team.

8.7 System will not boot

The system will not boot after installing a new HDD.

SAS configuration incorrect

- ▶ Check the settings for the HDDs (*SAS Device Configuration*) and the additional settings in the SAS configuration menu.

8.8 Drives reported as “dead” when starting system

This error message can occur when the onboard SAS controller has RAID functionality or the server is equipped with a PCI RAID controller.

RAID controller configuration incorrect

- ▶ Check and correct the settings for the drives using the RAID controller utility.

Further information is provided in the manual for the RAID controller.

8.9 Added drive reported as defective

RAID controller is not configured for this drive

The drive was probably installed when the system was switched off.

- ▶ Reconfigure the RAID controller for the drive using the corresponding utility. Information is provided in the documentation for the RAID controller.

or

- ▶ Remove and reinstall the drive while the system is switched ON.

If the drive continues to be shown as defective, then replace it.

8.10 Error message on screen

The meaning of the error message is explained in the documentation for the relevant components and programs on the Fujitsu manuals server.

8.11 Expansion cards or onboard devices not recognized

When an expansion card is added, other expansion cards or onboard devices might not be recognized.

- ▶ Reinstall the drivers for the expansion cards or onboard devices that are not recognized.

8.12 Temperature warning

A temperature warning is output to the hardware event log and OS event log, or ServerView issues a notification of a temperature warning such as by a popup message

The above log is output or the above notification is issued by ServerView when the ambient temperature exceeds the upper limit of the temperature boundaries. The upper limit is 35°C for standard server and 40°C or 45°C with Advanced Thermal design.

- ▶ Although continued use within the temperature boundaries poses no problems within itself, reconsider the surrounding environment conditions if this log is output or if ServerView issues this notification.

8.13 No effect of keyboard or mouse

Typing the keyboard does not display any characters, or the mouse cursor does not move.

- ▶ Check to see whether the keyboard and mouse are connected properly. If they are not connected or you replaced them yourself, then connect the cables to the server.

8.14 Optical drive cannot read data

- ▶ Check to see whether the CD/DVD/BD is inserted properly. If the CD/DVD/BD is not inserted, correctly insert the disk so that the label is facing up.
- ▶ Check to see whether the CD/DVD/BD is not dirty. If the CD/DVD/BD is dirty, wipe it in a radial way with a soft, dry cloth.
- ▶ Check to see whether the CD/DVD/BD is not scratched or bent. If scratched or damaged, replace the CD/DVD/BD.