

MDSC-2324

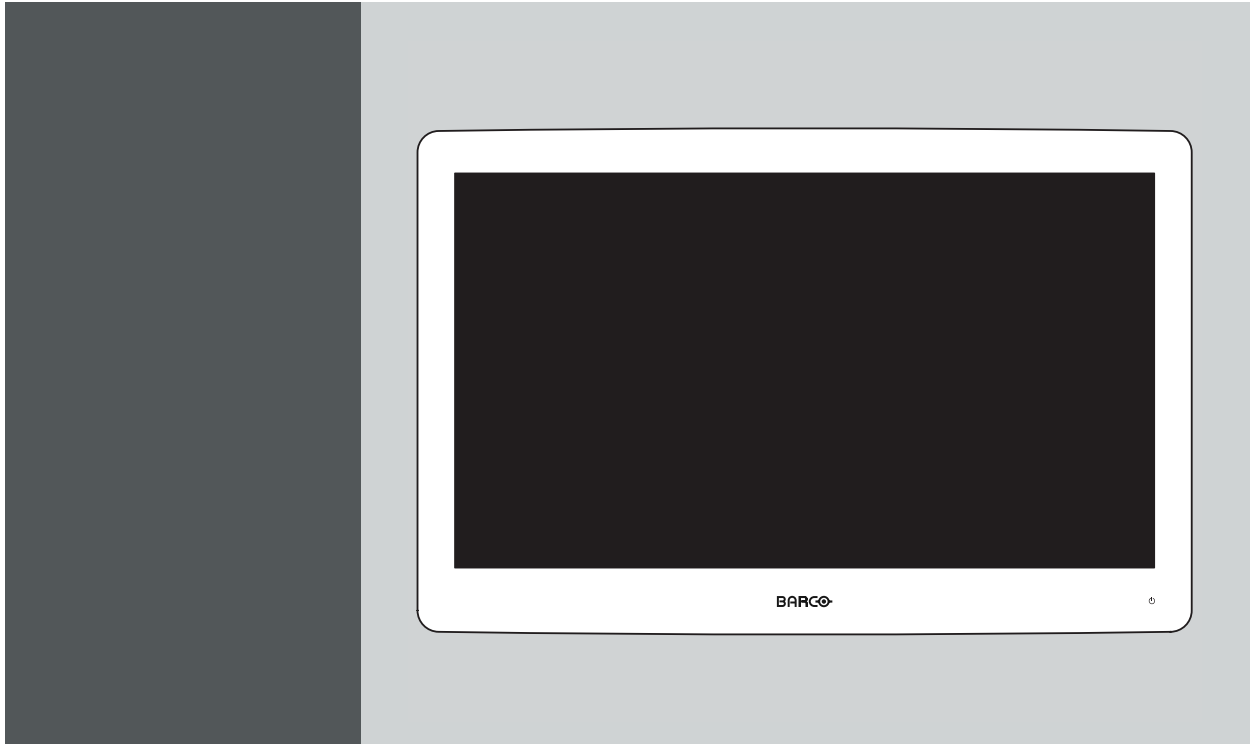

User Guide

MDSC-2324 LED
MDSC-2324 DDI
MDSC-2324 MNA

Barco NV

Beneluxpark 21, 8500 Kortrijk, Belgium

Phone: +32 56.23.32.11

Fax: +32 56.26.22.62

Support: www.barco.com/en/support

Visit us at the web: www.barco.com

Registered address: Barco NV

President Kennedypark 35, 8500 Kortrijk, Belgium

Phone: +32 56.23.32.11

Fax: +32 56.26.22.62

Support: www.barco.com/en/support

Visit us at the web: www.barco.com

TABLE OF CONTENTS

1. Welcome!	3
1.1 About the product	3
1.2 What's in the box	3
1.3 About this user guide	4
2. Product overview	5
2.1 Front view	5
2.2 Rear view	6
2.3 Connector view	6
2.3.1 MDSC-2324 LED version	6
2.3.2 MDSC-2324 DDI version	7
2.3.3 MDSC-2324 MNA version	7
2.4 Connector pin assignments	8
2.4.1 Input power connector	8
2.4.2 DVI-1 connector (DVI-I)	9
2.4.3 DVI-2 connector (DVI-D)	10
2.4.4 DVI out connector (DVI-D)	10
2.4.5 RS232 connector	10
2.4.6 USB type A connector	11
2.4.7 Mini USB connector	11
2.4.8 DisplayPort connector	11
2.4.9 S-Video and S-Video-out connector	12
3. Display installation	13
3.1 VESA mount installation	13
3.2 Cover removal	14
3.3 Video input connection	14
3.3.1 MDSC-2324 LED version	14
3.3.2 MDSC-2324 DDI version	15
3.3.3 MDSC-2324 MNA version	16
3.4 Video output connection	16
3.4.1 MDSC-2324 LED version	16
3.4.2 MDSC-2324 DDI version	17
3.4.3 MDSC-2324 MNA version	18
3.5 Nexxis OR	18
3.6 Power supply connection	18
3.7 Cable routing	19
4. Daily operation	21
4.1 Keyboard activation/deactivation	21
4.2 Keyboard backlight	22
4.3 On/Off switching	22
4.4 Power led status	22
4.5 OSD menu activation	23
4.6 OSD menu navigation	23
4.7 Shortkey functions	24
4.7.1 Main source selection	25
4.7.2 Multi-image configuration	25
4.7.3 Zoom factor selection	25
4.7.4 Brightness adjustment	25
4.8 Extended keyboard functions	26
4.8.1 Main source selection	27
4.8.2 Second source selection	27
4.8.3 Multi-image configuration	27
4.8.4 Common Functions: Transfer function selection	28
4.8.5 Common Functions: Image size selection	28
4.8.6 Common Functions: Zoom factor selection	29

4.9	Menu locking/unlocking	29
5.	Advanced operation	31
5.1	OSD picture menu	31
5.1.1	Profile	31
5.1.2	Brightness	31
5.1.3	Contrast	32
5.1.4	Saturation	32
5.1.5	Color temperature	32
5.1.6	Gamma	33
5.1.7	Sharpness	33
5.2	Picture Advanced menu	34
5.2.1	Black Level	34
5.2.2	Smart Video	34
5.2.3	Image Position	35
5.2.4	Auto Adjustment	35
5.2.5	Phase	35
5.2.6	Clock/Line	36
5.3	Display Format menu	36
5.3.1	Main Source (Primary Source)	36
5.3.2	Component Mode	37
5.3.3	Zoom	37
5.3.4	Image Size	38
5.3.5	2 nd Picture Mode	38
5.3.6	2 nd Picture Source	39
5.3.7	2 nd Picture Position	40
5.3.8	Picture Swap	40
5.4	Configuration menu	41
5.4.1	Information	41
5.4.2	Language	41
5.4.3	Failover mode	42
5.4.4	Extended keyboard	42
5.4.5	OSD setting	43
5.4.5.1	OSD Horizontal Position	43
5.4.5.2	OSD Vertical Position	43
5.4.5.3	OSD Time-out	43
5.4.6	Recall Profile	44
5.4.7	Save Profile	44
5.5	System menu	44
5.5.1	Power on DVI 1	45
5.5.2	Power on DVI 2	45
5.5.3	DVI Output	45
5.5.4	Keyboard lock	47
5.5.5	Keyboard backlight	47
5.5.6	Power Saving	47
6.	Important information	49
6.1	Safety information	49
6.2	Environmental information	52
6.3	Biological hazard and returns	54
6.4	Regulatory compliance information	54
6.5	EMC notice	55
6.6	Cleaning and disinfection	59
6.7	Explanation of symbols	59
6.8	Legal disclaimer	62
6.9	Technical specifications	62
6.10	Open source license information	67

1. WELCOME!

1.1 About the product

Overview

Barco's MDSC-2324 is a 24-inch surgical display. Purpose-built for the operating room, the MDSC-2324 offers an easy-clean design, smart mechanics and the most detailed images in the operating room today.

Ease of mind

Perfect hand-eye coordination: The display's high brightness, high contrast and full HD resolution provide surgeons with excellent depth perception and the most accurate images. The MDSC-2324 presents images with unrivaled color and grayscale accuracy and with near-zero latency, making it perfectly suited for use with today's state-of-the-art endoscopy camera systems.

Multi-source, multi-display imaging: With its broad input connectivity, the MDSC-2324 also offers flexible multi-modality imaging (PiP & PaP) in new integrated operating rooms. Thanks to its high-bright LED backlight, the surgical display also ensures a long lifetime and low power consumption.

Ease of installation

The MDSC-2324 comes with a smart cable management system that hides the cables for a clutter-free set-up. Its lightweight design allows easy mounting on surgical booms and spring arms. Available in different models, this surgical display also features a host of connectivity options and remote control.

Ease of use

Barco's MDSC-2324 allows easy cleaning and complete disinfection thanks to its smooth surface, sealed housing, and protective screen cover. The fanless design avoids the spread of contaminants.

Features

- 24-inch wide-screen LCD with full HD resolution and 10-bit per color
- Wide viewing angle
- High-brightness LED backlight
- Advanced, full 10-bit image processing algorithms with 12-bit LUT
- Widest range of SD and HD input signals, including 3G-SDI and DisplayPort
- Light weight to easily mount onto a boom

Innovative features are also available to give maximum flexibility when installing the display as: Configurable DVI-out and Failover Mode

1.2 What's in the box

Overview

Your MDSC-2324 display comes with:

- MDSC-2324 user guide
- DVI cable
- AC power cords
- external power supply
- 4 screws, 4 dented washers and an Allen key

1. Welcome!



Keep your original packaging. It is designed for this display and is the ideal protection during transport.



The user guide is available in other languages on www.barco.com.

1.3 About this user guide

Overview

This manual provides support to the user during the installation, set up and utilization of the MDSC-2324 display. Depending on the specific version that has been purchased, some of the features and options described in this document may not apply to the display in user's hands.

2. PRODUCT OVERVIEW

2.1 Front view

Overview

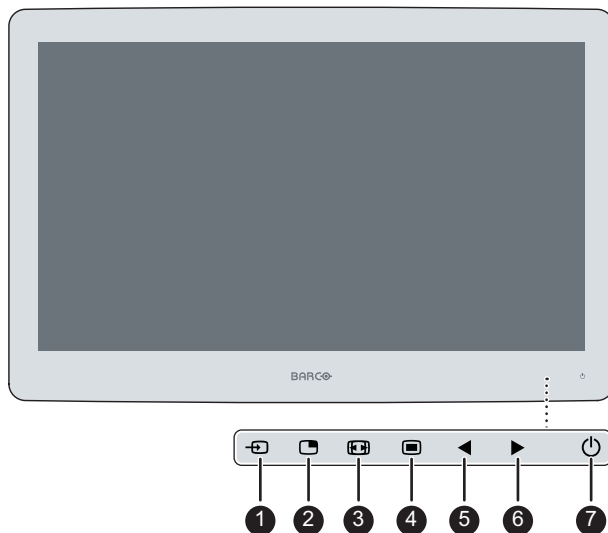

Image 2-1

1. Input Selection key
2. Multi-image selection key / Down key
3. Image zoom key / Up key
4. OSD Menu key / Enter key
5. Brightness decrease / Left key
6. Brightness increase / Right key
7. Stand-by key

A 7-key capacitive keypad is located on the front of the display. By default only the stand-by key is visible. When you touch any of the keys shortly, the front illumination of all other keys is switched on for a few seconds. When you touch any of these other keys again while the illumination is on, the function of the key is executed. If no further action is taken within the time-out, the front key illumination is switched off again.



The auto-dim function of the front key illumination can be disabled in the OSD menu.



For keyboard activation please refer to "Keyboard activation/deactivation", page 21

2.2 Rear view

Overview

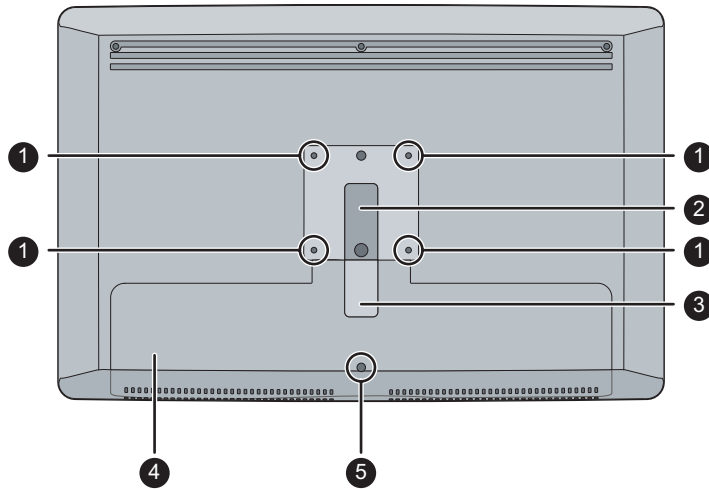

Image 2-2

1. VESA mount screw holes
2. Cable routing channel
3. Cable routing channel expansion clip
4. Connector compartment cover
5. Connector compartment cover fixation screw

2.3 Connector view

2.3.1 MDSC-2324 LED version

Overview

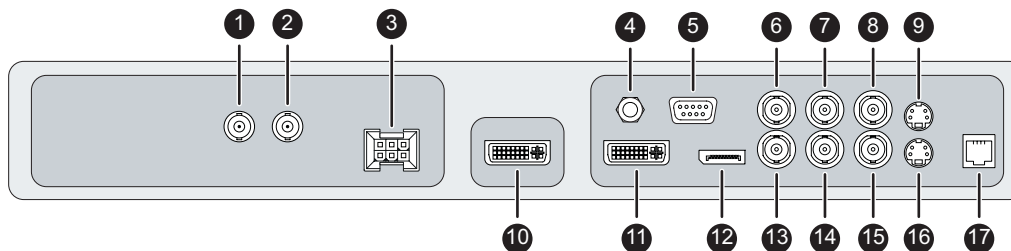

Image 2-3

1. SDI-1 out
2. SDI-1
3. Input power connector
4. Potential Equalization pin (POAG)
5. RS232
6. Sync
7. CVBS
8. CVBS out
9. S-Video out
10. DVI out
11. DVI-1 (DVI-I: digital & analog with HDCP)

- 12. DisplayPort (VESA std 1.1a)
- 13. R/Pr
- 14. G/Y – SOG
- 15. B
- 16. S-Video
- 17. Service

2.3.2 MDSC-2324 DDI version

Overview

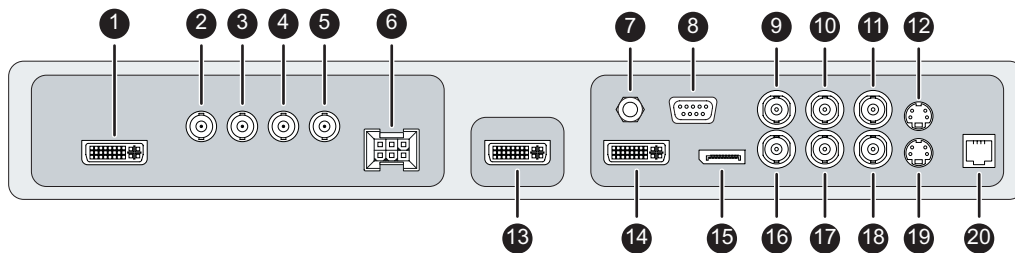

Image 2-4

- 1. DVI-2 (DVI-D: digital only)
- 2. SDI-2 out
- 3. SDI-2
- 4. SDI-1 out
- 5. SDI-1
- 6. Input power connector
- 7. Potential Equalization pin (POAG)
- 8. RS232
- 9. Sync
- 10. CVBS
- 11. CVBS out
- 12. S-Video out
- 13. DVI out
- 14. DVI-1 (DVI-I: digital & analog with HDCP)
- 15. DisplayPort (VESA std 1.1a)
- 16. R/Pr
- 17. G/Y – SOG
- 18. B
- 19. S-Video
- 20. Service

2.3.3 MDSC-2324 MNA version

Overview

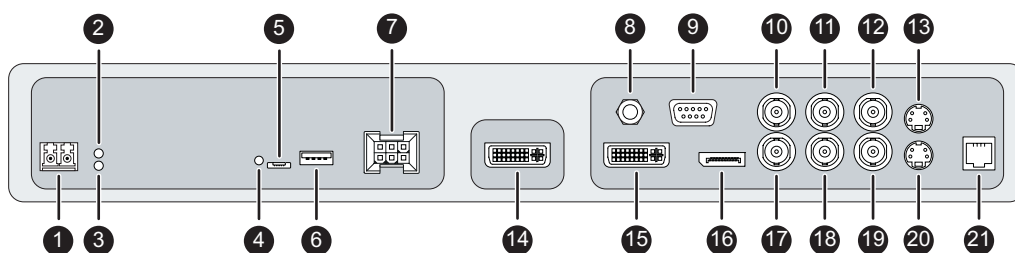

Image 2-5

2. Product overview

1. Optical 10Gb Ethernet SFP+ interface*
2. LED1*
 - Green: Link is active
 - Off: No active network connection
3. LED2*
 - Orange blinking: Activity = (Tx) or (Rx)
 - Off: No network activity
4. LED3*
 - Green: Power on, normal operation
 - Off: System not powered
 - Orange blinking: Error
5. Micro USB interface*
6. USB 2.0 type A interface*
7. Input power connector
8. Potential Equalization pin (POAG)
9. RS232
10. Sync
11. CVBS
12. CVBS out
13. S-Video out
14. DVI out
15. DVI-1 (DVI-I: digital & analog with HDCP)
16. DisplayPort (VESA std 1.1a)
17. R/Pr
18. G/Y – SOG
19. B
20. S-Video
21. Service

(*) Nexxis OR functionality: for more detailed information on Barco's Nexxis integrated OR solution please refer to the dedicated user guides. Please visit my.barco.com to obtain these user guides.

2.4 Connector pin assignments

2.4.1 Input power connector

Overview

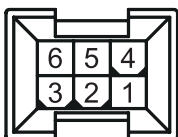

Image 2-6

1. GND
2. Not connected
3. +24 VDC
4. GND
5. Shield
6. +24 VDC



The ground and the shield connections on the power input connector have no Protective Earth function. A Protective Earth connection is provided via a dedicated pin (see "Power supply connection", page 18).

2.4.2 DVI-1 connector (DVI-I)

Overview

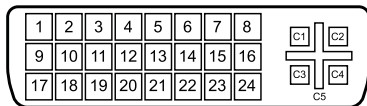

Image 2-7

1. D2_Rx- (T.M.D.S.)
 2. D2_Rx+ (T.M.D.S.)
 3. GND (data 2 shield)
 4. Not connected
 5. Not connected
 6. SCL (for DDC)
 7. SDA (for DDC)
 8. Analog vertical sync
 9. D1_Rx- (T.M.D.S.)
 10. D1_Rx+ (T.M.D.S.)
 11. GND (data 1 shield)
 12. Not connected
 13. Not connected
 14. +5V input (DDC supply) (*)
 15. GND (cable sense)
 16. Hot plug detect (*)
 17. D0_Rx- (T.M.D.S.)
 18. D0_Rx+ (T.M.D.S.)
 19. GND (data 0 shield)
 20. Not connected
 21. Not connected
 22. GND (clock shield)
 23. CK_Rx+ (T.M.D.S.)
 24. CK_Rx- (T.M.D.S.)
 25. C1: Analog Red
 26. C2: Analog Green
 27. C3: Analog Blue
 28. C4: Analog horizontal sync
 29. C5: Analog GND return (analog R, G, B)
- (*) +5 VDC output selectable on either pin 14 or 16 via the OSD menu. (+5V ± 10% @ 500mA (max))



PC analog (VGA) input source can be connected to the DVI-I input connector using a DVI-I to VGA adapter. The use of an adapter cable of at least 0.15 m long will allow an easy placement inside the cable cover.

2.4.3 DVI-2 connector (DVI-D)

Overview

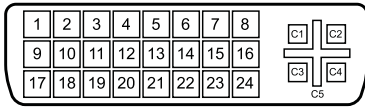

Image 2-8

1. D2_Rx- (T.M.D.S.)
2. D2_Rx+ (T.M.D.S.)
3. GND (data 2 shield)
4. Not connected
5. Not connected
6. SCL (for DDC)
7. SDA (for DDC)
8. Not connected
9. D1_Rx- (T.M.D.S.)
10. D1_Rx+ (T.M.D.S.)
11. GND (data 1 shield)
12. Not connected
13. Not connected
14. +5V input (DDC supply) (*)
15. GND (cable sense)
16. Hot plug detect (*)
17. D0_Rx- (T.M.D.S.)
18. D0_Rx+ (T.M.D.S.)
19. GND (data 0 shield)
20. Not connected
21. Not connected
22. GND (clock shield)
23. CK_Rx+ (T.M.D.S.)
24. CK_Rx- (T.M.D.S.)

(*) +5 VDC output selectable on either pin 14 or 16 via the OSD menu. (+5V ± 10% @ 500mA (max))

2.4.4 DVI out connector (DVI-D)

DVI-D

The DVI out connector is also a DVI-D connector type, see previous paragraph for more details.

2.4.5 RS232 connector

Overview

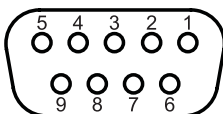

Image 2-9

1. Not connected
2. Rx (driven by host)
3. Tx (driven by display)
4. Not connected
5. Ground
6. Not connected
7. Not connected
8. Not connected
9. Not connected

2.4.6 USB type A connector

Overview

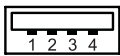

Image 2-10

1. +5 VDC
2. Data -
3. Data +
4. GND

2.4.7 Mini USB connector

Overview

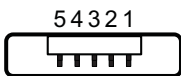

Image 2-11

1. +5 VDC
2. Data -
3. Data +
4. Not connected
5. GND

2.4.8 DisplayPort connector

Overview

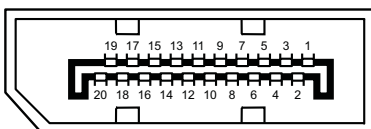

Image 2-12

2. Product overview

1. ML_Lane 0 (p)
2. GND
3. ML_Lane 0 (n)
4. ML_Lane 1 (p)
5. GND
6. ML_Lane 1 (n)
7. ML_Lane 2 (p)
8. GND
9. ML_Lane 2 (n)
10. ML_Lane 3 (p)
11. GND
12. ML_Lane 3 (n)
13. CONFIG1
14. CONFIG2
15. AUX CH (p)
16. GND
17. AUX CH (n)
18. Hot Plug
19. Return
20. DP_PWR (+3.3 VDC @ 500 mA max)

2.4.9 S-Video and S-Video-out connector

Overview

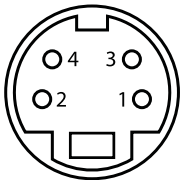

Image 2-13

1. Ground (Y)
2. Ground (C)
3. Luminance (Y)
4. Chroma (C)
5. SG: Shielded Ground

3. DISPLAY INSTALLATION

3.1 VESA mount installation

Overview

The display supports mounting arm & stands according to the VESA 100 mm standard.



CAUTION: Use an arm that is approved by VESA.



CAUTION: Use an arm that can support a weight of least 10 kg (22,05 lbs).

The monitor VESA interface has been designed for a safety factor 6 (to support 6 times the monitor weight). In the medical system, use an arm with suitable safety factor (IEC60601-1).

To mount the display to an arm stand

1. Attach the arm stand **firmly** to the panel using the included 4 hexagonal screws (M4 x 25 mm) and the dented washers. Use the included Allen key to fix the screws.

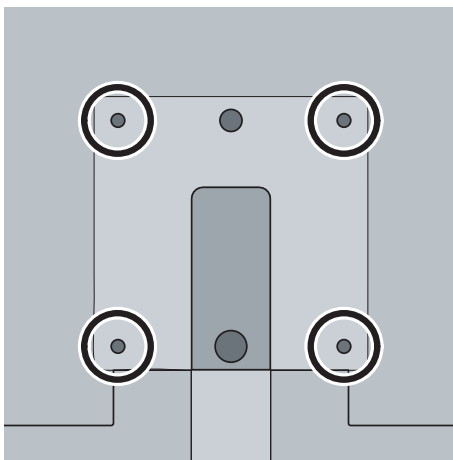

Image 3-1



CAUTION: The 4 screws included with this display (M4 x 25 mm) can be used for an external VESA arm interface with a thickness of up to 5 mm.

If, due to the thickness of the external VESA arm interface (=V), the length of the provided screws (=L) is not suitable, consider the following rule:

$$L_{\min} = V + 20 \text{ mm}$$

$$L_{\max} = V + 30 \text{ mm}$$

3.2 Cover removal

To remove the connector compartment cover

1. Loosen the screws fixing the connector compartment cover.
2. Slide the cover downwards to remove it from the display.

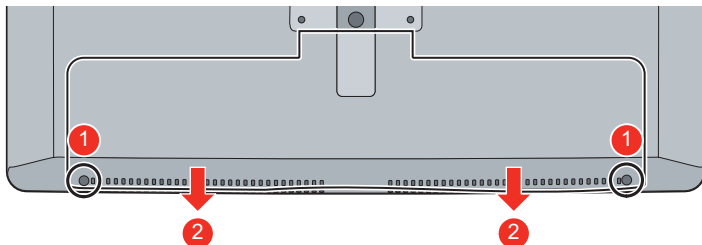

Image 3-2

3.3 Video input connection

About video input connections

The MDSC-2324 can have multiple different video inputs connected (depending on the display version). Switching between the different inputs can be easily done by pressing the direct access key for this. See the dedicated section for more info.

Futhermore, if more than one video source is connected, the Picture in Picture (PiP) and Side-by-Side (SbS) functionality becomes available, allowing you to view two different video inputs at once. Please refer to the dedicated chapter for more info on how to activate and use the PiP and SbS features on your MDSC-2324.

This chapter describes how to connect the different video input types for each version of the MDSC-2324.

3.3.1 MDSC-2324 LED version

To connect the video inputs

1. Connect one or more of the available video source(s) to the corresponding video inputs using the appropriate video cable(s).
 - DVI or VGA (*): 4
 - DisplayPort: 5
 - SDI: 1
 - R/G/B/S: 6/7/8/2
 - R/G/B (SOG): 6/7/8
 - Y/Pb/Pr: 7/8/6
 - CVBS: 3
 - S-Video: 9

(*) PC analog (VGA) input source can be connected to the DVI-I input connector using a DVI-I to VGA adapter. The use of an adapter cable of at least 0.15 m long will allow an easy placement inside the cable cover.

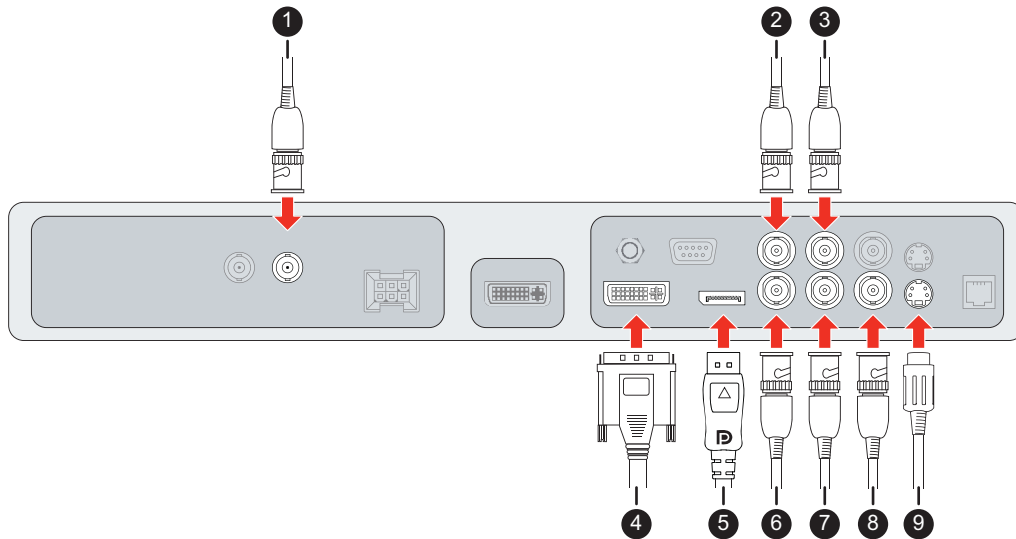

Image 3-3

3.3.2 MDSC-2324 DDI version

To connect the video inputs

1. Connect one or more of the available video source(s) to the corresponding video inputs using the appropriate video cable(s).

- DVI 1 or VGA (*): 6
- DVI 2: 1
- DisplayPort: 7
- SDI 1: 3
- SDI 2: 2
- R/G/B/S: 8/9/10/4
- R/G/B (SOG): 8/9/10
- Y/Pb/Pr: 9/10/8
- CVBS: 5
- S-Video: 11

(*) PC analog (VGA) input source can be connected to the DVI-I input connector using a DVI-I to VGA adapter. The use of an adapter cable of at least 0.15 m long will allow an easy placement inside the cable cover.

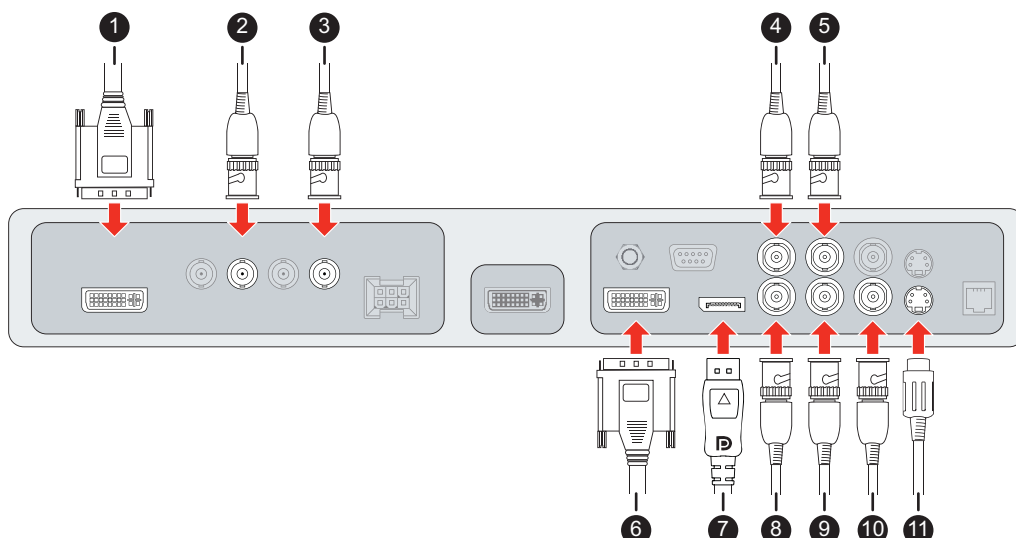

Image 3-4

3.3.3 MDSC-2324 MNA version

To connect the video inputs

1. Connect one or more of the available video source(s) to the corresponding video inputs using the appropriate video cable(s).

- Nexxis: 3
- DVI or VGA (*): 4
- DisplayPort: 5
- R/G/B/S: 6/7/8/1
- Y/Pb/Pr: 7/8/6
- CVBS: 2
- S-Video: 9

(*) PC analog (VGA) input source can be connected to the DVI-I input connector using a DVI-I to VGA adapter. The use of an adapter cable of at least 0.15 m long will allow an easy placement inside the cable cover.

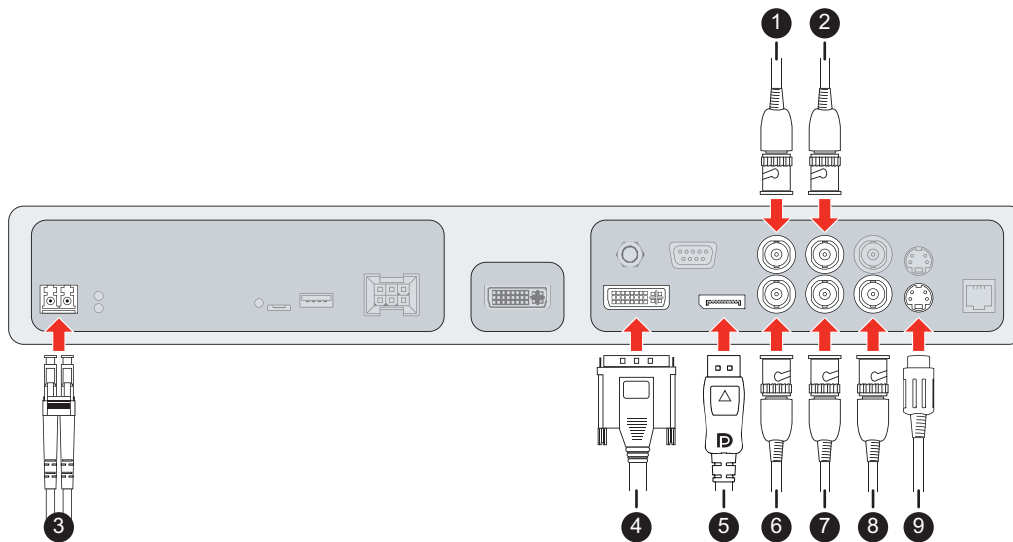

Image 3-5

3.4 Video output connection

About video output connections

Beside the video input connections, the MDSC-2324 also has video output capabilities allowing you to loop-through certain video inputs connected with the MDSC-2324 to another display, projector, video recorder, ...

This chapter describes how to make use of the video output connections available for each version of the MDSC-2324.

3.4.1 MDSC-2324 LED version

To connect the video outputs

1. Connect one or more of the available video sink(s) to the corresponding video outputs using the appropriate video cable(s).

- SDI: 1
- CVBS: 2
- S-Video: 3
- DVI: 4 (to be configured in OSD menu)

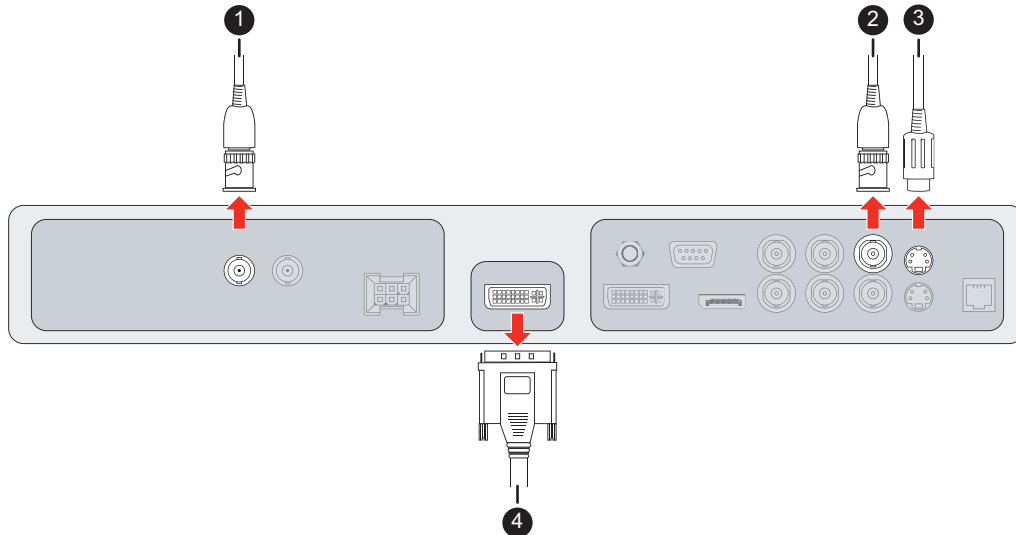

Image 3-6

3.4.2 MDSC-2324 DDI version

To connect the video outputs

1. Connect one or more of the available video sink(s) to the corresponding video outputs using the appropriate video cable(s).
 - SDI 1: 2
 - SDI 2: 1
 - CVBS: 3
 - S-Video: 4
 - DVI 1 or DVI 2: 5 (to be configured in OSD menu)

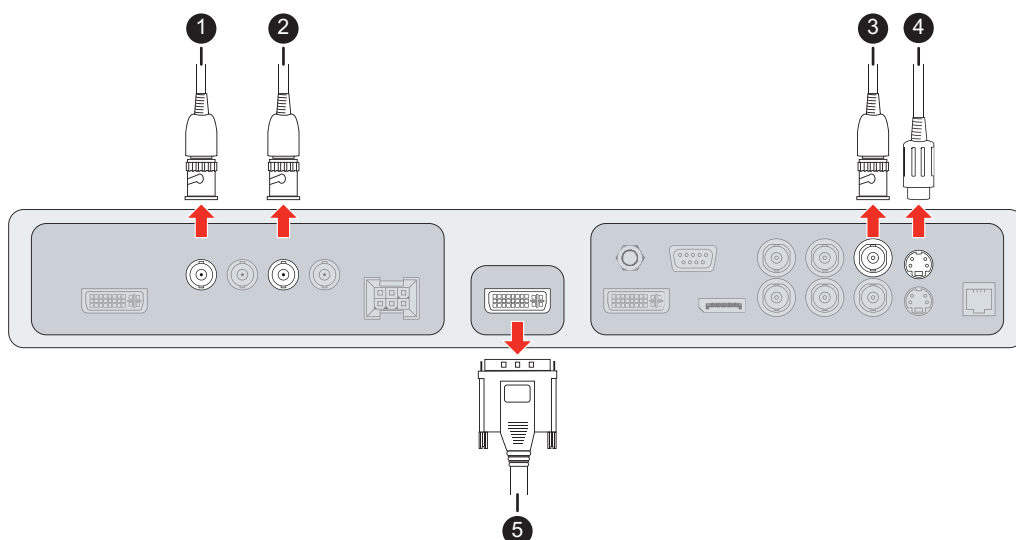

Image 3-7

3. Display installation

3.4.3 MDSC-2324 MNA version

To connect the video outputs

1. Connect one or more of the available video sink(s) to the corresponding video outputs using the appropriate video cable(s).
 - CVBS: 1
 - S-Video: 2
 - DVI: 3 (to be configured in OSD menu)
 - Nexxis: 3 (to be configured in OSD menu)

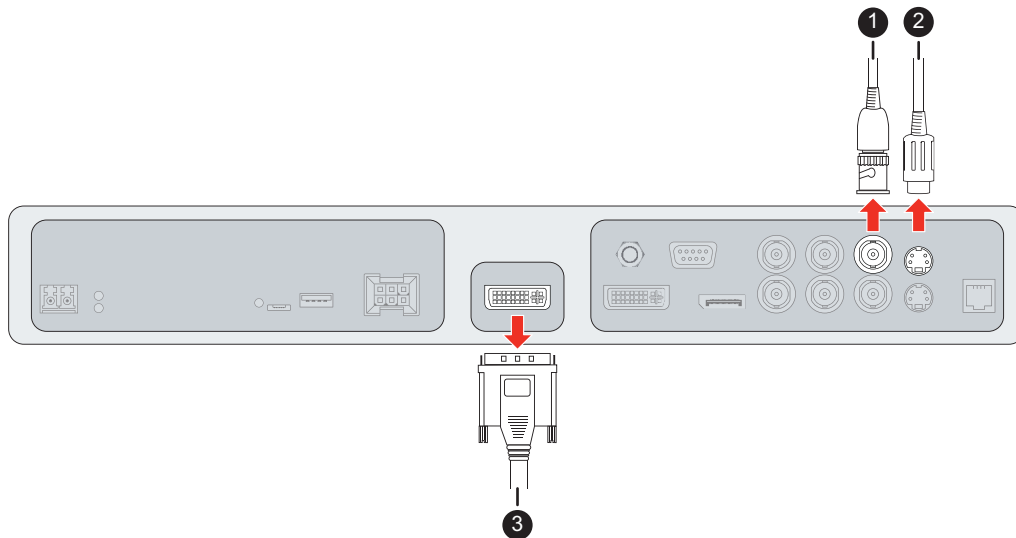

Image 3-8

3.5 Nexxis OR

Overview

Connecting your MDSC-2324 to Barco's Nexxis OR system allows you to distribute video, graphics, audio and computer data over the IP network, in raw uncompressed format, inside the operating room and even between surgical suites.

To connect your MDSC-2324 to Barco's Nexxis OR system, connect the 10Gb Ethernet interface to your Nexxis switch. More info about Nexxis OR and how to configure the MDSC-2324 in your network is available in the dedicated user guides. Please visit www.barco.com to obtain these user guides.



Nexxis OR is only available on the MDSC-2324 MNA version.

3.6 Power supply connection

To connect the power supply

1. Connect the supplied external DC power supply unit to the +24 VDC power input of your display.
2. Plug the other end of the external DC power supply into a **grounded** power outlet by means of the proper power cord delivered in the packaging.

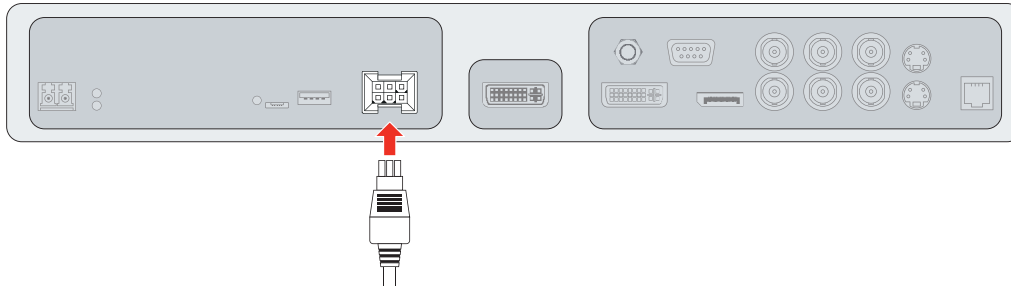

Image 3-9



CAUTION: To avoid risk of electric shock, the external DC power supply must be connected to a mains with protective earth. The ground connection on the display's DC power input connector has no protective earth function. The MDSC-2324 display protective earth connection is provided via a dedicate pin (see next steps).

Protective earth

Earth the MDSC-2324 by connecting the protective earth pin to a grounded outlet by means of a yellow/green AWG18 wire (maximum admitted cable length according to national regulation requirements).

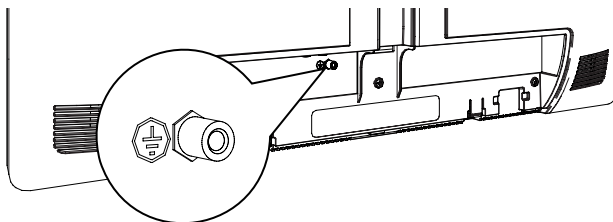

Image 3-10



CAUTION: The display must be earthed.

Potential equalization

When potential equalization between the display and other devices is required then connect the potential equalization pin (POAG: DIN42801) to the potential equalization terminal of the equipment.

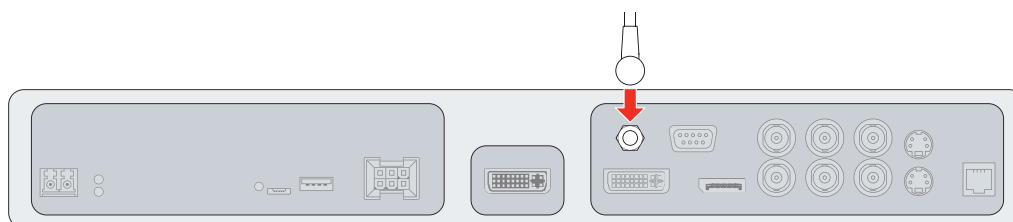

Image 3-11

3.7 Cable routing

To route the cables

1. For displays mounted to a VESA arm with internal cable routing provisions, route all cables through the cable routing channel, then reinstall the connector compartment cover.

3. Display installation

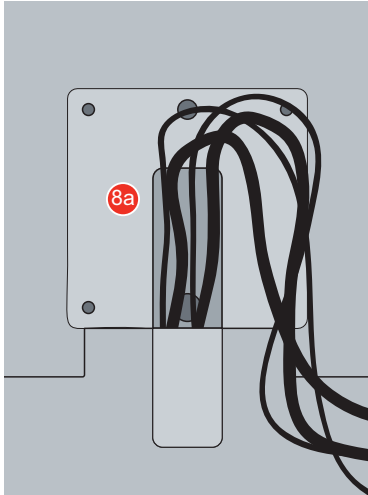

Image 3-12

Or,

For all other mounting options, remove the cable routing channel expansion clip from the connector compartment cover and route all cables through it while reinstalling the cover.

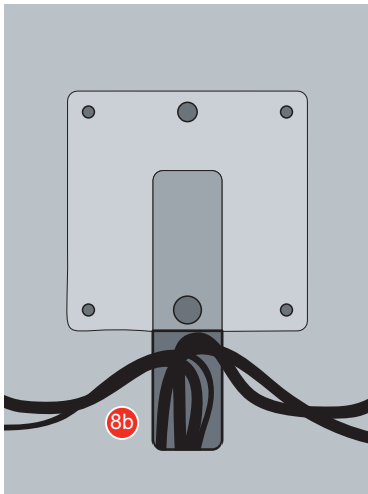

Image 3-13



WARNING: When the display is assembled in the medical system, take care of the fixation of all cables, to avoid unwanted detachment.

4. DAILY OPERATION

4.1 Keyboard activation/deactivation

To activate the keyboard:

In order to avoid unwanted or accidental activation of the OSD keyboard, a lock/unlock mechanism has been implemented. This means that, before the OSD keyboard can be used to change any of the setting of the display, it needs to be unlocked. Two options are available to activate the keyboard:

1. Option 1: Swipe a finger from the power button zone to the left for about 12 cm.
2. Option 2: Press the Power On/Off key for 3 seconds and release it within the next 2 seconds.

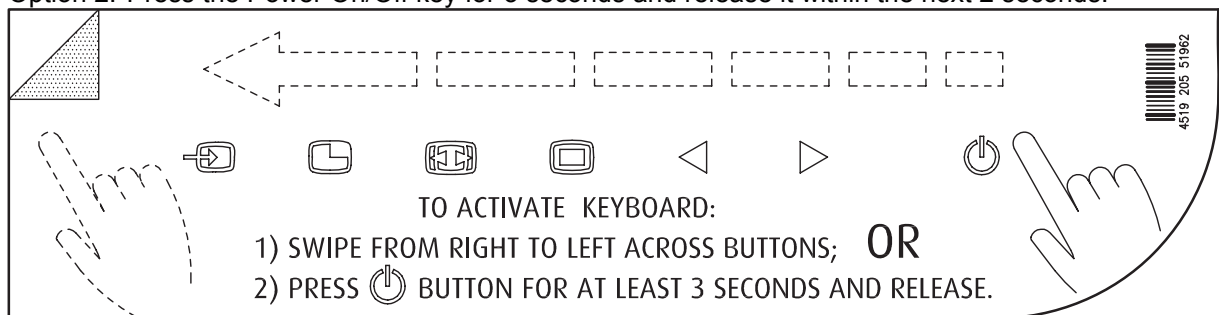

As a result, the keys will light up and are now available for further actions. However, if no further actions are taken within the following 10 seconds, the key indicator lights will dim and will be locked again.

To deactivate the keyboard:

The keyboard will automatically lock after 10 seconds of inactivity, except while navigating the OSD menu, during which it remains unlocked.

As a result, its backlight switches off to indicate that the keyboard is locked.

Keyboard backlight 'Always on' mode

When used with keyboard Backlight 'Always on' (factory setting is 'On with touch'), the lock / unlock status of the keyboard cannot be linked to the on / off status of the keyboard backlight (the backlight is always on in this mode, except when in Power Save of Soft Off).

Therefore, the keyboard lock status is being signaled by a slow blinking of the keyboard backlight between on and off at a rate of one cycle per second. The Keyboard will automatically lock after 10 minutes.

	Keyboard backlight 'On with touch' (Factory default)	Keyboard backlight 'Always on' (Custom setting)
Keyboard Locked	Keyboard backlight is off and remains off while a key is pressed.	Keyboard backlight is on and starts slowly blinking between on and off while key is pressed.
Keyboard Unlocked	Keyboard backlight is on and dims slightly while a key is pressed.	Keyboard backlight is on and dims slightly while a key is pressed.
Keyboard AUTO-lock Timeout	10 seconds	10 minutes

4.2 Keyboard backlight

About the keyboard backlight

By default only the stand-by key is visible. After keyboard activation (see "OSD menu activation", page 23), the backlight of all keys is switched on for a few seconds. When you touch any of these keys again while the backlight is on, the function of the key is executed. If no further action is taken within the time-out, the keyboard backlight is switched off again.



The keyboard backlight auto-dim function can be disabled in the OSD menu so that the keyboard backlight is always on (*Keyboard Backlight*).

4.3 On/Off switching

To switch on your display:

1. Activate the power supply through the switch located on the external power supply.
2. While your display is off, press and hold the stand-by key  for approximately 3 seconds (or until the keyboard backlight stops blinking).



To minimize the power consumption, also the external power supply has to be switched off.

To switch off your display:

1. While your display is switched on, unlock the keyboard see "OSD menu activation", page 23.
2. Press and hold the stand-by key  for approximately 3 seconds (or until the keyboard backlight stops blinking and switches off).



While pressing the stand-by key to switch off the display, the front key illumination will blink.

4.4 Power led status

About the the power led status

The behavior of the power led shows the status of the unit:

- No led visible: the status of the unit is hard OFF (the switch of the power supply is OFF)
- Led is fading between on and off: the status of the unit is soft OFF (when pushing the standby button, the unit is on or off)
- Led is full orange: the unit is in power save mode (no signal & power save mode enabled)
- Led is blinking green/orange: the unit is in searching mode (looking for a signal)
- Led is full green: the unit has an image on the screen.

4.5 OSD menu activation

To activate the OSD menu

1. If not already done so, switch on the display by pressing and holding the stand-by key \odot for approximately 3 seconds.
2. Switch on the front key illumination by activating the keyboard (see "Keyboard activation/deactivation", page 21).
3. Touch the Menu/Enter key \blacksquare .

As a result, the OSD main menu comes up in the bottom right corner of the screen. If no further actions are taken within the following 30 seconds, the OSD menu will disappear again.



The time-out of the OSD menu automatic close function can be adjusted or disabled in the OSD menu (*OSD Time-out*).



The OSD menu position can be adjusted in the OSD menu (*OSD Hor. Pos.* and *OSD Vert. Pos.*).

4.6 OSD menu navigation

OSD menu structure explained

Below is an example of the OSD menu structure:

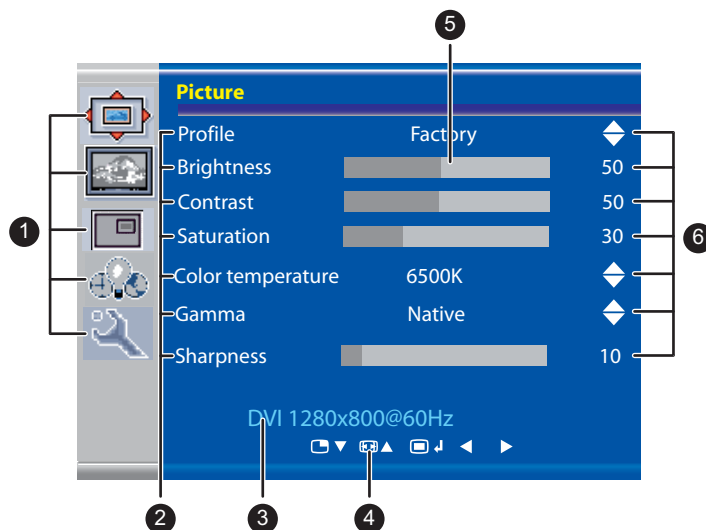

Image 4-1

①	Menu
②	Sub-menu
③	Status bar
④	Legend (shows the functionality associated to each keyboard key)
⑤	Selector/Slider
⑥	Item

To navigate through the OSD menu



Image 4-2

- Press the key to open the OSD menu.
- Use the or key to scroll to the desired menu page.
- When the desired Menu page is highlighted, press the key to select the top menu item that will be highlighted.
- Use the or keys to move to other Menu Items, then press the key to select it.
- If the selected menu item is controlled by a slider use the or keys to adjust the item value, then press the key to confirm.
- If the selected menu item is a multiple choices menu use the or keys to select the desired option then press the key to confirm.
- Press again or key to select other Menu items or exit from the Menu page by pressing the key.

4.7 Shortkey functions

About shortkey functions

The concept of shortkey functions is to present a selection of commonly used functions immediately available without the need to navigate through the OSD Menu.

The different available shortkey functions are:

- Main source selection
- Multi-image configuration
- Zoom factor selection
- Brightness adjustment



Unlike the extended keyboard functions (described in next chapter), the shortkey functionality is immediately available without the need to first enable this in the OSD menu.



When the extended keyboard functionality is enabled, all the shortkey functions described below (except for the brightness adjustment), will no longer be available and will be replaced by the corresponding extended keyboard functions described in the next chapter.

Overview of shortkeys

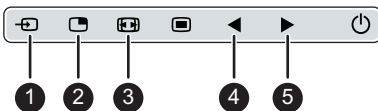

Image 4-3

1	Main source selection
2	Multi-image configuration
3	Zoom factor selection
4	Brightness decrease
5	Brightness increase

4.7.1 Main source selection

To quickly select the main source

1. Use the Input selection key (⏏) to scroll through all the possible input signals to select the main input source.



When the extended keyboard functionality is enabled, the shortcut functions will no longer be available and will be replaced by the corresponding extended keyboard functions described in the next chapter.

4.7.2 Multi-image configuration

To quickly select the multi-image configuration

1. Use the PiP selection key (⏏) to scroll through all possible configurations of Picture-in-Picture (PiP) and Side-by-Side (SbS).

The different PiP/SbS options are:

- Small PiP: 30% of Primary height in top-right corner
- Large PiP: 50% of Primary height in top-right corner
- Side-by-Side: Primary and Secondary input of equal height



Only a subset of multi-image configuration settings is available via this shortcut function. More multi-image configuration settings can be selected in the OSD menus.



When the extended keyboard functionality is enabled, this shortcut functions will no longer be available and will be replaced by the corresponding extended keyboard functions described in the next chapter.

4.7.3 Zoom factor selection

To quickly select the zoom factor

1. Use the Image zoom key (⏏) to select one of the available zoom factors.



When the extended keyboard functionality is enabled, the shortcut functions will no longer be available and will be replaced by the corresponding extended keyboard functions described in the next chapter.

4.7.4 Brightness adjustment

To quickly adjust the brightness

1. While no OSD Menu is on the screen, press the Brightness decrease (◀) or Brightness increase (▶) keys to adjust the brightness as desired.



Image 4-4



When the extended keyboard functionality is enabled, this shortkey functions will remain available.

4.8 Extended keyboard functions

About extended keyboard functions

The concept of the extended keyboard is to present a large selection of functions immediately available to the user without the need to navigate through the OSD Menu.

Once enabled through dedicated OSD menu function, by simply pressing one of the first 3 keys on the left the user is presented with a list of new selections displayed on screen; the new choices can be selected by using each of the key just below the OSD text.

If two options are available for one key, the first key press will select the upper option, a second press selects the lower option.

The different available extended keyboard functions are:

- Main source selection
- Second source selection
- Multi-image configuration
- Color temperature selection
- Image size selection
- Zoom factor selection



Unlike the shortkey functions (described before), the extended keyboard functionality must be first enabled in the OSD menu before you can make use of it. Please refer to the dedicated section in this manual for more details on how to enable/disable the extended keyboard functions.



When the extended keyboard functionality is enabled, all the shortkey functions described in previous chapter (except for the brightness adjustment), will no longer be available and will be replaced by the corresponding extended keyboard functions described below.

Overview of extended keyboard



Image 4-5

1	Main source selection
	Second source selection
2	Multi-image configuration
3	Color temperature selection
	Image size selection
	Zoom factor selection

4.8.1 Main source selection

To quickly select the main source

1. While no OSD Menu is on the screen, press the Input selection key (⏏) to bring up the main source quick selection menu.
2. Toggle the available main source options by pressing the key corresponding to the desired option.
If two options are available for one key, the first key press will select the upper option, a second press selects the lower option.
The current selection is marked in red.
3. Press the stand-by key (⏻) to confirm your choice and exit the main source quick selection menu.

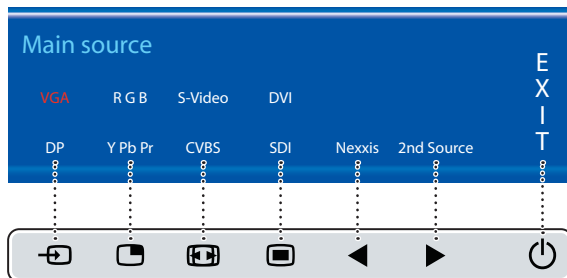

Image 4-6

4.8.2 Second source selection

To quickly select the second source

1. While no OSD Menu is on the screen, press the Input selection key (⏏) to bring up the main source quick selection menu.
2. Press the ► key to switch to the 2nd source quick selection menu.
3. Toggle the available second source options by pressing the key corresponding to the desired option.
If two options are available for one key, the first key press will select the upper option, a second press selects the lower option.
The current selection is marked in red.
4. Press the stand-by key (⏻) to confirm your choice and exit the second source quick selection menu.

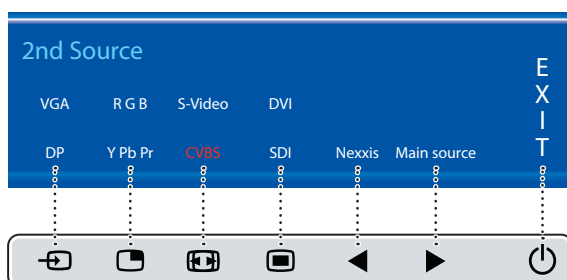

Image 4-7

4.8.3 Multi-image configuration

To quickly select the multi-image configuration

1. While no OSD Menu is on the screen, press the PiP selection key (⏏) to bring up the multi-image configuration quick selection menu.
2. Toggle the available multi-image configurations by pressing the key corresponding to the desired option.
The current selection is marked in red.
3. Press the stand-by key (⏻) to confirm your choice and exit the multi-image configuration quick selection menu.

4. Daily operation

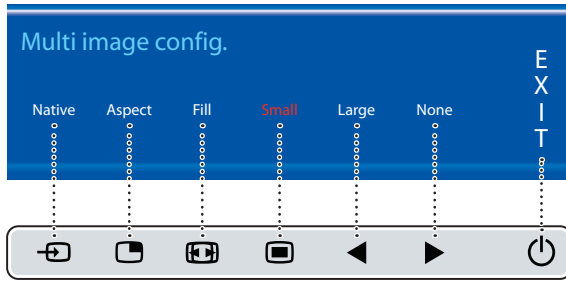

Image 4-8

4.8.4 Common Functions: Transfer function selection

To quickly select the transfer function

1. While no OSD Menu is on the screen, press the Image zoom key (⏏) to bring up the common functions quick selection menu.
2. Toggle the available transfer function settings by pressing the key corresponding to the desired option. The current selection is marked in red.
3. Press the stand-by key (⏏) to confirm your choice and exit the common functions quick selection menu.

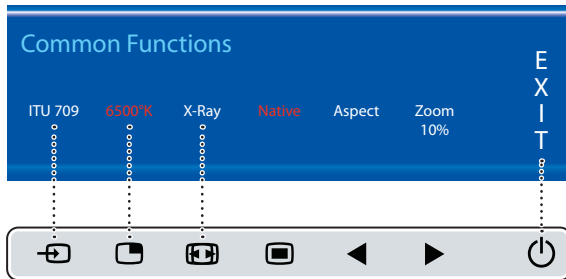

Image 4-9

Note: Only a subset of transfer function settings is available via this quick selection menu. More transfer function settings can be selected in the OSD menus.

4.8.5 Common Functions: Image size selection

To quickly select the image size

1. While no OSD Menu is on the screen, press the Image zoom key (⏏) to bring up the common functions quick selection menu.
2. Toggle the available image size settings by pressing the key corresponding to the desired option. The current selection is marked in red.
3. Press the stand-by key (⏏) to confirm your choice and exit the common functions quick selection menu.

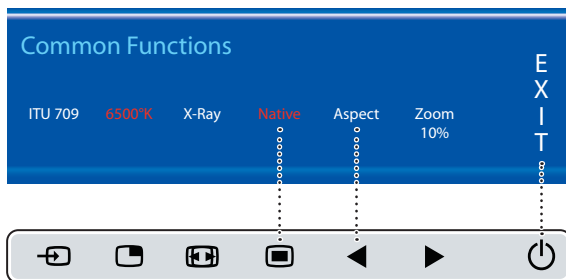

Image 4-10

Note: Only a subset of image size settings is available via this quick selection menu. More image size settings can be selected in the OSD menus.

4.8.6 Common Functions: Zoom factor selection

To quickly select the zoom factor

1. While no OSD Menu is on the screen, press the Image zoom key (🔍) to bring up the common functions quick selection menu.
2. Toggle the available zoom factors by repeatedly pressing the ▶ key until the desired zoom factor is shown.
3. Press the stand-by key (⏻) to confirm your choice and exit the common functions quick selection menu.

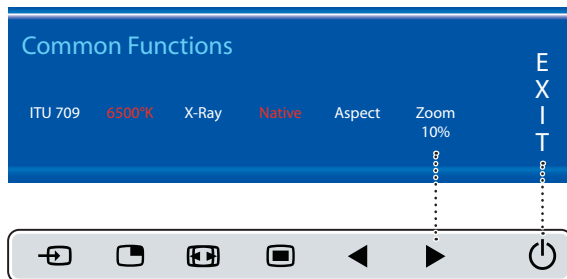

Image 4-11

4.9 Menu locking/unlocking

To lock/unlock the menu

The keyboard can be locked from the Menu to avoid unwanted access to OSD functions. When the keyboard is LOCKED only the OSD Menu key (⌂) and the Stand-by key (⏻) are active. When the Menu OSD key is pressed the *Menu Locked* window appears.

1. To unlock the keyboard the following sequence of keys need to be pressed:

◀, ▶, ▶, ⌂

Each time a key is pressed an asterisk is shown in the square boxes.

After pressing the fourth key, if the sequence is correct, the main OSD menu is activated. To unlock the keyboard permanently the specific OSD function is required.

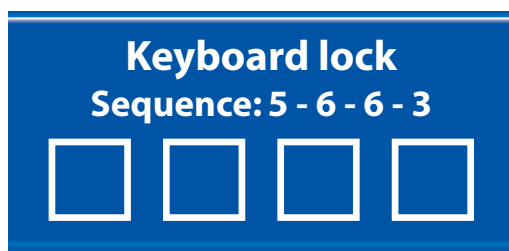

Image 4-12

4. Daily operation

5. ADVANCED OPERATION

5.1 OSD picture menu

Overview

- Profile
- Brightness
- Contrast
- Saturation
- Color temperature
- Gamma
- Sharpness

5.1.1 Profile

About profiles

To select a profile means to load a set of predefined video parameters like Brightness, Contrast, Saturation, Input selection (Primary & Secondary), Multi-image layout selection, etc.

The user can modify the default video parameters associated to each profile and save the new parameters setting under the User 1, User 2 or User 3 profile. The Factory and X Ray profiles can be temporarily modified, but the factory default can't be overwritten and can always be recalled through the recall profile menu item.

The available profiles for your display are:

- Factory
- X Ray
- User 1
- User 2
- User 3

To select a profile

1. Bring up the OSD main menu.
2. Navigate to the *Picture* menu.
3. Enter the *Profile* submenu.
4. Select one of the available profiles and confirm.

5.1.2 Brightness

To adjust the brightness level

1. Bring up the OSD main menu.
2. Navigate to the *Picture* menu.
3. Enter the *Brightness* submenu.
The command bar *Brightness* is highlighted.
4. Set the brightness level as desired and confirm.



The selected brightness is maintained at a constant level by the automatic backlight stabilization function.



The brightness level can also be adjusted through a shortcut function.



Brightness level is adjusted by controlling the backlight illumination only.

5.1.3 Contrast

To adjust the contrast level

1. Bring up the OSD main menu.
2. Navigate to the *Picture* menu.
3. Enter the *Contrast* submenu.
The command bar *Contrast* is highlighted.
4. Set the contrast level as desired and confirm.

5.1.4 Saturation

To adjust the saturation level

1. Bring up the OSD main menu.
2. Navigate to the *Picture* menu.
3. Enter the *Saturation* submenu.
The command bar *Saturation* is highlighted.
4. Set the saturation level as desired and confirm.

5.1.5 Color temperature

About color temperature presets

The available color temperature presets for your display are:

- 5600K
- 6500K
- 7600K
- 9300K
- ITU 709
- Native
- User



Factory calibration – White point:

The White Color points associated with the Color Temperature: 5600K, 6500K, 7600K or 9300K are factory calibrated with a consequent reduction of the maximum luminance compared to Native Color Temperature.



Factory calibration – Color space:

When ITU 709 is selected, the White Color point and the RGB color primaries are adjusted according to the target HDTV / sRGB color space defined in the ITU-709 recommendation. RGB primary calibration is performed within the physical limitation of the LCD panel used.



Only in case the User preset has been selected it is possible to get access to the color regulation commands described hereafter.

To select a color temperature preset

1. Bring up the OSD main menu.
2. Navigate to the *Picture* menu.
3. Enter the *Color Temperature* submenu.
4. Select one of the available color temperature presets and confirm.

Note: If you selected the User color temperature preset, a new menu will be displayed allowing you to manually adjust the gain and offset of red, green and blue.

5.1.6 Gamma

About gamma presets

The available gamma presets for your display are:

- 1.8
- 2.0
- 2.2
- 2.4
- Native (no correction curve is applied)
- X-ray (grayscale levels are following closely the DICOM curve)

To select a gamma preset

1. Bring up the OSD main menu.
2. Navigate to the *Picture* menu.
3. Enter the *Gamma* submenu.
4. Select one of the available gamma presets and confirm.

5.1.7 Sharpness

To adjust the sharpness level

1. Bring up the OSD main menu.
2. Navigate to the *Picture* menu.

3. Enter the *Sharpness* submenu.
The command bar *Sharpness* is highlighted.
4. Set the sharpness level as desired and confirm.

5.2 Picture Advanced menu

Overview

- Black Level
- Smart Video
- Image Position
- Auto Adjustment
- Phase
- Clock/Line

5.2.1 Black Level

About black level

This command allows to add or subtract an offset to the input video signal (available only on video formats).

To adjust the black level

1. Bring up the OSD main menu.
2. Navigate to the *Picture advanced* menu.
3. Enter the *Black Level* submenu.
The command bar *Black Level* is highlighted.
4. Set the black level as desired and confirm.

5.2.2 Smart Video

About Smart Video

This function allows to reduce the video latency in the monitor if its frame rate is in the range of 50 - 60 Hz. To achieve a minimum latency select one of the surgical modes.

The available Smart Video presets for your display are:

- Diagnostic (best picture quality)
- Surgical (low latency)
- Surgical 1 (low latency, optimized for fast moving images)

About latency

The video latency is defined as the delay between the monitor input video level transition time to the corresponding light output transition on the screen top-left corner.

The maximum latency in Surgical mode is less than 1 Video Frame period for all the monitor electrical inputs while in Diagnostic mode the latency is between 1 to 2 Video Frame periods excluding S-Video, CVBS analog and SFP optical (MNA versions) inputs which have an additional delay of maximum 1 Video Frame period.

To select a Smart Video preset

1. Bring up the OSD main menu.
2. Navigate to the *Picture advanced* menu.





3. Enter the *Smart Video* submenu.
4. Select one of the available Smart Video presets and confirm.

5.2.3 Image Position



This menu item is only available when VGA input is connected.

To adjust the image position

1. Bring up the OSD main menu.
2. Navigate to the *Picture advanced* menu.
3. Enter the *Image Position* submenu.
A small OSD menu will be activated indicating the horizontal and vertical image position offset.
4. Use the  and  keys to move the picture up and down.
5. Use the  and  keys to move the picture left and right.
6. When finished, use the  key to exit from the small OSD menu.

5.2.4 Auto Adjustment



This menu item is only available when VGA input is connected.

About auto adjustment

When auto adjustment is activated, the phase and clock per line parameters are automatically adjusted.

To activate auto adjustment

1. Bring up the OSD main menu.
2. Navigate to the *Picture advanced* menu.
3. Enter the *Auto Adjustment* submenu.
The automatic picture adjustment is activated: the phase and clock per line parameters are automatically adjusted.

5.2.5 Phase



This menu item is only available when VGA input is connected.

About phase

If the result of the Auto Adjustment procedure described above isn't satisfactory, the Phase can be manually adjusted by following this procedure.

To manually adjust the phase

1. Bring up the OSD main menu.
2. Navigate to the *Picture advanced* menu.

5. Advanced operation

3. Enter the *Phase* submenu.
The command bar *Phase* is highlighted.
4. Set the phase as desired and confirm.

5.2.6 Clock/Line



This menu item is only available when VGA input is connected.

About clock/line

If the result of the Auto Adjustment procedure described above isn't satisfactory, the Clock/Line can be manually adjusted by following this procedure.

To manually adjust the phase

1. Bring up the OSD main menu.
2. Navigate to the *Picture advanced* menu.
3. Enter the *Clock/Line* submenu.
The command bar *Clock/Line* is highlighted.
4. Set the clock/line as desired and confirm.

5.3 Display Format menu

Overview

- Main Source (Primary Source)
- Component Mode
- Zoom
- Image Size
- 2nd Picture Mode
- 2nd Picture Source
- 2nd Picture Position
- Picture Swap

5.3.1 Main Source (Primary Source)

About main sources

The available main sources for your display are:

- Auto Search
- Composite
- S-Video
- Component
- PC Analog
- DVI 1
- DVI 2
- SDI 1
- SDI 2
- Nexxis
- DisplayPort



Available main sources dependent on display model.



The main source can also be selected through a shortcut function or via the extended keyboard functionality.

To select the main source

1. Bring up the OSD main menu.
2. Navigate to the *Display Format* menu.
3. Enter the *Main Source* submenu.
4. Select one of the available main source and confirm.

Note: *If you selected the Auto Search preset, the display will automatically detect the connected signal.*

5.3.2 Component Mode

About component modes

The available component modes for your display are:

- YPbPr
- RGB

To select the component mode

1. Bring up the OSD main menu.
2. Navigate to the *Display Format* menu.
3. Enter the *Component Mode* submenu.
4. Select one of the available component modes and confirm.

5.3.3 Zoom

About zoom

The available zoom factors for your display are:

5. Advanced operation

- None
- 10%
- 20%
- 30%
- 40%
- 50%



The zoom factor can also be selected through a shortcutkey function or via the extended keyboard functionality.

To select a zoom factor

1. Bring up the OSD main menu.
2. Navigate to the *Display Format* menu.
3. Enter the *Zoom* submenu.
4. Select one of the available zoom factors and confirm.

5.3.4 Image Size

About image size

The available image sizes for your display are:

- Full Screen (fill the screen, image aspect-ratio can be altered)
- Aspect (fill the screen on largest dimension, no modification in image aspect-ratio)
- Native (input pixel to LCD pixel mapping, no scaling)



In Aspect and Native, the image may be displayed with black bars on top/bottom or left/right.



The image size can also be selected via the extended keyboard functionality.

To select the image size

1. Bring up the OSD main menu.
2. Navigate to the *Display Format* menu.
3. Enter the *Image Size* submenu.
4. Select one of the available image sizes and confirm.

5.3.5 2nd Picture Mode

About 2nd picture modes

The available 2nd picture modes for your display are:

- Off
- Small PiP: 30% of Primary height in top-right corner
- Large PiP: 50% of Primary height in top-right corner
- Side-by-Side: Primary and Secondary input of equal height
- S.b.S. Native: The 2 images are displayed with input pixel to LCD pixel mapping, with image crop if necessary
- S.b.S. Fill: Both images scaled to fill half of the screen, with image crop if necessary



The 2nd picture mode (multi-image configuration) can also be selected via the extended keyboard functionality.

To select the 2nd picture mode

1. Bring up the OSD main menu.
2. Navigate to the *Display Format* menu.
3. Enter the *2nd Picture Mode* submenu.
4. Select one of the available 2nd picture modes and confirm.



Multi image in Full HD available with any combination of input sources.

Multi image in SD video available with any combination of input source except Composite & S-video.

5.3.6 2nd Picture Source

About 2nd picture sources

The available 2nd picture sources for your display are:

- Auto Search
- Composite
- S-Video
- Component
- PC Analog
- DVI 1
- DVI 2
- SDI 1
- SDI 2
- Nexxis
- DisplayPort



The 2nd picture source can also be selected via the extended keyboard functionality.



Independent Transfer Function:

Gamma and Color temperature for the 2nd Picture Source are always set to Native and 6500K independently from the Transfer Function applied to the Main Picture Source. For a perfect visualization of a X-ray image please select the X-ray input signal as Main picture and, if needed, the Video image as 2nd picture.

To select the 2nd picture source

1. Bring up the OSD main menu.
2. Navigate to the *Display Format* menu.
3. Enter the *2nd Picture Source* submenu.
4. Select one of the available 2nd picture sources and confirm.

5.3.7 2nd Picture Position

About 2nd picture positions

The available 2nd picture positions for your display are:

- Top Right
- Top Left
- Bottom Right
- Bottom Left

To select the 2nd picture position

1. Bring up the OSD main menu.
2. Navigate to the *Display Format* menu.
3. Enter the *2nd Picture Position* submenu.
4. Select one of the available 2nd picture positions and confirm.

5.3.8 Picture Swap

About picture swapping

To swap pictures means to exchange (swap) main and 2nd picture.

To swap pictures

1. Bring up the OSD main menu.
2. Navigate to the *Display Format* menu.
3. Enter the *Picture Swap* submenu.
4. Select the desired setting and confirm.

5.4 Configuration menu

Overview

- Information
- Language
- Failover mode
- Extended keyboard
- OSD setting
- Recall Profile
- Save Profile

5.4.1 Information

About information

The available information items for your display are:

- Model (commercial type identification)
- Operating Hours (backlight operation hours)
- Firmware Release (firmware identification)
- Hardware Version (main board identification)
- Option SDI (SDI module identification)
- Serial Number: ANxxxxxxxxxxxx

To access information

1. Bring up the OSD main menu.
2. Navigate to the *Configuration* menu.
3. Enter the *Information* submenu.
The different information items are shown.

5.4.2 Language

About languages

The available languages for your display OSD menu are:

- English
- Français
- Deutsch
- Español
- Italiano

To select the language

1. Bring up the OSD main menu.
2. Navigate to the *Configuration* menu.
3. Enter the *Language* submenu.
4. Select one of the available languages and confirm.

5.4.3 Failover mode

About failover mode

This function allows the automatic switch to a defined Backup source when the Main input signal is missing.

The display will automatically restore the Main input as soon as the signal is back.

The Backup source is the input selected as "2nd Picture Source" with "2nd Picture Mode" = "Off".

This Main & Backup combination is stored at the moment the function "Failover mode" is set to "Enabled".

Failover Mode is not selectable when either the Main Source or the 2nd Picture Source is set to "Autosearch".



Failover mode is automatically disabled when either the Main Source or the 2nd Picture Source is changed. A warning message "Failover off" appears on the screen for a few seconds.

Returning to the original Main & Backup combination will automatically re-enable the Failover feature.



For the MNA version only, Failover mode will be activated up to 12 seconds after the Nexxis signal becomes unavailable (delay required to allow a Nexxis layout change).

To enable/disable failover mode

1. Bring up the OSD main menu.
2. Navigate to the *Configuration* menu.
3. Enter the *Failover mode* submenu.
4. Enable/Disable failover mode as desired and confirm.

5.4.4 Extended keyboard

About the extended keyboard

The concept of the extended keyboard is to present a large selection of functions immediately available to the user without the need to navigate through the OSD Menu.

Once enabled, by simply pressing one of the first 3 keys on the left the user is presented with a list of new selections displayed on screen; the new choices can be selected by using each of the key just below the OSD text.

If two options are available for one key, the first key press will select the upper option, a second press selects the lower option.

The different available extended keyboard functions are:

- Main source selection
- Second source selection
- Multi-image configuration
- Color temperature selection
- Image size selection
- Zoom factor selection

To enable/disable the extended keyboard

1. Bring up the OSD main menu.

2. Navigate to the *Configuration* menu.
3. Enter the *Extended keyboard* submenu.
4. Enable/Disable the extended keyboard as desired and confirm.

5.4.5 OSD setting

5.4.5.1 OSD Horizontal Position

To adjust the OSD horizontal position

1. Bring up the OSD main menu.
2. Navigate to the *Configuration* menu.
3. Enter the *OSD setting* submenu.
4. Select *OSD Hor. Pos.*
The command bar *OSD Hor. Pos.* is highlighted.
5. Set the OSD horizontal position as desired and confirm.

5.4.5.2 OSD Vertical Position

To adjust the OSD vertical position

1. Bring up the OSD main menu.
2. Navigate to the *Configuration* menu.
3. Enter the *OSD setting* submenu.
4. Select *OSD Ver. Pos.*
The command bar *OSD Ver. Pos.* is highlighted.
5. Set the OSD vertical position as desired and confirm.

5.4.5.3 OSD Time-out

About OSD time-out

The OSD menu can automatically close after a certain time of inactivity after the last selection was made.
The available OSD time-out values for your display are:

- 10 Sec.
- 20 Sec.
- 30 Sec.
- 60 Sec.
- Disabled (=5 minutes)

To adjust the OSD time-out

1. Bring up the OSD main menu.
2. Navigate to the *Configuration* menu.
3. Enter the *OSD setting* submenu.
4. Select *OSD Time-out*
5. Select one of the available OSD time-out values and confirm.

5.4.6 Recall Profile

About recalling profiles

To recall a profile means to restore the default factory settings (Factory and X Ray profiles) or recall the user defined profiles.

The available profiles to recall from your display are:

- Factory
- X Ray
- User 1
- User 2
- User 3

To recall a profile

1. Bring up the OSD main menu.
2. Navigate to the *Configuration* menu.
3. Enter the *Recall Profile* submenu.
4. Select one of the available profiles to recall and confirm.

5.4.7 Save Profile

About saving profiles

The user can modify the default video parameters associated to each profile and save the new parameter settings under the User 1, User 2 or User 3 profile. The Factory and X Ray profiles can be modified, but the factory default can't be overwritten and can always be recalled through the recall profile menu item.

The available profiles to save in your display are:

- User 1
- User 2
- User 3

To save a profile

1. Bring up the OSD main menu.
2. Navigate to the *Configuration* menu.
3. Enter the *Save Profile* submenu.
4. Select one of the available profiles to save and confirm.

5.5 System menu

Overview

- Power on DVI 1
- Power on DVI 2
- DVI Output
- Keyboard lock
- Keyboard backlight
- Power Saving

5.5.1 Power on DVI 1

About power on DVI 1

This setting allows you to select the pin of DVI port 1 connector on which the +5V DC supply is applied.

The available options are:

- Disabled
- +5V on Pin 14
- +5V on Pin 16

To select the power on DVI 1

1. Bring up the OSD main menu.
2. Navigate to the *System* menu.
3. Enter the *Power on DVI 1* submenu.
4. Select one of the available options and confirm.

5.5.2 Power on DVI 2

About power on DVI 2

This setting allows you to select the pin of DVI port 2 connector on which the +5V DC supply is applied.

The available options are:

- Disabled
- +5V on Pin 14
- +5V on Pin 16

To select the power on DVI 2

1. Bring up the OSD main menu.
2. Navigate to the *System* menu.
3. Enter the *Power on DVI 2* submenu.
4. Select one of the available options and confirm.

5.5.3 DVI Output

About DVI output

This setting allows you to select which digital input to replicate on the DVI out connector. Depending on the display version and the main and second picture selection, the options for DVI Output will be different. The following tables show the different options for each display version.



This feature is subject to restrictions in case of Multi-image (PiP, SbS).

MDSC-2324 LED version

Main picture	2nd picture	DVI Output option	
		"DVI"	"None"
DVI	DVI	Yes	Yes
	SDI	Yes	Yes
	Other	Yes	Yes

5. Advanced operation

Main picture	2nd picture	DVI Output option	
		"DVI"	"None"
SDI	DVI	Yes	Yes
	SDI	Yes	Yes
	Other	Yes	Yes
Other	DVI	Yes	Yes
	SDI	Yes	Yes
	Other	Yes	Yes

MDSC-2324 DDI version

Main picture	2nd picture	DVI Output option		
		"DVI 1"	"DVI 2"	"None"
DVI 1	DVI 1	Yes	Yes	Yes
	DVI 2	No	Yes	Yes
	SDI 1	Yes	No	Yes
	SDI 2	Yes	No	Yes
	Other	Yes	Yes	Yes
DVI 2	DVI 1	No	Yes	Yes
	DVI 2	No	Yes	Yes
	SDI 1	No	Yes	Yes
	SDI 2	No	Yes	Yes
	Other	No	Yes	Yes
SDI 1	DVI 1	Yes	No	Yes
	DVI 2	No	Yes	Yes
	SDI 1	Yes	Yes	Yes
	SDI 2	No	No	Yes
	Other	Yes	Yes	Yes
SDI 2	DVI 1	Yes	No	Yes
	DVI 2	No	Yes	Yes
	SDI 1	No	No	Yes
	SDI 2	Yes	Yes	Yes
	Other	Yes	Yes	Yes
Other	DVI 1	Yes	Yes	Yes
	DVI 2	No	Yes	Yes
	SDI 1	Yes	Yes	Yes
	SDI 2	Yes	Yes	Yes
	Other	Yes	Yes	Yes

MDSC-2324 MNA version

Main picture	2nd picture	DVI Output option		
		"DVI"	"Nexxis"	"None"
DVI	DVI	Yes	Yes	Yes
	Nexxis	Yes	No	Yes
	Other	Yes	Yes	Yes

Main picture	2nd picture	DVI Output option		
		"DVI"	"Nexxis"	"None"
Nexxis	DVI	Yes	No	Yes
	Nexxis	Yes	Yes	Yes
	Other	Yes	Yes	Yes
Other	DVI	Yes	Yes	Yes
	Nexxis	Yes	Yes	Yes
	Other	Yes	Yes	Yes

To select the DVI output

1. Bring up the OSD main menu.
2. Navigate to the *System* menu.
3. Enter the *DVI output* submenu.
4. Select one of the available options and confirm.

5.5.4 Keyboard lock

About keyboard locking

This setting allows you to disable the keyboard functionality and avoid unwanted access to the OSD functions.

Accessing the OSD menu is only possible after pressing a sequence of keys. Please refer to the dedicated section for more details (Keyboard locking/unlocking).

To enable/disable keyboard locking

1. Bring up the OSD main menu.
2. Navigate to the *System* menu.
3. Enter the *Keyboard Lock* submenu.
4. Enable/Disable keyboard locking as desired and confirm.

5.5.5 Keyboard backlight

About the keyboard backlight

By default, after lighting up, the keyboard backlight will dim again if no further actions are taken within the following 5 seconds. However, this behavior can be changed so that the keyboard backlight is always on.

To adjust the keyboard backlight

1. Bring up the OSD main menu.
2. Navigate to the *System* menu.
3. Enter the *Keyboard Backlight* submenu.
4. Select one of the available options and confirm.

5.5.6 Power Saving

About power saving

When the active input(s) is (are) missing, this setting allows the display to switch off the backlight and enter a low power mode. In this status the availability of the selected input is checked periodically.



The unit can exit from power save mode in two cases:

1. When a signal is applied on the selected input (or any input in case of auto).
 2. By activating the OSD menu, see "OSD menu activation", page 23.
-

To enable/disable power saving

1. Bring up the OSD main menu.
2. Navigate to the *System* menu.
3. Enter the *Power Saving* submenu.
4. Enable/Disable power saving as desired and confirm.

6. IMPORTANT INFORMATION

6.1 Safety information

General recommendations

Read the safety and operating instructions before operating the device.

Retain safety and operating instructions for future reference.

Adhere to all warnings on the device and in the operating instructions manual.

Follow all instructions for operation and use.

Electrical Shock or Fire Hazard

To prevent electric shock or fire hazard, do not remove cover.

No serviceable parts inside. Refer servicing to qualified personnel.

Do not expose this apparatus to rain or moisture.

Modifications to the unit

Do not modify this equipment without authorization of the manufacturer.

Preventive maintenance

Performance of preventive maintenance is not essential. Periodic maintenance inspections are essential to keep the monitor in optimum condition and ensure safe operation. We recommend a functional and safety test of the monitor at regular intervals (e.g. at least once a year).

Type of protection (Electrical)

Equipment with external power supply: Class I equipment

Degree of safety (flammable anesthetic mixture)

Equipment not suitable for use in the presence of a flammable anesthetic mixture with air or with oxygen or nitrous oxide.

Non-patient care equipment

- Equipment primarily for use in a health care facility that is intended for use where contact with a patient is unlikely (no applied part).
- The equipment shall not be used with life support equipment.
- The user should not touch the equipment, nor its signal input ports (SIP)/signal output ports (SOP) and the patient at the same time.

Mission critical applications

We strongly recommend there is a replacement display immediately available in mission critical applications.

Use of Electrical Surgical Knives

Provide as much distance as possible between the electrosurgical generator and other electronic equipment (such as monitors). An activated electrosurgical generator may cause interference with them. The interference can activate the OSD menu of the display and as such disrupt the functionality of the display.

Power connection – Equipment with external 24 VDC power supply

- Power requirements: The equipment must be powered using the delivered medical approved 24 VDC (—) SELV power supply.
- The medical approved DC (—) power supply must be powered by the AC mains voltage.
- The power supply is specified as a part of the ME equipment or combination is specified as a ME system.
- To avoid the risk of electric shock, this equipment must only be connected to a supply mains with protective earth.
- The equipment should be installed near an easily accessible outlet.
- The equipment is intended for continuous operation.
- The compliance of this monitor with Medical Safety and EMC requirements has been evaluated using the external (optional) Skynet medical power supply model BAR-A159. If a different power supply will be used, further investigation for Safety and EMC requirements, have to be performed at system level.

Power cords:

- Utilize a UL-listed detachable power cord, 3-wire, type SJ or equivalent, 18 AWG min., rated 250 V min., provided with a hospital-grade type plug 5-15P configuration for 120V application, or 6-15P for 240V application.
- Do not overload wall outlets and extension cords as this may result in fire or electric shock.
- Mains lead protection (U.S.: Power cord): Power cords should be routed so that they are not likely to be walked upon or pinched by items placed upon or against them, paying particular attention to cords at plugs and receptacles.
- Use a power cord that matches the voltage of the power outlet, which has been approved and complies with the safety standard of your particular country.

Transient over-voltage

If the device is not used for a long time, disconnect it from the AC inlet to avoid damage by transient over-voltage.

To fully disengage the power to the device, please disconnect the power cord from the AC inlet.

Connections

Any external connection with other peripherals must follow the requirements of clause 16 of IEC60601-1 3rd ed. or Table BBB.201 of IEC 60601-1-1 for the medical electrical systems.

Water and moisture

The equipment is IP21 compliant (IPx5 front side only) in vertical position.



The power supply is not approved for IP21. The power supply must be mounted in a flat position for best resistance to fluids.

Moisture condensation

Do not use monitor under rapid temperature and humidity change condition or avoid cold air from air-conditioning outlet directly.

Moisture may condense on the surface or inside of the unit, or create a mist residue inside the protection plate, this is not a malfunction of the product itself, although it may cause damage to the monitor.

If condensation happens, let the monitor stand unplugged until there is no condensation.

Ventilation

Do not cover or block any ventilation openings in the cover of the set. When installing the device in a cupboard or another enclosed location, heed the necessary space between the set and the sides of the cupboard.

Installation

- Place the equipment on a flat, solid and stable surface that can support the weight of at least 3 equipments. If you use an unstable cart or stand, the equipment may fall, causing serious injury to a child or adult, and serious damage to the equipment.
- Do not allow to climb or rest on the equipment.
- When adjusting the angle of the equipment, move it slowly so as to prevent the equipment from moving or slipping off from its stand or arm.
- When the equipment is attached to an arm, do not use the equipment as a handle or grip in order to move the equipment. Please refer to the instruction manual of the arm for instructions on how to move the arm with the equipment.
- Provide full attention to safety during installation, periodic maintenance and examination of this equipment.
- Sufficient expertise is required for installing this equipment, especially to determine the strength of the wall for withstanding the display's weight. Be sure to entrust the attachment of this equipment to the wall to licensed contractors of Barco and pay adequate attention to safety during the installation and usage.
- Barco is not liable for any damage or injury caused by mishandling or improper installation.

Malfunctions

Disconnect the equipment's power cord from the AC inlet and refer servicing to qualified service technicians under the following conditions:

- If the power cord or plug is damaged or frayed.
- If liquid has been spilled into the equipment.
- If the equipment has been exposed to rain or water.
- If the equipment does not operate normally when the operating instructions are followed. Adjust only those controls that are covered by the operating instructions since improper adjustment of other controls may result in damage and will often require extensive work by a qualified technician to restore the product to normal operation.
- If the equipment has been dropped or the cabinet has been damaged.
- If the product exhibits a distinct change in performance, indicating a need for service.

General warnings

- All devices and complete setup must be tested and validated before taking into operation.
- At end user application level it is necessary to foresee a backup unit in case the video falls away.

Technical data

- The monitor is intended for indoor use
- The monitor has been designed to be used in landscape position with a tilt of -10° (backward) and $+10^{\circ}$ (forward)
- The monitor is not intended to be sterilized
- The monitor has not applied parts, but the front side of the LCD panel and the plastic enclosure have been treated as applied part because considered accidentally touchable by the patient for a time <1 minute

This apparatus conforms to:

Medical Equipment:

6. Important information

CE (MDD) Class I, essential requirements of MDD 93/42/EEC, version 2007 (in effect as of March 2010)

Safety:

EN 60601-1 (Ed. 3) +A1: 2013 +A12: 2014

IEC 60601-1 (Ed.3) +A1:2012

ANSI/AAMI ES 60601-1 (Ed. 3) +A1: 2012; C1:2009/(R)2012 and A2:2010/(R)2012

CSA CAN/CSA-C22.2 NO. 60601-1:14

EMC:

IEC 60601-1-2: 2014

EN 60601-1-2: 2015

EN 55011 / CISPR11 (MDSC-2324 MNA: Class A; MDSC-2324 LED and MDSC-2324 DDI: Class B)

National Scandinavian Deviations for CL. 1.7.2

Finland: "Laitte on liitettävä suojamaadoituskoskettimilla varustettuun pistorasiaan"

Norway: "Apparatet må tilkoples jordet stikkontakt"

Sweden: "Apparaten skall anslutas till jordat uttag"



CAUTION: The enclosure has to be checked upon collision damage, refer to qualified service personnel.

6.2 Environmental information

Disposal Information

Waste Electrical and Electronic Equipment



■ This symbol on the product indicates that, under the European Directive 2012/19/EU governing waste from electrical and electronic equipment, this product must not be disposed of with other municipal waste. Please dispose of your waste equipment by handing it over to a designated collection point for the recycling of waste electrical and electronic equipment. To prevent possible harm to the environment or human health from uncontrolled waste disposal, please separate these items from other types of waste and recycle them responsibly to promote the sustainable reuse of material resources.

For more information about recycling of this product, please contact your local city office or your municipal waste disposal service.

For details, please visit the Barco website at: <http://www.barco.com/en/AboutBarco/weee>

Turkey RoHS compliance



■ Türkiye Cumhuriyeti: AEEE Yönetmeliğine Uygundur.

[Republic of Turkey: In conformity with the WEEE Regulation]

中国大陆 RoHS

Chinese Mainland RoHS

根据中国大陆《电器电子产品有害物质限制使用管理办法》(也称为中国大陆RoHS), 以下部分列出了Barco产品中可能包含的有毒和/或有害物质的名称和含量。中国大陆RoHS指令包含在中国信息产业部MCV标准:“电子信息产品中有毒物质的限量要求”中。

According to the “Management Methods for the Restriction of the Use of Hazardous Substances in Electrical and Electronic Products” (Also called RoHS of Chinese Mainland), the table below lists the names and contents of toxic and/or hazardous substances that Barco’s product may contain. The RoHS of Chinese Mainland is included in the MCV standard of the Ministry of Information Industry of China, in the section “Limit Requirements of toxic substances in Electronic Information Products”.

零件项目(名称) Component name	有毒有害物质或元素 Hazardous substances and elements					
	铅 Pb	汞 Hg	镉 Cd	六价铬 Cr6+	多溴联苯 PBB	多溴二苯醚 PBDE
印制电路配件 Printed Circuit Assemblies	X	O	O	O	O	O
液晶面板 LCD panel	X	O	O	O	O	O
外接电(线)缆 External Cables	X	O	O	O	O	O
内部线路 Internal wiring	O	O	O	O	O	O
金属外壳 Metal enclosure	O	O	O	O	O	O
塑胶外壳 Plastic enclosure	O	O	O	O	O	O
散热片(器) Heatsinks	O	O	O	O	O	O
风扇 Fan	O	O	O	O	O	O
电源供应器 Power Supply Unit	X	O	O	O	O	O
文件说明书 Paper Manuals	O	O	O	O	O	O
光盘说明书 CD manual	O	O	O	O	O	O

本表格依据SJ/T 11364的规定编制

This table is prepared in accordance with the provisions of SJ/T 11364.

O: 表示该有毒有害物质在该部件所有均质材料中的含量均在 GB/T 26572 标准规定的限量要求以下。

O: Indicates that this toxic or hazardous substance contained in all of the homogeneous materials for this part is below the limit requirement in GB/T 26572.

X: 表示该有毒有害物质至少在该部件的某一均质材料中的含量超出 GB/T 26572 标准规定的限量要求。

X: Indicates that this toxic or hazardous substance contained in at least one of the homogeneous materials used for this part is above the limit requirement in GB/T 26572.

在中国大陆销售的相应电子信息产品(EIP)都必须遵照中国大陆《电子电气产品有害物质限制使用标识要求》标准贴上环保使用期限(EFUP)标签。Barco产品所采用的EFUP标签(请参阅实例, 徽标内部的编号用于指定产品)基于中国大陆的《电子信息产品环保使用期限通则》标准。

6. Important information

All Electronic Information Products (EIP) that are sold within Chinese Mainland must comply with the “Marking for the restriction of the use of hazardous substances in electrical and electronic product” of Chinese Mainland, marked with the Environmental Friendly Use Period (EFUP) logo. The number inside the EFUP logo that Barco uses (please refer to the photo) is based on the “General guidelines of environment-friendly use period of electronic information products” of Chinese Mainland.



RoHS

Directive 2011/65/EC on the restriction of certain hazardous substances in electrical and electronic equipment.

According to what declared by our components suppliers, this product is RoHS compliant.

6.3 Biological hazard and returns

Overview

The structure and the specifications of this device as well as the materials used for manufacturing makes it easy to wipe and clean and therefore suitable to be used for various applications in hospitals and other medical environments, where procedures for frequent cleaning are specified.

However, normal use shall exclude biological contaminated environments, to prevent spreading of infections.

Therefore use of this device in such environments is at the exclusive risk of Customer. In case this device is used where potential biological contamination cannot be excluded.

Customer shall implement the decontamination process as defined in the latest edition of the ANSI/AAMI ST35 standard on each single failed Product that is returned for servicing, repair, reworking or failure investigation to Seller (or to the Authorized Service Provider). At least one adhesive yellow label shall be attached on the top site of the package of returned Product and accompanied by a declaration statement proving the Product has been successfully decontaminated.

Returned Products that are not provided with such external decontamination label, and/or whenever such declaration is missing, can be rejected by Seller (or by the Authorized Service Provider) and shipped back at Customer expenses.

6.4 Regulatory compliance information

Indications for use

This device is intended to be used in operation rooms, to display images from endoscopic cameras, room and boom cameras, ultrasound, cardiology, PACS, anesthesiology and patient information. It is not intended for diagnosis.

Manufacturing country

The manufacturing country of the product is indicated on the product label (“**Made in ...**”).

Importers contact information

To find your local importer, contact one of Barco’s regional offices via the contact information provided on our website (www.barco.com).

FCC Class B (valid for MDSC-2324 LED and MDSC-2324 DDI version)

This device complies with Part 15 of the FCC Rules. Operation is subject to the following two conditions: (1) this device may not cause harmful interference, and (2) this device must accept any interference received, including interference that may cause undesired operation.

This equipment has been tested and found to comply with the limits for a Class B digital device, pursuant to Part 15 of the FCC Rules. These limits are designed to provide reasonable protection against harmful interference in a residential installation. This equipment generates, uses and can radiate radio frequency energy and, if not installed and used in accordance with the instructions, may cause harmful interference to radio communications. However, there is no guarantee that interference will not occur in a particular installation. If this equipment does cause harmful interference to radio or television reception, which can be determined by turning the equipment off and on, the user is encouraged to try to correct the interference by one or more of the following measures:

- Reorient or relocate the receiving antenna.
- Increase the separation between the equipment and receiver.
- Connect the equipment into an outlet on a circuit different from that to which the receiver is connected.
- Consult the dealer or an experienced radio/TV technician for help.

FCC Class A (valid for MDSC-2324 MNA version)

This equipment has been tested and found to comply with the limits of a class A digital device, pursuant to Part 15 of the FCC rules. These limits are designed to provide reasonable protection against harmful interference when the equipment is operated in a commercial environment. This equipment generates, uses and can radiate radio frequency energy and, if not installed and used in accordance with the instruction manual, may cause harmful interference to radio communications. Operation of this equipment in a residential area is likely to cause harmful interference in which case the user will be required to correct the interference at his own expense.

Canadian notice

This ISM device complies with Canadian ICES-001.

Cet appareil ISM est conforme à la norme NMB-001 du Canada.

6.5 EMC notice**General information**

No specific requirement on the use of external cables or other accessories except power supply.

With the installation of the device, use only the delivered power supply or a spare part provided by the legal manufacturer. Using another can result in a decrease of the immunity level of the device.

Electromagnetic emissions

The MDSC-2324 is intended for use in the electromagnetic environment (IEC 60601-1-2 4th edition) specified below. The customer or the user of the MDSC-2324 should assure that it is used in such an environment.

Emissions test	Compliance	Electromagnetic environment – Guidance
RF emissions CISPR 11	Group 1	The MDSC-2324 uses RF energy only for its internal function. Therefore, its RF emissions are very low and are not likely to cause any interference in nearby electronic equipment.

6. Important information

Emissions test	Compliance	Electromagnetic environment – Guidance
RF emissions CISPR 11	Class B	The MDSC-2324 LED and DDI version is suitable for use in all establishments, including domestic establishments and those directly connected to the public low-voltage power supply network that supplies buildings used for domestic purposes.
Harmonic emissions IEC 61000-3-2	Not applicable: power consumption less than 75W	
Voltage fluctuations/ flicker emissions IEC 61000-3-3	Complies	
RF emissions CISPR 11	Class A	The MDSC-2324 MNA version is suitable for use in all establishments, including domestic establishments and those directly connected to the public low-voltage power supply network that supplies buildings used for domestic purposes.
Harmonic emissions IEC 61000-3-2	Not applicable: power consumption less than 75W	
Voltage fluctuations/ flicker emissions IEC 61000-3-3	Complies	

This MDSC-2324 complies with appropriate medical EMC standards on emissions to, and interference from surrounding equipment. Operation is subject to the following two conditions: (1) this device may not cause harmful interference, and (2) this device must accept any interference received, including interference that may cause undesired operation.

Interference can be determined by turning the equipment off and on.

If this equipment does cause harmful interference to, or suffer from harmful interference of, surrounding equipment, the user is encouraged to try to correct the interference by one or more of the following measures:

- Reorient or relocate the receiving antenna or equipment.
- Increase the separation between the equipment and receiver.
- Connect the equipment into an outlet on a circuit different from that to which the receiver is connected.
- Consult the dealer or an experienced technician for help.

Electromagnetic immunity

The MDSC-2324 is intended for use in the electromagnetic environment (IEC 60601-1-2 4th edition) specified below. The customer or the user of the MDSC-2324 should assure that it is used in such an environment.

Immunity test	IEC 60601-1-2 4 th edition (2014) Test levels	Compliance level	Electromagnetic environment – guidance
Electrostatic discharge (ESD) IEC 61000-4-2	± 8kV contact ± 15kV air	± 8kV contact ± 15kV air	Floors should be wood, concrete or ceramic tile. If floors are covered with synthetic material, the relative humidity should be at least 30%
Electrical fast transient/burst IEC 61000-4-4	± 2kV for power supply lines ± 1kV for input/ output lines	± 2kV for power supply lines ± 1kV for input/ output lines	Mains power quality should be that of a typical commercial or hospital environment
Surge IEC61000-4-5	± 1 kV line(s) to line(s) ± 2 kV line(s) to earth	± 1 kV line(s) to line(s) ± 2 kV line(s) to earth	Mains power quality should be that of a typical commercial or hospital environment

Immunity test	IEC 60601-1-2 4 th edition (2014) Test levels	Compliance level	Electromagnetic environment – guidance
Voltage dips, short interruptions and voltage variations on power supply input lines IEC 61000-4-11	< 5% U_T ¹ (> 95% dip in U_T) for 0.5 cycle 40% U_T (60% dip in U_T) for 5 cycles 70% U_T (30% dip in U_T) for 25 cycles < 5% U_T (>95% dip in U_T) for 5 seconds	< 5% U_T (> 95% dip in U_T) for 0.5 cycle 40% U_T (60% dip in U_T) for 5 cycles 70% U_T (30% dip in U_T) for 25 cycles < 5% U_T (>95% dip in U_T) for 5 seconds	Mains power quality should be that of a typical commercial or hospital environment. If the user of the MDSC-2324 requires continued operation during power mains interruptions, it is recommended that the MDSC-2324 be powered from an uninterruptible power supply or a battery.
Power frequency (50/60 Hz) magnetic field IEC 61000-4-8	30 A/m	30 A/m	Power frequency magnetic fields should be at levels characteristic of a typical location in a typical commercial or hospital environment.
Conducted RF IEC 61000-4-6 Radiated RF IEC 61000-4-3	3 V/m (150 kHz to 80 MHz) 9 to 28 V/m in communication service channels up to 6 GHz	3 V/m (150 kHz to 80 MHz) 9 to 28 V/m in communication service channels up to 6 GHz	Portable and mobile RF communications equipment should be used no closer to any part of the MDSC-2324, including cables, than the recommended separation distance calculated from the equation applicable to the frequency of the transmitter. Recommended separation distance $d = 1.2\sqrt{P}$ $d = 1.2\sqrt{P}$ 80 MHz to 800 MHz $d = 2.3\sqrt{P}$ 800 MHz to 2.5 GHz Where P is the maximum output power rating of the transmitter in watts (W) according to the transmitter manufacturer and d is the recommended separation distance in meters (m). Field strengths from fixed RF transmitters, as determined by an electromagnetic site survey, ² should be less than the compliance

1. is the a.c. mains voltage prior to application of the test level.

6. Important information

Immunity test	IEC 60601-1-2 4 th edition (2014) Test levels	Compliance level	Electromagnetic environment – guidance
			level in each frequency range. ³ Interference may occur in the vicinity of equipment marked with symbol: 



At 80 MHz and 800 MHz, the higher frequency range applies.



These guidelines may not apply in all situations. Electromagnetic propagation is affected by absorption and reflection from structures, objects and people.

Recommended separation distance

The MDSC-2324 is intended for use in an electromagnetic environment in which radiated RF disturbances are controlled. The customer of the user of the MDSC-2324 can help prevent electromagnetic interference by maintaining a minimum distance between portable and mobile RF communications equipment (transmitters) and the MDSC-2324 as recommended below, according to the maximum output power of the communications equipment.

Rated maximum output power of transmitter ⁴ W	Separation distance according to frequency of transmitter		
	150kHz to 80MHz $d=1.2\sqrt{P}$	80MHz to 800MHz $d=1.2\sqrt{P}$	800MHz to 2.5GHz $d=2.3\sqrt{P}$
0.01	0.12	0.12	0.23
0.1	0.38	0.38	0.73
1	1.2	1.2	2.3
10	3.8	3.8	7.3
100	12	12	23



At 80 MHz and 800 MHz, the separation distance for the higher frequency range applies.



These guidelines may not apply in all situations. Electromagnetic propagation is affected by absorption and reflection from structures, object and people.

2. Field strengths from fixed transmitters, such as base stations for radio (cellular/cordless) telephones and land mobile radios, amateur radio, AM and FM radio broadcast and TV broadcast cannot be predicted theoretically with accuracy. To assess the electromagnetic environment due to fixed RF transmitters, an electromagnetic site survey should be considered. If the measured field strength in the location in which the MDSC-2324 is used exceeds the applicable RF compliance level above, the MDSC-2324 should be observed to verify normal operation. If abnormal performance is observed, additional measures may be necessary, such as re-orienting or relocating the MDSC-2324.

3. Over the frequency range 150 kHz to 80 MHz, field strengths should be less than 3 V/m.

4. For transmitters rated at a maximum output power not listed above, the recommended separation distance d in meters (m) can be estimated using the equation applicable to the frequency of the transmitter. Where P is the maximum output power rating of the transmitter in watts (W) according to the transmitter manufacturer.

6.6 Cleaning and disinfection

Instructions

- Be sure to unplug the power cord from the mains when cleaning your LCD monitor.
- Take care not to scratch the front surface with any hard or abrasive material.
- Dust, finger marks, grease etc. can be removed with a soft damp cloth (a small amount of mild detergent can be used on the damp cloth).
- Wipe off water drop immediately.









Possible cleaning solutions

- 70 percent isopropyl alcohol
- 1.6 percent aqueous ammonia
- Cidex® (2.4 percent glutaraldehyde solution)
- Sodium hypochlorite (bleach) 10 percent
- “Green soap” (USP)
- 0.5 percent Chlorhexidine in 70 percent isopropyl alcohol.
- Like Cleansafe® optical cleaning liquid















6.7 Explanation of symbols

Symbols on the device



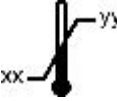



On the device or power supply, you may find the following symbols (nonrestrictive list):

	Indicates the device meets the requirements of the applicable EC directives.
	Indicates compliance with Part 15 of the FCC rules (Class A or Class B)
	Indicates the device is approved according to the UL Recognition regulations
	MEDICAL – GENERAL MEDICAL EQUIPMENT AS TO ELECTRICAL SHOCK, FIRE AND MECHANICAL HAZARDS ONLY IN ACCORDANCE WITH ANSI/AAMI AS60601-1:2005/(R)2012, CSA CAN/CSA-C222.2 NO. 60601-1:14
	Indicates the device is approved according to the UL Demko regulations
	Indicates the device is approved according to the CCC regulations
	Indicates the device is approved according to the VCCI regulations
	Indicates the device is approved according to the KC regulations

6. Important information





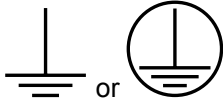

	Indicates the device is approved according to the BSMI regulations
	Indicates the device is approved according to the PSE regulations
	Indicates the device is approved according to the RCM regulations
	Indicates the device is approved according to the EAC regulations
	Caution: Federal law (United State of America) restricts this device to sale by or on the order of a licensed healthcare practitioner.
IS 13252 (Part 1) IEC 60950-1  R-xxxxxxx	Indicates the device is approved according to the BIS regulations
	Indicates the USB connectors on the device
	Indicates the DisplayPort connectors on the device
	Indicates the legal manufacturer
	Indicates the manufacturing date
	Indicates the temperature limitations ⁵ for the device to safely operate within specs.
	Indicates the device serial number
	Indicates the device part number or catalogue number
	Warning: dangerous voltage

5. Values for xx and yy can be found in the technical specifications paragraph.

	Caution
	Consult the operating instructions
	Indicates this device must not be thrown in the trash but must be recycled, according to the European WEEE (Waste Electrical and Electronic Equipment) directive
	Indicates Direct Current (DC)
	Indicates Alternating Current (AC)
	Stand-by
	Equipotentiality
	Protective earth (ground)

Symbols on the box

On the box of the device, you may find the following symbols (nonrestrictive list):

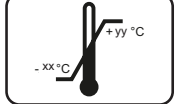
	Indicates a device that can be broken or damaged if not handled carefully when being stored.
	Indicates a device that needs to be protected from moisture when being stored.
	Indicates the storage direction of the box. The box must be transported, handled and stored in such a way that the arrows always point upwards.
	Indicates the maximum number of identical boxes which may be stacked on each other, where "n" is the limiting number.
	Indicates the weight of the box and that it should be carried with two persons.
	Indicates that the box should not be cut with a knife, a cutter or any other sharp object.
	Indicates the temperature limits ⁶ to which the device can be safely exposed when being stored.

6. Important information

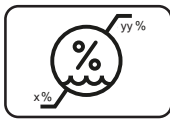
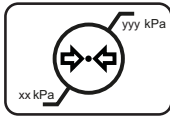
	Indicates the range ⁶ of humidity to which the device can be safely exposed when being stored.
	Indicates the range ⁶ of atmospheric pressure to which the device can be safely exposed when being stored.

6.8 Legal disclaimer

Disclaimer notice

Although every attempt has been made to achieve technical accuracy in this document, we assume no responsibility for errors that may be found. Our goal is to provide you with the most accurate and usable documentation possible; if you discover errors, please let us know.

Barco software products are the property of Barco. They are distributed under copyright by Barco NV or Barco Inc., for use only under the specific terms of a software license agreement between Barco NV or Barco Inc. and the licensee. No other use, duplication, or disclosure of a Barco software product, in any form, is authorized.

The specifications of Barco products are subject to change without notice.

Trademarks

All trademarks and registered trademarks are property of their respective owners.

Copyright notice

This document is copyrighted. All rights are reserved. Neither this document, nor any part of it, may be reproduced or copied in any form or by any means - graphical, electronic, or mechanical including photocopying, taping or information storage and retrieval systems - without written permission of Barco.

© 2017 Barco NV all rights reserved.

6.9 Technical specifications

Overview

Screen technology	TFT AM LCD
Active screen size (diagonal)	611 mm (24.1")
Active screen size (H x V)	518 x 324 mm (20.4 x 12.7")
Aspect ratio (H:V)	16:10
Resolution	W-UXGA (1920 x 1200)
Pixel pitch	0.270 mm
Color imaging	Yes
Color support	1073 million
Viewing angle (H, V)	178° (panel typical)
Maximum luminance	400 cd/m ² (panel typical)
Contrast ratio	1500:1 (panel typical)
Response time (Tr + Tf)	18 ms (typical)

⁶. Values for xx and yy can be found in the technical specifications paragraph.

Housing color	White
Video input signals	DVI-I Single Link (digital & analog – HDMI video support with HDCP)
	DVI-D Single Link (digital only)
	DisplayPort (VESA std 1.1a)
	RGBS / SOG
	VGA (only computer VESA signals accepted)
	S-video
	Composite video
	Component video
	SDI/HD-SDI/3GSDI
	Nexxis fiber optic input
	Video output signals
CVBS	
S-video	
SDI / HD-SDI / 3GSDI	
Power source requirements for external power supply (nominal)	100-250 VAC
Power source requirements for display power input	LED and DDI version: 24 VDC 2.3 A max
	MNA version: 24 VDC 3.2 A max
Power consumption	LED and DDI version: 55 W max
	MNA version: 75 W max
Power save mode	Yes
Dot clock	165 MHz max. (DVI)
OSD languages	English, French, German, Spanish, Italian
Display dimensions w/o stand (W x H x D)	595,4 x 414 x 84 mm (23.44 x 16.3 x 3.31 in)
Power Supply dimensions (W x H x D)	210 x 103 x 52 mm (8.27 x 4.06 x 2.05 in)
Dimensions packaged (W x H x D)	712 x 605 x 178 mm (28.03 x 23.82 x 7.01 in)
Net weight display w/o stand	8.0 kg (17.6 lbs) (9.6 kg (21.2 lbs) incl. power supply and accessories)
Net weight power supply	1.5 kg (3.31 lbs)
Net weight packaged w/o stand	12.5 kg (27.6 lbs)
Power supply DC output cable length	2.5 m (8.2 ft)
Mounting standard	VESA (100 mm)
Screen protection	Protective, non-reflective PMMA cover
Recommended modalities	Endoscopy, Laparoscopy, PACS, PM, US, CT, MR
Certifications	CE (MDD) Class I, essential requirements of MDD 93/42/EEC, version 2007 (in effect as of March 2010), EN 60601-1 (Ed.3) +A1: 2013 +A12: 2014, IEC 60601-1 (Ed. 3) +A1: 2012, IEC 60601-1-6 (Ed. 3); Am1, IEC 62366(Ed.1); Am1, ANSI/AAMI ES 60601-1 (Ed. 3) +A1: 2012; C1: 2009/(R) 2012 and A2: 2010/(R)2012, CSA CAN/CSA-C22.2 NO. 60601-1:14, IEC 60601-1-2: 2014, EN 60601-1-2: 2015, EN 55011/CISPR11 (MDSC-2324 MNA version: Class A, MDSC-2324 LED and DDI version: Class B), FCC CFR 47 Part 15 Subpart B (MDSC-2324 MNA version: Class A, MDSC-2324 LED and DDI version: Class B), RoHS compliant, IP21 (IP45 front side only).

6. Important information

Supplied accessories	User Guide
	Video cable (DVI Dual Link)
	Mains cables (European (CEBEC/KEMA), USA (UL/CSA), Chinese (Z3487500 "Chinese" power cord L=1500)
	External power supply
Optional accessories	Barco stand (K9302097A)
	Power extension cable 10m (K3495066)
	Power extension cable 30m (K3495068)
Operating temperature	10-35°C for performance / 0-40°C for safety
Storage temperature	-20 ÷ +60°C
Operating humidity	10 ÷ 90% (non-condensing)
Storage humidity	10 ÷ 90% (non-condensing)
Operating altitude	3000 m max.
Storage altitude	12000 m max.

Timings DVI-VGA

Item	Name	Pixel x Line	Format	Hor. Fr. (kHz)	Vert. Fr. (Hz)	Hor. Total	Vert. Total	DVI	VGA adapter to DVI-I
1	480i	720 x 487	NTSC	15,734	59,94			Y	N
2	480p59	720 x 480	480p	31,47	59,94			Y	N
3	480p60	720 x 480	480p	31,5	60			Y	N
4	576i	720 x 576	PAL I	15,625	50			Y	N
5	576p	720 x 576	576p	31,25	50			Y	N
6	720p29	1280 x 720	720p	22,48	29,97			Y	N
7	720p30	1280 x 720	720p	22,5	30			Y	N
8	720p50	1280 x 720	720p	37,5	50			Y	N
9	720p59	1280 x 720	720p	44,96	59,94			Y	N
10	720p60	1280 x 720	720p	45	60			Y	N
11	1080i25	1920 x 1080	1080i	28,13	50			Y	N
12	1080i29	1920 x 1080	1080i	33,72	59,94			Y	N
13	1080i30	1920 x 1080	1080i	33,75	60			Y	N
14	1080p29	1920 x 1080	1080p	33,72	29,97			Y	N
15	1080p30	1920 x 1080	1080p	33,75	30			Y	N
16	1080p50	1920 x 1080	1080p	56,25	50			Y	N
17	1080p59	1920 x 1080	1080p	67,433	59,94			Y	N
18	1080p60	1920 x 1080	1080p	67,5	60			Y	N
19	DMT0660	640 x 480	VGA	31,5	60			Y	Y
20	DMT0672	640 x 480	VGA	37,86	72,808			Y	Y
21	DMT0675	640 x 480	VGA	37,5	75			Y	Y
22	DMT0685	640 x 480	VGA	43,269	85,008			Y	Y
23	DMT0856	800 x 600	SVGA	35,16	56,25			Y	Y
24	DMT0860	800 x 600	SVGA	37,88	60,32			Y	Y
25	DMT0872	800 x 600	SVGA	48,08	72,19			Y	Y
26	DMT0875	800 x 600	SVGA	46,875	75			Y	Y
27	DMT0885	800 x 600	SVGA	53,74	85,061			Y	Y
28	DMT1060	1027 x 768	XGA	48,4	60			Y	Y

Item	Name	Pixel x Line	Format	Hor. Fr. (kHz)	Vert. Fr. (Hz)	Hor. Total	Vert. Total	DVI	VGA adapter to DVI-I
29	DMT1070	1024 x 768	XGA	56,4	70			Y (Diag. mode) ⁷	Y (Diag. mode) ⁷
30	DMT1075	1024 x 768	XGA	60	75			Y	Y
31	DMT1085	1024 x 768	XGA	68,7	85			Y	Y
32	DMT1175	1152 x 864	XGA+	67,5	75			Y	Y
33	DMT1260G	1280 x 1024	SXGA	64	60			Y	Y
34	DMT1275G	1280 x 1024	SXGA	79,976	75,025			Y	Y
35	DMT1285G	1280 x 1024	SXGA	91,1	85			Y	Y
36	DMT1660	1600 x 1200	UXGA	75	60			Y	Y
37	CVR1460	1400 x 1050	SXGA+	64,744	59,948			Y	Y
38	CVT1460	1400 x 1050	SXGA+ (VESA)	65,32	59,98			Y	Y
39	CVR1660D	1680 x 1050	WSXGA+1	64,67	59,88			Y	Y
40	CVT1660D	1680 x 1050	WSXGA+2	65,29	59,95			Y	Y
41	CVT	1920 x 1200	WUXGA1	74,038	59,95			Y	Y
42	IBM	640 x 350		31,5	70	800	449	Y (Diag. mode) ⁷	N
43	VESA	640 x 350		37,9	85	832	446	Y	Y
44	VESA	640 x 400		24,8	56,3	848	440	N	Y
45	IBM	640 x 400		31,5	70,0	800	449	Y (Diag. mode) ⁷	N
46	VESA	640 x 400		37,9	85,0	832	446	Y	Y

Timings BNC inputs: Comp RGBS - YPbPr - SOG

Item	Name	Pixel x Line	Format	Hor. Fr. (kHz)	Vert. Fr. (Hz)	Hor. Total	Vert. Total	SOG	RGBS / YPbPr
1	480i	720 x 487	NTSC	15,734	59,94			Y	Y
2	480p59	720 x 480	480p	31,47	59,94			Y	Y
3	480p60	720 x 480	480p	31,5	60			Y	Y
4	576i	720 x 576	PAL I	15,625	50			Y	Y
5	576p	720 x 576	576p	31,25	50			Y	Y
8	720p50	1280 x 720	720p	37,5	50			Y	Y
9	720p59	1280 x 720	720p	44,96	59,94			Y	Y
10	720p60	1280 x 720	720p	45	60			Y	Y
11	1080i25	1920 x 1080	1080i	28,13	50			Y	Y
12	1080i29	1920 x 1080	1080i	33,72	59,94			Y	Y
13	1080i30	1920 x 1080	1080i	33,75	60			Y	Y
14	1080p29	1920 x 1080	1080p	33,72	29,97			Y	Y
15	1080p30	1920 x 1080	1080p	33,75	30			Y	Y
16	1080p50	1920 x 1080	1080p	56,25	50			Y	Y
17	1080p59	1920 x 1080	1080p	67,433	59,94			Y	Y
18	1080p60	1920 x 1080	1080p	67,5	60			Y	Y

⁷ OSD Smart Video set to "Diagnostic"

6. Important information

Timings SDI

Item	Name	Pixel x Line	Format	Hor. Fr. (kHz)	Vert. Fr. (Hz)	Hor. Total	Vert. Total	SDI (Ypb)	RGBS / YPbPr
1	480i	720 x 487	NTSC	15,734	59,94			Y	Y
4	576i	720 x 576	PAL I	15,625	50			Y	Y
8	720p50	1280 x 720	720p	37,5	50			Y	Y
9	720p59	1280 x 720	720p	44,96	59,94			Y	Y
10	720p60	1280 x 720	720p	45	60			Y	Y
11	1080i25	1920 x 1080	1080i	28,13	50			Y	Y
12	1080i29	1920 x 1080	1080i	33,72	59,94			Y	Y
13	1080i30	1920 x 1080	1080i	33,75	60			Y	Y
14	1080p29	1920 x 1080	1080p	33,72	29,97			Y	Y
15	1080p30	1920 x 1080	1080p	33,75	30			Y	Y
16	1080p50	1920 x 1080	1080p	56,25	50			Y	Y
17	1080p59	1920 x 1080	1080p	67,433	59,94			Y	Y
18	1080p60	1920 x 1080	1080p	67,5	60			Y	Y

SDI Standard Compliance:

SMPTE 425M (level A), SMPTE 424M, SMPTE 292M, SMPTE 296M, ITU-R BT.656, ITU-R BT.601

SDI Video Sampling:

Y Cb Cr 4:2:2

Dimensions

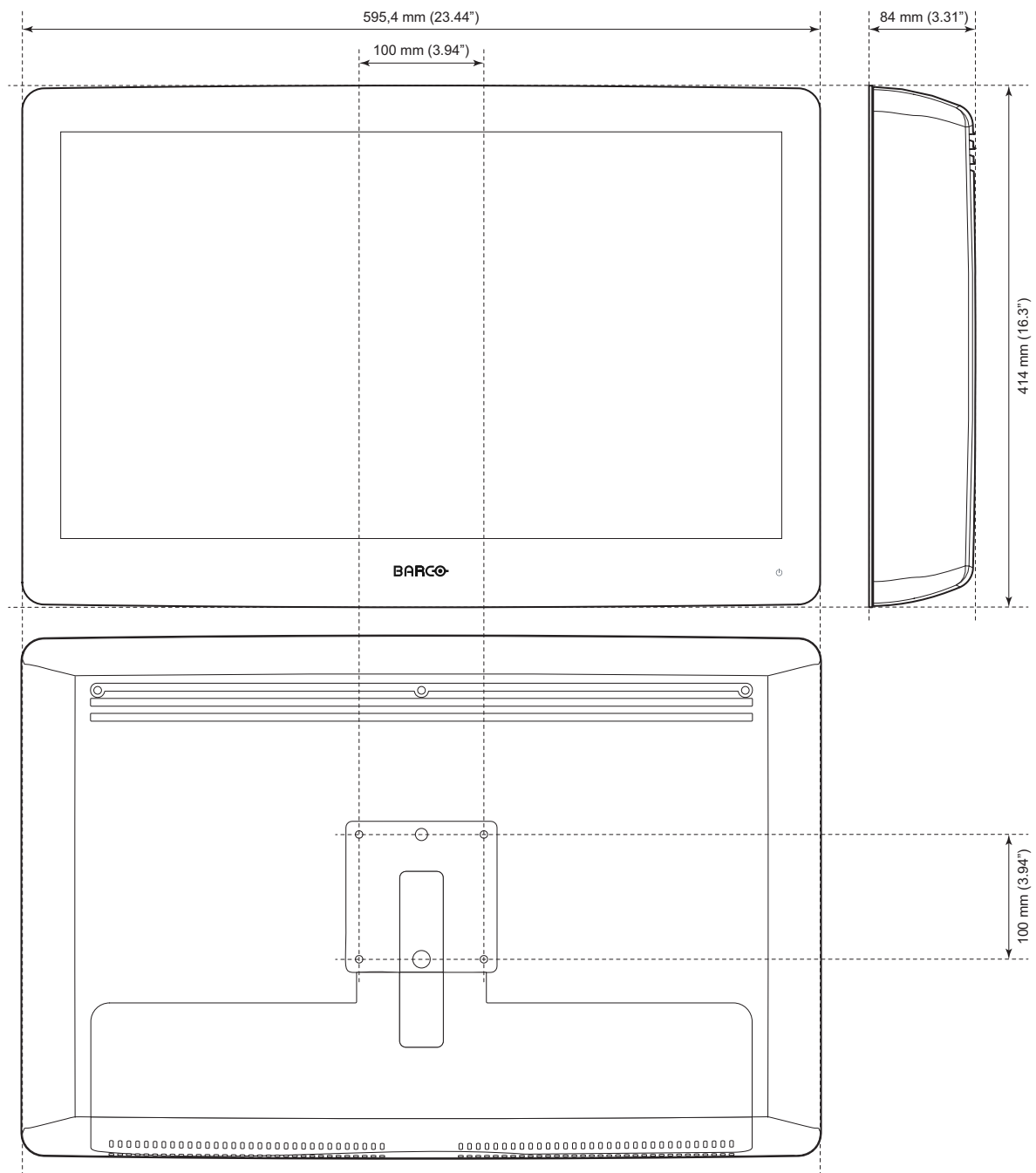

Image 6-1

6.10 Open source license information

Open source license information

This product contains software components released under an Open Source license. You acknowledge living up to the conditions of each separate Open Source Software license.

A list of the Open Source Software components used is available in the applicable EULA, through the “My Barco” section of the Barco website or through other (online) means.

6. Important information

Copyright on each Open Source Software component belongs to the respective initial copyright holder, each additional contributor and/or their respective assignee(s), as may be identified in the respective Open Source Software documentation, source code, README file, or otherwise. You shall not remove or obscure or otherwise alter the respective copyrights.

EACH SEPARATE OPEN SOURCE SOFTWARE COMPONENT AND ANY RELATED DOCUMENTATION ARE PROVIDED "AS IS" WITHOUT EXPRESS OR IMPLIED WARRANTY INCLUDING, BUT NOT LIMITED TO, THE IMPLIED WARRANTIES OF MERCHANTABILITY AND FITNESS FOR A PARTICULAR PURPOSE. IN NO EVENT SHALL THE COPYRIGHTHOLDER OR ANY OTHER CONTRIBUTOR BE LIABLE FOR DIRECT, INCIDENTAL, SPECIAL, EXEMPLARY OR CONSEQUENTIAL DAMAGES, EVEN IF ADVISED OF THE POSSIBILITY OF SUCH DAMAGES, HOWEVER CAUSED AND ON ANY THEORY OF LIABILITY. MORE INFORMATION/DETAILS IS TO BE FOUND IN EACH SPECIFIC OPEN SOURCE LICENSE.

With respect to GPL, LGPL or similar licenses with regard to corresponding source code access and automatic license terms applicability:

- You acknowledge living up to the conditions of each such specific applicable Open Source Software license. You are responsible for your own additions, changes or modifications without any recourse or claim towards Barco whatsoever. You further acknowledge that any such additions, changes or modifications may impair the ability of Barco – at Barco's sole discretion - to continue to provide service, warranties, software updates, fixes, maintenance, access or such similar abilities, without any recourse or claim towards Barco whatsoever.
- Barco offers to provide the corresponding source code, and shall make the corresponding source code available to you via email or download link, except where the applicable license entitles you to require Barco to provide you the corresponding source code on a tangible medium, in which case Barco will charge you for the actual costs of performing such distribution, such as the cost of media, shipping and handling. You may exercise this option upon written request to Barco N.V, attn. legal department, President Kennedypark 35, 8500 Kortrijk (Belgium). This offer is valid for a period of three (3) years from the date of the distribution of this product by Barco.