

EN

User Manual
Dishwasher

DISHWASHER

User Manual

QW-T21F472W-EU

SHARP

If you want to view advanced functions for your product, you can
do so by visiting www.sharphomeappliances.com

CONTENTS

CHAPTER-1: EXPLANATION OF PRODUCT	
Technical specifications	5
Conformity with the standards and test data	5
CHAPTER-2: SAFETY INFORMATION AND RECOMMENDATIONS	
Recycling	6
Safety information	6
Recommendations	8
Items not suitable for dishwashing	8
CHAPTER-3: INSTALLING THE MACHINE	
Positioning the machine	9
Water connections	9
Water inlet hose	9
Water outlet hose	10
Electrical connection	11
Fitting the machine undercounter	11
Prior to using the machine	13
CHAPTER-4: PREPARING THE MACHINE FOR USE	
The importance of water decalcification	13
Filling with salt	13
Testing strip	13
Adjusting salt consumption	14
Detergent usage	14
Filling the detergent compartment	14
Combined detergent	15
Filling with rinse aid and making the setting	15
CHAPTER-5: LOADING YOUR DISHWASHER	
Dish rack	16
Alternative basket loads	18
CHAPTER -6: PROGRAMME DESCRIPTIONS	
Programme items	19
CHAPTER -7: SWITCHING ON THE MACHINE AND SELECTING A PROGRAMME	
Switching on the machine	23
Programme follow-up	23
Changing a programme	23
Changing a programme with resetting	24
Switching the machine off	24
CHAPTER-8: MAINTENANCE AND CLEANING	
Filters	25
Spray arms	25
Hose filter	25
CHAPTER-9: FAILURE CODES AND WHAT TO DO IN CASE OF FAILURE	26
CHAPTER-10: PRACTICAL AND USEFUL INFORMATION	27

Dear Customer, our goal is to offer you, high quality products that exceed your expectations. Your appliance is produced in modern facilities and is duplicated, is carefully tested for quality.

Before using your appliance, carefully read this guide which includes basic information for safe installation, maintenance and use.

The operating instructions apply to several models. Differences may therefore occur.

CHAPTER -1: EXPLANATION OF PRODUCT

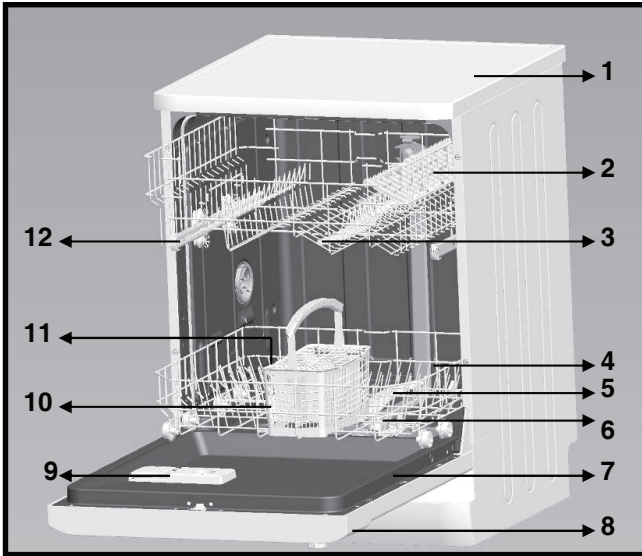

1. Worktop
2. Upper basket with racks
3. Upper spray arm
4. Lower basket
5. Lower spray arm
6. Filters
7. Rating plate
8. Control Panel
9. Detergent and rinse-aid dispenser
10. Cutlery basket
11. Salt dispenser
12. Upper basket track latch



13. Active Drying Unit: This system provides better drying performance for your dishes.

CHAPTER -1: TECHNICAL SPECIFICATIONS

Technical specifications

Capacity	12 place settings
Height	850 mm
Height (without worktop)	820 mm
Width	598 mm
Depth	598 mm
Net Weight	46 kg
Electricity input	220-240 V, 50 Hz
Total Power	2200 W
Heating Power	2000 W
Pump Power	100 W
Drain Pump Power	25 W
Water supply pressure	0.03 MPa (0,3 bar)-1 MPa (10 bar)
Current	10 A

Conformity with the standards and Test data / EC Declaration of Conformity

All stages related to the machine are executed in accordance with the safety rules provided in all relevant directives of the European Community. 2004/108/EC, 2006/95/EC, IEC 436/DIN 44990, EN 50242

Important Note for User: For a softcopy of this user manual, please contact the following address:

"dishwasher@standardtest.info". In your e-mail, please provide the model name and serial number (20 digits) which you can find on the appliance door.

Recycling

- The recyclable materials are used in certain components and packaging.
- Plastic parts are marked with international abbreviations: (>PE< , >PS< , >POM< , >PP< ,)
- Cardboard parts have been produced from recycled paper which should be disposed of into waste paper collection containers for recycling.
- Such materials are not suitable for garbage bins. They should be delivered to recycling centres instead.
- Contact relevant centres in order to obtain information on methods and points of disposal.

Safety Information

When you take delivery of your machine

- If you see any damage on your machine's packaging, please notify your retailer.
- Unwrap the packaging materials as indicated and dispose of them in accordance with the rules.

The points to pay attention during machine installation

- Choose a suitable, safe and level place to install your machine.
- Carry out the installation and connection of your machine by following the instructions.
- We recommend that the machine is installed by an authorised installer, and should only be serviced by an approved technician.
- Only original spare parts should be used with the machine.
- Before installing, be sure that the machine is unplugged.
- Check whether the indoor electrical fuse system is connected according to the regulations.
- All electrical connections must match values on the rating plate.
- Be sure that the machine does not stand on the electricity supply cable.
- Never use an extension cord or a multiple socket for making a connection. The plug should be easily accessible after installation.
- After installation, run it unloaded for the first time.

In daily use

- This machine is for household use; do not use it for any other purpose. Commercial usage of the dishwasher will void the guarantee.
- Do not use detergents and rinse aids that are not specifically designed for dishwashers. Improper use of such items may invalidate the warranty.
- Due to risk of explosion, do not put into the machine's washing section any chemical dissolving agents such as solvents.
- Check whether plastic items are heat-resistant before washing.

CHAPTER -2: SAFETY INFORMATION AND RECOMMENDATIONS

- This appliance can be used by children aged from 8 years and above and persons with reduced physical, sensory or mental capabilities or lack of experience and knowledge if they are supervised or have been given instruction concerning use of the appliance in a safe way and understand the hazards involved. Children should not play with the appliance. Cleaning and user maintenance shall not be made by children without supervision.
- Do not put unsuitable and heavy items above the basket capacity into your machine. SHARP will not be responsible for any damage on the inner parts.
- The door should not be opened whilst the machine is operating. A safety device will ensure that the machine stops if opened.
- To avoid accidents, do not leave the door open.
- Place knives and other sharp-ended objects in the cutlery basket in bladedown position.
- If the supply cord is damaged, it must be replaced by SHARP, or its service agent.
- If EnergySave option is selected as “Yes”, the door will be opened at the end of the program. Do not force the door closed to avoid harming the auto door mechanism for 1 minute. The door must be open for 30 minutes to dry effectively(in models with auto door opening system).

Warning: Do not stand in front of the door after the auto-open signal sounds.

For your children's safety

- After removing the machine's packaging, make sure that the packaging material is out of reach of children.
- Do not allow children to play with or start the machine.
- Keep children away from detergents and rinse aid.
- Keep children away from the machine while it is open because there may still be residues of cleaning substances inside the machine.
- Be sure that your old machine does not pose any threat to your children. Children are known to have become locked in old machines. To prevent such a situation, break your machine's door lock and tear off the electrical cables.

In case of malfunction

- Any repair performed by anyone other than authorized service personnel will invalidate your warranty.
- Prior to any repair work on the machine, be sure that the machine is isolated from the mains. Switch off the fuse or unplug the machine. Do not pull by the cable when unplugging. Make sure to turn off the water tap.

Recommendations

- For energy and water saving, remove coarse residues on your dishes before placing the dishes into the machine. Start your machine after having fully loaded it.
- Use the pre-wash programme only when necessary.
- Place hollow items such as bowls, glasses and pots into the machine in such a way that they will face down.
- You are not recommended to overload your machine or load it in a way other than that which is indicated.

Items not suitable for dishwashing:

- Cigarette ash candle leftovers, polish, paint, chemical substances, ironalloy materials.
- Forks, spoons and knives with wooden or bone, or ivory or nacre-coated handles; glued items, items soiled with abrasive, acidic or base chemicals.
- Plastic items that are not heat-resistant, copper or tin-coated containers.
- Aluminium and silver objects (they may discolour, become dull).
- Certain delicate glass types, porcelain with ornamental printed patterns as they fade even after the first wash; certain crystal items as they lose their transparency over time, cutlery that is not heat-resistant, lead crystal glasses, cutting boards, items manufactured with synthetic fibre.
- Absorbent items as sponges or kitchen rags are not suitable for dishwashing.

Warning: Take care to buy dishwasher-proof sets in your future purchases.

INSTALLING THE MACHINE

Positioning the machine

When determining the installation place, choose an accessible place for easy loading and unloading of the dishes.

Do not put your machine in any location where there is the possibility of the room temperature falling below 0°C.

Before positioning, take the machine out of its packaging by following the warnings located on the package.

Position the machine close to a water tap or drain. You need to site your machine, taking into consideration that its connections cannot be altered once they are made.

Do not grip the machine by its door or panel in order to move it.

Take care to leave sufficient clearance from all sides of the machine for moving it back and forth during cleaning.

Make sure that the water inlet and outlet hoses do not get squeezed while positioning the machine. Also, make sure that the machine does not stand on the electrical cable.

Adjust the machine's adjustable feet so that it can stand level and balanced. Proper positioning of the machine ensures problem-free opening and closing of the door.

CHAPTER -3: INSTALLING THE MACHINE

If the door of machine does not close properly, check if the machine is stable on the floor if not, adjust the feet and ensure its stable position.

Water connection

Indoor plumbing must be suitable for installing a dishwasher. Also, we recommend that you fit a filter at the entrance of your property so as to avoid any damage to your machine because of contamination (sand, clay, rust etc.) that might be occasionally carried in through the mains water supply or the indoor plumbing, and to prevent such complaints as yellowing and formation of deposits after washing.

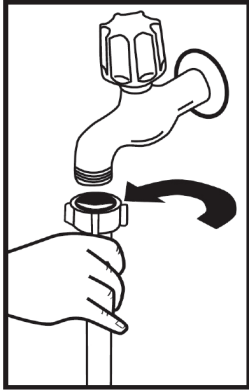

Water inlet hose

Do not use the water inlet hose of your old machine. Use the new one supplied with your machine instead. If you connect a new or long - unused water inlet hose to your machine, run water through it for a while before making the connection. Connect the water inlet hose directly to the water inlet tap. The pressure supplied by the tap should be at a minimum of 0.03 Mpa and at a maximum of 1 Mpa. If the water pressure is above 1 Mpa, a pressure-relief valve should be fitted in between.

After making connections, the tap should be turned on fully and checked for water tightness. For safety purposes, we recommend that you turn off the water inlet tap when the machine is not going to be used for an extended period of time.

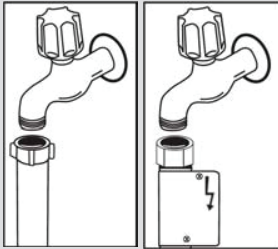

NOTE: An Aquastop water etc. spout is used in some models. With Aquastop, a potentially dangerous tension exists. Do not cut the Aquastop water spout. Do not let it get folded or twisted.

Water outlet hose

The water drain hose can be connected either directly to the water drain hole or to the sink outlet spigot. Using a special bent pipe (if available), the water can be drained directly into the sink via hooking the bent pipe over the edge of the sink. This connection should be between 50 and 110 cm from the floor plane.

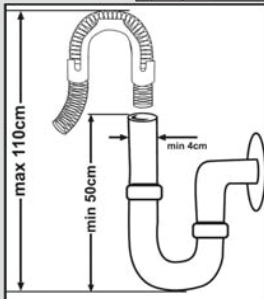

CHAPTER -3: INSTALLING THE MACHINE

Warning: When a drain hose longer than 4 m is used, the dishes might remain dirty. In that case, SHARP will not accept responsibility.

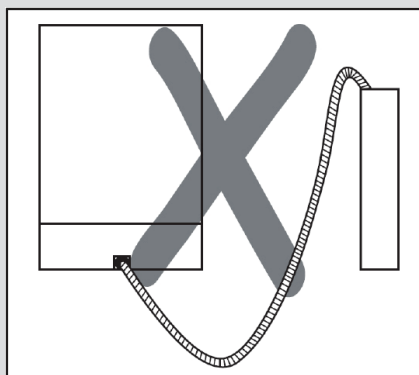
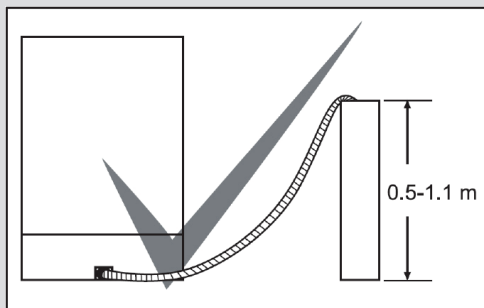

Electrical connection

The earthed plug of your machine should be connected to an earthed outlet supplied by suitable voltage and current. If there is no earthing installation, have a competent electrician to carry it out. In case of usage without earthing installed, our company will not be responsible for any loss of usage that might occur.

The indoor fuse current value should be 10-16 A.

Your machine is set according to 220-240 V. If the mains voltage in your location is 110 V, connect a transformer of 110/220 V and 3000 W inbetween.

The machine should not be plugged in during positioning.

Always use the coated plug supplied with your machine.

Running in low voltage will cause a decline in washing quality.

The machine's electrical cable should be replaced by an authorised service or an authorised electrician only. Failure to do so may lead to accidents.

CHAPTER -3: INSTALLING THE MACHINE

For safety purposes, we recommend that you disconnect the plug when the machine is not going to be used for an extended period of time.

In order avoid electric shocks, do not unplug when your hands are wet.

When disconnecting your machine from the mains supply, always pull from the plug. Never pull the cord itself.

Fitting the machine undercounter

If you wish to fit your machine undercounter, check whether you have sufficient space under your countertop and whether the wiring-plumbing is suitable to do so. **1** If you decide that the space under the countertop is suitable for fitting your machine, remove the worktop as shown in the illustration. **2**

Warning: The surface which you place the machine under when removing its worktop has to be stable to avoid balance problems.

To remove the worktop, remove the screws that hold the worktop which are located at the rear of the machine; then push the front panel 1 cm from the front side towards the rear and lift it.

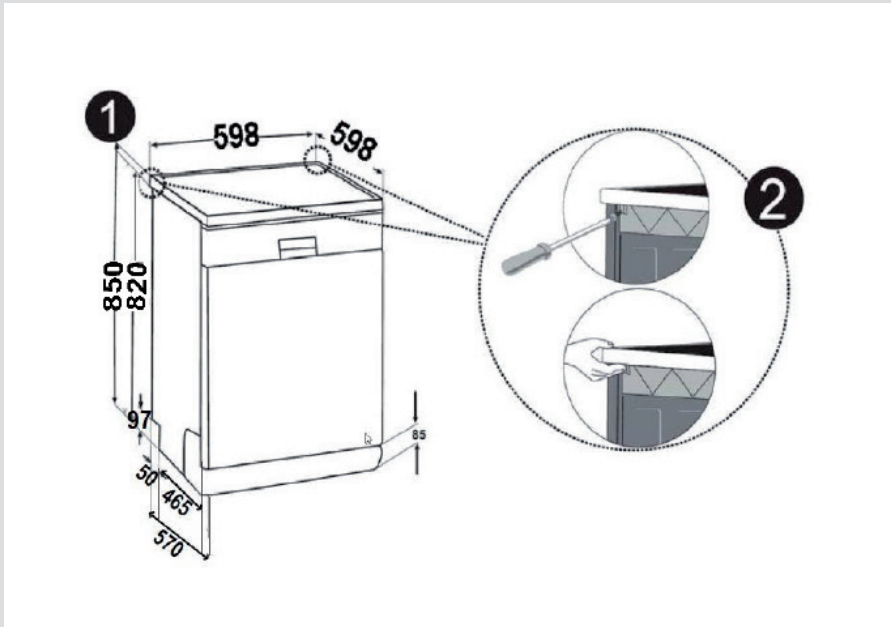

CHAPTER -3: INSTALLING THE MACHINE

Adjust the machine's feet according to the slope of the floor.**3** Fit your machine by pushing it undercounter without letting the hoses get crushed or bent.**4**

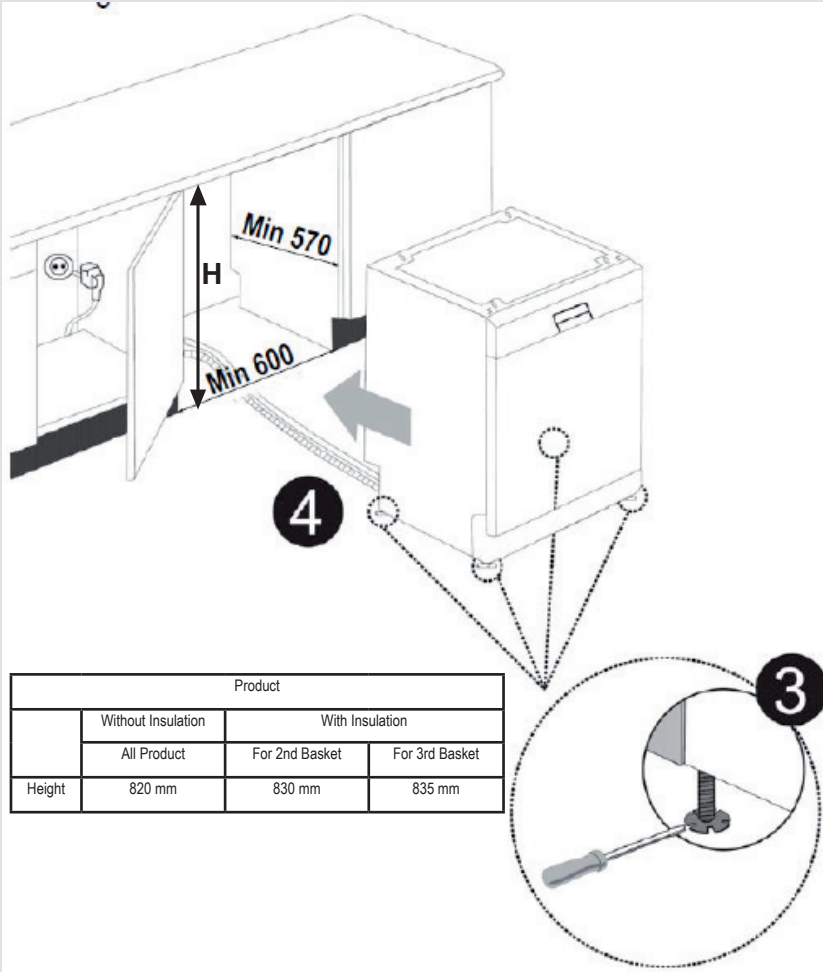

Warning: After removal of the worktop, the machine should be placed in such a closed place of which dimensions are shown at fig.

CHAPTER -4: PREPARING THE MACHINE FOR USE

Prior to using the machine for the first time

- Check whether the electricity and supply water specifications match the values indicated by the installation instructions for the machine.
- Remove all packaging materials inside the machine.
- Set the water softener.
- Add 2 kg salt into the salt compartment and fill with water up to a level at which it will almost overflow.
- Fill the rinse aid compartment.

PREPARING THE MACHINE FOR USE

The importance of water decalcification

For a good washing function, the dishwasher needs soft, i.e. less calcareous water. Otherwise, white lime residues will remain on the dishes and the interior. This will negatively affect your machine's washing, drying and shining performance. For this reason, a softener system is used on dishwashers. The softener system has to be refreshed so that it operates with the same performance also during the next wash. For this purpose, dishwasher salt is used.

Filling with salt

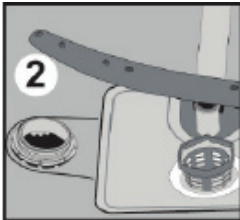
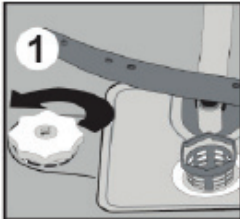



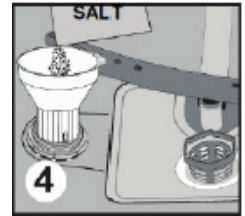







Use softener salt specifically produced for use in dishwashers. To put softener salt, first remove the lower basket and then open the salt compartment cap by turning it counter clockwise. 1 2 At first use fill the compartment with 2kg salt and water 3 at overflowing level. If available, using the funnel 4 provided will make filling easier. refit the cap and close it. After every 20th-30th wash, add salt into your machine until it fills up (approx. 1.5 kg). Fill the salt compartment with water at first use only. We recommend to use smallgrained or powder softener salt. Do not put table salt into your machine. Otherwise, the function of the softener the compartment may decrease over time. When you start the machine, the salt compartment gets filled with water. Therefore, add the softener salt prior to starting your machine. This way, overflowing salt gets immediately cleaned up through the wash operation. If you will not wash any dishes immediately after adding salt, then run a short washing program with an empty machine in order to avoid corrosion on your machine due to the salt overflow while filling the salt container. In order to understand whether or not the amount of

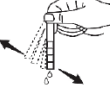

softener salt in the machine is sufficient, check the transparent section on the salt compartment cap. There is sufficient salt if the transparent section is green. Salt has to be added if it is not green.

Testing strip

The washing effectiveness of your machine depends on the softness of the tap water. For this reason, your machine is equipped with a system that reduces the hardness in mains water supply. The washing effectiveness will increase when the system is correctly set. To find out the water hardness level of water in your area, contact your local water board or determine water hardness level by using the test strip(if available).

Open the testing strip	Run water through your tap for 1 min.	Keep the testing strip in water for 1.sec.	Shake the testing strip after taking it out of water	Water for 1 min.	Make your machine's water hardness setting according to the result obtained through the testing strip.
					Level 1  No Lime Level 2  Very low lime content Level 3  Low lime content Level 4  Medium lime content Level 5  Lime content Level 6  High lime content

CHAPTER -4: PREPARING THE MACHINE FOR USE

Water hardness level	German hardness level dH	French hardness level dF	British hardness level dE	Hardness Level Indicator
1	0-5	0-9	0-6	L1 is seen on display.
2	6-11	10-20	7-14	L2 is seen on display.
3	12-17	21-30	15-21	L3 is seen on display.
4	18-22	31-40	22-28	L4 is seen on display.
5	23-31	41-55	29-39	L5 is seen on display.
6	32-50	56-90	40-63	L6 is seen on display.

Adjust the water hardness setting of your machine according to the level specified on the test strip.

NOTE: Hardness level is adjusted to level 3 as a factory setting.



Push the Programme selection button and hold down. (1)

In the meantime, power on the machine by pushing ON/OFF button. (2)

Hold down the programme selection button until "SL" on the screen goes off. After "SL" goes off, release the programme button. (1)

The machine will show the last water softening setting carried out.

You can change the water hardness setting by pressing on "+" and "-" buttons on the display. (3)

After adjusting water hardness setting, press the ON/OFF button to save the settings in the memory.

Detergent usage

Use a detergent specifically designed for use in domestic dishwashers.

You can find powder, gel, and tablet detergents that have been designed for household dishwashers.

Detergent should be put into the compartment prior to starting the machine. Keep your detergents in cool, dry places out of reach of your children.

Do not overfill the detergent compartment; otherwise it may cause scratches on your glasses as well as lead to a poorly dissolved detergent.

Should you need more information concerning the detergent you will use, contact the detergent manufacturers directly.

Filling the detergent compartment

Push the latch to open the detergent container as shown in the image. 1 The Detergent pod has level lines inside. The Detergent pod can take a total of 40 cm³ of detergent. Open the dishwasher detergent and pour into the larger compartment **b** 25 cm³ if dishes are heavily soiled or less 15 cm³. 2 If dishes have been kept dirty for a very long time, dried food wastes on them or overly loaded the dishwasher, pour a 5cm³ of detergent into the prewash compartment and start the machine. You may have to add more detergent into your machine, depending on the degree of soil and on the water hardness level in your area.

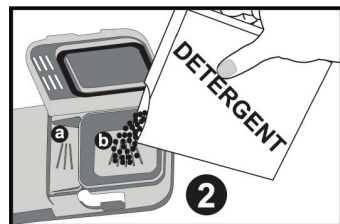
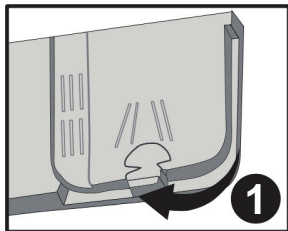

CHAPTER -4: PREPARING THE MACHINE FOR USE

Combined detergents

Combined detergents may include various properties. Before using the detergent, read the instructions carefully. Generally combined detergents produce sufficient results under certain conditions only.

Points to consider when using this type of products:

- Check the specifications of the product whether it is combined or not.
- Check if the detergent used is appropriate for the hardness of mains water.
- Observe the instructions of products on packagings.
- Always put the tablets into the detergent compartment in the detergent dispenser.
- You need to contact the manufacturers and find out about the suitable conditions of use.
- If you use appropriate products, they ensure savings in salt and/or rinse aid consumption.
- The scope of warranty for your machine does not cover any complaints caused by the use of these types of detergents.

Recommended usage: If you want to obtain better results while using combined detergents, add salt and rinse aid into your machine and adjust the water hardness setting and the rinse aid setting to the lowest position.



Solubility of the tablet detergents produced by different companies can vary depending on the temperature and time. Therefore, it is not recommended to use such detergents in short programs. It is more suitable to use powder detergents in such programs.

Warning: Should any problem, which you have not encountered before arise with the use of this type of detergent, contact the detergent manufacturer directly.

When you stop using combined detergents

- Fill the salt and rinse aid compartments.
- Adjust the water hardness setting to the highest position and run an empty-wash.
- Adjust the water hardness level.
- Make the suitable rinse aid setting.

Filling with rinse aid and making the setting

Adequate amount of rinse aid prevents the accumulation of white water drops, lime stains, white film stripshaped. It also increases drying performance.

To add rinse aid, remove the rinse aid compartment cap by turning it. 1 Fill the rinse aid compartment with rinse to add rinse aid level indicator becomes dark; 2 refit the cap and close it by turning it in a way that the nails, remove the rinse aid compartment cap by turning it. Will correspond to one another. By checking the rinse aid level indicator on the detergent dispenser, you can understand whether or not your machine needs rinse aid. A dark indicator **b** means that there is rinse aid in the compartment, while a light indicator **a** shows that you need to fill the compartment with rinse aid.

The rinse aid level adjuster can be set to a position between 1 and 6. Factory setting for rinse aid is the position 3.

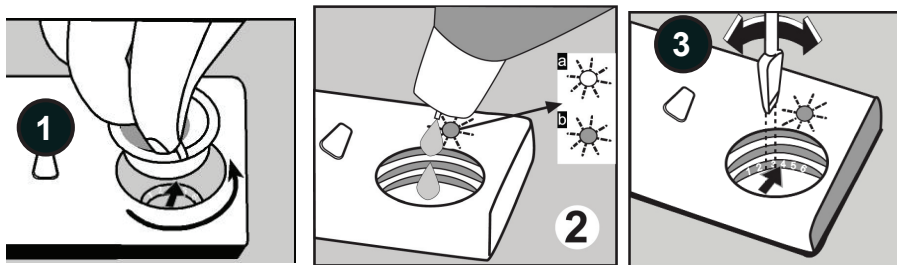

You need to increase the degree of the adjuster if water stains form on your dishes after a wash, whereas you need to decrease the degree if a blue stain is left when wiped by hand. 3

Warning: Use only those rinse aid materials which are allowed for use in the machine. As rinse aid residues left as a result of overflowing will create extremely high amounts of foam and thus reduce the washing performance, remove the excess amount of rinse aid by wiping it with a rag.

CHAPTER-5: LOADING YOUR DISHWASHER

LOADING YOUR DISHWASHER

Place dishes properly into the machine.

There are two separate baskets to load dishes into your machine. The lower basket is for round and deep items. The upper basket is for thin and narrow items. You are recommended to use the cutlery basket in order to obtain the best result.

To avoid any possible injuries, place long-handle and sharp-pointed knives with their sharp points facing down or horizontally on the baskets.

Warning: Place your dishes into your machine in a way that they will not prevent the upper and lower spray arms from spinning.

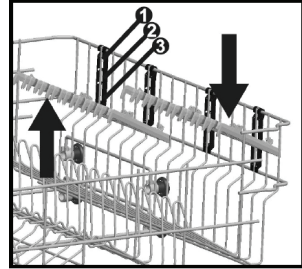

Dish rack

You can place different sizes of glasses under these racks thanks to the adjustable height feature. You can use racks in 3 different heights.

Top basket height adjustment while it is full

Basket height adjustment mechanism on the top basket of your machine is designed to let you adjust the height of your top basket upwards or downwards, without removing it from your machine when it is full, and create large spaces at the top or bottom area of your machine as needed. Basket of your machine is set to upper position in factory settings. In order to raise your basket, hold it from both sides again, and pull it upwards. In order to lower it, hold it from both sides again, and leave it. In loaded basket adjustment mechanism, make sure that both sides are in the same position (up or down)

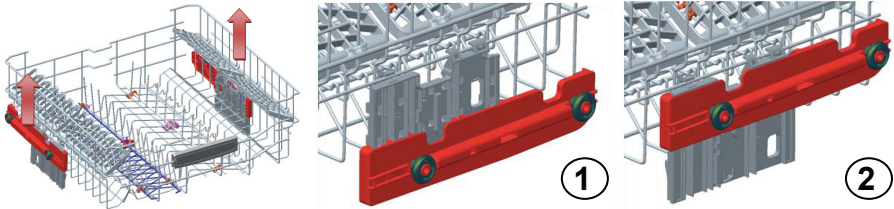

Lower Basket

Folding Racks

Folding racks consist of four parts in order to let you place big items more easily such as pots, pans, etc. If desired, each part can be folded separately in order to obtain larger space.

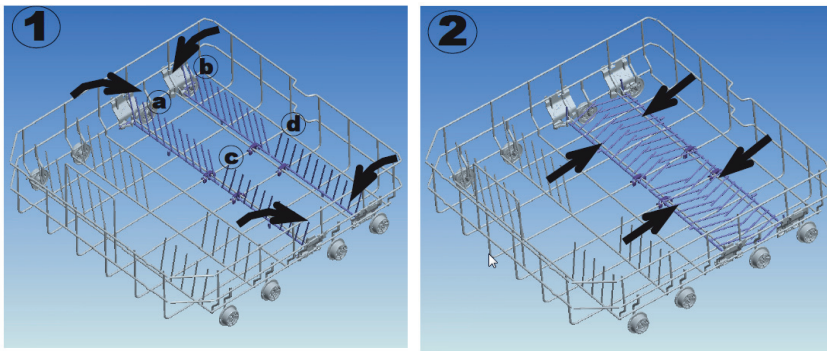

CHAPTER-5: LOADING YOUR DISHWASHER

The movable cutlery basket can slide between the front and rear wires of the bottom basket.



CHAPTER-5: LOADING YOUR DISHWASHER

Alternative basket loads

Lower Basket

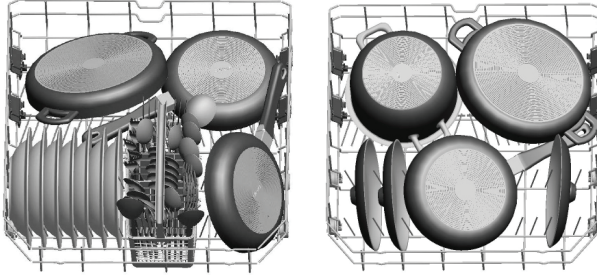

Top basket

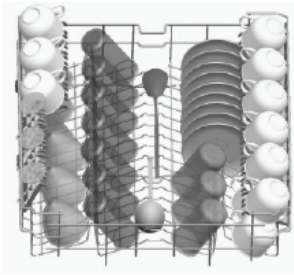

Faulty loads

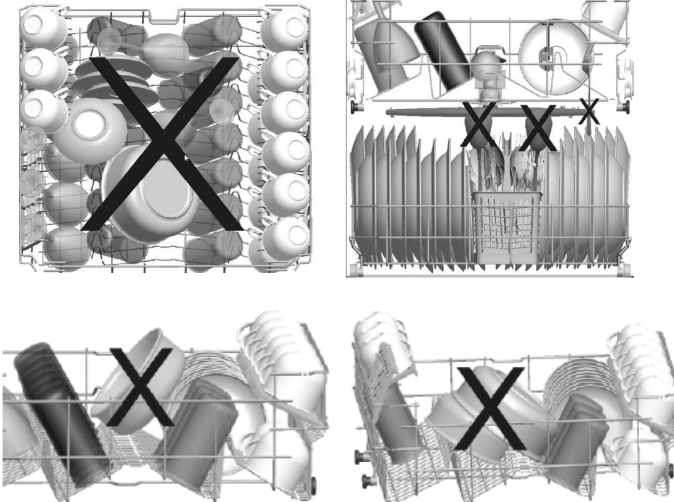

Important Note for Test Laboratories

For detailed information on performance tests, please contact following address: "dishwasher@standardtest.info". In your email, please provide the model name and serial number (20 digits) which you can find on the appliance door.

CHAPTER -6: PROGRAMME DESCRIPTIONS

Programme items

Programme No					
Programme names and temperatures	Pre-washing	Auto Delicate 30-50°C	Auto Normal 50-60°C	Auto Intense 60-70°C	Quick 30 min. 40°C
Type of food waste	Fresh less dirty, coffee,milk, tea	Detects contamination level of dishes and sets temperature and amount of washing water and washing period automatically.			Fresh coffee, milk, tea, cold meat, vegetables
Level of soil	small	small	high	high	small
Detergent amount B: 25 cm ³ / 15 cm ³ A: 5 cm ³	A*	B	A+B	A+B	B
	35°C Wash	Detects contamination level of dishes and sets temperature and amount of washing water and washing period automatically			Prewash
	Hot Rinse				40° C Wash
	End				Cold Rinse
					Hot Rinse
					Dry
					End
Programme duration (min.)	18	64 - 92	100 - 127	111 - 183	30
Electricity consumption (kW hours)	0.45	0.80 - 0.99	1.13 - 1.46	1.30 - 1.95	0.88
Water consumption (liters)	7.7	10.6 - 17.7	10.9 - 18.5	12.3 - 24.6	10.9
If you choose half load option values change into ;					
Programme duration (min.)	18	62 - 81	100 - 127	113 - 163	30
Electricity consumption (kW hours)	0.45	0.77 - 0.96	1.10 - 1.43	113 - 163	10.9
Water consumption (liters)	7.7	9,9 -13,7	10.9 - 18.5	11.3 -19.9	10.9

Warning: Short programs do not include a drying step.

The values declared above are the values obtained under laboratory conditions according to relevant standards. These values can change depending on conditions of product's use and environment (network tension, water pressure, water input temperature and environment temperature).

CHAPTER -6: PROGRAMME DESCRIPTIONS

Programme items

Programme No			
Programme names and temperatures	Eco 50° C	**Super 50 min.	Daily 65° C
Type of food waste	Fresh coffee, milk, tea, cold meat, vegetables	Tarried soup, sauce, pastry, egg, rice, potato and meals cooked in oven, fried food	Fresh coffee, milk, tea, cold meat, vegetables
Level of soil	medium	medium	medium
Detergent amount B: 25 cm ³ / 15 cm ³ A: 5 cm ³	A+B	A+B	A+B
	Prewash	65°C Wash	Prewash
	50° C Wash	65°C Wash	60°C Wash
	Cold Rinse	Cold Rinse	Cold Rinse
	Hot Rinse	Hot Rinse	Hot Rinse
	Dry	End	Dry
	End		End
Programme duration (min.)	156	50	90
Electricity consumption (kW hours)	0.90	1,31	1.38
Water consumption (liters)	9,0	10.7	14.4
If you choose half load option values change into ;			
Programme duration (min.)	144	42	78
Electricity consumption (kW hours)	0.88	1,31	1.35
Water consumption (liters)	9,0	10.7	11.1

* Only powder detergent should be used in cycle of prewash programme.

** You can wash your dishes through washing performance A by using cycle of Super 50 min.

CHAPTER -7: SWITCHING ON THE MACHINE AND SELECTING A PROGRAMME

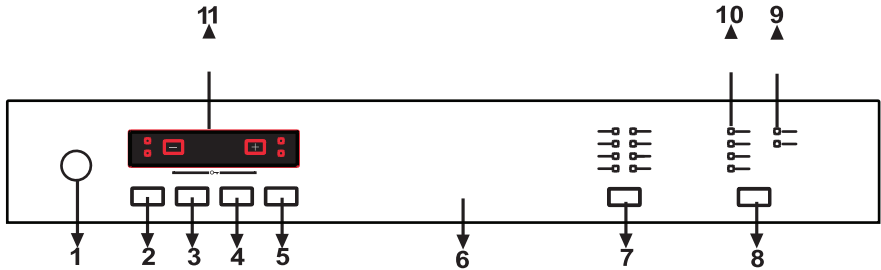

1.) ON/OFF Button

When the ON/OFF button is pressed, the machine powers up and the Start/Standby light comes on.

2.) Extra Rinse / Dry Button

You can add extra rinsing or drying functions into the selected program by using this button.

If you select the extra rinsing function, the light for extra rinsing on the upper left-hand side of the indicator will come on, and thus washing-rinsing steps will be added into the selected program.

If you select the extra drying function, the light for extra drying on the lower left-hand side of the indicator will come on, and thus the extra heating and drying steps will be added into the selected program.

3.) Extra Hygiene Button

By using this option, washing temperature and periods during respective cycles may be changed, which ensures more hygienic washing.

4.) Tablet Detergent Button

Push the Tablet Detergent button when using combined detergent that contains salt, rinse aid and extra functions.

5.) ½ Half Load Button

Using the function ½, three sorts of washing up can be done those being lower basket, upper basket and both baskets.



If you have a small amount of dishes in your machine and if you have to wash them, you can also activate the semi-filling function in some of the programs additionally. If you have dishes in both baskets, press the key ½ and select the position in which both lamps are highlighted.



If you have dishes only in the upper basket, press the key ½ and select the position in which the upper lamp is illuminated. Thus, washing up shall be done only on the upper basket of your machine. No dishes should be put in the lower basket while using this feature.



If you have dishes only in the lower basket, press the key ½ and select the position in which the lower lamp is illuminated.

CHAPTER -7: SWITCHING ON THE MACHINE AND SELECTING A PROGRAMME

Thus, washing up shall be done only on the lower basket of your machine. In using this feature, make sure that there are no dishes in the upper basket.

Note : If you have used an extra feature on the latest washing program, this feature will remain active also on the next washing program. If you do not want to use this feature on the newly selected washing program, press the selected feature button again, and check that the lamp on the button goes off.

6.) Door Handle

The door handle is used to open/close the door of your machine.

7.) Programme selector Button

With the program selector button, you can select a suitable program for your dishes.

8.) Start/Pause Button

Once you press the Start/Pause button, the programme you selected with the programme selector button will start running and the status indicator lamp "wash" will light up. In the stop condition while wash led is On, the Start/Pause led will blink.

9.) Salt Warning Indicator Light

In order to see whether the softening salt in your machine is sufficient or not, check the salt warning light on the display. When the salt light warning light starts coming on, you need to fill in the salt chamber.

Rinse aid Warning Indicator Light

In order to check that there is sufficient rinse aid in your machine check the rinse aid warning light on the display. When the rinse aid warning light starts coming on, fill in the rinse aid chamber.

10.) Program Monitor Lights

The program flow can be monitored via program monitor lights on control panel.

- Wash
- Rinse
- End

11.) Remaining Time Indicator

The Remaining Time Indicator displays the program times and remaining time during the program that is in operation. In addition, you can adjust the program delay time by pressing the buttons on the indicator before the program starts. If you want to change the delay time, you can set the time by pressing the Start/Pause button and using buttons on the indicator. Press the Start/Pause button again in order to activate.

Child Lock Operation

In order to activate the child lock, press "+" and "-" buttons on the Remaining time indicator simultaneously 3 for seconds. At this time, "CL" appears for 2 seconds on remaining time indicator. To deactivate child lock, press "+" and "-" buttons again simultaneously for 3 seconds. "CL" will blink for 1 times.

CHAPTER -7: SWITCHING ON THE MACHINE AND SELECTING A PROGRAMME

Switching on the machine

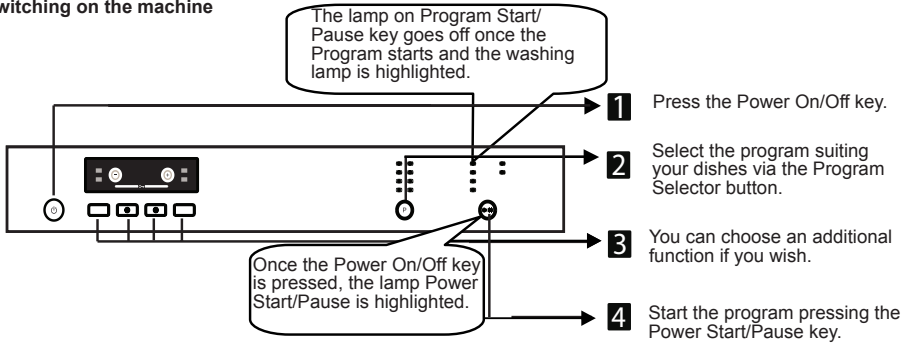

Program follow-up

You can follow the program flow using the program follow-up lamps located on the control panel.

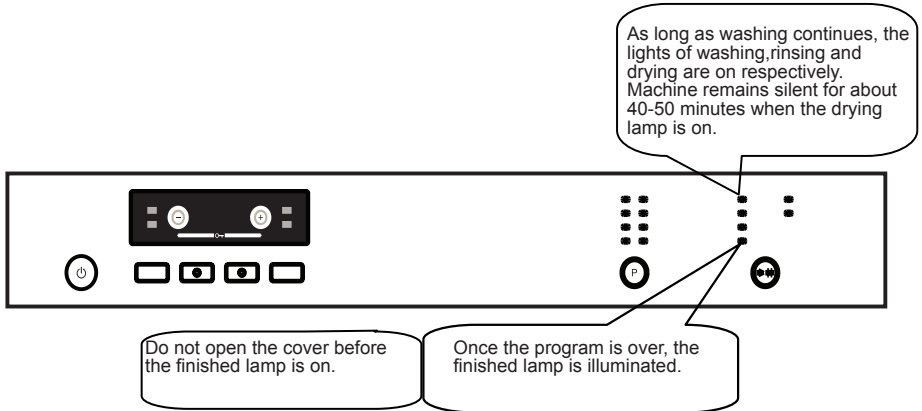

Changing a programme

If you would like to change programs while a washing program is continuing.

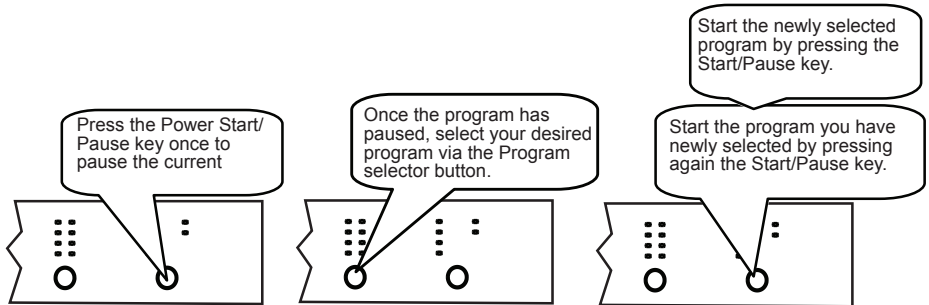

CHAPTER -7: SWITCHING ON THE MACHINE AND SELECTING A PROGRAMME

Changing a programme with resetting

If you would like to cancel a program while a washing program is resumed

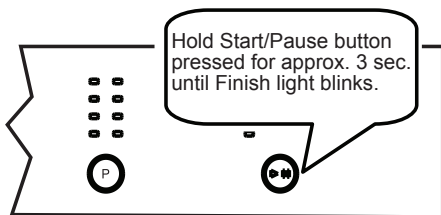

Once Finish light comes on, it means that the cycle has been cancelled.

After Finish light starts blinking, discharges the water inside for approx. 30 sec.

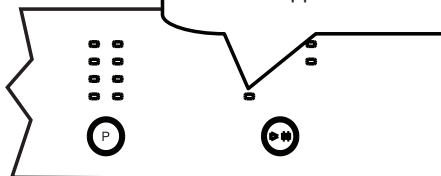

Switching the machine off

Pull the plug out of the outlet. Turn of the water tap.

When the lamp "End" lights up, switch your machine off by using the Power On/Off button.

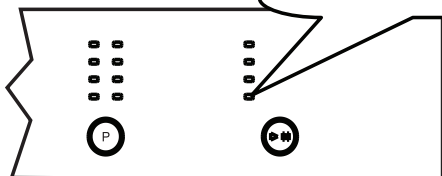

Note: You can slightly open the door in order for the machine to perform a faster dry operation after the wash programme is finished.

Note: If the machine door opens during washing or the power is cut off, the machine resume the program when the door is shut or the power comes back.

CHAPTER -8: MAINTENANCE AND CLEANING

Cleaning the machine regularly prolongs the machine's service life.

Oil and limescale may accumulate in the machine's washing section. In case of such accumulation;

-Fill the detergent compartment without loading any dishes into the machine, run the machine at high temperature. If this does not work, use special cleansing materials.

Cleaning the seals in the machine door,

-Wipe the seals regularly by using a dampened cloth.

Cleaning machine,

Clean the filters and spray arms at least once a week.

Unplug your machine and turn off its tap before starting the cleaning.

Wipe with a fine cleaning material and a dampened cloth.

Filters

If any food wastes have remained on the coarse and fine filters, remove the filters and clean them thoroughly under the water tap.

a. Micro Filter

b. Coarse Filter

c. Metal/Plastic Filter

To remove and clean the filter combination, turn it counter clockwise and take it out by lifting upwards. **1**

Pull and remove the metal/plastic filter. **3** Then pull the coarse filter out of the micro filter. **2** Rinse it with lots of water under the tap. Refit the metal/plastic filter. Insert the coarse filter into the micro filter in a way that the marks will correspond to one another. Attach micro filter into the metal/plastic filter and turn to the direction of arrow and it is locked when the arrow on micro filter can be seen from across. **4**

- Never use your dishwasher without a filter.
- Incorrect fitting of the filter will reduce the washing effectiveness.
- Clean filters are very important in terms of the proper running of the machine.

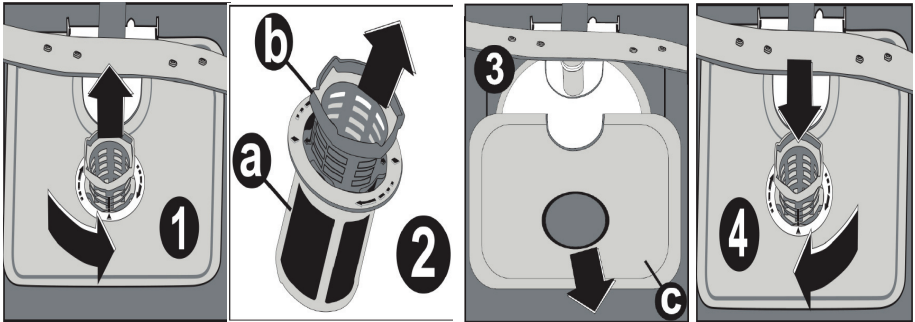

Spray arms

Check the holes for the upper and lower spray arms. If there is any clogging, remove the spray arms and clean them under water.

You can remove the lower spray arm by pulling it upwards, while the upper spray arm nut can be removed by turning the nut to the left. Be sure that the nut is perfectly tightened when refitting the upper spray arm.

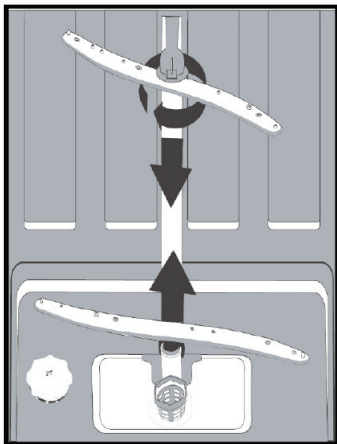

Hose filter

Check the filter and the hose from time to time and clean them to prevent yellowing and formation of deposits after washing. To clean the filter, first turn off your tap and then remove the hose. After removing the filter from the hose, clean it under the tap. Insert the cleaned filter back into its place inside the hose. Refit the hose.

CHAPTER -9: FAILURE CODES AND WHAT TO DO IN CASE OF FAILURE

ERROR CODE	ERROR DESCRIPTION	CONTROL
F5	Inadequate water supply	<ul style="list-style-type: none"> • Make sure the water input tap is totally open and that there is no water cut. • Close the water input tap, separate the water input hose from the tap and clean the filter at the connection end of the hose. • Restart your machine, contact the service if the error resumes.
F3	Error of continuous water input	<ul style="list-style-type: none"> • Close the tap. • Contact service.
F2	The waste water in the machine cannot be discharged.	<ul style="list-style-type: none"> • Water discharge hose is clogged. • The filters of your machine might be clogged. • Power off-on your machine and activate the program cancellation command. • If the error continues, contact the service.
F8	Heater error	<ul style="list-style-type: none"> • Contact service.
F1	Alarm is active against water overflow	<ul style="list-style-type: none"> • Power off your machine and close the tap. • Contact service.
FE	Faulty electronic card	<ul style="list-style-type: none"> • Contact service.
F7	Overheating error (temperature in the machine is too high)	<ul style="list-style-type: none"> • Contact service.
F9	Divisor position error	<ul style="list-style-type: none"> • Contact service.
F6	Faulty heater sensor	<ul style="list-style-type: none"> • Contact service.

If one of the program monitor lights is on and start/Pause light is on and off,
Your machine's door is open, shut the door.

If the programme won't start

- Check if the plug is connected.
- Check your indoor fuses.
- Be sure that the water inlet tap is turned on.
- Be sure that you have closed the machine door.
- Be sure that you switched off the machine by pressing the Power On / Off button.
- Be sure that the water inlet filter and the machine filters are not clogged.

If the lamps "Wash/Dry" and "End" keep flashing

- The water overflow alarm is active
- Turn off your tap and contact the Sharp helpdesk.

If the control lamps won't go out after a wash operation

Check if the Power On/Off button is released.

If detergent residues are left in the detergent compartment

Detergent has been added when the detergent compartment was wet.

If water is left inside the machine at the end of the programme

- The water drain hose is clogged or twisted.
- The filters are clogged.
- The programme is not finished yet.

If the machine stops during a wash operation

- Power failure.
- Water inlet failure.
- Program can be on standby mode.

If shaking and hitting noises are heard during a wash operation

- Dishes placed incorrectly.
- Spray arm hitting the dishes.

If there are partial food wastes left on the dishes

- Dishes placed incorrectly into the machine, sprayed water did not reach related places.
- Basket overly loaded.
- Dishes leaning against one another.
- Small amount of detergent added.
- An unsuitable, rather weak wash programme selected.
- Spray arm clogged with food wastes.
- Filters clogged.
- Filters incorrectly fitted.
- Water drain pump clogged.

CHAPTER -10: PRACTICAL AND USEFUL INFORMATION

If there are whitish stains on the dishes

- insufficient detergent is being used
- Rinse aid dosage setting at a very low level.
- No special salt is being used despite the high degree of water hardness.
- Water softener system setting is at a very low level.
- Salt compartment cap not closed well.

Won't dry no need for dry

- A programme without a dry operation has been selected.
- Rinse aid dosage set too low
- Dishes unloaded too fast.

If there are rust stains on the dishes

- Stainless-steel quality of the dishes washed is insufficient.
- High rate of salt in the wash water.
- Salt compartment cap not properly closed.
- Too much salt spilt into the sides and into the machine while filling it with salt.
- Poor mains grounding.

Call an authorised service if the problem still persists after the controls or in case of any malfunction not described above.

PRACTICAL AND USEFUL INFORMATION

- 1- When you won't be using your machine for an extended period
 - Unplug the machine and then turn the water off.
 - Leave the door slightly ajar in order to prevent the formation of unpleasant smells.
 - Keep the machine interior clean.
- 2- Eliminating water droplets
 - Wash the dishes with the intensive programme.
 - Take all of the metal containers in the machine out.
 - Do not add detergent.
- 3- If you properly place your dishes into the machine, you will be using it in the best way in terms of energy consumption, washing and drying performance.
- 4- Clean all rough waste before you place dirty dishes to the machine.
- 5- Operate the machine after it is completely full.
- 6- Use pre-washing program only when necessary.
- 7- Observe program information and average consumption values table when selecting a program.
- 8- Since the machine will reach high temperatures, it should not be placed near a refrigerator.
- 9- If the appliance is located in a place where the risk of freezing exists, you must completely drain the water that has remained in the machine. Turn off the water tap, disconnect the water inlet hose from the tap and allow the interior water to drain.

DISPOSAL OF YOUR OLD MACHINE

This symbol on the product or package implies that the product should not be treated as domestic waste. Instead, it should be delivered to waste collection places recycling electrical and electronic equipment. You will help avoid damage to the environment and risks to public health. Recycling materials will help natural resources to be preserved. For more detailed information regarding recycling of this product, please contact your local authority or the shop where you purchased the product from.





SHARP

Waterside Drive, Langley, Berkshire, SL3 6EZ, UNITED KINGDOM

52173661 R20