

ZONE WIRED USB-C TO A ADAPTER

Complete Setup Guide

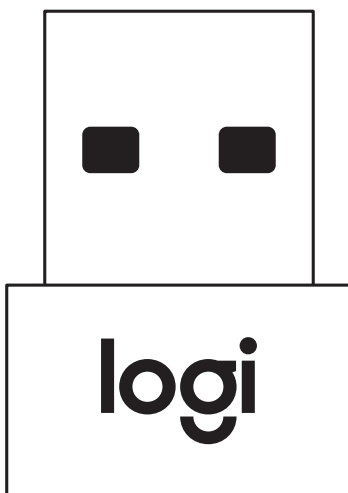

CONTENTS

English	3	Česká verze	33
Deutsch	5	Slovenčina	35
Français	7	Українська	37
Italiano	9	Eesti	39
Español	11	Latviski	41
Português	13	Lietuvių	43
Nederlands	15	Български	45
Svenska	17	Hrvatski	47
Dansk	19	Srpski	49
Norsk	21	Slovenščina	51
Suomi	23	Română	53
Ελληνικά	25	Türkçe	55
По-русски	27	57 العربية	
Po polsku	29	59 עברית	
Magyar	31		

KNOW YOUR PRODUCT

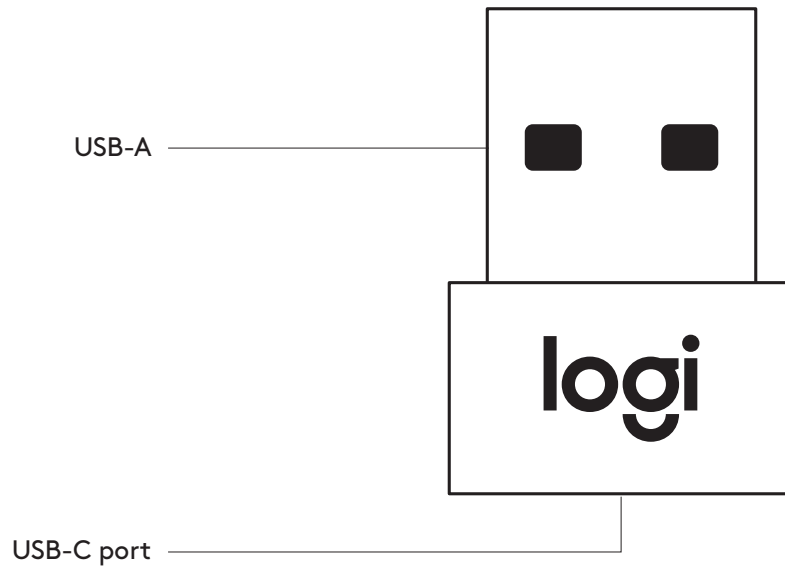

WHAT'S IN THE BOX

USB-C to A adapter



INSTRUCTIONS

- 1 Plug the USB-C connector into the USB-A adapter.

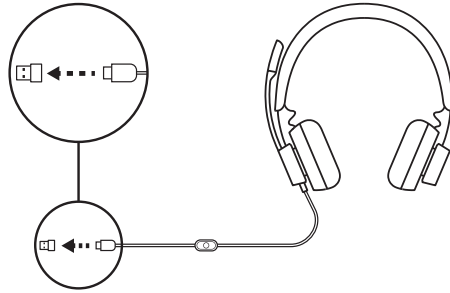

- 2 Plug the USB-A connector into your computer USB-A port.

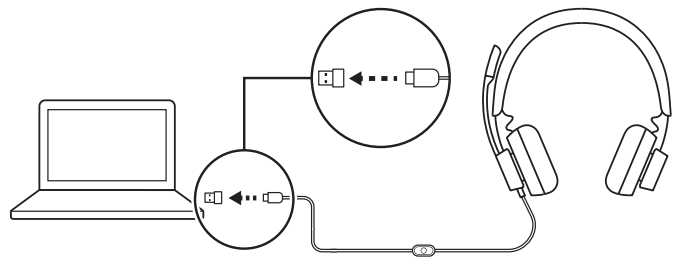

DIMENSIONS

ADAPTER:

Height x Width x Depth: 21.5 mm x 15.4 mm x 7.9 mm

www.logitech.com/support/zone-wired-adapter

PRODUKT AUF EINEN BLICK

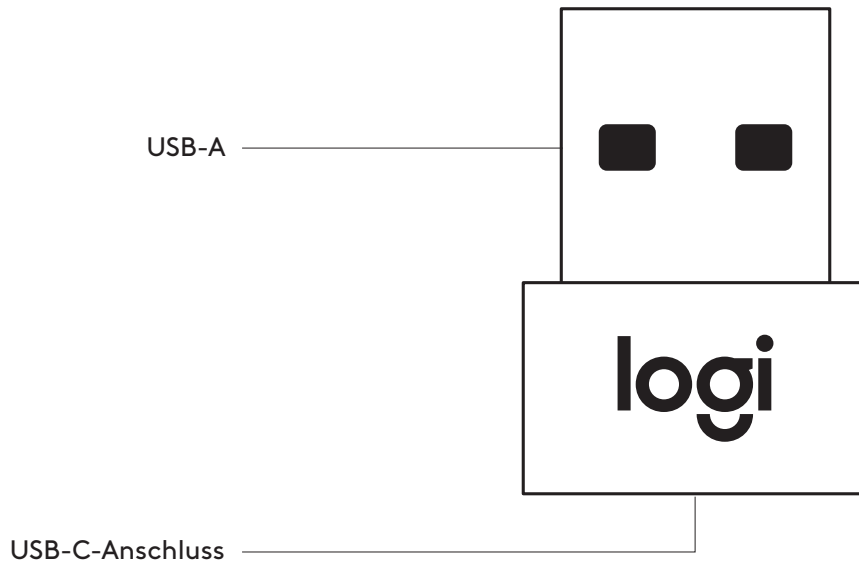

INHALT

USB-C-auf-A-Adapter



ANWEISUNGEN

- 1 Schließen Sie den USB-C-Stecker am USB-A-Adapter an.

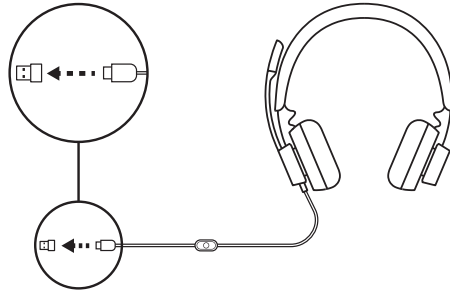

- 2 Schließen Sie den USB-A-Stecker am USB-A-Anschluss des Computers an.

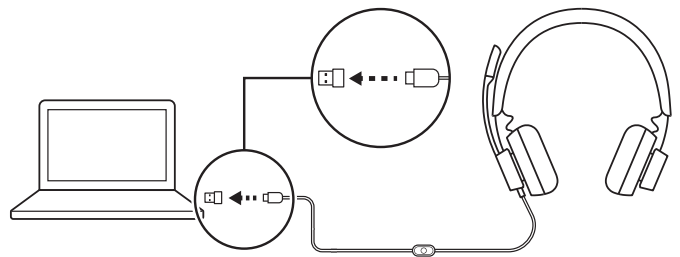

ABMESSUNGEN

ADAPTER

Höhe x Breite x Tiefe: 21,5 mm x 15,4 mm x 7,9 mm

www.logitech.com/support/zone-wired-adapter

PRÉSENTATION DU PRODUIT

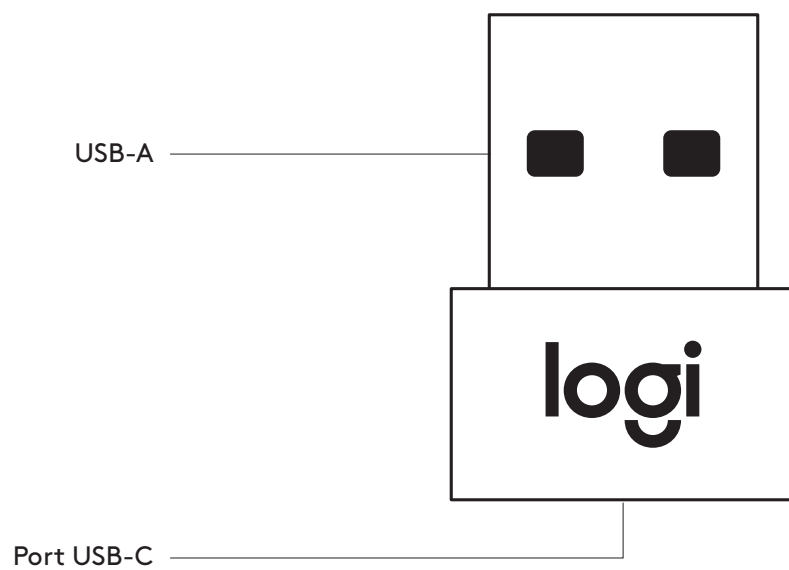

CONTENU DU COFFRET

Adaptateur USB-C vers A



INSTRUCTIONS

1 Branchez le connecteur USB-C à l'adaptateur USB-A.

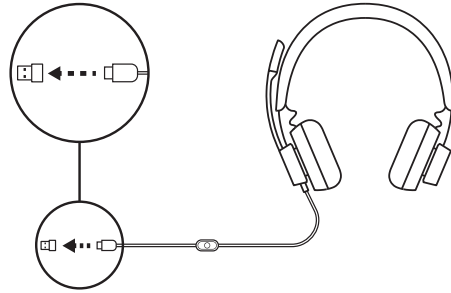

2 Branchez le connecteur USB-A dans le port USB-A de votre ordinateur.

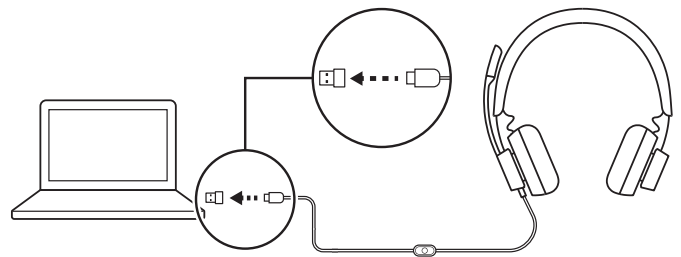

DIMENSIONS

ADAPTATEUR:

Hauteur x largeur x profondeur:
21,5 mm x 15,4 mm x 7,9 mm

www.logitech.com/support/zone-wired-adapter

SUSIPAŽINKITE SU SAVO PRODUKTU

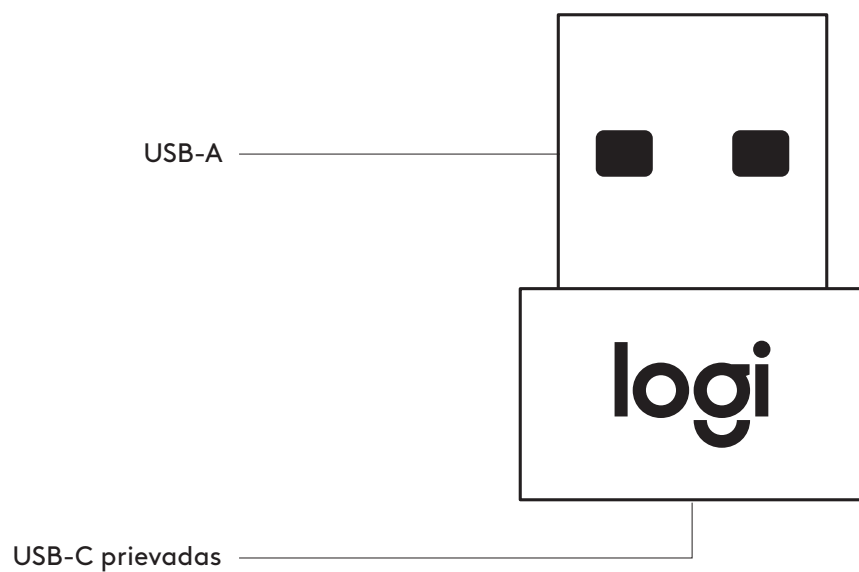

DĚŽUTĚJE YRA

USB-C ir A adapteris



INSTRUKCIJOS

1 Prijunkite USB-C jungtį prie USB-A adapterio.

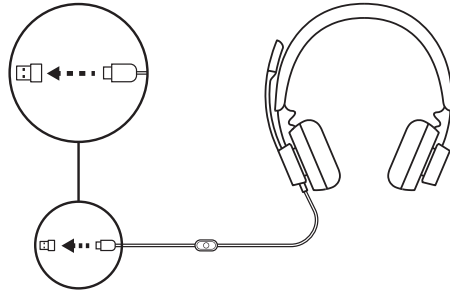

2 Prijunkite USB-A jungtį prie savo kompiuterio USB-A prievado.

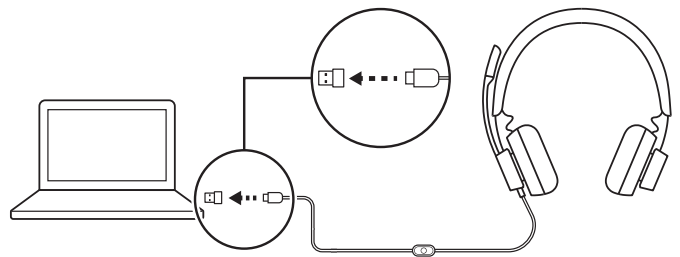

MATMENYS

ADAPTERIS:

aukštis x plotis x gylis: 21,5 mm x 15,4 mm x 7,9 mm

www.logitech.com/support/zone-wired-adapter

COMPONENTES DEL PRODUCTO

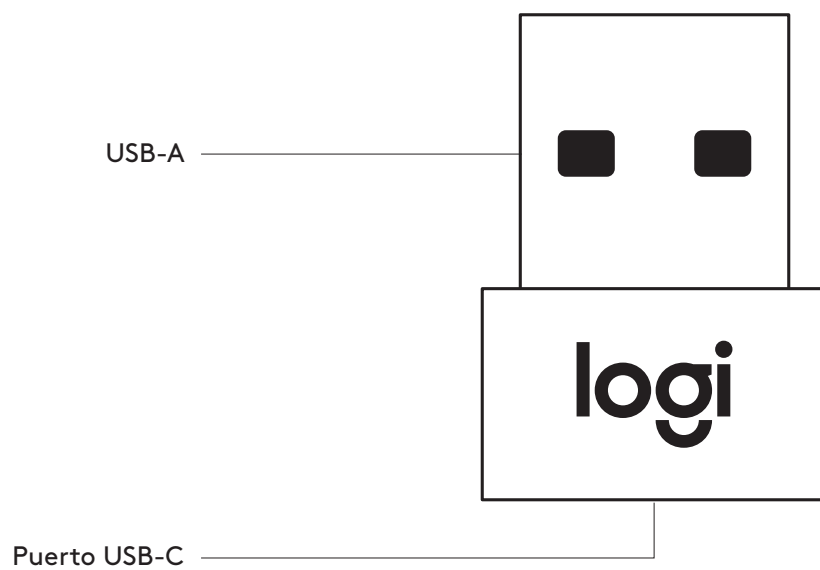

CONTENIDO DE LA CAJA

Adaptador USB-C a A



INSTRUCCIONES

1 Conecte el conector USB-C al adaptador USB-A.

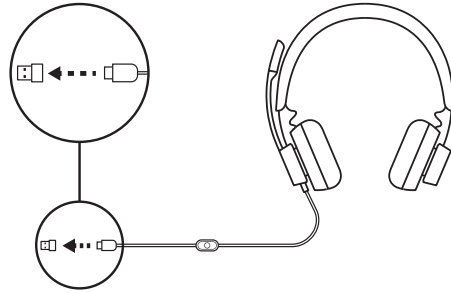

2 Conecte el conector USB-A al puerto USB-A del ordenador.

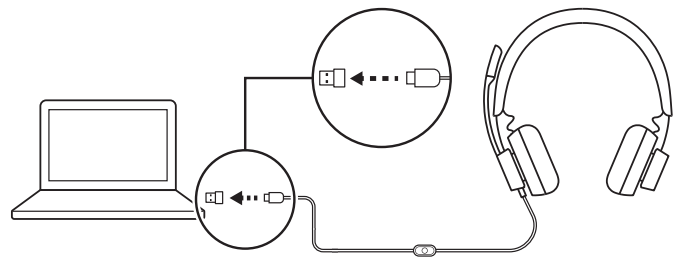

DIMENSIONES

ADAPTADOR:

Altura x Anchura x Profundidad:
21,5 mm x 15,4 mm x 7,9 mm

www.logitech.com/support/zone-wired-adapter

CONHEÇA O SEU PRODUTO

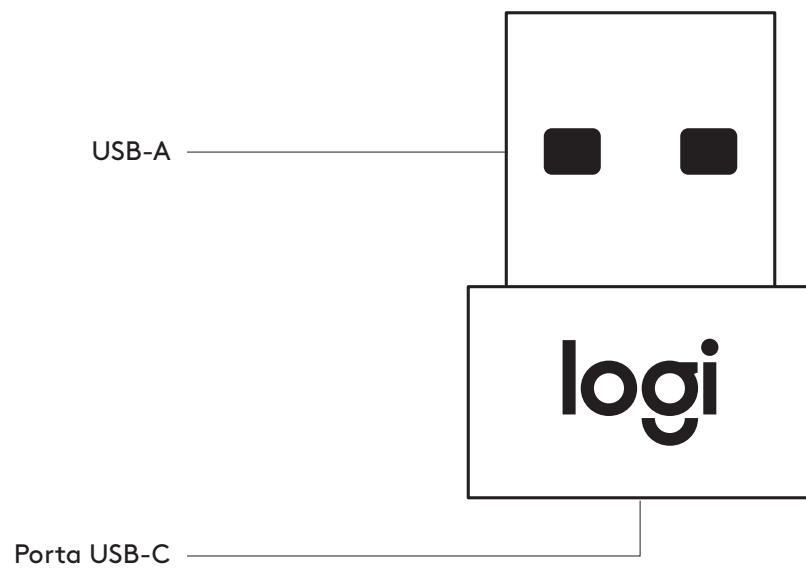

ITENS INCLUÍDOS NA EMBALAGEM

Adaptador USB C para A



INSTRUÇÕES

1 Ligue o conector USB-C ao adaptador USB-A.

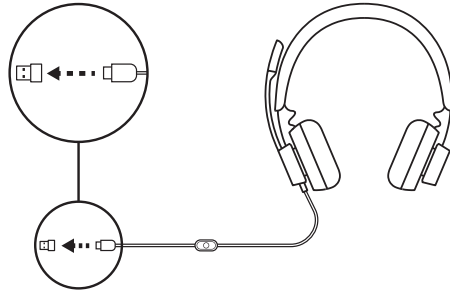

2 Ligue o conector USB-A à porta USB-A do seu computador.

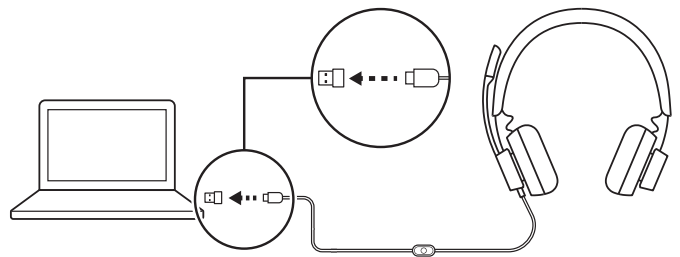

DIMENSÕES

ADAPTADOR:

Altura x largura x profundidade:
21,5 mm x 15,4 mm x 7,9 mm

www.logitech.com/support/zone-wired-adapter

KEN UW PRODUCT

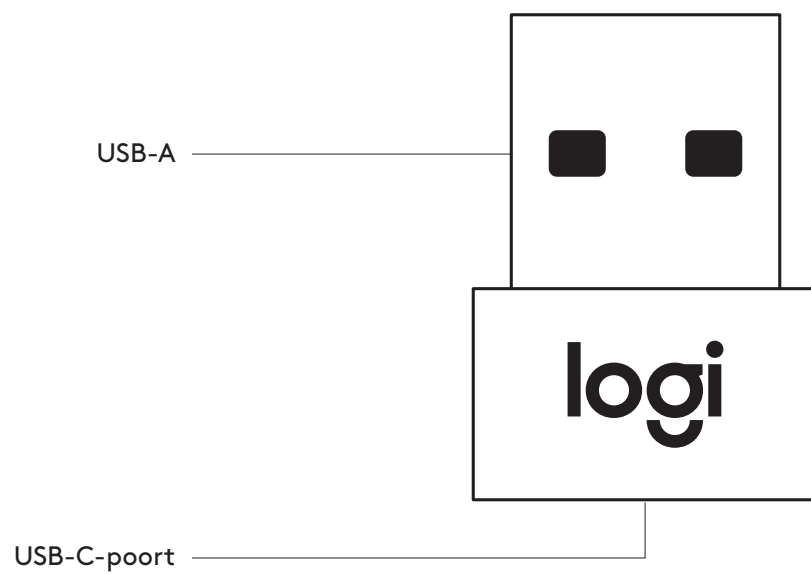

INHOUD VAN DE DOOS

Adapter USB-C naar USB-A



INSTRUCTIES

1 Sluit de USB-C-connector aan op de USB-A-adapter.

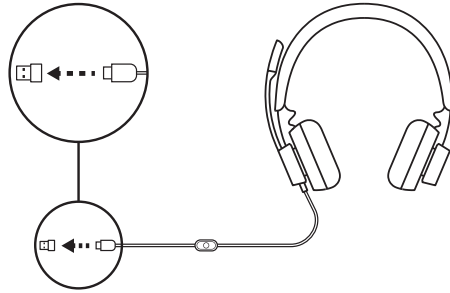

2 Sluit de USB-A-connector aan op de USB-A-poort van uw computer.

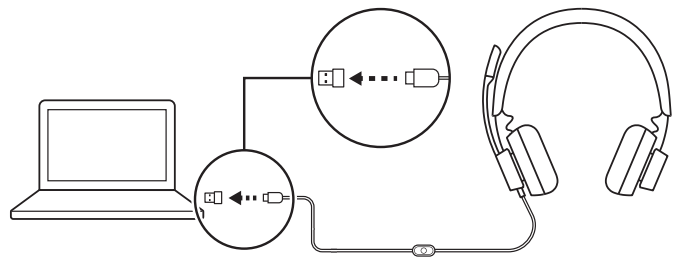

AFMETINGEN

ADAPTER:

Hoogte x breedte x diepte: 21,5 mm x 15,4 mm x 7,9 mm

www.logitech.com/support/zone-wired-adapter

PRODUKTÖVERSIKT

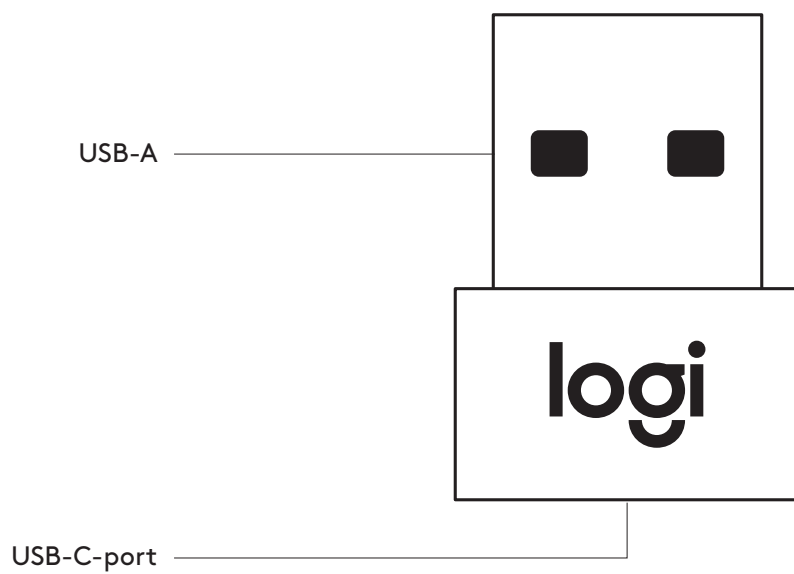

INNEHÅLL

USB-C- till A-adapter



ANVISNINGAR

1 Anslut USB-C-kontakten till USB-A-adaptern.

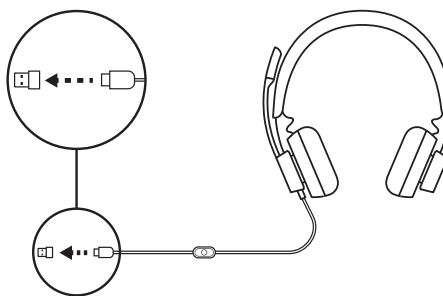

2 Anslut USB-A-kontakten till datorns USB-A-port.

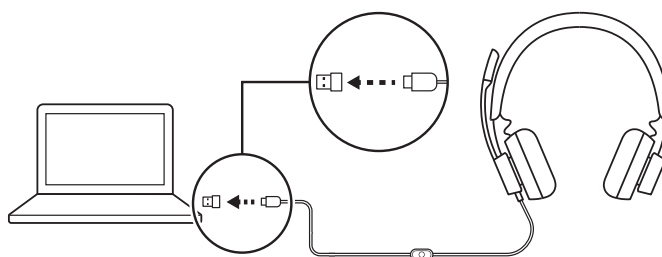

MÅTT

ADAPTER:

Höjd x bredd x djup: 21,5 mm x 15,4 mm x 7,9 mm

www.logitech.com/support/zone-wired-adapter

PRODUKTOVERSIGT

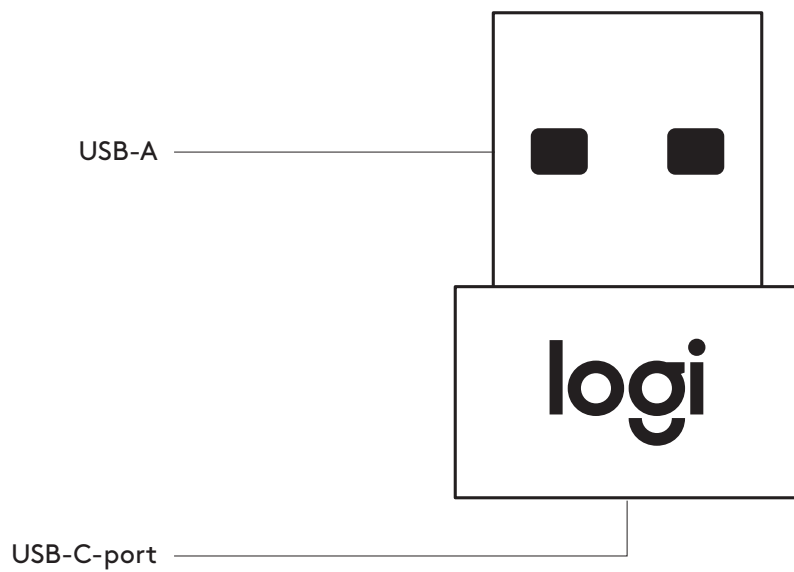

DET INDEHOLDER KASSEN

USB-C til A-adapter



ANVISNINGER

1 Slut USB-C-stikket til en USB-A-adapteren.

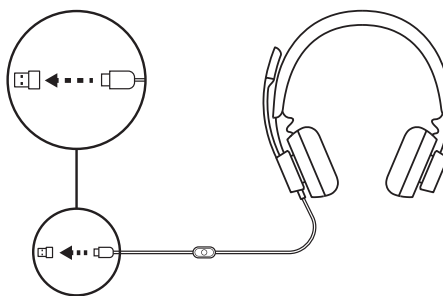

2 Sæt USB-A-stikket i computerens USB-A-port.

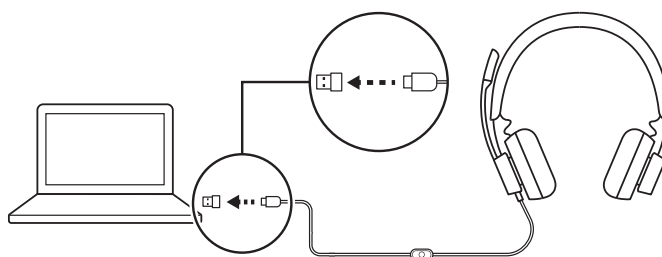

MÅL

ADAPTER:

Højde x bredde x dybde: 21.5 mm x 15.4 mm x 7.9 mm

www.logitech.com/support/zone-wired-adapter

BLI KJENT MED PRODUKTET

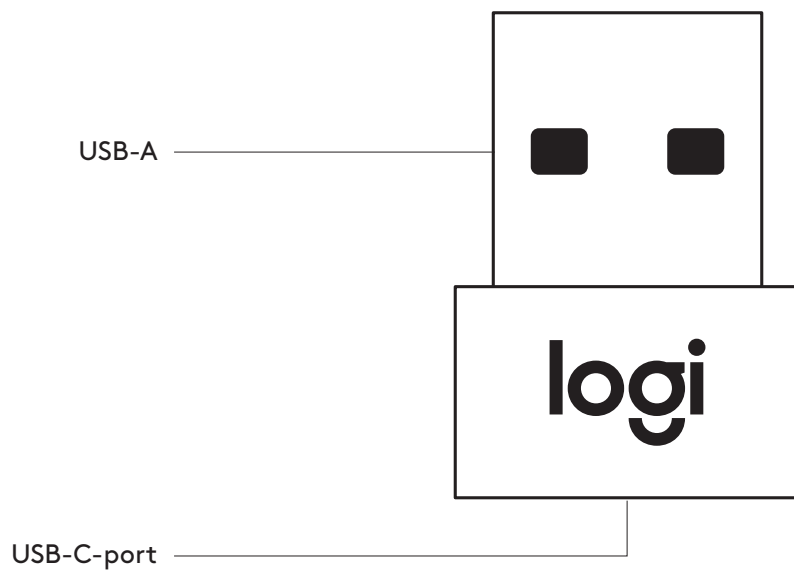

I ESKEN

USB-C til A-adapter

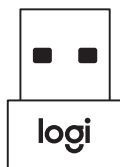

INSTRUKSJONER

1 Koble USB-C-kontakten til en USB-A-adapter.

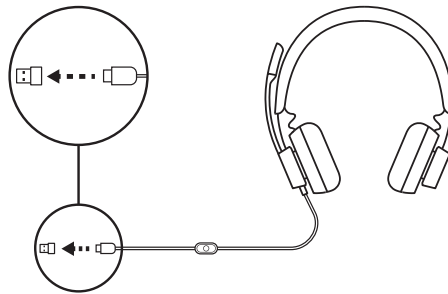

2 Koble USB-A-kontakten til datamaskinens USB-A-port.

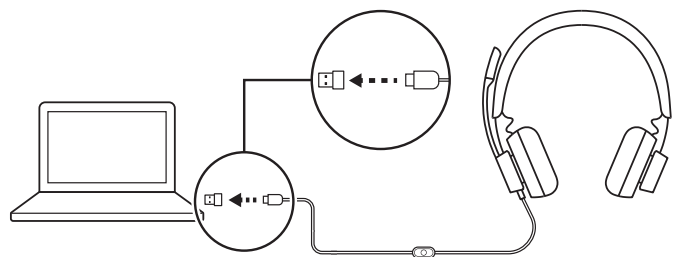

MÅL

ADAPTER:

Høyde x bredde x dybde: 21,5 mm x 15,4 mm x 7,9 mm

www.logitech.com/support/zone-wired-adapter

TUNNE TUOTTEESI

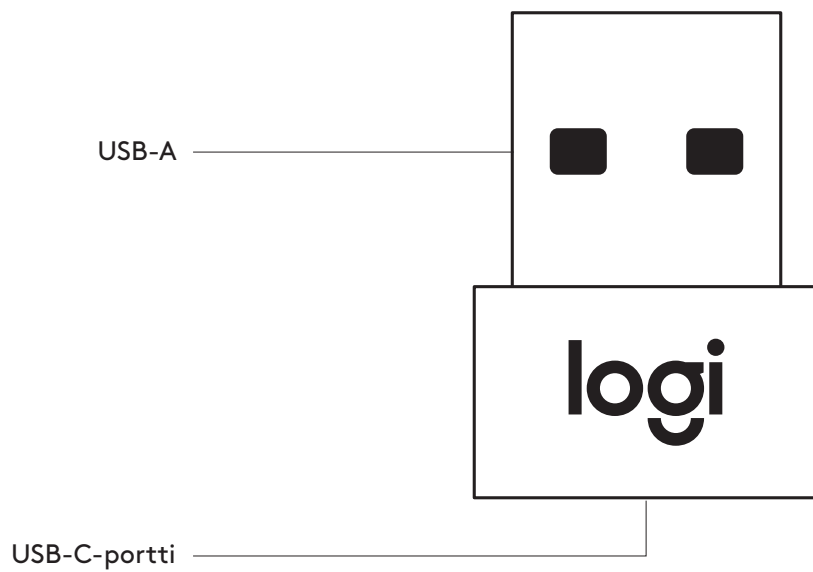

PAKKAUKSEN SISÄLTÖ

USB-C-A-sovitin

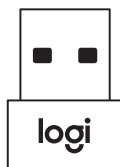

OHJEET

1 Liitä USB-C-liitin USB-A-sovittimeen.

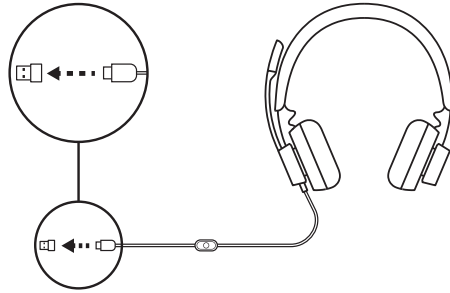

2 Liitä USB-A-liitin tietokoneen USB-A-porttiin.

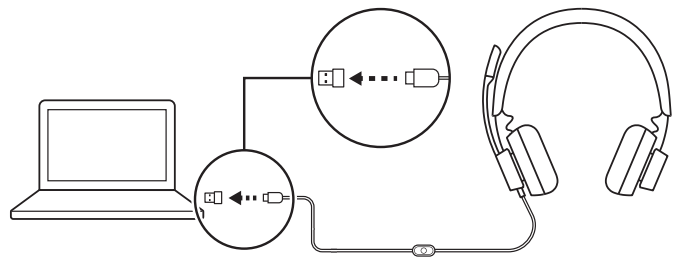

MITAT

SOVITIN:

Korkeus x leveys x syvyys: 21.5 x 15.4 x 7.9 mm

www.logitech.com/support/zone-wired-adapter

ΓΝΩΡΙΜΙΑ ΜΕ ΤΟ ΠΡΟΪΟΝ

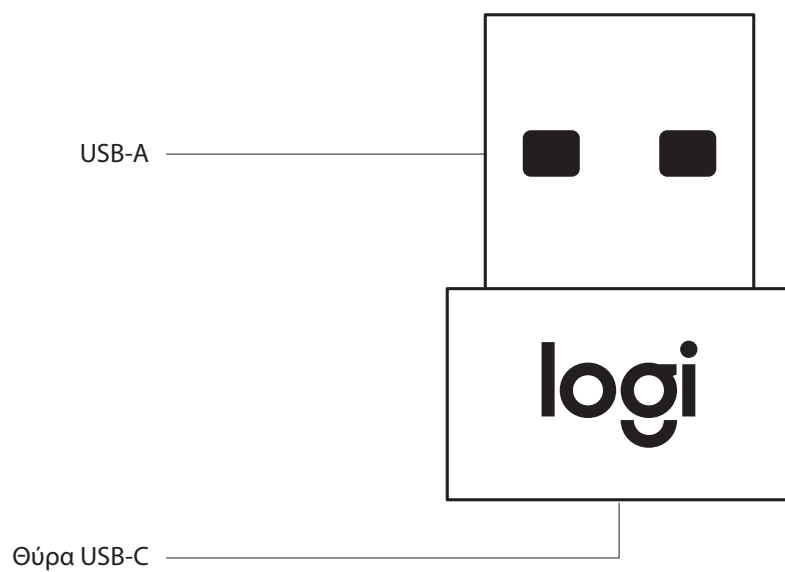

ΠΕΡΙΧΟΜΕΝΑ ΣΥΣΚΕΥΑΣΙΑΣ

Προσαρμογέας USB-C σε A



ΟΔΗΓΙΕΣ

1 Συνδέστε το βύσμα USB-C στον προσαρμογέα USB-A.

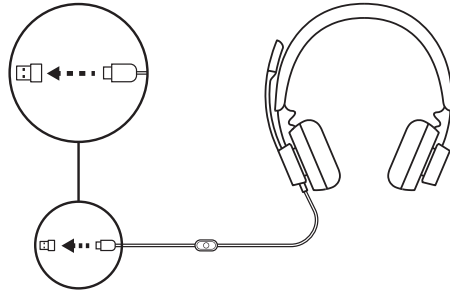

2 Συνδέστε το βύσμα USB-A στη θύρα USB-A του υπολογιστή σας.

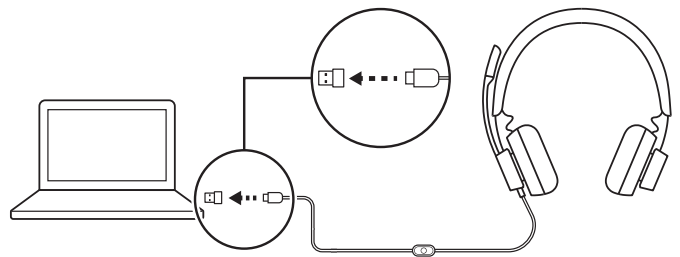

ΔΙΑΣΤΑΣΕΙΣ

ΠΡΟΣΑΡΜΟΓΕΑΣ:

Ύψος x Πλάτος x Βάθος: 21,5 mm x 15,4 mm x 7,9 mm

www.logitech.com/support/zone-wired-adapter

ЗНАКОМСТВО С ПРОДУКТОМ

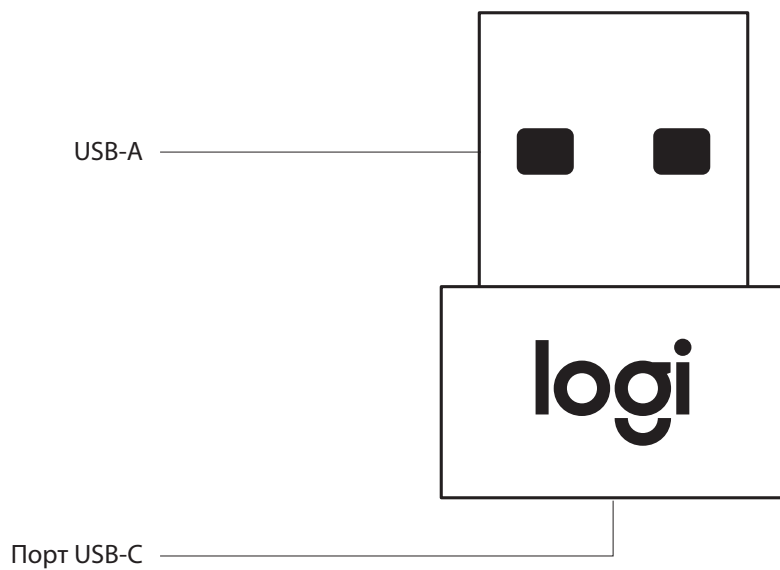

КОМПЛЕКТ ПОСТАВКИ

Адаптер с разъемами USB-C и USB-A



ИНСТРУКЦИИ

1 Вставьте разъем USB-C в адаптер USB-A.

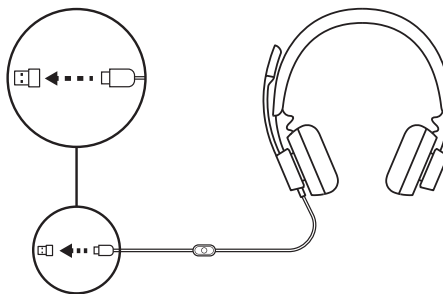

2 Вставьте разъем USB-A в порт USB-A на компьютере.

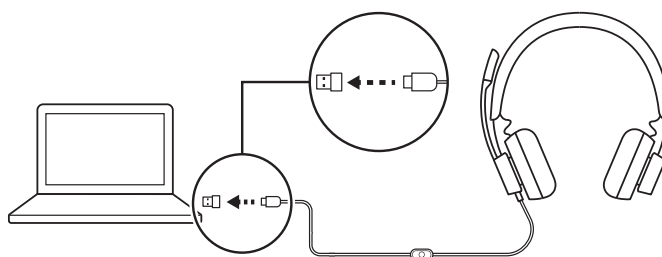

РАЗМЕРЫ

АДАПТЕР

Высота x ширина x длина: 21,5 x 15,4 x 7,9 мм

www.logitech.com/support/zone-wired-adapter

OPIS URZĄDZENIA

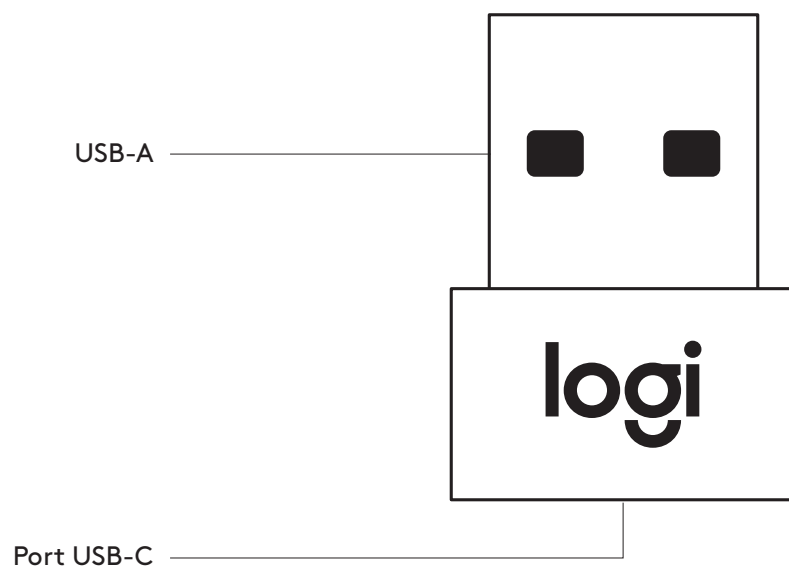

ZAWARTOŚĆ ZESTAWU

Adapter USB-C do A



INSTRUKCJE

1 Podłącz złącze USB-C do adaptera USB-A.

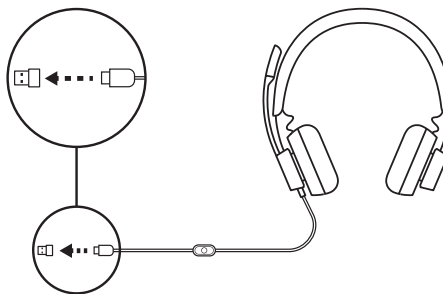

2 Podłącz złącze USB-A do portu USB-A komputera.

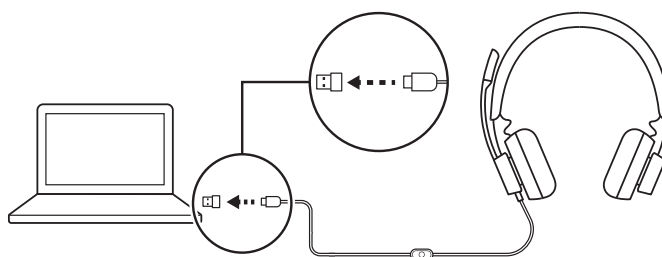

WYMIARY

ADAPTER:

Wysokość x szerokość x głębokość:
21,5 mm x 15,4 mm x 7,9 mm

www.logitech.com/support/zone-wired-adapter

A TERMÉK ISMERTETÉSE

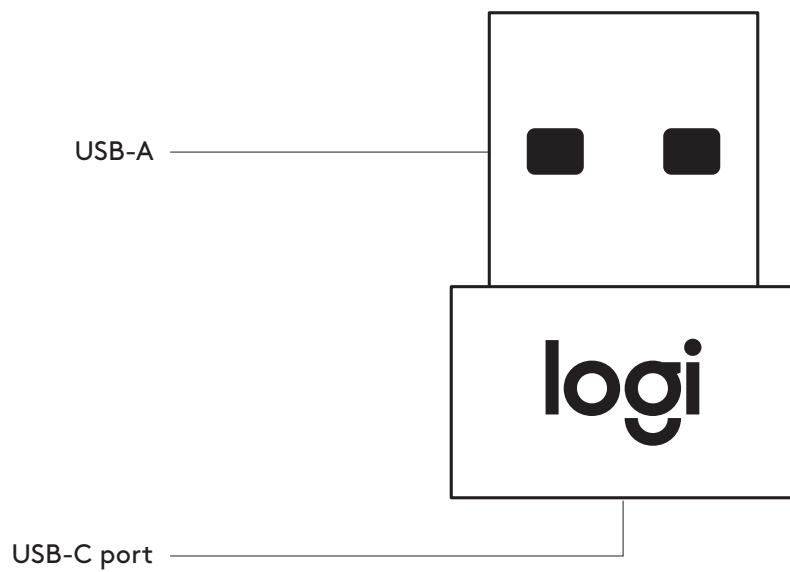

A CSOMAG TARTALMA

USB-C – USB-A átalakító



UTASÍTÁSOK

- 1 Csatlakoztassa az USB-C-csatlakozót az USB-A átalakítóhoz.

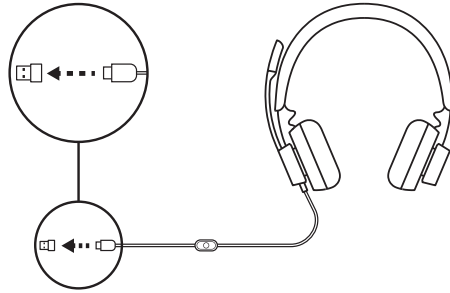

- 2 Csatlakoztassa az USB-A-csatlakozót a számítógép USB-A-portjához.

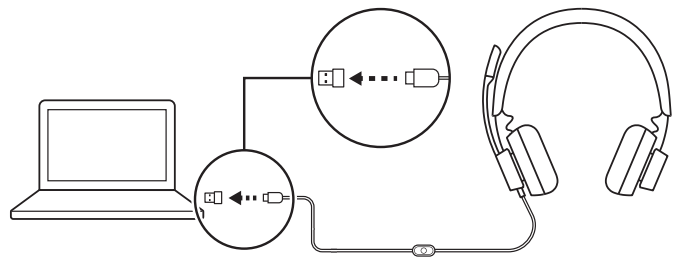

MÉRETEK

ÁTALAKÍTÓ:

Magasság × szélesség × mélység:
21,5 mm x 15,4 mm x 7,9 mm

www.logitech.com/support/zone-wired-adapter

POPIS PRODUKTU

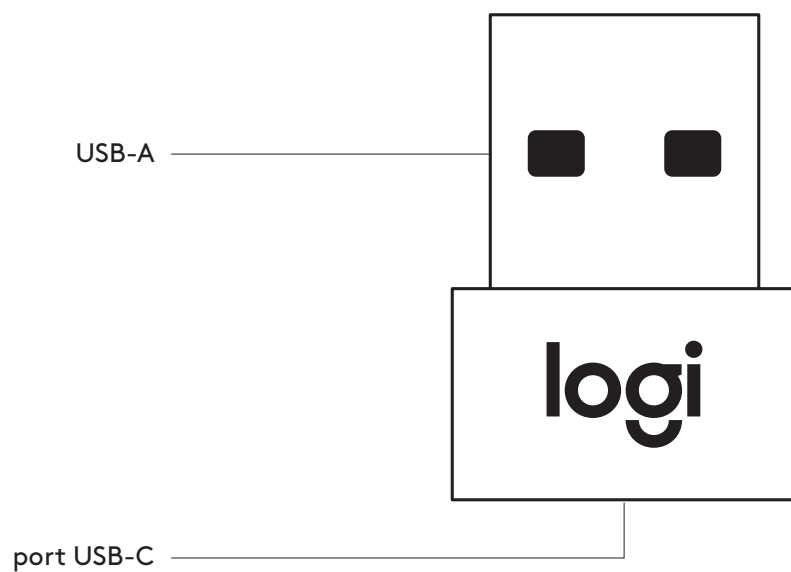

OBSAH BALENÍ

Adaptér USB-C do A



POKYNY

1 Připojte konektor USB-C k adaptéru USB-A.

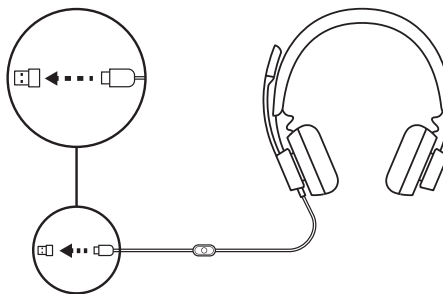

2 Připojte konektor USB-A k portu USB-A v počítači.

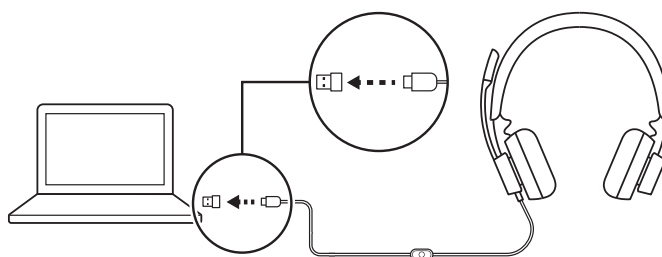

ROZMĚRY

ADAPTÉR:

Výška x šířka x hloubka: 21,5 mm x 15,4 mm x 7,9 mm

www.logitech.com/support/zone-wired-adapter

OPIS PRODUKTU

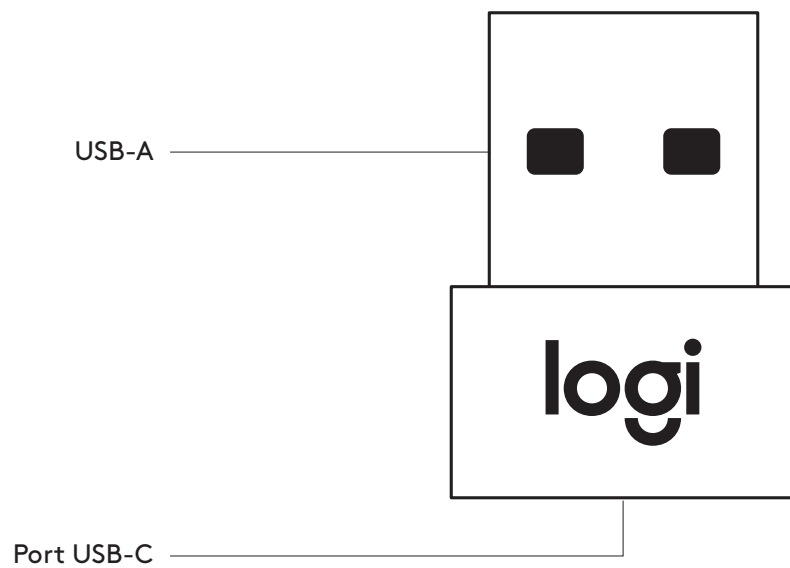

OBSAH BALENIA

Adaptér USB-C do A



POKYNY

1 Pripojte konektor USB-C k adaptéru USB-A.

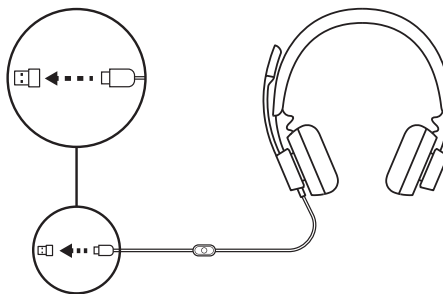

2 Pripojte konektor USB-A k portu USB-A v počítači.

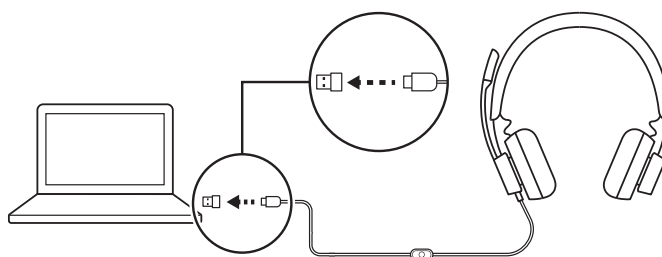

ROZMERY

ADAPTÉR:

Výška x šírka x hĺbka: 21,5 mm x 15,4 mm x 7,9 mm

www.logitech.com/support/zone-wired-adapter

ОЗНАЙОМЛЕННЯ З ПРИСТРОЄМ

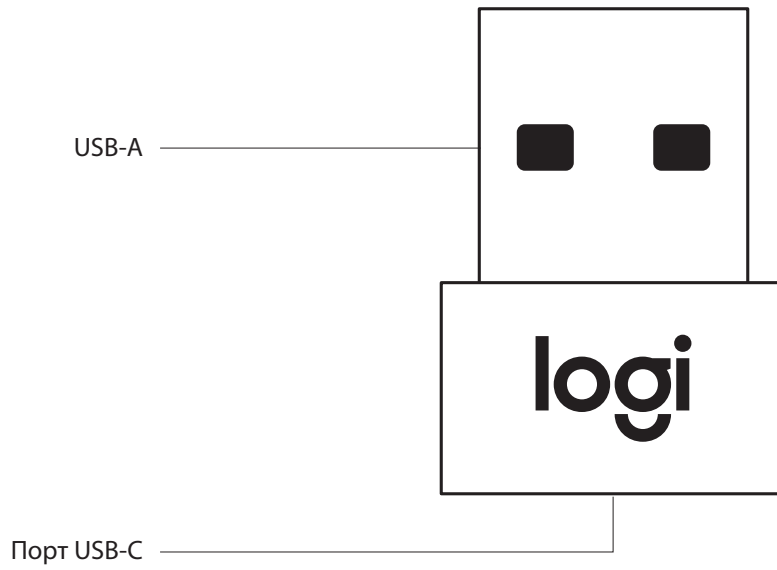

У КОМПЛЕКТІ

Адаптер із роз'ємами USB-C і USB-A



ІНСТРУКЦІЇ

1 Вставте роз'єм USB-C в адаптер USB-A.

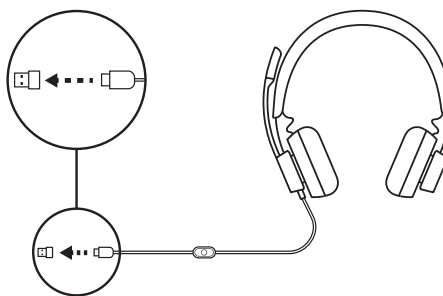

2 Вставте роз'єм USB-A у порт USB-A на комп'ютері.

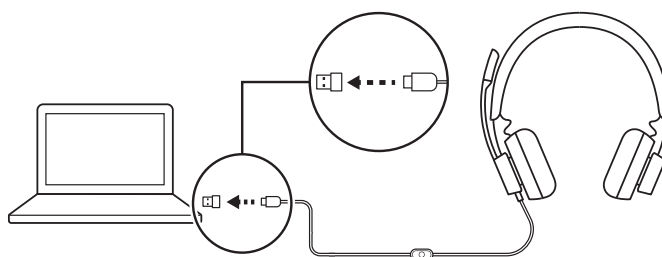

РОЗМІРИ

АДАПТЕР

Висота x ширина x довжина: 21,5 x 15,4 x 7,9 мм

www.logitech.com/support/zone-wired-adapter

TOOTE TUTVUSTUS

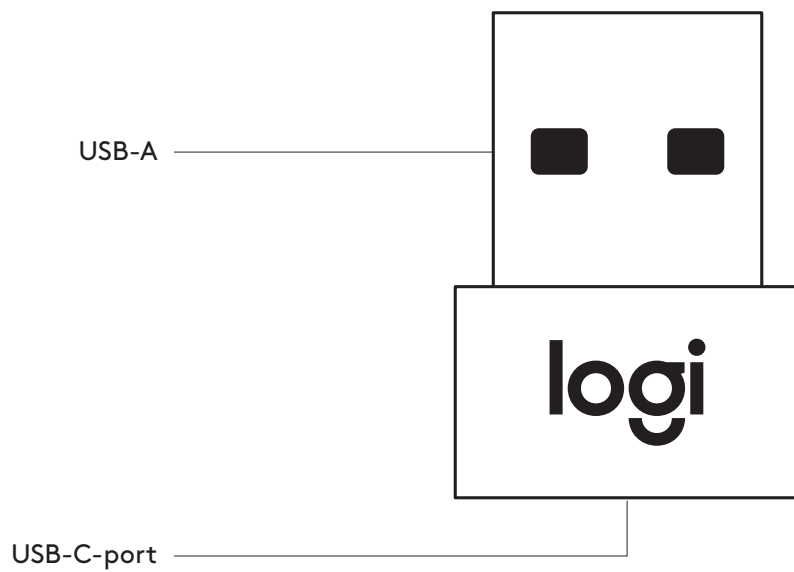

KARBI SISU

USB-C – USB-A adapter



JUHISED

1 Ühendage USB-C-konnektor USB-A-adapteriga.

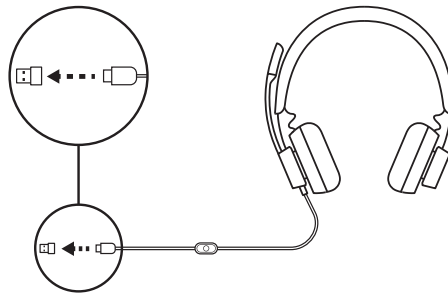

2 Ühendage USB-A-konnektor arvuti USB-A porti.

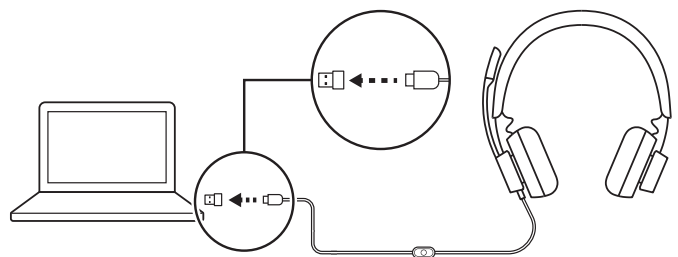

MÕÕDUD

ADAPTER:

Kõrgus x laius x sügavus: 21,5 mm x 15,4 mm x 7,9 mm

www.logitech.com/support/zone-wired-adapter

IEPAZĪSTIETIES AR IERĪCES APRAKSTU

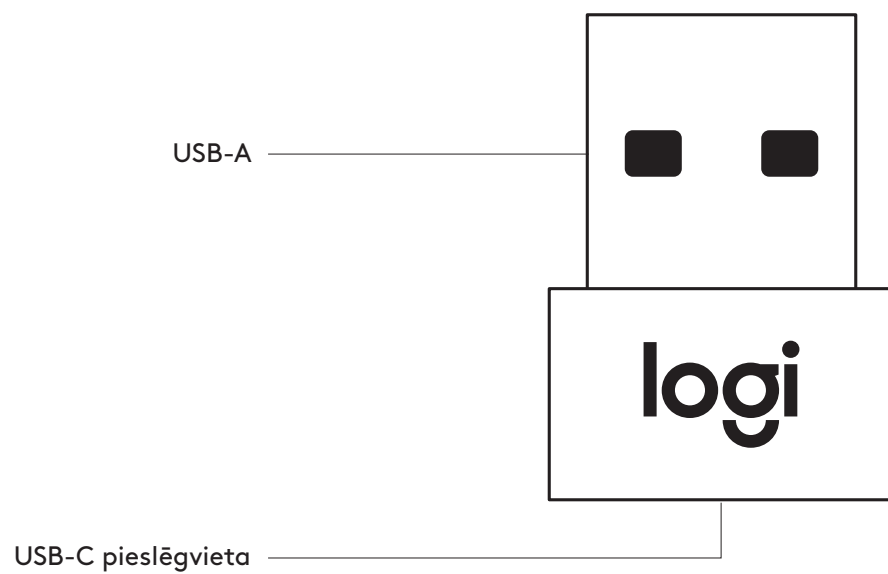

IEPAKOJUMA SATURS

Adapteris pārejai no USB-C uz USB-A savienojumu



NORĀDES

1 Iespraudiet USB-C savienotāju USB-A adapterī.

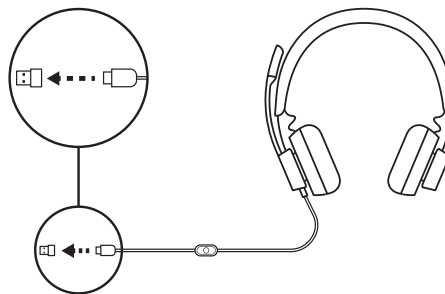

2 Iespraudiet USB-A savienotāju datora USB-A pieslēgvietā.

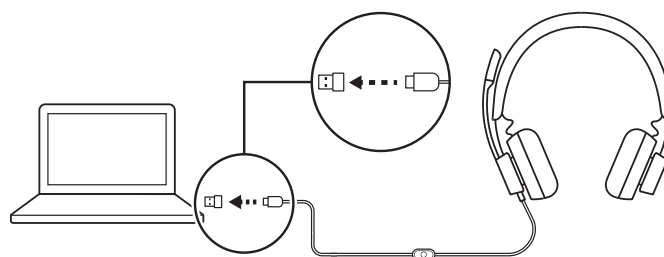

IZMĒRI

ADAPTERIS

Augstums x platums x dziļums:
21,5 mm x 15,4 mm x 7,9 mm

www.logitech.com/support/zone-wired-adapter

SUSIPAŽINKITE SU SAVO PRODUKTU

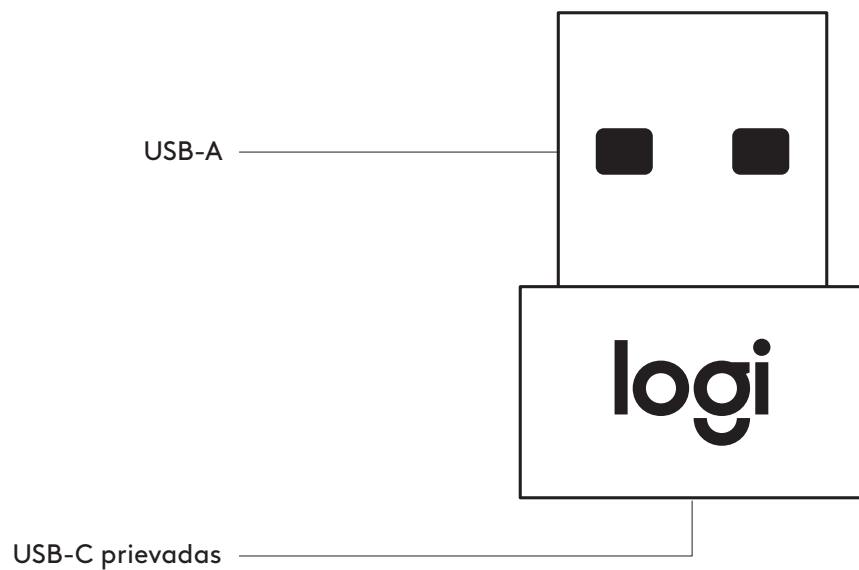

DĒŽUTĒJE YRA

USB-C ir A adapteris



INSTRUKCIJOS

1 Prijunkite USB-C jungtį prie USB-A adapterio.

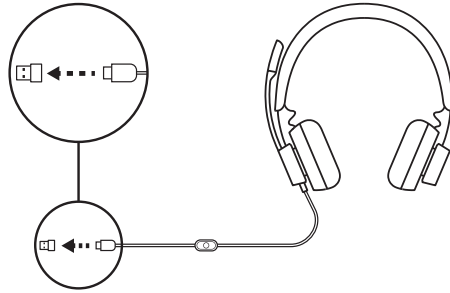

2 Prijunkite USB-A jungtį prie savo kompiuterio USB-A prievado.

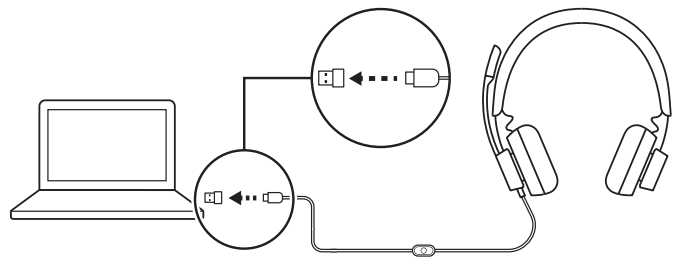

MATMENYS

ADAPTERIS:

aukštis x plotis x gylis: 21,5 mm x 15,4 mm x 7,9 mm

www.logitech.com/support/zone-wired-adapter

ЗАПОЗНАЙТЕ СЕ СЪС СВОЯ ПРОДУКТ

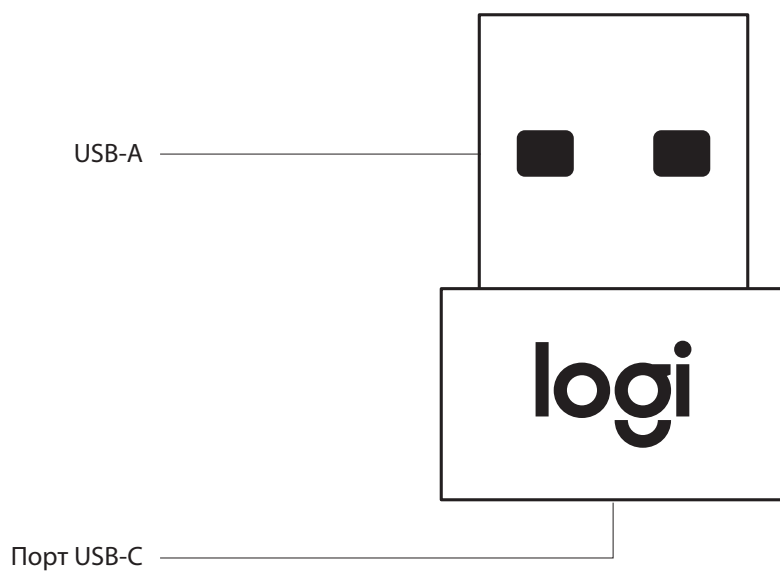

СЪДЪРЖАНИЕ НА КУТИЯТА

Адаптер USB-C към А

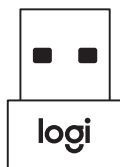

ИНСТРУКЦИИ

1 Включете USB-C конектора към USB-A адаптера.

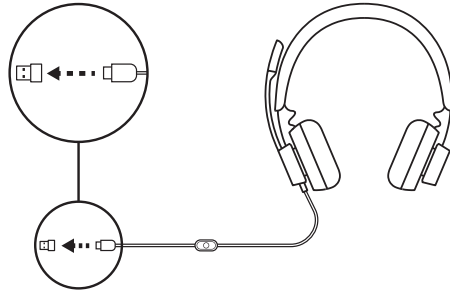

2 Включете USB-A конектора към USB-A порта на компютъра.

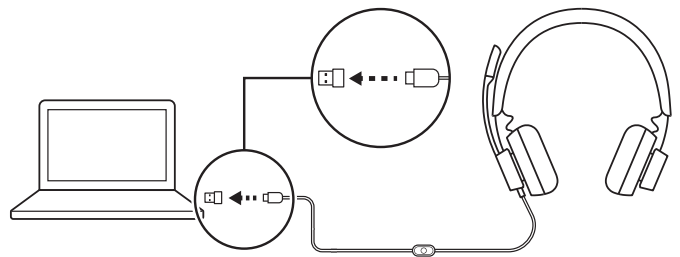

РАЗМЕРИ

АДАПТЕР:

Височина x ширина x дълбочина: 21,5 мм x 15,4 мм x 7,9 мм

www.logitech.com/support/zone-wired-adapter

UPOZNAJTE SVOJ UREĐAJ

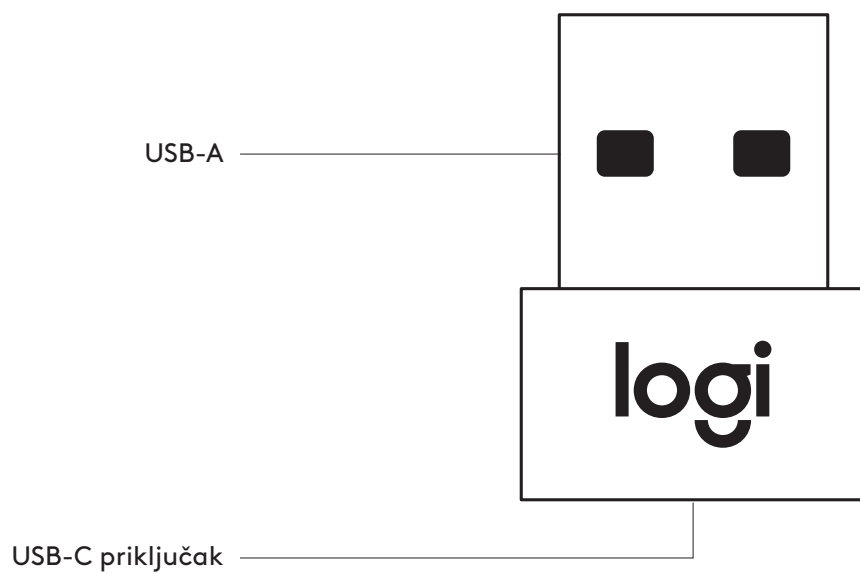

SADRŽAJ KUTIJE

USB-C na A adapter



UPUTE

1 Ukopčajte USB-C priključak u USB-A adapter.

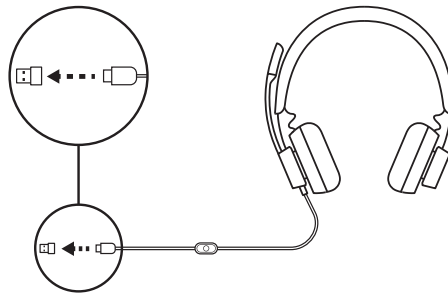

2 Ukopčajte USB-A priključak u USB-A priključnicu na računalu.

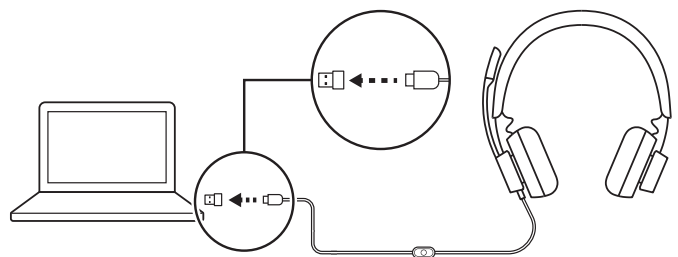

DIMENZIJE

ADAPTER:

Visina x širina x dubina: 21,5 mm x 15,4 mm x 7,9 mm

www.logitech.com/support/zone-wired-adapter

UPOZNAJTE SVOJ PROIZVOD

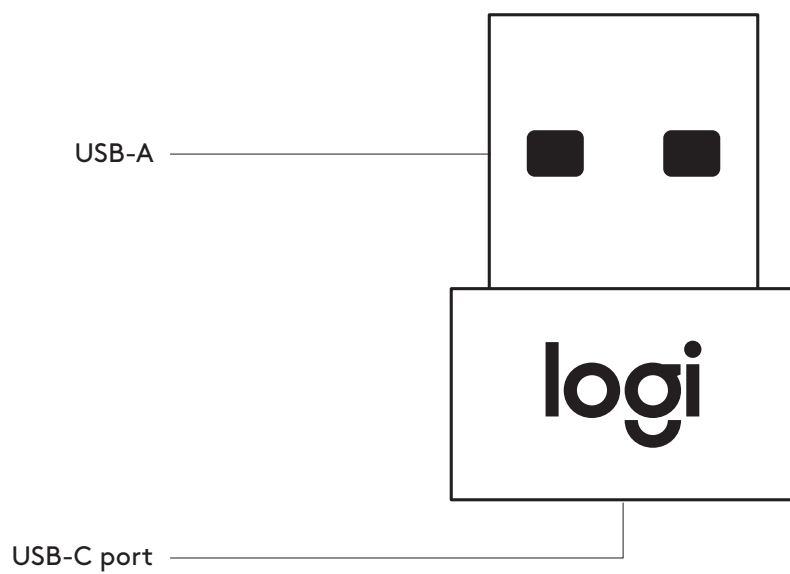

SADRŽAJ PAKOVANJA

USB-C na A adapter



UPUTSTVA

1 Priključite USB-C konektor u USB-A adapter.

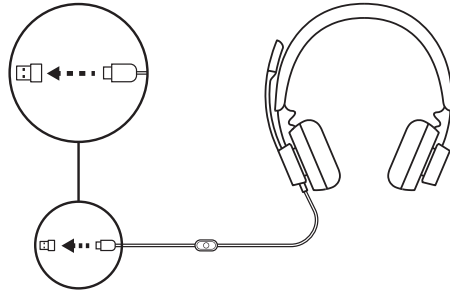

2 Priključite USB-A konektor u USB-A port na računaru.

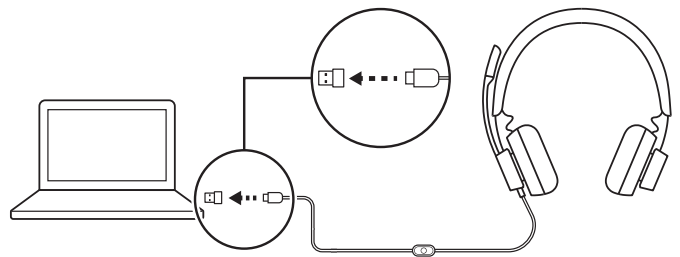

DIMENZIJE

ADAPTER:

Visina x širina x dužina: 21,5 mm x 15,4 mm x 7,9 mm

www.logitech.com/support/zone-wired-adapter

SPOZNAJTE IZDELEK

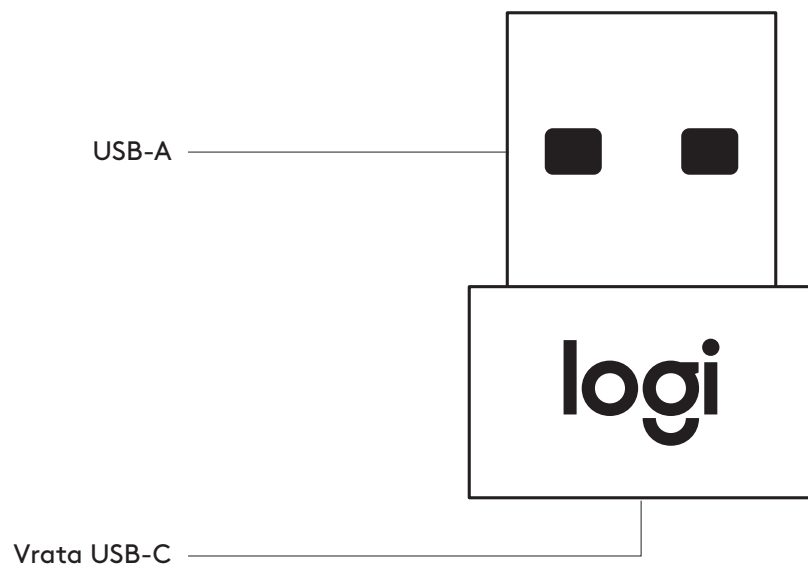

KAJ JE V ŠKATLI?

Adapter iz USB-C na A



NAVODILA

1 Priključek USB-C priključite v adapter USB-A.

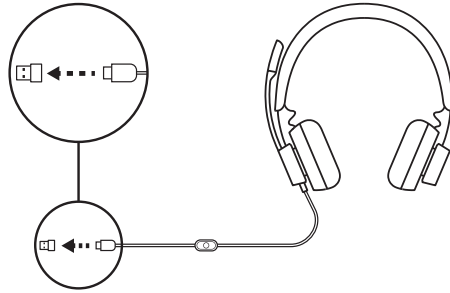

2 Priključek USB-A priključite v vrata USB-A na računalniku.

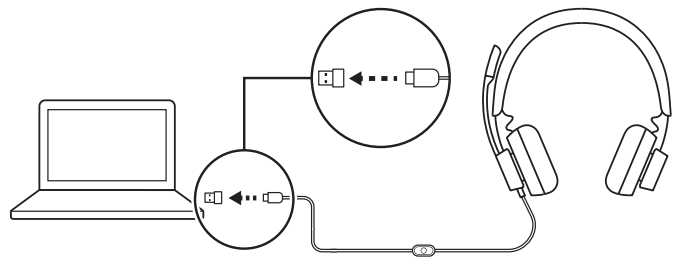

DIMENZIJE

ADAPTER:

Višina × širina × globina: 21,5 mm × 15,4 mm × 7,9 mm

www.logitech.com/support/zone-wired-adapter

FAMILIARIZAȚI-VĂ CU PRODUSUL

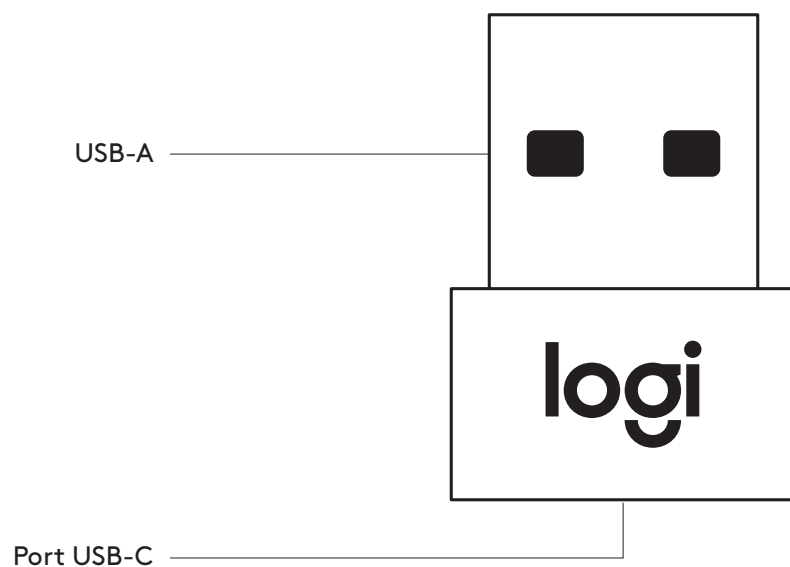

CONȚINUTUL CUTIEI

Adaptor USB-C la A



INSTRUCȚIUNI

- 1 Introduceți conectorul USB-C în adaptorul USB-A.

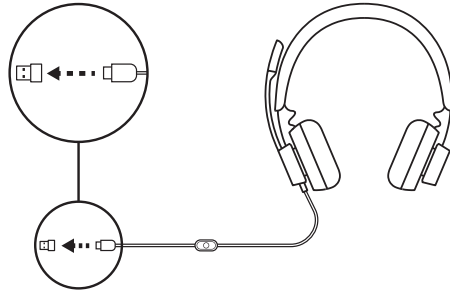

- 2 Introduceți conectorul USB-A în portul USB-A al computerului.

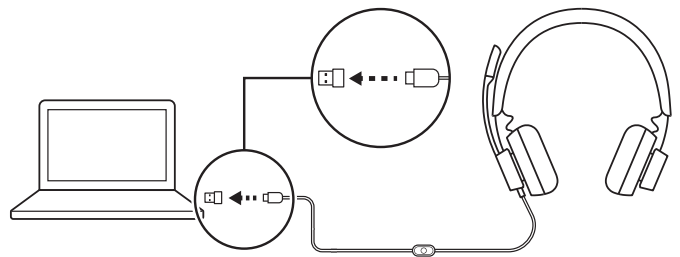

DIMENSIUNI

ADAPTORUL:

Înălțime x lățime x adâncime:
21,5 mm x 15,4 mm x 7,9 mm

www.logitech.com/support/zone-wired-adapter

ÜRÜNÜNÜZÜ TANIYIN

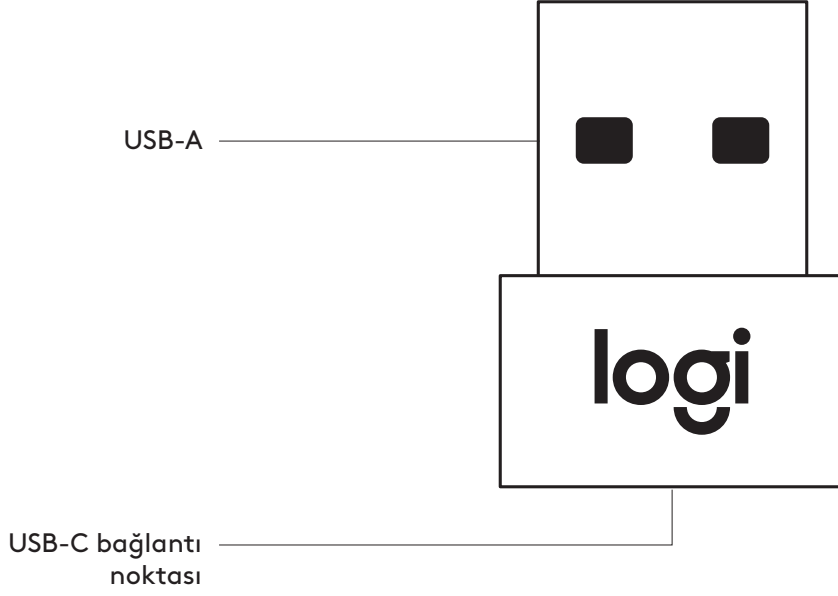

KUTU İÇERİĞİ

USB-C'den USB-A'ya adaptör



YÖNERGELER

1 USB-C konektörünü USB-A adaptörüne takın.

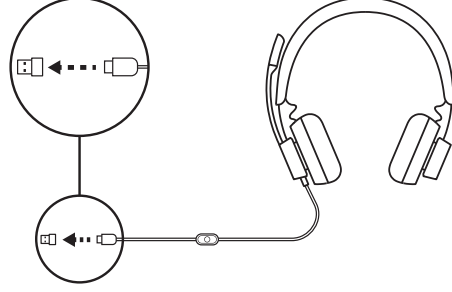

2 USB-A konektörünü bilgisayarınızın USB-A bağlantı noktasına takın.

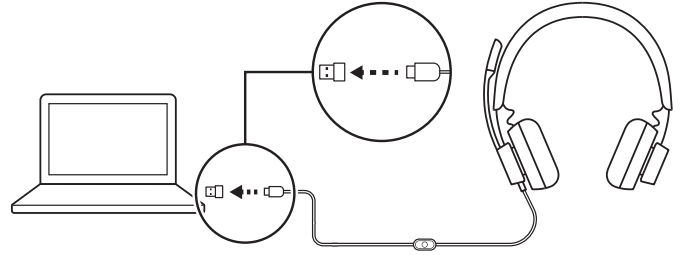

BOYUTLAR

ADAPTÖR:

Yükseklik x Genişlik x Derinlik:
21,5 mm x 15,4 mm x 7,9 mm

www.logitech.com/support/zone-wired-adapter

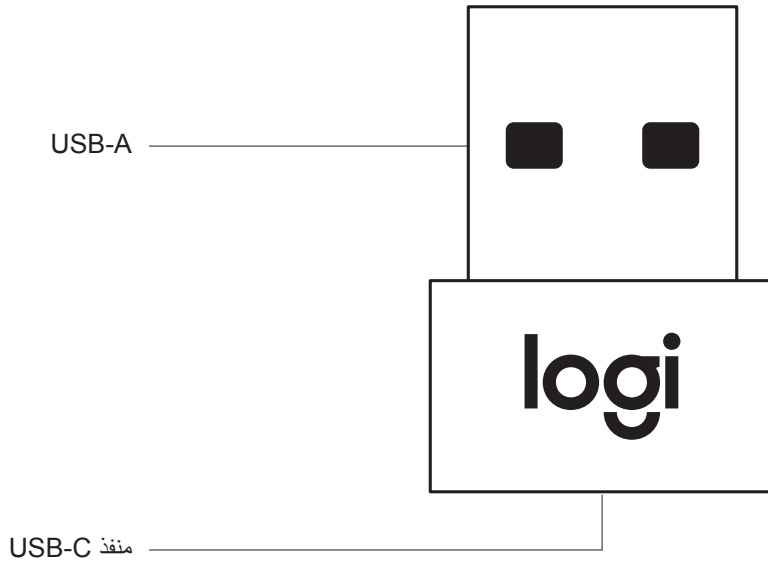

محتويات العبوة

محول USB-C إلى A

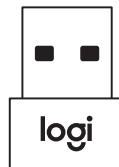

الإرشادات

1 وصل موصل USB-C بمهايئ USB-A.

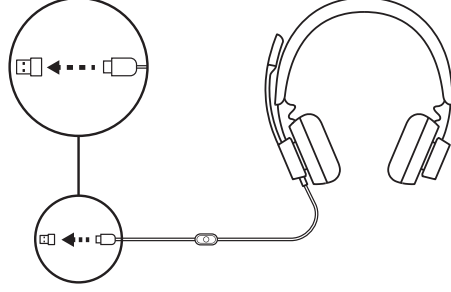

2 وصل موصل USB-A بمنفذ USB-A بالكمبيوتر.

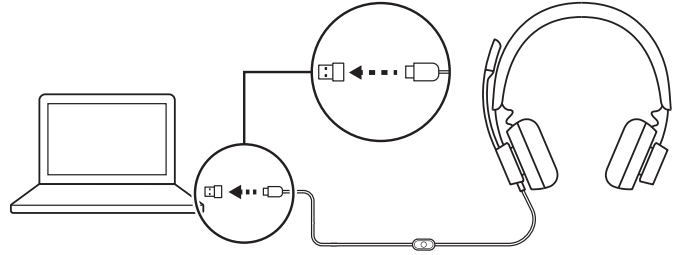

الأبعاد

المحول:

الطول × العرض × العمق: 21.5 ملم × 15.4 ملم × 7.9 ملم

www.logitech.com/support/zone-wired-adapter

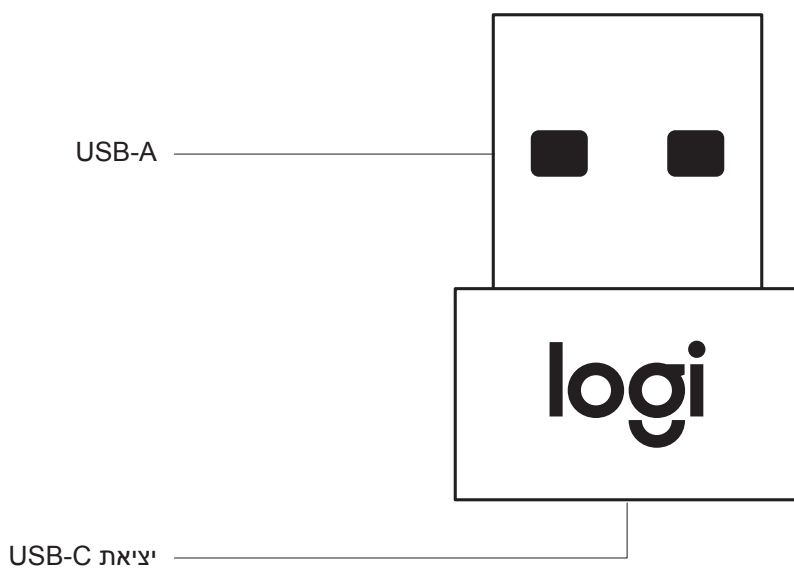

מה בקופסה?

מתאם USB-C ל-A



הוראות

1 חבר את מחבר ה-USB-C למתאם ה-USB-A.

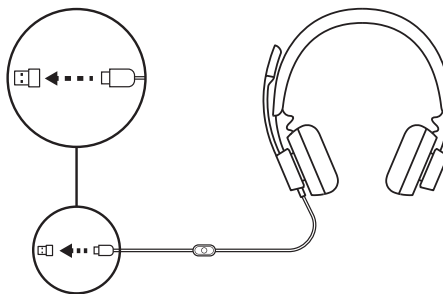

2 חבר את מחבר ה-USB-A לציאת USB-A במחשב.

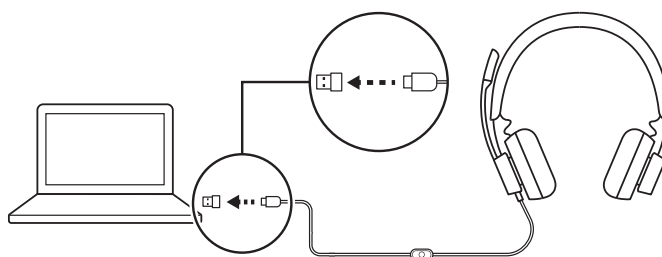

מידות

מתאם:

גובה x רוחב x עומק: 21.5 מ"מ x 15.4 מ"מ x 7.9 מ"מ

www.logitech.com/support/zone-wired-adapter