

User's Guide

Copyright

Copyright

No part of this publication may be reproduced, stored in a retrieval system, or transmitted in any form or by any means, electronic, mechanical, photocopying, recording, or otherwise, without the prior written permission of Seiko Epson Corporation. No patent liability is assumed with respect to the use of the information contained herein. Neither is any liability assumed for damages resulting from the use of the information herein. The information contained herein is designed only for use with this Epson printer. Epson is not responsible for any use of this information as applied to other printers.

Neither Seiko Epson Corporation nor its affiliates shall be liable to the purchaser of this product or third parties for damages, losses, costs, or expenses incurred by the purchaser or third parties as a result of accident, misuse, or abuse of this product or unauthorized modifications, repairs, or alterations to this product, or (excluding the U.S.) failure to strictly comply with Seiko Epson Corporation's operating and maintenance instructions.

Seiko Epson Corporation and its affiliates shall not be liable for any damages or problems arising from the use of any options or any consumable products other than those designated as Original Epson Products or Epson Approved Products by Seiko Epson Corporation.

Seiko Epson Corporation shall not be held liable for any damage resulting from electromagnetic interference that occurs from the use of any interface cables other than those designated as Epson Approved Products by Seiko Epson Corporation.

© 2014 Seiko Epson Corporation. All rights reserved.

The contents of this manual and the specifications of this product are subject to change without notice.

Trademarks

Trademarks

- ❑ EPSON® is a registered trademark, and EPSON EXCEED YOUR VISION or EXCEED YOUR VISION is a trademark of Seiko Epson Corporation.
- ❑ PRINT Image Matching™ and the PRINT Image Matching logo are trademarks of Seiko Epson Corporation. Copyright © 2001 Seiko Epson Corporation. All rights reserved.
- ❑ EPSON Scan software is based in part on the work of the Independent JPEG Group.
- ❑ libtiff

Copyright © 1988-1997 Sam Leffler

Copyright © 1991-1997 Silicon Graphics, Inc.

Permission to use, copy, modify, distribute, and sell this software and its documentation for any purpose is hereby granted without fee, provided that (i) the above copyright notices and this permission notice appear in all copies of the software and related documentation, and (ii) the names of Sam Leffler and Silicon Graphics may not be used in any advertising or publicity relating to the software without the specific, prior written permission of Sam Leffler and Silicon Graphics.

THE SOFTWARE IS PROVIDED "AS-IS" AND WITHOUT WARRANTY OF ANY KIND, EXPRESS, IMPLIED OR OTHERWISE, INCLUDING WITHOUT LIMITATION, ANY WARRANTY OF MERCHANTABILITY OR FITNESS FOR A PARTICULAR PURPOSE.

IN NO EVENT SHALL SAM LEFFLER OR SILICON GRAPHICS BE LIABLE FOR ANY SPECIAL, INCIDENTAL, INDIRECT OR CONSEQUENTIAL DAMAGES OF ANY KIND, OR ANY DAMAGES WHATSOEVER RESULTING FROM LOSS OF USE, DATA OR PROFITS, WHETHER OR NOT ADVISED OF THE POSSIBILITY OF DAMAGE, AND ON ANY THEORY OF LIABILITY, ARISING OUT OF OR IN CONNECTION WITH THE USE OR PERFORMANCE OF THIS SOFTWARE.

- ❑ SDXC Logo is a trademark of SD-3C, LLC.



- ❑ Memory Stick, Memory Stick Duo, Memory Stick PRO, Memory Stick PRO Duo, Memory Stick PRO-HG Duo, Memory Stick Micro, MagicGate Memory Stick and MagicGate Memory Stick Duo are trademarks of Sony Corporation.



- ❑ PictBridge is a trademark.



- ❑ Microsoft®, Windows®, and Windows Vista® are registered trademarks of Microsoft Corporation.
- ❑ Apple, Macintosh, Mac OS, OS X are trademarks of Apple Inc., registered in the U.S. and other countries.

Trademarks

- ❑ Adobe, Adobe Reader, Acrobat, and Photoshop are trademarks of Adobe systems Incorporated, which may be registered in certain jurisdictions.
- ❑ ABBYY® and ABBYY FineReader® names and logos are registered trademarks of ABBYY Software House.
- ❑ Intel® is a registered trademark of Intel Corporation.
- ❑ General Notice: Other product names used herein are for identification purposes only and may be trademarks of their respective owners. Epson disclaims any and all rights in those marks.

Contents

Copyright

Trademarks

About This Manual

| | |
|---|---|
| Introduction to the Manuals. | 8 |
| Marks and Symbols. | 8 |
| Descriptions Used in this Manual. | 8 |
| Operating System References. | 9 |

Important Instructions

| | |
|---|----|
| Safety Instructions. | 10 |
| Printer Advisories and Warnings. | 10 |
| Advisories and Warnings for Setting Up/ Using the Printer. | 10 |
| Advisories and Warnings for Using Memory Cards. | 12 |
| Advisories and Warnings for Using the Touchpad. | 12 |

Printer Basics

| | |
|-----------------------------------|----|
| Part Names and Functions. | 13 |
| Control Panel. | 15 |
| Buttons. | 15 |
| Guide to the LCD Screen. | 16 |
| Menu Options. | 17 |
| Copy Mode. | 17 |
| Print Photos Mode. | 19 |
| Scan Mode. | 23 |
| Setup Mode. | 24 |
| Back Up Data Mode. | 25 |

Loading Paper

| | |
|---|----|
| Paper Handling Precautions. | 27 |
| Available Paper and Capacities. | 28 |
| List of Paper Types. | 29 |
| Loading Paper in the Rear Paper Feed. | 30 |

Placing Originals on the Scanner Glass

Inserting a Memory Card

| | |
|---|----|
| Supported Memory Cards. | 35 |
| Inserting and Removing a Memory Card. | 35 |

Loading a CD/DVD for Printing

| | |
|--------------------------------------|----|
| Printable CD/DVDs. | 37 |
| CD/DVD Handling Precautions. | 37 |
| Loading a CD/DVD. | 38 |
| Removing a CD/DVD. | 39 |

Printing

| | |
|---|----|
| Printing from the Control Panel. | 41 |
| Printing Photos by Selecting from a Memory Card. | 41 |
| Printing Photos from a Memory Card onto a CD/DVD Label. | 42 |
| Printing Photos from a Memory Card with Handwritten Notes. | 43 |
| Printing Photos Using Other Features. | 44 |
| Printing from a Computer. | 46 |
| Printing Basics - Windows. | 46 |
| Printing Basics - Mac OS X. | 48 |
| Printing on 2-Sides (for Windows only). | 50 |
| Printing Several Pages on One Sheet. | 51 |
| Printing to Fit the Paper Size. | 52 |
| Printing Multiple Files Together (for Windows Only). | 53 |
| Enlarged Printing and Making Posters (for Windows Only). | 54 |
| Printing Using Advanced Features. | 60 |
| Printing Photos Using Epson Easy Photo Printt. | 62 |
| Printing a CD/DVD Label with Epson Print CD. | 63 |
| Printing from a Digital Camera. | 63 |
| Printing from a Digital Camera Connected by USB Cable. | 63 |
| Canceling Printing. | 64 |
| Canceling Printing - Printer Button. | 64 |
| Canceling Printing - Windows. | 64 |
| Canceling Printing - Mac OS X. | 65 |

Contents

Copying

| | |
|------------------------------------|----|
| Copying Basics. | 66 |
| Copying Photos. | 66 |
| Copying on a CD/DVD Label. | 67 |

Scanning

| | |
|---|----|
| Scanning Using the Control Panel. | 69 |
| Scanning to a Memory Card. | 69 |
| Scanning to a Computer. | 69 |
| Scanning from a Computer. | 70 |
| Scanning Basics. | 70 |
| Scanning Using Advanced Features. | 73 |
| Scanning by Detecting the Original Automatically (Full Auto Mode). | 73 |
| Scanning at a Specified Size (Office Mode). | 74 |
| Scanning by Adjusting the Image Quality (Professional Mode). | 75 |

Refilling Ink

| | |
|---|----|
| Checking the Ink Levels. | 76 |
| Checking the Ink Levels - Windows. | 76 |
| Checking the Ink Levels - Mac OS X. | 76 |
| Ink Bottle Codes. | 77 |
| Ink Bottle Handling Precautions. | 77 |
| Refilling the Ink Tanks. | 78 |

Improving Print and Scan Quality

| | |
|--|----|
| Checking and Cleaning the Print Head. | 82 |
| Checking and Cleaning the Print Head - Control Panel. | 82 |
| Checking and Cleaning the Print Head - Windows. | 83 |
| Checking and Cleaning the Print Head - Mac OS X. | 83 |
| Replacing Ink inside the Ink Tubes. | 84 |
| Replacing Ink inside the Ink Tubes - Windows. | 84 |
| Replacing Ink inside the Ink Tubes - Mac OS X. | 84 |
| Aligning the Print Head. | 85 |
| Aligning the Print Head - Control Panel. | 85 |
| Aligning the Print Head - Windows. | 85 |
| Aligning the Print Head - Mac OS X. | 86 |
| Cleaning the Paper Path. | 86 |
| Cleaning the Scanner Glass. | 87 |

Application Information

| | |
|---------------------------------|----|
| Necessary Applications. | 88 |
|---------------------------------|----|

| | |
|---|----|
| Windows Printer Driver. | 88 |
| Mac OS X Printer Driver. | 91 |
| EPSON Scan (Scanner Driver). | 94 |
| Epson Event Manager. | 94 |
| Epson Easy Photo Print. | 95 |
| Epson Print CD. | 95 |
| E-Web Print (for Windows Only). | 95 |
| EPSON Software Updater. | 96 |
| Uninstalling Applications. | 96 |
| Uninstalling Applications - Windows. | 96 |
| Uninstalling Applications - Mac OS X. | 97 |
| Installing Applications. | 97 |
| Updating Applications and Firmware. | 98 |

Solving Problems

| | |
|--|-----|
| Checking the Printer Status. | 99 |
| Checking Messages on the LCD Screen. | 99 |
| Checking the Printer Status - Windows. | 100 |
| Checking Printer Status - Mac OS X. | 100 |
| Removing Jammed Paper. | 100 |
| Removing Jammed Paper from the Rear Paper Feed. | 101 |
| Removing Jammed Paper from Inside the Printer. | 101 |
| Paper Does Not Feed Correctly. | 103 |
| Power and Control Panel Problems. | 103 |
| Power Does Not Turn On. | 103 |
| Lights Came On and then Went Out. | 103 |
| Power Does Not Turn Off. | 104 |
| LCD Screen Gets Dark. | 104 |
| Printer Does Not Print. | 104 |
| Printout Problems. | 105 |
| Print Quality Is Poor. | 105 |
| Copy Quality Is Poor. | 106 |
| An Image of the Reverse Side of the Original Appears in the Copied Image. | 106 |
| The Position, Size, or Margins of the Printout Are Incorrect. | 106 |
| Paper Is Smearred or Scuffed. | 107 |
| Printed Characters Are Incorrect or Garbled. | 108 |
| The Printed Image Is Inverted. | 108 |
| The Printout Problem Could Not be Cleared. | 109 |
| Printing Is Too Slow. | 109 |
| Cannot Start Scanning. | 109 |
| Cannot Start Scanning when Using the Control Panel. | 110 |
| Scanned Image Problems. | 110 |
| Scan Quality Is Poor. | 110 |

Contents

| | | | |
|--|-----|-------------------------------------|-----|
| Characters Are Blurred. | 111 | Technical Support Web Site. | 125 |
| An Image of the Reverse Side of the Original Appears in the Scanned Image. | 111 | Contacting Epson Support. | 125 |
| Moire (Cross-Hatch) Patterns Appear in the Scanned Image. | 111 | | |
| Scanning Area or Direction Is Not Correct. | 111 | | |
| The Scanned Image Problem Could Not be Cleared. | 112 | | |
| Other Scanning Problems. | 112 | | |
| Cannot Scan in Full Auto Mode in EPSON Scan. | 112 | | |
| Thumbnail Preview Does Not Work Properly. | 112 | | |
| Scanning Is Too Slow. | 113 | | |
| Scanning Stops when Scanning to PDF/ Multi-TIFF. | 113 | | |
| Other Problems. | 113 | | |
| Slight Electric Shock when Touching the Printer. | 113 | | |
| Operation Sounds Are Loud. | 113 | | |
| Cannot Save Data to a Memory Device. | 113 | | |
| Application Is Blocked by a Firewall (for Windows Only). | 114 | | |
| "?" Is Displayed on the Photo Selection Screen. | 114 | | |
| A Message Prompting You to Reset the Ink Levels is Displayed. | 114 | | |
| | | | |
| Appendix | | | |
| Technical Specifications. | 115 | | |
| Printer Specifications. | 115 | | |
| Scanner Specifications. | 116 | | |
| Interface Specifications. | 117 | | |
| External Storage Device Specifications. | 117 | | |
| Dimensions. | 119 | | |
| Electrical Specifications. | 119 | | |
| Environmental Specifications. | 119 | | |
| System Requirements. | 120 | | |
| Regulatory Information. | 120 | | |
| Standards and Approvals for European Model. | 120 | | |
| Restrictions on Copying. | 120 | | |
| Checking the Total Number of Pages Fed Through the Printer. | 121 | | |
| Checking the Total Number of Pages Fed Through the Printer - Control Panel. | 121 | | |
| Checking the Total Number of Pages Fed Through the Printer - Windows. | 121 | | |
| Checking the Total Number of Pages Fed Through the Printer - Mac OS X. | 122 | | |
| Transporting the Printer. | 122 | | |
| Accessing a Memory Card From a Computer. | 124 | | |
| Where to Get Help. | 125 | | |

About This Manual

Introduction to the Manuals

The latest versions of the following manuals are available from the Epson support website.

<http://www.epson.eu/Support> (Europe)

<http://support.epson.net/> (outside Europe)

Start Here (paper manual)

Provides you with information on setting up the printer, installing the software, using the printer basically, solving problems, and so on.

User's Guide (PDF manual)

This manual. Provides overall information and instructions on using the printer, and on solving problems.

As well as the manuals above, see the help included in the various Epson software applications.

Marks and Symbols



Caution:

Instructions that must be followed carefully to avoid bodily injury.



Important:

Instructions that must be observed to avoid damage to your equipment.

Note:

Instructions containing useful tips and restrictions on printer operation.

➔ Related Information

Links to related sections.

Descriptions Used in this Manual

- Screenshots of the printer driver and the EPSON Scan (scanner driver) screens are from Windows 8.1 or Mac OS X v10.9.x. The content displayed on the screens varies depending on the model and situation.
- Illustrations of the printer used in this manual are examples only. Although there may be slight differences depending on the model, the method of operation is the same.
- Some of the menu items on the LCD screen vary depending on the model and settings.

Operating System References

Windows

In this manual, terms such as "Windows 8.1", "Windows 8", "Windows 7", "Windows Vista", and "Windows XP" refer to the following operating systems. Additionally, "Windows" is used to refer to all versions.

- Microsoft® Windows® 8.1 operating system
- Microsoft® Windows® 8 operating system
- Microsoft® Windows® 7 operating system
- Microsoft® Windows Vista® operating system
- Microsoft® Windows® XP operating system
- Microsoft® Windows® XP Professional x64 Edition operating system

Mac OS X

In this manual, "Mac OS X v10.9.x" refers to "OS X Mavericks" and "Mac OS X v10.8.x" refers to "OS X Mountain Lion". Additionally, "Mac OS X" is used to refer to "Mac OS X v10.9.x", "Mac OS X v10.8.x", "Mac OS X v10.7.x" and "Mac OS X v10.6.x".

Important Instructions

Safety Instructions

Read and follow these instructions to ensure safe use of this printer. Make sure you keep this manual for future reference. Also, be sure to follow all warnings and instructions marked on the printer.

- Use only the power cord supplied with the printer and do not use the cord with any other equipment. Use of other cords with this printer or the use of the supplied power cord with other equipment may result in fire or electric shock.
- Be sure your AC power cord meets the relevant local safety standard.
- Never disassemble, modify, or attempt to repair the power cord, plug, printer unit, scanner unit, or options by yourself, except as specifically explained in the printer's manuals.
- Unplug the printer and refer servicing to qualified service personnel under the following conditions:
The power cord or plug is damaged; liquid has entered the printer; the printer has been dropped or the casing damaged; the printer does not operate normally or exhibits a distinct change in performance. Do not adjust controls that are not covered by the operating instructions.
- Place the printer near a wall outlet where the plug can be easily unplugged.
- Do not place or store the printer outdoors, near excessive dirt or dust, water, heat sources, or in locations subject to shocks, vibrations, high temperature or humidity.
- Take care not to spill liquid on the printer and not to handle the printer with wet hands.
- If the LCD screen is damaged, contact your dealer. If the liquid crystal solution gets on your hands, wash them thoroughly with soap and water. If the liquid crystal solution gets into your eyes, flush them immediately with water. If discomfort or vision problems remain after a thorough flushing, see a doctor immediately.
- Be careful not to touch any ink when you handle the ink tanks, ink tank caps, and opened ink bottles or ink bottle caps.
 - If ink gets on your skin, wash the area thoroughly with soap and water.
 - If ink gets into your eyes, flush them immediately with water. If discomfort or vision problems continue after a thorough flushing, see a doctor immediately.
 - If ink gets into your mouth, see a doctor right away.
- Do not tilt or shake an ink bottle after removing its seal; this can cause leakage.
- Keep ink bottles and the ink tank unit out of the reach of children. Do not allow children to drink from or handle the ink bottles and ink bottle cap.



Printer Advisories and Warnings

Read and follow these instructions to avoid damaging the printer or your property. Make sure you keep this manual for future reference.

Advisories and Warnings for Setting Up/Using the Printer

- Do not block or cover the vents and openings in the printer.
- Use only the type of power source indicated on the printer's label.

Important Instructions

- ❑ Avoid using outlets on the same circuit as photocopiers or air control systems that regularly switch on and off.
- ❑ Avoid electrical outlets controlled by wall switches or automatic timers.
- ❑ Keep the entire computer system away from potential sources of electromagnetic interference, such as loudspeakers or the base units of cordless telephones.
- ❑ The power-supply cords should be placed to avoid abrasions, cuts, fraying, crimping, and kinking. Do not place objects on top of the power-supply cords and do not allow the power-supply cords to be stepped on or run over. Be particularly careful to keep all the power-supply cords straight at the ends and the points where they enter and leave the transformer.
- ❑ If you use an extension cord with the printer, make sure that the total ampere rating of the devices plugged into the extension cord does not exceed the cord's ampere rating. Also, make sure that the total ampere rating of all devices plugged into the wall outlet does not exceed the wall outlet's ampere rating.
- ❑ If you plan to use the printer in Germany, the building installation must be protected by a 10 or 16 amp circuit breaker to provide adequate short-circuit protection and over-current protection for the printer.
- ❑ When connecting the printer to a computer or other device with a cable, ensure the correct orientation of the connectors. Each connector has only one correct orientation. Inserting a connector in the wrong orientation may damage both devices connected by the cable.
- ❑ Place the printer on a flat, stable surface that extends beyond the base of the printer in all directions. The printer will not operate properly if it is tilted at an angle.
- ❑ When storing or transporting the printer, avoid tilting it, placing it vertically, or turning it upside down; otherwise ink may leak.
- ❑ Allow space above the printer so that you can fully raise the document cover.
- ❑ Leave enough space in front of the printer for the paper to be fully ejected.
- ❑ Avoid places subject to rapid changes in temperature and humidity. Also, keep the printer away from direct sunlight, strong light, or heat sources.
- ❑ Do not insert objects through the slots in the printer.
- ❑ Do not put your hand inside the printer during printing.
- ❑ Do not touch the white flat cable and ink tubes inside the printer.
- ❑ Do not touch the left lateral surface of the print head inside the printer when the printer is on.
- ❑ Do not use aerosol products that contain flammable gases inside or around the printer. Doing so may cause fire.
- ❑ Do not move the print head by hand; otherwise, you may damage the printer.
- ❑ Be careful not to trap your fingers when closing the scanner unit.
- ❑ Do not press too hard on the scanner glass when placing the originals.
- ❑ Do not continue printing when the ink level is below the lower line on the ink tank. Continued use of the printer when the ink level is below the lower line could damage the printer. Epson recommends filling all ink tanks to the upper line when the printer is not operating to reset the ink levels.
- ❑ Always turn the printer off using the  button. Do not unplug the printer or turn off the power at the outlet until the  light stops flashing.
- ❑ Before transporting the printer, make sure that the print head is in the home (far right) position.
- ❑ If you are not going to use the printer for a long period, be sure to unplug the power cord from the electrical outlet.

Important Instructions

Advisories and Warnings for Using Memory Cards

- ❑ Do not remove a memory card or turn off the printer while the memory card light is flashing.
- ❑ The methods for using memory cards vary according to card type. Be sure to refer to the manual packaged with your memory card for details.
- ❑ Use only memory cards compatible with the printer.

Related Information

- ➔ [“Supported Memory Card Specifications” on page 117](#)

Advisories and Warnings for Using the Touchpad

- ❑ The LCD screen may contain a few small bright or dark spots, and because of its features it may have an uneven brightness. These are normal and do not indicate that it is damaged in any way.
- ❑ Only use a dry, soft cloth for cleaning. Do not use liquid or chemical cleaners.
- ❑ The exterior cover of the touchpad could break if it receives a heavy impact. Contact your dealer if the touchpad's surface chips or cracks, and do not touch or attempt to remove the broken pieces.
- ❑ Press the touchpad gently with your finger. Do not press forcefully or operate with your nails.
- ❑ The touchpad is a capacitive touch panel, which responds only when touched directly with a finger. The panel may not respond when touched with wet hands, gloved hands, or touched through a protective sheet or sticker.
- ❑ Do not operate using sharp objects such as a ball point pen, pencil and so on.
- ❑ Condensation inside the touchpad due to abrupt changes in temperature or humidity may cause performance to deteriorate.

Printer Basics

Part Names and Functions

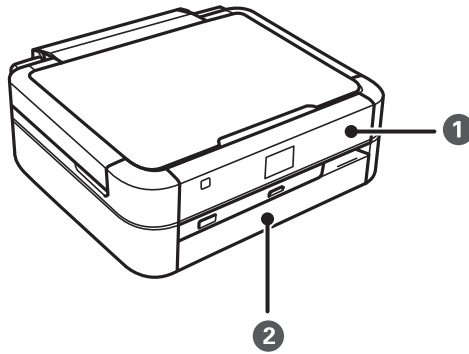

| | | |
|---|---------------|--|
| 1 | Control panel | Operates the printer. |
| 2 | Front cover | Prevents dust from entering the printer. |

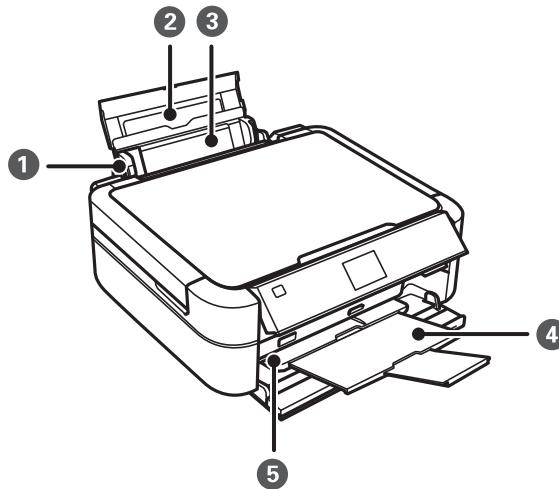

| | | |
|---|-----------------|---|
| 1 | Edge guide | Feeds the paper straight into the printer. Slide to the edges of the paper. |
| 2 | Paper support | Supports loaded paper. |
| 3 | Rear paper feed | Loads paper. Usually keep the rear paper feed closed to prevents foreign substance from entering the printer. |
| 4 | Output tray | Holds the ejected paper. Before printing, raise the stopper to prevent the ejected paper from falling off the tray. |
| 5 | Tray lever | Lower the lever when printing on a disc. When the lever is lowered, the output tray moves so that you can insert the CD/DVD tray. |

Printer Basics

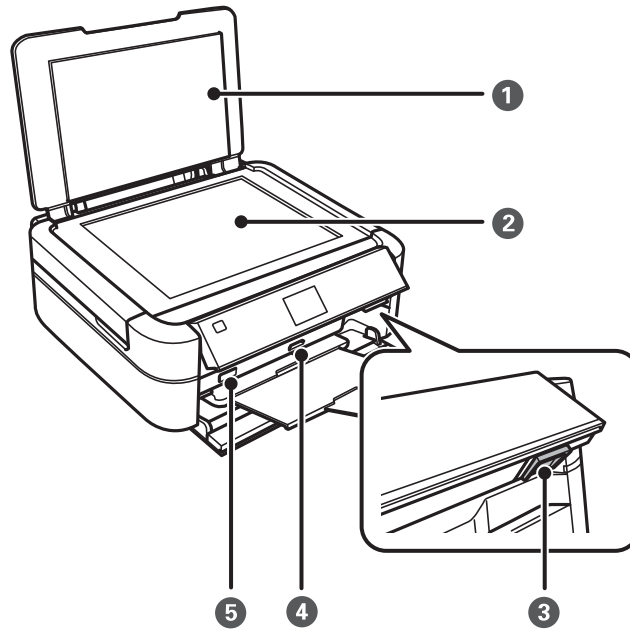

| | | |
|---|-----------------------------|---|
| 1 | Document cover | Blocks external light while scanning. |
| 2 | Scanner glass | Place the originals. |
| 3 | Unlock button | To lower or close the panel, unlock by pushing this button at the rear, and then lower. |
| 4 | Memory card slot | Insert a memory card. |
| 5 | External interface USB port | Connects an external storage device or a PictBridge capable device. |

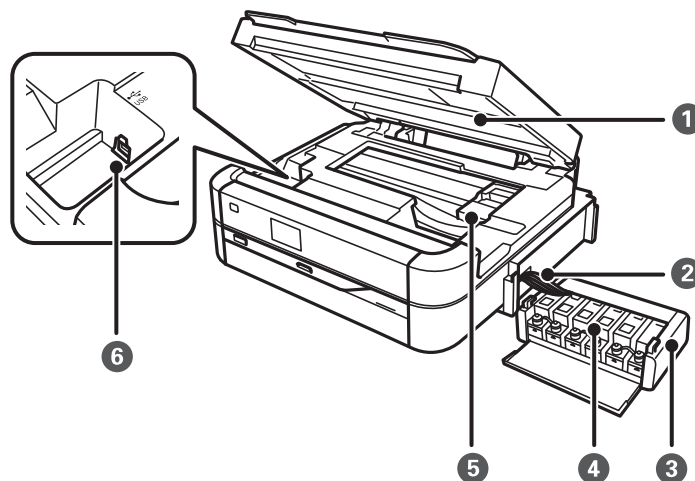

| | | |
|---|--------------|--|
| 1 | Scanner unit | Scans placed originals. Open to remove jammed paper. This unit should usually be kept closed. |
| 2 | Ink tube | Supplies ink to the print head. |

Printer Basics

| | | |
|---|---------------------------------|--|
| 3 | Ink tank unit | Contains the ink tanks. |
| 4 | Ink reservoir tanks (Ink tanks) | Supplies ink to the ink tubes. |
| 5 | Print head | Fires ink. |
| 6 | USB port | Connects a USB cable to connect to a computer. |

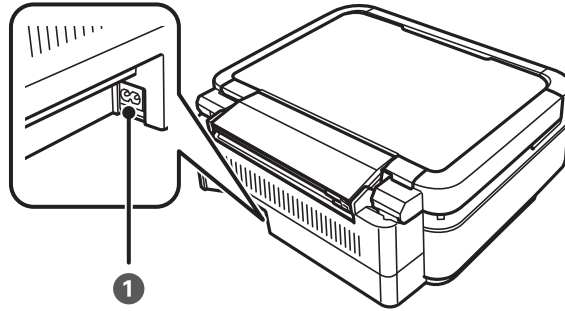

| | | |
|---|----------|--------------------------|
| 1 | AC inlet | Connects the power cord. |
|---|----------|--------------------------|

Control Panel

You can change the angle of the control panel.

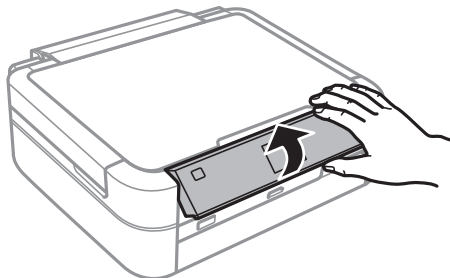

Buttons

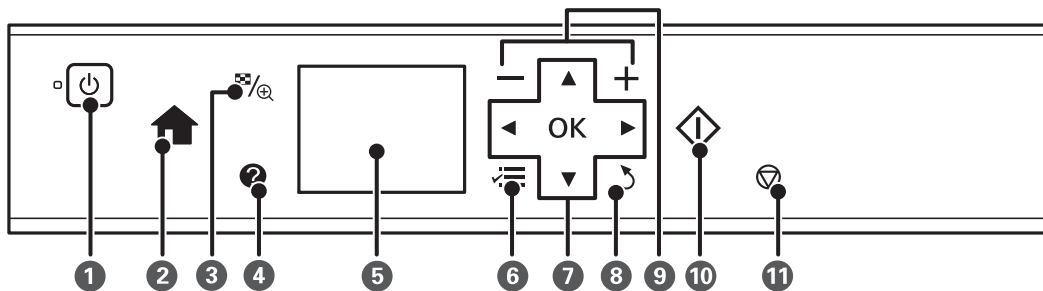

Printer Basics

| | | |
|----|---|--|
| 1 | | Turns the printer on or off. Do not turn off while the power light is flashing (while the printer is operating or processing data). Unplug the power cord when the power light is off. |
| 2 | | Displays the home screen. |
| 3 | | Changes the view of photos or displays the crop setting screen. |
| 4 | | Displays operating instructions, troubleshooting information, and the meaning of icons that appear on the LCD screen. |
| 5 | - | Displays menus and messages. |
| 6 | | Displays detailed setting items. |
| 7 | | Use the buttons to select a menu, and then press the OK button to open the selected menu. |
| 8 | | Returns to the previous screen. |
| 9 | | Selects the number of pages to print. |
| 10 | | Starts an operation such as printing. |
| 11 | | Stops the current operation. |

Related Information

➔ [“Menu Options” on page 17](#)

Guide to the LCD Screen

Menus and messages are displayed on the LCD screen. Select a menu or setting by pressing the buttons.

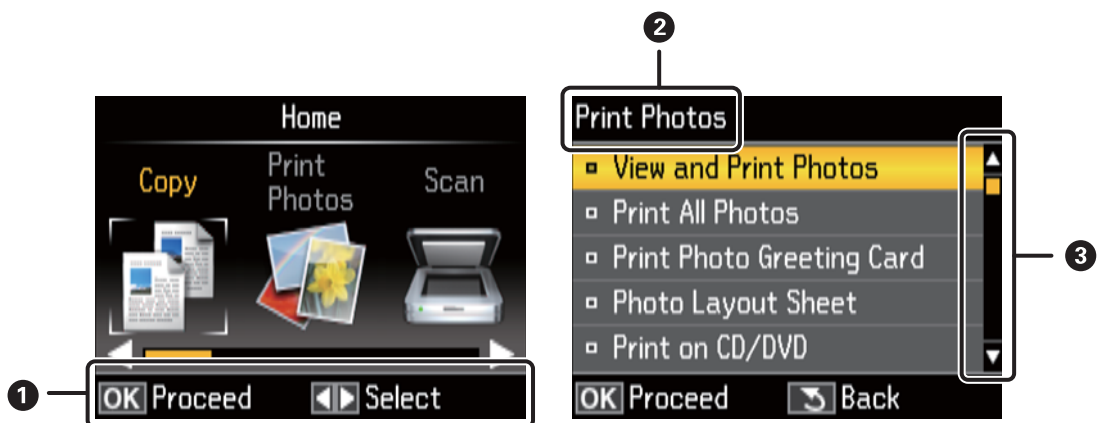

| | |
|---|---|
| 1 | Available buttons are displayed. In this example, you can proceed to the next screen by pressing the OK button, and select another menu by pressing the buttons. |
| 2 | The name of the screen displayed. |
| 3 | When and are displayed, you can scroll up or down. |

Related Information

➔ [“Menu Options” on page 17](#)



Menu Options

Copy Mode

Copy Mode Top Screen

| Menu | Settings and Explanations |
|----------------------|--|
| The number of copies | Enter the number of copies. |
| Color/B&W | Select the color for copying. |
| Density | Set the density of your copies. Increase the level of density when the copying results are too light. Decrease the level of density when ink smears. |

Paper and Copy Settings

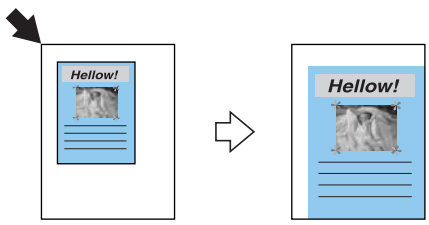

To access the following menus, press the  button on the **Copy** mode top screen, select **Paper and Copy Settings** using the  or  button, and then press the OK button.

| Menu | Settings and Explanations |
|----------------|---|
| Layout | With Border Copies with margins around the edges. |
| | Borderless Copies without margins around the edges. The image is enlarged a little to remove borders from the edges of the paper. |
| | 2-up Copy Copies two single-sided originals onto a single sheet of A4 size paper in 2-up layout. |
| Reduce/Enlarge | <p>Enlarges or reduces the original.</p> <p>Auto Fit Page: All areas that include text and images in the original as well as the space from the corner mark are scanned, and the scanned data is enlarged or reduced to fit to the selected paper size.</p> <div style="text-align: center;">  </div> <p>Custom Size(%): Specifies the magnification to enlarge or reduce the original.</p> |
| | |
| Paper Size | Select the paper size you loaded. |
| Paper Type | Select the paper type you loaded. |
| Document Type | Select the type of your original. |

Printer Basics



| Menu | Settings and Explanations |
|-----------|--|
| Quality | Select the quality for copying. Draft: Provides faster printing, but the printouts may be faint. Best: Provides higher quality printing, but the printing speed may be slower. |
| Expansion | With borderless printing, the image is enlarged a little to remove borders from the edges of the paper. Select how much to enlarge the image. |

Copy/Restore Photos

You can copy your printed photos. To access the following menus, press the  button on the **Copy** mode top screen. Then select **Copy/Restore Photos** using the  or  button, and press the OK button.



| Menu | Settings and Explanations |
|-------------------|--------------------------------------|
| Color Restoration | Restores the colors in faded photos. |

Menu Options for Copy/Restore Photos

To access the following menus, press the  button while a scanned photo is displayed, and then select **Paper and Copy Settings** using the  or  button, and then press the OK button.

| Menu | Settings and Explanations |
|------------|---|
| Paper Size | Select the paper size you loaded. |
| Paper Type | Select the paper type you loaded. |
| Borderless | Copies without margins around the edges. The image is enlarged a little to remove borders from the edges of the paper. |
| Expansion | With borderless printing, the image is enlarged a little to remove borders from the edges of the paper. Select how much to enlarge the image. |
| Enhance | Selecting PhotoEnhance produces sharper images and more vivid colors by automatically adjusting the contrast, saturation, and brightness of the original image data. |
| Filter | Prints in monochrome. |

Copy to CD/DVD

You can copy your photo or CD/DVD label onto a CD/DVD. To access the following menus, press the  button on the copy settings screen, select **Copy to CD/DVD** using the  or  button, and then press the OK button.

Note:



You cannot copy on 8 cm discs.

| Menu | Settings and Explanations |
|-------------|--|
| Outer/Inner | Specify the print range. Up to 120 mm for the outer diameter, and a minimum of 18 mm for the inner diameter can be specified. Depending on the setting, the CD/DVD or CD/DVD tray may get dirty. Set the range to fit the printable area of your CD/DVD. |

Printer Basics

| Menu | Settings and Explanations |
|------------------------|--|
| Print on a CD/DVD | Select whether to print a test on A4 size plain paper or print on a CD/DVD. |
| Test print on A4 paper | |
| Color/B&W | Select the color for copying. |
| Density | Set the density of your copies. Increase the level of density when the copying results are too light. Decrease the level of density when ink smears. |



Menu Options for Copy to CD/DVD

To access the following menus, press the  button on the copy settings screen, select **Paper and Copy Settings** using the  or  button, and then press the OK button.

| Menu | Settings and Explanations |
|---------------|---|
| Document Type | Select the type of your original. |
| Quality | Select the quality for copying. Best is only available when selecting Print on a CD/DVD . Standard Quality: Provides faster printing, but the printouts may be faint. Best: Provides higher quality printing, but the printing speed may be slower. |

Copy Layout Wizard

The wizard guides you through selecting a copy layout, paper size and paper type. First, set the number of copies and copy color (Color or B&W) on the **Copy** mode top screen, and then run the wizard.

To run the wizard, press the  button on the **Copy** mode top screen, select **Copy Layout Wizard** using the  or  button, and then press the OK button.

Maintenance

You can access the menus for maintaining the printer. See the list of menus in **Setup** mode.



Related Information

- ➔ [“Loading Paper in the Rear Paper Feed” on page 30](#)
- ➔ [“Placing Originals on the Scanner Glass” on page 33](#)
- ➔ [“Copying” on page 66](#)

Print Photos Mode

| Menu | Settings and Explanations |
|---------------------------|---|
| View and Print Photos | You can select the photos on a memory card that you want to print while viewing them on the LCD screen. |
| Print All Photos | You can print all photos on a memory card at the same time. |
| Print Photo Greeting Card | You can add handwritten text to a photo. |

Printer Basics

| Menu | Settings and Explanations | |
|---------------------|---|--|
| Photo Layout Sheet | You can print your photos in various layouts, such as printing multiple photos on a sheet of photo paper. | |
| Print on CD/DVD | You can print the photos on a memory card onto a CD/DVD. | |
| Print Proof Sheet | You can print all photos on a memory card as an index. Press the  button, and then select Print Settings to change the paper size and paper type. | |
| Slide Show | You can print your photos on a memory card by viewing the photos with slide show. To make print settings, press the  button after selecting photos. See the list of menus in View and Print Photos for more details. | |
| Copy/Restore Photos | You can copy your printed photos. | |
| Select Location | Select Folder | Select a folder to display the photos on the external storage device. |
| | Select Group | If you have 1000 or more photos on your memory card, photos are automatically divided into groups containing a maximum of 999 photos. Select a group to display. |

Menu Options for View and Print Photos

To access the following menus, press the  button when a photo is displayed on a screen.

| Menu | Settings and Explanations | |
|---------------|---------------------------|--|
| Select Photos | Select All Photos | Select all the photos on the memory card and set the number of prints. |
| | Select by Date | Displays the photos on the memory card sorted by date. Select a date to display all photos saved on that date. |
| | Cancel Photo Selection | Returns the number of copies of all photos to 0 (zero). |

Printer Basics

| Menu | Settings and Explanations | | |
|-------------------|---|---|--|
| Print Settings | Paper Size | Select the paper size you loaded. | |
| | Paper Type | Select the paper type you loaded. | |
| | Borderless | Prints without margins around the edges. The image is enlarged a little to remove borders from the edges of the paper. | |
| | Quality | Select the print quality. Selecting Best provides higher quality printing, but the printing speed may be slower. | |
| | Expansion | With borderless printing, the image is enlarged a little to remove borders from the edges of the paper. Select how much to enlarge the image. | |
| | Date | Select a date format to print photos with a date. The date is not printed for some layouts or if date information is not included in the photo data. | |
| | Fit Frame | Trims your photo. This may not be available for panorama photos. The photo is always trimmed in Borderless , Upper 1/2 , or Lower 1/2 | |
| | | On | Crops the top and bottom or left and right of the image. |
| Off | | Creates margins on the left and right or top and bottom of the image. | |
| Bidirectional | Prints while the print head moves to the left and to the right. Selecting Off (prints while moving in one direction) provides higher quality printing, but the printing speed may be slower. | | |
| Photo Adjustments | Enhance | Select one of the image adjustment options. PhotoEnhance: Produces sharper images and more vivid colors by automatically adjusting the contrast, saturation, and brightness of the original image data. P.I.M.: Adjusts the image based on the print information provided by a digital camera compatible with PRINT Image Matching. | |
| | Scene Detection | Available when selecting PhotoEnhance as the Enhance setting. Improves the image quality for photos of people, landscapes, and night scenes. | |
| | Fix Red-Eye | Fixes red-eye in photos. Corrections are not applied to the original file, only to the printouts. Depending on the type of photo, parts of the image other than the eyes may be corrected. | |
| | Filter | Prints in sepia or monochrome. | |
| | Brightness | Adjusts the brightness of the image. | |
| | Contrast | Adjusts the difference between the brightness and darkness. | |
| | Sharpness | Enhances or defocuses the outline of the image. | |
| | Saturation | Adjusts the vividness of the image. | |
| Maintenance | You can access the menus for maintaining the printer. See the list of menus in Setup mode. | | |

Printer Basics

Photo Layout Sheet

| Menu | Settings and Explanations | |
|---------------|---|--|
| Layout | Select a layout. 20-up: The serial number or date is printed below each photo. Sticker 16-up: Select when printing on photo stickers. P.I.F. is displayed if you have a P.I.F. frame on your memory card. | |
| Paper Size | Select the paper size you loaded. | |
| Paper Type | Select the paper type you loaded. | |
| Layout method | Select how to place the photos. | |
| | Automatic layout | Photos are placed automatically using the selected layout. If the number of selected photos is less than that of the selected layout, blank spaces appear on the printout. |
| | Place photos manually | Manually place the photos in a selected layout. Selecting Leave blank provides a blank space in the printout. |

Menu Options for Photo Layout Sheet

To access the following menus, press the  button on the photo selection screen.

| Menu | Settings and Explanations |
|-------------------|---|
| Select Photos | See the list of menus in View and Print Photos for more details. |
| Print Settings | |
| Photo Adjustments | |
| Maintenance | See the list of menus in Setup for more details. |

Print on CD/DVD

Note:

You can only print on an 8 cm disc when printing from a computer.

| Menu | Settings and Explanations |
|--------|--|
| Layout | Select the layout you want to use to print onto a CD/DVD. CD/DVD Variety automatically lays out the 10 photos you selected. <div style="text-align: center; margin-top: 20px;">  </div> |

Printer Basics

| Menu | Settings and Explanations | |
|------------------------|--|--|
| Layout method | Select how to place the photos. | |
| | Automatic layout | Photos are placed automatically using the selected layout. If the number of selected photos is less than that of the selected layout, blank spaces appear on the printout. |
| | Place photos manually | Manually place the photos in a selected layout. Selecting Leave blank provides a blank space in the printout. |
| Outer | Specify the print range. Up to 120 mm for the outer diameter, and a minimum of 18 mm for the inner diameter can be specified. Depending on the setting, the CD/DVD or CD/DVD tray may get dirty. Set the range to fit the printable area of your CD/DVD. | |
| Inner | | |
| Print on a CD/DVD | Select whether to print a test on A4 size plain paper or print on a CD/DVD. | |
| Test print on A4 paper | | |

Menu Options for Print on CD/DVD

To access the following menus, press the  button when a photo is displayed on a screen.

| Menu | Settings and Explanations | |
|-------------------|---|---|
| Print Settings | CD Density | Set the density to use when printing onto a CD/DVD. |
| Photo Adjustments | See the list of menus in View and Print Photos for more details. | |
| Maintenance | See the list of menus in Setup for more details. | |

Menu Options for Copy/Restore Photos

See the list of menus **Copy/Restore Photos** in the **Copy** mode.

Related Information

- ➔ [“Loading Paper in the Rear Paper Feed” on page 30](#)
- ➔ [“Inserting and Removing a Memory Card” on page 35](#)
- ➔ [“Copy Mode” on page 17](#)
- ➔ [“Printing from the Control Panel” on page 41](#)

Scan Mode

| Menu | Settings and Explanations |
|---------------------|---|
| Scan to Memory Card | Scans your original and saves the scanned image to the memory card inserted into the printer. You can change the format or scan area. |
| Scan to PC | Saves the scanned image to a computer in JPEG format. |

Printer Basics

| Menu | Settings and Explanations |
|--------------------|--|
| Scan to PC (PDF) | Saves the scanned image to a computer in PDF format. |
| Scan to PC (Email) | Attaches the scanned image to an email. |

Menu Options for Scan

The following menus are only available for **Scan to Memory Card**.

| Menu | Settings and Explanations |
|-----------|--|
| Format | Select the format in which to save the scanned image. |
| Scan Area | Select the scan area. Auto Cropping: Crops the white space around the text or image when scanning. Max Area: Scans at the maximum scan area of the scanner glass. Select this setting and scan again if the edges of the scanned image are cropped when A4 is selected. |
| Document | Select the type of your original. |
| Quality | Select the scan quality. |

Related Information

- ➔ [“Placing Originals on the Scanner Glass” on page 33](#)
- ➔ [“Inserting and Removing a Memory Card” on page 35](#)
- ➔ [“Scanning Using the Control Panel” on page 69](#)

Setup Mode

| Menu | Settings and Explanations | |
|-------------|---------------------------|--|
| Maintenance | Nozzle Check | Prints a pattern to check if the print head nozzles are clogged. |
| | Head Cleaning | Cleans clogged nozzles in the print head. |
| | Head Alignment | Adjusts the print head to improve print quality. |
| | Reset Ink Levels | Resets ink levels. |

Printer Basics

| Menu | Settings and Explanations | |
|--------------------------|---|---|
| Printer Setup | CD/DVD | Adjusts the printing position of a CD/DVD. |
| | Stickers | Adjusts the printing position of a photo sticker. |
| | Thick Paper | Use this feature if ink smears and the paper gets dirty. When enabled, the printing speed may be slower. Only enable this setting when ink smears. It is disabled when the printer is turned off. |
| | Sound | Adjust the volume and select the type of audio. |
| | Screen Saver | By selecting Memory Card Data , photos are displayed sequentially when no operations are performed for about three minutes. |
| | Display Options | Select the default setting used to display the photos on the memory card. 1 photo : Displays one photo on a screen. Information on settings, such as zoom, is also displayed. 1 photo without Info : Displays one photo on a screen. Information on settings, such as zoom, is not displayed. Thumbnail: Displays nine photos on a screen. |
| | Power Off Timer | You can adjust the time before power management is applied. Any increase will affect the product's energy efficiency. Please consider the environment before making any change. |
| | Sleep Timer | Select the time period before the printer enters sleep mode (energy saving mode) when no operations are performed. The LCD screen turns black when the set time passes. |
| | Language | Select the display language. |
| External Device Setup | Change the print settings to print directly from an external device such as a digital camera. | |
| Restore Default Settings | Resets the selected settings to their defaults. | |

Related Information

➔ [“Improving Print and Scan Quality” on page 82](#)

Back Up Data Mode

Back Up Memory Card allows you to save the data on a memory card to an external storage device such as a hard disk or USB flash memory without using a computer.

| Menu | Settings and Explanations |
|---------------------|---|
| Back Up Memory Card | Select this menu after connecting an external USB storage device. A folder is automatically created for each photo. When saving the data to a disc, you can change the writing speed by pressing the  button, and then selecting Writing Speed . |

Related Information

➔ [“Inserting and Removing a Memory Card” on page 35](#)

Printer Basics

➔ [“External Storage Device Specifications” on page 117](#)

Loading Paper

Paper Handling Precautions

- ❑ Read the instruction sheets supplied with the paper.
- ❑ Fan and align the edges of the paper before loading. Do not fan or curl photo paper. Doing so may damage the printable side.

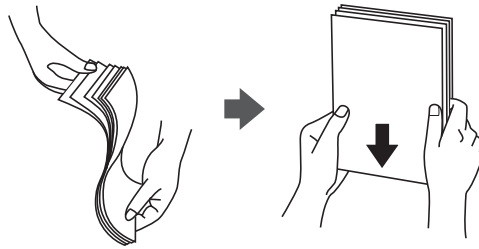

- ❑ If the paper is curled, flatten it or curl it slightly in the opposite direction before loading. Printing on curled paper may cause paper jams and smears on the printout.

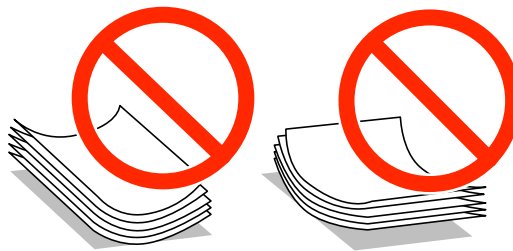

- ❑ Do not use paper that is wavy, torn, cut, folded, damp, too thick, too thin, or paper that has stickers stuck to it. Using these types of paper causes paper jams and smears on the printout.
- ❑ Fan and align the edges of the envelopes before loading. When the stacked envelopes are puffed up with air, press them down to flatten them before loading.

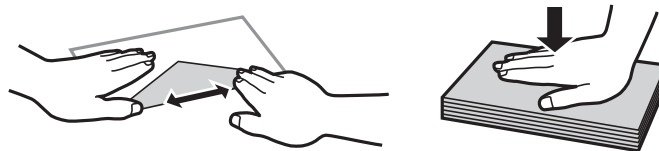

- ❑ Do not use envelopes that are curled or folded. Using these envelopes causes paper jams and smears on the printout.
- ❑ Do not use envelopes with adhesive surfaces on the flaps or window envelopes.
- ❑ Avoid using envelopes that are too thin, as they may curl during printing.

Related Information

- ➔ [“Printer Specifications” on page 115](#)

Available Paper and Capacities

Epson recommends using genuine Epson paper to ensure high-quality printouts.

Genuine Epson Paper

| Media Name | Size | Loading Capacity (Sheets) | Manual 2-Sided Printing | Borderless Printing |
|--|---|---------------------------|-------------------------|---------------------|
| Epson Bright White Ink Jet Paper | A4 | 80*1 | ✓ | - |
| Epson Ultra Glossy Photo Paper | A4, 13 × 18 cm (5 × 7 in.), 10 × 15 cm (4 × 6 in.) | 20 | - | ✓ |
| Epson Premium Glossy Photo Paper | A4, 13 × 18 cm (5 × 7 in.), 16:9 wide size (102 × 181 mm), 10 × 15 cm (4 × 6 in.) | 20 | - | ✓ |
| Epson Premium Semigloss Photo Paper*2 | A4, 10 × 15 cm (4 × 6 in.) | 20 | - | ✓ |
| Epson Photo Paper Glossy | A4, 13 × 18 cm (5 × 7 in.), 10 × 15 cm (4 × 6 in.) | 20 | - | ✓ |
| Epson Matte Paper-Heavyweight | A4 | 20 | - | ✓ |
| Epson Double-Sided Matte Paper*2 | A4 | 1 | ✓ | - |
| Epson Photo Quality Ink Jet Paper | A4 | 100 | - | - |
| Epson Photo Stickers 16 | A6 | 1 | - | - |
| Epson Iron-On Cool Peel Transfer Paper*2 | A4 | 1 | - | - |

*1 For manual 2-sided printing, you can load up to 30 sheets for paper with one side already printed.

*2 Only printing from computer is available.

Note:

The availability of paper varies by location. For the latest information on paper available in your area, contact Epson support.

Loading Paper

Commercially Available Paper

| Media Name | Size | Loading Capacity (Sheets) | Manual 2-Sided Printing | Borderless Printing |
|------------------------|--|--|-------------------------|---------------------|
| Plain paper | Letter ^{*1} , A4, B5 ^{*1} , A5, A6 ^{*1} | Up to the line indicated by the triangle symbol on the edge guide. ^{*2} | ✓ | - |
| | Legal ^{*1} , User Defined ^{*1} | 1 | | |
| Envelope ^{*1} | Envelope #10, Envelope DL, Envelope C6 | 10 | - | |

*1 Only printing from computer is available.

*2 For manual 2-sided printing, you can load up to 30 sheets for paper with one side already printed.

Related Information

➔ [“Technical Support Web Site” on page 125](#)

List of Paper Types

To obtain optimum printing results, select the paper type that suits the paper.

| Media Name | Media Type | |
|--|----------------|-----------------------------|
| | Control Panel | Printer Driver |
| Epson Bright White Ink Jet Paper [*] | Plain Paper | plain papers |
| Epson Ultra Glossy Photo Paper [*] | Ultra Glossy | Epson Ultra Glossy |
| Epson Premium Glossy Photo Paper [*] | Prem. Glossy | Epson Premium Glossy |
| Epson Premium Semigloss Photo Paper [*] | - | Epson Premium Semigloss |
| Epson Photo Paper Glossy [*] | Glossy | Photo Paper Glossy |
| Epson Matte Paper-Heavyweight [*] | Matte | Epson Matte |
| Epson Double-Sided Matte Paper [*] | - | Epson Matte |
| Epson Photo Quality Ink Jet Paper [*] | Matte | Epson Photo Quality Ink Jet |
| Epson Photo Stickers 16 [*] | Photo Stickers | Epson Photo Stickers |
| Epson Iron-On Cool Peel Transfer Paper | - | plain papers |
| Plain paper [*] | Plain Paper | plain papers |
| Envelope | - | Envelope |

Loading Paper

* These paper types are compatible with Exif Print and PRINT Image Matching when printed by the printer driver. For more information, see the documentation that came with the Exif Print or PRINT Image Matching compatible digital camera.

Loading Paper in the Rear Paper Feed

1. Open the rear paper feed, and then extend the paper support.

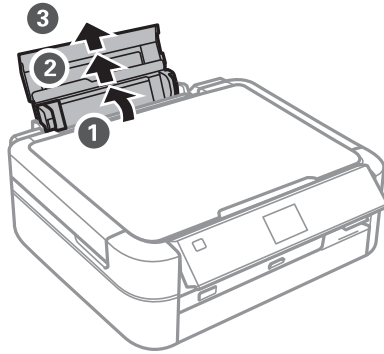

2. Slide the edge guide to the left.

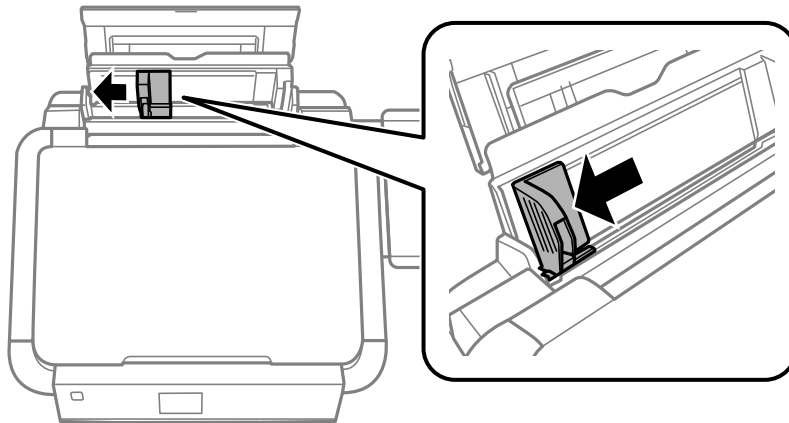

3. Load paper vertically along the right side of the rear paper feed with the printable side facing up.

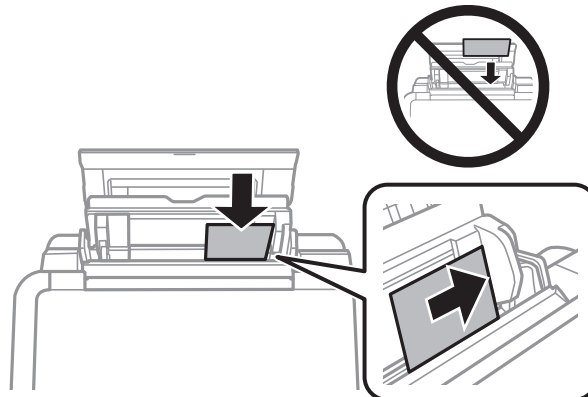

Loading Paper

! Important:

- ❑ Do not load more than the maximum number of sheets specified for the paper. For plain paper, do not load above the line indicated by the triangle symbol on the edge guide.
- ❑ When loading envelopes, load the short edge first with the flap facing down and to the left.

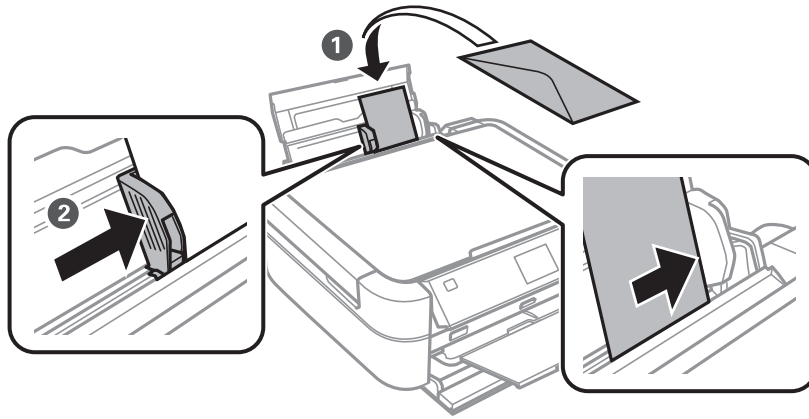

- ❑ Do not use paper with binding holes.

4. Slide the edge guide to the edge of the paper.

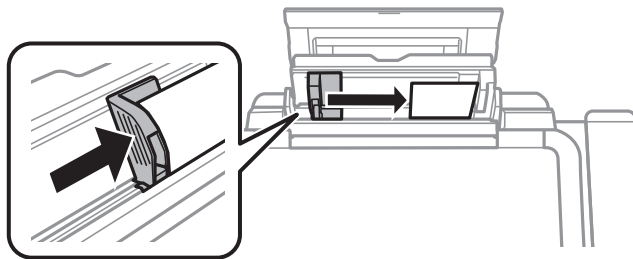

5. Open the front cover, and then slide out the output tray and the stopper.

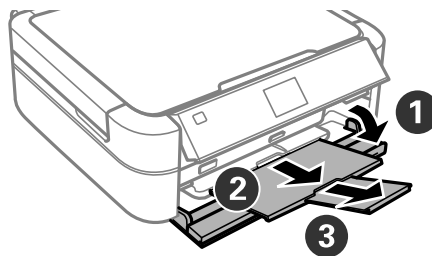

Loading Paper

6. Make sure that the tray lever is in the up position.

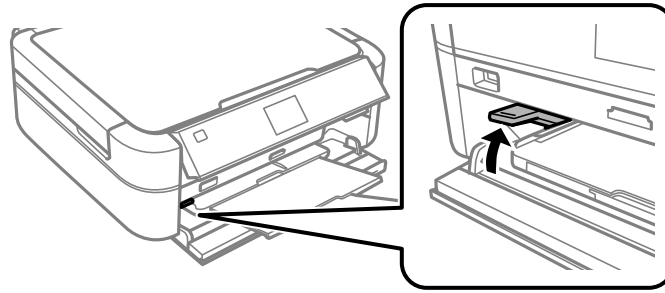

Important:

- Do not move the tray lever while the printer is operating.
- Before you move the tray lever, make sure no paper or other objects are on the output tray and the output tray is not extended.
- Do not touch the output tray when moving the tray lever.

Note:

Return the remaining paper to its package. If you leave it in the printer, the paper may curl or the print quality may decline.

Related Information

- ➔ [“Paper Handling Precautions” on page 27](#)
- ➔ [“Available Paper and Capacities” on page 28](#)

Placing Originals on the Scanner Glass

Placing Originals on the Scanner Glass



Important:

When placing bulky originals such as books, prevent exterior light from shining directly onto the scanner glass.

1. Open the document cover.

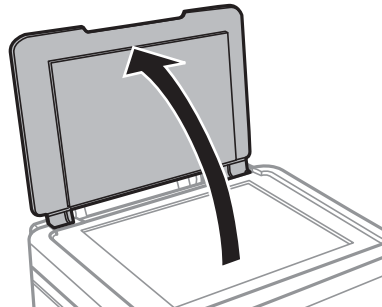

2. Remove any dust or stains on the scanner glass.
3. Place the original face-down and slide it to the corner mark.

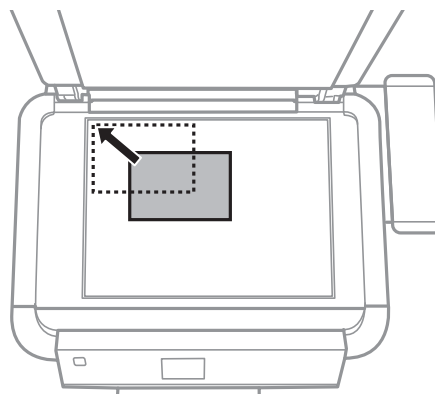

Note:

A range of 1.5 mm from the edges of the scanner glass is not scanned.

- When copying photos, place the photos 5 mm apart from the edges of the scanner glass.

You can place up to two photos at the same time (depending on the size of originals). Leave 5 mm between photos.

You can place photos of different sizes at the same time. The photos should be larger than 30 x 40mm.

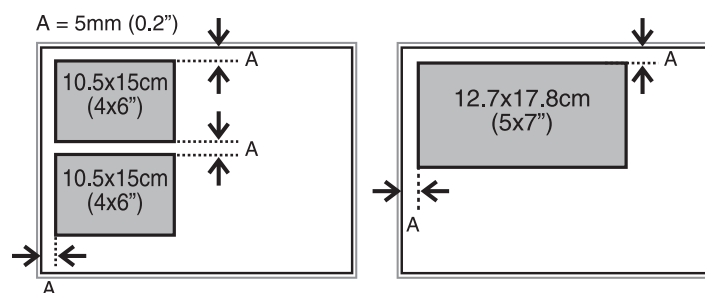

Placing Originals on the Scanner Glass

- ❑ To copy a CD/DVD label, place the CD/DVD in the center of the scanner glass. If the CD/DVD is not placed exactly in the center, the positioning is automatically adjusted.

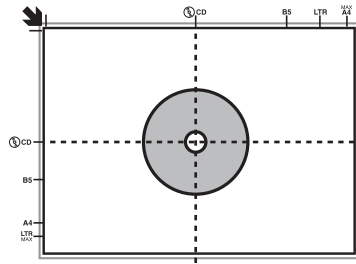

- ❑ If you are scanning using **Full Auto Mode** or thumbnail preview in EPSON Scan, place the original 4.5 mm away from the edges of the scanner glass.

Place multiple photos at least 20 mm apart from each other.

The photos should be larger than 15 x 15 mm.

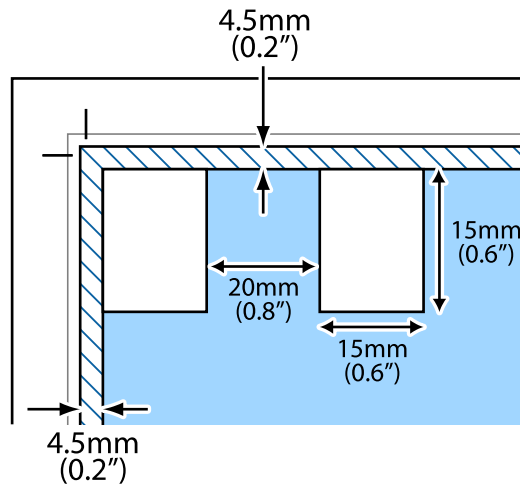



4. Close the cover gently.

Note:

Remove the originals after scanning or copying. If you leave the originals on the scanner glass for a long time, they may stick to the surface of the glass.

Inserting a Memory Card

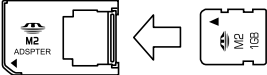
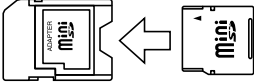
Supported Memory Cards

| | |
|---|---|
|  | <p>Memory Stick Memory Stick PRO MagicGate Memory Stick</p> |
|  | <p>Memory Stick Duo* Memory Stick PRO Duo* Memory Stick PRO-HG Duo* Memory Stick Micro* MagicGate Memory Stick Duo*</p> |
|  | <p>miniSD* miniSDHC* microSD* microSDHC* microSDXC*</p> |
|  | <p>SD SDHC SDXC</p> |

* Attach an adapter to fit the memory card slot. Otherwise, the card may get stuck.

Related Information

➔ [“Supported Memory Card Specifications” on page 117](#)

Inserting and Removing a Memory Card

1. Insert a memory card into the printer.

The printer starts reading the data and the light flashes. When reading is complete, the light stops flashing and remains on.

Inserting a Memory Card

! *Important:*

Do not try to force the card all the way into the slot. It should not be fully inserted.

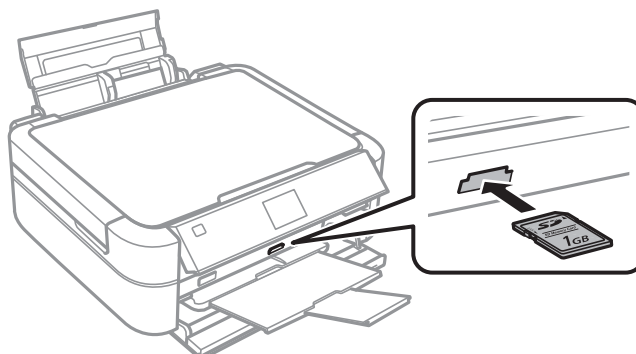

2. When you have finished using the memory card, make sure the light is not flashing, and then remove the card.

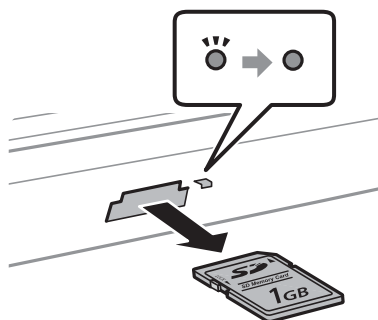

! *Important:*

If you remove the memory card while the light is flashing, the data in the memory card may be lost.

Note:

If you access the memory card from a computer, you need to operate the computer to safely remove the removal device.

Related Information

- ➔ [“Accessing a Memory Card From a Computer” on page 124](#)

Loading a CD/DVD for Printing

Printable CD/DVDs

You can print on a circular 12-cm or 8-cm CD/DVD labelled as suitable for printing, for example "printable on the label surface" or "printable with ink jet printers."

You can also print on a Blu-ray Discs™.

CD/DVD Handling Precautions

- ❑ See the documentation provided with your CD/DVD for more information on handling the CD/DVD or writing data.
- ❑ Do not print on the CD/DVD before writing your data to it. If you do, fingerprints, dirt, or scratches on the surface may cause errors while writing data.
- ❑ Depending on the CD/DVD type or printing data, smearing may occur. Try making a test print on a spare CD/DVD. Check the printed surface after waiting for one full day.
- ❑ Compared to printing on genuine Epson paper, the print density is lowered to prevent ink from smearing on the CD/DVD. Adjust the print density as necessary.
- ❑ Allow the printed CD/DVDs at least 24 hours to dry avoiding direct sunlight. Do not stack or insert the CD/DVDs into your device until they are completely dry.
- ❑ If the printed surface is sticky even after it has dried, lower the print density.
- ❑ Reprinting on the same CD/DVD may not improve the print quality.
- ❑ If the CD/DVD tray or the internal transparent compartment are accidentally printed on, immediately wipe off the ink.
- ❑ Depending on the print area setting, the CD/DVD or CD/DVD tray may get dirty. Make settings to print on the printable area.

Related Information

- ➔ [“Epson Print CD” on page 95](#)
- ➔ [“Printable Area” on page 115](#)

Loading a CD/DVD

! **Important:**

- Before printing on the CD/DVD, see the CD/DVD handling precautions.
- Do not insert the CD/DVD tray while the printer is operating. This may damage the printer.
- Do not insert the CD/DVD tray until you are instructed to do so.
- Insert the CD/DVD tray while the power is on. Otherwise, automatic print position adjustment may not take place after inserting the CD/DVD tray.
- Do not turn the printer on or off while the CD/DVD tray is inserted in the printer. This may damage the printer.

1. Send print data from a computer, or select the menu you want to use to print on a CD/DVD on the control panel.
2. When a message prompts you to load a CD/DVD, follow the instructions below to load the CD/DVD.
3. Open the front cover, and then move the tray lever down.

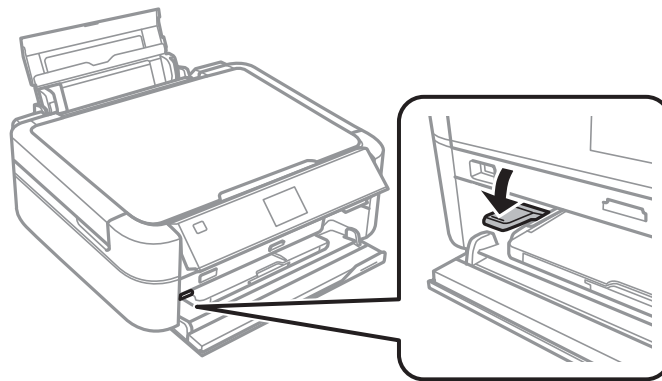

! **Important:**

- Do not move the tray lever while the printer is operating.
- Before you move the tray lever, make sure no paper or other objects are on the output tray and the output tray is not extended.
- Do not touch the output tray when moving the tray lever.

4. Place a CD/DVD on the CD/DVD tray with the printable side facing up.
 - When printing on a 12-cm CD/DVD, set it directly onto the CD/DVD tray, without the adapter.

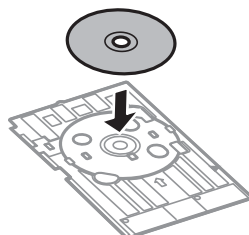

Loading a CD/DVD for Printing

- ❑ When printing on an 8-cm CD/DVD, fit the adapter into the CD/DVD tray, and then set an 8-cm CD/DVD inside the adapter.

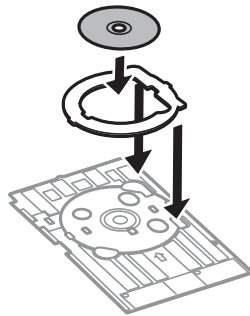

5. Insert the CD/DVD tray into the printer making sure that it passes under the right and left guides. Line up the alignment marks on the printer and the tray.

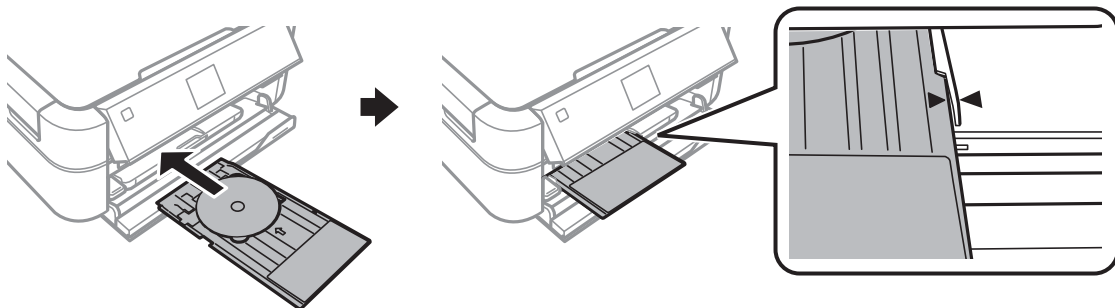

Related Information

- ➔ [“Printable CD/DVDs” on page 37](#)
- ➔ [“CD/DVD Handling Precautions” on page 37](#)

Removing a CD/DVD

! *Important:*

Do not turn the printer on or off while the CD/DVD tray is inserted in the printer. This may damage the printer.

1. Remove the CD/DVD tray, and then remove the CD/DVD from the tray.

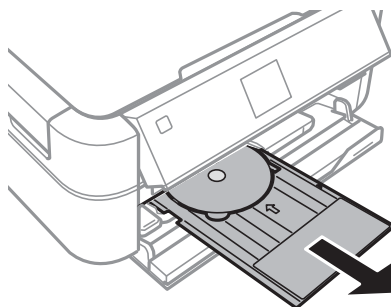

Loading a CD/DVD for Printing



Important:

Store the CD/DVD tray in a flat place. A warped or damaged CD/DVD tray may cause malfunctions.

2. Move the tray lever up.

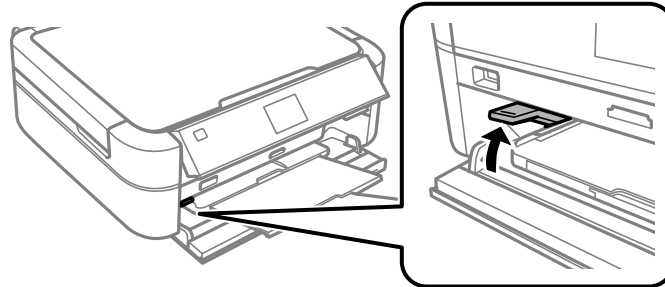

Important:

- Do not move the tray lever while the printer is operating.
- Before you move the tray lever, make sure no paper or other objects are on the output tray and the output tray is not extended.
- Do not touch the output tray when moving the tray lever.

Related Information

- ➔ [“CD/DVD Handling Precautions” on page 37](#)

Printing

Printing from the Control Panel

Printing Photos by Selecting from a Memory Card

1. Load paper in the printer.
2. Insert a memory card into the printer.



Important:



Do not remove the memory card until you have finished printing.



Note:

- Remove the memory card when printing from an external storage device such as a hard disk or USB flash memory.
- If you have 1000 or more photos on your memory card, photos are automatically divided into groups containing a maximum of 999 photos and the Select Group screen is displayed. Select a group containing the photos you want to print.

3. Enter **Print Photos** from the home screen using the ◀ or ▶ button, and then press the OK button.
4. Select **View and Print Photos** using the ▲ or ▼ button, and then press the OK button.
5. Select a photo using the ◀ or ▶ button, and then set the number of copies using the ▲ or ▼ button. When printing more than one photo, repeat this procedure.

Note:

- Press the /Ⓜ button to crop a part of a photo. Use the ▲, ▼, ◀, or ▶ button to move the frame to the area you want to crop, and then press the – or + button to change the size of the frame. Press the  button to rotate the frame.
- If you want to show a photo without indicators when one photo is displayed on a screen, press the /Ⓜ button twice. Press this button twice again to show indicators.

6. Press the  button to display the menu, select **Print Settings** using the ▲ or ▼ button, and then press the OK button.
7. Select setting items such as the paper size using the ▲ or ▼ button, and then press the OK button.
8. Change the settings using the ▲ or ▼ button. Press the OK button to confirm the settings. When you have finished, press the  button.
9. Press the OK button to display the print settings confirmation screen.
10. Press the  button.

Printing

Related Information

- ➔ “Loading Paper in the Rear Paper Feed” on page 30
- ➔ “List of Paper Types” on page 29
- ➔ “Inserting a Memory Card” on page 35
- ➔ “Print Photos Mode” on page 19

Printing Photos from a Memory Card onto a CD/DVD Label

You can select photos stored on a memory card to print onto a CD/DVD label.

1. Insert a memory card into the printer.



Important:

Do not remove the memory card until you have finished printing.

2. Enter **Print Photos** from the home screen using the ◀ or ▶ button, and then press the OK button.
3. Select **Print on CD/DVD** using the ▲ or ▼ button, and then press the OK button.
4. Select the layout using the ◀ or ▶ button, and then press the OK button.
5. Check the screen, and then press the OK button. For **CD/DVD 4-up**, select whether to place photos automatically or manually using the ▲ or ▼ button, and then press the OK button.
6. Select the photos you want to print using the ◀ or ▶ button, set the number of copies using the – or + button, and then press the OK button. When placing photos manually for **CD/DVD 4-up**, after displaying the photo you want to print using the ◀ or ▶ button, select **Place this photo** using the ▲ or ▼ button, and then press the OK button. If you want to leave a blank space, select **Leave blank** using the ▲ or ▼ button, and then press the OK button.

Note:

- ❑ *The available number of copies is displayed at the top of the screen where you select the photos you want to print and the number of copies. You can select photos until 0 is indicated.*
- ❑ *Press the /Ⓚ button to crop a part of a photo. Use the ▲, ▼, ◀, or ▶ button to move the frame to the area you want to crop, and then press the – or + button to change the size of the frame.*

7. Check the screen, and then press the OK button.
8. Set the outer diameter using the ◀ or ▶ button, set the inner diameter using the ▲ or ▼ button, and then press the OK button.

Note:



You can set 114 to 120 mm as the outer diameter, and 18 to 46 mm as the inner diameter in 1 mm increments.

9. Select **Print on a CD/DVD** using the ▲ or ▼ button, and then press the OK button.

Note:

*For test printing, select **Test print on A4 paper**, and then load A4 plain paper in the printer. You can check the printout image before printing on a CD/DVD label.*

Printing

10. Press the OK button to check the instructions, load a CD/DVD, and then press the OK button.
11. If necessary, change the density settings by pressing the  button, and then selecting **Print Settings > CD Density**.
12. Press the  button.
13. When printing has finished, remove the CD/DVD tray from the printer.

Related Information

- ➔ [“Inserting a Memory Card” on page 35](#)
- ➔ [“Print Photos Mode” on page 19](#)
- ➔ [“Loading a CD/DVD” on page 38](#)
- ➔ [“Removing a CD/DVD” on page 39](#)

Printing Photos from a Memory Card with Handwritten Notes

You can print a photo on a memory card with handwritten text or drawings. This allows you to create original cards such as New Year's cards or Christmas cards.

First select a photo and print a template on plain paper. Write or draw on the template and then scan it with the printer. You can then print the photo with your own personal notes and drawings.

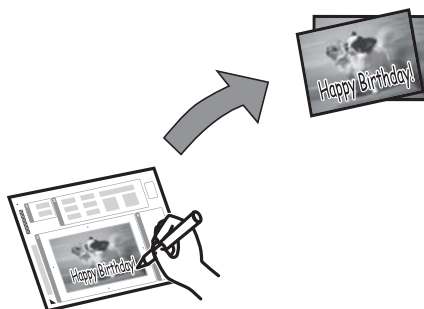











1. Insert a memory card into the printer.



Important:

Do not remove the memory card until you have finished printing.

2. Enter **Print Photos** from the home screen using the  or  button, and then press the OK button.
3. Select **Print Photo Greeting Card** using the  or  button, and then press the OK button.
4. Select **Select Photo and Print Template** using the  or  button, and then press the OK button.
5. Select a photo using the  or  button, and then press the OK button.
6. Select the paper size using the  or  button, and then press the OK button.

Printing

7. Select the paper type using the ▲ or ▼ button, and then press the OK button.
8. Select the layout using the ▲ or ▼ button, and then press the OK button.
9. Select the frame using the ▲ or ▼ button, and then press the OK button.
10. Load A4 plain paper in the printer to print a template.
11. Press the ◊ button to print a template.
12. Follow the instructions on the template to write and draw.
13. Load paper that matches the paper type and size indicated on the right of the template in the printer.
14. Select **Print Greeting Cards from Template** using the ▲ or ▼ button, and then press the OK button.
15. Check the screen, place the template on the scanner glass, and then press the OK button.

Note:

Make sure that the text on the template is completely dry before placing it on the scanner glass. If there are stains on the scanner glass, the stains are also printed on the photo.

16. Set the number of copies using the – or + button.

Note:

Press the  button to adjust the colors in the photos.

17. Press the ◊ button.

Related Information

- ➔ [“Inserting a Memory Card” on page 35](#)
- ➔ [“Print Photos Mode” on page 19](#)
- ➔ [“Loading Paper in the Rear Paper Feed” on page 30](#)
- ➔ [“List of Paper Types” on page 29](#)
- ➔ [“Placing Originals on the Scanner Glass” on page 33](#)

Printing Photos Using Other Features

This section introduces the other printing features available using the control panel.

Printing

Printing in Various Layouts

You can print the photos on your memory card in various layouts such as 2-up, 4-up, and upper half.



Enter **Print Photos** from the home screen using the ◀ or ▶ button, and then press the OK button. Select **Photo Layout Sheet** using the ▲ or ▼ button, and then press the OK button. Follow the on-screen instructions to print.

Related Information

➔ [“Print Photos Mode” on page 19](#)

Printing Proof Sheets of All Photos

You can print all photos on your memory card as thumbnails.



Enter **Print Photos** from the home screen using the ◀ or ▶ button, and then press the OK button. Select **Print Proof Sheet** using the ▲ or ▼ button, and then press the OK button. Follow the on-screen instructions to print.

Related Information

➔ [“Print Photos Mode” on page 19](#)

Printing

Printing Photos from the Slide Show

You can select and print the photos on your memory card from the slide show.

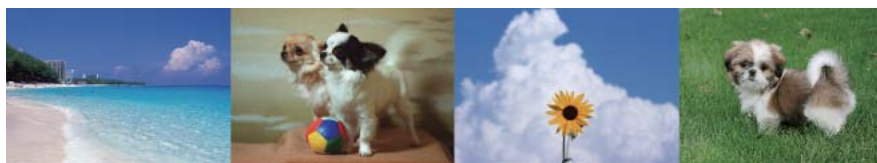

Enter **Print Photos** from the home screen using the ◀ or ▶ button, and then press the OK button. Select **Slide Show** using the ▲ or ▼ button, and then press the OK button to start a slide show. To pause the slide show, press the ▼ button, and to re-restart the slide show, press the ▼ button again. Press the OK button to print. Setting items are the same as in **Print Photos** mode.

Related Information

➔ [“Print Photos Mode” on page 19](#)

DPOF Printing

This printer is compatible with DPOF (Digital Print Order Format) Ver. 1.10. DPOF is a format that stores additional information for photos such as the date, time, user name, and printing information. DPOF-compatible cameras allow you to set which image on a memory card to print and the number of copies. When the memory card is inserted into the printer, the photos selected by the camera are printed.

Note:

For information on making print settings on your camera, see the documentation provided with your camera.

When you insert a memory card into the printer, a confirmation screen is displayed. Select **Yes** using the ▲ or ▼ button, and then press the OK button to display the print start screen. Press the ◊ button to start printing. If you want to change the print settings, press the ≡ button. Setting items are the same as in **Print Photos** mode.

Related Information

➔ [“Print Photos Mode” on page 19](#)

Printing from a Computer

Printing Basics - Windows

Note:

- ❑ See the online help for explanations of the setting items. Right-click an item, and then click **Help**.
- ❑ Operations differ depending on the application. See the application's help for details.

1. Load paper in the printer.
2. Open the file you want to print.
3. Select **Print** or **Print Setup** from the **File** menu.

Printing

4. Select your printer.
5. Select **Preferences** or **Properties** to access the printer driver window.

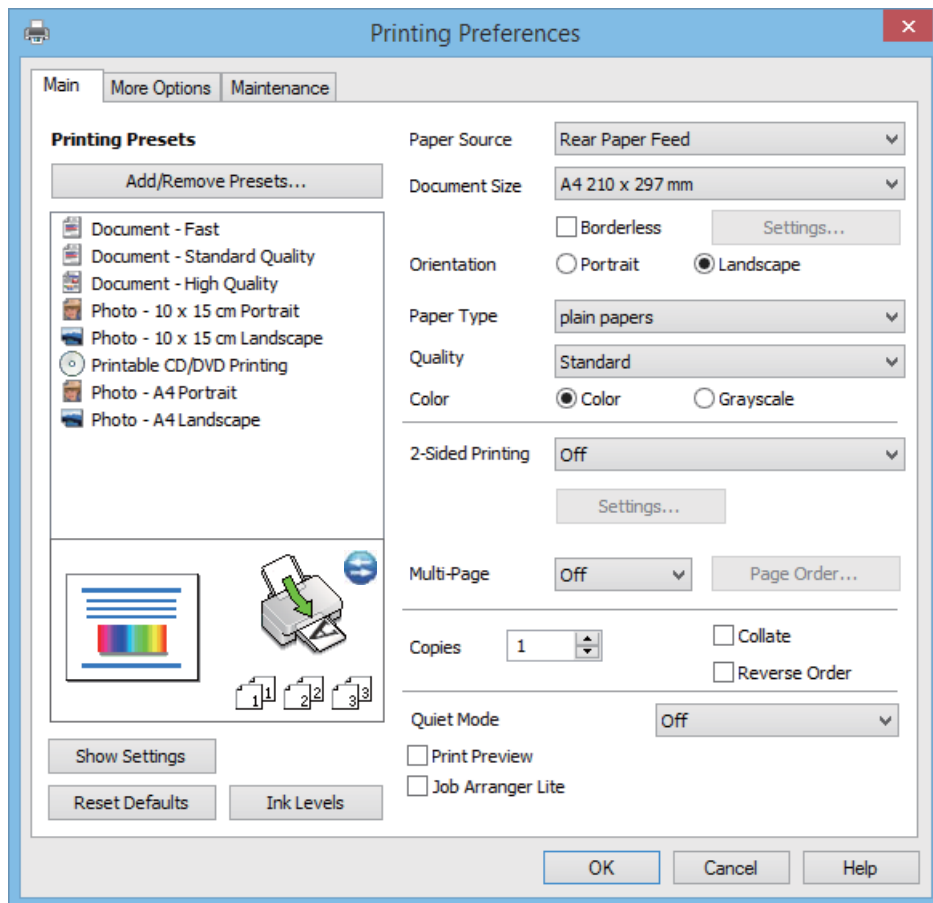

6. Make the following settings.
 - Paper Source: Select the paper source in which you loaded the paper.
If the printer has only one paper source, this item is not displayed.
 - Document Size: Select the paper size you loaded in the printer.
 - Borderless: Select to print with no margins around the image.
In borderless printing, the print data is enlarged slightly more than the paper size so that no margins are printed around the edges of the paper. Click **Settings** to select the amount of enlargement.
 - Orientation: Select the orientation you set in the application.
 - Paper Type: Select the type of paper you loaded.
 - Color: Select **Grayscale** when you want to print in black or shades of gray.

Note:
When printing on envelopes, select **Landscape** as the **Orientation** setting.
7. Click **OK** to close the printer driver window.
8. Click **Print**.

Printing

Related Information

- ➔ “Available Paper and Capacities” on page 28
- ➔ “Loading Paper in the Rear Paper Feed” on page 30
- ➔ “Guide to Windows Printer Driver” on page 89
- ➔ “List of Paper Types” on page 29

Printing Basics - Mac OS X

Note:

Operations differ depending on the application. See the application's help for details.

1. Load paper in the printer.
2. Open the file you want to print.
3. Select **Print** from the **File** menu or another command to access the print dialog.

If necessary, click **Show Details** or ▼ to expand the print window.

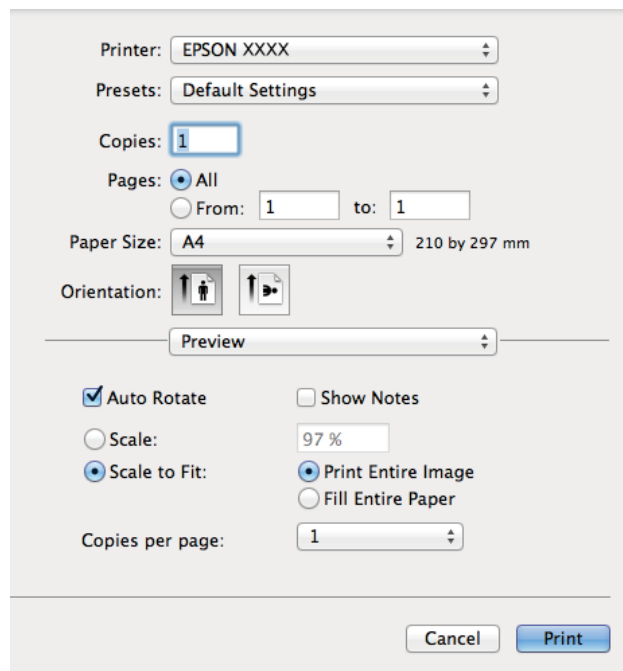

4. Make the following settings.
 - Printer: Select your printer.
 - Preset: Select when you want to use the registered settings.
 - Paper Size: Select the paper size you loaded in the printer.
When printing with no margins, select a "borderless" paper size.
 - Orientation: Select the orientation you set in the application.

Note:

When printing on envelopes, select landscape orientation.

Printing

5. Select **Print Settings** from the pop-up menu.

Note:

On Mac OS X v10.8.x or later, if the **Print Settings** menu is not displayed, the Epson printer driver has not been installed correctly.

Select **System Preferences** from the  menu > **Printers & Scanners** (or **Print & Scan**, **Print & Fax**), remove the printer, and then add the printer again. See the following to add a printer.

<http://epson.sn>

6. Make the following settings.

- Media Type: Select the type of paper you loaded.
- Expansion: Available when selecting a borderless paper size.

In borderless printing, the print data is enlarged slightly more than the paper size so that no margins are printed around the edges of the paper. Select the amount of enlargement.

- Grayscale: Select to print in black or shades of gray.

7. Click **Print**.

Related Information

- ➔ “Available Paper and Capacities” on page 28
- ➔ “Loading Paper in the Rear Paper Feed” on page 30
- ➔ “Guide to Mac OS X Printer Driver” on page 92
- ➔ “List of Paper Types” on page 29

Printing

Printing on 2-Sides (for Windows only)

The printer driver prints automatically separating even pages and odd pages. When the printer has finished printing the odd pages, flip the paper over following the instructions to print the even pages. You can also print a booklet that can be created by folding the printout.

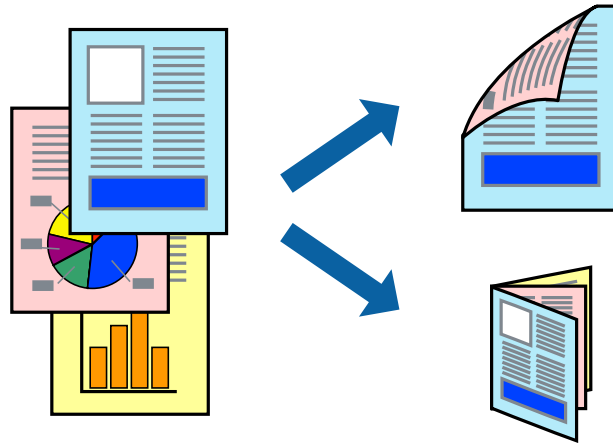

Note:

- This feature is not available for borderless printing.
- If you do not use paper that is suitable for 2-sided printing, the print quality may decline and paper jams may occur.
- Depending on the paper and the data, ink may bleed through to the other side of the paper.
- If **EPSON Status Monitor 3** is disabled, access the printer driver, click **Extended Settings** on the **Maintenance** tab, and then select **Enable EPSON Status Monitor 3**.
- 2-sided printing may not be available when the printer is accessed over a network or is used as a shared printer.

1. Load paper in the printer.
2. Open the file you want to print.
3. Access the printer driver window.
4. Select a binding method from **2-Sided Printing** on the **Main** tab.
5. Click **Settings**, make the appropriate settings, and then click **OK** to close the window.

Note:

To print as a booklet, select **Booklet**.

6. Set the other items on the **Main** and **More Options** tabs as necessary, and then click **OK**.
7. Click **Print**.

When the first side has finished printing, a pop-up window is displayed on the computer. Follow the on-screen instructions.

Related Information

- ➔ [“Available Paper and Capacities” on page 28](#)
- ➔ [“Loading Paper in the Rear Paper Feed” on page 30](#)
- ➔ [“Printing Basics - Windows” on page 46](#)

Printing

Printing Several Pages on One Sheet

You can print two or four pages of data on a single sheet of paper.

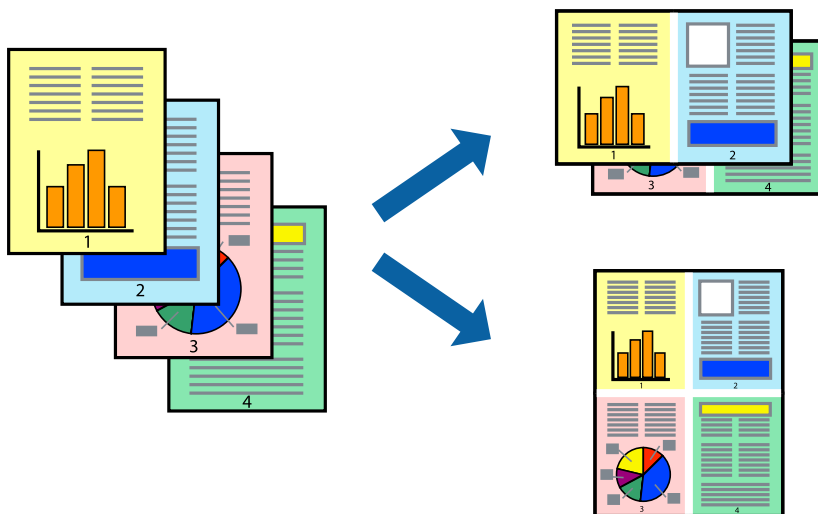

Printing Several Pages on One Sheet - Windows

Note:

This feature is not available for borderless printing.

1. Load paper in the printer.
2. Open the file you want to print.
3. Access the printer driver window.
4. Select **2-Up** or **4-Up** as the **Multi-Page** setting on the **Main** tab.
5. Click **Page Order**, make the appropriate settings, and then click **OK** to close the window.
6. Set the other items on the **Main** and **More Options** tabs as necessary, and then click **OK**.
7. Click **Print**.

Related Information

- ➔ [“Loading Paper in the Rear Paper Feed” on page 30](#)
- ➔ [“Printing Basics - Windows” on page 46](#)

Printing Several Pages on One Sheet - Mac OS X

1. Load paper in the printer.
2. Open the file you want to print.
3. Access the print dialog.
4. Select **Layout** from the pop-up menu.

Printing

5. Set the number of pages in **Pages per Sheet**, the **Layout Direction** (page order), and **Border**.
6. Set the other items as necessary.
7. Click **Print**.

Related Information

- ➔ [“Loading Paper in the Rear Paper Feed” on page 30](#)
- ➔ [“Printing Basics - Mac OS X” on page 48](#)

Printing to Fit the Paper Size

You can print to fit the paper size you loaded in the printer.



Printing to Fit the Paper Size - Windows

Note:

This feature is not available for borderless printing.

1. Load paper in the printer.
2. Open the file you want to print.
3. Access the printer driver window.
4. Make the following settings on the **More Options** tab.
 - Document Size: Select the paper size you set in the application.
 - Output Paper: Select the paper size you loaded in the printer.
Fit to Page is selected automatically.

Note:

*If you want to print a reduced image at the center of the page, select **Center**.*

5. Set the other items on the **Main** and **More Options** tabs as necessary, and then click **OK**.
6. Click **Print**.

Printing

Related Information

- ➔ “Loading Paper in the Rear Paper Feed” on page 30
- ➔ “Printing Basics - Windows” on page 46

Printing to Fit the Paper Size - Mac OS X

1. Load paper in the printer.
2. Open the file you want to print.
3. Access the print dialog.
4. Select the size of the paper you set in the application as the **Paper Size** setting.
5. Select **Paper Handling** from the pop-up menu.
6. Select **Scale to fit paper size**.
7. Select the paper size you loaded in the printer as the **Destination Paper Size** setting.
8. Set the other items as necessary.
9. Click **Print**.

Related Information

- ➔ “Loading Paper in the Rear Paper Feed” on page 30
- ➔ “Printing Basics - Mac OS X” on page 48

Printing Multiple Files Together (for Windows Only)

Job Arranger Lite allows you to combine several files created by different applications and print them as a single print job. You can specify the print settings for combined files, such as layout, print order, and orientation.

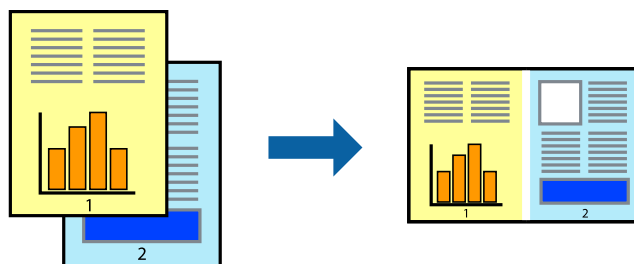

Note:

To open a **Print Project** saved in **Job Arranger Lite**, click **Job Arranger Lite** on the printer driver's **Maintenance** tab. Next, select **Open** from the **File** menu to select the file. The extension of the saved files is ".ecl".

1. Load paper in the printer.
2. Open the file you want to print.
3. Access the printer driver window.

Printing

4. Select **Job Arranger Lite** on the **Main** tab.
5. Click **OK** to close the printer driver window.
6. Click **Print**.

The **Job Arranger Lite** window is displayed and the print job is added to the **Print Project**.

7. With the **Job Arranger Lite** window opened, open the file that you want to combine with the current file, and then repeat steps 3 to 6.

Note:

*If you close the **Job Arranger Lite** window, the unsaved **Print Project** is deleted. To print later, select **Save** from the **File** menu.*

8. Select the **Layout** and **Edit** menus in **Job Arranger Lite** to edit the **Print Project** as necessary.
9. Select **Print** from the **File** menu.

Related Information

- ➔ [“Loading Paper in the Rear Paper Feed” on page 30](#)
- ➔ [“Printing Basics - Windows” on page 46](#)

Enlarged Printing and Making Posters (for Windows Only)

You can print one image on multiple sheets of paper to create a larger poster. You can print alignment marks that help you stick the sheets together.

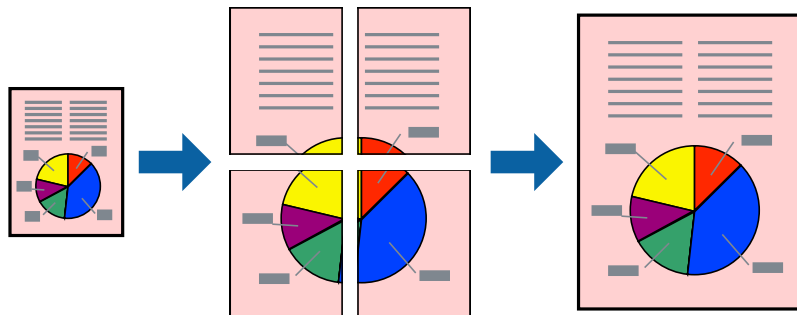

Note:

This feature is not available for borderless printing.

1. Load paper in the printer.
2. Open the file you want to print.
3. Access the printer driver window.
4. Select **2x1 Poster**, **2x2 Poster**, **3x3 Poster**, or **4x4 Poster** from **Multi-Page** on the **Main** tab.
5. Click **Settings**, make the appropriate settings, and then click **OK**.
6. Set the other items on the **Main** and **More Options** tabs as necessary, and then click **OK**.

Printing

7. Click **Print**.

Related Information

- ➔ [“Loading Paper in the Rear Paper Feed”](#) on page 30
- ➔ [“Printing Basics - Windows”](#) on page 46

Making Posters Using Overlapping Alignment Marks

Here is an example of how to make a poster when **2x2 Poster** is selected, and **Overlapping Alignment Marks** is selected in **Print Cutting Guides**.

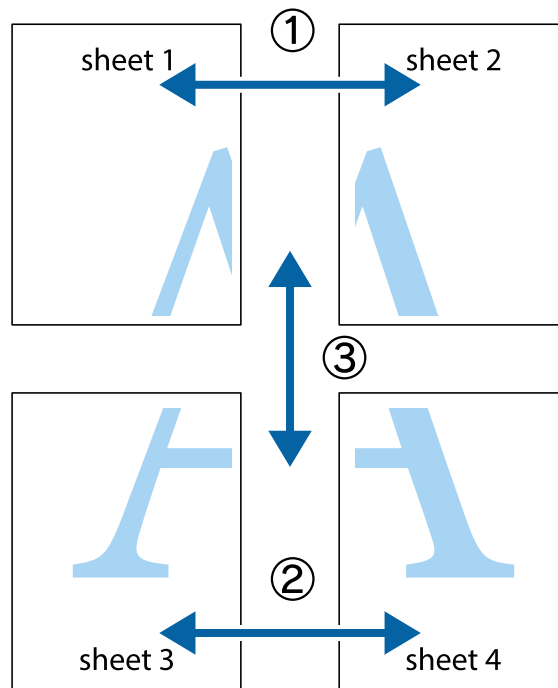

Printing

1. Prepare Sheet 1 and Sheet 2. Cut off the margins of Sheet 1 along the vertical blue line through the center of the top and bottom cross marks.

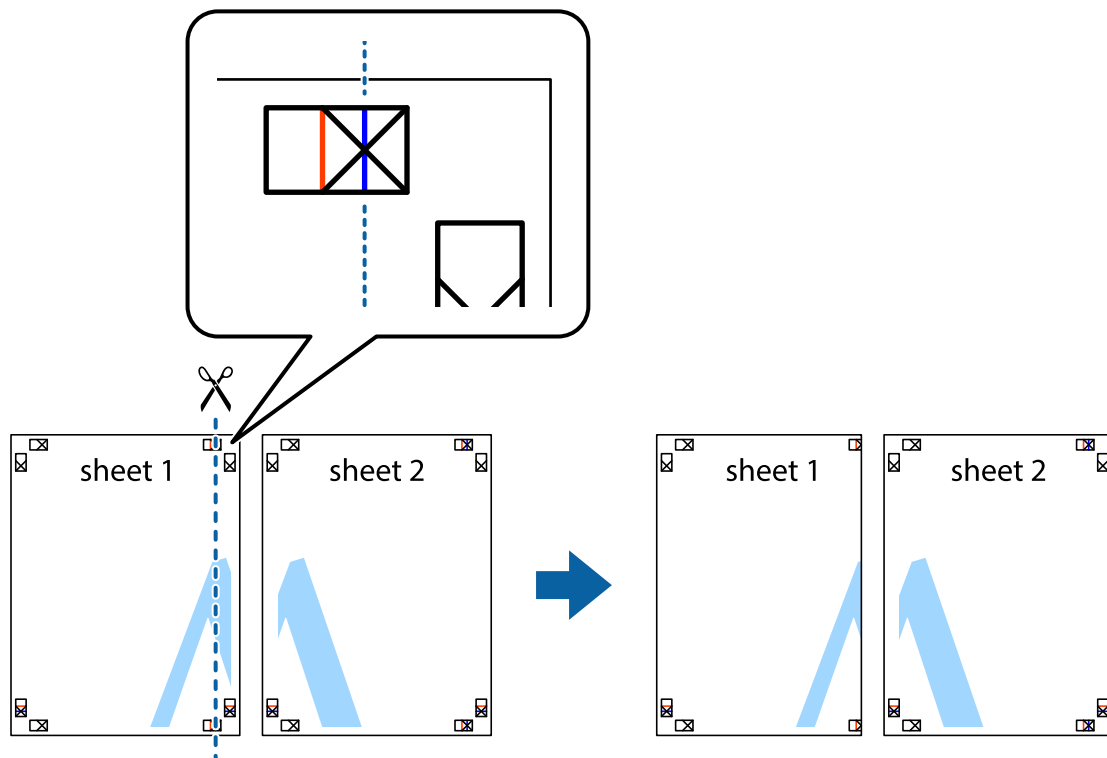

2. Place the edge of Sheet 1 on top of Sheet 2 and align the cross marks, then temporarily tape the two sheets together from the back.

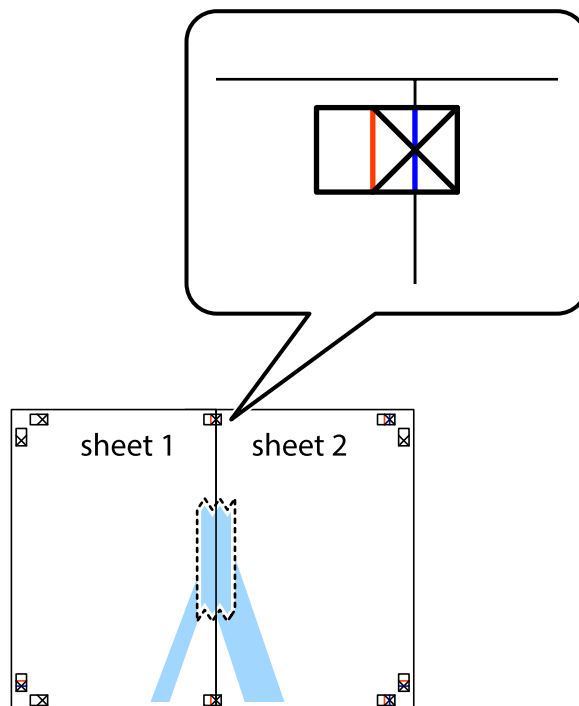

Printing

- Cut the taped sheets in two along the vertical red line through the alignment markers (this time, the line to the left of the cross marks).

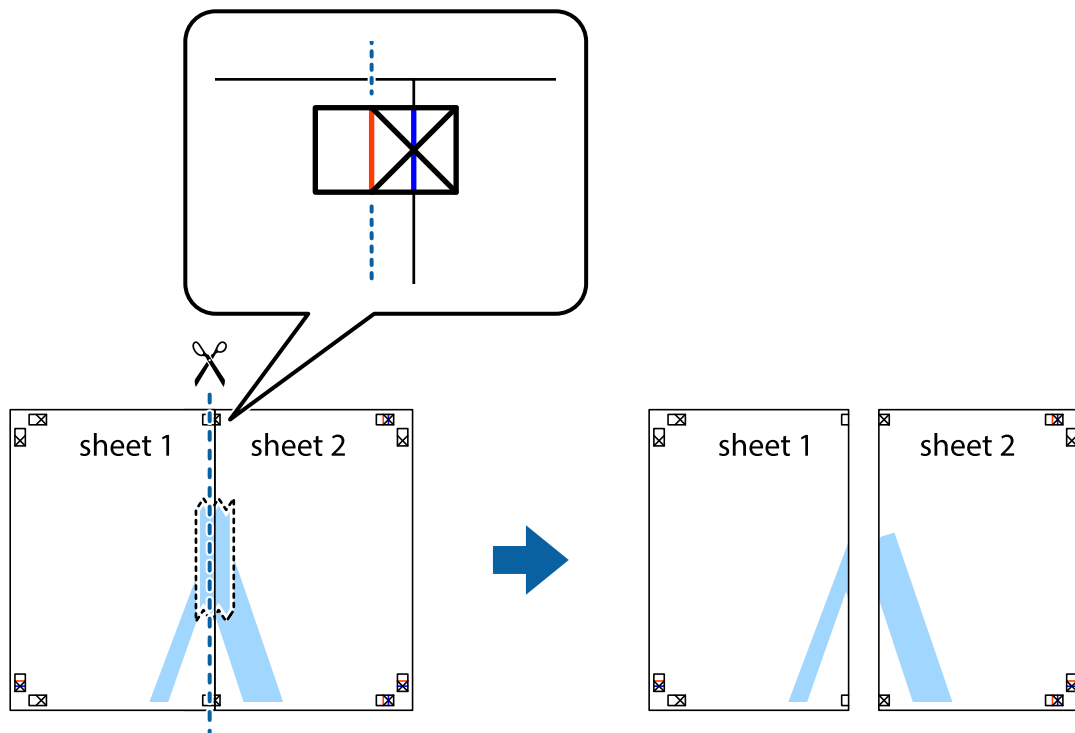

- Tape the sheets together from the back.

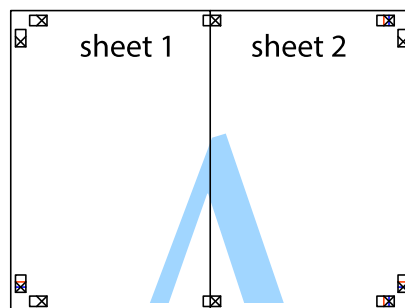

- Repeat steps 1 to 4 to tape Sheet 3 and Sheet 4 together.

Printing

6. Cut off the margins of Sheet 1 and Sheet 2 along the horizontal blue line through the center of the left and right side cross marks.

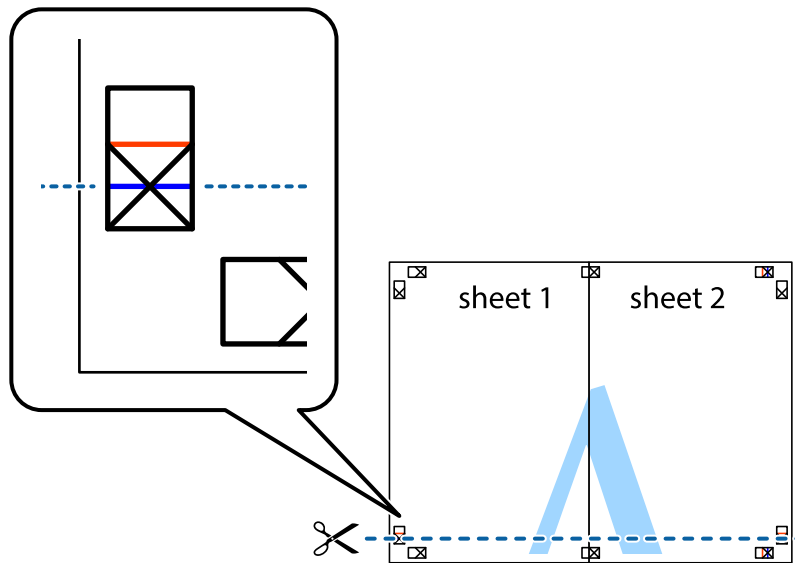

7. Place the edge of Sheet 1 and Sheet 2 on top of Sheet 3 and Sheet 4 and align the cross marks, and then temporarily tape them together from the back.

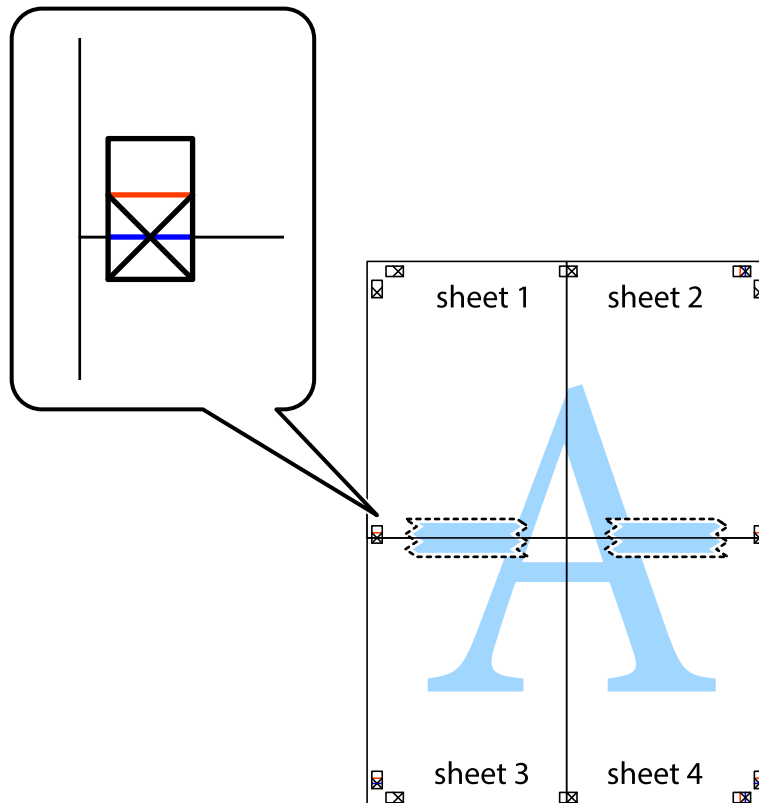

Printing

- Cut the taped sheets in two along the horizontal red line through the alignment markers (this time, the line above the cross marks).

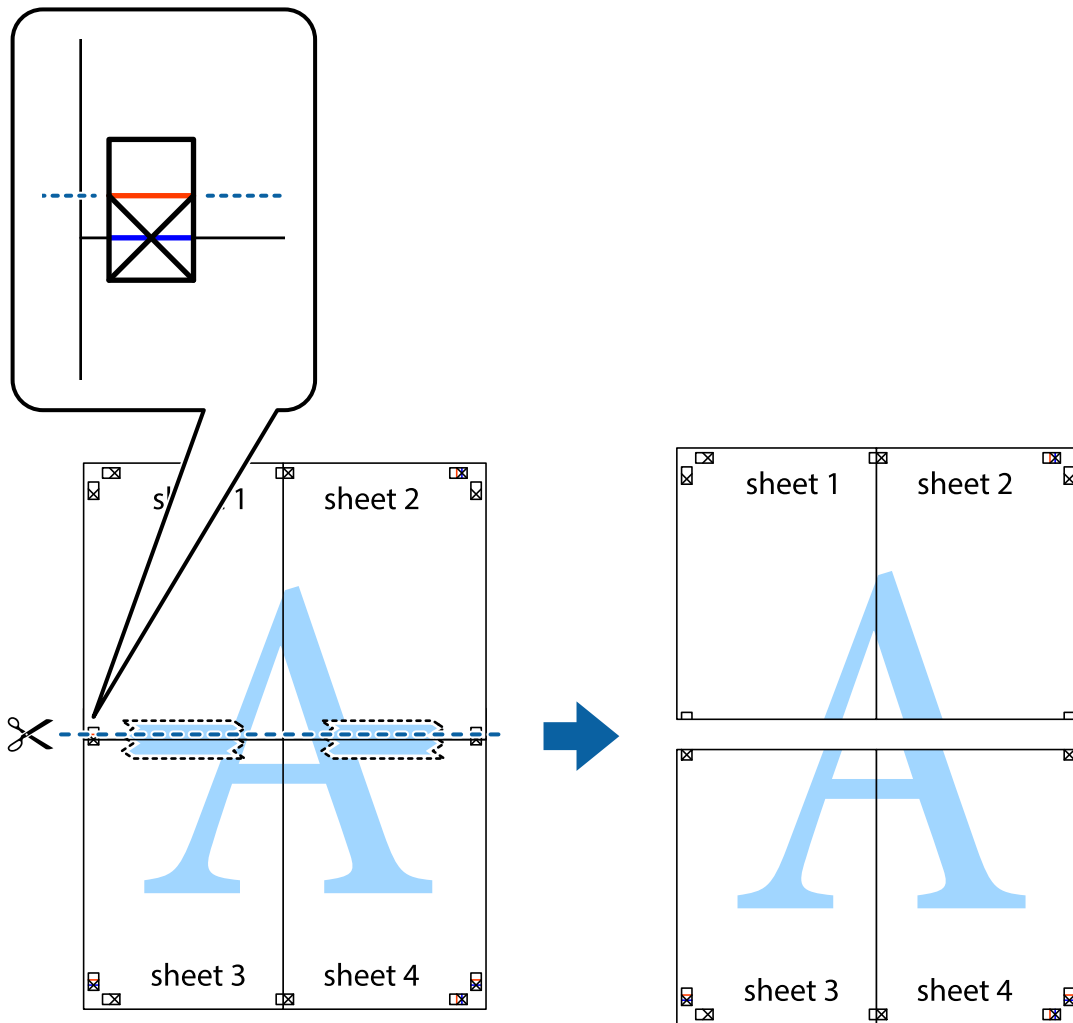

- Tape the sheets together from the back.

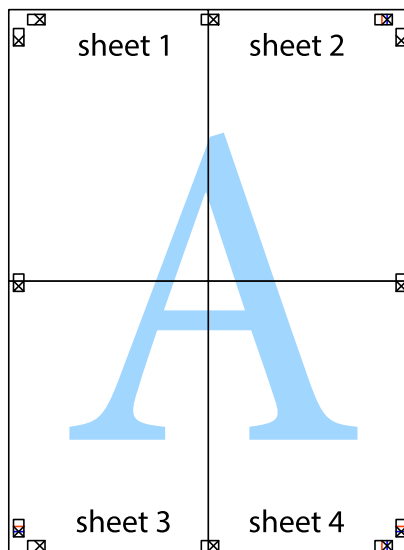

Printing

10. Cut off the remaining margins along the outer guide.

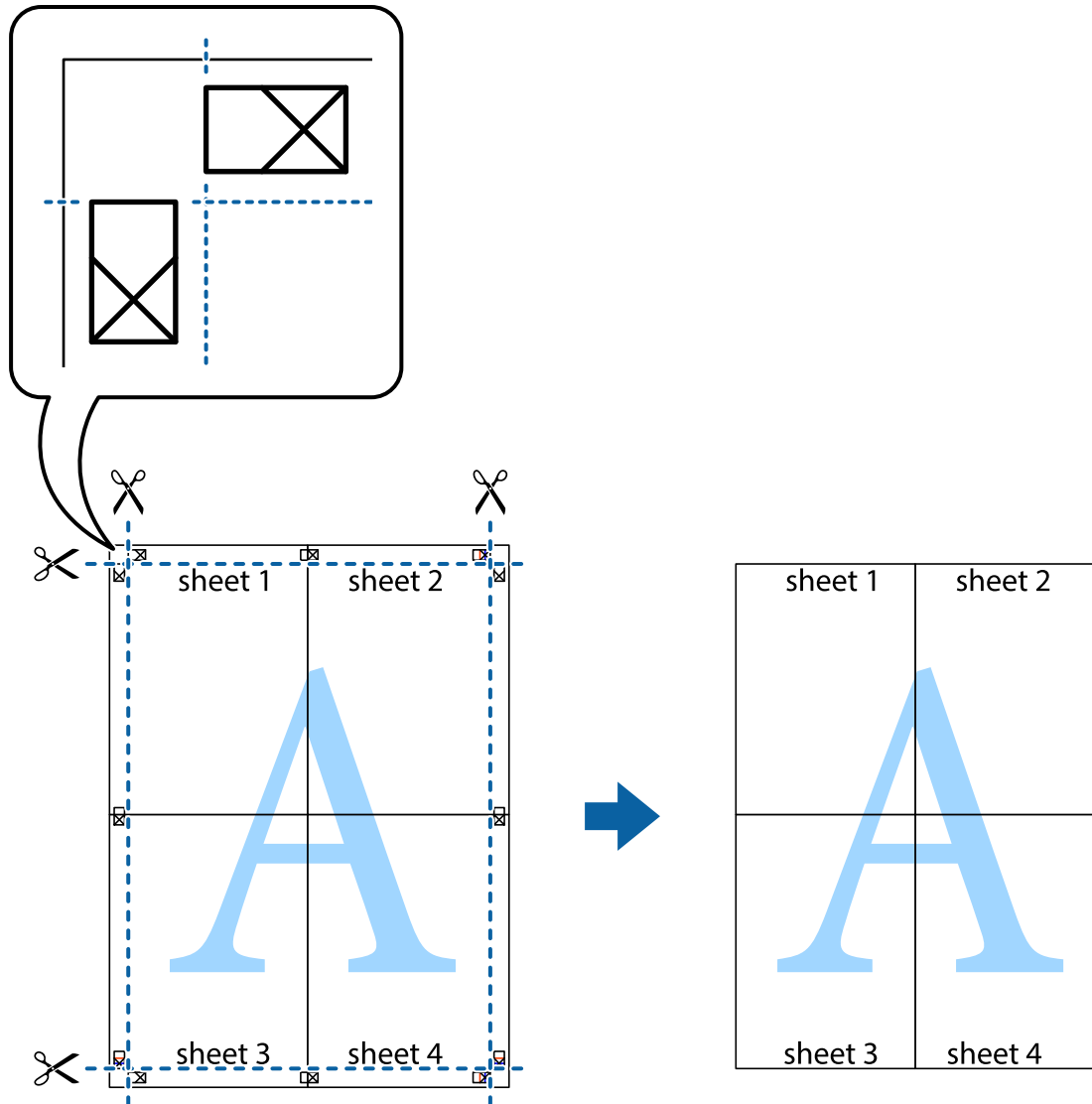

Printing Using Advanced Features

This section introduces a variety of additional layout and printing features available on the printer driver.

Related Information

- ➔ [“Windows Printer Driver” on page 88](#)
- ➔ [“Mac OS X Printer Driver” on page 91](#)

Adding a Printing Preset to Print Easily

If you create your own preset of frequently used print settings on the printer driver, you can print easily by selecting the preset from the list.

Printing

Windows

To add your own preset, set items such as the **Document Size** and **Paper Type** on the **Main** or **More Options** tab, and then click **Add/Remove Presets** in **Printing Presets**.

Note:

To delete an added preset, click **Add/Remove Presets**, select the preset name you want to delete from the list, and then delete it.

Mac OS X

Access the print dialog. To add your own preset, set items such as the **Paper Size** and **Media Type**, and then save the current settings as the preset in the **Presets** setting.

Note:

To delete an added preset, click **presets > Show Presets**, select the preset name you want to delete from the list, and then delete it.

Printing a Reduced or Enlarged Document

You can reduce or enlarge the size of a document by a specific percentage.

Windows

Note:

This feature is not available for borderless printing.

Set the **Document Size** on the **More Options** tab. Select **Reduce/Enlarge Document**, **Zoom to**, and then enter a percentage.

Mac OS X

Select **Page Setup** from the **File** menu. Select the settings for **Format For** and **Paper Size**, and then enter a percentage in **Scale**. Close the window, and then print following the basic printing instructions.

Related Information

➔ [“Printing Basics - Mac OS X” on page 48](#)

Adjusting the Print Color

You can adjust the colors used in the print job.

PhotoEnhance produces sharper images and more vivid colors by automatically adjusting the contrast, saturation, and brightness of the original image data.

Note:

- These adjustments are not applied to the original data.
- PhotoEnhance** adjusts the color by analyzing the location of the subject. Therefore, if you have changed the location of the subject by reducing, enlarging, cropping, or rotating the image, the color may change unexpectedly. Selecting the borderless setting also changes the location of the subject resulting in changes in color. If the image is out of focus, the tone may be unnatural. If the color is changed or becomes unnatural, print in a mode other than **PhotoEnhance**.

Windows

Select the method of color correction from **Color Correction** on the **More Options** tab.

Printing

If you select **Automatic**, the colors are automatically adjusted to match the paper type and print quality settings. If you select **Custom** and click **Advanced**, you can make your own settings.

Mac OS X

Access the print dialog. Select **Color Matching** from the pop-up menu, and then select **EPSON Color Controls**. Select **Color Options** from the pop-up menu, and then select one of the available options. Click the arrow next to **Advanced Settings** and make the appropriate settings.

Printing a Watermark (for Windows Only)

You can print a watermark such as "Confidential" on your printouts. You can also add your own watermark.

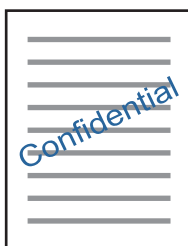

Note:

This feature is not available for borderless printing.

Click **Watermark Features** on the **More Options** tab, and then select a watermark. Click **Settings** to change details such as the color and position of the watermark.

Printing a Header and Footer (for Windows Only)

You can print information such as a user name and printing date as headers or footers.

Click **Watermark Features** in the **More Options** tab, and then select **Header/Footer**. Click **Settings** and select necessary items from the drop-down list.

Printing Photos Using Epson Easy Photo Printt

Epson Easy Photo Printt lets you lay out and print photos easily on various types of paper.

Note:

- By printing on genuine Epson photo paper, the ink quality is maximized and the printouts are vivid and clear.*
- To perform borderless printing using a commercially available application, make the following settings.*
 - Create the image data to fully fit the paper size and if a margin setting is available in the application you are using, set the margin to 0 mm.*
 - Enable the borderless printing setting in the printer driver.*

Related Information

- ➔ ["Epson Easy Photo Print" on page 95](#)
- ➔ ["Available Paper and Capacities" on page 28](#)
- ➔ ["Loading Paper in the Rear Paper Feed" on page 30](#)

Printing

Printing a CD/DVD Label with Epson Print CD

Epson Print CD lets you easily create and print an original design CD/DVD label. You can also create and print a CD/DVD jacket.

You can set the print range for the CD/DVD to a minimum of 18 mm for the inner diameter, and a maximum of 120 mm for the outer diameter. Depending on the settings, the CD/DVD or tray may be smeared. Set within the print range for the CD/DVD you want to print.

Note:

When printing a CD/DVD label using a commercially available application, make the following settings.

- For Windows, A4 is automatically selected as the **Document Size** setting when you select **CD/DVD Tray** as the **Paper Source** setting. Select **Portrait** as the **Orientation** setting, and **CD/DVD** as the **Paper Type** setting.
- For Mac OS X, select **A4 (CD/DVD)** as the **Paper Size** setting. Select **portrait** as the printing direction, and then select **CD/DVD** as the **Media Type** on the **Print Settings** menu.
- On some applications, you may need to specify the tray type. Select **Epson Tray Type 2**. The setting name may vary slightly depending on the application.

Related Information

- ➔ [“Epson Print CD” on page 95](#)
- ➔ [“CD/DVD Handling Precautions” on page 37](#)
- ➔ [“Loading a CD/DVD” on page 38](#)
- ➔ [“Printable Area” on page 115](#)

Printing from a Digital Camera

Note:

- You can print photos directly from a PictBridge-compatible digital camera. For more details on making operations on your camera, see the documentation provided with your camera.
- Usually digital camera settings are given priority; however, in the following situations, the printer settings are reflected.
 - When the camera's print setting is set to "use printer settings"
 - When the **Sepia** or **B&W** option is selected in the printer's print settings.
 - You may not be able to combine certain paper type, size, or layout settings depending on the camera settings and the printer settings. The digital camera settings may not be reflected in the output.
- When printing on a CD/DVD (only for printers that support CD/DVD printing), make the print settings on the printer before selecting photos on the digital camera, and then start printing. However, depending on your digital camera, you may not be able to print photos with DPOF settings on a CD/DVD.
- You can print photos with DPOF settings directly from a camera.

Printing from a Digital Camera Connected by USB Cable

You can print photos directly from a digital camera connected by USB cable.

1. Remove a memory card from the printer.
2. Load paper in the printer.

Printing

3. Enter **Setup** from the home screen using the ◀ or ▶ button, and then press the OK button. Select **External Device Setup** using the ▲ or ▼ button, and then press the OK button.
4. Select **Print Settings** or **Photo Adjustments**, press the OK button, and then change the settings if necessary. Select setting items using the ▲ or ▼ button, and then press the OK button. Change the settings using the ▲ or ▼ button, and then press the OK button.
5. Turn on the digital camera, and then connect to the printer using a USB cable.

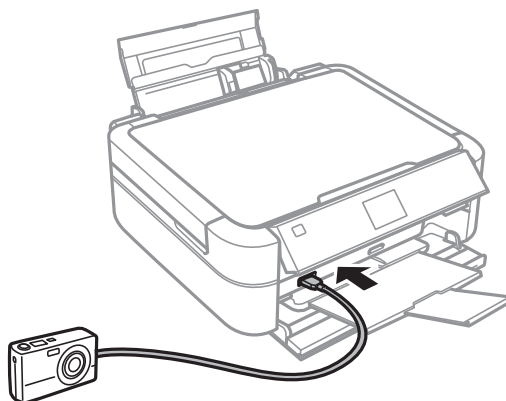

Note:

Use a USB cable that is shorter than two meters.

6. Select the photos you want to print from the digital camera, make settings such as the number of copies, and then start printing.

Related Information

➔ [“Loading Paper in the Rear Paper Feed” on page 30](#)

Canceling Printing

Note:

- ❑ In Windows, you cannot cancel a print job from the computer once it has been completely sent to the printer. In this case, cancel the print job by using the printer's control panel.
- ❑ When printing several pages from Mac OS X, you cannot cancel all of the jobs by using the control panel. In this case, cancel the print job from the computer.

Canceling Printing - Printer Button

Press the ⏏ button to cancel the print job in progress.

Canceling Printing - Windows

1. Access the printer driver window.
2. Select the **Maintenance** tab.

Printing

3. Click **Print Queue**.
4. Right-click on the job you want to cancel and then select **Cancel**.

Related Information

➔ [“Windows Printer Driver” on page 88](#)

Canceling Printing - Mac OS X

1. Click the printer icon in the **Dock**.
2. Select the job you want to cancel.
3. Cancel the job.
 - Mac OS X v10.8.x to Mac OS X v10.9.x
Click  next to the progress meter.
 - Mac OS X v10.6.x to v10.7.x
Click **Delete**.

Copying

Copying Basics

1. Load paper in the printer.
2. Place the originals.
3. Enter **Copy** from the home screen using the ◀ or ▶ button, and then press the OK button.
4. Set the number of copies using the – or + button.
5. Select color copy or monochrome copy using the ▲ or ▼ button.
6. Press the ☰ button. Select **Paper and Copy Settings** using the ▲ or ▼ button, and then press the OK button.
7. Check the settings such as the paper size and the paper type and change the settings if necessary. Select the setting items using the ▲ or ▼ button, and then press the OK button.
8. Change the settings using the ▲ or ▼ button. Press the OK button to confirm the settings. When you have finished, press the ☰ button.

Note:

If you want to copy by reducing or enlarging the size of a document by a specific percentage, select **Custom Size** as the **Reduce/Enlarge** setting, press the OK button, and then press the ▲ or ▼ button to specify a percentage. You can change the percentage in increments of 10% by holding down the ▲ or ▼ button.

9. Press the ⬡ button.

Related Information

- ➔ [“Copy Mode” on page 17](#)
- ➔ [“Loading Paper in the Rear Paper Feed” on page 30](#)
- ➔ [“Placing Originals on the Scanner Glass” on page 33](#)

Copying Photos





You can copy multiple photos at the same time. You can also restore the colors in faded photos.

Note:

- ❑ *The smallest size of original you can copy is 30 x 40 mm.*
- ❑ *White space around the photo may not be detected.*

1. Load paper in the printer.
2. Enter **Copy** from the home screen using the ◀ or ▶ button, and then press the OK button.

Copying

3. Press the  button. Select **Copy/Restore Photos** using the ▲ or ▼ button, and then press the OK button.
4. Select whether or not to restore the colors in faded photos using the ▲ or ▼ button, and then press the OK button.
5. Press the OK button to display the instructions on how to place originals, and then place the photos on the scanner glass.
6. Press the OK button.
The photos are scanned and displayed on the screen.
7. Press the  button. Select **Paper and Copy Settings** using the ▲ or ▼ button, and then press the OK button.
Note:
Press the /Ⓜ button if you want to crop a part of a photo. Use the ▲, ▼, ◀, or ▶ button to move the frame to the area you want to crop, and then press the – or + button to change the size of the frame.
8. Check the settings such as the paper size and the paper type and change the settings if necessary. Select the setting items using the ▲ or ▼ button, and then press the OK button.
9. Change the settings using the ▲ or ▼ button. Press the OK button to confirm the settings. When you have finished, press the  button.
10. Press the  button.

Related Information

- ➔ [“Copy Mode” on page 17](#)
- ➔ [“Loading Paper in the Rear Paper Feed” on page 30](#)
- ➔ [“Placing Originals on the Scanner Glass” on page 33](#)

Copying on a CD/DVD Label

You can copy a disc label or a square original such as a photo onto a CD/DVD label.

1. Enter **Copy** from the home screen using the ◀ or ▶ button, and then press the OK button.
2. Press the  button. Select **Copy to CD/DVD** using the ▲ or ▼ button, and then press the OK button.
3. Place the original following the instructions displayed on the screen, and then press the OK button.
4. Set the outer and inner diameter using the ▲, ▼, ◀, ▶ button, and then press the OK button.

Note:

You can set 114 to 120 mm as the outer diameter, and 18 to 46 mm as the inner diameter in 1 mm increments.

5. Select **Print on a CD/DVD**.

Note:

*For test printing, select **Test print on A4 paper**, and then load A4 plain paper in the sheet feeder. You can check the printout image before printing on a CD/DVD label.*

Copying

6. Press the OK button to check the instructions, load a CD/DVD, and then press the OK button.
7. Select color copy or monochrome copy using the ▲ or ▼ button.
8. If you want to change the settings such as document type or printing quality, press the ☰ button. Select **Paper and Copy Settings** using the ▲ or ▼ button, and then press the OK button.
9. Check the settings and change the settings if necessary. Select the setting items using the ▲ or ▼ button, press the OK button, and then and change the settings using the ▲ or ▼ button. Press the OK button to confirm the settings. When you have finished, press the ☰ button.
10. Press the ⬠ button.
11. When printing has finished, remove the CD/DVD tray from the printer.

Related Information

- ➔ [“Copy Mode” on page 17](#)
- ➔ [“Loading Paper in the Rear Paper Feed” on page 30](#)
- ➔ [“Placing Originals on the Scanner Glass” on page 33](#)
- ➔ [“Loading a CD/DVD for Printing” on page 37](#)

Scanning

Scanning Using the Control Panel

Scanning to a Memory Card

You can save the scanned image to a memory card.

1. Place the originals.
2. Insert a memory card into the printer.
3. Enter **Scan** from the home screen using the ◀ or ▶ button, and then press the OK button.
4. Select **Scan to Memory Card** using the ▲ or ▼ button, and then press the OK button.
5. Check settings such as the save format. To change the settings, select the setting item using the ▲ or ▼ button, and then press the OK or ▶ button to display the setting screen. Select the setting using the ▲ or ▼ button, and then press the OK button.
6. Press the ⬡ button.

Related Information

- ➔ [“Scan Mode” on page 23](#)
- ➔ [“Placing Originals on the Scanner Glass” on page 33](#)
- ➔ [“Inserting and Removing a Memory Card” on page 35](#)

Scanning to a Computer

You can save the scanned image to a computer.

**Important:**

Make sure you have installed EPSON Scan and Epson Event Manager on your computer before using this feature.

1. Place the originals.
2. Enter **Scan** from the home screen using the ◀ or ▶ button, and then press the OK button.
3. Select **Scan to PC**, **Scan to PC (PDF)**, or **Scan to PC (Email)** using the ▲ or ▼ button, and then press the OK button.

Note:

You can change to frequently-used scan settings such as the document type, folder to save, or save format by using Epson Event Manager.

4. Press the  button.

Related Information

- ➔ [“Scan Mode” on page 23](#)
- ➔ [“Placing Originals on the Scanner Glass” on page 33](#)
- ➔ [“Epson Event Manager” on page 94](#)

Scanning from a Computer

Scan using the scanner driver "EPSON Scan". See the EPSON Scan help for an explanation of each setting item.

Scanning Basics

This section uses EPSON Scan's **Home Mode** to explain the basics of scanning. The operation work flow is the same in other scanning modes.

1. Place the originals.
2. Start EPSON Scan.

Scanning

3. Select **Home Mode** from the **Mode** list.

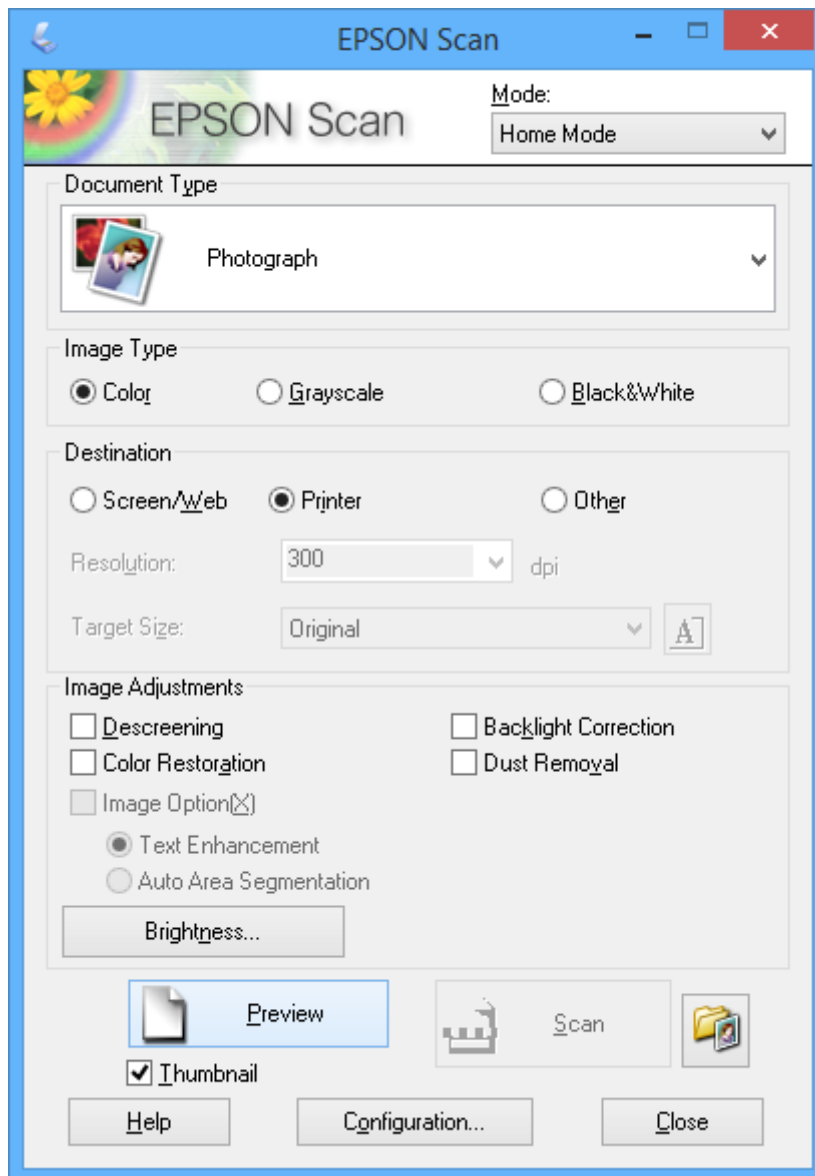

4. Make the following settings.
 - Document Type: Select the type of the original you want to scan.
 - Image Type: Select the color type of the image you want to scan.
Although this is automatically selected by the **Document Type** setting, you can change the setting.
 - Destination: Select the resolution of the image you want to scan.
If you select **Other**, you can set **Resolution**.
 - Thumbnail: Only available if you select **Photograph** as the Document Type setting.
If you select this item and click **Preview**, you can scan by automatically detecting the scan area, direction, or skew of the document, or place multiple photos on the scanner glass.

Scanning

5. Click **Preview**.

Note:

- ❑ *Depending on the photos and the scanning conditions, the scan results may not be as intended. Clear **Thumbnail**, and only place one photo.*
- ❑ *When placing multiple photos, place them at least 20 mm (0.8 inch) apart. Also, the edge area of the scanner glass is not scanned.*

6. Adjust the quality or brightness of the image as necessary.

Note:

Depending on the originals, the scan results may not be as intended.

7. Click **Scan**.

8. In the **File Save Settings** window, make appropriate settings and then click **OK**.

Note:

*When **Show this dialog box before next scan** is cleared, the **File Save Settings** screen is not displayed and scanning starts immediately. To display the **File Save Settings** screen, click the icon (**File Save Settings**) to the right of **Scan** before starting to scan.*

Related Information

- ➔ [“Placing Originals on the Scanner Glass” on page 33](#)
- ➔ [“EPSON Scan \(Scanner Driver\)” on page 94](#)

Scanning Using Advanced Features

Scanning by Detecting the Original Automatically (Full Auto Mode)

You can start scanning by simply placing the original and clicking **Scan**. Select **Full Auto Mode** from the **Mode** list in EPSON Scan.

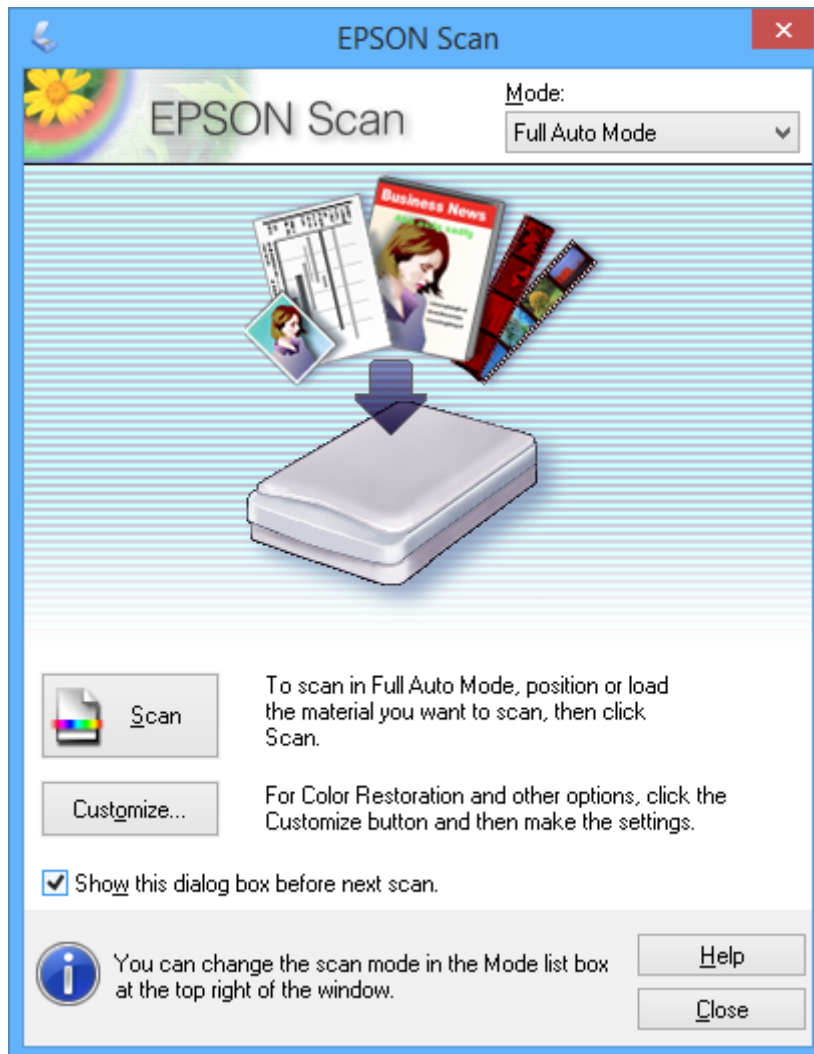

Scanning

Scanning at a Specified Size (Office Mode)

You can scan the originals at a specified size without previewing. Select **Office Mode** from the **Mode** list in EPSON Scan.

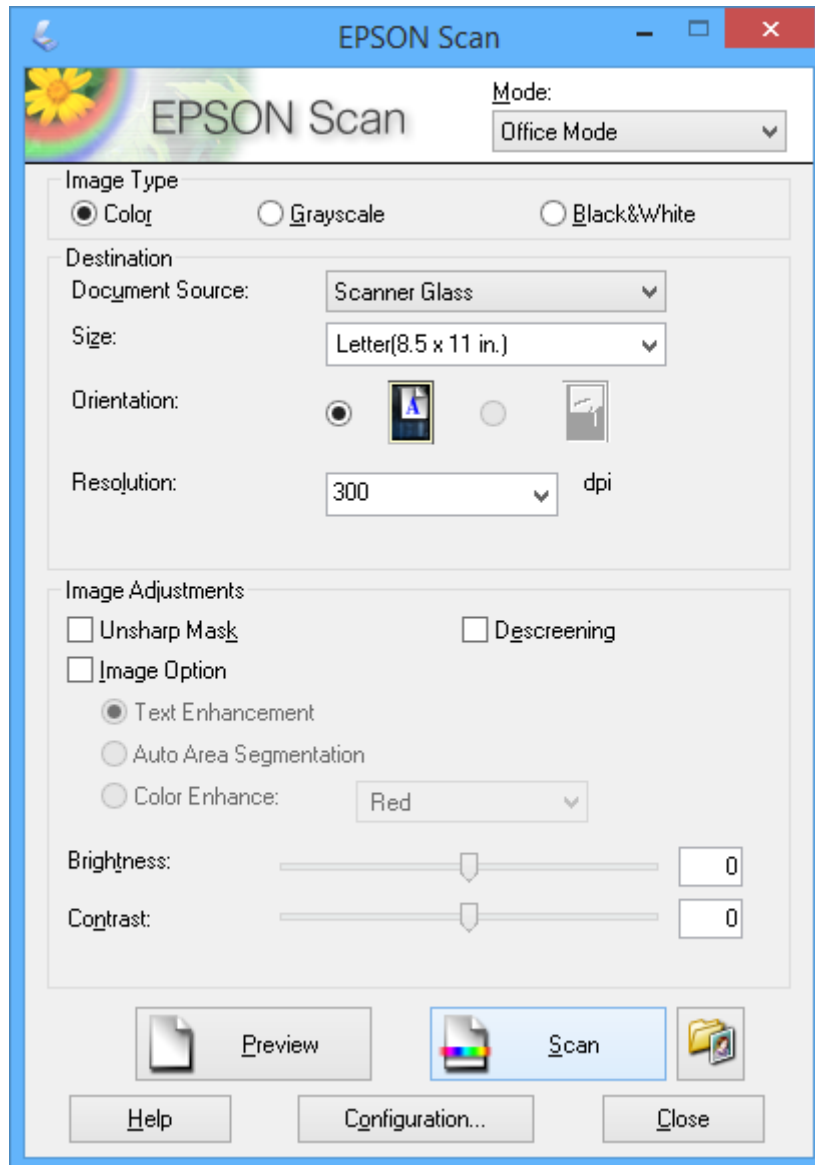

Scanning

Scanning by Adjusting the Image Quality (Professional Mode)

You can scan images while adjusting the quality and color. This mode is recommended for advanced users. Select **Professional Mode** from the **Mode** list in EPSON Scan.

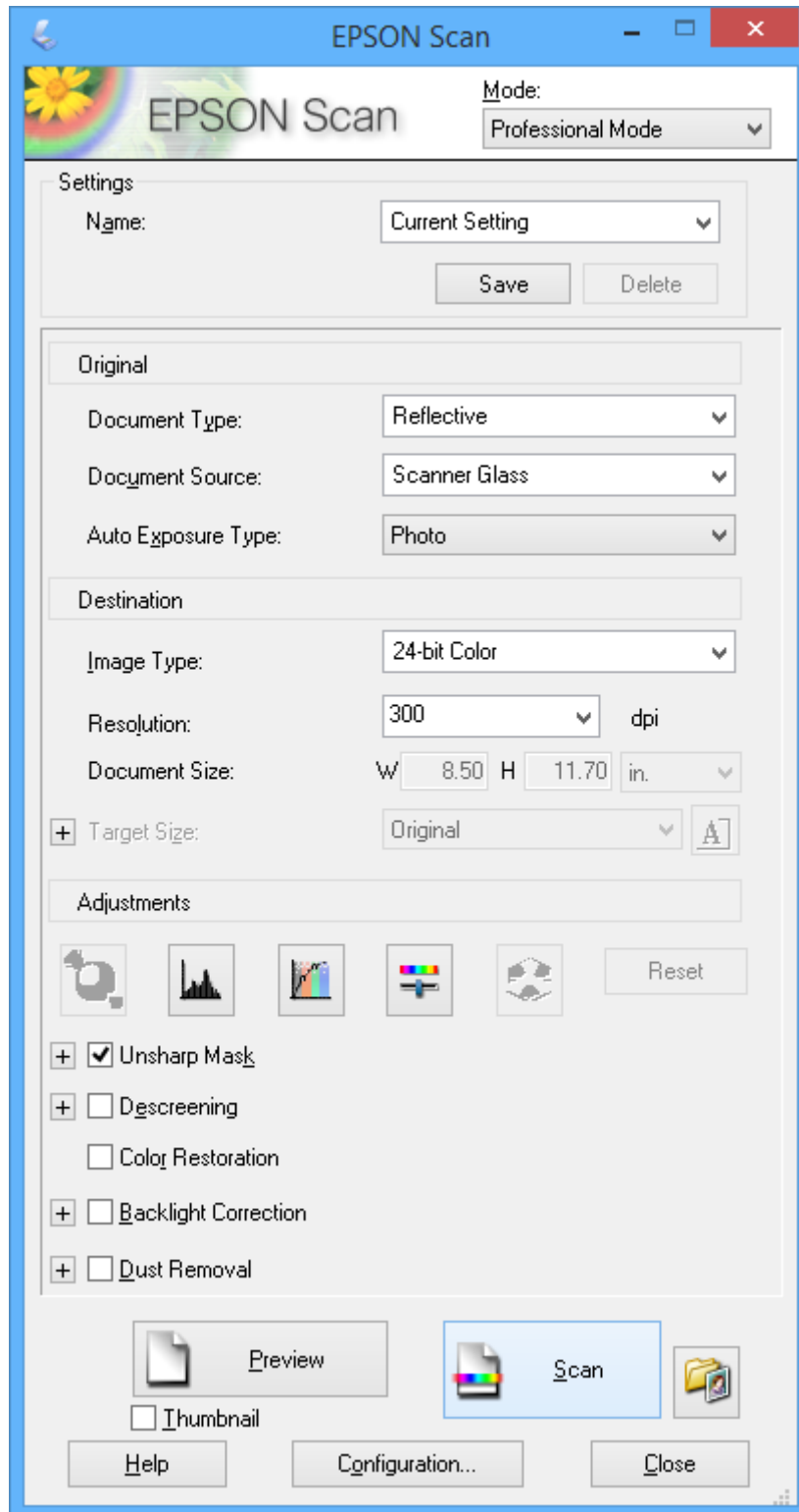

Refilling Ink

Checking the Ink Levels

To confirm the actual ink remaining, visually check the ink levels in all of the printer's tanks.

! *Important:*

If any of the ink tanks are not filled up to the lower line, fill them to the upper line on the ink tank. Continued use of the printer when the ink level is below the lower line on the tanks could damage the printer.

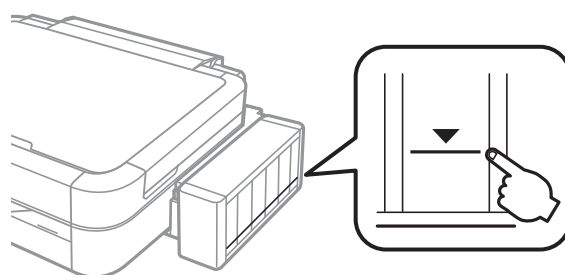

You can check the approximate ink levels from the computer.

Checking the Ink Levels - Windows

1. Access the printer driver window.
2. Click **EPSON Status Monitor 3** on the **Maintenance** tab.

Note:

*If EPSON Status Monitor 3 is disabled, click **Extended Settings** on the **Maintenance** tab, and then select **Enable EPSON Status Monitor 3**.*

Related Information

➔ [“Windows Printer Driver” on page 88](#)

Checking the Ink Levels - Mac OS X

1. Select **System Preferences** from the  menu > **Printers & Scanners** (or **Print & Scan, Print & Fax**), and then select the printer.
2. Click **Options & Supplies** > **Utility** > **Open Printer Utility**.
3. Click **EPSON Status Monitor**.

Ink Bottle Codes

Epson recommends the use of genuine Epson ink bottles. Epson cannot guarantee the quality or reliability of non-genuine ink. The use of non-genuine ink may cause damage that is not covered by Epson's warranties, and under certain circumstances, may cause erratic printer behavior.

Other products not manufactured by Epson may cause damage that is not covered by Epson's warranties, and under certain circumstances, may cause erratic printer behavior.

The following are the codes for genuine Epson ink bottles.

| BK (Black) | C (Cyan) | M (Magenta) | Y (Yellow) | LC (Light Cyan) | LM (Light Magenta) |
|------------|----------|-------------|------------|-----------------|--------------------|
| T6731 | T6732 | T6733 | T6734 | T6735 | T6736 |



Important:

Use of genuine Epson ink other than specified could cause damage that is not covered by Epson's warranties.

Note:

For European users, visit the following website for information on Epson's ink bottle yields.

<http://www.epson.eu/pageyield>

Ink Bottle Handling Precautions

Read the following instructions before refilling ink.

Handling precautions

- Use ink bottles with the correct part code for this printer.
- This printer requires careful handling of ink. Ink may splatter when the ink tanks are filled or refilled with ink. If ink gets on your clothes or belongings, it may not come off.
- Store ink bottles at normal room temperature and keep them away from direct sunlight.
- Epson recommends using the ink bottle before the date printed on the package.
- Store the ink bottles in the same environment as the printer.
- When storing or transporting an ink bottle after removing its seal, do not tilt the bottle and do not subject it to impacts or temperature changes. Otherwise, ink may leak even if the cap on the ink bottle is tightened securely. Be sure to keep the ink bottle upright when tightening the cap, and take measures to prevent ink from leaking when you transport the bottle.
- After bringing an ink bottle inside from a cold storage site, allow it to warm up at room temperature for at least three hours before using it.
- Do not open the ink bottle package until you are ready to fill the ink tank. The ink bottle is vacuum packed to maintain its reliability. If you leave an ink bottle unpacked for a long time before using it, normal printing may not be possible.
- Do not continue printing when the ink level is below the lower line on the ink tank. Continued use of the printer when the ink level is below the lower line could damage the printer. Epson recommends filling all ink tanks to the upper line when the printer is not operating to reset the ink levels.

Refilling Ink

- ❑ To ensure you receive premium print quality and to help protect your print head, a variable ink safety reserve remains in the ink tank when your printer indicates to refill ink. The yields quoted for you do not include this reserve.
- ❑ Although the ink bottles may contain recycled materials, this does not affect printer function or performance.
- ❑ Specifications and appearance of the ink bottle are subject to change without prior notice for improvement.
- ❑ Quoted yields may vary depending on the images that you are printing, the paper type that you are using, the frequency of your prints and environmental conditions such as temperature.

Ink consumption

- ❑ To maintain optimum print head performance, some ink is consumed from all ink tanks not only during printing but also during maintenance operation such as print head cleaning.
- ❑ When printing in monochrome or grayscale, color inks instead of black ink may be used depending on the paper type or print quality settings. This is because a mixture of color inks is used to create black.
- ❑ The ink in the ink bottles supplied with your printer is partly used during initial setup. In order to produce high quality printouts, the print head in your printer will be fully charged with ink. This one-off process consumes a quantity of ink and therefore these bottles may print fewer pages compared to subsequent ink bottles.

Refilling the Ink Tanks

1. Enter **Setup** from the home screen using the ◀ or ▶ button, and then press the OK button.
2. Select **Maintenance** using the ▲ or ▼ button, and then press the OK button.
3. Select **Reset Ink Levels** using the ▲ or ▼ button, and then press the OK button.
4. Press the ◊ button.
5. Unhook the ink tank unit from the printer and lay it down.

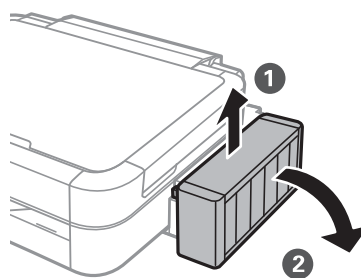
**Important:**

Do not pull the tubes.

Refilling Ink

6. Open the ink tank unit cover, and then remove the cap of the ink tank.

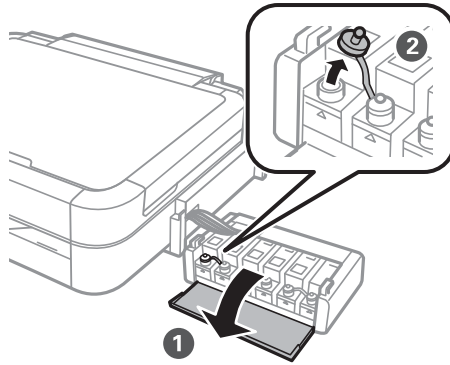

! *Important:*

- Be careful not to spill any ink.*
- Make sure that the color of the ink tank matches the ink color that you want to refill.*

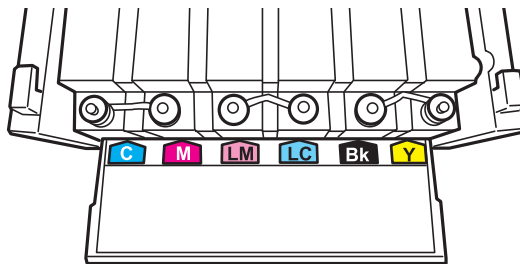

7. Snap off the top of the cap, remove the cap of the ink bottle, remove the seal from the bottle, and then install the cap.

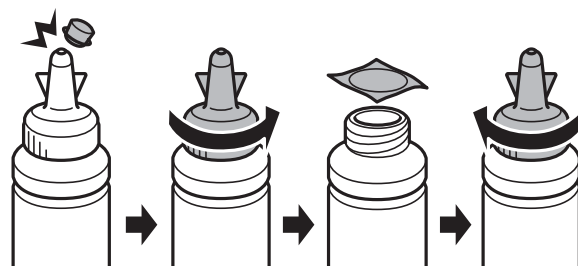

Refilling Ink

! *Important:*

Close the ink bottle cap tightly; otherwise ink may leak.

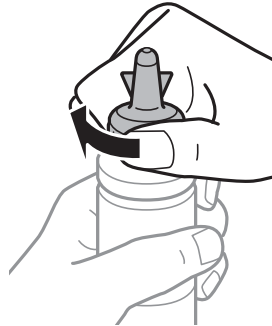

Note:

Do not dispose of the top of the cap. If any ink remains in the ink bottle after refilling the tank, use the top of the cap to seal the ink bottle cap.

8. Refill the ink tank with the correct colored ink up to the upper line on the ink tank.

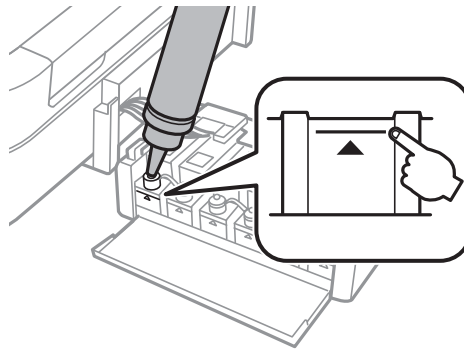

Note:

If any ink remains in the ink bottle after filling the ink tank up to the upper line, install the cap securely and store the ink bottle upright for later use.

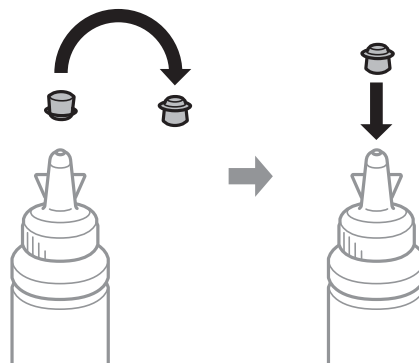

Refilling Ink

9. Close the cap onto the ink tank securely.

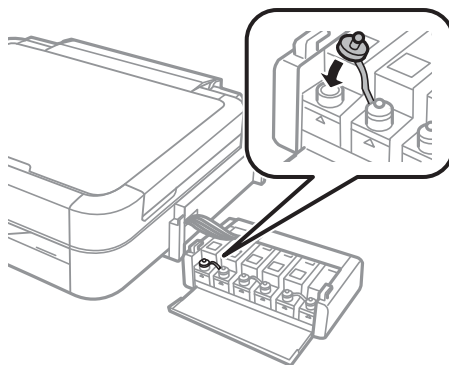

10. Close the ink tank unit cover.

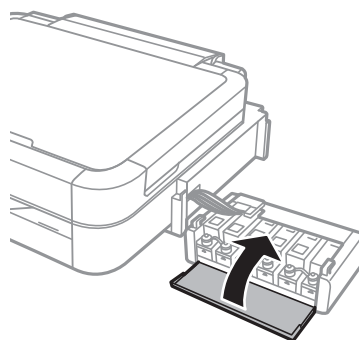

11. Hook the ink tank unit onto the printer.

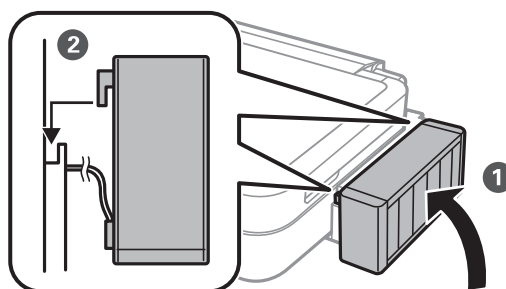

12. Press the OK button.
13. Check the color that you refilled to the upper line, and then select it and follow the instructions on the LCD screen to reset the ink levels.

Note:

You can reset the ink levels even if you did not fill the ink to the upper line. However, this printer cannot generate notifications and stop operations before ink levels drop below the lower line.

Related Information

- ➔ [“Ink Bottle Codes” on page 77](#)
- ➔ [“Ink Bottle Handling Precautions” on page 77](#)

Improving Print and Scan Quality

Checking and Cleaning the Print Head

If the nozzles are clogged, the printouts become faint, there is visible banding, or unexpected colors appear. When print quality has declined, use the nozzle check feature and check if the nozzles are clogged. If the nozzles are clogged, clean the print head.

! **Important:**

Do not open the scanner unit or turn off the printer during head cleaning. If the head cleaning is incomplete, you may not be able to print.

Note:

- Because print head cleaning uses some ink, clean the print head only if quality declines.
- When ink is low, you may not be able to clean the print head. Prepare a new ink bottle.
- If print quality has not improved after repeating nozzle check and head cleaning three times, wait for at least 12 hours without printing, and then run the nozzle check again and repeat the head cleaning if necessary. If the printer operates printing while waiting, extend the waiting time. We recommend to turn off the printer. If print quality has still not improved, contact Epson support.
- To prevent the print head from drying out, always turn the printer off by pressing the  button.
- To keep the print head operating at its best, we recommend printing a few pages on a regular basis.

Checking and Cleaning the Print Head - Control Panel

1. Make sure that the CD/DVD tray is not inserted in the printer, and that the tray lever is in the up position.
2. Load A4-size plain paper in the printer.
3. Enter **Setup** from the home screen using the ◀ or ▶ button, and then press the OK button.
4. Select **Maintenance** using the ▲ or ▼ button, and then press the OK button.
5. Select **Nozzle Check** using the ▲ or ▼ button, and then press the OK button.
6. Follow the on-screen instructions to print the nozzle check pattern.
7. Compare the printed check pattern with the sample shown below.
 - All lines are printed: The print head nozzles are not clogged. Select **Finish Nozzle Check** using the ▲ or ▼ button, and then press the OK button.

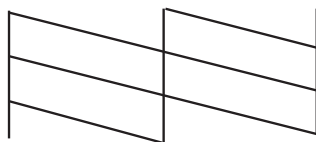

Improving Print and Scan Quality

- ❑ There are broken lines or missing segments: The print head nozzles may be clogged. Go to the next step.

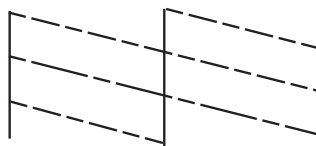

Note:

The test pattern may vary by model.

8. Select **Head Cleaning** using the ▲ or ▼ button, and then press the OK button.
9. Follow the on-screen instructions to clean the print head.
10. When cleaning is finished, select **Nozzle Check** using the ▲ or ▼ button, and then follow the on-screen instructions to print the nozzle check pattern again. Repeat cleaning and printing the pattern until all lines are printed completely.

Related Information

- ➔ [“Loading Paper in the Rear Paper Feed” on page 30](#)

Checking and Cleaning the Print Head - Windows

1. Make sure that the CD/DVD tray is not inserted in the printer, and that the tray lever is in the up position.
2. Load A4-size plain paper in the printer.
3. Access the printer driver window.
4. Click **Nozzle Check** on the **Maintenance** tab.
5. Follow the on-screen instructions.

Related Information

- ➔ [“Loading Paper in the Rear Paper Feed” on page 30](#)
- ➔ [“Windows Printer Driver” on page 88](#)

Checking and Cleaning the Print Head - Mac OS X

1. Make sure that the CD/DVD tray is not inserted in the printer, and that the tray lever is in the up position.
2. Load A4-size plain paper in the printer.
3. Select **System Preferences** from the  menu > **Printers & Scanners** (or **Print & Scan**, **Print & Fax**), and then select the printer.
4. Click **Options & Supplies** > **Utility** > **Open Printer Utility**.

Improving Print and Scan Quality

5. Click **Nozzle Check**.
6. Follow the on-screen instructions.

Related Information

➔ [“Loading Paper in the Rear Paper Feed” on page 30](#)

Replacing Ink inside the Ink Tubes

If you have not used the printer for a long time and notice banding or missing colors in the printouts, you may need to replace the ink inside the ink tubes to solve the problem. The **Power Ink Flushing** utility allows you to replace all of the ink inside the ink tubes.

Important:

This feature consumes a lot of ink. Before using this feature, make sure there is enough ink in the printer's ink tanks. If there is not enough ink, refill the ink tanks.

Caution:

- ❑ *This feature effects the service life of the ink pad. Ink pad reaches its capacity earlier by running this feature. Contact Epson or an authorised Epson service provider to request replacement before the end of its service life. It is not a user-serviceable part.*
- ❑ *After using the Power Ink Flushing utility, turn the printer off and wait for at least 12 hours. Using this feature improves the print quality after 12 hours, however it cannot be used again within 12 hours of the last use. If you still cannot solve the problem after trying all of the methods above, contact Epson support.*

Replacing Ink inside the Ink Tubes - Windows

1. Make sure that the CD/DVD tray is not inserted in the printer, and that the tray lever is in the up position.
2. Access the printer driver window.
3. Click **Power Ink Flushing** on the **Maintenance** tab.
4. Follow the on-screen instructions.

Related Information

➔ [“Windows Printer Driver” on page 88](#)

Replacing Ink inside the Ink Tubes - Mac OS X

1. Make sure that the CD/DVD tray is not inserted in the printer, and that the tray lever is in the up position.
2. Select **System Preferences** from the  menu > **Printers & Scanners** (or **Print & Scan, Print & Fax**), and then select the printer.
3. Click **Options & Supplies** > **Utility** > **Open Printer Utility**.

Improving Print and Scan Quality

4. Click **Power Ink Flushing**.
5. Follow the on-screen instructions.

Aligning the Print Head

If you notice a misalignment of vertical lines or blurred images, align the print head.

Aligning the Print Head - Control Panel

1. Make sure that the CD/DVD tray is not inserted in the printer, and that the tray lever is in the up position.
2. Load A4-size plain paper in the printer.
3. Enter **Setup** from the home screen using the ◀ or ▶ button, and then press the OK button.
4. Select **Maintenance** using the ▲ or ▼ button, and then press the OK button.
5. Select **Head Alignment** using the ▲ or ▼ button, and then press the OK button.
6. Follow the on-screen instructions to print the alignment pattern.
7. Follow the on-screen instructions to align the print head. Find and select the number for the most solid pattern in each group using the ▲ or ▼ button, and then press the OK button.

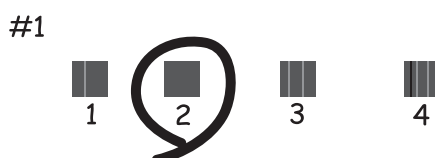

Note:

- ❑ The test pattern may vary by model.
- ❑ If print quality is not improved, align the print head from a computer.

Related Information

- ➔ [“Loading Paper in the Rear Paper Feed” on page 30](#)

Aligning the Print Head - Windows

1. Make sure that the CD/DVD tray is not inserted in the printer, and that the tray lever is in the up position.
2. Load A4-size plain paper in the printer.

Improving Print and Scan Quality

3. Access the printer driver window.
4. Click **Print Head Alignment** on the **Maintenance** tab.
5. Follow the on-screen instructions.

Related Information

➔ [“Loading Paper in the Rear Paper Feed” on page 30](#)

Aligning the Print Head - Mac OS X

1. Make sure that the CD/DVD tray is not inserted in the printer, and that the tray lever is in the up position.
2. Load A4-size plain paper in the printer.
3. Select **System Preferences** from the  menu > **Printers & Scanners** (or **Print & Scan**, **Print & Fax**), and then select the printer.
4. Click **Options & Supplies** > **Utility** > **Open Printer Utility**.
5. Click **Print Head Alignment**.
6. Follow the on-screen instructions.

Related Information

➔ [“Loading Paper in the Rear Paper Feed” on page 30](#)

Cleaning the Paper Path

When the printouts are smeared or scuffed or paper does not feed correctly, clean the roller inside.

**Important:**

Do not use tissue paper to clean the inside of the printer. The print head nozzles may be clogged with lint.

1. Make sure that the CD/DVD tray is not inserted in the printer, and that the tray lever is in the up position.
2. Make sure there is no dust or stains on the scanner glass and the document cover.
3. Load paper for cleaning in the printer.
 - Load A4-size plain paper to clear a smearing or scuffing problem.
 - Load the cleaning sheet that came with Epson paper to clear a paper feeding problem. If you do not have the cleaning sheet, use plain paper instead.

Improving Print and Scan Quality

4. Start copying without placing the original.

Note:

- Repeat this procedure until the paper is not smeared with ink.
- To clear a paper feeding problem, repeat this procedure two or three times.
- The cleaning sheet loses effect when used three times or more.

Related Information

- ➔ [“Loading Paper in the Rear Paper Feed” on page 30](#)
- ➔ [“Copying Basics” on page 66](#)

Cleaning the Scanner Glass

When the copies or scanned images are smeared or scuffed, clean the scanner glass.



Important:

Never use alcohol or thinner to clean the printer. These chemicals can damage the printer.

1. Open the document cover.

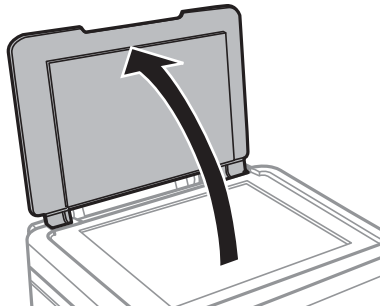

2. Use a soft, dry, clean cloth to clean the surface of the scanner glass.

Note:

- If the glass surface is stained with grease or some other hard-to-remove material, use a small amount of glass cleaner and a soft cloth to remove it. Wipe off all remaining liquid.
- Do not press the glass surface too hard.
- Be careful not to scratch or damage the surface of the glass. A damaged glass surface can decrease the scan quality.

Application Information

Necessary Applications

Windows Printer Driver

The printer driver is an application that controls the printer according to the print commands from other applications. Making settings on the printer driver provides the best printing results. You can also check the status of the printer or keep it in top operating condition using the printer driver utility.

Note:

*You can change the language of the printer driver. Select the language you want to use from the **Language** setting on the **Maintenance** tab.*

Accessing the printer driver from applications

To make settings that apply only to the application you are using, access from that application.

Select **Print** or **Print Setup** from the **File** menu. Select your printer, and then click **Preferences** or **Properties**.

Note:

Operations differ depending on the application. See the application's help for details.

Accessing the printer driver from the control panel

To make settings that apply to all of the applications, access from the control panel.

Windows 8.1/Windows 8

Select **Desktop > Settings > Control Panel > View devices and printers** in **Hardware and Sound**. Right-click on your printer, or press and hold it and then select **Printing preferences**.

Windows 7

Click the start button, and select **Control Panel > View devices and printers** in **Hardware and Sound**. Right-click on your printer and select **Printing preferences**.

Windows Vista

Click the start button, and select **Control Panel > Printers** in **Hardware and Sound**. Right-click on your printer and select **Printing preferences**.

Windows XP

Click the start button, and select **Control Panel > Printers and Other Hardware > Printers and Faxes**. Right-click on your printer and select **Printing preferences**.

Accessing the printer driver from the printer icon on the task bar (Windows)

The printer icon on the desktop task bar is a shortcut icon allowing you to quickly access the printer driver.

If you click the printer icon and select **Printer Settings**, you can access the same printer settings window as the one displayed from the control panel. If you double-click this icon, you can check the status of the printer.

Note:

*If the printer icon is not displayed on the task bar, access the printer driver window, click **Monitoring Preferences** on the **Maintenance** tab, and then select **Register the shortcut icon to the taskbar**.*

Application Information

Guide to Windows Printer Driver

Help is available in the printer driver for Windows. To view explanations of the setting items, right-click on each item, and then click **Help**.

Main Tab

You can make basic settings for printing, such as paper type or paper size.

You can also make settings for printing both sides of the paper or printing multiple pages on one sheet.

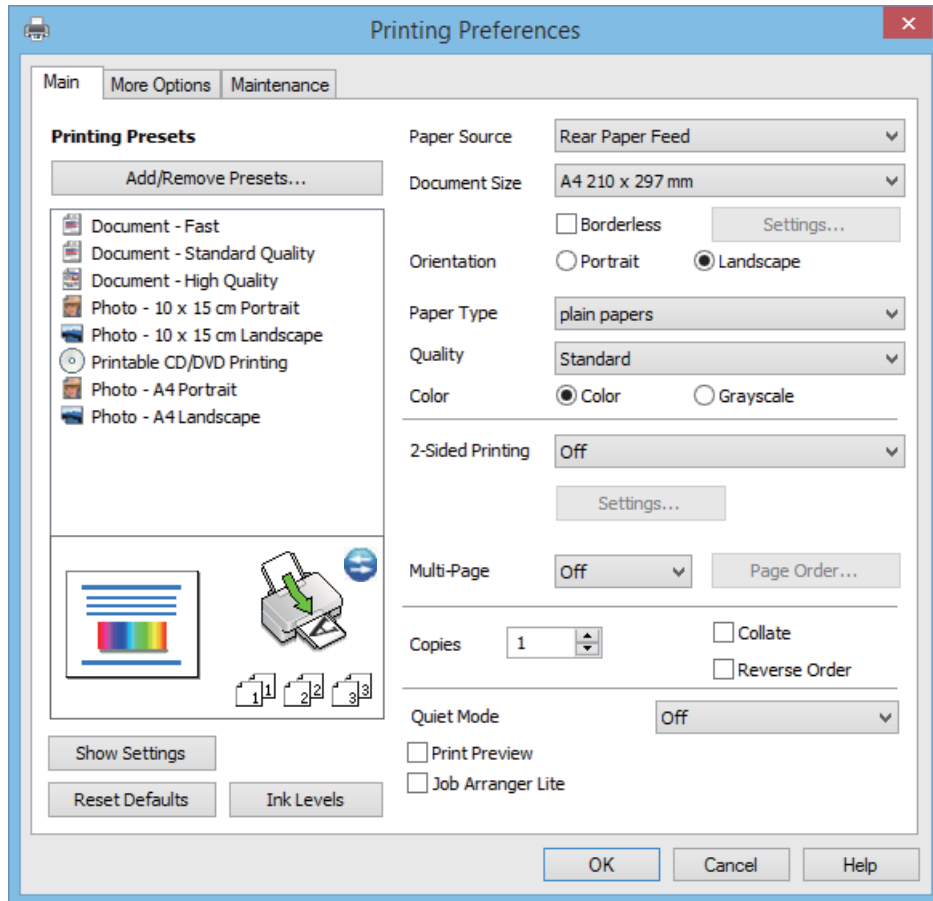

Application Information

More Options Tab

You can select additional layout and printing options such as changing the size of a printout or making color corrections.

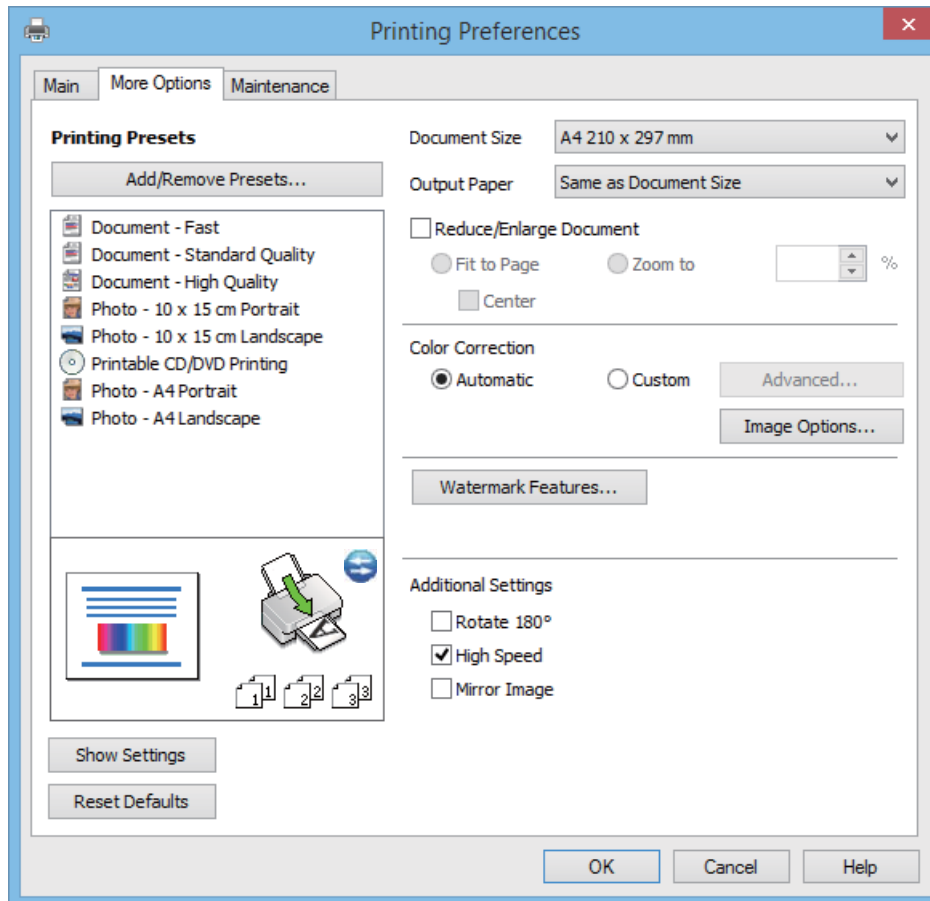

Application Information

Maintenance Tab

You can check the approximate ink levels and error information, and also maintain your printer, such as nozzle check or print head cleaning.

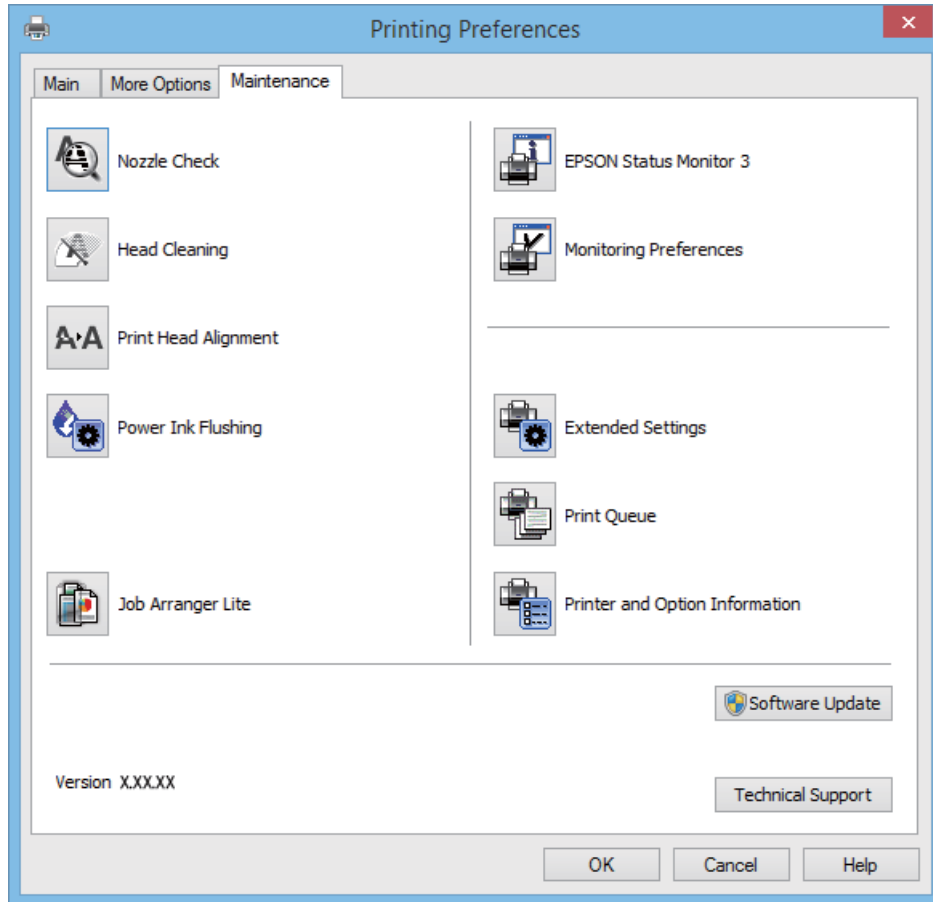

Making Operation Settings for the Windows Printer Driver

You can make settings such as enabling **EPSON Status Monitor 3**.

1. Access the printer driver window.
2. Click **Extended Settings** on the **Maintenance** tab.
3. Make the appropriate settings, and then click **OK**.
See the online help for explanations of the setting items.

Related Information

➔ [“Windows Printer Driver” on page 88](#)

Mac OS X Printer Driver

The printer driver is an application that controls the printer according to the print commands from other applications. Making settings on the printer driver provides the best printing results. You can also check the status of the printer or keep it in top operating condition using the printer driver utility.

Application Information

Accessing the printer driver from applications

Select **Print** from the **File** menu. If necessary, click **Show Details** (or ▼) to expand the print window.

Note:

Operations differ depending on the application. See the application's help for details.

Starting the utility

Select **System Preferences** from the  menu > **Printers & Scanners** (or **Print & Scan, Print & Fax**), and then select the printer. Click **Options & Supplies** > **Utility** > **Open Printer Utility**.

Guide to Mac OS X Printer Driver

Printer Driver Screen

Switch the pop-up menu on the center of the screen to show more items.

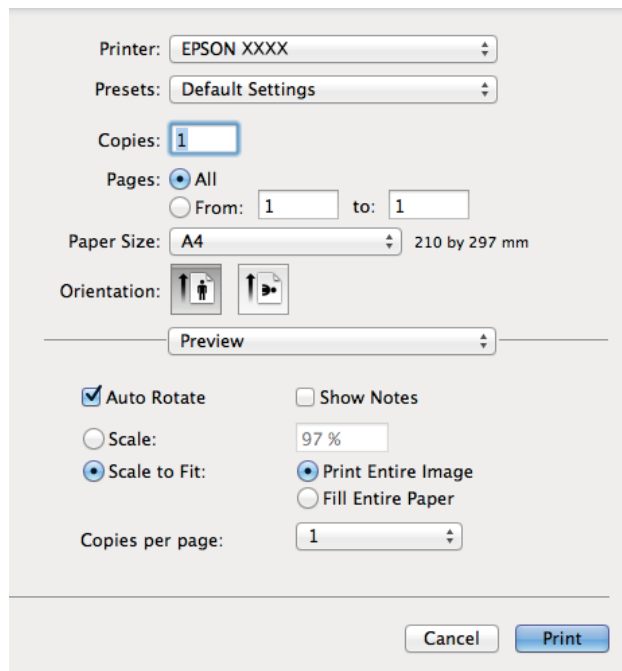

| Pop-up Menu | Descriptions |
|-----------------------------|---|
| Print Settings | You can make basic settings for printing, such as paper type or borderless printing. |
| Two-sided Printing Settings | You can select a binding direction for 2-sided printing or select a document type. This menu is only displayed for automatic 2-sided printing capable models. |
| Layout | You can select a layout for printing several pages on one sheet or select to print a border. |
| Paper Handling | You can reduce or enlarge the size of the print job to automatically fit the paper size you loaded. |
| Color Matching | You can adjust the colors. |

Application Information

Note:

On Mac OS X v10.8.x or later, if **Print Settings** menu is not displayed, Epson printer driver has not been installed correctly.

Select **System Preferences** from the  menu > **Printers & Scanners** (or **Print & Scan**, **Print & Fax**), remove the printer, and then add the printer again. See the following to add a printer.

<http://epson.sn>

Epson Printer Utility

You can check the approximate ink levels and error information, and also maintain your printer, such as nozzle check or print head cleaning.



Making Operation Settings for the Mac OS X Printer Driver

You can make various settings such as skipping blank pages and enabling/disabling high speed printing.

1. Select **System Preferences** from the  menu > **Printers & Scanners** (or **Print & Scan**, **Print & Fax**), and then select the printer. Click **Options & Supplies** > **Options** (or **Driver**).
2. Make the appropriate settings, and then click **OK**.
 - Thick paper and envelopes: Prevents the ink from smearing when printing on thick paper. However, the print speed may be slower.
 - Skip Blank Page: Avoids printing blank pages.
 - Quiet Mode: Prints quietly. However, the print speed may be slower.
 - Permit temporary black printing: Prints only with black ink temporarily.

Application Information

- High Speed Printing: Prints when the print head moves in both directions. The print speed is faster, but the quality may decline.
- Remove white borders: Removes unnecessary margins during borderless printing.
- Warning Notifications: Allows the printer driver to display warning notifications.
- Establish bidirectional communication: Usually, this should be set to **On**. Select **Off** when acquiring the printer information is impossible because the printer is shared with Windows computers on a network or for any other reason.
- Lower Cassette: Add the optional paper cassette units to the paper source.

Note:

The availability of these settings varies by model.

EPSON Scan (Scanner Driver)

EPSON Scan is an application for controlling scanning. You can adjust the size, resolution, brightness, contrast, and quality of the scanned image.

Note:

You can also start EPSON Scan from a TWAIN-compliant scanning application.

Starting on Windows

- Windows 8.1/Windows 8

Enter the application name in the search charm, and then select the displayed icon.

- Except for Windows 8.1/Windows 8

Click the start button, and select **All Programs** or **Programs > EPSON > EPSON Scan > EPSON Scan**.

Starting on Mac OS X

Note:

EPSON Scan does not support the Mac OS X fast user switching feature. Turn off fast user switching.

Select **Go > Applications > Epson Software > EPSON Scan**.

Epson Event Manager

Epson Event Manager is an application that allows you to manage scanning from the control panel and save images to a computer. You can add your own settings as presets, such as the document type, the save folder location, and the image format. See the application's help for details.

Starting on Windows

- Windows 8.1/Windows 8

Enter the application name in the search charm, and then select the displayed icon.

- Except for Windows 8.1/Windows 8

Click the start button, and select **All Programs** or **Programs > Epson Software > Event Manager**.

Starting on Mac OS X

Select **Go > Applications > Epson Software > Event Manager**.

Application Information

Related Information

➔ [“Scanning to a Computer” on page 69](#)

Epson Easy Photo Print

Epson Easy Photo Print is an application that allows you to easily print photos with various layouts. You can preview the photo image and adjust the images or position. You can also print photos with a frame. See the application's help for details.

Note:

To use this application, the printer driver needs to be installed.

Starting on Windows

- Windows 8.1/Windows 8

Enter the application name in the search charm, and then select the displayed icon.

- Except for Windows 8.1/Windows 8

Click the start button, and then select **All Programs** or **Programs** > **Epson Software** > **Epson Easy Photo PrintE-Photo**.

Starting on Mac OS X

Select **Go** > **Applications** > **Epson Software** > **Epson Easy Photo Print**.

Epson Print CD

Epson Print CD is an application that allows you to design a CD/DVD label to be printed directly onto a CD/DVD. You can also print a CD/DVD jacket for CD/DVD case. See the application's help for details.

Note:

To use this application, the printer driver needs to be installed.

Starting on Windows

- Windows 8/Windows 8.1

Enter the application name in the search charm, and then select the displayed icon.

- Except for Windows 8/Windows 8.1

Click the start button, and then select **All Programs** or **Programs** > **Epson Software** > **Print CD**.

Starting on Mac OS X

Select **Go-Applications** > **Epson Software** > **Print CD** > **Print CD**.

E-Web Print (for Windows Only)

E-Web Print is an application that allows you to easily print web pages with various layouts. See the application's help for details. You can access the help from the **E-Web Print** menu on the **E-Web Print** tool bar.

Starting

When you install E-Web Print, it is displayed in your browser. Click **Print** or **Clip**.

EPSON Software Updater

EPSON Software Updater is an application that checks for new or updated software on the internet and installs it. You can also update the printer's firmware and manual.

Starting on Windows

- Windows 8.1/Windows 8

Enter the application name in the search charm, and then select the displayed icon.

- Except for Windows 8.1/Windows 8

Click the start button, and select **All Programs** (or **Programs**) > **Epson Software** > **EPSON Software Updater**.

Note:

You can also start EPSON Software Updater by clicking the printer icon on the task bar on the desktop, and then selecting **Software Update**.

Starting on Mac OS X

Select **Go** > **Applications** > **Epson Software** > **EPSON Software Updater**.

Uninstalling Applications

Note:

Log on to your computer as an administrator. Enter the administrator password if the computer prompts you.

Uninstalling Applications - Windows

1. Press the  button to turn off the printer.
2. Quit all running applications.
3. Open **Control Panel**:
 - Windows 8.1/Windows 8
Select **Desktop** > **Settings** > **Control Panel**.
 - Except for Windows 8.1/Windows 8
Click the start button and select **Control Panel**.
4. Open **Uninstall a program** (or **Add or Remove Programs**):
 - Windows 8.1/Windows 8/Windows 7/Windows Vista
Select **Uninstall a program** in **Programs**.
 - Windows XP
Click **Add or Remove Programs**.
5. Select the application you want to uninstall.
6. Uninstall the applications:
 - Windows 8.1/Windows 8/Windows 7/Windows Vista
Click **Uninstall/Change** or **Uninstall**.

Application Information

- Windows XP



Click **Change/Remove** or **Remove**.

Note:

If the **User Account Control** window is displayed, click **Continue**.

7. Follow the on-screen instructions.

Uninstalling Applications - Mac OS X

1. Download the Uninstaller using EPSON Software Updater.
Once you have downloaded the Uninstaller, you do not need to download it again each time you uninstall the application.
2. Turn off the printer by pressing the  button.
3. To uninstall the printer driver, select **System Preferences** from the  menu > **Printers & Scanners** (or **Print & Scan, Print & Fax**), and then remove the printer from the enabled printers list.
4. Quit all running applications.
5. Select **Go > Applications > Epson Software > Uninstaller**.
6. Select the application you want to uninstall, and then click **Uninstall**.



Important:

The Uninstaller removes all drivers for Epson inkjet printers on the computer. If you use multiple Epson inkjet printers and you only want to delete some drivers, delete all of them first, and then install the necessary printer driver again.

Note:

If you cannot find the application you want to uninstall in the application list, you cannot uninstall using the Uninstaller. In this situation, select **Go > Applications > Epson Software**, select the application you want to uninstall, and then drag it to the trash icon.

Related Information

- ➔ [“EPSON Software Updater” on page 96](#)

Installing Applications

If your computer is connected to a network, install the latest applications available on the website. If you are unable to download the applications from the website, install them from the software disc that came with the printer.

Note:

- Log on to your computer as an administrator. Enter the administrator password if the computer prompts you.
- When reinstalling an application, you need to uninstall it first.

1. Quit all running applications.

Application Information

2. When installing the printer driver or EPSON Scan, disconnect the printer and the computer temporarily.

Note:

Do not connect the printer and the computer until you are instructed to do so.

3. Install the applications by following the instructions on the website below.

<http://epson.sn>

Related Information

➔ “Uninstalling Applications” on page 96

Updating Applications and Firmware

You may be able to clear certain problems and improve or add functions by updating the applications and the firmware. Make sure you use the latest version of the applications and firmware.

1. Make sure that the printer and the computer are connected, and the computer is connected to the internet.
2. Start EPSON Software Updater, and update the applications or the firmware.



Important:

Do not turn off the computer or the printer while updating.

Note:

If you cannot find the application you want to update in the list, you cannot update using the EPSON Software Updater. Check for the latest versions of the applications from your local Epson website.

<http://www.epson.com>

Related Information

➔ “EPSON Software Updater” on page 96

Solving Problems

Checking the Printer Status

Checking Messages on the LCD Screen

If an error message is displayed on the LCD screen, follow the on-screen instructions or the solutions below to solve the problem.

| Messages | Solutions |
|---|--|
| Printer error. Turn power off and then on again. For details, see your documentation. | Remove any paper or protective material in the printer. If the error message is still displayed after turning the power off and on again, contact your dealer. |
| Operation canceled. Error while saving. | The external storage device, such as a memory card, may be damaged. Check if the device is available. |
| A printer's ink pad is nearing the end of its service life. Please contact Epson Support. | Contact Epson or an authorised Epson service provider to replace the ink pad*. It is not a user-serviceable part. The message will be displayed until the ink pad is replaced. Press the ◊ button to resume printing. |
| A printer's ink pad is at the end of its service life. Please contact Epson Support. | Contact Epson or an authorised Epson service provider to replace the ink pad*. It is not a user-serviceable part. |
| Communication error. Make sure the computer is connected, then try again. | Connect the computer and the printer correctly. If the error message is still displayed, make sure that EPSON Scan and Epson Event Manager are installed on the computer. |
| Recovery Mode | The printer has started in recovery mode because the firmware update failed. Follow the steps below to try to update the firmware again. 1. Connect the computer and the printer with a USB cable. 2. Visit your local Epson website for further instructions. |

* In some print cycles a very small amount of surplus ink may be collected in the ink pad. To prevent ink leakage from the pad, the printer is designed to stop printing when the pad has reached its limit. Whether and how often this is required will vary according to the number of pages you print, the type of material that you print and the number of cleaning cycles that the printer performs. The need for replacement of the pad does not mean that your printer has ceased to operate in accordance with its specifications. The printer will advise you when the pad requires replacing and this can only be performed by an authorised Epson Service provider. The Epson warranty does not cover the cost of this replacement.

Related Information

- ➔ [“Contacting Epson Support” on page 125](#)
- ➔ [“Supported Memory Card Specifications” on page 117](#)
- ➔ [“Supported External Storage Device Specifications” on page 118](#)
- ➔ [“Installing Applications” on page 97](#)
- ➔ [“Updating Applications and Firmware” on page 98](#)

Checking the Printer Status - Windows

1. Access the printer driver window.
2. Click **EPSON Status Monitor 3** on the **Maintenance** tab.

Note:

- ❑ You can also check the printer status by double-clicking the printer icon on the taskbar. If the printer icon is not added to the taskbar, click **Monitoring Preferences** on the **Maintenance** tab, and then select **Register the shortcut icon to the taskbar**.
- ❑ If **EPSON Status Monitor 3** is disabled, click **Extended Settings** on the **Maintenance** tab, and then select **Enable EPSON Status Monitor 3**.

Related Information

➔ [“Windows Printer Driver” on page 88](#)

Checking Printer Status - Mac OS X

1. Select **System Preferences** from the  menu > **Printers & Scanners** (or **Print & Scan, Print & Fax**), and then select the printer.
2. Click **Options & Supplies** > **Utility** > **Open Printer Utility**.
3. Click **EPSON Status Monitor**.

Removing Jammed Paper

Check the error displayed on the control panel and follow the instructions to remove the jammed paper including any torn pieces. Next, clear the error.



Important:

Remove the jammed paper carefully. Removing the paper vigorously may cause damage to the printer.

Solving Problems

Removing Jammed Paper from the Rear Paper Feed

Remove the jammed paper.

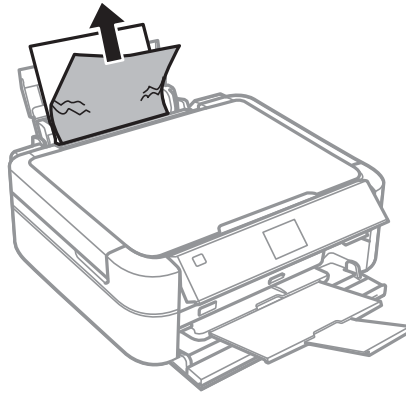

Removing Jammed Paper from Inside the Printer

 **Caution:**

- Be careful not to trap your hand or fingers when opening or closing the scanner unit. Otherwise you may be injured.
- Never touch the buttons on the control panel while your hand is inside the printer. If the printer starts operating, it could cause an injury. Be careful not to touch the protruding parts to avoid injury.

1. Open the scanner unit with the document cover closed.

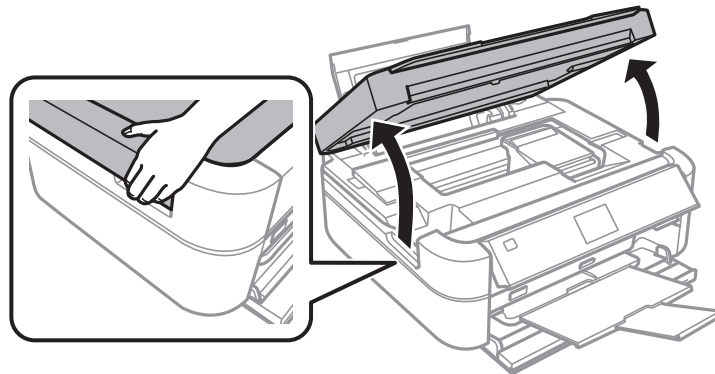

Solving Problems

2. Remove the jammed paper.

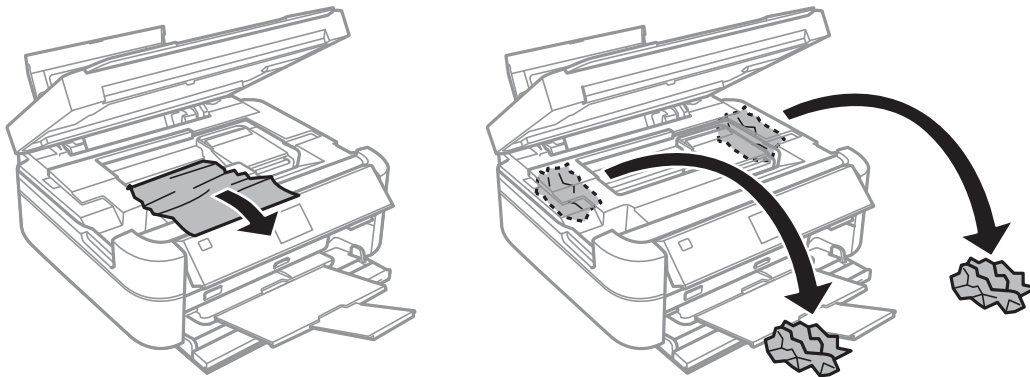

! *Important:*

Do not touch the white flat cable, translucent part, ink tubes, and left lateral surface of the print head inside the printer. Doing so may cause a malfunction.

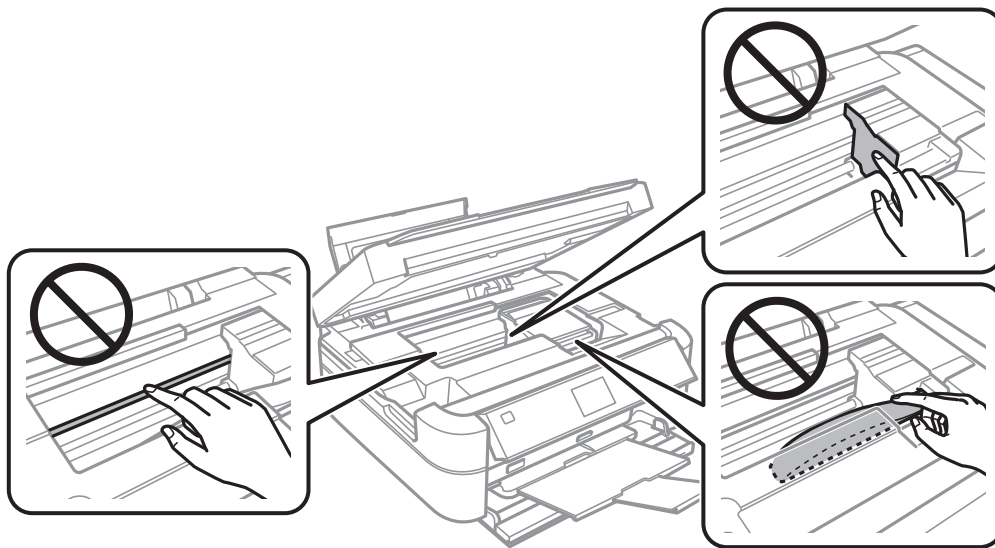

3. Close the scanner unit.

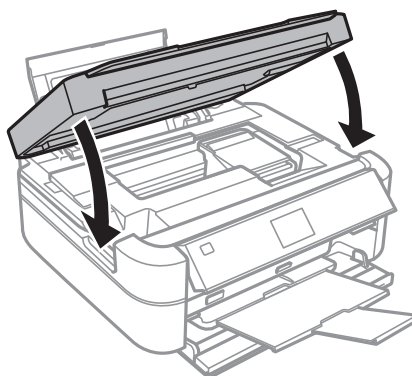

Paper Does Not Feed Correctly

Check the following if the paper jams, paper feeds at a slant, several sheets of paper feed at a time, no paper feeds, or paper is ejected.

- Place the printer on a flat surface and operate in the recommended environmental conditions.
- Use paper supported by this printer.
- Follow the paper handling precautions.
- Load paper in the correct direction, and slide the edge guide against the edge of the paper.
- Do not load more than the maximum number of sheets specified for the paper. For plain paper, do not load above the line indicated by the triangle symbol on the edge guide.
- Load one sheet of paper at a time when loading multiple sheets of paper.
- When multiple sheets of paper feed at once during manual 2-sided printing, remove any paper which is loaded in the paper source before you reload the paper.
- Load and eject paper without printing to clean the paper path.
- If you have opened the scanner unit during printing, close it immediately. If printing is paused, the paper is ejected.

Related Information

- ➔ [“Environmental Specifications” on page 119](#)
- ➔ [“Paper Handling Precautions” on page 27](#)
- ➔ [“Available Paper and Capacities” on page 28](#)
- ➔ [“Loading Paper in the Rear Paper Feed” on page 30](#)
- ➔ [“Cleaning the Paper Path” on page 86](#)

Power and Control Panel Problems

Power Does Not Turn On

- Hold down the  button for a little longer.
- Make sure the power cord is securely plugged in.



Lights Came On and then Went Out

The printer's voltage may not match the outlet rating. Turn off the printer and unplug it immediately. Then check the label on the printer.

**Caution:**

If the voltage does not match, DO NOT PLUG YOUR PRINTER BACK IN. Contact your dealer.

Power Does Not Turn Off

Hold down the  button for a little longer. If you still cannot turn off the printer, unplug the power cord. To prevent the print head from drying out, turn the printer back on and turn it off by pressing the  button.

LCD Screen Gets Dark

The printer is in sleep mode. Press any button on the control panel to return the LCD screen to its former state.

Printer Does Not Print

Check the following if the printer does not operate or prints nothing.

- Install the printer driver.
- To print a disc label, install Epson Print CD.
- To print photos easily, install Epson Easy Photo Print.
- Connect the interface cable securely to the printer and the computer.
- If you are using a USB hub, try to connect the printer directly to the computer.
- If you are printing a large image, the computer may not have enough memory. Print the image at a lower resolution or a smaller size.
- In Windows, click **Print Queue** on the printer driver's **Maintenance** tab, and then check the following.
 - Check if there are any paused print jobs.
Cancel printing if necessary.
 - Make sure the printer is not offline or pending.
If the printer is offline or pending, clear the offline or pending setting from the **Printer** menu.
 - Make sure the printer is selected as the default printer from the **Printer** menu (there should be a check mark on the menu item).
If the printer is not selected as the default printer, set it as the default printer.
- In Mac OS X, make sure the printer status is not **Pause**.
Select **System Preferences** from the  menu > **Printers & Scanners** (or **Print & Scan**, **Print & Fax**), and then double-click the printer. If the printer is paused, click **Resume** (or **Resume Printer**).
- Run the nozzle check and then clean the print head if any of the print head nozzles are clogged.

Related Information

- ➔ [“Installing Applications” on page 97](#)
- ➔ [“Epson Easy Photo Print” on page 95](#)
- ➔ [“Epson Print CD” on page 95](#)
- ➔ [“Canceling Printing” on page 64](#)
- ➔ [“Checking and Cleaning the Print Head” on page 82](#)

Printout Problems

Print Quality Is Poor

Check the following if the print quality is poor due to blurry prints, banding, missing colors, faded colors, misalignment, and mosaic-like patterns in the prints.

- Make sure the initial ink charging is complete.
- Check the ink tank. If the tank is empty, refill the ink immediately and clean the print head.
- Run the nozzle check and then clean the print head if any of the print head nozzles are clogged.
- If you have not used the printer for a long time, use the Power Ink Flushing utility of the printer driver.
- Align the print head.
- If banding appears at intervals of 2.5 cm, align the print head.
- Use paper supported by this printer.
- Do not print on paper that is damp, damaged, or too old.
- If the paper is curled or the envelope is puffed up, flatten it.
- When printing images or photos, print using high-resolution data. Images on websites are often low resolution although they look good enough on the display, and so print quality may decline.
- Select the appropriate paper type setting on the control panel or in the printer driver for the type of paper loaded in the printer.
- Print using a high quality setting on the control panel or in the printer driver.
- When printing on a disc, adjust the level of density on the control panel or in Epson Print CD.
- When images or photos are printed in unexpected colors, adjust the color and then print again. The automatic color correction feature uses the standard correction mode in **PhotoEnhance**. Try another correction mode in **PhotoEnhance** by selecting an option other than **Auto Correct** (or **Automatic**) as the **Scene Correction** (or **Scene Detection**) setting. If the problem continues, use any other color correction feature other than **PhotoEnhance**.
- Disable the bidirectional (or high speed) setting. When this setting is enabled, the print head prints while moving in both directions, and vertical lines may be misaligned. If you disable this feature, printing may slow down.
 - Control Panel
In the print settings for **Print Photos** mode, disable **Bidirectional**.
 - Windows
Clear **High Speed** on the printer driver's **More Options** tab.
 - Mac OS X
Select **System Preferences** from the  menu > **Printers & Scanners** (or **Print & Scan, Print & Fax**), and then select the printer. Click **Options & Supplies** > **Options** (or **Driver**). Select **Off** as the **High Speed Printing** setting.
- Do not stack the paper immediately after printing.
- Dry the printouts completely before filing or displaying them. When drying the printouts, avoid direct sun light, do not use a dryer, and do not touch the printed side of paper.
- Try to use genuine Epson ink bottles. This product is designed to adjust colors based on the use of genuine Epson ink bottles. The use of non-genuine ink bottles may cause print quality to decline.

Solving Problems

- Use ink bottles with the correct part code for this printer.
- Epson recommends using the ink bottle before the date printed on the package.
- When printing images or photos, Epson recommends using genuine Epson paper rather than plain paper. Print on the printable side of the genuine Epson paper.

Related Information

- ➔ [“Refilling the Ink Tanks” on page 78](#)
- ➔ [“Checking and Cleaning the Print Head” on page 82](#)
- ➔ [“Replacing Ink inside the Ink Tubes” on page 84](#)
- ➔ [“Aligning the Print Head” on page 85](#)
- ➔ [“Paper Handling Precautions” on page 27](#)
- ➔ [“Available Paper and Capacities” on page 28](#)
- ➔ [“List of Paper Types” on page 29](#)
- ➔ [“Epson Print CD” on page 95](#)
- ➔ [“Adjusting the Print Color” on page 61](#)
- ➔ [“Print Photos Mode” on page 19](#)

Copy Quality Is Poor

Check the following if uneven colors, smears, dots, or straight lines appear in the copied image.

- Load and eject paper without printing to clean the paper path.
- Clean the scanner glass and the document cover.
- Do not press too hard on the original or the document cover when you are placing the originals on the scanner glass. Uneven colors, smears, or dots may appear when the original or the document cover are pressed too hard.
- If a moire (cross-hatch) pattern appears, change the reduce and enlarge setting or place the original at a slightly different angle.

Related Information

- ➔ [“Cleaning the Paper Path” on page 86](#)
- ➔ [“Cleaning the Scanner Glass” on page 87](#)
- ➔ [“Print Quality Is Poor” on page 105](#)

An Image of the Reverse Side of the Original Appears in the Copied Image

- For a thin original, place the original on the scanner glass and then place a piece of black paper over it.
- Lower the copy density setting on the control panel.

The Position, Size, or Margins of the Printout Are Incorrect

- Load paper in the correct direction, and slide the edge guides against the edges of the paper.
- When printing on photo stickers, enter **Setup**, select **Printer Setup > Stickers**, and then adjust the printing position.

Solving Problems

- When printing on a disc, enter **Setup**, select **Printer Setup > CD/DVD**, and then adjust the printing position.
- When placing the originals on the scanner glass, align the corner of the original with the corner indicated by a symbol on the frame of the scanner glass. If the edges of the copy are cropped off, move the original slightly away from the corner.
- When you place multiple originals on the scanner glass to copy them separately, but they are copied onto a single sheet, place the originals at least 5mm (0.2 inch) apart. If the problem continues, place one original at a time.
- Clean the scanner glass and the document cover. If there is dust or stains on the glass, the copy area may extend to include the dust or stains, resulting in the wrong printing position or small images.
- Select the appropriate paper size setting on the control panel or in the printer driver.
- Adjust the margin setting in the application so that it falls within the printable area.
- If you want to print with no margins, make settings for borderless printing.
 - Control Panel

In the print settings for **Print Photos** or **Copy** mode, select **Borderless**. If you select a paper type that does not support borderless printing, you cannot select **Borderless**. Select a paper type that supports borderless printing.
 - Windows

Select **Borderless** on the printer driver's **Main** tab. If you select a paper type that does not support borderless printing, you cannot select this check box. Select a paper type that supports borderless printing.
 - Mac OS X

Select a paper size for borderless printing as the **Paper Size** setting in the print dialog.
- During borderless printing, the image is slightly enlarged and the protruding area is cropped. Adjust the amount of enlargement.
 - Control Panel

In the print settings for **Print Photos** or **Copy** mode, select **Expansion**, and then select the amount of enlargement.
 - Windows

Click **Settings** on the printer driver's **Main** tab, and then select the amount of enlargement.
 - Mac OS X

Select the **Print Settings** menu in the print dialog and select the amount of enlargement in the **Expansion** setting.

Related Information

- ➔ [“Loading Paper in the Rear Paper Feed” on page 30](#)
- ➔ [“Cleaning the Scanner Glass” on page 87](#)
- ➔ [“Printable Area” on page 115](#)
- ➔ [“Available Paper and Capacities” on page 28](#)
- ➔ [“Print Photos Mode” on page 19](#)
- ➔ [“Copy Mode” on page 17](#)

Paper Is Smearred or Scuffed

Check the following if the paper is smearred or scuffed when printing.

Solving Problems

- Clean the paper path.
- Clean the scanner glass and the document cover.
- Load paper in the correct direction.
- When performing manual 2-sided printing, make sure that the ink is completely dry before reloading the paper.
- Enable the scuffing prevention feature. Only enable this feature when a scuffing problem occurs because using it may cause the print quality to decline and print speed to slow down.
 - Control Panel
 - Enter **Setup**, select **Printer Setup**, and then enable the **Thick Paper** setting.
 - Windows
 - Select the **Maintenance** tab on the printer driver, click **Extended Settings**, and then select **Thick Paper and Envelopes**.
 - Mac OS X
 - Select **System Preferences** from the  menu > **Printers & Scanners** (or **Print & Scan, Print & Fax**), and then select the printer. Click **Options & Supplies > Options** (or **Driver**). Select **On** as the **Thick paper and envelopes** setting.
- When the paper is smeared during copying, lower the copy density setting on the control panel.

Related Information

- ➔ [“Cleaning the Paper Path” on page 86](#)
- ➔ [“Cleaning the Scanner Glass” on page 87](#)
- ➔ [“Loading Paper in the Rear Paper Feed” on page 30](#)
- ➔ [“Copy Mode” on page 17](#)
- ➔ [“Print Quality Is Poor” on page 105](#)

Printed Characters Are Incorrect or Garbled

- Connect the interface cable securely to the printer and the computer.
- Cancel any paused print jobs.
- Do not put the computer manually into the **Hibernate** mode or the **Sleep** mode while printing. Pages of garbled text may be printed next time you start the computer.

Related Information

- ➔ [“Canceling Printing” on page 64](#)

The Printed Image Is Inverted

Clear any mirror image settings in the printer driver or the application.

- Windows
 - Clear **Mirror Image** on the printer driver's **More Options** tab.
- Mac OS X
 - Clear **Mirror Image** from the print dialog's **Print Settings** menu.



The Printout Problem Could Not be Cleared

If you have tried all of the solutions and have not solved the problem, try uninstalling and then reinstalling the printer driver.

Related Information

- ➔ [“Uninstalling Applications” on page 96](#)
- ➔ [“Installing Applications” on page 97](#)

Printing Is Too Slow

- When printing continuously for approximately more than 30 minutes, printing slows down to prevent the printer mechanism from overheating and being damaged. However, you can continue printing. To return the printer to normal printing speed, cancel printing, and leave the printer idle for at least 30 minutes with the power on. The printer does not recover if the power is off.
- Close any unnecessary applications.
- Lower the quality setting on the control panel or the printer driver. High quality printing slows down the printing speed.
- Enable the bidirectional (or high speed) setting. When this setting is enabled, the print head prints while moving in both directions, and the printing speed increases.
 - Control Panel
In the print settings for **Print Photos** mode, enable **Bidirectional**.
 - Windows
Select **High Speed** on the printer driver's **More Options** tab.
 - Mac OS X
Select **System Preferences** from the  menu > **Printers & Scanners** (or **Print & Scan, Print & Fax**), and then select the printer. Click **Options & Supplies** > **Options** (or **Driver**). Select **On** as the **High Speed Printing** setting.
- Disable quiet mode. This feature slows down the printing speed.
 - Windows
Disable the **Quiet Mode** setting on the printer driver's **Main** tab.
 - Mac OS X
Select **System Preferences** from the  menu > **Printers & Scanners** (or **Print & Scan, Print & Fax**), and then select the printer. Click **Options & Supplies** > **Options** (or **Driver**). Select **Off** as the **Quiet Mode** setting.

Cannot Start Scanning

- Connect the interface cable securely to the printer and the computer.
- If you are using a USB hub, try to connect the printer directly to the computer.
- Make sure you select the correct printer (scanner) if a scanner list is displayed when you start EPSON Scan.
- If you are using any TWAIN-compliant applications, select the printer (scanner) you are using.

Solving Problems

- ❑ In Windows, make sure the printer (scanner) is displayed in **Scanner and Camera**. The printer (scanner) should be displayed as "EPSON XXXXX (printer name)". If the printer (scanner) is not displayed, uninstall and then re-install EPSON Scan. See the following to access **Scanner and Camera**.
 - ❑ Windows 8.1/Windows 8
Select **Desktop > Settings > Control Panel**, enter "Scanner and Camera" in the search charm, click **Show Scanner and Camera**, and then check if the printer is displayed.
 - ❑ Windows 7
Click the start button and select **Control Panel**, enter "Scanner and Camera" in the search charm, click **View scanners and cameras**, and then check if the printer is displayed.
 - ❑ Windows Vista
Click the start button, select **Control Panel > Hardware and Sound > Scanners and Cameras**, and then check if the printer is displayed.
 - ❑ Windows XP
Click the start button, select **Control Panel > Printers and Other Hardware > Scanner and Cameras**, and then check if the printer is displayed.
- ❑ If you cannot scan using any TWAIN-compliant applications, uninstall and then reinstall the TWAIN compliant application.
- ❑ For Mac OS X with an Intel processor, if other Epson scanner drivers except for EPSON Scan, such as Rosetta or PPC are installed, uninstall them and EPSON Scan, and then reinstall EPSON Scan.

Related Information

- ➔ ["Uninstalling Applications" on page 96](#)
- ➔ ["Installing Applications" on page 97](#)

Cannot Start Scanning when Using the Control Panel

- ❑ Make sure EPSON Scan and Epson Event Manager are installed correctly.
- ❑ Check the scanning setting assigned in Epson Event Manager.

Related Information

- ➔ ["Cannot Start Scanning" on page 109](#)

Scanned Image Problems

Scan Quality Is Poor

- ❑ Clean the scanner glass and the document cover.
- ❑ Do not press too hard on the original or the document cover when you are placing the originals on the scanner glass. Uneven colors, smears, or dots may appear when the original or the document cover are pressed too hard.
- ❑ Remove dust from the original.
- ❑ Make the appropriate document type settings on the control panel.
- ❑ Scan at a higher resolution.

Solving Problems

- ❑ Adjust the image in EPSON Scan, and then scan. See the EPSON Scan help for details.

Related Information

- ➔ [“Cleaning the Scanner Glass” on page 87](#)
- ➔ [“Scan Mode” on page 23](#)

Characters Are Blurred

- ❑ In **Home Mode** or **Office Mode** in EPSON Scan, select **Image Option** from the **Image Adjustments** setting, and then select **Text Enhancement**.
- ❑ In **Professional Mode** in EPSON Scan, select **Document** as the **Auto Exposure Type** in the **Original** settings.
- ❑ Adjust the threshold settings in EPSON Scan.
 - ❑ **Home Mode**
Select **Black & White** as the **Image Type** setting, click **Brightness**, and then adjust the threshold.
 - ❑ **Office Mode** or **Professional Mode**
Select **Black & White** as the **Image Type** setting, and then adjust the threshold.
- ❑ Scan at a higher resolution.

An Image of the Reverse Side of the Original Appears in the Scanned Image

- ❑ For a thin original, place the original on the scanner glass and then place a piece of black paper over it.
- ❑ Make the appropriate document type settings on the control panel or in EPSON Scan.
- ❑ In **Home Mode** or **Office Mode** in EPSON Scan, select **Image Option** from the **Image Adjustments** setting, and then select **Text Enhancement**.

Moire (Cross-Hatch) Patterns Appear in the Scanned Image

- ❑ Place the original at a slightly different angle.
- ❑ Select **Descreening** in any mode other than **Full Auto Mode** in EPSON Scan.
- ❑ Change the resolution setting on the control panel or in EPSON Scan.

Related Information

- ➔ [“Scan Mode” on page 23](#)

Scanning Area or Direction Is Not Correct

- ❑ When placing the originals on the scanner glass, align the corner of the original with the corner indicated by a symbol on the frame of the scanner glass. If the edges of the scanned image are cropped off, move the original slightly away from the corner.
- ❑ Clean the scanner glass and the document cover. If there is dust or stains on the glass, the scanning area may extend to include the dust or stains, resulting in the wrong scanning position or small images.

Solving Problems

- ❑ When you place multiple originals on the scanner glass to scan them separately, but they are scanned onto a single file, place the originals at least 20 mm (0.8 inch) apart. If the problem continues, place one original at a time.
- ❑ When scanning from the control panel, set the scan area correctly.
- ❑ When scanning using **Full Auto Mode** or the thumbnail preview in EPSON Scan, move the original 4.5 mm (0.18 inch) away from the edges of the scanner glass.
- ❑ When using the thumbnail preview for a large original in **Home Mode** or **Professional Mode** in EPSON Scan, the scanning area may not be correct. When previewing in EPSON Scan, create marquees of the area you want to scan on the **Preview** tab in the **Preview** window.
- ❑ If **Auto Photo Orientation** in EPSON Scan does not work as intended, see the EPSON Scan help.
- ❑ Clear **Auto Photo Orientation** in EPSON Scan.
- ❑ When scanning with EPSON Scan the available scanning area may be restricted if the resolution setting is too high. Lower the resolution or adjust the scanning area in the **Preview** window.

Related Information

- ➔ [“Placing Originals on the Scanner Glass” on page 33](#)
- ➔ [“Cleaning the Scanner Glass” on page 87](#)
- ➔ [“Scan Mode” on page 23](#)

The Scanned Image Problem Could Not be Cleared

If you have tried all of the solutions and could not solve the problem, click **Configuration** in a mode other than **Full Auto Mode** in the EPSON Scan window, and then click **Reset All** on the **Other** tab to initialize the EPSON Scan settings. If initialization does not solve the problem uninstall and re-install EPSON Scan.

Related Information

- ➔ [“Uninstalling Applications” on page 96](#)
- ➔ [“Installing Applications” on page 97](#)

Other Scanning Problems

Cannot Scan in Full Auto Mode in EPSON Scan

- ❑ You cannot scan to PDF/Multi-TIFF format continuously in **Full Auto Mode**. Scan in a mode other than **Full Auto Mode**.
- ❑ See the EPSON Scan help for other way of solving problems.

Thumbnail Preview Does Not Work Properly

See the EPSON Scan help.

Scanning Is Too Slow

- Lower the resolution.
- Click **Configuration** in EPSON Scan, and then disable **Quiet Mode** on the **Other** tab.

Related Information

➔ [“Scan Mode” on page 23](#)

Scanning Stops when Scanning to PDF/Multi-TIFF

- When scanning large volumes, we recommend scanning in grayscale.
- Increase the free space on the computer's hard disk. Scanning may stop if there is not enough free space.
- Try scanning at a lower resolution. Scanning stops if the total data size reaches the limit.

Related Information

➔ [“Scan Mode” on page 23](#)

Other Problems

Slight Electric Shock when Touching the Printer

If many peripherals are connected to the computer, you may feel a slight electric shock when touching the printer. Install a ground wire to the computer that is connected to the printer.

Operation Sounds Are Loud

If operations sounds are too loud, enable quiet mode. However, this may slow down printer operations.

- Windows

Enable **Quiet Mode** on the **Main** tab in the printer driver.

- Mac OS X

Select **System Preferences** from the  menu > **Printers & Scanners** (or **Print & Scan, Print & Fax**), and then select the printer. Click **Options & Supplies** > **Options** (or **Driver**). Select **On** as the **Quiet Mode** setting.

Quiet Mode is only effective when you select the **Print Settings** menu in the print dialog, and then select **plain papers** as the **Media Type** setting and **Normal** as the **Print Quality** setting.

- EPSON Scan

Select a mode other than **Full Auto Mode**, click **Configuration**, and then set **Quiet Mode** on the **Other** tab.

Cannot Save Data to a Memory Device

- Use a memory device that is supported by the printer.
- Check that the memory device is not write protected.

Solving Problems

- ❑ Check that the memory device has enough available memory. If the available memory is low, data cannot be saved.

Related Information

- ➔ [“Supported Memory Card Specifications” on page 117](#)
- ➔ [“Supported External Storage Device Specifications” on page 118](#)

Application Is Blocked by a Firewall (for Windows Only)

Add the application to the Windows Firewall allowed program in security settings on the **Control Panel**.

"?" Is Displayed on the Photo Selection Screen

"?" is displayed on the LCD screen when the image file is not supported by the product.

Related Information

- ➔ [“Supported Data Specifications” on page 118](#)

A Message Prompting You to Reset the Ink Levels is Displayed

Refill all or the specified ink tanks, select the color that you refilled on the LCD screen, and then press the  button to reset the ink levels.

Depending on the usage conditions, the message may be displayed when there is still ink in the tank.

Related Information

- ➔ [“Refilling the Ink Tanks” on page 78](#)

Appendix

Technical Specifications

Printer Specifications

| | | |
|-----------------------------|-------------|---|
| Print Head Nozzle Placement | | Black ink nozzles: 90 Color ink nozzles: 90 for each color |
| Weight of Paper | Plain Paper | 64 to 90 g/m ² (17 to 24lb) |
| | Envelopes | Envelope #10, DL, C6: 75 to 90 g/m ² (20 to 24 lb) |

Printable Area

Print quality may decline in the shaded areas due to the printer's mechanism.

Single sheets (normal printing)

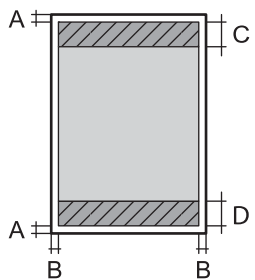
| | | |
|---|---|--------------------|
|  | A | 3.0 mm (0.12 in.) |
| | B | 3.0 mm (0.12 in.) |
| | C | 36.0 mm (1.42 in.) |
| | D | 18.0 mm (0.71 in.) |

Single sheets (borderless printing)

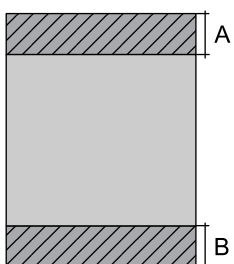
| | | |
|---|---|--------------------|
|  | A | 39.0 mm (1.54 in.) |
| | B | 21.0 mm (0.82 in.) |

Appendix

Envelopes

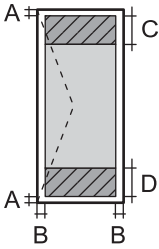
| | | |
|---|---|--------------------|
|  | A | 3.0 mm (0.12 in.) |
| | B | 5.0 mm (0.20 in.) |
| | C | 18.0 mm (0.71 in.) |
| | D | 36.0 mm (1.42 in.) |

CD/DVD

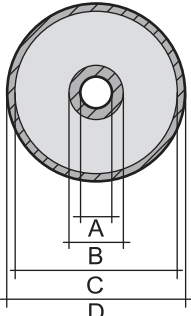
| | | | |
|--|-------|-------------------|------------------|
| CD/DVD size | 12 cm | 8 cm | |
|  | A | 18 mm (0.71 in.) | |
| | B | 43 mm (1.69 in.) | |
| | C | 116 mm (4.57 in.) | 76 mm (2.99 in.) |
| | D | 120 mm (4.72 in.) | 80 mm (3.15 in.) |

Scanner Specifications

| | |
|-----------------------|--|
| Scanner Type | Flatbed |
| Photoelectric Device | CIS |
| Maximum Document Size | 216 × 297 mm (8.5 × 11.7 in.) A4, Letter |
| Resolution | 1200 dpi (main scan) 2400 dpi (sub scan) |
| Color Depth | Color <input type="checkbox"/> 48 bits per pixel internal (16 bits per pixel per color internal) <input type="checkbox"/> 24 bits per pixel external (8 bits per pixel per color external) Grayscale <input type="checkbox"/> 16 bits per pixel internal <input type="checkbox"/> 8 bits per pixel external Black and white <input type="checkbox"/> 16 bits per pixel internal <input type="checkbox"/> 1 bits per pixel external |
| Light Source | LED |

Interface Specifications

| | |
|---|--------------|
| For Computer | Hi-Speed USB |
| For External USB Devices and PictBridge | Hi-Speed USB |

External Storage Device Specifications

Supported Memory Card Specifications

| Compatible Memory Cards | Maximum Capacities |
|---|--------------------|
| Memory Stick Memory Stick Duo* | 128 MB |
| Memory Stick PRO Memory Stick PRO Duo* Memory Stick PRO-HG Duo* | 32 GB |
| MagicGate Memory Stick MagicGate Memory Stick Duo* | 128 MB |
| Memory Stick Micro* | 32 GB |
| miniSD* | 2 GB |
| miniSDHC* | 32 GB |
| microSD* | 2 GB |
| microSDHC* | 32 GB |
| microSDXC* | 64 GB |
| SD | 2 GB |
| SDHC | 32 GB |
| SDXC | 64 GB |

* Attach an adapter to fit the memory card slot. Otherwise, the card may get stuck.

Supported memory card voltages

3.3 V type, dual voltage (3.3 V and 5V) type (supply voltage: 3.3 V)

5 V memory cards are not supported.

Maximum supply current

Memory Stick/PRO: 100 mA

SD: 200 mA

Appendix

Supported External Storage Device Specifications

| Compatible External Storage Devices | Maximum Capacities |
|---|---|
| CD-R Drive *1 DVD-R Drive *1 Blu-ray Drive *1 | CD-ROM*2/CD-R: 700 MB DVD-ROM*2/DVD-R: 4.7 GB (CD-RW, DVD+R, DVD±RW, DVD-RAM, and Blu-ray Disc™ are not supported.) |
| MO Drive *1 | 1.3 GB |
| HDD*1 USB Flash Drive | 2 TB (formatted in FAT, FAT32, or exFAT) |

*1 We do not recommend using external USB devices that are powered by USB. Use only external USB devices with independent AC power sources.

*2 Read only.

You cannot use the following devices:

- A device that requires a dedicated driver
- A device with security settings (password, encryption, and so on)
- A device with a built-in USB hub

Epson cannot guarantee operations for all externally connected devices.

Supported Data Specifications

| | |
|-------------------------|---|
| File Format | JPEG with the Exif Version 2.3 standard taken by digital cameras DCF*1 version 1.0 or 2.0*2 compliant |
| Image Size | Horizontal: 80 to 9200 pixels Vertical: 80 to 9200 pixels |
| File Size | Up to 2 GB |
| Maximum Number of Files | 9990*3 |

*1 Design rule for Camera File system.

*2 Photo data stored in the built-in memory of a digital camera is not supported.

*3 Up to 999 files can be displayed at a time. (If the number of files exceeds 999, the files are displayed in groups.)

Note:

"?" is displayed on the LCD screen when the printer cannot recognize the image file. In this situation, if you select a multiple image layout, blank sections will be printed.

Appendix

Dimensions

| | |
|------------|---|
| Dimensions | <p>Storage</p> <ul style="list-style-type: none"> ❑ Width: 542 mm (21.3 in.) ❑ Depth: 386 mm (15.2 in.) ❑ Height: 196 mm (7.7 in.) <p>Printing</p> <ul style="list-style-type: none"> ❑ Width: 542 mm (21.3 in.) ❑ Depth: 608 mm (23.9 in.) ❑ Height: 283 mm (11.1 in.) |
| Weight* | Approx. 9.1 kg (20.1 lb) |

* Without the ink and the power cord.

Electrical Specifications

| Model | 100 to 120 V Model | 220 to 240 V Model |
|---|---|---|
| Rated Frequency Range | 50 to 60 Hz | 50 to 60 Hz |
| Rated Current | 0.6 A | 0.3 A |
| Power Consumption (with USB Connection) | <p>Standalone copying: Approx. 12 W (ISO/IEC24712)</p> <p>Ready mode: Approx. 5.0 W</p> <p>Sleep mode: Approx. 1.2 W</p> <p>Power off: Approx. 0.15 W</p> | <p>Standalone copying: Approx. 12 W (ISO/IEC24712)</p> <p>Ready mode: Approx. 5.3 W</p> <p>Sleep mode: Approx. 1.6 W</p> <p>Power off: Approx. 0.35 W</p> |

Note:

Check the label on the printer for its voltage.

Environmental Specifications

| | |
|-----------|--|
| Operation | <p>Use the printer within the range shown in the following graph.</p> <p>Temperature: 10 to 35°C (50 to 95°F)</p> <p>Humidity: 20 to 80% RH (without condensation)</p> |
| Storage | <p>Temperature: -20 to 40°C (-4 to 104°F)*</p> <p>Humidity: 5 to 85% RH (without condensation)</p> |

Appendix

* You can store for one month at 40°C (104°F).

Environmental Specifications for Ink Bottles

| | |
|----------------------|--|
| Storage Temperature | -20 to 40 °C (-4 to 104 °F)* |
| Freezing Temperature | -15 °C (5 °F) Ink thaws and is usable after approximately 2 hours at 25 °C (77 °F). |

* You can store for one month at 40 °C (104 °F).

System Requirements

- Windows 8.1 (32-bit, 64-bit)/Windows 8 (32-bit, 64-bit)/Windows 7 (32-bit, 64-bit)/Windows Vista (32-bit, 64-bit)/Windows XP Professional x64 Edition/Windows XP (32-bit)
- Mac OS X v10.9.x/Mac OS X v10.8.x/Mac OS X v10.7.x/Mac OS X v10.6.8

Note:

- Mac OS X may not support some applications and features.*
- The UNIX File System (UFS) for Mac OS X is not supported.*

Regulatory Information

Standards and Approvals for European Model

| | |
|----------------------------------|--|
| Low voltage directive 2006/95/EC | EN60950-1 |
| EMC directive 2004/108/EC | EN55022 Class B EN61000-3-2 EN61000-3-3 EN55024 |

Restrictions on Copying

Observe the following restrictions to ensure the responsible and legal use of the printer.

Copying of the following items is prohibited by law:

- Bank bills, coins, government-issued marketable securities, government bond securities, and municipal securities
- Unused postage stamps, pre-stamped postcards, and other official postal items bearing valid postage
- Government-issued revenue stamps, and securities issued according to legal procedure

Exercise caution when copying the following items:

- Private marketable securities (stock certificates, negotiable notes, checks, etc.), monthly passes, concession tickets, etc.
- Passports, driver's licenses, warrants of fitness, road passes, food stamps, tickets, etc.

Note:

Copying these items may also be prohibited by law.

Responsible use of copyrighted materials:

Printers can be misused by improperly copying copyrighted materials. Unless acting on the advice of a knowledgeable attorney, be responsible and respectful by obtaining the permission of the copyright holder before copying published material.

Checking the Total Number of Pages Fed Through the Printer

You can check the total number of pages (sheets of paper and CDs/DVDs) fed through the printer.

Checking the Total Number of Pages Fed Through the Printer - Control Panel

The information is printed together with the nozzle check pattern. You can also check details such as the color page count and the count for CD/DVD printing.

1. Make sure that the CD/DVD tray is not inserted in the printer, and that the tray lever is in the up position.
2. Load A4-size plain paper in the printer.
3. Enter **Setup** from the home screen using the ◀ or ▶ button, and then press the OK button.
4. Select **Maintenance** using the ▲ or ▼ button, and then press the OK button.
5. Select **Nozzle Check** using the ▲ or ▼ button, and then press the OK button.
6. Follow the on-screen instructions to print the nozzle check pattern.

Related Information

➔ [“Loading Paper in the Rear Paper Feed” on page 30](#)

Checking the Total Number of Pages Fed Through the Printer - Windows

1. Access the printer driver window.
2. Click **Printer and Option Information** on the **Maintenance** tab.

Checking the Total Number of Pages Fed Through the Printer - Mac OS X

1. Select **System Preferences** from the  menu > **Printers & Scanners** (or **Print & Scan**, **Print & Fax**), and then select the printer.
2. Click **Options & Supplies** > **Utility** > **Open Printer Utility**.
3. Click **Printer and Option Information**.

Transporting the Printer

When you need to transport the printer to move or for repairs, follow the steps below to pack the printer.

 **Important:**

- When storing or transporting the printer, avoid tilting it, placing it vertically, or turning it upside down; otherwise ink may leak.*
- When storing or transporting an ink bottle after removing its seal, do not tilt the bottle and do not subject it to impacts or temperature changes. Otherwise, ink may leak even if the cap on the ink bottle is tightened securely. Be sure to keep the ink bottle upright when tightening the cap, and take measures to prevent ink from leaking when you transport the bottle.*
- Do not put opened ink bottles in the box with printer.*

1. Turn off the printer by pressing the  button.
2. Make sure the power light turns off, and then unplug the power cord.

 **Important:**

Unplug the power cord when the power light is off. Otherwise, the print head does not return to the home position causing the ink to dry, and printing may become impossible.

3. Disconnect all cables such as the power cord and USB cable.
4. Make sure there is no memory card inserted.
5. Remove all of the paper from the printer.
6. Make sure there are no originals on the printer.

Appendix

7. Open the scanner unit with the document cover closed. Secure the print head to the case with tape.

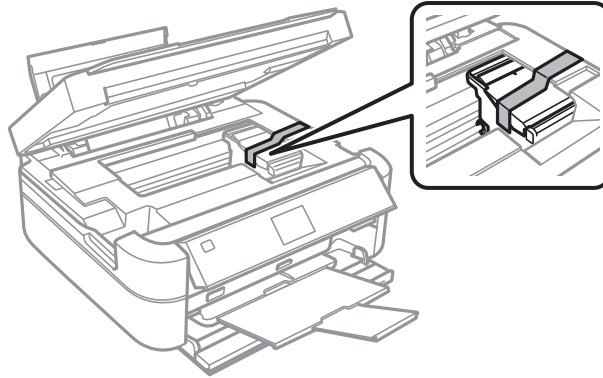

8. Close the scanner unit.

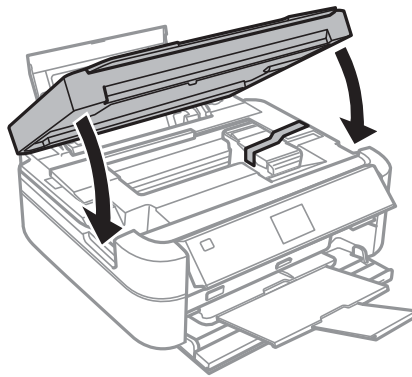

9. Prepare to pack the printer as shown below.

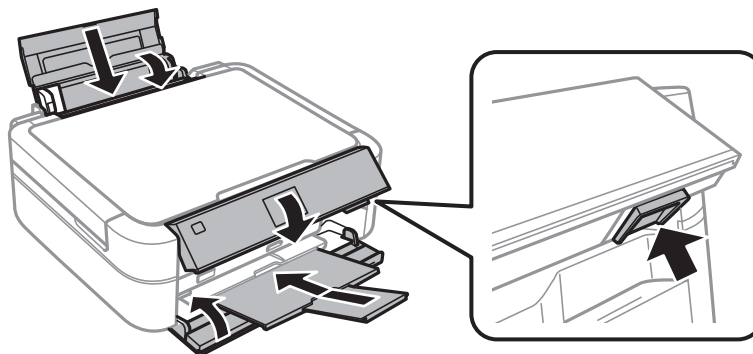

Appendix

10. Unhook the ink tank unit from the printer and lay it down, and then make sure to install the cap onto the ink tank securely.

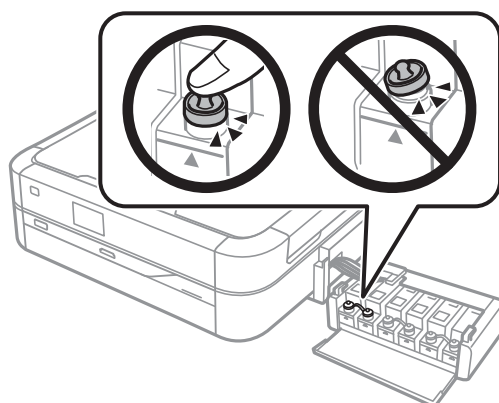

11. Hook the ink tank unit onto the printer.
12. Pack the printer in its box using the protective materials to prevent the ink tank from being unhooked.

When you use the printer again, make sure you remove the tape securing the print head. If print quality has declined the next time you print, clean and align the print head.

Related Information

- ➔ [“Part Names and Functions” on page 13](#)
- ➔ [“Checking and Cleaning the Print Head” on page 82](#)
- ➔ [“Aligning the Print Head” on page 85](#)

Accessing a Memory Card From a Computer

You can write or read data on an external storage device such as a memory card that has been inserted in the printer from a computer.

! Important:

- Insert a memory card after removing write protection.
- If an image is saved to the memory card from a computer, the image and the number of photos are not refreshed on the LCD screen. Remove and insert the memory card again.

Note:

It takes a while to recognize data from a computer if a large external storage device, such as 2TB HDD, is connected.

Windows

Select an external storage device in **Computer** or **My Computer**. The data on the external storage device is displayed.

Mac OS X

Select a corresponding device icon. The data on the external storage device is displayed.

Appendix

Note:

To remove an external storage device, drag the device icon to the trash icon. Otherwise, data in the shared drive may not be displayed correctly when another external storage device is inserted.

Related Information

- ➔ [“Inserting a Memory Card” on page 35](#)
- ➔ [“Supported Memory Card Specifications” on page 117](#)
- ➔ [“Supported External Storage Device Specifications” on page 118](#)

Where to Get Help

Technical Support Web Site

If you need further help, visit the Epson support website shown below. Select your country or region and go to the support section of your local Epson website. The latest drivers, FAQs, manuals, or other downloadables are also available from the site.

<http://support.epson.net/>

<http://www.epson.eu/Support> (Europe)

If your Epson product is not operating properly and you cannot solve the problem, contact Epson support services for assistance.

Contacting Epson Support

Before Contacting Epson

If your Epson product is not operating properly and you cannot solve the problem using the troubleshooting information in your product manuals, contact Epson support services for assistance. If Epson support for your area is not listed below, contact the dealer where you purchased your product.

Epson support will be able to help you much more quickly if you give them the following information:

- Product serial number
(The serial number label is usually on the back of the product.)
- Product model
- Product software version
(Click **About**, **Version Info**, or similar button in the product software.)
- Brand and model of your computer
- Your computer operating system name and version
- Names and versions of the software applications you normally use with your product

Help for Users in Europe

Check your Pan-European Warranty Document for information on how to contact Epson support.

Appendix

Help for Users in Singapore

Sources of information, support, and services available from Epson Singapore are:

World Wide Web

<http://www.epson.com.sg>

Information on product specifications, drivers for download, Frequently Asked Questions (FAQ), Sales Enquiries, and Technical Support via e-mail are available.

Epson HelpDesk (Phone: (65) 6586 3111)

Our HelpDesk team can help you with the following over the phone:

- Sales enquiries and product information
- Product usage questions or problems
- Enquiries on repair service and warranty

Help for Users in Thailand

Contacts for information, support, and services are:

World Wide Web

<http://www.epson.co.th>

Information on product specifications, drivers for download, Frequently Asked Questions (FAQ), and e-mail are available.

Epson Hotline (Phone: (66) 2685-9899)

Our Hotline team can help you with the following over the phone:

- Sales enquiries and product information
- Product usage questions or problems
- Enquiries on repair service and warranty

Help for Users in Vietnam

Contacts for information, support, and services are:

Epson Hotline (Phone): 84-8-823-9239

Service Center: 80 Truong Dinh Street, District 1, Hochiminh City, Vietnam.

Help for Users in Indonesia

Contacts for information, support, and services are:

World Wide Web

<http://www.epson.co.id>

- Information on product specifications, drivers for download
- Frequently Asked Questions (FAQ), Sales Enquiries, questions through e-mail

Appendix

Epson Hotline

Sales enquiries and product information

Technical support

Phone: (62) 21-572 4350

Fax: (62) 21-572 4357

Epson Service Center

| | | |
|------------|--|---|
| Jakarta | Mangga Dua Mall 3rd floor No 3A/B Jl. Arteri Mangga Dua, Jakarta | Phone/Fax: (62) 21-62301104 |
| Bandung | Lippo Center 8th floor Jl. Gatot Subroto No.2 Bandung | Phone/Fax: (62) 22-7303766 |
| Surabaya | Hitech Mall It IIB No. 12 Jl. Kusuma Bangsa 116-118 Surabaya | Phone: (62) 31-5355035 Fax: (62)31-5477837 |
| Yogyakarta | Hotel Natour Garuda Jl. Malioboro No. 60 Yogyakarta | Phone: (62) 274-565478 |
| Medan | Wisma HSBC 4th floor Jl. Diponegoro No. 11 Medan | Phone/Fax: (62) 61-4516173 |
| Makassar | MTC Karebosi Lt. III Kav. P7-8 Jl. Ahmad Yani No.49 Makassar | Phone: (62)411-350147/411-350148 |

Help for Users in Hong Kong

To obtain technical support as well as other after-sales services, users are welcome to contact Epson Hong Kong Limited.

Internet Home Page

Epson Hong Kong has established a local home page in both Chinese and English on the Internet to provide users with the following information:

Product information

Answers to Frequently Asked Questions (FAQs)

Latest versions of Epson product drivers

Users can access our World Wide Web home page at:

<http://www.epson.com.hk>

Appendix

Technical Support Hotline

You can also contact our technical staff at the following telephone and fax numbers:

Phone: (852) 2827-8911

Fax: (852) 2827-4383

Help for Users in Malaysia

Contacts for information, support, and services are:

World Wide Web

<http://www.epson.com.my>

- Information on product specifications, drivers for download
- Frequently Asked Questions (FAQ), Sales Enquiries, questions through e-mail

Epson Trading (M) Sdn. Bhd.

Head Office:

Phone: 603-56288288

Fax: 603-56288388/399

Epson Helpdesk:

- Sales enquiries and product information (Infoline)
Phone: 603-56288222
- Enquiries on repair services & warranty, product usage and technical support (Techline)
Phone: 603-56288333

Help for Users in India

Contacts for information, support, and services are:

World Wide Web

<http://www.epson.co.in>

Information on product specifications, drivers for download, and products enquiry are available.

Epson India Head Office - Bangalore

Phone: 080-30515000

Fax: 30515005

Epson India Regional Offices:

| Location | Telephone number | Fax number |
|----------|--------------------|--------------|
| Mumbai | 022-28261515/16/17 | 022-28257287 |
| Delhi | 011-30615000 | 011-30615005 |
| Chennai | 044-30277500 | 044-30277575 |

Appendix

| Location | Telephone number | Fax number |
|------------|--------------------------------|--------------|
| Kolkata | 033-22831589/90 | 033-22831591 |
| Hyderabad | 040-66331738/39 | 040-66328633 |
| Cochin | 0484-2357950 | 0484-2357950 |
| Coimbatore | 0422-2380002 | NA |
| Pune | 020-30286000/30286001/30286002 | 020-30286000 |
| Ahmedabad | 079-26407176/77 | 079-26407347 |

Helpline

For Service, Product info or to order a cartridge - 18004250011 (9AM - 9PM) - This is a Toll-free number.

For Service (CDMA & Mobile Users) - 3900 1600 (9AM - 6PM) Prefix local STD code

Help for Users in the Philippines

To obtain technical support as well as other after sales services, users are welcome to contact the Epson Philippines Corporation at the telephone and fax numbers and e-mail address below:

Trunk Line: (63-2) 706 2609

Fax: (63-2) 706 2665

Helpdesk Direct Line: (63-2) 706 2625

E-mail: epchelpdesk@epc.epson.com.ph

World Wide Web

<http://www.epson.com.ph>

Information on product specifications, drivers for download, Frequently Asked Questions (FAQ), and E-mail Enquiries are available.

Toll-Free No. 1800-1069-EPSON (37766)

Our Hotline team can help you with the following over the phone:

- Sales enquiries and product information
- Product usage questions or problems
- Enquiries on repair service and warranty