



Epson[®] SureColor[®] P700/P900 User's Guide

Contents

SureColor P700/P900 Series User's Guide	9
Introduction to Your Printer	10
Notations Used in the Documentation	10
Optional Equipment and Replacement Parts	10
Printer Part Locations	10
Product Parts - Front	11
Product Parts - Rear	12
Opening the Port Cover	13
Using the Control Panel	14
The LCD Screen	14
Network Status Icon Information	15
Entering Characters on the LCD Screen	16
Switching the Screen View	17
Adjusting the Control Panel Position	19
Changing the LCD Screen Language	19
Selecting the Date and Time	19
Adjusting Control Panel Sounds	20
Adjusting the Screen Brightness	20
Turning Off the Internal Light	20
Using Power Saving Settings	21
Changing the Sleep Timer Settings	21
Changing the Power Off Timer Settings	21
Using AirPrint	21
Wi-Fi or Wired Networking	23
Network Security Recommendations	23
Wi-Fi Infrastructure Mode Setup	24
Selecting Wireless Network Settings from the Control Panel	25
Wi-Fi Direct Mode Setup	26
Enabling Wi-Fi Direct Mode	26
Wi-Fi Protected Setup (WPS)	27

Using WPS to Connect to a Network	27
Printing a Network Status Sheet.....	28
Printing a Network Connection Report	28
Network Connection Report Codes and Messages	29
Changing or Updating Network Connections	34
Accessing the Web Config Utility.....	34
Changing a USB Connection to a Wi-Fi Connection.....	35
Changing a Wi-Fi Connection to a Wired Network Connection.....	35
Connecting to a New Wi-Fi Router	35
Disabling Wi-Fi Features	36
Loading Media	37
Loading Media in the Rear Paper Feeder.....	37
Loading Media in the Front Paper Feeder	39
Loading Roll Paper.....	41
Cutting and Removing Roll Paper	42
Loading a CD/DVD.....	42
Removing a Printed CD/DVD	43
Media Loading Capacity.....	44
Available Epson Papers	49
Borderless Paper Type Compatibility	56
Paper or Media Type Settings - Product Software.....	57
Selecting the Paper Settings for Each Source - Control Panel	57
Paper or Media Type Settings - Control Panel.....	58
Printing from a Computer	60
Printing with Windows	60
Selecting Basic Print Settings - Windows	60
Paper Configuration Options - Windows	63
Advanced B&W Photo Options - Windows.....	63
Print Quality Options - Windows	64
Color Management Options - Windows	65
Advanced Color Controls - Windows	66
Paper Source Options - Windows	66
Using Layout Manager - Windows	68

Selecting Print Layout Options - Windows	74
Reduce/Enlarge Options - Windows	75
Multi-Page Printing Options - Windows	75
Selecting Additional Settings - Windows	76
Saving, Sharing, and Customizing the Printer Settings	78
Saving and Sharing Print Settings - Windows	78
Saving and Sharing Media Settings - Windows	80
Editing Print Setting Displays - Windows	81
Printing Your Document - Windows	84
Checking Print Status - Windows	85
Selecting Default Print Settings - Windows	85
Changing the Language of the Printer Software Screens	87
Changing Automatic Update Options	88
Printing on a Mac	89
Selecting Basic Print Settings - Mac	89
Advanced Color Settings - Mac	95
Print Quality Settings - Mac	99
Print Options - Mac	99
Selecting Roll Paper Settings - Mac	100
Managing Color - Mac	101
Color Matching Options - Mac	102
Selecting Paper Configuration Settings - Mac	103
Selecting Print Layout Options - Mac	103
Sizing Printed Images - Mac	104
Selecting Printing Preferences - Mac	105
Printing Preferences - Mac	105
Printing Your Document or Photo - Mac	106
Checking Print Status - Mac	107
Using the Control Panel Menus	109
Accessing the Printer's Menus	109
Maintenance Menu	110
Screen Customization Menu	111
Printer Settings Menu	111

Basic Settings Menu.....	112
Network Settings Menu	113
Restore Default Settings Menu	114
Printer Status/Print Menu	114
Replacing Ink Cartridges and Maintenance Boxes.....	116
Checking Ink Cartridge and Maintenance Box Status on the LCD Screen	116
Purchase Epson Ink Cartridges and Maintenance Box	116
Ink Cartridge and Maintenance Box Part Numbers.....	117
Removing and Installing Ink Cartridges.....	117
Maintenance Box Replacement	123
Adjusting Print Quality.....	124
Print Head Maintenance.....	124
Print Head Nozzle Check.....	124
Checking the Nozzles Using the Product Control Panel	124
Checking the Nozzles Using a Computer Utility	125
Print Head Cleaning	127
Cleaning the Print Head Using the Product Control Panel	127
Cleaning the Print Head Using a Computer Utility.....	129
Running a Power Cleaning Using the Product Control Panel.....	130
Print Head Alignment	131
Aligning the Print Head Using the Product Control Panel	131
Aligning the Print Head Using a Computer Utility.....	132
Cleaning the Paper Guide	133
Maintenance and Transportation	134
Cleaning Your Product	134
Transporting Your Product	134
Solving Problems	136
Checking for Software Updates.....	136
Product Status Messages	137
Running a Product Check	138
Resetting Control Panel Defaults	139
Solving Setup Problems	139

Noise After Ink Installation	139
Software Installation Problems	140
Solving Network Problems	140
Product Cannot Connect to a Wireless Router or Access Point	140
Network Software Cannot Find Product on a Network.....	142
Product Does Not Appear in Mac Printer Window	143
Cannot Print Over a Network.....	143
Solving Paper Problems	144
Paper Feeding Problems	145
Paper Ejection Problems	146
Solving Problems Printing from a Computer.....	146
Nothing Prints	146
Product Icon Does Not Appear in Windows Taskbar	147
Error After Cartridge Replacement	147
Printing is Slow	148
Solving Page Layout and Content Problems	149
Inverted Image.....	149
Too Many Copies Print	150
Blank Pages Print	150
Incorrect Margins on Printout.....	150
Border Appears on Borderless Prints	150
Incorrect Characters Print.....	151
Incorrect Image Size or Position	151
Slanted Printout.....	152
Solving Print Quality Problems	152
White or Dark Lines in Printout	152
Blurry or Smearred Printout	153
Faint Printout or Printout Has Gaps	153
Grainy Printout.....	154
Incorrect Colors	154
Uninstall Your Product Software.....	155
Uninstalling Printing Software - Windows	155
Uninstalling Product Software - Mac.....	156

Where to Get Help.....	157
Technical Specifications	158
Windows System Requirements	158
OS X System Requirements.....	159
Paper Specifications	159
Printable Area Specifications	160
Ink Specifications	163
Dimension Specifications	164
Electrical Specifications	165
Environmental Specifications	166
Interface Specifications	166
Network Interface Specifications	166
Safety and Approvals Specifications	167
Safety and Approvals Specifications for Latin America	168
Notices	170
Important Safety Instructions.....	170
General Printer Safety Instructions.....	170
Ink Cartridge Safety Instructions.....	171
LCD Screen Safety Instructions.....	172
Wireless Connection Safety Instructions	173
Important Privacy Notice (Printer Serial Number).....	173
Binding Arbitration and Class Waiver	174
FCC Compliance Statement.....	177
Trademarks	178
Copyright Notice.....	178
A Note Concerning Responsible Use of Copyrighted Materials.....	179
Default Delay Times for Power Management for Epson Products	179
Copyright Attribution	179

SureColor P700/P900 Series User's Guide

Welcome to the SureColor P700/P900 Series *User's Guide*.

For a printable PDF copy of this guide, [click here](#).

Introduction to Your Printer

Refer to these sections to learn more about your printer and this manual.

[Notations Used in the Documentation](#)

[Optional Equipment and Replacement Parts](#)

[Printer Part Locations](#)

[Using the Control Panel](#)

[Using AirPrint](#)

Notations Used in the Documentation

Follow the guidelines in these notations as you read your documentation:

- **Warnings** must be followed carefully to avoid bodily injury.
- **Cautions** must be observed to avoid damage to your equipment.
- **Notes** contain important information about your printer.
- **Tips** contain additional printing information.

Parent topic: [Introduction to Your Printer](#)

Optional Equipment and Replacement Parts

You can purchase genuine Epson ink, paper, and accessories from an Epson authorized reseller. To find the nearest reseller, visit proimaging.epson.com (U.S.) or proimaging.epson.ca (Canada), select your product series and product, and click the **Where to Buy** button. Or call 800-GO-EPSON (800-463-7766) in the U.S. or 800-807-7766 in Canada.

Option or part	Part number
Roll media adapter (SureColor P900)	C12C935221
Maintenance box	C12C935711

In addition to the accessories listed above, extended service plans are available.

Parent topic: [Introduction to Your Printer](#)

Printer Part Locations

Check the printer part illustrations to learn about the parts on your printer.

Product Parts - Front

Product Parts - Rear

Opening the Port Cover

Parent topic: Introduction to Your Printer

Product Parts - Front

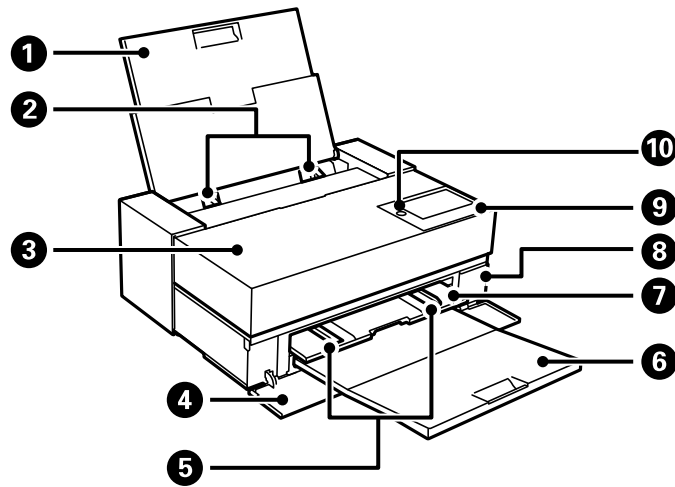

- 1 Rear paper feeder
- 2 Edge guides
- 3 Printer cover
- 4 Front cover
- 5 Edge guides
- 6 Output tray
- 7 Front paper feeder
- 8 Maintenance box cover
- 9 Control panel
- 10  power button and light

Parent topic: [Printer Part Locations](#)

Product Parts - Rear

SureColor P700

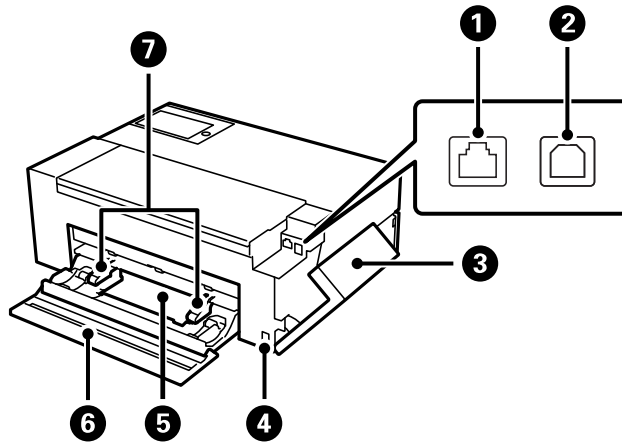

- 1 LAN port
- 2 USB port
- 3 Port cover
- 4 AC inlet
- 5 Roll paper unit
- 6 Rear cover
- 7 Edge guides

SureColor P900

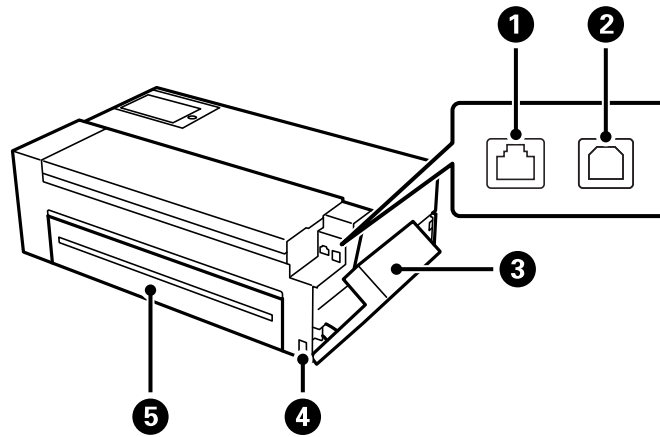

- 1 LAN port
- 2 USB port
- 3 Port cover
- 4 AC inlet
- 5 Rear cover

Parent topic: [Printer Part Locations](#)

Opening the Port Cover

You can access the ports by opening the rear paper feeder first and then the port cover.

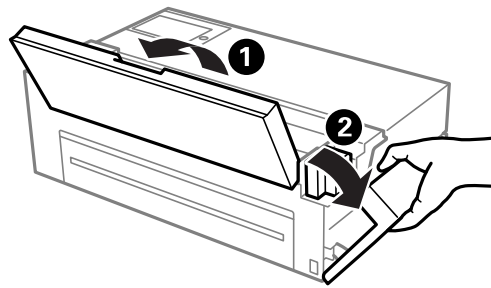

Parent topic: [Printer Part Locations](#)

Using the Control Panel

See these sections to learn about the control panel and select control panel settings.

[The LCD Screen](#)

[Adjusting the Control Panel Position](#)

[Changing the LCD Screen Language](#)

[Selecting the Date and Time](#)

[Adjusting Control Panel Sounds](#)

[Adjusting the Screen Brightness](#)

[Turning Off the Internal Light](#)

[Using Power Saving Settings](#)

Parent topic: [Introduction to Your Printer](#)

The LCD Screen

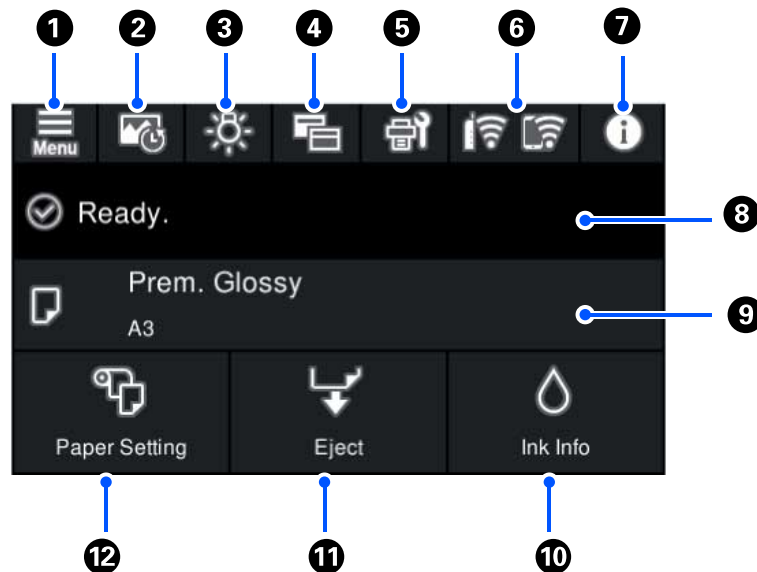

1 Displays the menu screen to adjust printer settings

- 2 Displays your print history
- 3 Turns on or off the printer's interior light
- 4 Switches the screen view to display additional information
- 5 Displays the maintenance settings
- 6 Displays the network connection status
- 7 Displays notifications
- 8 Displays the printer's status
- 9 Displays the paper settings
- 10 Displays the ink and maintenance box levels
- 11 Ejects loaded paper
- 12 Selects paper size and type settings

[Network Status Icon Information](#)





[Entering Characters on the LCD Screen](#)



[Switching the Screen View](#)

Parent topic: [Using the Control Panel](#)

Network Status Icon Information

Your product displays status icons on the LCD screen for certain network status conditions.

Icons	Description
	The product is not connected to a wired (Ethernet) network.
	The product is connected to a wired (Ethernet) network.
	The product is not connected to a wireless (Wi-Fi) network.
	The product is searching for an SSID or experiencing a wireless network connection issue.
	The product is connected to a wireless (Wi-Fi) network; the number of bars indicates the connection's signal strength.

Icons	Description
	Wi-Fi Direct is not enabled.
	Wi-Fi Direct is enabled.

Parent topic: [The LCD Screen](#)

Entering Characters on the LCD Screen

Follow these guidelines to enter characters for passwords and other settings.

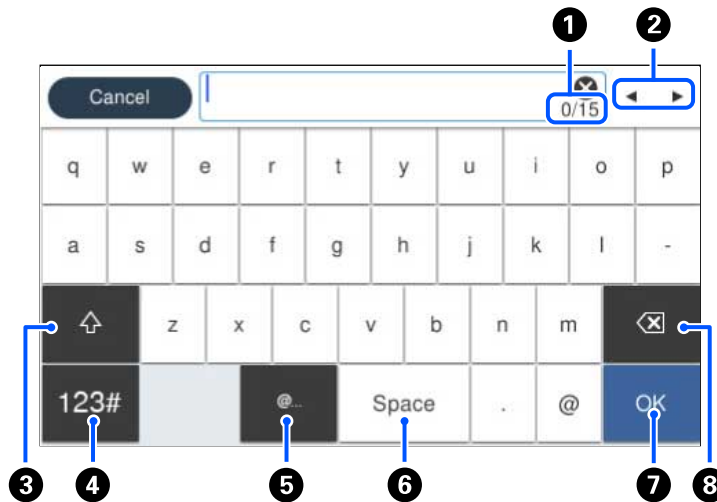

- 1 Displays the character count
- 2 Moves the cursor left or right
- 3 Switches between uppercase and lowercase characters, numbers and symbols
- 4 Switches between characters and numbers or symbols
- 5 Displays a list of common domain names to choose from
- 6 Enters a space
- 7 Select when you are finished
- 8 Deletes the previous character

Parent topic: [The LCD Screen](#)

Switching the Screen View

You can select  to switch between the home screen and printing screen.

Home screen

Default screen

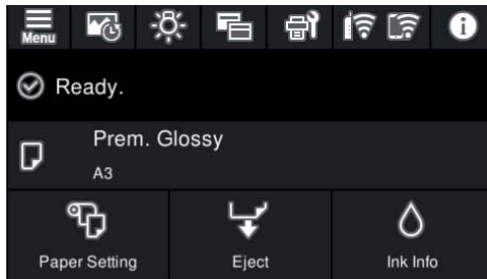

Ink and maintenance box levels screen

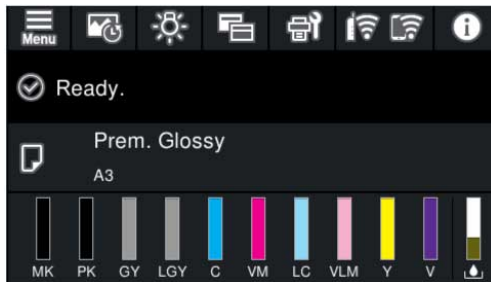

Printing screen

Photo display screen (displays thumbnails of images you print using the printer driver and Epson Print Layout).

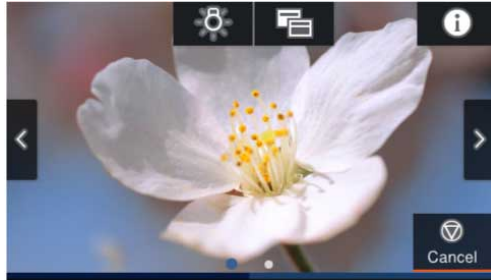

Print status screen (displays ink levels and progress bar when printing).

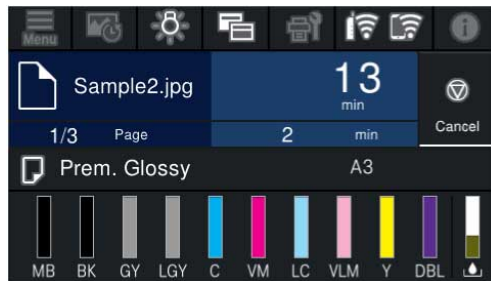

Print setting screen (displays print settings for the printer driver and Epson Print Layout).

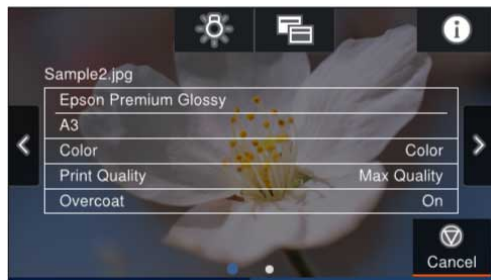

Parent topic: [The LCD Screen](#)

Adjusting the Control Panel Position

You can adjust the position of the control panel to make it easier to access. Raise or lower it to the desired angle.

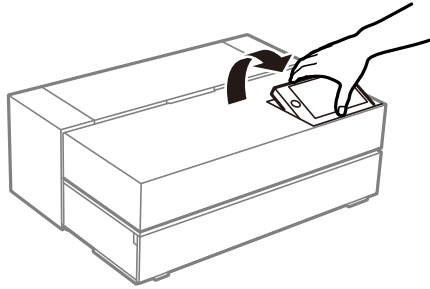

Parent topic: [Using the Control Panel](#)

Changing the LCD Screen Language

You can change the language used on the LCD screen.

1. Select the  icon.
2. Select **General Settings > Basic Settings > Language**.
3. Select a language.

Parent topic: [Using the Control Panel](#)

Selecting the Date and Time

You can select the current date, time, and daylight saving phase in your area, and choose your preferred date and time format.

1. Select the  icon.
2. Select **General Settings > Basic Settings > Date/Time Settings**.
3. Change any of these settings as necessary:
 - **Date/Time:** Selects the date and time.
 - **Daylight Saving Time:** Selects between summer or winter daylight saving time.

- **Time Difference:** Adjusts the time difference between your local time and UTC (Coordinated Universal Time).

Parent topic: [Using the Control Panel](#)

Adjusting Control Panel Sounds

You can adjust the sound level heard when you press buttons on the control panel or an error occurs.

1. Select the  icon.
2. Select **General Settings > Basic Settings > Sounds**.
3. Change any of these settings as necessary:
 - **Mute:** Turns on or off all sound from the product.
 - **Button Press:** Adjusts the sound volume heard when pressing a button.
 - **Error Tone:** Adjusts the sound volume heard when a product error occurs.
 - **Sound Type:** Changes the type of sound heard.

Parent topic: [Using the Control Panel](#)

Adjusting the Screen Brightness



You can adjust the brightness of the LCD screen.

1. Select the  icon.
2. Select **General Settings > Basic Settings > LCD Brightness**.
3. Press the – or + icons to decrease or increase the brightness.
4. Select **OK** to exit.

Parent topic: [Using the Control Panel](#)

Turning Off the Internal Light

The printer's internal light turns on during printing but you can turn it off.

1. Select the  icon.
2. Select **General Settings > Basic Settings > Inside Light**.
3. Select from the following options:
 - **Auto:** Turns on the internal light automatically during printing.
 - **Manual:** Turns the light on or off only when you press the  icon.

Parent topic: [Using the Control Panel](#)

Using Power Saving Settings

Your product enters sleep mode automatically and turns off the LCD screen if it is not used for a period of time. You can make the time period shorter and select other options to save energy and resources.

[Changing the Sleep Timer Settings](#)

[Changing the Power Off Timer Settings](#)

Parent topic: [Using the Control Panel](#)

Changing the Sleep Timer Settings

You can adjust the time period before your product enters sleep mode and turns off the LCD screen.

1. Select the  icon.
2. Select **General Settings > Basic Settings > Sleep Timer**.
3. Select the length of time before your product enters sleep mode.

Parent topic: [Using Power Saving Settings](#)

Changing the Power Off Timer Settings

You can have the product turn off automatically if it is not used for a specified period of time.

1. Select the  icon.
2. Select **General Settings > Basic Settings > Power Off Timer**.
3. Select when you want the product to automatically turn off.

Parent topic: [Using Power Saving Settings](#)

Using AirPrint

AirPrint enables instant wireless printing from iPhone, iPad, iPod touch, and Mac without the need to install drivers or download software.



1. Load paper in your product.

2. Set up your product for wireless printing. See the link below.
3. Connect your Apple device to the same wireless network that your product is using.
4. Print from your device to your product.

Note: For details, see the AirPrint page on the Apple website.

Parent topic: [Introduction to Your Printer](#)

Wi-Fi or Wired Networking

See these sections to use your product on a Wi-Fi or wired network.

[Network Security Recommendations](#)

[Wi-Fi Infrastructure Mode Setup](#)

[Wi-Fi Direct Mode Setup](#)

[Wi-Fi Protected Setup \(WPS\)](#)

[Printing a Network Status Sheet](#)

[Printing a Network Connection Report](#)

[Changing or Updating Network Connections](#)

Network Security Recommendations

To help deter unauthorized access to your product over a network, you should protect your network environment using appropriate security measures.

Security measures such as these can help deter threats such as loss of user data, use of telephone and fax lines, and other intrusions:

- **Enable security on your wireless LAN**

Enable the appropriate security on the wireless LAN you plan to use with your product. Network security such as a network password can deter interception of traffic over the wireless LAN. Your router may already have a default password enabled by your Internet service provider (ISP). See your ISP and router documentation for instructions on how to change the default password and better secure your network.

- **Connect your product only to a network protected by a firewall**

Connecting your product directly to the Internet may leave it vulnerable to security threats. Instead, connect it to a router or other network connection protected by a firewall. Your router may already have a firewall set up by your Internet service provider; check with your ISP for confirmation. For best results, set up and use a private IP address for your network connection.

- **Change the default administrator password on your product**

If your product has an option to set an administrator password, change the default administrator password to deter access by unauthorized users to personal data stored on your product, such as IDs, passwords, and contact lists.

Parent topic: [Wi-Fi or Wired Networking](#)

Wi-Fi Infrastructure Mode Setup

You can set up your product to communicate with your computer using a wireless router or access point. The wireless router or access point can be connected to your computer over a wireless or wired network.

Note: You cannot connect to a wired and wireless network at the same time.

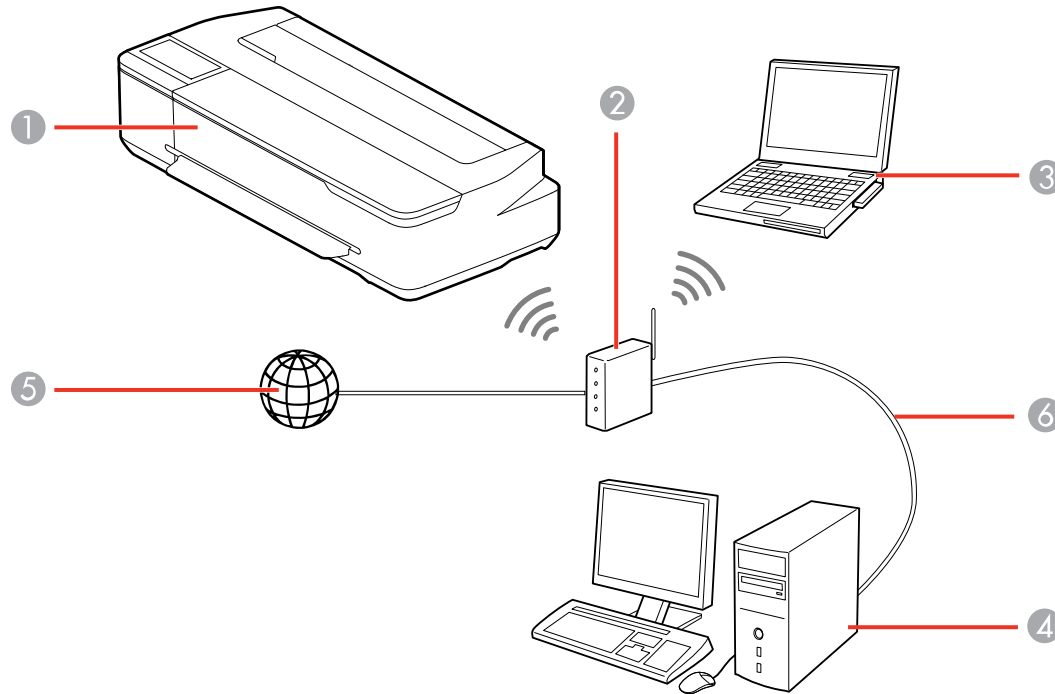

- 1 Epson product
- 2 Wireless router or access point
- 3 Computer with a wireless interface
- 4 Computer
- 5 Internet
- 6 Ethernet cable (used only for wired connection to the wireless router or access point)

Selecting Wireless Network Settings from the Control Panel

Parent topic: [Wi-Fi or Wired Networking](#)

Selecting Wireless Network Settings from the Control Panel



You can select or change wireless network settings using your product control panel.

To install your product on a wireless network, install the necessary print driver software package by downloading it from the Epson website. The installer program guides you through network setup.

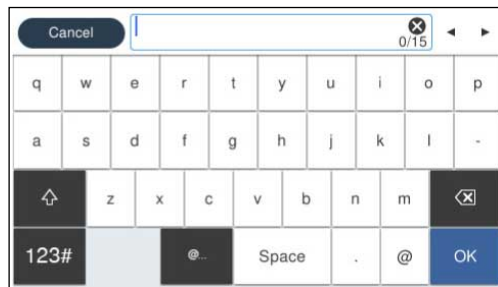
1. Select the  icon.
2. Select **Wi-Fi (Recommended) > Start Setup** or **Change Settings > Wi-Fi Setup Wizard**.
3. Select the name of your wireless network or select **Enter Manually** to enter the name manually. Use the on-screen keyboard to enter your network name.
4. Select the **Enter Password** field and enter your wireless password using the on-screen keyboard.



Note: The network name and password are case sensitive. Be sure to correctly enter uppercase and lowercase letters, and numeric or special characters.

- To move the cursor, press the left or right arrows.
 - To enter numbers or symbols, select **123#**.
 - To change the case of letters, select .
 - To delete the previous character, select .
 - To enter a space, select **Space**.
5. Select **OK** when you finish entering your password.

6. Confirm the displayed network settings and select **Start Setup** to save them.

Parent topic: [Wi-Fi Infrastructure Mode Setup](#)

Wi-Fi Direct Mode Setup

You can set up your product to communicate directly with your computer or another device without requiring a wireless router or access point. In Wi-Fi Direct Mode, the product itself acts as a network access point for up to 8 devices.

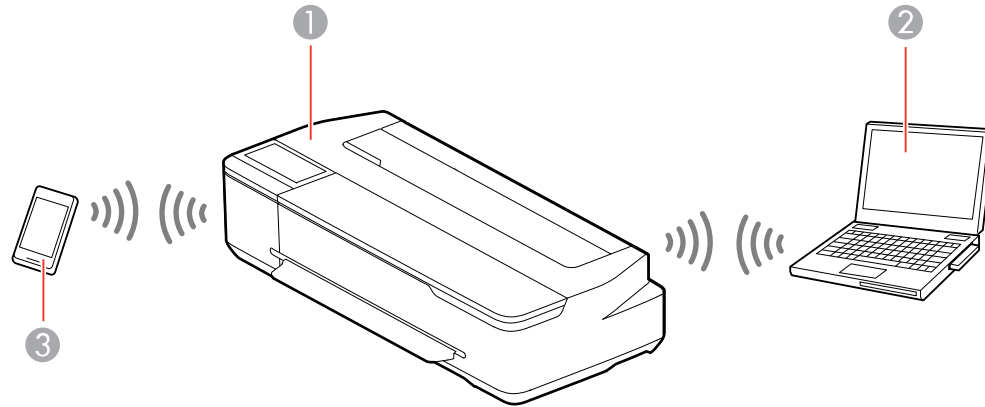

- 1 Epson product
- 2 Computer with a wireless interface
- 3 Other wireless device

[Enabling Wi-Fi Direct Mode](#)

Parent topic: [Wi-Fi or Wired Networking](#)

Enabling Wi-Fi Direct Mode

You can enable Wi-Fi Direct mode to allow direct communication between your product and computer or other devices without a wireless router or access point.

1. Select the  icon.
2. Select **Wi-Fi Direct** > **Start Setup**.

3. Do one of the following to complete Wi-Fi Direct setup:
 - For iOS devices, select **iOS**. Scan the QR code with the camera app on your device and follow the instructions on your device. Select **Next** on the LCD screen to display your product information, then open the compatible Epson printing app on your device and select your product. Select **Complete** on the LCD screen.
 - For Android devices, select **Android**. Open the compatible Epson printing app on your device and select your product. Select **Complete** on the LCD screen.
 - For other types of devices, select **Other OS Devices**. Use your device to select the Wi-Fi network name (SSID) displayed on the LCD screen and enter the password shown. Select **Next** on the LCD screen to display your product information, then follow the instructions on the LCD screen.

Parent topic: [Wi-Fi Direct Mode Setup](#)

Wi-Fi Protected Setup (WPS)

If your network uses a WPS-enabled wireless router or access point, you can quickly connect your product to the network using Wi-Fi Protected Setup (WPS).

Note: To check if your router is WPS-enabled, look for a button labeled **WPS** on your router or access point. If there is no hardware button, there may be a virtual WPS button in the software for the device. Check your network product documentation for details.

[Using WPS to Connect to a Network](#)

Parent topic: [Wi-Fi or Wired Networking](#)

Using WPS to Connect to a Network

If you have a WPS-enabled wireless router or access point, you can use Wi-Fi Protected Setup (WPS) to connect your product to the network.

1. Select the  icon.
2. Select **Wi-Fi (Recommended) > Start Setup** or **Change Settings > Push Button Setup (WPS)**.
3. Hold down the WPS button on your wireless router until the security light flashes.
4. Follow the instructions on the LCD screen to complete WPS setup.

Parent topic: [Wi-Fi Protected Setup \(WPS\)](#)

Printing a Network Status Sheet

You can print a network status sheet to help you determine the causes of any problems you may have using your product on a network.

1. Select the  icon.
2. Select **General Settings > Network Settings > Network Status** .
3. Select **Print Status Sheet** .

Examine the settings shown on the network status sheet to diagnose any problems you have.

Parent topic: [Wi-Fi or Wired Networking](#)

Printing a Network Connection Report

You can print a network connection report to view solutions to any problems you may have using your product on a network.

1. Select the  icon.
2. Select **General Settings > Network Settings > Connection Check**.
The product checks your connection status.
3. Select **Print Check Report**.

Examine the error codes and solutions shown on the network connection report.

[Network Connection Report Codes and Messages](#)

Parent topic: [Wi-Fi or Wired Networking](#)

Network Connection Report Codes and Messages

Check the error codes and messages on the network connection report to solve problems you may encounter with network connections. The tables here list solutions to problems based on the error codes and messages that may appear on the top of the report.

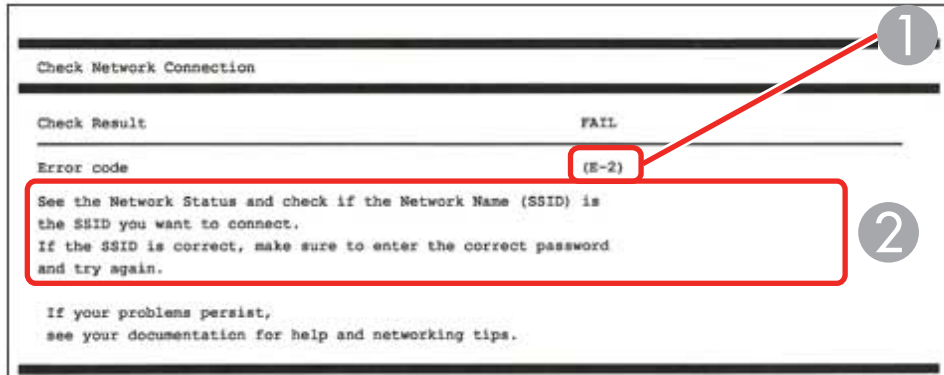

- 1 Error code
- 2 Message

Note: Error codes and messages listed here may not all apply to your product.

Error Codes and Messages

Error code and message	Solution
E-1 Confirm that the network cable is connected and network devices such as hub, router, or access point are turned on.	Make sure your router, access point, and/or hub are turned on, and the network cable is securely connected to your device and to your product. If you are trying to set up Wi-Fi, remove the network cable and set up Wi-Fi again. Ethernet and Wi-Fi cannot be connected at the same time.

Error code and message	Solution
<p>E-2, E-3, or E-7</p> <p>No wireless network names (SSID) found. Confirm that the router/access point is turned on and the wireless network (SSID) is set up correctly. Contact your network administrator for assistance.</p> <p>No wireless network names (SSID) found. Confirm that the wireless network name (SSID) of the PC you wish to connect is set up correctly. Contact your network administrator for assistance.</p> <p>Entered security key/password does not match the one set for your router/access point. Confirm security key/password. Contact your network administrator for assistance.</p>	<p>Check the following:</p> <ul style="list-style-type: none"> • Make sure your router or access point is turned on, and is correctly connected to your computer or network device. • Turn off the router or access point, wait about 10 seconds, and turn it on again. • Move your product closer to your router or access point, and remove any obstacles between them. Also move your product away from devices such as wireless phones or microwaves. • Confirm that the SSID shown on the network connection report matches the label on your router or access point. Also make sure your SSID uses only ASCII characters and symbols, or your product cannot display the SSID correctly. • If you are trying to connect using the WPS push button method, make sure your router or access point supports it. • If you are using a network password, check the label on your router or access point to confirm that you are using the correct password, or check with your network administrator or router/access point documentation. • If you are connecting to a smart device that generates an SSID, check the device documentation for the SSID and password you should use. • If your wireless connection suddenly disconnects, and another smart device was added to the network using a WPS push button method or your network was set up using a non-WPS push button method, try downloading and installing your product software again. • Check to see if you have the latest firmware installed.

Error code and message	Solution
<p>E-5 Security mode (e.g. WEP, WPA) does not match the current setting of the printer. Confirm security mode. Contact your network administrator for assistance.</p>	<p>If the security on your router or access point is not one of the following types, change the type of security on your router or access point and reset your product's network settings.</p> <ul style="list-style-type: none"> • WEP-64 bit (40 bit) • WEP-128 bit (104 bit) • WPA PSK (TKIP/AES); also known as WPA Personal • WPA2 PSK (TKIP/AES); also known as WPA2 Personal • WPA (TKIP/AES) • WPA2 (TKIP/AES) <p>Latin America: Also make sure you are connecting to the 2.4GHz band on your network and using the password for that band.</p>
<p>E-6 MAC address of your printer may be filtered. Check whether your router/access point has restrictions such as MAC address filtering. See the documentation of the router/access point or contact your network administrator for assistance.</p>	<p>If your router or access point has MAC address filtering enabled, register your product's MAC address so it is not filtered. Locate the MAC address on the network connection report and check your router or access point documentation for instructions.</p> <p>If your router or access point is using shared authentication with WEP security, confirm that you are using the correct authentication key and index.</p> <p>If your router or access point limits the number of connected devices, raise the connection limit. See your router or access point documentation for instructions.</p>
<p>E-8 Incorrect IP address is assigned to the printer. Confirm IP address setup of the network device (hub, router, or access point). Contact your network administrator for assistance.</p>	<p>If your product's Obtain IP Address setting is set to Auto, enable DHCP on your router or access point. If it is set to Manual, the IP address may be out of range or on a different network segment; set a valid IP address using your product control panel or the Web Config utility.</p> <p>You can also try turning off your product and the router or access point, waiting about 10 seconds, and turning them on again.</p>

Error code and message	Solution
<p>E-9 Confirm the connection and network setup of the PC or other device. Connection using the EpsonNet Setup is available. Contact your network administrator for assistance.</p>	<p>Make sure your computer or network device are turned on. Also make sure that you can access the Internet and other devices on the same network from the devices you are trying to connect to your product.</p> <p>If you still cannot connect to your product, turn off your router or access point, wait about 10 seconds, and turn it on again. Download and install your product software again to reset your network settings.</p>
<p>E-10 Confirm IP address, subnet mask, and default gateway setup. Connection using the EpsonNet Setup is available. Contact your network administrator for assistance.</p>	<p>Make sure other devices on the network are turned on and do the following:</p> <ul style="list-style-type: none"> • If your product's Obtain IP Address setting is set to Manual, check the IP address, subnet mask, and default gateway addresses on the network connection report to see if they are correct. If not, correct the settings. • If DHCP is enabled, set your product's Obtain IP Address setting to Auto. If you want to use the DHCP-assigned address as a static address, set the Obtain IP Address setting to Manual, enter the product's IP address as listed on the network connection report, and set the subnet mask to 255.255.255.0. <p>If you still cannot connect to your product, turn off your router or access point, wait about 10 seconds, and turn it on again.</p>
<p>E-11 Setup is incomplete. Confirm default gateway setup. Connection using the EpsonNet Setup is available. Contact your network administrator for assistance.</p>	<p>If you set your product's TCP/IP Setup setting to Manual, check that the default gateway address listed on the network connection report is correct. Also turn on the device that is set as the default gateway.</p>

Error code and message	Solution
<p>E-12</p> <p>Confirm the following:</p> <ul style="list-style-type: none"> -Entered security key/password is correct -Index of the security key/password is set to the first number -IP address, subnet mask, or default gateway setup is correct <p>Contact your network administrator for assistance.</p>	<p>Make sure other devices on the network are turned on and do the following:</p> <ul style="list-style-type: none"> • Make sure the IP address, subnet mask, and default gateway addresses are correct, if you are entering them manually. • Confirm that the subnet mask and default gateway addresses for other devices are the same. • Make sure the IP address does not conflict with other devices. <p>If you still cannot connect to your product, do the following:</p> <ul style="list-style-type: none"> • Turn off your router or access point, wait about 10 seconds, and turn it on again. • Download and install your product software again to reset your network settings. • If your router or access point uses WEP security with several registered passwords, make sure that the first registered password is set on your product.
<p>E-13</p> <p>Confirm the following:</p> <ul style="list-style-type: none"> -Entered security key/password is correct -Index of the security key/password is set to the first number -Connection and network setup of the PC or other device is correct <p>Contact your network administrator for assistance.</p>	<p>Make sure your router, access point, and/or hub are turned on. Also make sure the TCP/IP setup on your router, access point, and/or hub is not set manually; this may cause your product's network settings to differ from the manually set up devices.</p> <p>If you still cannot connect to your product, do the following:</p> <ul style="list-style-type: none"> • Turn off your router or access point, wait about 10 seconds, and turn it on again. • Download and install your product software again to reset your network settings. • If your router or access point uses WEP security with several registered passwords, make sure that the first registered password is set on your product.

Network Environment Messages

Message	Solution
The Wi-Fi environment needs to be improved. Turn the wireless router off and then turn it on. If the connection does not improve, see the documentation for the wireless router.	Move your product closer to your router or access point, and remove any obstacles between them. Then turn off your router or access point, wait about 10 seconds, and turn it back on again. If you still cannot connect to your product, check the documentation that came with your router or access point for solutions.
*No more devices can be connected. Disconnect one of the connected devices if you want to add another one.	You can connect up to 8 computers or other devices to your product using a Wi-Fi Direct (Simple AP) connection. If you want to add another device, disconnect an existing connected device first.
The same SSID as Wi-Fi Direct exists in the environment. Change the Wi-Fi Direct SSID if you cannot connect a smart device to the printer.	Change the Wi-Fi Direct SSID.

Parent topic: [Printing a Network Connection Report](#)

Changing or Updating Network Connections

See these sections to change or update how your product connects to a network.

[Accessing the Web Config Utility](#)

[Changing a USB Connection to a Wi-Fi Connection](#)

[Changing a Wi-Fi Connection to a Wired Network Connection](#)

[Connecting to a New Wi-Fi Router](#)

[Disabling Wi-Fi Features](#)

Parent topic: [Wi-Fi or Wired Networking](#)

Accessing the Web Config Utility

You can select your product's network settings and confirm its operating status using a web browser. You do this by accessing your product's built-in Web Config utility from a computer or other device that is connected to the same network as your product.

1. Print a network status sheet.
2. Locate the IP address for your product that is listed on the network status sheet.

3. On a computer or other device connected to the same network as your product, open a web browser.
4. Enter your product's IP address into the address bar.
You see the available Web Config utility options.

Parent topic: [Changing or Updating Network Connections](#)

Changing a USB Connection to a Wi-Fi Connection

If you have already connected your product to your computer using a USB connection, you can change to a Wi-Fi connection.

1. Disconnect the USB cable from your product.
2. Uninstall your product software.
3. Download and install your product software from the Epson website using the instructions on the *Start Here* sheet.

Parent topic: [Changing or Updating Network Connections](#)

Changing a Wi-Fi Connection to a Wired Network Connection

If you have already connected your product to your computer wirelessly, you can change to a wired network connection if necessary.

1. Select the  icon.
2. Select **Description > Wired LAN Connection Method > Start Setup**.
The Wi-Fi connection is disabled.
3. Connect one end of an Ethernet network cable to the product's **LAN** port.
4. Connect the other end to any available LAN port on your router or access point.

Parent topic: [Changing or Updating Network Connections](#)

Connecting to a New Wi-Fi Router

If you change the wireless router you have been using on your network, you need to update your product's Wi-Fi connection to the new router.

Note for Latin America: If you are using a 5 GHz wireless router, set the router to operate in dual band (2.4 GHz and 5 GHz) mode. If your router uses a single network name (SSID) for both the 2.4 GHz and 5 GHz band, give each band its own network name (SSID) instead, such as Home Network 2.4 GHz and

Home Network 5 GHz. See your router documentation or contact your internet service provider for instructions.

1. Do one of the following:
 - **Windows:** Uninstall your product software.
 - **Mac:** Go to the next step.
2. Download and install your product software from the Epson website using the instructions on the *Start Here* sheet.

Parent topic: [Changing or Updating Network Connections](#)

Disabling Wi-Fi Features

You may need to disable your product's Wi-Fi features if you change your network connection type or need to solve a problem with your network connection.

Note: Before disabling Wi-Fi features, make a note of your product's SSID (network name) and password.

1. Select the  icon.
2. Select **Wi-Fi (Recommended)** > **Start Setup** or **Change Settings** > **Others** > **Disable Wi-Fi**.
3. Select **Start Setup** to disable Wi-Fi.

Parent topic: [Changing or Updating Network Connections](#)

Loading Media

Before you print, load media for the type of printing you will do.

[Loading Media in the Rear Paper Feeder](#)

[Loading Media in the Front Paper Feeder](#)

[Loading Roll Paper](#)

[Loading a CD/DVD](#)

[Media Loading Capacity](#)

[Available Epson Papers](#)

[Borderless Paper Type Compatibility](#)

[Paper or Media Type Settings - Product Software](#)

[Selecting the Paper Settings for Each Source - Control Panel](#)

Loading Media in the Rear Paper Feeder

You can print on a variety of paper types and sizes from paper loaded in the sheet feeder.

1. Turn on your product.
2. Open the paper support and pull up the extensions.

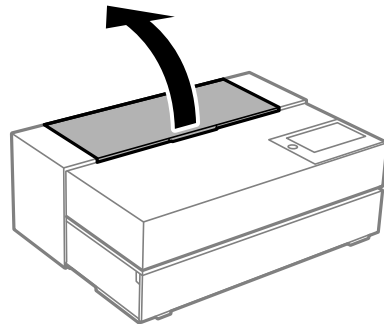

3. Open the front cover.

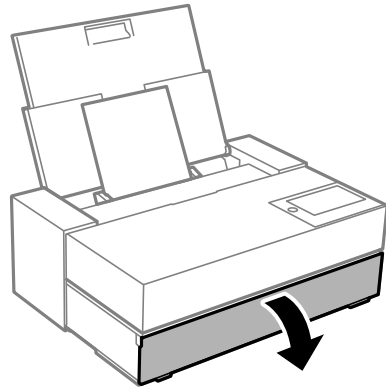

4. Load paper, glossy or printable side up and short edge first.

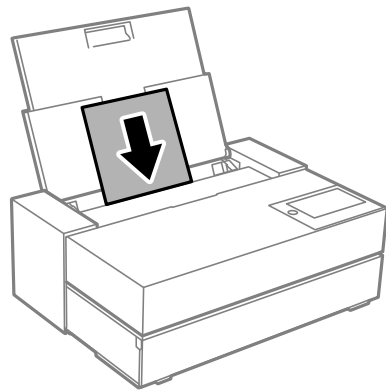

5. Slide the edge guides against the paper, but not too tightly.

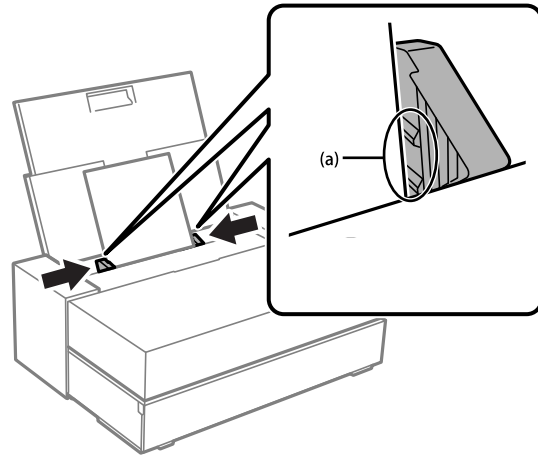

6. When prompted by LCD screen, select the size and type of the paper you loaded.

Always follow these paper loading guidelines:

- Load only the recommended number of sheets.
- Load paper short edge first, no matter which way your document faces.
- Load the printable side faceup.
- Load letterhead or pre-printed paper top edge first.
- Do not load paper above the arrow mark inside the edge guide.
- Check the paper package for any additional loading instructions.

Parent topic: [Loading Media](#)

Loading Media in the Front Paper Feeder

You can load fine art media, poster boards, and other thick media in the front paper feeder. You can load papers up to 0.011 inch (0.3 mm) thick.

Note: Leave at least the following amount of space behind the printer for ejected paper:

SureColor P700: 13 inches (330 mm)

SureColor P900: 16 inches (405 mm)

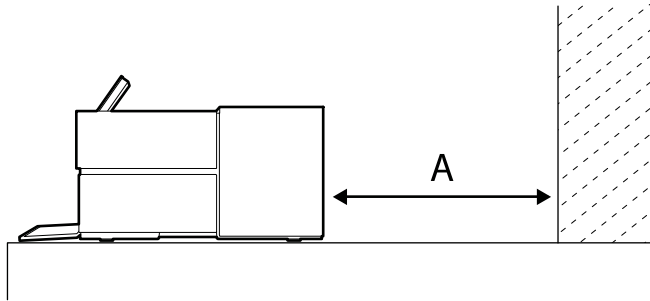

1. Select **Paper Setting** on the LCD screen.

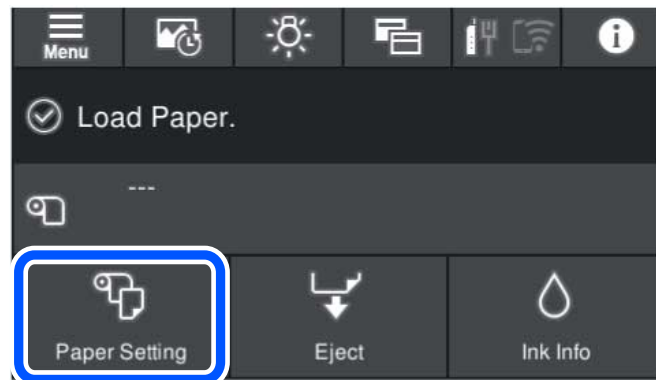

2. Select **Front Paper Feeder - Fine Art** or **Front Paper Feeder - Poster Board**.
3. Pull out the front paper feeder as instructed on the LCD screen.
4. Follow the rest of the on-screen instructions to load paper.
5. When prompted by the LCD screen, select the size and type of the paper you loaded.

Always follow these paper loading guidelines:

- Load only one sheet at a time.
- Load fine art media short edge first, no matter which way your document faces.
- Load the printable side faceup.
- Check the paper package for any additional loading instructions.

Parent topic: [Loading Media](#)

Loading Roll Paper

You can load roll paper into the SureColor P700. To load roll paper in the SureColor P900, you need to install the optional roll media adapter.

1. Select **Paper Setting** on the LCD screen.

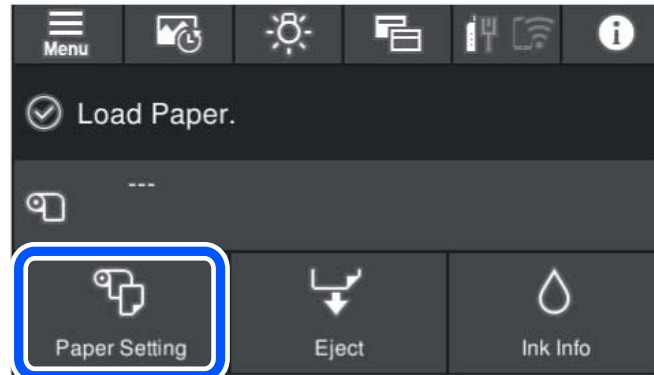

2. Select **Roll Paper**.
3. Pull out the roll paper unit as instructed on the LCD screen.
4. Follow the rest of the on-screen instructions to load paper.
5. When prompted by the LCD screen, select the size and type of the paper you loaded.

[Cutting and Removing Roll Paper](#)

Parent topic: [Loading Media](#)

Cutting and Removing Roll Paper

After printing on roll paper, use scissors as described here to cut your printout from the roll paper.

1. When printing is finished, select **Cut/Eject** on the LCD screen.
2. Select **Cut and Eject** to print a cut line and feed the paper.
3. Use scissors to cut the paper along the cut line.
4. Select **Done**.

The paper feeds back through the printer.

5. For SureColor P900 only, open the roll paper unit.

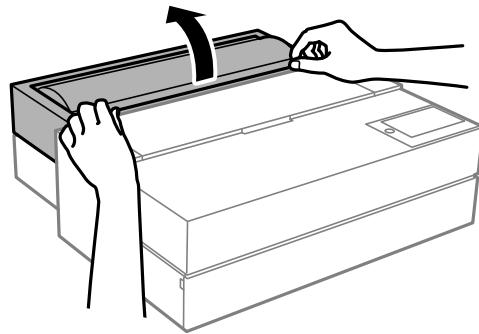

6. Remove the roll paper.

Store unused roll paper in its original packaging away from high temperatures, humidity, and direct sunlight.

Parent topic: [Loading Roll Paper](#)

Loading a CD/DVD

You can print on any compatible, ink jet-printable CDs or DVDs, including Blu-ray Discs.

Caution: Do not insert the disc tray while the product is printing, copying, or performing other operations. Otherwise, your product may be damaged or the surface of the CD/DVD may become dirty or scratched.

Note: If you are using discs where the printable area extends to within 0.16 inch (4 mm) of the center hole, you may need to adjust the inner diameter setting using the control panel.

1. Burn your files, music, or video onto your disc before printing on it.
2. Select **Paper Setting** on the LCD screen.

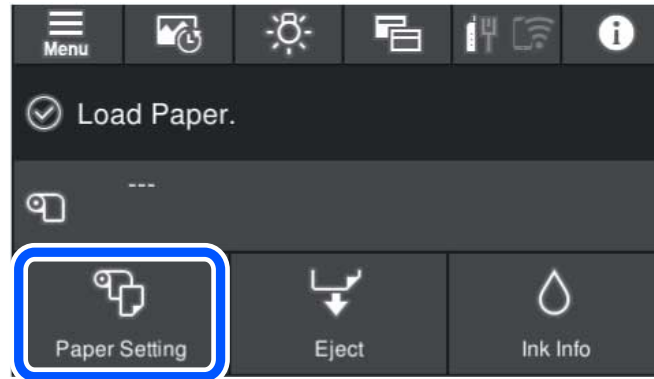

3. Select **Disc Tray**.
4. Pull out the front paper feeder as shown on the LCD screen.
5. Follow the rest of the on-screen instructions to load your disc.

Caution: Do not turn off the product with a CD or DVD loaded in it. Always remove the disc first.

[Removing a Printed CD/DVD](#)

Parent topic: [Loading Media](#)

Removing a Printed CD/DVD

After your CD or DVD is printed, the tray extends automatically.

Caution: Always remove the disc tray after printing. If you turn the product off and on again or perform a head cleaning without removing the tray, the print head may contact the CD/DVD tray and cause the product to malfunction.

1. Pull the disc tray out of the product and remove your CD or DVD from the tray.

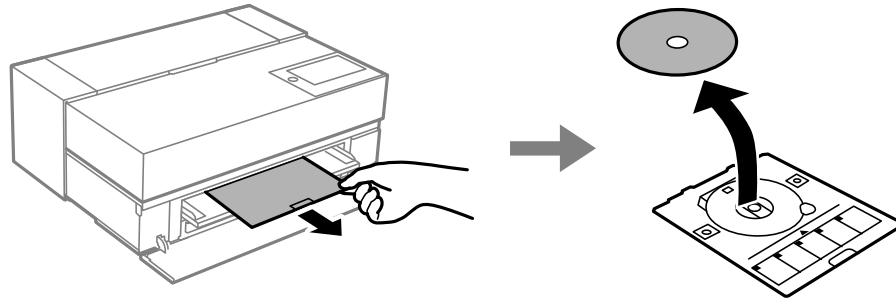

2. Close the front cover.

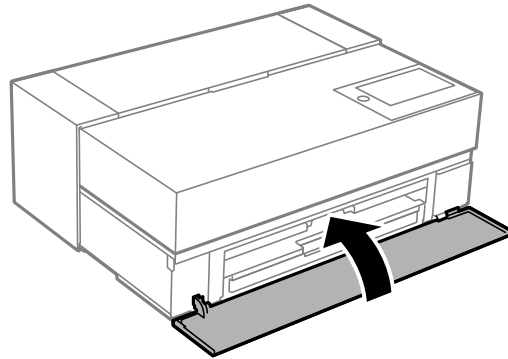

Caution: After printing, handle the CD or DVD carefully. You may need to wait up to 24 hours for the ink to dry fully before inserting it in a drive, depending on the type of disc you used. Keep printed discs away from moisture and direct sunlight.

Parent topic: [Loading a CD/DVD](#)

Media Loading Capacity

You can load media in the paper types and quantities listed here into your product.

Rear Paper Feeder

Paper type	Size	Loading capacity	Black ink type
Plain paper	Letter (8.5 × 11 inches [216 × 279 mm]), A3 (11.7 × 16.5 inches [297 × 420 mm]), A3+ (13 × 19 inches [329 × 483 mm]), B4 (13.9 × 9.84 inches [353 × 250 mm])	Up to about 0.2 inch (5 mm) total thickness	—
	Legal (8.5 × 14 inches [216 × 356 mm]), A4 (8.3 × 11.7 inches [210 × 297 mm]), B5 (7.2 × 10.1 inches [182 × 257 mm]), A5 (5.8 × 8.2 inches [148 × 210 mm]), A6 (4.1 × 5.8 inches [105 × 148 mm])	Up to about 0.47 inch (12 mm) total thickness	
	Non-standard sizes Width: 3.5 to 13 inches (89 to 329 mm) for SureColor P700 and 3.5 to 17 inches (89 to 432 mm) for SureColor P900 Length: 5 to 47.2 inches (127 to 1200 mm)	Up to about 0.2 inch (5 mm) total thickness	
Epson Bright White Pro Paper	A3 (11.7 × 16.5 inches [297 × 420 mm])	40 sheets	Matte Black
	Letter (8.5 × 11 inches [216 × 279 mm]), A4 (8.3 × 11.7 inches [210 × 297 mm])	80 sheets	

Paper type	Size	Loading capacity	Black ink type
Epson Premium Photo Paper Glossy	SureColor P900 only: A2 (16.5 × 23.4 inches [420 × 594 mm])	1	Photo Black
	A3 (11.7 × 16.5 inches [297 × 420 mm]), A3+ (13 × 19 inches [329 × 483 mm]), 10 × 12 inches (254 × 305 mm)	10 sheets	
	Letter (8.5 × 11 inches [216 × 279 mm]), A4 (8.3 × 11.7 inches [210 × 297 mm]), 16:9 wide (4 × 7.1 inches [102 × 181 mm])	20 sheets	
	4 × 6 inches (102 × 152 mm), 5 × 7 inches (127 × 178 mm)	30 sheets	
Epson Premium Photo Paper Semi-gloss	SureColor P900 only: A2 (16.5 × 23.4 inches [420 × 594 mm])	1	Photo Black
	A3 (11.7 × 16.5 inches [297 × 420 mm]), A3+ (13 × 19 inches [329 × 483 mm])	10 sheets	
	Letter (8.5 × 11 inches [216 × 279 mm]), A4 (8.3 × 11.7 inches [210 × 297 mm]), 5 × 7 inches (127 × 178 mm)	20 sheets	
	4 × 6 inches (102 × 152 mm)	30 sheets	

Paper type	Size	Loading capacity	Black ink type
Epson Photo Paper Glossy	Letter (8.5 × 11 inches [216 × 279 mm]), A4 (8.3 × 11.7 inches [210 × 297 mm]), 4 × 6 inches (102 × 152 mm), 5 × 7 inches (127 × 178 mm)	30 sheets	Photo Black
Epson Ultra Premium Photo Paper Glossy	SureColor P900 only: A2 (16.5 × 23.4 inches [420 × 594 mm])	1	Photo Black
	A3 (11.7 × 16.5 inches [297 × 420 mm]), A3+ (13 × 19 inches [329 × 483 mm]), 10 × 12 inches (254 × 305 mm)	10	
	Letter (8.5 × 11 inches [216 × 279 mm]), A4 (8.3 × 11.7 inches [210 × 297 mm]), 8 × 10 inches (203 × 254 mm), 4 × 6 inches (102 × 152 mm), 5 × 7 inches (127 × 178 mm), 3.5 × 5 inches (89 × 127 mm)	20	
Epson Premium Presentation Paper Matte	A3 (11.7 × 16.5 inches [297 × 420 mm]), A3+ (13 × 19 inches [329 × 483 mm])	10 sheets	Matte Black
	Letter (8.5 × 11 inches [216 × 279 mm]), A4 (8.3 × 11.7 inches [210 × 297 mm])	30 sheets	

Paper type	Size	Loading capacity	Black ink type
Epson Ultra Premium Photo Paper Luster	A3 (11.7 × 16.5 inches [297 × 420 mm]), A3+ (13 × 19 inches [329 × 483 mm])	10 sheets	Photo Black
	Letter (8.5 × 11 inches [216 × 279 mm]), A4 (8.3 × 11.7 inches [210 × 297 mm])	30 sheets	
Epson Presentation Paper Matte	A3 (11.7 × 16.5 inches [297 × 420 mm]), A3+ (13 × 19 inches [329 × 483 mm])	50 sheets	Matte Black
	Letter (8.5 × 11 inches [216 × 279 mm]), A4 (8.3 × 11.7 inches [210 × 297 mm])	60 sheets	
Epson Premium Presentation Paper Matte Double-sided	Letter (8.5 × 11 inches [216 × 279 mm]), A4 (8.3 × 11.7 inches [210 × 297 mm])	1 sheet	Matte Black
Epson Photo Quality Self-adhesive Sheets	Letter (8.5 × 11 inches [216 × 279 mm]), A4 (8.3 × 11.7 inches [210 × 297 mm])	1 sheet	Matte Black
Epson Proofing Paper White Semimatte	A3+ (13 × 19 inches [329 × 483 mm])	1 sheet	Photo Black

Front paper feeder

You can load one sheet of posterboard or other thick media 0.02 to 0.059 inch (0.51 to 1.5 mm) thick in the front paper feeder. You can also load one sheet of the following types of media:

- Epson Velvet Fine Art Paper
- Epson UltraSmooth Fine Art Paper
- Epson Watercolor Paper Radiant White
- Epson Exhibition Fiber Paper

- Epson Exhibition Watercolor Paper Textured
- Epson Hot Press Bright
- Epson Hot Press Natural
- Epson Cold Press Bright
- Epson Cold Press Natural

Parent topic: [Loading Media](#)

Available Epson Papers

You can purchase genuine Epson ink and paper at epson.com (U.S. sales), epson.ca (Canadian sales), or epson.com.jm (Caribbean sales). You can also purchase supplies from an Epson authorized reseller. To find the nearest one, call 800-GO-EPSON (800-463-7766) in the U.S. or 800-807-7766 in Canada.

Note: Paper/media availability varies by country.

Paper Type	Size	Part number	Sheet count
Epson Bright White Pro Paper	Letter (8.5 × 11 inches [216 × 279 mm])	S041586	500
Epson Cold Press Bright	Letter (8.5 × 11 inches [216 × 279 mm])	S041111	100
	Letter (8.5 × 11 inches [216 × 279 mm])	S042307	25
	13 × 19 inches (330 × 483 mm)	S042310	25
	17 × 22 inches (432 × 559 mm)	S042311	25
Epson Cold Press Natural	Letter (8.5 × 11 inches [216 × 279 mm])	S042297	25
	13 × 19 inches (330 × 483 mm)	S042300	25
	17 × 22 inches (432 × 559 mm)	S042301	25

Paper Type	Size	Part number	Sheet count
Epson Velvet Fine Art Paper	Letter (8.5 × 11 inches [216 × 279 mm])	S041636	20
	13 × 19 inches (330 × 483 mm)	S041637	20
	17 × 22 inches (432 × 559 mm)	S042097	25
Epson Exhibition Fiber Paper	Letter (8.5 × 11 inches [216 × 279 mm])	S045033	25
	13 × 19 inches (330 × 483 mm)	S045037	25
	17 × 22 inches (432 × 559 mm)	S045039	25
Epson Hot Press Bright	Letter (8.5 × 11 inches [216 × 279 mm])	S042327	25
	13 × 19 inches (330 × 483 mm)	S042330	25
	17 × 22 inches (432 × 559 mm)	S042331	25
Epson Hot Press Natural	Letter (8.5 × 11 inches [216 × 279 mm])	S042317	25
	13 × 19 inches (330 × 483 mm)	S042320	25
	17 × 22 inches (432 × 559 mm)	S042321	25
Epson Exhibition Watercolor Paper Textured	Letter (8.5 × 11 inches [216 × 279 mm])	S045486	25
	13 × 19 inches (330 × 483 mm)	S045487	20
	17 × 22 inches (432 × 559 mm)	S045488	25

Paper Type	Size	Part number	Sheet count
Epson Brochure & Flyer Paper Matte Double-sided	Letter (8.5 × 11 inches [216 × 279 mm])	S042384	150
Epson (Consumer) Sample Media Pack	Various sizes	SMP603	Various quantities
Epson Photo Quality Self-adhesive Sheets	A4 (8.3 × 11.7 inches [210 × 297 mm])	S041106	10
Photo Quality Ink Jet Cards	A6 (4.1 × 5.8 inches [105 × 148 mm])	S041054	50
Epson Ultra Premium Photo Paper Glossy	Letter (8.5 × 11 inches [216 × 279 mm])	S042175	20
	8 × 10 inches (203 × 254 mm)	S041946	20
Epson Premium Luster Photo Paper (260)	8.3 inches (211 mm) × 32 feet (9.8 m)	S041408	1 roll
	13 inches (330 mm) × 32 feet (9.8 m)	S041409	1 roll
	10 inches (254 mm) × 100 feet (30.5 m)	S042077	1 roll
Epson Metallic Photo Paper Glossy	Letter (8.5 × 11 inches [216 × 279 mm])	S045589	25
	13 × 19 inches (330 × 483 mm)	S045590	25
	17 × 22 inches (432 × 559 mm)	S045591	25
Epson Metallic Photo Paper Luster	Letter (8.5 × 11 inches [216 × 279 mm])	S045516	25
	13 × 19 inches (330 × 483 mm)	S045517	25
	17 × 22 inches (432 × 559 mm)	S045598	25

Paper Type	Size	Part number	Sheet count
Epson Photo Paper Glossy	Letter (8.5 × 11 inches [216 × 279 mm])	S041649	50
	11 × 17 inches (279 × 432 mm)	S041156	20
	13 × 19 inches (330 × 483 mm)	S041143	20
	Letter (8.5 × 11 inches [216 × 279 mm])	S041271	100
Epson Premium Photo Paper Glossy	Letter (8.5 × 11 inches [216 × 279 mm])	S041286	20
	A3 (11.7 × 16.5 inches [297 × 420 mm])	S041288	20
	13 × 19 inches (330 × 483 mm)	S041289	20
	Letter (8.5 × 11 inches [216 × 279 mm])	S041667	50
	11 × 17 inches (279 × 432 mm)	S041290	20
	4 × 6 inches (102 × 152 mm)	S041727	100
	5 × 7 inches (127 × 178 mm)	S041464	20
	8 × 10 inches (203 × 254 mm)	S041465	20
	11 × 14 inches (279 × 356 mm)	S041466	20
	17 × 22 inches (432 × 559 mm)	S042092	25

Paper Type	Size	Part number	Sheet count
Epson Premium Photo Paper Semi-gloss	4 × 6 inches (102 × 152 mm)	S041982	40
	Letter (8.5 × 11 inches [216 × 279 mm])	S041331	20
	13 × 19 inches (330 × 483 mm)	S041327	20
	8 × 10 inches (203 × 254 mm)	S041467	50
	Letter (8.5 × 11 inches [216 × 279 mm])	S041257	50
	11 × 14 inches (279 × 356 mm)	S041468	50
	A3 (11.7 × 16.5 inches [297 × 420 mm])	S041260	50
	13 × 19 inches (330 × 483 mm)	S041263	50
	17 × 22 inches (432 × 559 mm)	S042124	25
Epson Premium Presentation Paper Matte Double-sided	Letter (8.5 × 11 inches [216 × 279 mm])	S041568	50
Epson Premium Presentation Paper Matte	Letter (8.5 × 11 inches [216 × 279 mm])	S041062	100
	Legal (8.5 × 14 inches [216 × 356 mm])	S041067	100
	11 × 17 inches (279 × 432 mm)	S041070	100
	13 × 19 inches (330 × 483 mm)	S041069	100
	16.5 × 23.4 inches (420 × 594 mm)	S041079	30
	17 × 22 inches (432 × 559 mm)	S041171	100

Paper Type	Size	Part number	Sheet count
Epson Proofing Paper White Semimatte	13 × 19 inches (330 × 483 mm)	S045115	100
	13 inches (300 mm) × 100 feet (30.5 m)	S042002	1 roll
Epson Standard Proofing Paper Publication	13 inches (300 mm) × 100 feet (30.5 m)	S041996	1 roll
Epson Standard Proofing Paper Commercial	13 inches (300 mm) × 100 feet (30.5 m)	S042144	1 roll
Epson Signature Worthy Sample Pack	Letter (8.5 × 11 inches [216 × 279 mm])	S045234	14
Epson Standard Proofing Paper (240)	13 × 19 inches (330 × 483 mm)	S045115	100
Epson Ultra Premium Photo Paper Luster	Letter (8.5 × 11 inches [216 × 279 mm])	S041405	50
	A3 (11.7 × 16.5 inches [297 × 420 mm])	S041406	50
	13 × 19 inches (330 × 483 mm)	S041407	50
	13 × 19 inches (330 × 483 mm)	S041604	100
	17 × 22 inches (432 × 559 mm)	S042084	25
	13 inches (330 mm) × 32.8 feet (10 m)	S041409	1 roll

Paper Type	Size	Part number	Sheet count
Epson Ultra Premium Presentation Paper Matte	Letter (8.5 × 11 inches [216 × 279 mm])	S041341	50
	A3 (11.7 × 16.5 inches [297 × 420 mm])	S041343	50
	13 × 19 inches (330 × 483 mm)	S041339	50
	13 × 19 inches (330 × 483 mm)	S041605	100
	17 × 22 inches (432 × 559 mm)	S041908	100
Epson UltraSmooth Fine Art Paper	13 × 19 inches (330 × 483 mm)	S041896	25
	17 × 22 inches (432 × 559 mm)	S041897	25
Epson Watercolor Paper Radiant White	13 × 19 inches (330 × 483 mm)	S041351	20
Epson Exhibition Canvas Matte	13 inches (330 mm) × 20 feet (6.1 m)	S045255	1 roll
	17 × 22 inches (432 × 559 mm)	S045255	25
Epson Exhibition Canvas Gloss	13 inches (330 mm) × 20 feet (6.1 m)	S045241	1 roll
Epson Exhibition Canvas Natural Matte	13 inches (330 mm) × 20 feet (6.1 m)	S045241	1 roll
Epson Exhibition Canvas Natural Satin	13 inches (330 mm) × 20 feet (6.1 m)	S045396	1 roll
Epson Exhibition Canvas Natural Gloss	13 inches (330 mm) × 20 feet (6.1 m)	S045410	1 roll

Parent topic: [Loading Media](#)

Borderless Paper Type Compatibility

You can print borderless photos on compatible paper types in compatible sizes.

Borderless Paper Types

- Epson Brochure & Flyer Paper Matte Double-sided
- Epson Ultra Premium Presentation Paper Matte
- Epson Premium Presentation Paper Matte
- Epson Premium Presentation Paper Matte Double-sided
- Epson Ultra Premium Photo Paper Glossy
- Epson Premium Photo Paper Semi-gloss
- Epson Ultra Premium Photo Paper Luster
- Epson Velvet Fine Art Paper
- Epson Watercolor Paper Radiant White
- Epson UltraSmooth Fine Art Paper 325 gsm
- Epson Premium Photo Paper Glossy
- Epson Photo Paper Glossy

Borderless Paper Sizes

- 4 × 6 inches (102 × 152 mm)
- 5 × 7 inches (127 × 178 mm)
- 8 × 10 inches (203 × 254 mm)
- Letter (8.5 × 11 inches [216 × 279 mm])
- 11 × 14 inches (279 × 356 mm)
- A4 (8.3 × 11.7 inches [210 × 297 mm])
- A3 (11.7 × 16.5 inches [297 × 420 mm])
- 13 × 19 inches (330 × 483 mm)
- 17 × 22 inches (432 × 559 mm)

Parent topic: [Loading Media](#)

Paper or Media Type Settings - Product Software

For this paper	Select this Paper Type or Media Type setting
Plain paper Epson Bright White Pro Paper	Plain Paper/Bright White Paper
Epson Premium Photo Paper Glossy	Epson Premium Glossy
Epson Premium Photo Paper Semi-gloss	Epson Premium Semigloss
Epson Photo Paper Glossy	Photo Paper Glossy
Epson Watercolor Paper Radiant White	Watercolor Paper Radiant White
Epson Velvet Fine Art Paper	Velvet Fine Art Paper
Epson UltraSmooth Fine Art Paper	UltraSmooth Fine Art Paper
Epson Premium Presentation Paper Matte	Epson Archival Matte
Epson Presentation Paper Matte	Epson Photo Quality Ink Jet
Epson Proofing Paper White Semimatte	Epson Proofing Paper White Semimatte
Epson Premium Glossy Photo Paper (250)	Epson Premium Glossy
Epson Premium Semigloss Photo Paper (250)	Epson Premium Semigloss
Epson Premium Luster Photo Paper (260)	Premium Luster Photo Paper
Epson Premium Semimatte Photo Paper (250)	Epson Premium Semigloss

Parent topic: [Loading Media](#)

Selecting the Paper Settings for Each Source - Control Panel

You can change the default paper size and paper type for each source using the control panel on the product.

1. Select **Paper Setting** on the LCD screen.

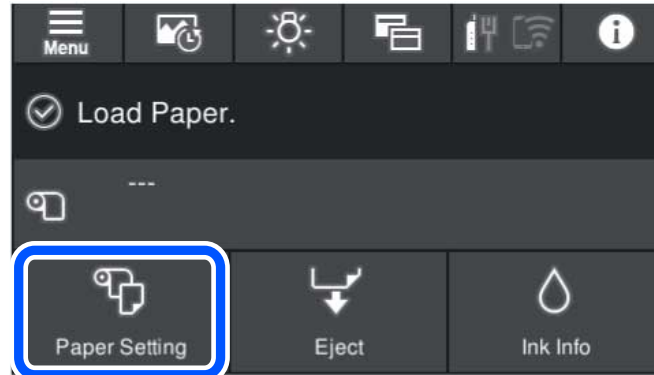

2. Select the paper source you want to change.
3. Select **Paper Size**.
4. Select the paper size you loaded.
5. Select **Paper Type**.
6. Select the paper type for the paper you loaded following the guidelines in the link here.
7. Repeat these steps to select another paper source to change.

[Paper or Media Type Settings - Control Panel](#)

Parent topic: [Loading Media](#)

Paper or Media Type Settings - Control Panel

For this paper	Select this Paper Type setting
Plain paper	Plain Paper
Epson Bright White Pro Paper	
Epson Premium Photo Paper Glossy	Prem. Glossy
Epson Premium Photo Paper Semi-gloss	Prem. Semigloss
Epson Photo Paper Glossy	Glossy
Epson Watercolor Paper Radiant White	Watercolor Paper Radiant White

For this paper	Select this Paper Type setting
Epson Velvet Fine Art Paper	Velvet Fine Art Paper
Epson UltraSmooth Fine Art Paper	Epson UltraSmooth Fine Art paper
Epson Premium Presentation Paper Matte	Archival Matte
Epson Presentation Paper Matte	Photo Quality Ink Jet
Epson Proofing Paper White Semimatte	Proofing Semimatte
Epson Premium Glossy Photo Paper (250)	Prem. Glossy
Epson Premium Semigloss Photo Paper (250)	Prem. Semigloss
Epson Premium Luster Photo Paper (260)	Prem. Luster
Epson Premium Semimatte Photo Paper (250)	Prem. Semigloss

Parent topic: [Selecting the Paper Settings for Each Source - Control Panel](#)

Printing from a Computer

Before printing from your computer, make sure you have set up your product and installed its software as described on the *Start Here* sheet.

Note: If you have an Internet connection, it is a good idea to check for updates to your product software on Epson's support website. If you see a Software Update screen, select **Enable automatic checking** and click **OK**. The update scans your system to see if you have the latest product software. Follow the on-screen instructions.

[Printing with Windows](#)

[Printing on a Mac](#)

Printing with Windows

You can print with your product using any Windows application, as described in these sections.

Note: If you are using your Epson product with the Windows 10 S operating system, you cannot use the software described in this section. You also cannot download and install any Epson product software from the Epson website for use with Windows 10 S; you must obtain software only from the Windows Store.

[Selecting Basic Print Settings - Windows](#)

[Selecting Print Layout Options - Windows](#)

[Selecting Additional Settings - Windows](#)

[Saving, Sharing, and Customizing the Printer Settings](#)

[Printing Your Document - Windows](#)

[Selecting Default Print Settings - Windows](#)

[Changing the Language of the Printer Software Screens](#)

[Changing Automatic Update Options](#)

Parent topic: [Printing from a Computer](#)

Selecting Basic Print Settings - Windows

Select the basic settings for the photo or document you want to print.

1. Open a photo or document for printing.

2. Select the print command in your application.

Note: You may need to select a print icon on your screen, the **Print** option in the File menu, or another command. See your application's help utility for details.

3. If necessary, select your product name as the printer you want to use.

Note: You may also need to select **Preferences**, **Properties**, **Print Settings**, or **Printer Properties** to view your print settings.

You see the Main tab of your printer settings window:

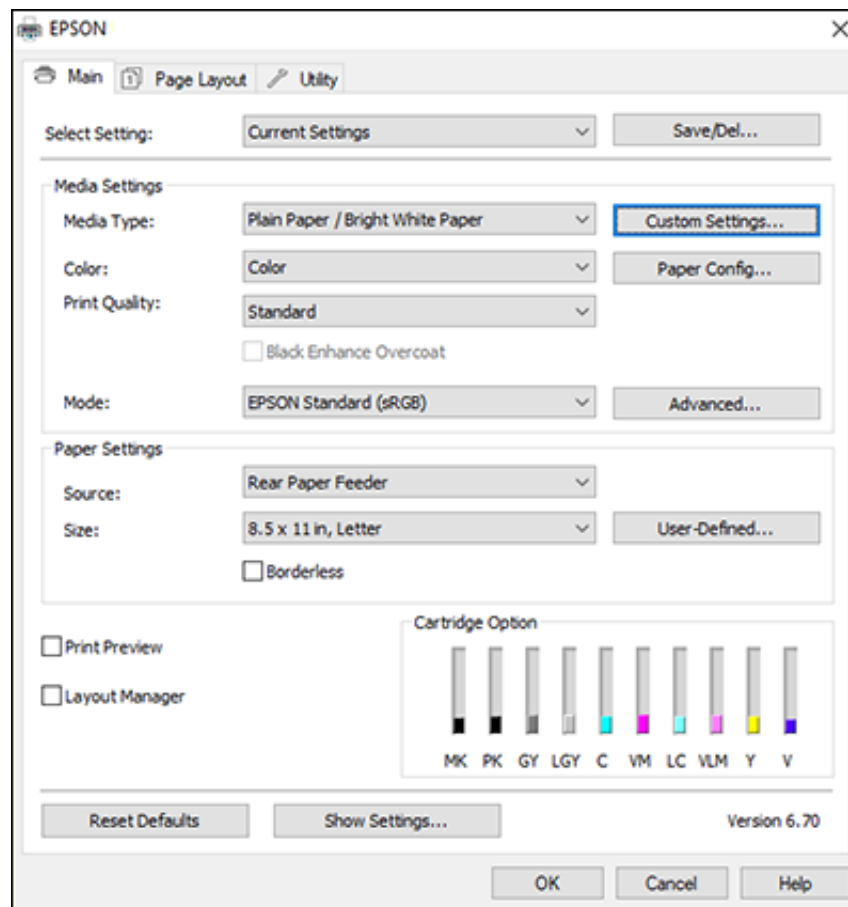

4. Select the **Media Type** setting that matches the paper you loaded.

Note: You can click **Custom Settings** to select a custom paper configuration.

5. If you are using non-Epson paper or media and you need to fine-tune its performance, select the **Media Type** setting that is closest to the paper you loaded, click the **Paper Config** button, and adjust the **Color Density** option as necessary.

6. Select a **Color** option:

- To print a color document or photo, select the **Color** setting.
- To print text and graphics in black or shades of gray, select the **Advanced B&W Photo** or **Grayscale** setting.

Note: The **Grayscale** setting is available only when plain paper is selected as the **Media Type**.

7. Select the **Print Quality** setting that matches the print quality you want to use.
8. Select **Black Enhance Overcoat** to increase the black density by overcoating light gray ink on the dark parts of printouts.

Note: The **Black Enhance Overcoat** setting may not be available depending on the selected paper type.

9. Select the desired color management option as the **Mode** setting.
10. Select the **Source** setting that matches the paper feeding method you are using.
11. Select the size of the paper you loaded as the **Size** setting.

Note: You can also select the **User-Defined** setting to create a custom paper size.

12. If you want to print a photo without borders, select **Borderless**.

Note: You must select a compatible borderless paper type and size to print without borders. Check the borderless paper compatibility list for details.

13. To see a preview of how your document or photo will print, select **Print Preview**. (The preview appears after you click **Print** but before printing starts.)
14. To layout multiple print jobs for printing all at once, select **Layout Manager**.

[Paper Configuration Options - Windows](#)
[Advanced B&W Photo Options - Windows](#)
[Print Quality Options - Windows](#)
[Color Management Options - Windows](#)
[Advanced Color Controls - Windows](#)
[Paper Source Options - Windows](#)
[Using Layout Manager - Windows](#)

Parent topic: [Printing with Windows](#)

Paper Configuration Options - Windows

Select any of the available Paper Configuration options to fine-tune the quality of your print.

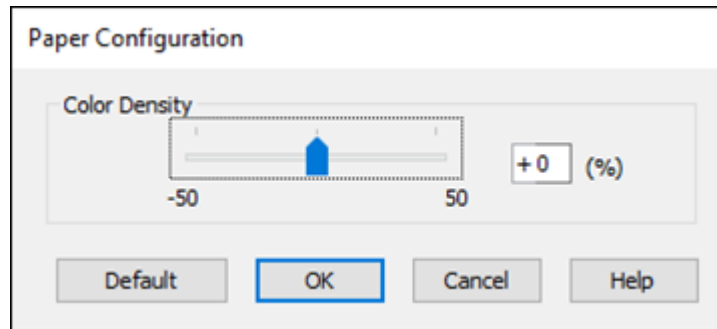

Color Density

Adjusts the ink saturation level.

Parent topic: [Selecting Basic Print Settings - Windows](#)

Advanced B&W Photo Options - Windows

If you select **Advanced B&W Photo** as the Color option, you can easily produce neutral and toned black-and-white prints. Whether your photo is color or grayscale, you can use this screening and color management technology to create stunning black-and-white prints. Click **Advanced** and select any of the available options. You can also use **Black Enhanced Overcoat** to print darker tones of black.

Color Toning

Adds tone (hue) to your black-and-white output. The default is **Neutral**, which provides a neutral tonal scale print. You can also choose other popular presets such as **Cool**, **Warm**, and **Sepia**. Note that the presets affect the target in the tone color circle.

Tone

Changes the entire tonal scale of your black-and-white output. While **Darker** is the default setting, you may see better results if you choose **Dark**. The tone color circle adjusts the hue of your black-and-white print. Click on any portion of the color wheel or enter corresponding values to customize the tone (hue) to add to your print. The closer you select to the edge of the wheel, the more color you add.

Brightness

Adjusts the overall lightness and darkness of your image.

Contrast

Adjusts the difference between the light and dark areas of your image.

Shadow Tonality

Controls tonality only in the shadow areas of your image.

Highlight Tonality

Controls tonality only in the highlight areas of your image.

Max Optical Density

Adjusts the overall density or focus of the print. Create a soft focus print by lowering the density setting.

Highlight Point Shift

Helps reduce gloss differential on glossy media by adding density to the highlights of your image.

Parent topic: [Selecting Basic Print Settings - Windows](#)

Print Quality Options - Windows

You can use the Speed/Quality slider to set the desired quality level and select any of the available Print Quality options to fine-tune the quality of your print. Some settings may be unavailable, depending on the paper type and border setting you have chosen.

High Speed

Speeds up printing but may reduce print quality.

Edge Smoothing

Smooths jagged edges in low-resolution images such as screen captures or images from the Web.

Finest Detail

Sharpens edges on vector-based data including text, graphics, and line art. (This setting does not affect photographs.)

Note: Enabling **Finest Detail** may decrease the print speed.

Black Enhance Overcoat

Prints darker tones of black by overcoating the black ink with gray.

Note: Printing with **Black Enhance Overcoat** increases the edge margins. Select **Quality Options > Minimize Top Margin** to reduce the size of the margins. This may lower print quality and may cause paper that curls easily to rub against the print head.

Parent topic: [Selecting Basic Print Settings - Windows](#)

Color Management Options - Windows

You can adjust the **Mode** setting to fine-tune the colors in your printout or turn off color management in your printer software.

EPSON Standard (sRGB)

Increases the contrast in images.

Note: This is the standard mode for most photos and documents when not using an ICC profile.

Adobe RGB

Matches image colors to the Adobe RGB color standard. Use this setting if your source file was captured in Adobe RGB.

PhotoEnhance

Lets you choose from various Scene Correction settings to automatically analyze your photos.

Note: PhotoEnhance uses a sophisticated face recognition technology to optimize photos that include faces. For this to work, both eyes and the nose must be visible in the subject's face. If your photo includes a face with an intentional color cast, such as a statue, you may want to turn off **PhotoEnhance** to retain the special color effects.

ICM

Automatically adjusts colors based on the printer's ICC profile and the selected **Media Type** setting, using the Image Color Matching system. Click the **Advanced** button to choose the input profile and other settings.

Note: In most cases, you get better results by applying color management in your application, rather than in the printer driver.

Off (No Color Adjustment)

Turns off color management in your printer software so you can manage color using only your application software.

Note: An ICC profile is required if color management is turned off.

Parent topic: [Selecting Basic Print Settings - Windows](#)

Advanced Color Controls - Windows

If you selected **Custom** as the **Mode** setting and **Color Controls** from the dropdown menu, you can click the **Advanced** button to select detailed settings.

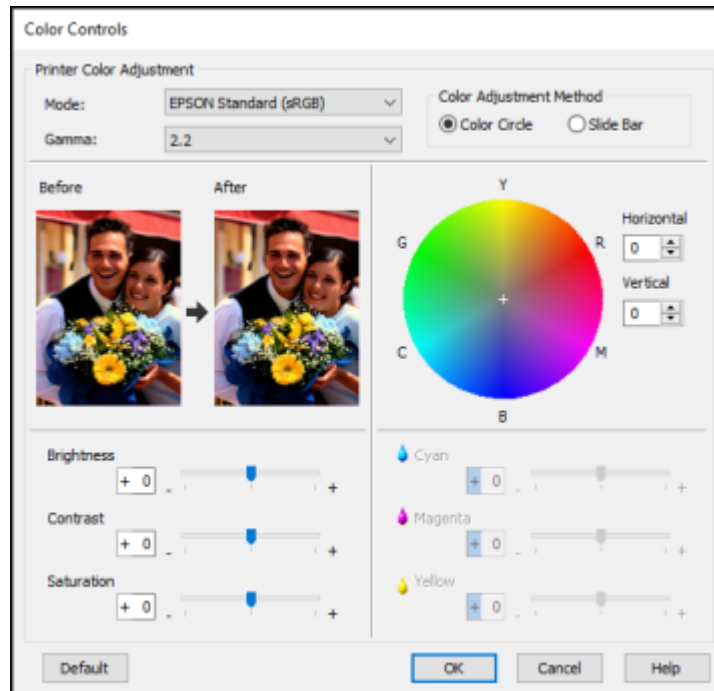

The Color Controls screen lets you specify values for adjusting brightness, contrast, saturation, and individual Cyan, Magenta, and Yellow color tones. You can choose from two Printer Color Adjustment modes and two Gamma settings, and use either a color circle or slide bar to adjust color.

Parent topic: [Selecting Basic Print Settings - Windows](#)

Paper Source Options - Windows

You can select any of the available options in the paper Source menu to print on the paper loaded in that source.

Roll Paper

Selects roll paper loaded in the roll paper holder.

Roll Paper (Banner)

Selects roll paper loaded in the roll paper holder for a series of continuous images without any margin space between them.

Sheet

Selects sheets of paper loaded in the sheet feeder.

Poster Board

Selects poster board or other thick media loaded in the cut sheet feed slot.

Parent topic: [Selecting Basic Print Settings - Windows](#)

Using Layout Manager - Windows

Layout Manager lets you create a poster or display by dragging multiple pieces of print data created in different applications onto one sheet of paper for printing.

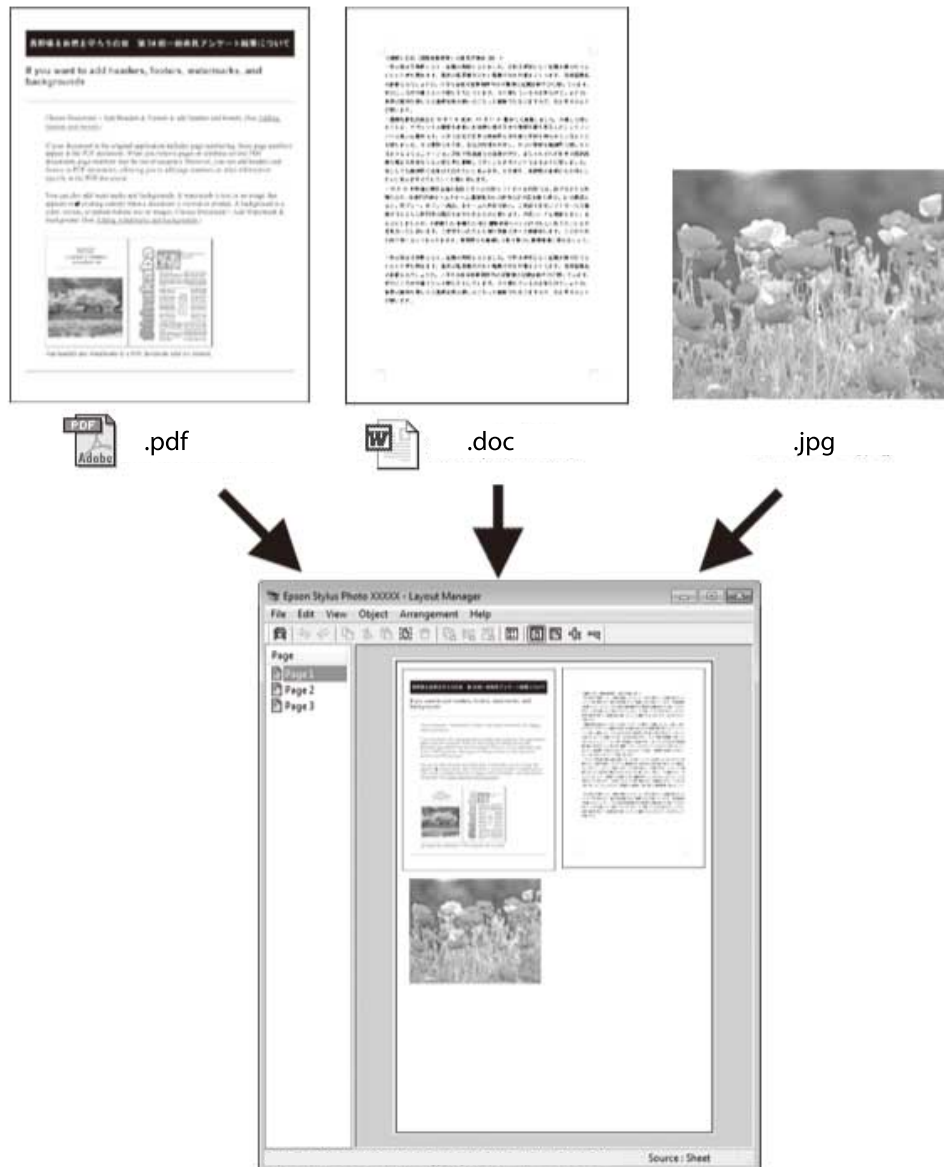

You can also place the same print data multiple times as shown here.



You can place print data in different sizes and orientations to maximize media usage, as shown here.

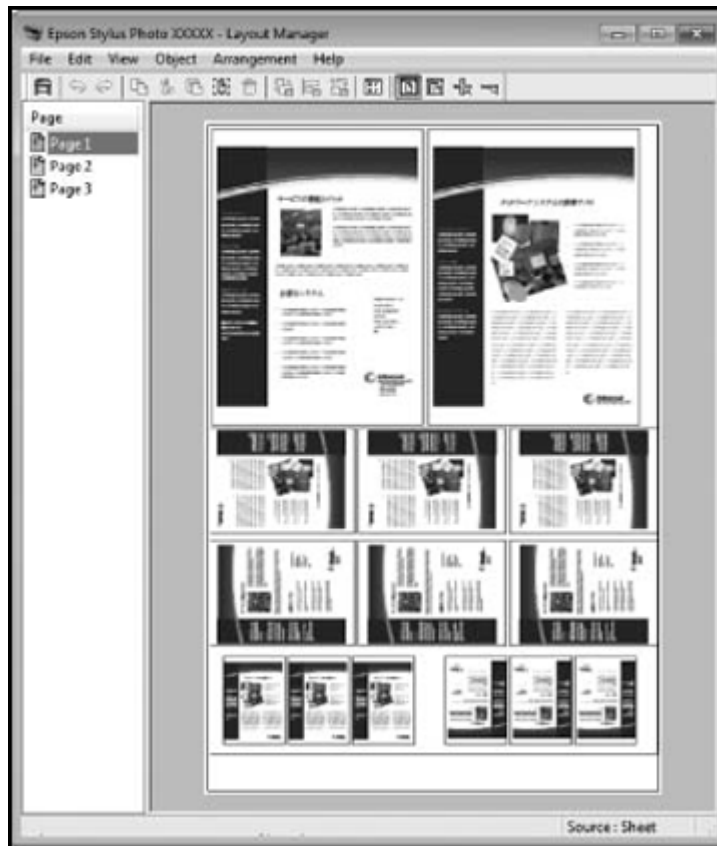

You can place print data on roll paper as shown here.

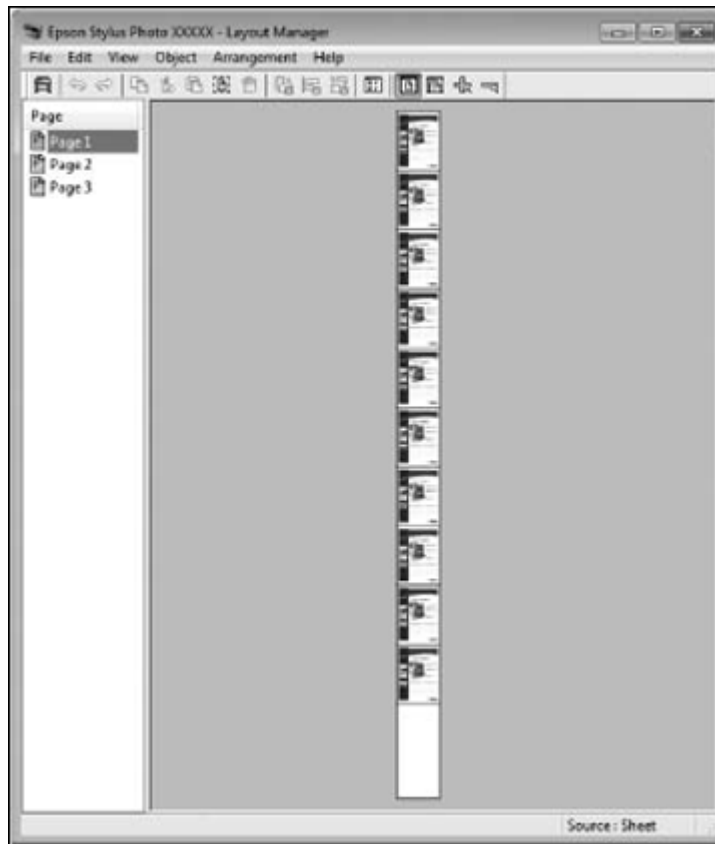

1. Open the file you want to print in your application.
2. Select the print command in your application.

3. Select **Layout Manager** on the Main tab and choose an option for the **Size** setting that matches the size of the document in your application.

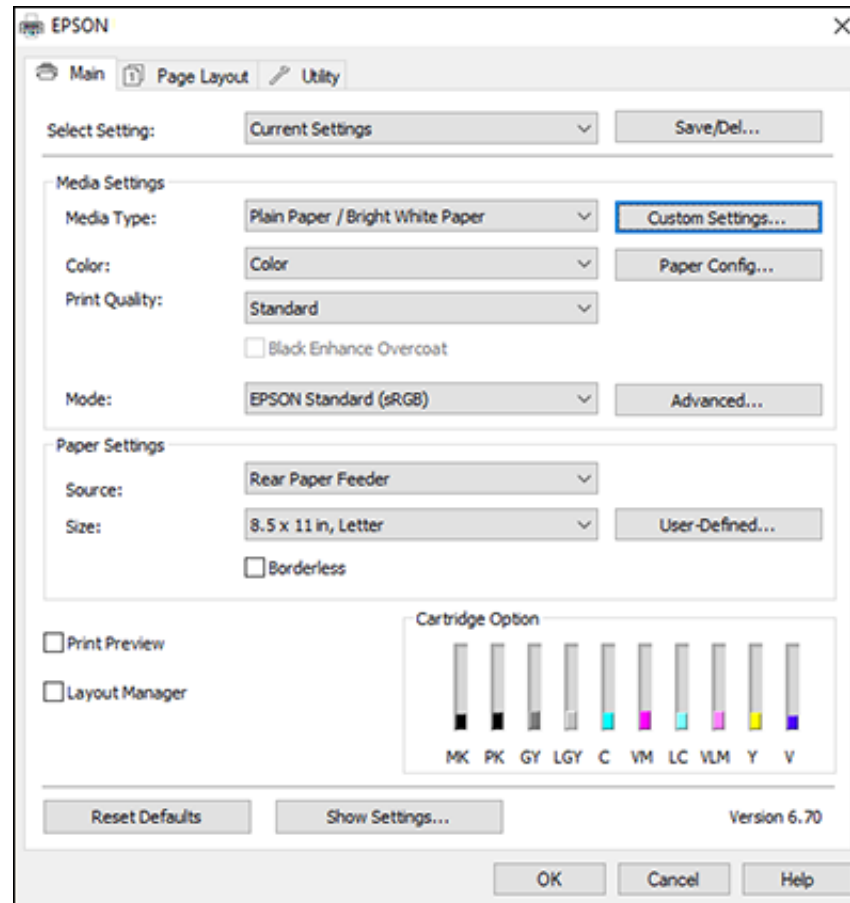

Note: You select the size of the paper you are printing on in a later step.

4. Click **OK** and then click **Print**, if necessary.
The Layout Manager screen opens and displays one page in the layout.
5. Leave the Layout Manager screen open and repeat steps 1 to 4 to arrange additional print data. The pages are added to the Layout Manager screen.

6. Do the following to arrange objects on the Layout Manager screen:
 - Drag pages to move and resize them.
 - Use the tool buttons and the Object menu to align and rotate pages.
 - Resize and replace whole pages in the Preference or Arrangement Settings screens.

Note: See the Layout Manager screen help for details.

7. Click **File > Properties**, then select your print settings, including the size of the paper you are printing on, on the Main tab.
8. Click the **File** menu on the Layout Manager screen and click **Print**.

Note: To save the current job to a file, click the **File** menu on the Layout Manager screen, save the file, and close the Layout Manager screen. To open the saved file later for editing or reprinting, right-click the printer icon in the Windows taskbar, click **Layout Manager**, and open the file.

Parent topic: [Selecting Basic Print Settings - Windows](#)

Selecting Print Layout Options - Windows

You can select a variety of sizing and layout options for your document or photo on the Page Layout tab.

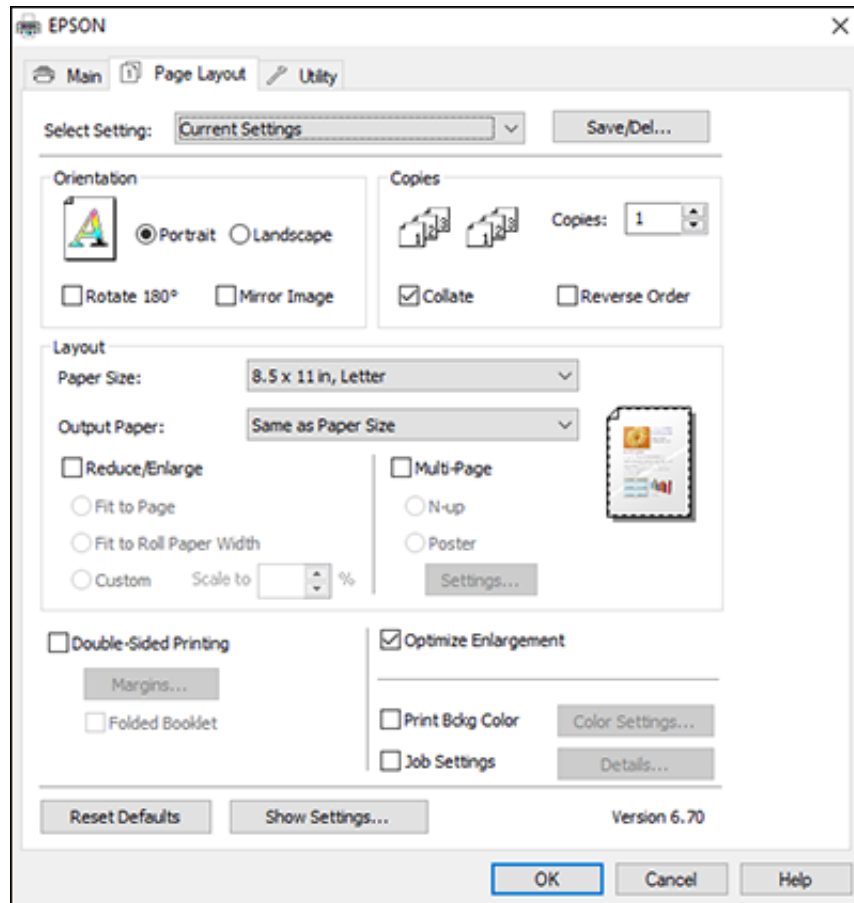

- To change the orientation of your printed document or photo, select the **Portrait** or **Landscape** checkbox.
- To rotate or flip the printed image, select the **Rotate 180°** or **Mirror Image** checkbox.
- To select multiple copies and their print order, select the **Copies**, **Collate**, and **Reverse Order** options.

- To change the size of your printed document or photo, select the **Reduce/Enlarge** checkbox and select sizing options.
- To print multiple pages on one sheet of paper, or print one image on multiple sheets of paper, select the **Multi-Page** checkbox and select the options you want.
- To print on both sides of the paper, select a **Double-Sided Printing** option
- To enlarge your image beyond the limits of your application program, select the **Optimize Enlargement** checkbox.

Note: The driver can increase the image size up to 650% and decrease the output resolution to stay within the pixel limitations. Depending on the resolution of the original image and the print size, you may see reduced print quality.

- To print a color background on the page, select the **Print Bckg Color** checkbox and click **Color Settings** to select the color you want to use.
- To print the time, date, and other information about your print job at the top or bottom of the page, select the **Job Settings** checkbox and click **Details** to select the settings you want to use.

[Reduce/Enlarge Options - Windows](#)

[Multi-Page Printing Options - Windows](#)

Parent topic: [Printing with Windows](#)

Reduce/Enlarge Options - Windows

You can select any of the Reduce/Enlarge options to size your printed image.

Fit to Page

Sizes your printed image to fit on the paper you loaded and selected as the Output Paper setting.

Fit to Roll Paper Width

Sizes your printed image to fit the width of the roll paper you loaded.

Custom

Sizes your printed image by the percentage you select as the **Scale to** setting.

Parent topic: [Selecting Print Layout Options - Windows](#)

Multi-Page Printing Options - Windows

You can select these Multi-Page options to set up your multi-page print job.

N-up

Prints 2 (**2-up**) or 4 (**4-up**) pages on one sheet of paper.



Poster

Prints one image on multiple sheets of paper to create a large poster with or without borders. Click the **Settings** button to select the layout and guideline options.

Parent topic: [Selecting Print Layout Options - Windows](#)

Selecting Additional Settings - Windows

You can run maintenance utilities and select additional settings that apply to all the print jobs you send to your product.

1. Access the Windows Desktop and right-click the  icon for your product in the right side of the Windows taskbar, or click the up arrow and right-click .
2. Select **Printer Settings**.
3. Click the **Utility** tab.

You see a window like this:

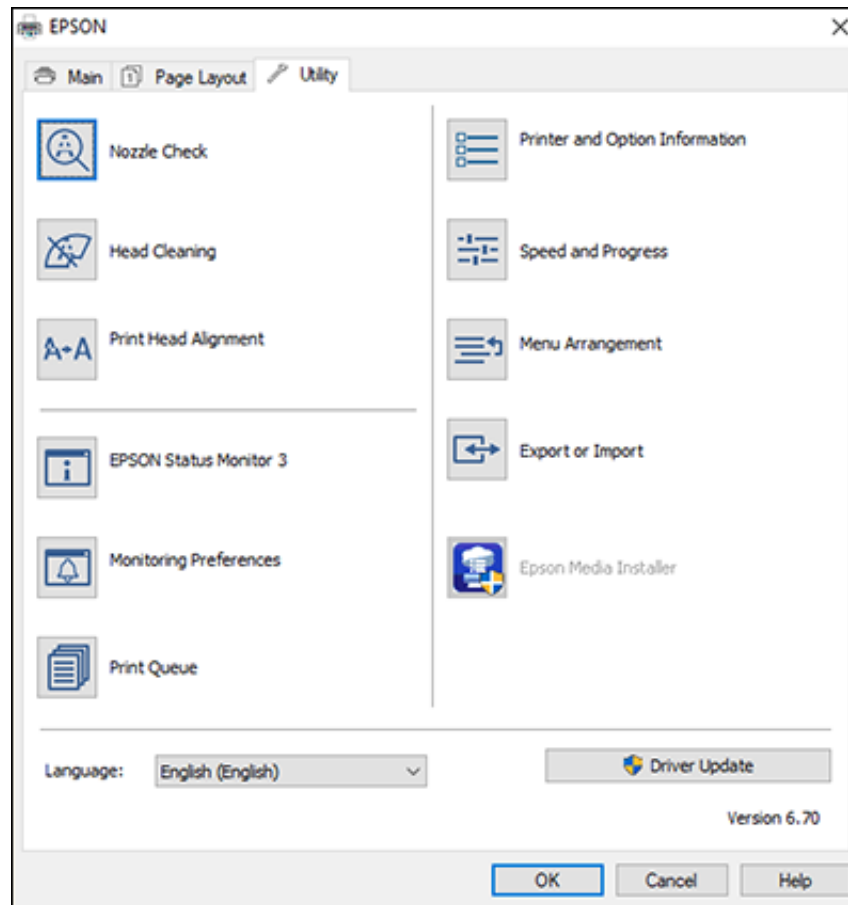

4. Select any of the following options, as necessary:
 - **Nozzle Check** to print a nozzle check pattern to check whether the print head nozzles are clogged.
 - **Head Cleaning** to clean the print head if you notice banding or gaps in your printouts.
 - **Print Head Alignment** to align the print head if your printouts are blurry or have vertical or horizontal lines.
 - **Epson Status Monitor 3** to check the printer's status.

- **Monitoring Preferences** to select the error notifications displayed on the Epson Status Monitor 3 screen, or add a shortcut to the utility in the Windows taskbar.
 - **Print Queue** to display a list of all waiting print jobs, view information on the data waiting to be printed, and delete or reprint the jobs.
 - **Language** to select the language you want to use for the printer software screens.
 - **Printer and Option Information** to adjust the printer's energy saving options.
 - **Speed and Progress** to select various printing options.
 - **Menu Arrangement** to arrange the **Setting**, **Media Type**, and **Paper Size** options by frequency of use.
 - **Export or Import** to save the print settings to a file or import them from a file. This is useful when you want to select the same print settings on multiple computers.
 - **Epson Media Installer** to create and manage custom paper configurations.
5. Click **OK** to close the printer software window.

Parent topic: [Printing with Windows](#)

Saving, Sharing, and Customizing the Printer Settings

You can save groups of print settings or media settings so you can reuse them for future print jobs. You can export these settings as a file so you can share them with other users. You can also edit the settings displayed in the printer software screens.

[Saving and Sharing Print Settings - Windows](#)

[Saving and Sharing Media Settings - Windows](#)

[Editing Print Setting Displays - Windows](#)

Parent topic: [Printing with Windows](#)

Saving and Sharing Print Settings - Windows

You can save your print settings so you can use them for future print jobs.

1. Select the print settings you want to save.
2. Click **Save/Del** at the top of the Main or Page Layout tab in your printer software.

You see a window like this:

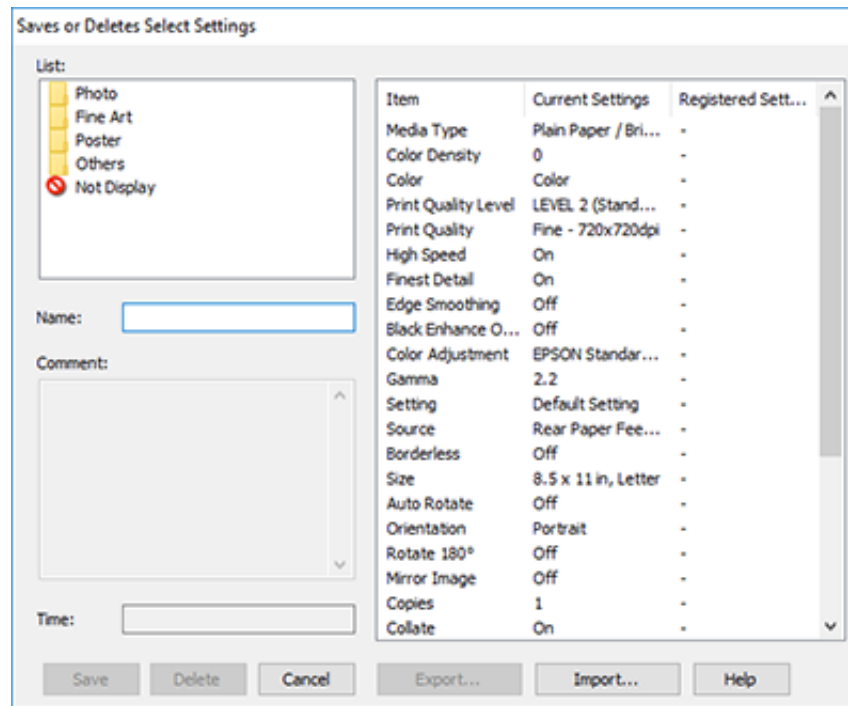

3. Verify that your settings are correct, enter a name for the group of settings in the **Name** field, and click **Save**.

Note: If you need to delete a group of settings you have created, select the name of the group of settings from the list and click **Delete**.

4. Do the following as necessary:
 - Select the name of the group of settings from the Select Setting list and use them to print.
 - To export the settings, click **Save/Del**, select the name of the group of settings, click **Export**, select a location, and enter a file name.
 - To import a group of settings, click **Save/Del**, click **Import**, select the file you want to use, and click **Open**. Then use the settings to print.

Parent topic: [Saving, Sharing, and Customizing the Printer Settings](#)

Saving and Sharing Media Settings - Windows

You can save and share settings you have selected for a particular media type so you can use them for future print jobs.

1. Select the Media Settings you want to save on the Main tab, as necessary.
2. Click **Custom Settings**.

You see a window like this:

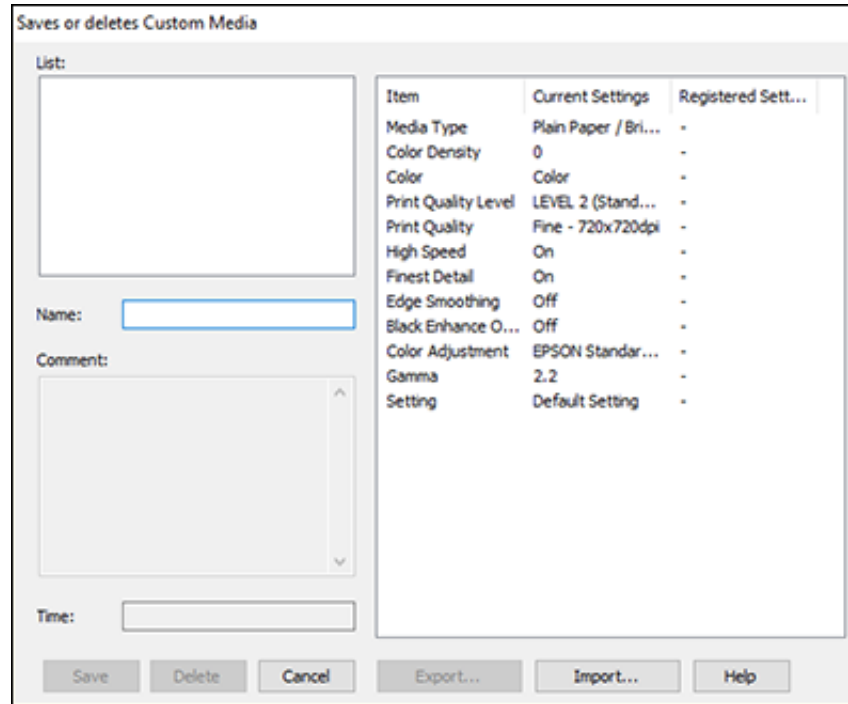

3. Verify that your settings are correct, enter a name for the media settings in the **Name** field, and click **Save**.

Note: If you need to delete a group of settings you have created, select the name of the settings from the list and click **Delete**.

4. Do the following as necessary:
 - Select the name of a media setting as the **Media Type** setting and use it to print.
 - To export the settings, click **Custom Settings**, select the name of the media settings, click **Export**, select a location, and enter a file name.
 - To import settings, click **Custom Settings**, select the name of the media settings, click **Import**, select the file you want to use, and click **Open**. Then use these settings to print.

Parent topic: [Saving, Sharing, and Customizing the Printer Settings](#)

Editing Print Setting Displays - Windows

You can arrange the displayed print settings so you can easily select the settings you use most often.

1. Click the **Utility** tab in the printer software.
2. Select **Menu Arrangement**.

You see this window:

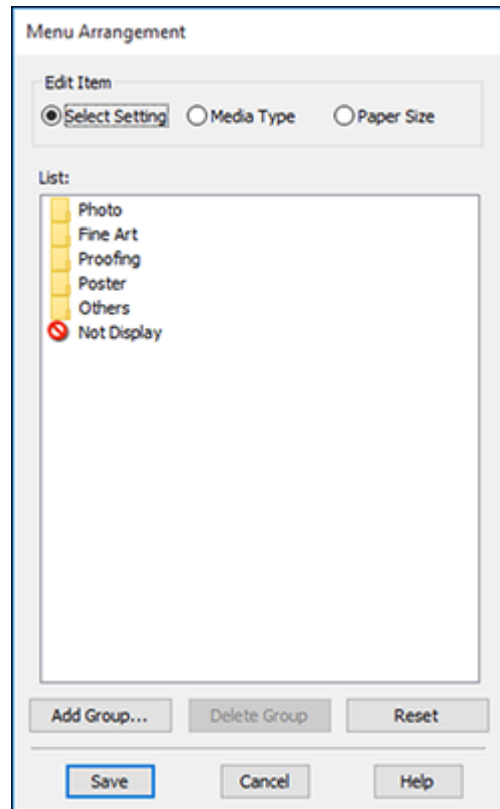

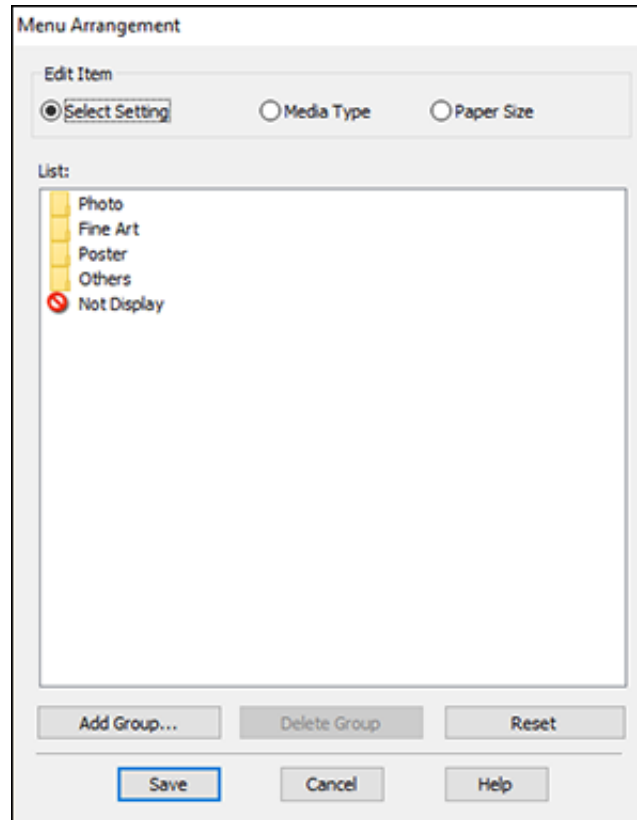

3. Select the item you want to edit.
4. Order or group items in the **List** box as follows:
 - To move and reorder items, drag and drop them in the list.
 - To add a new group (folder), click **Add Group**.
 - To delete a group (folder), select the group and click **Delete Group**.
 - To hide a group, drag and drop it to **Not Display**.

Note: If you delete a group, the group folder is deleted but the items within the folder remain.

5. Click **Save**.

Parent topic: [Saving, Sharing, and Customizing the Printer Settings](#)

Printing Your Document - Windows

Once you have selected your print settings, you are ready to save your settings and print.

1. Click **OK** to save your settings.

You see your application's Print window, such as this one:

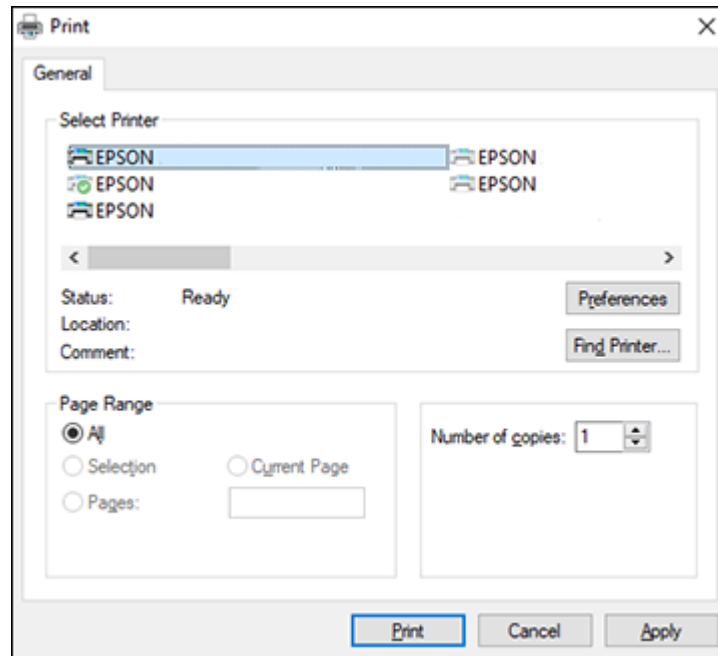

2. Click **OK** or **Print** to start printing.

[Checking Print Status - Windows](#)

Parent topic: [Printing with Windows](#)

Checking Print Status - Windows

During printing, you see this window showing the progress of your print job. It allows you to control printing and check ink cartridge status.

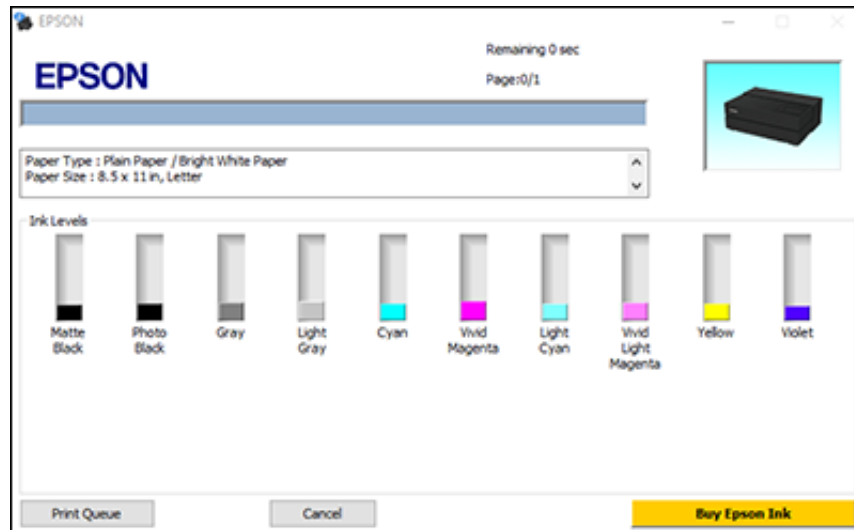



- To cancel printing, click **Cancel**.
- To see print jobs waiting to print, click **Print Queue**.

Parent topic: [Printing Your Document - Windows](#)

Selecting Default Print Settings - Windows

When you change your print settings in a program, the changes apply only while you are printing in that program session. If you want to change the print settings you use in all your Windows programs, you can select new default print settings.

1. Access the Windows Desktop and right-click the  icon for your product in the right side of the Windows taskbar, or click the up arrow and right-click .
2. Select **Printer Settings**.

You see the printer settings window:

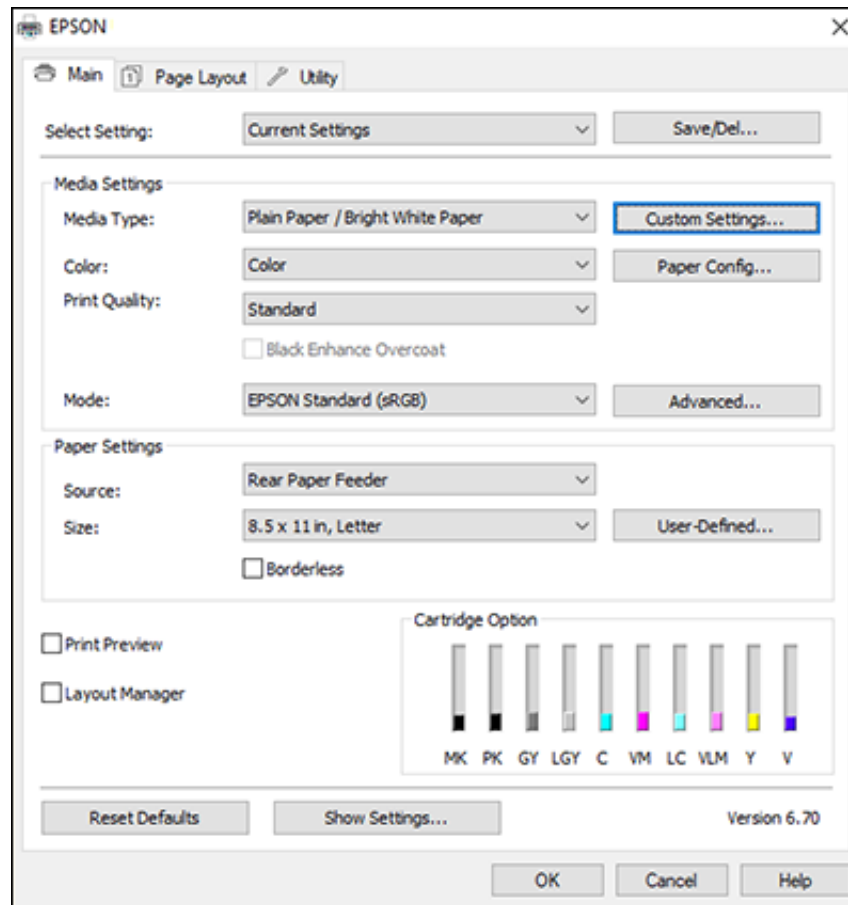



3. Select the print settings you want to use as defaults in all your Windows programs.
4. Click **OK**.

These settings are now the defaults selected for printing. You can still change them as needed for printing in any program session.

Parent topic: [Printing with Windows](#)

Changing the Language of the Printer Software Screens

You can change the language used on the Windows printer software screens.

1. Access the Windows Desktop and right-click the  icon for your product in the right side of the Windows taskbar, or click the up arrow and right-click .
2. Select **Printer Settings**.
You see the printer settings window.
3. Click the **Utility** tab.

You see these options:

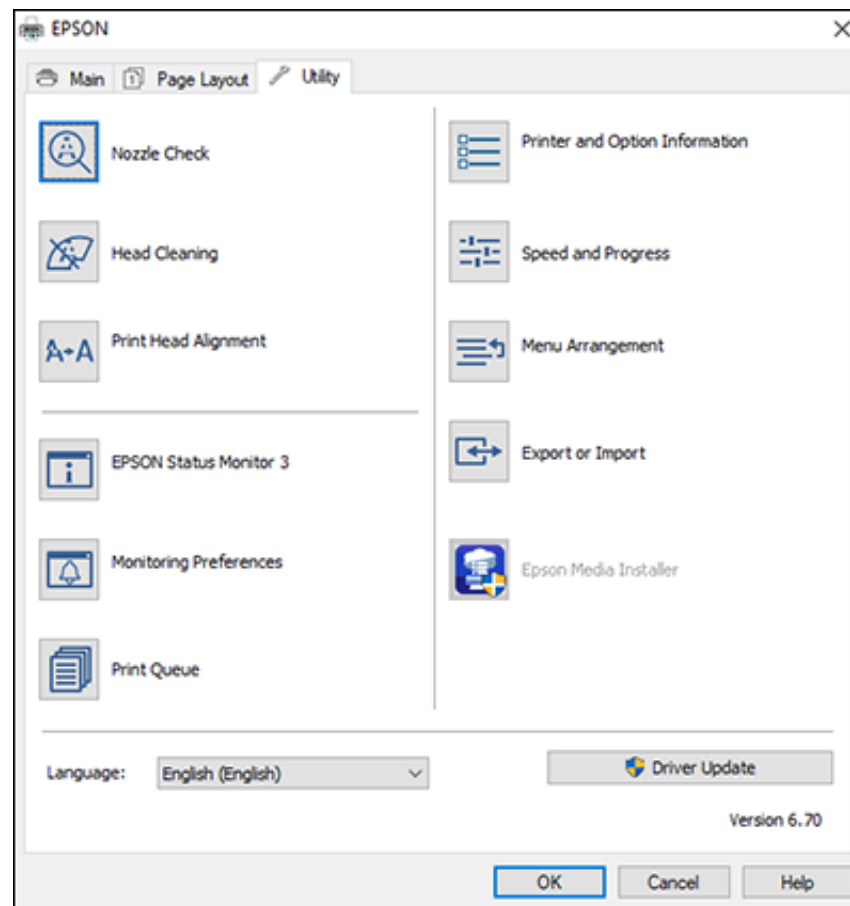



4. Select the language you want to use as the **Language** setting.
5. Click **OK** to close the printer software window.

The printer software screens appear in the language you selected the next time you access them.

Parent topic: [Printing with Windows](#)

Changing Automatic Update Options

Your printer software for Windows automatically checks for updates to the product software. You can change how often the software checks for updates or disable this feature.

1. Access the Windows Desktop and right-click the  icon for your product in the right side of the Windows taskbar, or click the up arrow and right-click .
2. Select **Software Update Settings**.

You see this window:

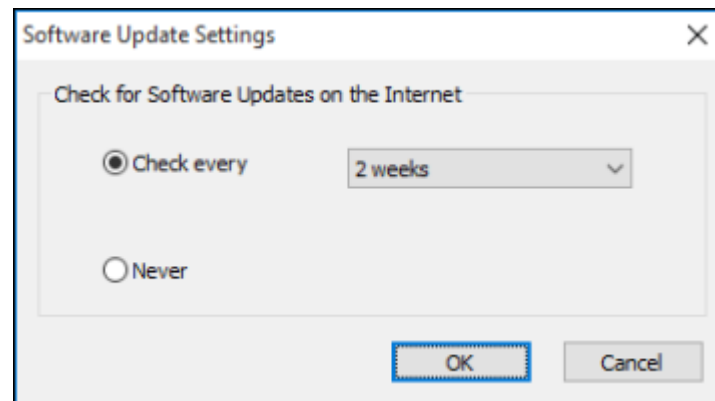

3. Do one of the following:
 - To change how often the software checks for updates, select a setting in the **Check every** menu.
 - To disable the automatic update feature, select the **Never** option.
4. Click **OK** to exit.

Note: If you choose to disable the automatic update feature, you can check for updates manually.

Parent topic: [Printing with Windows](#)

Printing on a Mac

You can print with your product using any Mac printing program, as described in these sections.

Note: If you have an Internet connection, it is a good idea to check for updates to your product software on Epson's support website or using Epson Software Updater.

[Selecting Basic Print Settings - Mac](#)

[Selecting Roll Paper Settings - Mac](#)

[Managing Color - Mac](#)

[Selecting Paper Configuration Settings - Mac](#)

[Selecting Print Layout Options - Mac](#)

[Sizing Printed Images - Mac](#)

[Selecting Printing Preferences - Mac](#)

[Printing Your Document or Photo - Mac](#)

Parent topic: [Printing from a Computer](#)

Selecting Basic Print Settings - Mac

Select the basic settings for the photo or document you want to print.

1. Open a photo or document for printing.
2. Select the print command in your application.

Note: You may need to select a print icon on your screen, the **Print** option in the File menu, or another command. See your application's help utility for details.

3. Select your product as the **Printer** setting.

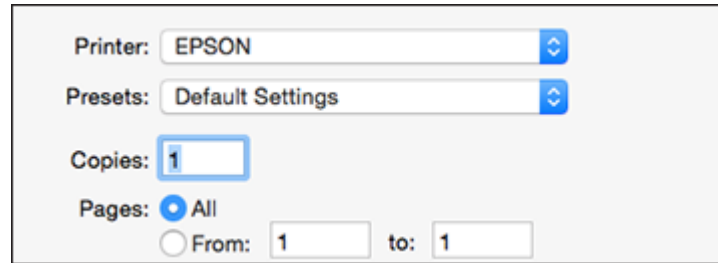

The image shows a printer settings dialog box with the following controls:

- Printer:** A dropdown menu showing "EPSON" with a blue arrow icon on the right.
- Presets:** A dropdown menu showing "Default Settings" with a blue arrow icon on the right.
- Copies:** A text input field containing the number "1".
- Pages:** A radio button labeled "All" which is selected (indicated by a blue dot).
- From:** A radio button labeled "From:" followed by a text input field containing the number "1".
- to:** A radio button labeled "to:" followed by a text input field containing the number "1".

4. If necessary, click the arrow next to the Printer setting or the **Show Details** button to expand the print window.

You see the expanded printer settings window for your product:

The image shows a printer settings dialog box for an EPSON printer. The settings are as follows:

- Printer: EPSON
- Presets: Default Settings
- Copies: 1
- Pages: All, From: 1 to: 1
- Paper Size: US Letter (8.50 by 11.00 inches)
- Orientation: Portrait (selected), Landscape
- Preview: Preview
- Auto Rotate
- Scale: Scale: 100%, Scale to Fit: Print Entire Image, Fill Entire Paper
- Copies per page: 1

Buttons: Cancel, Print

Note: The print window may look different, depending on the Mac OS version and the application you are using.

5. Select the **Copies** and **Pages** settings as necessary.

Note: If you do not see these settings in the print window, check for them in your application before printing.

6. Select the size of the paper you loaded as the **Paper Size** setting.
 - To print a borderless photo, select the **Borderless** checkbox or a paper size with a **Borderless** option. You can also create a custom paper size.
 - To print on roll paper, select a roll paper size or one with a **Borderless** option.

Note: For roll paper, make sure the maximum width of your photo is set to 13 inches (SureColor P700) or 17 inches (SureColor P900) to fit in the width of your roll paper (set the margins to 0 in your application software).

- To print on paper loaded in the manual feed tray, select a paper size with a **Front - Thick** or **Front - Poster Board** option.

Note: You can reduce or enlarge the size of the printed image by selecting **Paper Handling** from the pop-up menu and selecting a scaling option.

Note: If you do not see these settings in the print window, check for them in your application before printing. They may be accessible by selecting **Page Setup** from the File menu.

7. Choose portrait or landscape as the **Orientation** setting.
8. Select any application-specific settings that appear on the screen, such as those shown in the image above for the Preview application.

9. Select **Printer Settings** from the pop-up menu.

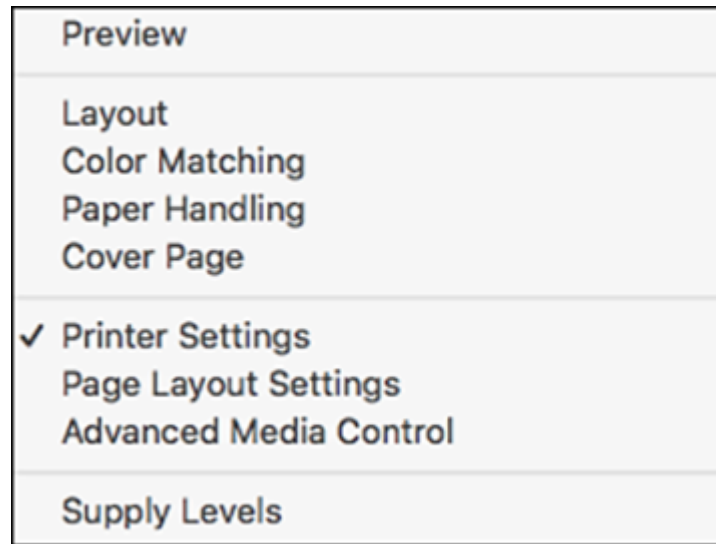

Note: In certain programs, you may need to select **Advanced** before you can select **Printer Settings**. For more information about printer settings, click the ? button.

You see these settings:

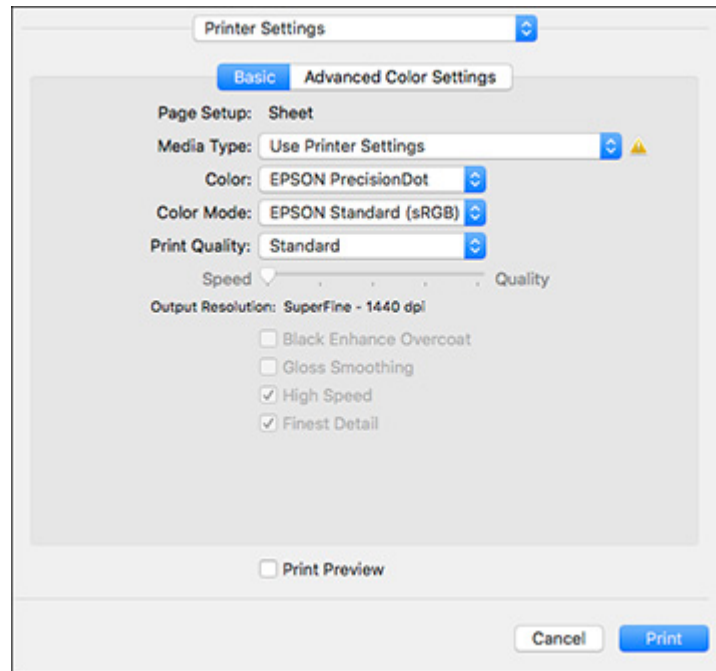

10. Select the type of paper you loaded as the **Media Type** setting.

Note: The setting may not exactly match the name of your paper. Check the media type settings list for details.

11. Select one of the following as the **Color** setting:

- Select **EPSON PrecisionDot** for any type of photographic printing.
- Select **Advanced B&W Photo** to print black-and-white photos on certain types of photo paper. See the list of Advanced B&W Photo options for details. If your paper type does not support this option, print black-and-white photos using the **EPSON PrecisionDot** setting.
- Select **Black/Grayscale** when using plain paper.

Note: If you have enabled color matching settings in your application, this setting may not be available.

12. Select one of the following as the **Color Mode** setting:

- **EPSON Standard (sRGB)**: Increases the contrast in images. Use this setting if your source file was captured using sRGB. Click the **Advanced Color Settings** tab to use advanced color controls.
- **Adobe RGB**: Matches image colors to the Adobe RGB color standard. Use this setting if your source file was captured in Adobe RGB. Click the **Advanced Color Settings** tab to use advanced color controls.
- **Fix Photo**: Improves the color, contrast, and sharpness of flawed photos.

Note: Fix Photo uses a sophisticated face recognition technology to optimize photos that include faces. For this to work, both eyes and the nose must be visible in the subject's face. If your photo includes a face with an intentional color cast, such as a statue, you may want to turn off Fix Photo to retain the special color effects.

- **Off (No Color Management)**: Turns off color management in your printer software so you can manage color using only your application software.

Note: If desired, you can instead use ColorSync to manage colors. In most cases, you get better results by applying color management in your application, rather than in the printer driver.

13. Select the **Print Quality** setting you want to use.

Note: Select **Quality Options** to access all print quality settings and customize as needed.

[Advanced Color Settings - Mac](#)

[Print Quality Settings - Mac](#)

[Print Options - Mac](#)

Parent topic: [Printing on a Mac](#)

Advanced Color Settings - Mac

When you click the **Advanced Color Settings** tab, you see one of the screens below depending on the **Color** and **Color Mode** settings you selected.

- **EPSON Standard (sRGB) or Adobe RGB**

You can specify values for adjusting brightness, contrast, saturation, and individual Cyan, Magenta, and Yellow color tones.

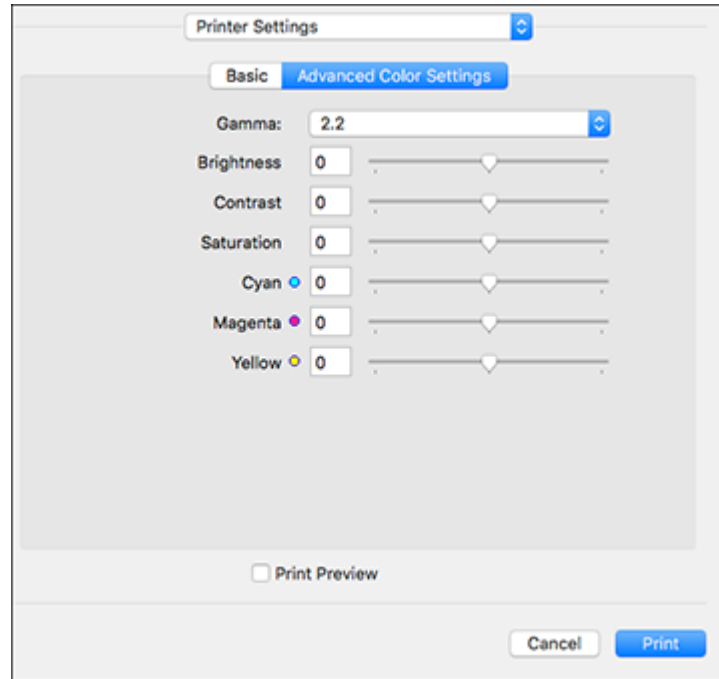

- **Advanced B&W Photo**

You can select any of the available options.

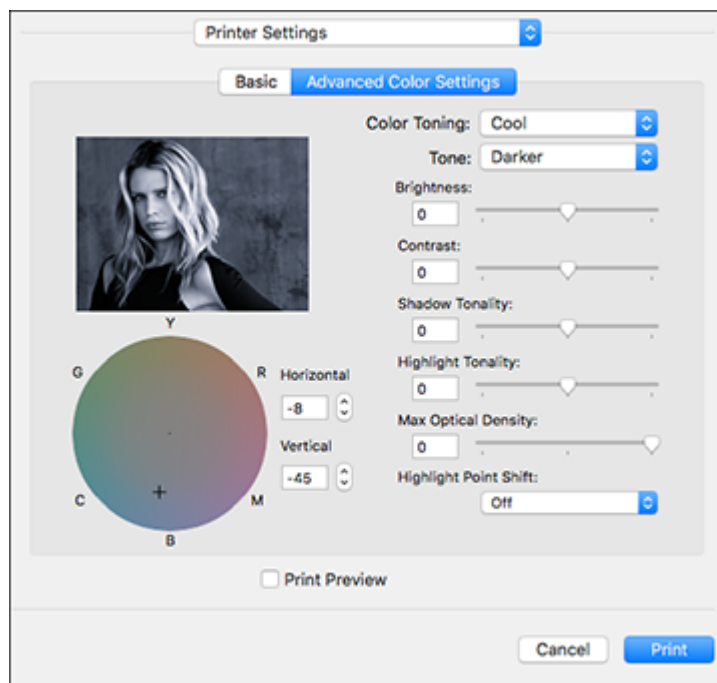

Color Toning

Adds tone (hue) to your black-and-white output. The default is **Neutral**, which provides a neutral tonal scale print. You can also choose other popular presets such as **Cool**, **Warm**, and **Sepia**. Note that the presets affect the target in the tone color circle.

Tone

Changes the entire tonal scale of your black-and-white output. While **Darker** is the default setting, you may see better results if you choose **Dark**. The tone color circle adjusts the hue of your black-and-white print. Click on any portion of the color wheel or enter corresponding values to customize the tone (hue) to add to your print. The closer you select to the edge of the wheel, the more color you add.

Brightness

Adjusts the overall lightness and darkness of your image.

Contrast

Adjusts the difference between the light and dark areas of the overall image.

Shadow Tonality

Controls tonality only in the shadow areas of your image.

Highlight Tonality

Controls tonality only in the highlight areas of your image.

Max Optical Density

Adjusts the overall density or focus of the print. Create a soft focus print by lowering the density setting.

Highlight Point Shift

Helps reduce gloss differential on glossy media by adding density to the highlights of your image.

- **Fix Photo:** You can select Scene Correction and choose Automatic, People, Landscape, Night Scene, Sepia, or Gray. Additional options let you select settings for sharpness and Digital Camera Correction.

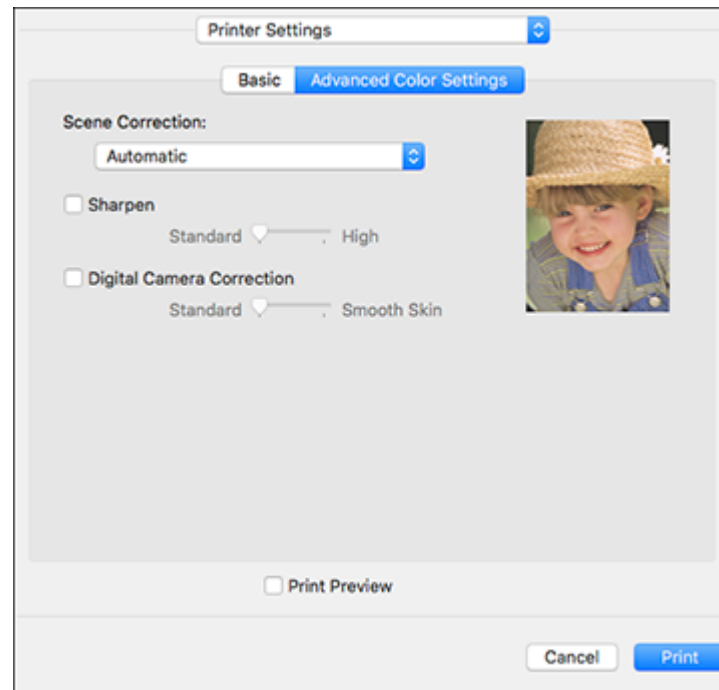

Parent topic: [Selecting Basic Print Settings - Mac](#)

Print Quality Settings - Mac

You can select any of the **Print Quality** settings to fine-tune the quality of your print. Some settings may be unavailable, depending on the paper type and border setting you have chosen.

Standard

For everyday text and image printing.

Quality

For photos and graphics with good quality and print speed.

High Quality

For photos and graphics with high print quality.

Max Quality

For the maximum print quality, but the slowest print speed.

Max Quality (Carbon Black)

For increased black density, works best on glossy media, can reduce print speed.

Parent topic: [Selecting Basic Print Settings - Mac](#)

Print Options - Mac

You can select any of the print options to customize your print. Some options may be unavailable, depending on other settings you have chosen.

Black Enhance Overcoat

Prints with enhanced image contrast and increased black density.

Gloss Smoothing

Reduces the amount of light that is reflected from black areas to achieve a smoother gloss on photo paper.

Note: Enabling **Gloss Smoothing** may decrease the black print density.

High Speed

Speeds up printing but may reduce print quality.

Finest Detail

Sharpens edges on vector-based data including text, graphics, and line art. (This setting does not affect photographs.)

Note: Enabling **Finest Detail** may decrease the print speed.

Parent topic: [Selecting Basic Print Settings - Mac](#)

Selecting Roll Paper Settings - Mac

To print on roll paper, you select the roll paper size and roll paper options from the Printer Settings menu.

1. Select **Manage Custom Sizes** as the **Paper Size** setting.
2. Click **+**, double-click **Untitled**, and enter a name for your roll paper size.
3. For borderless printing, enter one of the following as the **Width** setting:
 - **8.3** for 8.3-inch (211 mm) wide roll paper (SureColor P700)
 - **12.95** for 13-inch (330 mm) wide roll paper
 - **16** for 16-inch (406 mm) wide roll paper (SureColor P900)
 - **16.5** for 16.5-inch (419 mm) wide roll paper (SureColor P900)
 - **17** for 17-inch (432 mm) wide roll paper (SureColor P900)

Note: Make sure your image fits within the width of your roll paper.

4. Enter the length of your roll paper image as the **Height** setting (up to 129 inches [3277 mm]).
5. Set the margin settings to **0**.
6. Click **OK**.
7. Select your new custom roll paper size as the **Paper Size** setting.
8. Select **Page Layout Settings**.

You see this window:

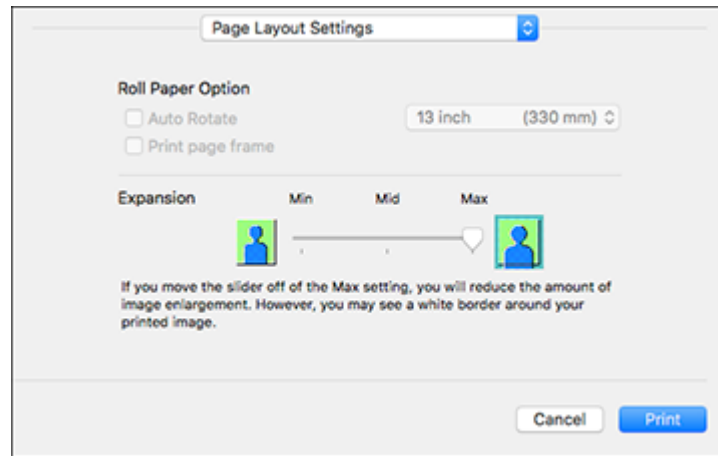

Note: Some settings may not be available, depending on the Roll Paper option you selected for your Paper Size.

9. Select the following settings as necessary:
 - Click **Auto Rotate** and select the roll paper width to fit the images to the paper.
 - Click **Print page frame** to print a cutting guideline around images.
 - Adjust the amount of image expansion when printing borderless images.

Note: This option is available only when you choose a Paper Size setting with a **Borderless** option.

10. Click **Print**.

Parent topic: [Printing on a Mac](#)

Managing Color - Mac

You can adjust the Color Matching settings to fine-tune the colors in your printout, or turn off color management in your printer software.

1. Select **Color Matching** from the pop-up menu in the print window.

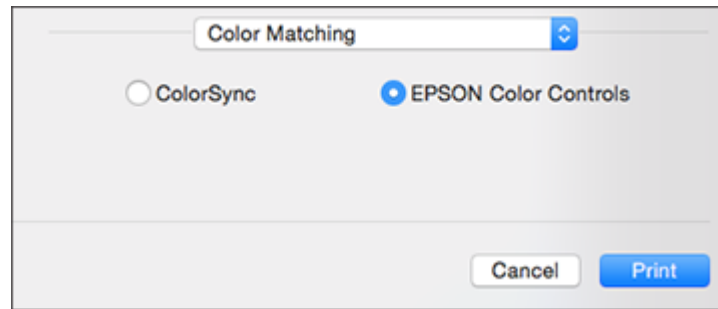

2. Select one of the available options.

[Color Matching Options - Mac](#)

Parent topic: [Printing on a Mac](#)

Color Matching Options - Mac

You can select from these settings on the **Color Matching** menu.

ColorSync

Prints using standard color profiles for your product and paper to help match image colors. You can customize the conversion method and filter settings on the ColorSync pop-up menu in the print window.

EPSON Color Controls

Lets you manage color using controls in your printer driver or turn off color management.

Parent topic: [Managing Color - Mac](#)

Selecting Paper Configuration Settings - Mac

If you are using non-Epson media and need to fine-tune its print quality, select **Advanced Media Control** from the pop-up menu, then change the **Color Density** setting to adjust the ink saturation level as necessary.

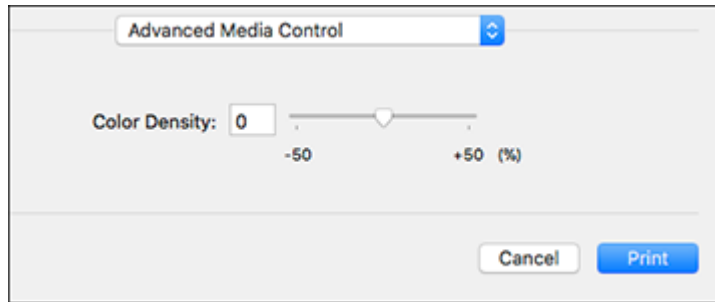

Parent topic: [Printing on a Mac](#)

Selecting Print Layout Options - Mac

You can select a variety of layout options for your document or photo by selecting **Layout** from the pop-up menu on the print window.

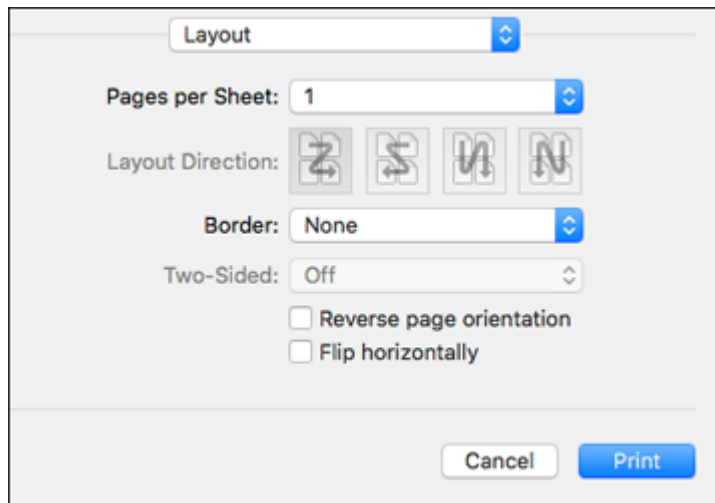

- To print multiple pages on one sheet of paper, select the number of pages in the **Pages per Sheet** pop-up menu. To arrange the print order of the pages, select a **Layout Direction** setting.
- To print borders around each page on the sheet, select a line setting from the **Border** pop-up menu.
- To invert or flip the printed image, select the **Reverse page orientation** or **Flip horizontally** settings.

Parent topic: [Printing on a Mac](#)

Sizing Printed Images - Mac

You can adjust the size of the image as you print it by selecting **Paper Handling** from the pop-up menu on the Print window.

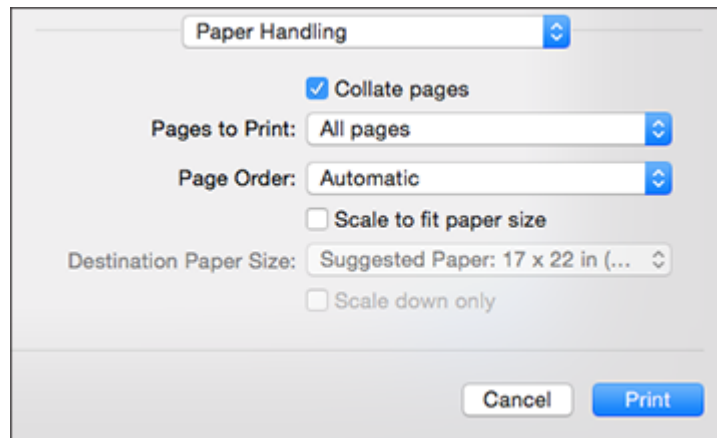

- To collate multiple copies into sets of documents, select the **Collate pages** checkbox.
- To print only selected pages in a multi-page document, select an option from the **Pages to Print** pop-up menu.
- To adjust the order in which pages are printed, select an option from the **Page Order** pop-up menu.
- To scale the image to fit on a specific paper size, select the **Scale to fit paper size** checkbox and select a paper size from the **Destination Paper Size** pop-up menu.
- To restrict scaling of the image to reduced sizing, select the **Scale down only** checkbox. (Deselect this checkbox when enlarging the image.)

Parent topic: [Printing on a Mac](#)

Selecting Printing Preferences - Mac

You can select printing preferences that apply to all the print jobs you send to your product.

1. In the Apple menu or the Dock, select **System Preferences**.
2. Select **Print & Fax**, **Print & Scan**, or **Printers & Scanners**, select your product, and select **Options & Supplies**.
3. Select **Driver** or **Options**.

You see a screen like this:

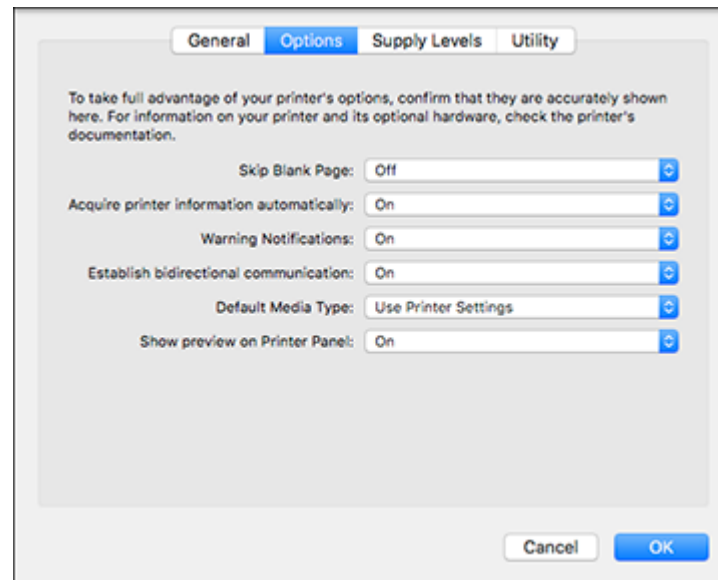

4. Select any of the available printing preferences.
5. Click **OK**.

[Printing Preferences - Mac](#)

Parent topic: [Printing on a Mac](#)

Printing Preferences - Mac

You can select from these settings on the **Options** tab.

Skip Blank Page

Ensures that your product does not print pages that contain no text or images.

Acquire printer information automatically

Ensures that the paper size and paper type settings are automatically updated if paper is loaded or changed after closing the print window.

Warning Notifications

Lets you choose whether or not to receive warning notifications from the printer software for various operating conditions.

Establish bidirectional communication

Allows the product to communicate with the computer. Do not change the default setting unless you experience issues when using a shared printing pool.

Default media type

Select the Media Type that you want to use as the default in the printer driver.

Show preview on Printer Panel

Lets you choose whether or not to show a preview of the print job on the printer control panel while printing.

Parent topic: [Selecting Printing Preferences - Mac](#)

Printing Your Document or Photo - Mac

Once you have selected your print settings, you are ready to print.

Click **Print** at the bottom of the print window.

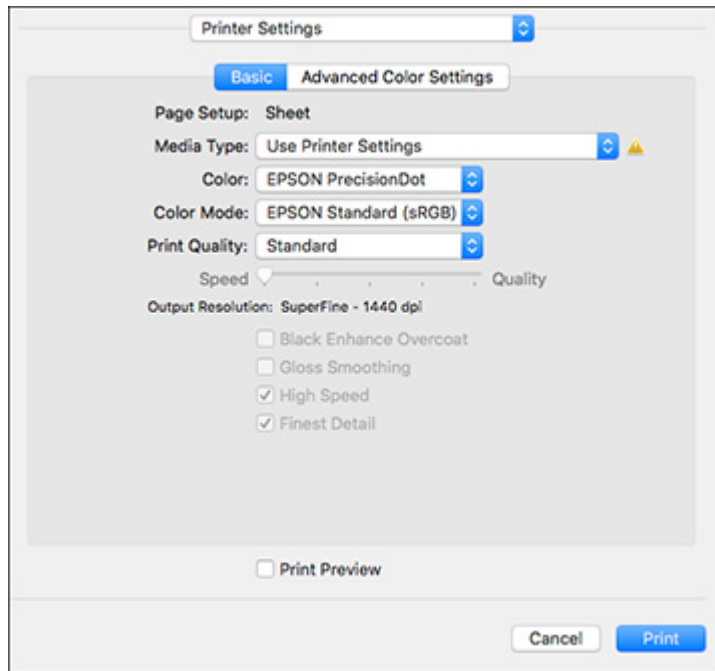

[Checking Print Status - Mac](#)

Parent topic: [Printing on a Mac](#)

Checking Print Status - Mac



During printing, you can view the progress of your print job, control printing, and check ink status.

1. Click the printer icon when it appears in the Dock.

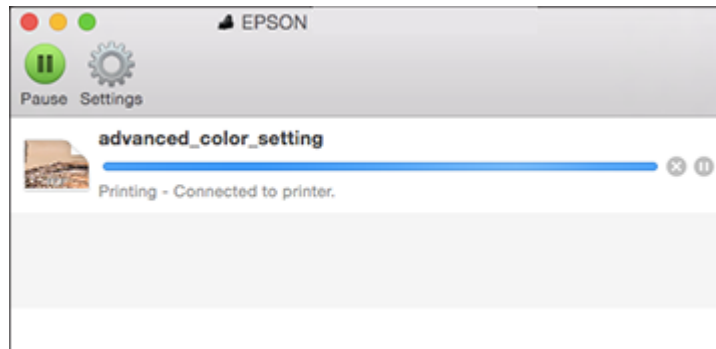
You see the print status window:



2. Select the following options as necessary for your Mac OS version:

- To cancel printing, click the print job and click  or **Delete**.
- To pause a print job, click the print job and click  or **Hold**. To resume a print job, click the paused print job and click  or **Resume**.
- To pause printing for all queued print jobs, click **Pause** or **Pause Printer**.
- To display other printer information, click **Settings** or **Supply Levels**.

Parent topic: [Printing Your Document or Photo - Mac](#)

Using the Control Panel Menus

Follow the instructions in these sections to access the printer menu system and select settings.

[Accessing the Printer's Menus](#)

[Maintenance Menu](#)

[Screen Customization Menu](#)

[Printer Settings Menu](#)

[Basic Settings Menu](#)

[Network Settings Menu](#)

[Restore Default Settings Menu](#)

[Printer Status/Print Menu](#)

Accessing the Printer's Menus

You can use the printer menus to adjust the settings that control how your printer works.

1. Press the  home button, if necessary.
2. Select **Menu**.

You see this screen:

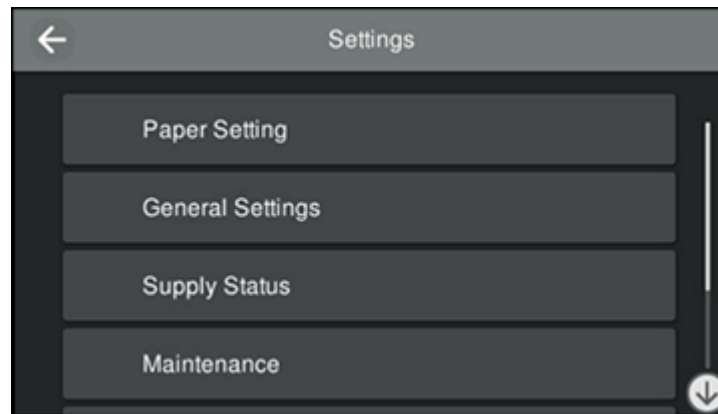

3. Press the up or down arrow to scroll through the menus, or swipe up or down on the LCD screen.

Note: To return to the previous screen, press the left arrow.

4. Press the up or down arrow to move through the settings, or swipe up or down on the LCD screen.
5. To select a setting, press the setting name. You can also select a setting to toggle it on or off, as shown below.

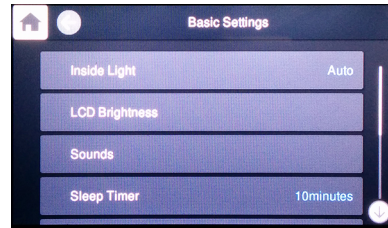

6. When you finish changing settings on a menu, press the left arrow to return to the previous menu or press the  home button to exit the menu system.

Parent topic: [Using the Control Panel Menus](#)

Maintenance Menu

Select  > **Maintenance** to run nozzle checks, cleaning cycles, and other maintenance operations.

Caution: Follow the instructions in the topic links below the table to use these menu settings correctly.

Setting	Description
Print Head Nozzle Check	Prints a nozzle check pattern so you can check for clogged nozzles
Print Head Cleaning	Perform if the nozzle check pattern has faint or missing areas
Power Cleaning	Perform if the nozzle check pattern still has faint or missing areas after performing a head cleaning several times
Print Head Alignment	Perform if your printouts become grainy or blurry or you notice misalignment of vertical lines

Setting	Description
Ink Cartridge(s) Replacement	Moves the print head to the correct position so you can replace ink cartridges. Displays the ink cartridge replacement procedure.
Replace Maintenance Box	Displays the maintenance box replacement procedure
Paper Guide Cleaning	Perform if printouts are smeared when printing from the rear paper feeder

Parent topic: [Using the Control Panel Menus](#)

Screen Customization Menu

Select  > **General Settings** > **Screen Customization** to customize the LCD screen.

Setting	Options	Description
Background Color	—	Changes the color of the home screen.
Home Screen	Standard Supply Status	Selects the default screen to display as the home screen
Print Screen	Photo Print Settings Print Status	Selects the default screen to display when printing

Parent topic: [Using the Control Panel Menus](#)

Printer Settings Menu

Select  > **General Settings** > **Printer Settings** to customize paper and printing options.

Setting	Options	Description
Paper Setup Auto Display	On Off	Select On to display the Paper Setting screen when loading paper in the rear paper feeder. If you disable this feature, you cannot print from an iPhone, iPad, or iPod touch using AirPrint.

Setting	Options	Description
Error Notice	Paper Mismatch Detect Paper Meandering	Select On to display an error message when the output size or paper type settings differ between the driver and printer, or if the paper is skewed
Horizontal Centered	On Off	Select On to print the image in the center of the paper.
Thick Paper	On Off	Select On to prevent ink from smearing on your printouts.

Parent topic: [Using the Control Panel Menus](#)

Basic Settings Menu

Select  > **General Settings** > **Basic Settings** to customize to customize various display and power settings.

Setting	Options	Description
Inside Light	Auto Manual	Adjusts the behavior of the internal light. Set to Auto to turn the light on when a print job is running. Select Manual to use the  icon on the LCD screen to turn the light on or off.
LCD Brightness	1 to 9	Adjusts LCD screen brightness
Sounds	Mute	Turns on or off all sound
	Button Press	Adjusts the volume of control panel sounds
	Error Notice	Adjusts the volume of error notifications
	Sound Type	Adjusts the type of control panel sounds
Sleep Timer	3 to 15 minutes	Selects the amount of time before the printer enters sleep mode

Setting	Options	Description
Power Off Timer	Various times Off	Selects the amount of time before the printer turns off automatically
Date/Time Settings	Date/Time	Enters the date and time
	Daylight Saving Time	Select whether daylight savings is active. If your area does not observe daylight savings time, choose Winter .
	Time Difference	Sets the time difference for coordinated universal time (UTC)
Language	Various languages	Selects the language used on the LCD screen
Length Unit	m ft/in	Selects the unit of length displayed on the LCD screen

Parent topic: [Using the Control Panel Menus](#)

Network Settings Menu

Select  > **General Settings** > **Network Settings** to configure your printer's network settings.

Setting	Options	Description
Wi-Fi Setup	Wi-Fi (Recommended) Wi-Fi Direct	Set up or change wireless network settings.
Wired LAN Setup	—	Disables a Wi-Fi connection so that you can connect to a network using a wired Ethernet cable
Network Status	Wired LAN Status	Displays current communication status and connection settings
	Wi-Fi Direct Status	
	Print Status Sheet	Prints the current network connection information
Connection Check	—	Displays the network status and lets you print a connection check report

Setting	Options	Description
Advanced	—	Displays advanced information, such as TCP/IP settings. You can enable or disable other network settings.

Parent topic: [Using the Control Panel Menus](#)

Restore Default Settings Menu

Select  > **General Settings** > **Restore Default Settings** to reset settings to their defaults.

Setting	Options	Description
Network Settings	—	Resets all network settings
All Except Network Settings	—	Resets all except network settings
Clear All Data and Settings	—	Resets all control panel settings

Parent topic: [Using the Control Panel Menus](#)

Printer Status/Print Menu

Select  > **General Settings** > **Printer Settings** to view current printer and network settings.

Setting	Options	Description
Print Status Sheet	Configuration Status Sheet	Prints a summary of current printer settings
	Supply Status Sheet	Prints a summary of the status of consumables
	Usage History Sheet	Prints a summary showing the usages history of the printer

Setting	Options	Description
Network	Wired LAN/Wi-Fi Status	Displays current communication status and connection settings
	Wi-Fi Direct Status	Displays the number of connected devices and connection settings
	Print Status Sheet	Prints the current network connection information
Problem Checklist		Checks for printer problems by having you print some test pages
Firmware Version	—	Displays the firmware version for the printer and any optional accessories connected to it

Parent topic: [Using the Control Panel Menus](#)

Replacing Ink Cartridges and Maintenance Boxes

The maintenance box stores ink that gets flushed from the system during print head cleaning. When an ink cartridge is expended or the maintenance box is at the end of its service life, you need to replace it.

You may also need to replace a cartridge that is more than six months old if your printouts do not look their best, even after cleaning and aligning the print head.

Note: Please dispose of your used Epson branded ink cartridges and maintenance boxes responsibly and in accordance with local requirements. If you would like to return your used ink cartridges and maintenance boxes to Epson for proper disposal, please go to [epson.com/recycle](https://www.epson.com/recycle) for more information.



[Checking Ink Cartridge and Maintenance Box Status on the LCD Screen](#)

[Purchase Epson Ink Cartridges and Maintenance Box](#)

[Removing and Installing Ink Cartridges](#)

[Maintenance Box Replacement](#)

Checking Ink Cartridge and Maintenance Box Status on the LCD Screen

You can select  **Ink Info** on the product's home screen to check the status of the ink cartridges and maintenance box. If the  icon appears on an ink color or the maintenance box, you need to replace them soon.

Parent topic: [Replacing Ink Cartridges and Maintenance Boxes](#)

Purchase Epson Ink Cartridges and Maintenance Box

U.S. and Canada:

You can purchase genuine Epson ink, maintenance boxes, and paper at [epson.com](https://www.epson.com) (U.S. sales), [epson.ca](https://www.epson.ca) (Canadian sales), or [epson.com.jm](https://www.epson.com.jm) (Caribbean sales). You can also purchase supplies from an Epson authorized reseller. To find the nearest one, call 800-GO-EPSON (800-463-7766) in the U.S. or 800-807-7766 in Canada.

Latin America:

You can purchase genuine Epson ink, maintenance boxes, and paper from an Epson authorized reseller. To find the nearest reseller, visit [epson.com.jm](https://www.epson.com.jm) or call your nearest Epson sales office.

Note: This product is designed to work with genuine Epson inks. Non-Epson ink or any other ink not specified for this printer could cause damage not covered by Epson's warranties.

[Ink Cartridge and Maintenance Box Part Numbers](#)

Parent topic: [Replacing Ink Cartridges and Maintenance Boxes](#)

Ink Cartridge and Maintenance Box Part Numbers

Use these part numbers when you order or purchase a new ink cartridge or maintenance box.

Note: For best printing results, use up a cartridge within one year of opening the package. Epson recommends removing and shaking the ink cartridges once every six months.

Maintenance box part number: C12C935711

Ink color	SureColor P700 (25 ml)	SureColor P900 (50 ml)
Photo Black	T7701	T46Y1
Cyan	T7702	T46Y2
Vivid Magenta	T7703	T46Y3
Yellow	T7704	T46Y4
Light Cyan	T7705	T46Y5
Vivid Light Magenta	T7706	T46Y6
Gray	T7707	T46Y7
Matte Black	T7708	T46Y8
Light Gray	T7709	T46Y9
Violet	T7700	T46YD

Parent topic: [Purchase Epson Ink Cartridges and Maintenance Box](#)

Removing and Installing Ink Cartridges

Make sure you have your replacement cartridges handy before you begin. You must install new cartridges immediately after removing the old ones.

Note: When you see a message on the LCD screen to replace an ink cartridge, you can select **How To** to view on-screen instructions or the instructions below to replace the cartridge.

Note: Replace all expended ink cartridges. You cannot print if any of the ink cartridges are expended or missing.

1. Turn on your product.
2. Open the front cover.

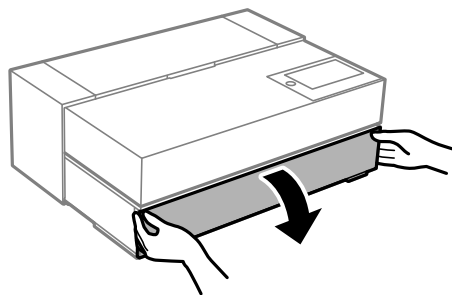

3. Open the printer cover.

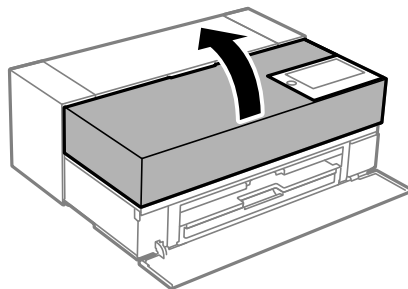

4. Push down the tab to unlock the ink cartridge you are replacing.

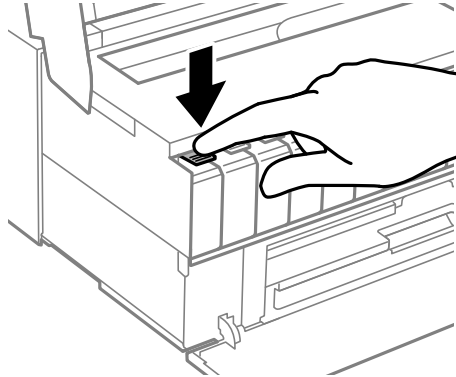

5. Pull out the ink cartridge.

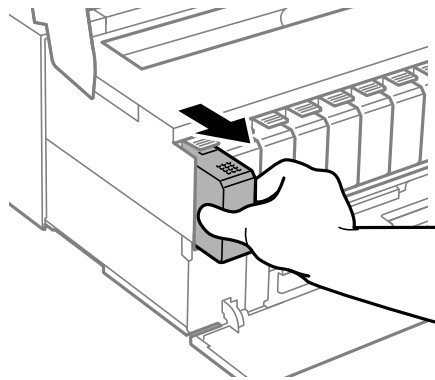

Warning: If ink gets on your skin, wash it thoroughly with soap and water. If ink gets into your eyes, flush them immediately with water. If discomfort or vision problems persist, see a doctor immediately. If ink gets into your mouth, spit it out and see a doctor right away. Keep ink cartridges out of the reach of children.

Note: Dispose of used cartridges carefully. Do not take the used cartridge apart or try to refill it.

6. Gently shake the new ink cartridge about 15 times.

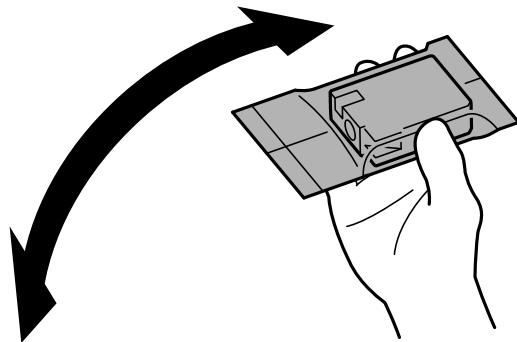

7. Remove the new ink cartridge from the package.

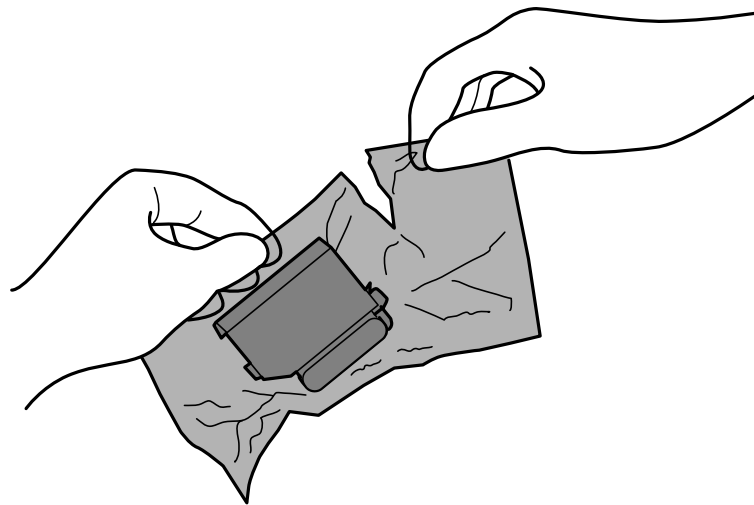

Caution: Do not touch the areas shown here; doing so may prevent normal operation and printing.

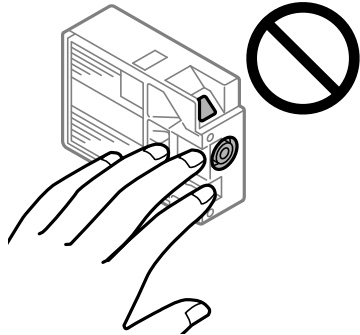

8. Insert the new cartridge into the ink cartridge holder until it clicks into place.

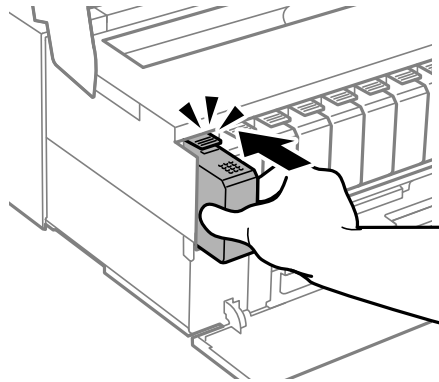

9. After you replace all the cartridges that need replacing, close the printer cover.

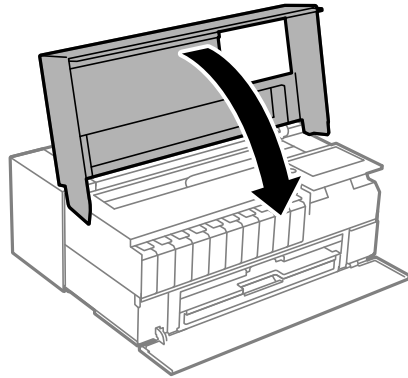

10. Close the front cover.

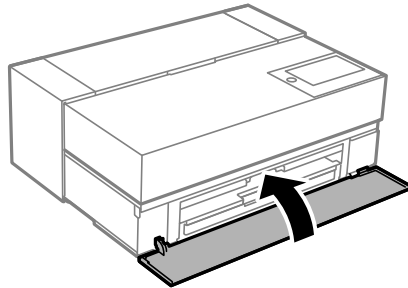

Your product begins charging the ink delivery system.

Caution: If you remove an ink cartridge for later use, protect the ink supply area from dirt and dust and store it in the same environment as the printer. The valve in the ink supply is designed to contain any excess ink, but do not touch the ink supply port or surrounding area.

Parent topic: [Replacing Ink Cartridges and Maintenance Boxes](#)

Maintenance Box Replacement

The maintenance box stores surplus ink that gets collected during printing or print head cleaning. When you see a message on the LCD screen, follow the on-screen instructions to replace the maintenance box.

Note the following precautions when replacing the maintenance box:

- Do not remove the maintenance box or its cover except when replacing the maintenance box; otherwise, ink may leak.
- Do not touch the green chip on the side of the maintenance box.
- Do not tilt the maintenance box after removing it or ink may leak.
- Do not touch the openings in the maintenance box or you may get ink on you.
- Do not drop the maintenance box or subject it to strong shocks.
- If you cannot replace the cover, the maintenance box may not be installed correctly. Remove and reinstall the maintenance box.
- Do not store the maintenance box in high or freezing temperatures.
- Do not replace the maintenance box during printing; otherwise, ink may leak.
- Keep the maintenance box out of direct sunlight.

Caution: Do not reuse a maintenance box that has been removed and left uninstalled for a long period. Keep the maintenance box away from direct sunlight.

Note: The maintenance box is a user-replaceable part and is not covered by the product warranty.

Parent topic: [Replacing Ink Cartridges and Maintenance Boxes](#)

Adjusting Print Quality

If your print quality declines, you may need to run a utility to clean or align the print head.

If running these utilities does not solve the problem, you may need to replace the ink cartridges.

[Print Head Maintenance](#)

[Print Head Alignment](#)

[Cleaning the Paper Guide](#)

Print Head Maintenance

If your printouts become too light, or you see dark or light bands across them, you may need to clean the print head nozzles. Cleaning uses ink, so clean the nozzles only if print quality declines.

You can check for clogged nozzles before you clean them so you don't clean them unnecessarily.

Note: You cannot clean the print head if an ink cartridge is expended, and may not be able to clean it when a cartridge is low. You must replace the cartridge first.

[Print Head Nozzle Check](#)

[Print Head Cleaning](#)

Parent topic: [Adjusting Print Quality](#)

Print Head Nozzle Check

You can print a nozzle check pattern to check for clogged nozzles.

[Checking the Nozzles Using the Product Control Panel](#)

[Checking the Nozzles Using a Computer Utility](#)

Parent topic: [Print Head Maintenance](#)

Checking the Nozzles Using the Product Control Panel

You can check the print head nozzles using the control panel on your product.

1. Load a few sheets of plain paper in the rear paper feeder.
2. Select the  icon on the LCD screen
3. Select **Maintenance** > **Print Head Nozzle Check**.
4. Select **Start**.

The nozzle pattern prints.

5. Check the printed pattern to see if there are gaps in the lines.

Print head is clean

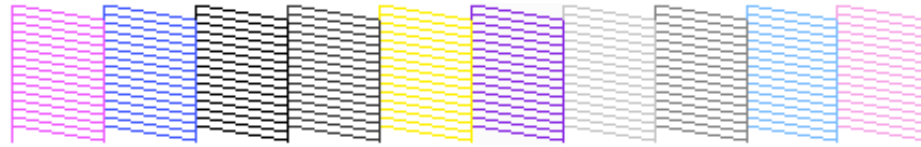

Print head needs cleaning

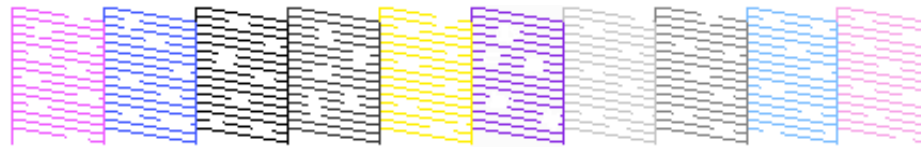



6. Do one of the following:
 - If there are no gaps, select **O**.
 - If there are gaps or the pattern is faint, select **X** and continue.
7. Follow the instructions on the screen to clean the print head, check the nozzles, and repeat the process as necessary.

Parent topic: [Print Head Nozzle Check](#)

Checking the Nozzles Using a Computer Utility

You can check the print head nozzles using a utility on your Windows or Mac computer.

1. Load a few sheets of plain paper in the rear paper feeder.
2. Do one of the following:
 - **Windows:** Access the Windows Desktop and right-click the  icon for your product in the right side of the Windows taskbar, or click the up arrow and right-click .
 - **Mac:** In the Apple menu or the Dock, select **System Preferences**. Select **Print & Fax**, **Print & Scan**, or **Printers & Scanners**, select your product, and select **Options & Supplies**. Select **Utility** and select **Open Printer Utility**.

3. Select **Print Head Nozzle Check**.

You see a window like this:

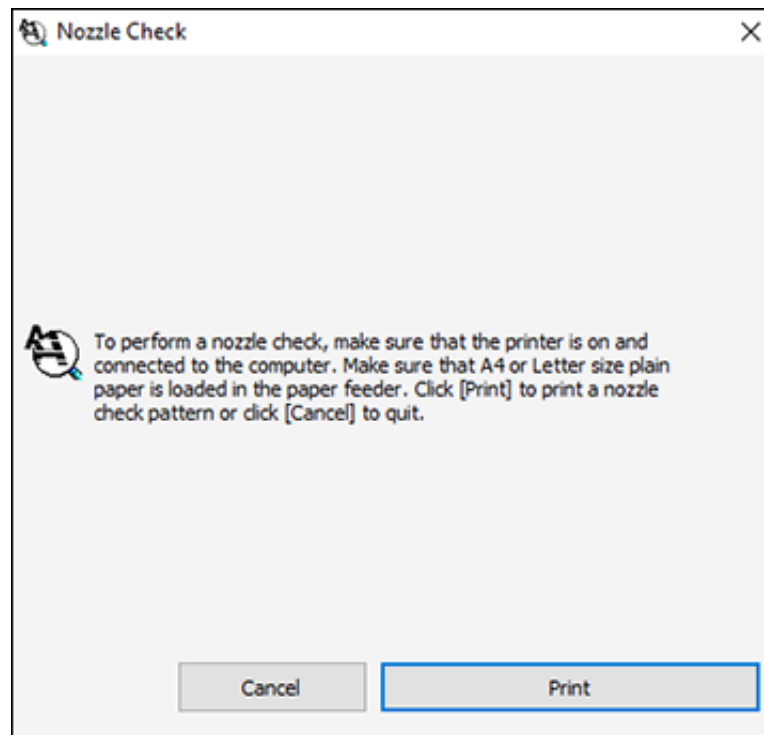

4. Click **Print**.

5. Check the printed pattern to see if there are gaps in the lines.

Print head is clean

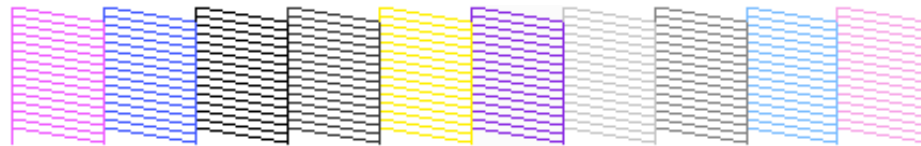

Print head needs cleaning

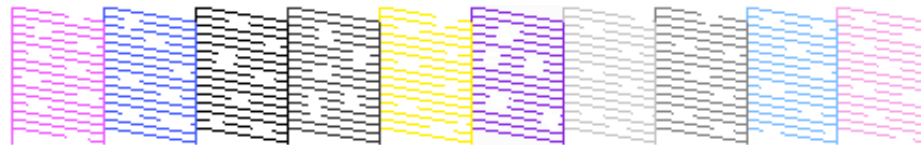

6. If there are no gaps, click **Finish**.

If there are gaps or the pattern is faint, clean the print head. If almost the entire pattern is missing, see the link below for instructions on performing a Power Cleaning.

Parent topic: [Print Head Nozzle Check](#)

Print Head Cleaning

If print quality has declined and the nozzle check pattern indicates clogged nozzles, you can clean the print head.

Note: You cannot clean the print head if an ink cartridge is expended, and may not be able to clean it when a cartridge is low. You must replace the cartridge first.

[Cleaning the Print Head Using the Product Control Panel](#)

[Cleaning the Print Head Using a Computer Utility](#)

[Running a Power Cleaning Using the Product Control Panel](#)

Parent topic: [Print Head Maintenance](#)

Cleaning the Print Head Using the Product Control Panel

You can clean the print head using the control panel on your product.

1. Load a few sheets of plain paper in the rear paper feeder.
2. Select the  icon on the LCD screen
3. Select **Maintenance** > **Print Head Nozzle Check**.
4. Select **Start**.

When the cleaning cycle is finished, you see a message on the screen.

Caution: Never turn off the product during a cleaning cycle or you may damage it.

5. Check the printed pattern to see if there are gaps in the lines.

Print head is clean

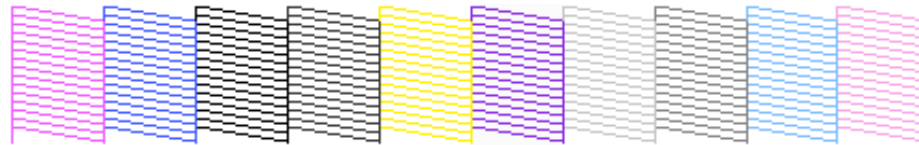

Print head needs cleaning

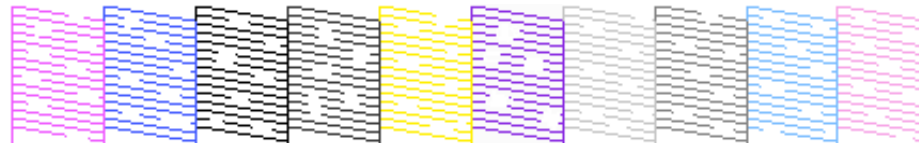



- If there are no gaps, select **O**.
 - If there are gaps or the pattern is faint, select **X** and continue.
6. Follow the instructions on the screen to clean the print head, check the nozzles, and repeat the process as necessary.

If you don't see any improvement after cleaning the print head up to 3 times, wait at least 6 hours. Then try cleaning the print head again. If quality still does not improve, one of the ink cartridges may be old or damaged and needs to be replaced.

Parent topic: [Print Head Cleaning](#)

Cleaning the Print Head Using a Computer Utility

You can clean the print head using a utility on your Windows or Mac computer.

1. Load a few sheets of plain paper in the rear paper feeder.
2. Do one of the following:
 - **Windows:** Access the Windows Desktop and right-click the  icon for your product in the right side of the Windows taskbar, or click the up arrow and right-click .
 - **Mac:** In the Apple menu or the Dock, select **System Preferences**. Select **Print & Fax**, **Print & Scan**, or **Printers & Scanners**, select your product, and select **Options & Supplies**. Select **Utility** and select **Open Printer Utility**.
3. Select **Print Head Cleaning**.

You see a window like this:

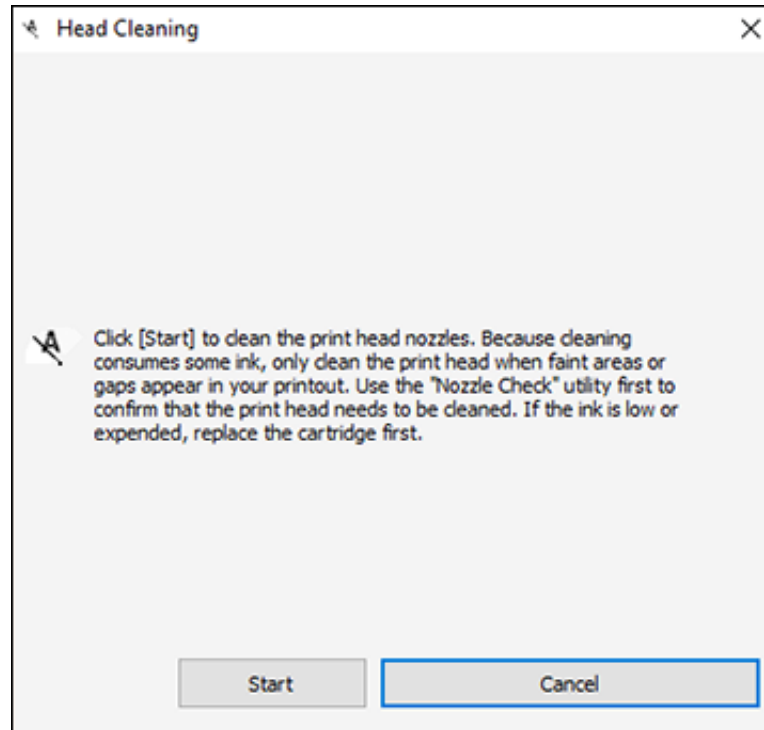

4. Click **Start** to begin the cleaning cycle.
You see a message on the computer screen during the cleaning cycle.

Caution: Never turn off the product during a cleaning cycle or you may damage it.

5. When the cleaning cycle is finished, you can check to see if the nozzles are clean; click **Print Nozzle Check Pattern** and click **Print**.
6. Check the printed pattern to see if there are gaps in the lines.

Print head is clean

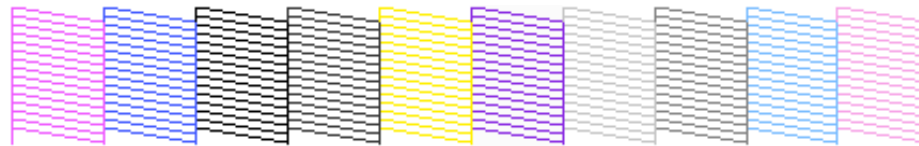

Print head needs cleaning

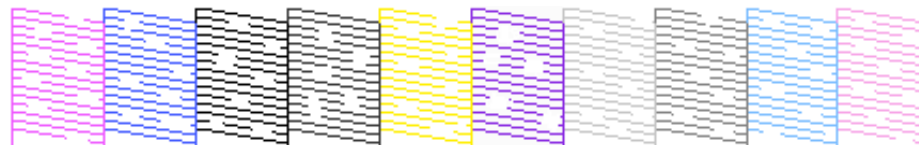

- If there are no gaps, click **Finish**.
- If there are gaps or the pattern is faint, click **Clean** to clean the print head again.

If you don't see any improvement after cleaning the print head up to 3 times, turn off the product and wait at least six hours. Then try cleaning the print head again. If quality still does not improve, run a Power Cleaning. If there is still no improvement, contact Epson support.

Parent topic: [Print Head Cleaning](#)

Running a Power Cleaning Using the Product Control Panel

If print head nozzles are still clogged after cleaning the print head several times, run the **Power Cleaning** utility from the product control panel. This process consumes a lot of ink to clean the clogged nozzles.

1. Load a few sheets of plain paper in the rear paper feeder.

2. Select the  icon on the LCD screen
3. Select **Maintenance > Power Cleaning**.
4. Select **Start** to begin the power cleaning cycle.

Caution: Never turn off the product during a cleaning cycle or you may damage it.

5. When the cleaning cycle is finished, print the nozzle check pattern again to see if any nozzles are still clogged.

If nozzles are still clogged, wait for at least 6 hours without printing. Then try cleaning the print head again. If there is still no improvement, contact Epson for support.

Parent topic: [Print Head Cleaning](#)

Print Head Alignment

If your printouts become grainy or blurry, you notice misalignment of vertical lines, or you see dark or light horizontal bands, you may need to align the print head.

Note: Banding may also occur if your print head nozzles need cleaning.

[Aligning the Print Head Using the Product Control Panel](#)

[Aligning the Print Head Using a Computer Utility](#)

Parent topic: [Adjusting Print Quality](#)

Aligning the Print Head Using the Product Control Panel

You can align the print head using the control panel on your product.

1. Load a few sheets of plain paper in the rear paper feeder.
2. Select the  icon on the LCD screen
3. Select **Maintenance > Print Head Alignment**.
4. Select **Start** to print an alignment sheet.

Note: Do not cancel printing while you are printing head alignment patterns.



After the alignment sheet is printed, you see a series of screens asking you to select the best square in each pattern set.

5. Check the printed pattern and follow the on-screen instructions to choose the number of the best printed pattern for each set.

Parent topic: [Print Head Alignment](#)

Aligning the Print Head Using a Computer Utility

You can align the print head using a utility on your Windows or Mac computer.

1. Load a few sheets of plain paper in the product.
2. Do one of the following:
 - **Windows:** Access the Windows Desktop and right-click the  icon for your product in the right side of the Windows taskbar, or click the up arrow and right-click .
 - **Mac:** In the Apple menu or the Dock, select **System Preferences**. Select **Print & Fax**, **Print & Scan**, or **Printers & Scanners**, select your product, and select **Options & Supplies**. Select **Utility** and select **Open Printer Utility**.
3. Select **Print Head Alignment**.
4. Click **Next**, then click **Print** to print an alignment sheet.

Note: Do not cancel printing while you are printing a head alignment pattern.

You see a window like this:

5. Check the printed pattern and follow the instructions on the screen to choose the number of the best printed pattern for each set.

#1

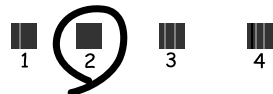

- After choosing a pattern number, click **Next**.
- If no patterns are aligned in one or more of the sets, choose the closest one in each set and click **Realignment**. Then print another alignment sheet and check it.

Note: Click **Skip** (where available) if you want to skip a particular alignment sheet.

6. When you are done, click **Finish**.

Parent topic: [Print Head Alignment](#)

Cleaning the Paper Guide

If you see ink on the back of a printout, you can clean the paper guide rollers to remove any excess ink.

1. Load a few sheets of the following size paper in the rear paper feeder: A3 (11.7 × 16.5 inches [297 × 420 mm]) or A3+ (13 × 19 inches [329 × 483 mm]) for SureColor P700 and A2 (16.5 × 23.4 inches [420 × 594 mm]) for SureColor P900.
2. Select the  icon on the LCD screen.
3. Select **Maintenance > Paper Guide Cleaning**.
4. Follow the on-screen instructions to clean the paper path.
5. Repeat these steps as necessary until no smeared ink appears on your printouts.

Parent topic: [Adjusting Print Quality](#)

Maintenance and Transportation

See the instructions in these sections to maintain your printer for optimum results, or to move or transport your printer.

[Cleaning Your Product](#)

[Transporting Your Product](#)

Cleaning Your Product

To keep your product working at its best, you should clean it several times a year.

Caution: Do not use a hard brush, benzene, alcohol, or paint thinner to clean the product or you may damage it. Do not place anything on top of the cover or use the cover as a writing surface, or it could get permanently scratched. Do not use oil or other lubricants inside the product or let water get inside.

1. Turn off the product.
2. Unplug the power cable.
3. Disconnect any connected cables.
4. Remove all the paper and the roll paper unit from the product.
5. Close the paper support, rear paper feeder, output tray, and any covers.
6. Clean the outer case, except for the front cover, with a soft cloth dampened with a mild detergent. For the front cover, use a feather duster to clean the surface.
7. Plug the power cable back in and turn on the product.
8. Load several sheets of plain paper (or a cleaning sheet) in the sheet feeder and clean the paper guide.

Close the rear paper support and output tray when you are not using the product to help keep it clean.

Parent topic: [Maintenance and Transportation](#)

Transporting Your Product

If you need to store your product or transport it a long distance, prepare it for transportation as described here.

Caution: During transportation and storage, follow these guidelines:

- Avoid tilting the product, placing it vertically, or turning it upside down; otherwise ink may leak.

- Leave the ink cartridges installed. Removing the cartridges can dry out the print head and may prevent the product from printing.

Note: Before storing your product for a long period, replace low, expended, or expired ink to help prevent the print head from drying out. Store your product in a cool, dry place.

1. Turn off the product.
2. Unplug the power cable.
3. Disconnect any connected cables.
4. Remove all the paper from the product.
5. Open the printer cover and secure the print head to the case with tape.
6. Close the printer cover.
7. Prepare the printer for transportation as shown.
8. Place the product in its original packing materials, if possible, or use equivalent materials with cushioning around the product. Make sure the box adequately protects the product control panel.
9. After unpacking the product, be sure to remove the tape from the print head.

Keep the product level during transportation. If print quality has declined when you print again, clean and align the print head.

Parent topic: [Maintenance and Transportation](#)

Solving Problems

Check these sections for solutions to problems you may have using your product.

[Checking for Software Updates](#)

[Product Status Messages](#)

[Running a Product Check](#)

[Resetting Control Panel Defaults](#)

[Solving Setup Problems](#)

[Solving Network Problems](#)

[Solving Paper Problems](#)

[Solving Problems Printing from a Computer](#)

[Solving Page Layout and Content Problems](#)



[Solving Print Quality Problems](#)

[Uninstall Your Product Software](#)

[Where to Get Help](#)

Checking for Software Updates

Periodically, it's a good idea to check Epson's support website for free updates to your product software. Visit epson.com/support (U.S.), epson.ca/support (Canada), or epson.com.jm/support (Caribbean) and select your product.

- **Windows:** Your printer software automatically checks for updates. You can also manually update the software by:
 - Accessing the Windows Desktop and right-clicking the  icon for your product in the right side of the Windows taskbar, or clicking the up arrow and right-clicking . Select **Software Update**.
 - Clicking on the **Utility** tab in the printer settings window and selecting **Driver Update**

You can also update the software by selecting **EPSON Software Updater** in the **EPSON** or **EPSON Software** program group, accessible by the **Start** button, or on the **Start** or **Apps** screens, depending on your version of Windows.

- **OS X:** You can manually update the software by opening the **Applications > Epson Software** folder and selecting **EPSON Software Updater**.

Parent topic: [Solving Problems](#)

Product Status Messages

You can often diagnose problems with your product by checking the messages on its LCD screen.

Note: If the LCD screen is dark, press the screen to wake the product from sleep mode.

LCD screen message	Condition/solution
The combination of the IP address and the subnet mask is invalid. See your documentation for more details.	There is a problem with the network configuration of your product. Enter the correct IP address or default gateway. If applicable, contact your network administrator for assistance.
Ink is low.	The ink cartridge is low. You can continue printing until you are prompted to replace the cartridge. Make sure you have the replacement cartridge ready.
Ink cartridge(s) are low. Print job may not print completely.	Select Continue printing or Replace before printing . If the product runs out of ink in the middle of the print job, the product will stop printing and you will be given the option to replace the ink cartridge. The color of your print job may be slightly different after replacing an ink cartridge.
You need to replace Ink Cartridge(s).	The ink cartridge is expended. Replace the cartridge.
To use cloud services, update the root certificate from the Epson Web Config utility.	Access your product's built-in Web Config utility and update the root certificate for your product.
The printer's Ink Pad is nearing the end of its service life. It is not a user-replaceable part. Please contact Epson support.	The ink pad is near the end of its service life and the message will be displayed until the ink pad is replaced. Contact Epson for support. (To resume printing, select OK .)
The printer's Ink Pad has reached the end of its service life. It is not a user-replaceable part. Please contact Epson support.	The ink pad is at the end of its service life. Contact Epson for support.
The ink pad has reached the end of its service life. It is not a user-replaceable part. Please contact Epson support. If you use it as is, printing speed on [paper type] may slow down.	

LCD screen message	Condition/solution
Printer error. Turn the power off and on again. If the problem persists, contact Epson Support.	A serious error has occurred. Turn the product off and then back on again. If the error continues, check for a paper jam. If there is no paper jam, contact Epson for support.
Paper Setup Auto Display is set to Off. Some features may not be available. For details, see your documentation.	If Paper Setup Auto Display setting is disabled, you cannot use AirPrint.
Recovery Mode Update Firmware	An error has occurred during firmware updating. Connect your product using a USB cable and try updating the firmware again. If you still receive this error message, contact Epson for support.

Note: The ink pads in the printer collect, distribute, and contain the ink that is not used on printed pages. During the life of your product it may reach a condition where either satisfactory print quality cannot be maintained or the ink pads have reached the end of their usable life. The Epson Status Monitor, your LCD screen, or lights on the control panel will advise you when these parts need replacing. If this happens during the standard warranty of the product, the exchange of the product or replacement of the pads is covered under the standard warranty. If the product is out of warranty, the pads can be replaced by any Epson authorized service provider. The waste ink pads are not a user-replaceable part.

Parent topic: [Solving Problems](#)

Running a Product Check

Running a product check helps you determine if your product is operating properly.

1. Disconnect any interface cables connected to your product.
2. Make sure plain paper is loaded in the rear paper feeder.
3. Select the  icon on the LCD screen
4. Select **Maintenance > Print Head Nozzle Check**.
5. Follow the on-screen instructions to print the nozzle check pattern.
The nozzle pattern prints.
6. Do one of the following, depending on the results of the product check:
 - If the page prints and the nozzle check pattern is complete, the product is operating properly. Any operation problem you may have could be caused by your computer, cable, software, or selected

settings. Check the other solutions in this manual or try uninstalling and reinstalling your printer software.

- If the page prints but the nozzle check pattern has gaps, clean or align the print head.
- If the page does not print, the product may have a problem. Check the other solutions available. If they do not work, contact Epson.

Parent topic: [Solving Problems](#)

Resetting Control Panel Defaults

If you have a problem with settings on the product control panel, you can reset them to their factory defaults. You can choose which settings to reset or reset them all.

1. Select the  icon on the LCD screen
2. Select **General Settings > Restore Default Settings**.
3. Select one of these options:
 - **Network Settings**: Resets all network settings.
 - **All except Network Settings**: Resets all except network settings.
 - **Clear All Data and Settings**: Resets all control panel settings.

Parent topic: [Solving Problems](#)

Solving Setup Problems

Check these sections if you have problems while setting up your product.

[Noise After Ink Installation](#)

[Software Installation Problems](#)

Parent topic: [Solving Problems](#)

Noise After Ink Installation

If you hear noises from your product after installing ink, check the following:

- The first time you install the ink cartridges, the product must charge its print head. Wait until charging finishes before you turn off the product, or it may charge improperly and use excess ink the next time you turn it on.
- If the product's print head stops moving or making noise, and the charging process has not finished after approximately 5 minutes, turn off your product. Turn it back on and check to see if charging is still in progress. If it is still in progress, contact Epson for help.

Parent topic: [Solving Setup Problems](#)

Software Installation Problems

If you have problems while installing your product software, try these solutions:

- Make sure your product is turned on and any necessary cables are securely connected at both ends. If you still have problems installing software, disconnect the cable and carefully follow the instructions on the *Start Here* sheet. Also make sure your system meets the requirements for your operating system.
- Close any other programs, including screen savers and virus protection software, and install your product software again.
- In Windows, make sure your product is selected as the default printer and the correct port is shown in the printer properties.
- If you see any error message or your software does not install correctly in Windows, you may not have software installation privileges. Contact your system administrator.
- If you are printing over a network, make sure your product is set up properly on the network.

Parent topic: [Solving Setup Problems](#)

Solving Network Problems

Check these solutions if you have problems setting up or using your product on a network.

[Product Cannot Connect to a Wireless Router or Access Point](#)

[Network Software Cannot Find Product on a Network](#)

[Product Does Not Appear in Mac Printer Window](#)

[Cannot Print Over a Network](#)

Parent topic: [Solving Problems](#)

Product Cannot Connect to a Wireless Router or Access Point

If your product has trouble finding or connecting to a wireless router or access point, try these solutions:

- If you are connecting the product via Wi-Fi Protected Setup (WPS) and the Wi-Fi icon on your product's LCD screen is not lit or does not appear, make sure you select one of the WPS options from the product control panel within 2 minutes of pressing the WPS button on your router.
- Make sure to place your product within contact range of your router or access point. Avoid placing your product near a microwave oven, cordless phone, or large metal object, such as a filing cabinet.

Note for Latin America: If you are using a 5 GHz wireless router, set the router to operate in dual band (2.4 GHz and 5 GHz) mode. If your router uses a single network name (SSID) for both the 2.4 GHz and 5 GHz band, give each band its own network name (SSID) instead, such as Home Network 2.4 GHz and Home Network 5 GHz. See your router documentation or contact your internet service provider for instructions.

- Verify that your router or access point is operating correctly by connecting to it from your computer or another device.
- Print a network connection report and check the codes and messages on the report to help determine the cause of the problem.
- You may need to disable the firewall and any anti-virus software on your wireless router or access point.
- Try restarting your router following the instructions in your router documentation.

Note: If you are reading these instructions online, you will lose your Internet connection when you restart your router.

- Check to see if access restrictions, such as MAC address filtering, are set on the router or access point. If access restrictions are set, add your product's MAC address to your router's address list. To obtain your product's MAC address, print a network status sheet. Then follow the instructions in your router or access point documentation to add the address to the list.
- If your router or access point does not broadcast its network name (SSID), follow the instructions that came with your product to enter your wireless network name manually.
- If your router or access point has security enabled, determine the kind of security it is using and any required password or passphrase for connection. Then make sure to enter the exact WEP key or WPA passphrase correctly.
- Check if your computer is restricting the available wireless channels. If so, verify that your wireless access point is using one of the usable channels and change to a usable channel, if necessary.
- If you cannot connect your product to a device using Wi-Fi Direct, you may have exceeded the maximum number of devices connected to your product (8). Print a network status sheet or access Web Config on the browser for your device and check the number of connected devices. If 8 devices are already connected, disconnect a device by deleting the product's SSID from the Wi-Fi screen of that device. If fewer than 8 devices are connected, check the accuracy of your other network settings, move your device closer to your product, and try connecting again.
- If you are using a Wi-Fi Direct connection that suddenly disconnects, the Wi-Fi direct password on your device may have been changed. If necessary, delete the existing **DIRECT-xxxxxxx** connection settings from your device and enter a new password. See your device documentation for instructions.

- If you connected your product to a Windows computer using Wi-Fi Direct and it automatically selected Access Point Mode, you may have trouble accessing a low-priority Internet connection. Check the network connection or adapter settings in the Windows Control Panel and set the **Internet metric** setting to **100** for your version of the Internet Protocol.

Parent topic: [Solving Network Problems](#)

Network Software Cannot Find Product on a Network

If EpsonNet Setup cannot find your product on a network, try these solutions:

- Make sure your product is turned on and connected to your network. Verify the connection using your product control panel.
- Check if your network name (SSID) contains non-ASCII characters. Your product cannot display non-ASCII characters.
- Print a network connection report and check the codes and messages on the report to help determine the cause of the problem.
- Make sure your product is not connected to a guest network.
- If necessary, reinstall your product software and try running EpsonNet Setup again:
 1. Reset your product's network settings to their factory defaults.
 2. **Windows only:** Uninstall your product software.
 3. Restart your router following the instructions in your router documentation.

Note: If you are reading these instructions online, you will lose your Internet connection when you restart your router, so note the next step before restarting it.

4. Download your product software from the Epson website using the instructions on the *Start Here* sheet.
- If you have replaced your router, reinstall your product software to connect to the new router.

Note for Latin America: If you are using a 5 GHz wireless router, set the router to operate in dual band (2.4 GHz and 5 GHz) mode. If your router uses a single network name (SSID) for both the 2.4 GHz and 5 GHz band, give each band its own network name (SSID) instead, such as Home Network 2.4 GHz and Home Network 5 GHz. See your router documentation or contact your internet service provider for instructions.

- Check to see if your wireless router or access point has an enabled Privacy Separator function that is preventing detection of your device over the network. See your router or access point documentation for instructions on disabling the Privacy Separator function.

Parent topic: [Solving Network Problems](#)

Product Does Not Appear in Mac Printer Window

If your product does not appear in the Mac printer window, try these solutions:

- Turn your product off, wait 30 seconds, then turn it back on again.
- If you are connecting the product wirelessly via EpsonNet Setup and a WiFi symbol is not displayed on the product's LCD screen, make sure your product software was installed correctly. If necessary, reinstall your software.
- Make sure you installed your product software correctly for your network. See the *Start Here* sheet for instructions.
- If your Mac includes both wired and wireless network services, make sure the network to which you connected your product is at the top of the Set Service Order list. Check your Mac documentation for instructions.

Note for Latin America: If you are using a 5 GHz wireless router, set the router to operate in dual band (2.4 GHz and 5 GHz) mode. If your router uses a single network name (SSID) for both the 2.4 GHz and 5 GHz band, give each band its own network name (SSID) instead, such as Home Network 2.4 GHz and Home Network 5 GHz. See your router documentation or contact your internet service provider for instructions.

- Parent topic: [Solving Network Problems](#)

Cannot Print Over a Network

If you cannot print over a network, try these solutions:

- Make sure that your product is turned on.
- Make sure you install your product's network software as described in your product documentation.
- Print a network status sheet and verify that the network settings are correct. If the network status is **Disconnected**, check any cable connections and turn your product off and then on again.
- Print a network connection report and check the codes and messages on the report to help determine the cause of the problem.
- If you are using TCP/IP, make sure the product's IP address is set correctly for your network. If your network does not assign IP addresses using DHCP, set the IP address manually.

- Make sure your computer and product are both using the same wireless network.
- If network printing is slow, print a network status sheet and check the signal strength. If it is poor, place your product closer to your router or access point. Avoid placing your product near a microwave oven, cordless phone, or large metal object, such as a filing cabinet.

Note for Latin America: If you are using a 5 GHz wireless router, set the router to operate in dual band (2.4 GHz and 5 GHz) mode. If your router uses a single network name (SSID) for both the 2.4 GHz and 5 GHz band, give each band its own network name (SSID) instead, such as Home Network 2.4 GHz and Home Network 5 GHz. See your router documentation or contact your internet service provider for instructions.

- Try restarting your router following the instructions in your router documentation.

Note: If you are reading these instructions online, you will lose your Internet connection when you restart your router.

- Check if there are any paused print jobs.
- Make sure your printer is selected as the default printer.
- Check to see if your wireless router or access point has an enabled Privacy Separator function that is preventing printing from a device over the network. See your router or access point documentation for instructions on disabling the Privacy Separator function.
- If you are connecting the product via Wi-Fi Protected Setup (WPS) and the Wi-Fi icon on your product's LCD screen is not lit, make sure you select one of the WPS options from the product control panel within 2 minutes of pressing the WPS button on your router.
- Check your wired LAN router or access point to see if the LED for the port to which your product is connected is on or flashing. If the link LED is off, try the following:
 - Make sure the Ethernet cable is securely connected to your product and to your router, access point, switch, or hub.
 - Try connecting your product to a different port or a different router, access point, switch, or hub.
 - Try connecting with a different Ethernet cable.
 - Try printing to your product from another computer on the network.

Parent topic: [Solving Network Problems](#)

Solving Paper Problems

Check these sections if you have problems using paper with your product.

[Paper Feeding Problems](#)

[Paper Ejection Problems](#)

Parent topic: [Solving Problems](#)

Paper Feeding Problems

If you have problems feeding paper, try these solutions:

- If paper does not feed into the sheet feeder, remove the paper and fan the edges to separate the sheets. Reload paper against the right side and slide the edge guide against it. Do not load too many sheets in the sheet feeder at once and make sure the product cover is closed.
- When using the sheet feeder, do not load paper above the arrow mark on the left edge guide. Load only one sheet of compatible paper when using the front manual feed tray.
- Load only one sheet of media in the front manual feed tray. For posterboard, make sure there is enough space behind the product for the media to feed through.
- If multiple pages feed at once, remove the paper, fan the edges to separate the sheets, and reload it.
- If you can not insert paper easily into the front manual feed tray, make sure the paper is perfectly flat and not curled.
- If you are printing on roll paper or with the sheet feeder, make sure the manual feed tray is not extended. Extend it only to load fine art paper or posterboard.
- If paper loaded using the front manual feed tray does not feed, make sure you installed the paper correctly and guided it all the way into the product.
- Do not load more than the recommended number of sheets.
- Make sure paper is loaded in the correct orientation. Load cut sheets in the sheet feeder vertically.
- Make sure your paper meets the specifications for your product.
- If paper dust builds up on the rollers, they may lose traction and become unable to feed paper properly. Clean the paper guide.
- If roll paper does not feed, cut the end straight across and uncurl it by rolling it backward, if necessary. Then reload the paper.
- If thick media does not feed, make sure you are loading it straight into the product, not at an angle.
- If paper jams when you print on both sides of the paper, try loading fewer sheets.
- For best results, follow these guidelines:
 - Use new, smooth, high-quality paper that is not damp, curled, creased, old, too thin, or too thick.
 - Load paper printable side up.

- Follow any special loading instructions that came with the paper.

Parent topic: [Solving Paper Problems](#)

Paper Ejection Problems

If you have problems with paper ejecting properly, try these solutions:

- If paper does not eject fully, you may have set the wrong paper size. Cancel printing using the product control panel, then select the option to cut or eject the paper. Remove any paper remaining in the product. Select the correct size when you reprint.
- If paper is wrinkled when it ejects, it may be damp or too thin. Load new paper and be sure to select the correct paper type setting in your printer software when you reprint.

Parent topic: [Solving Paper Problems](#)

Solving Problems Printing from a Computer

Check these sections if you have problems while printing from your computer.

[Nothing Prints](#)

[Product Icon Does Not Appear in Windows Taskbar](#)

[Error After Cartridge Replacement](#)



[Printing is Slow](#)

Parent topic: [Solving Problems](#)

Nothing Prints

If you have sent a print job and nothing prints, try these solutions:



- Make sure your product is turned on.
- Make sure any interface cables are connected securely at both ends.
- If you connected your product to a USB hub, make sure it is a first-tier hub. If it still does not print, connect your product directly to your computer instead of the hub.
- Run a product check to see if a test page prints. If the test page prints, check to see if your product software is installed correctly.
- In Windows, make sure your product is selected as the default printer.

- In Windows, clear any stalled print jobs from the Windows Spooler:
 - **Windows 10:** Click  and select  (Settings) > **Devices > Printers & scanners**. Select your product name and select **Manage > Open print queue**. Right-click the stalled print job, click **Cancel**, and click **Yes**.
 - **Windows 8.x:** Navigate to the **Apps** screen and select **Control Panel > Hardware and Sound > Devices and Printers**. Right-click your product name, select **See what's printing**, and select your product name again if necessary. Right-click the stalled print job, click **Cancel**, and click **Yes**.
 - **Windows 7:** Click  and select **Devices and Printers**. Right-click your product name, select **See what's printing**, and select your product name again, if necessary. Right-click the stalled print job, click **Cancel**, and click **Yes**.

Parent topic: [Solving Problems Printing from a Computer](#)

Product Icon Does Not Appear in Windows Taskbar

If you do not see your product icon in the Windows taskbar, first try restarting your computer. If that does not work, try this solution:

1. Do one of the following:
 - **Windows 10:** Click  and select  (Settings) > **Devices > Printers & scanners**. Select your product name and select **Manage > Printing preferences**.
 - **Windows 8.x:** Navigate to the **Apps** screen and select **Control Panel > Hardware and Sound > Devices and Printers**. Right-click your product name, select **Printing Preferences**, and select your product name again if necessary.
 - **Windows 7:** Click  and select **Devices and Printers**. Right-click your product name, select **Printing Preferences**, and select your product name again if necessary.
2. Click the **Utility** tab.
3. Click the **Monitoring Preferences** button.
4. Click the checkbox for the option that adds the shortcut icon to the taskbar.
5. Click **OK** to close the open program windows.

Parent topic: [Solving Problems Printing from a Computer](#)

Error After Cartridge Replacement

If you see an error message after you replace an ink cartridge, follow these steps:

1. Remove and reinsert the replaced ink cartridge, making sure to push it all the way into its slot.

2. Complete the ink cartridge installation steps.

Parent topic: [Solving Problems Printing from a Computer](#)

Printing is Slow

If printing becomes slow, try these solutions:

- Make sure your system meets the requirements for your operating system. If you are printing a high-resolution image, you may need more than the minimum requirements. If necessary, increase your system's memory.
- If you are using Windows 7, close the **Devices and Printers** window before you print.
- On a Mac, make sure you download and install the Epson printer driver.
- Clear space on your hard drive or run a defragmentation utility to free up existing space.
- Close any programs you are not using when you print.
- If your product is connected to a USB hub, connect it directly to your computer instead.
- If printing becomes slower after printing continuously for a long time, the product may have automatically slowed down to protect the print mechanism from overheating or becoming damaged. Let the product rest with the power on for 30 minutes, then try printing again.
- If you are printing over a wireless network, factors such as interference, network traffic, or weak signal strength may affect your printing speed.

Note for Latin America: If you are using a 5 GHz wireless router, set the router to operate in dual band (2.4 GHz and 5 GHz) mode. If your router uses a single network name (SSID) for both the 2.4 GHz and 5 GHz band, give each band its own network name (SSID) instead, such as Home Network 2.4 GHz and Home Network 5 GHz. See your router documentation or contact your internet service provider for instructions.

For the fastest printing, select the following settings in your product software:

- Make sure the paper type setting matches the type of paper you loaded.
- Turn on any high speed settings in your product software.
- Select a lower print quality setting.
- **Windows:** Click the **Maintenance** or **Utility** tab, select **Extended Settings** or **Speed and Progress**, and select the following settings:
 - **Always Spool RAW Datatype**
 - **Page Rendering Mode**

- **Print as Bitmap**

If printing is still slow and you are using Windows 7 or Windows Vista, try the following:

1. Click  and select **Computer** or **My Computer**. Double-click the **C:** drive and open these folders: **ProgramData > EPSON > PRINTER**.

Note: If you do not see the ProgramData folder, open the **Organize** menu and select **Folder and search options**. In the window that appears, click the **View** tab, select **Show hidden files, folders, and drives** in the Advanced settings list, and click **OK**.

2. Right-click the **EPAUDF01.AUD** file and select **Delete**.
3. Restart your computer and try printing again.

Parent topic: [Solving Problems Printing from a Computer](#)

Solving Page Layout and Content Problems

Check these sections if you have problems with the layout or content of your printed pages.

[Inverted Image](#)

[Too Many Copies Print](#)

[Blank Pages Print](#)

[Incorrect Margins on Printout](#)

[Border Appears on Borderless Prints](#)

[Incorrect Characters Print](#)

[Incorrect Image Size or Position](#)

[Slanted Printout](#)

Parent topic: [Solving Problems](#)

Inverted Image

If your printed image is inverted unexpectedly, try these solutions:

- Turn off any mirror or inversion settings in your printing application.
- Turn off the **Mirror Image**, **Flip horizontally**, or **Reverse page orientation** settings in your printer software. (This option has different names, depending on your operating system version.)

Parent topic: [Solving Page Layout and Content Problems](#)

Too Many Copies Print

Make sure that the **Copies** setting in your printing program or printer software is not set for multiple copies.

Parent topic: [Solving Page Layout and Content Problems](#)

Blank Pages Print

If blank pages print unexpectedly, try these solutions:

- Make sure you selected the correct paper size settings in your printing program and printer software.
- If a blank page exists in a document you are printing and you want to skip printing it, select the **Skip Blank Page** setting in your printer software, if available.
- Run a print head nozzle check to see if any of the nozzles are clogged. Then clean the print head, if necessary.
- Make sure your product is selected as the printer in your printing program.

Parent topic: [Solving Page Layout and Content Problems](#)

Incorrect Margins on Printout

If your printed page has incorrect margins, try these solutions:

- Make sure you selected the correct paper size settings in your printing program and printer software.
- Make sure you selected the correct margins for your paper size in your printing program.
- Make sure your paper is positioned correctly for feeding into the product.

You can use the preview option in your printer software to check your margins before you print.

Parent topic: [Solving Page Layout and Content Problems](#)

Border Appears on Borderless Prints

If you see a border on borderless prints, try these solutions:

- Make sure you are printing on a compatible borderless paper type and size.

Note: For custom paper sizes, make sure you select a supported borderless page width.

- **Windows:** Make sure you selected the **Borderless** setting in your printer software.
- **Mac:** Make sure you selected the **Borderless** checkbox or a paper size with a **Borderless** option in your printer software.

- Adjust the **Expansion** setting to adjust the amount of image expansion on the edges of borderless prints.
- Make sure the image size and the paper size are set correctly; if the image is small, the enlargement may not be enough to cover the paper.
- Make sure you have stored the paper correctly. Paper can expand or contract if it is not stored properly. See the instructions that came with your paper for storage instructions.

Parent topic: [Solving Page Layout and Content Problems](#)

Incorrect Characters Print

If incorrect characters appear in your prints, try these solutions before reprinting:

- Make sure any cables are securely connected at both ends.
- In Windows, delete all jobs from the Windows Spooler. Click **Print Queue** on the Maintenance tab in the printer settings window, and cancel any stalled print jobs.
- If your product is connected to a USB hub, connect it directly to your computer instead.
- If incorrect characters still appear in your prints, try connecting your product using a different cable.
- Make sure you are using the printer software for this product. Check the product name at the top of the driver window.

Parent topic: [Solving Page Layout and Content Problems](#)

Incorrect Image Size or Position

If your printed image is the wrong size or in the wrong position, try these solutions:

- Make sure you selected the correct paper size and layout settings in your printing program and printer software.
- Make sure you selected the correct paper size on the control panel.
- Make sure your paper is positioned correctly for feeding into the printer.
- Slide the edge guides against the edges of the paper.
- Make sure you selected the correct margins for your paper size in your printing program.

You can use the preview option in your printer software to check your margins before you print.

Parent topic: [Solving Page Layout and Content Problems](#)

Slanted Printout

If your printouts are slanted, try these solutions:

- Slide the edge guides against the edges of the paper.
- Select a higher print quality setting in your printer software.
- Turn off any high speed settings in your product software.
- Align the print head.
- Make sure the product is not printing while tilted or at an angle.

Parent topic: [Solving Page Layout and Content Problems](#)

Solving Print Quality Problems

Check these sections if your printouts have problems with print quality, but your image looks fine on your computer screen.

Note: When printing using AirPrint, the available print settings are different from those covered in this manual. See the Apple website for details.

[White or Dark Lines in Printout](#)

[Blurry or Smearred Printout](#)

[Faint Printout or Printout Has Gaps](#)

[Grainy Printout](#)

[Incorrect Colors](#)

Parent topic: [Solving Problems](#)

White or Dark Lines in Printout

If you notice white or dark lines in your prints (also called banding), try these solutions before you reprint:

- Run a nozzle check to see if any of the print head nozzles are clogged. Then clean the print head, if necessary.
- Make sure the paper type setting matches the type of paper you loaded.
- Make sure you loaded the printable side of the paper correctly for your product.
- Turn off any high speed settings in your product software.
- You may need to replace the ink cartridges.

Parent topic: [Solving Print Quality Problems](#)

Blurry or Smearred Printout

If your printouts are blurry or smearred, try these solutions:

- Make sure your paper is not damp, curled, old, or loaded incorrectly in your product.
- Use a support sheet with special paper, or load special paper one sheet at a time.
- Make sure your paper meets the specifications for your product.
- Use Epson papers to ensure proper saturation and absorption of genuine Epson inks.
- Make sure the paper type setting in your product software matches the type of paper you loaded.
- Make sure you loaded the printable side of the paper correctly for your product.
- If you are printing on thick paper or poster board, make sure you select the appropriate settings.
- Avoid handling printouts on glossy paper right after printing to allow the ink to set.
- Dry printouts completely before filing or displaying them. When drying printouts, avoid direct sunlight, do not use a dryer, and do not touch the printed side of the paper.
- Do not stack printouts immediately after printing.
- If you print on both sides of a sheet of paper, smudges may appear on the reverse side of heavily saturated or dark images. If one side of a sheet will contain a lighter image or text, print that side first. Adjust the density and/or ink drying time settings.
- Run a nozzle check to see if any of the print head nozzles are clogged. Then clean the print head, if necessary.
- Adjust the print quality in the product software.
- Clean the paper path.

Note: Your product will not operate properly while tilted at an angle. Place it on a flat, stable surface that extends beyond the base of the product in all directions.

Parent topic: [Solving Print Quality Problems](#)

Faint Printout or Printout Has Gaps

If your printouts are faint or have gaps, try these solutions:

- Run a nozzle check to see if any of the print head nozzles are clogged. Then clean the print head, if necessary.

- The ink cartridges may be old or low on ink, and you may need to replace them.
- Make sure the paper type setting matches the type of paper you loaded.
- Make sure your paper is not damp, curled, old, or loaded incorrectly in your product.
- Adjust the print quality in the product software.
- Clean the paper path.

Parent topic: [Solving Print Quality Problems](#)

Grainy Printout

If your printouts are grainy, try these solutions:

- Make sure you loaded the printable side of the paper correctly for your product.
- Select a higher print quality setting and turn off any high speed settings in your product software.
- Run a nozzle check to see if any of the print head nozzles are clogged. Then clean the print head, if necessary.
- Adjust the print quality in the product software.
- You may need to increase the image resolution or print a smaller size; see your software documentation.

Note: Images from the Internet may be low resolution and not result in a high quality printout.

- If you enlarged the image size in an image-editing program, you need to increase the image resolution setting to retain a high image quality. Increase the image resolution by the same amount you increase the image size. For example, if the image resolution is 300 dpi (dots per inch) and you will double the image size for printing, change the resolution setting to 600 dpi.

Note: Higher resolution settings result in larger file sizes, which take longer to process and print. Consider the limitations of your computer system when selecting a resolution, and select the lowest possible resolution that produces acceptable quality to keep file sizes manageable.

Parent topic: [Solving Print Quality Problems](#)

Incorrect Colors

If your printouts have incorrect colors, try these solutions:

- Make sure the paper type setting matches the paper you loaded.

- Make sure the **Grayscale** setting is not selected in your printer software.
- Run a nozzle check to see if any of the print head nozzles are clogged. Then clean the print head, if necessary.
- The ink cartridges may be old or low on ink, and you may need to replace them.
- After you print, the colors in your printout need time to set as the ink dries. During this time, the colors may look different than you expect. To speed up drying time, do not stack your printouts on top of each other.
- Your printed colors can never exactly match your on-screen colors. However, you can use a color management system to get as close as possible. Try using the color management options in your printer software.
- For best results, use genuine Epson paper.

Parent topic: [Solving Print Quality Problems](#)

Uninstall Your Product Software

If you have a problem that requires you to uninstall and re-install your software, follow the instructions for your operating system.



[Uninstalling Printing Software - Windows](#)

[Uninstalling Product Software - Mac](#)

Parent topic: [Solving Problems](#)

Uninstalling Printing Software - Windows

You can uninstall and then re-install your printer software to solve certain problems.

1. Turn off the product.
2. Disconnect any interface cables.
3. Do one of the following:
 - **Windows 10:** Click  and select  (Settings) > **Apps** > **Apps & features**. Select the program you want to uninstall and select **Uninstall**.
 - **Windows 8.x:** Navigate to the **Apps** screen and select **Control Panel** > **Programs** > **Programs and Features**. Select the uninstall option for your Epson product, then select **Uninstall/Change**.

Note: If you see a **User Account Control** window, click **Yes** or **Continue**.

In the next window, select your product, if necessary, and click **OK**. Then follow any on-screen instructions.

- **Windows (other versions):** Click  or **Start**, and select **All Programs** or **Programs**. Select **Epson**, select your product, then click **EPSON Printer Software Uninstall**.

Note: If you see a **User Account Control** window, click **Yes** or **Continue**.

In the next window, select your product, if necessary, and click **OK**. Then follow any on-screen instructions.

4. Restart your computer, then re-install your software.

Note: If you find that re-installing your product software does not solve a problem, contact Epson.

Parent topic: [Uninstall Your Product Software](#)

Uninstalling Product Software - Mac

In most cases, you do not need to uninstall your product software before re-installing it. However, you can download the Uninstaller utility from the Epson support website to uninstall your product software as described here.

Note: If you find that re-installing your product software does not solve a problem, contact Epson.

1. To download the Uninstaller utility, visit epson.com/support (U.S.), epson.ca/support (Canada), or latin.epson.com/support (Caribbean) and select your product.
2. Click **Downloads**.
3. Select your operating system, click **Utilities**, locate the Uninstaller utility, and click **Download**.
4. Run the file you downloaded.
5. Double-click the **Uninstaller** icon.
6. In the Epson Uninstaller screen, select the checkbox for each software program you want to uninstall.
7. Click **Uninstall**.
8. Follow the on-screen instructions to uninstall the software.
9. Reinstall your product software.

Note: If you uninstall the printer driver and your product name remains in the **Print & Fax, Print & Scan,** or **Printers & Scanners** window, select your product name and click the – (remove) icon to remove it.

Parent topic: [Uninstall Your Product Software](#)

Where to Get Help

If you need to contact Epson for technical support services, use the following support options.

Internet Support

Visit Epson's support website at epson.com/support (U.S.), epson.ca/support (Canada), or latin.epson.com/support (Caribbean) and select your product for solutions to common problems. You can download drivers and documentation, get FAQs and troubleshooting advice, or e-mail Epson with your questions.

Speak to a Support Representative

Before you call Epson for support, please have the following information ready:

- Product name
- Product serial number (located on a label on the product)
- Proof of purchase (such as a store receipt) and date of purchase
- Computer configuration
- Description of the problem

Then call:

- U.S.: (562) 276-7272, 6 AM to 8 PM, Pacific Time, Monday through Friday, and 7 AM to 4 PM, Pacific Time, Saturday
- Canada: (905) 709-2567, 6 AM to 8 PM, Pacific Time, Monday through Friday, and 7 AM to 4 PM, Pacific Time, Saturday

Days and hours of support are subject to change without notice. Toll or long distance charges may apply.

Purchase Supplies and Accessories

You can purchase genuine Epson ink and paper at epson.com (U.S. sales), epson.ca (Canadian sales), or epson.com.jm (Caribbean sales). You can also purchase supplies from an Epson authorized reseller. To find the nearest one, call 800-GO-EPSON (800-463-7766) in the U.S. or 800-807-7766 in Canada.

Parent topic: [Solving Problems](#)

Technical Specifications

These sections list the technical specifications for your product.

Note: Epson offers a recycling program for end of life Epson products. Please go to [this site](#) (U.S) or [this site](#) (Canada) for information on how to return your Epson products for proper disposal.

[Windows System Requirements](#)

[OS X System Requirements](#)

[Paper Specifications](#)

[Printable Area Specifications](#)

[Ink Specifications](#)

[Dimension Specifications](#)

[Electrical Specifications](#)

[Environmental Specifications](#)

[Interface Specifications](#)

[Network Interface Specifications](#)

[Safety and Approvals Specifications](#)

[Safety and Approvals Specifications for Latin America](#)

Windows System Requirements

To use your product and its software, your computer should use one of these Microsoft operating systems:

- Windows 10
- Windows 8.x
- Windows 7

Note: For the latest product software available for your operating system, visit the Epson support site at [epson.com/support](#) (U.S.), [epson.ca/support](#) (Canada), or [latin.epson.com/support](#) (Caribbean), select your product, and select **Downloads**.

Parent topic: [Technical Specifications](#)

OS X System Requirements

To use your product and its software, your Mac should use one of these operating systems:

- macOS 10.15.x
- macOS 10.14.x
- macOS 10.13.x
- macOS 10.12.x
- OS X 10.11.x
- OS X 10.10.x
- OS X 10.9.x

Note: For the latest product software available for your operating system, visit the Epson support site at epson.com/support (U.S.), epson.ca/support (Canada), or latin.epson.com/support (Caribbean), select your product, and select **Downloads**.

Parent topic: [Technical Specifications](#)

Paper Specifications

Note: Since the quality of any particular brand or type of paper may be changed by the manufacturer at any time, Epson cannot guarantee the quality of any non-Epson brand or type of paper. Always test a sample of paper stock before purchasing large quantities or printing large jobs.

Roll paper

Core size	SureColor P700: 2 inches (51 mm) SureColor P900: 2 inches (51 mm) or 3 inches (76.2 mm)
Outer diameter	SureColor P700: Up to 3.31 inches (84 mm) SureColor P900: Up to 5.91 inches (150 mm)
Width	SureColor P700: 8.27 to 13 inches (210 to 330.2 mm) SureColor P900: 8.27 to 17 inches (210 to 431.8 mm)
Thickness	0.003 to 0.027 inches (0.08 to 0.7 mm)

Cut sheet paper (1 sheet)

Width	SureColor P700: 8.27 to 24 inches (210 to 610 mm) SureColor P900: 8.27 to 36 inches (210 to 914 mm)
Length	11 to 62.2 inches (279.4 to 1580 mm)
Thickness	0.003 to 0.011 inch (0.08 to 0.3 mm)

Parent topic: [Technical Specifications](#)

Printable Area Specifications

Note: When printing borderless, quality may decline in the expanded printable area.

Cut sheets - normal printing

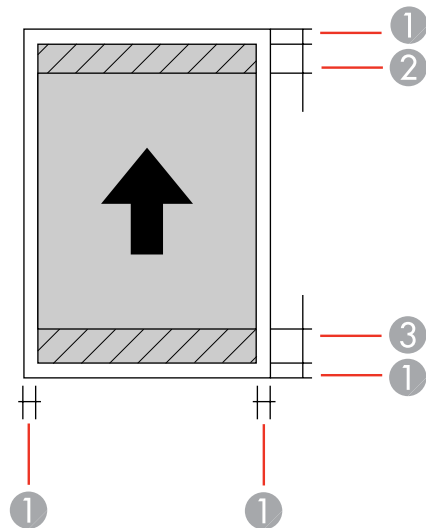

- 1 Top and side margins: 0.12 inch (3 mm) minimum
- 2 Top/reduced print quality area: 1.30 inches (33 mm) minimum
- 3 Bottom/reduced print quality area: 1.41 inches (36 mm) minimum

Note: Poster board margins are 0.79 inch (20 mm).

Cut sheets - borderless printing

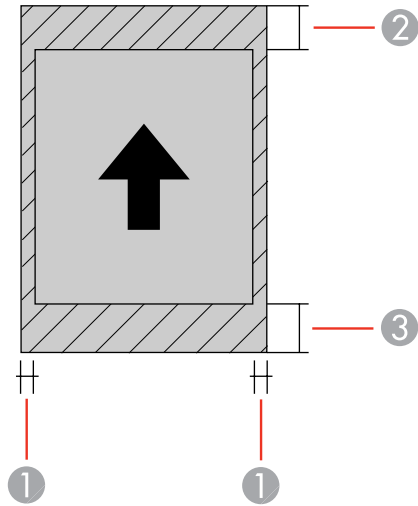

- 1 Side/reduced print quality area: 0.12 inch (3 mm) minimum
- 2 Top/reduced print quality area: 1.42 inches (36 mm) minimum
- 3 Bottom/reduced print quality area: 1.53 inches (39 mm) minimum

Note: You cannot print borderless on poster board.

Roll paper - normal printing

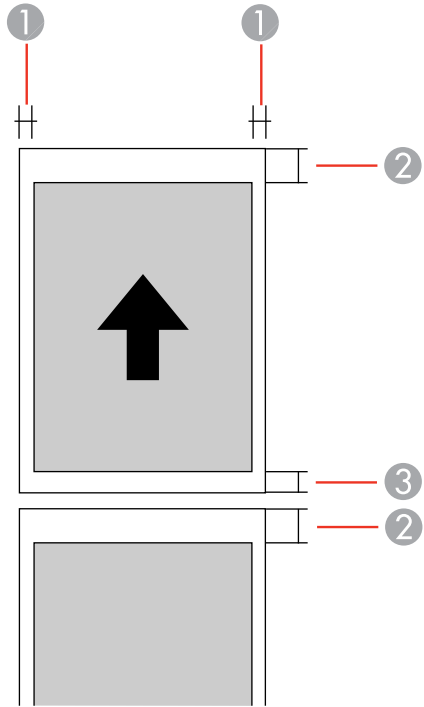

- 1 Side margins: 0.12 inch (3 mm) minimum
- 2 Top margin: 1.97 inches (50 mm) minimum
- 3 Bottom margin: 0.55 inch (14 mm) minimum

Roll paper - borderless printing

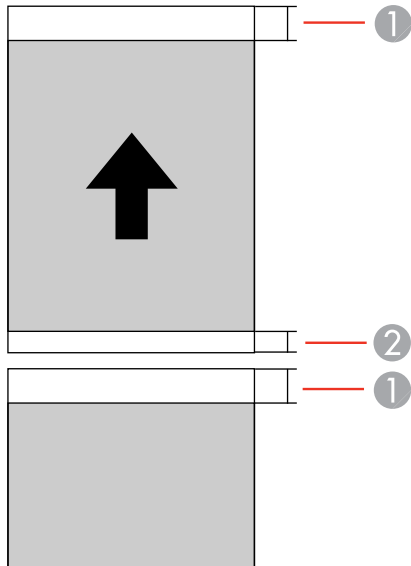

- 1 Top margin: 1.97 inches (50 mm) minimum
- 2 Bottom margin: 0.55 inch (14 mm) minimum

Note: For continuous printing on roll paper, there is no margin between printed images (normal and borderless printing).

Parent topic: [Technical Specifications](#)

Ink Specifications

Note: Epson's warranties do not extend to any damage caused by the use of third-party ink or ink not designed for your printer.

The included initial ink bottles must be used for printer setup and are not for resale. The printer ships with full ink bottles and part of the ink from the first bottles is used to charge the print head. Yields vary considerably based on images printed, print settings, paper type, frequency of use and temperature.

Color	Photo Black, Matte Black, Gray, Light Gray, Yellow, Cyan, Light Cyan, Vivid Magenta, Vivid Light Magenta, and Violet
Ink life	Do not use if the date on the package has expired
Temperature	Storage: -4 to 104 °F (-20 to 40 °C) 1 month at 104 °F (40 °C) Ink freezes at 32 °F (0 °C) Ink thaws and is usable after approximately 3 hours at 77 °F (25 °C)

Parent topic: [Technical Specifications](#)

Dimension Specifications

SureColor P700

Height	Stored: 7.3 inches (185 mm) Printing: 16.5 inches (420 mm)
Width	Stored: 20.3 inches (515 mm) Printing: 20.3 inches (515 mm)
Depth	Stored: 14.5 inches (368 mm) Printing: 30.3 inches (769 mm)
Weight (without ink cartridges and power cord)	Approx. 27.8 lb (12.6 kg)

SureColor P900

Height	Stored: 7.8 inches (199 mm) Printing: 20.5 inches (520 mm)
Width	Stored: 24.2 inches (615 mm) Printing: 24.2 inches (615 mm)

Depth Stored: 14.5 inches (368 mm)
Printing: 35.6 inches (905 mm)

Weight Approx. 32.6 lb (14.8 kg)
(without ink cartridges and power cord)

Parent topic: [Technical Specifications](#)

Electrical Specifications

Power supply rating 100 to 240 V

Rated frequency range 50/60 Hz

Rated current 1.3 to 0.7 A

Power consumption

SureColor P700:

- Printing: approximately 22 W
- Ready mode: approximately 8 W
- Sleep mode: approximately 1.1 W
- Power off mode: approximately 0.14 W

SureColor P900:

- Printing: approximately 24 W
- Ready mode: approximately 8 W
- Sleep mode: approximately 1.1 W
- Power off mode: approximately 0.14 W

Parent topic: [Technical Specifications](#)

Environmental Specifications

Temperature	Operating: 50 to 95 °F (10 to 35 °C) Storage: –4 to 104 °F (–20 to 40 °C) 1 month at 104 °F (40 °C)
Humidity (non-condensing)	Operating: 20 to 80% RH Storage: 5 to 85% RH

Parent topic: [Technical Specifications](#)

Interface Specifications

Super-Speed USB-Compatible with the Universal Serial Bus Specifications Revision 3.0

Parent topic: [Technical Specifications](#)

Network Interface Specifications

Wi-Fi

Standards	IEEE802.11b/g/n/ac
Securities	WEP (64/128bit) WPA-PSK (TKIP) WPA2-PSK (AES) (complies with WPA2 standards with support for WPA/WPA2 Personal)
Frequency range	2.4 GHz/5 GHz
Communication mode	Infrastructure Wi-Fi Direct (Simple AP) (not supported for IEEE802.11b)

Ethernet

Standards	IEEE802.3i (10BASE-T) IEEE802.3u (100BASE-TX) IEEE802.3ab (1000BASE-T) IEEE802.3az (Energy Efficient Ethernet); connected device should comply with IEEE802.3az standards
------------------	--

Note: Use a category 5 or higher shielded twisted pair cable for all interfaces.

Parent topic: [Technical Specifications](#)

Safety and Approvals Specifications

United States	Safety: UL62368-1 EMC: FCC part 15 Subpart B class B
Canada	Safety: CAN/CSA C22.2 No. 62368-1 EMC: CAN ICES-3 (B)/NMB-3 (B)

This equipment contains the following wireless module:

- Manufacturer: SEIKO EPSON CORPORATION
- Type: J26H005

This product conforms to Part 15 of FCC Rules and RSS-210 of the IC Rules. Epson cannot accept responsibility for any failure to satisfy the protection requirements resulting from a non-recommended modification of the product. Operation is subject to the following two conditions: (1) this device may not cause harmful interference, and (2) this device must accept any interference received, including interference that may cause undesired operation of the device.

To prevent radio interference to the licensed service, this device is intended to be operated indoors and away from windows to provide maximum shielding. Equipment (or its transmit antenna) that is installed outdoors is subject to licensing.

This equipment complies with FCC/IC radiation exposure limits set forth for an uncontrolled environment and meets the FCC radio frequency (RF) Exposure Guidelines in Supplement C to OET65 and RSS-102 of the IC radio frequency (RF) Exposure rules. This equipment should be installed and operated so that

the radiator is kept at least 7.9 inches (20 cm) or more away from a person's body (excluding extremities: hands, wrists, feet and ankles).

Parent topic: [Technical Specifications](#)

Safety and Approvals Specifications for Latin America

Notice for Argentina

CNC Certification

WLAN Module: J26H006

Brand: EPSON

 CNC ID: C-20841

Notice for Mexico

Operation is subject to the following two conditions: (1) this device may not cause harmful interference, and (2) this device must accept any interference received, including interference that may cause undesired operation of the device.

Product Model: K371A (SureColor P700/P900)

WLAN Module Model: J26H006

Brand: EPSON

IFT Certification Number: RCPEPJ218-0025

Notice for Paraguay

Imported by:

Fastrax, S.A.

Av. Perú esq. Río de Janeiro, Barrios Las Mercedes, Asunción, Paraguay

Imported by:

Sol Control S.R.L.

Av. Gral. Bernardino Caballero 810 esq. Celsa Speratti, Asunción, Paraguay

Notice for Peru

Product Model: SureColor P700/P900 (K371A)

Brand: EPSON

This product uses the following WLAN module:

WLAN Module Model: J26H006

FCC ID: BKMFBJ26H006

Product Manufacturer: Seiko Epson Corporation

Address: 3-3-5 Owa Suwa-shi, Nagano-Ken 392-8502, Japan

Parent topic: [Technical Specifications](#)

Notices

Check these sections for important notices about your product.

Note: Epson offers a recycling program for end of life Epson products. Please go to [this site](#) (U.S) or [this site](#) (Canada) for information on how to return your Epson products for proper disposal.

[Important Safety Instructions](#)

[Important Privacy Notice \(Printer Serial Number\)](#)

[Binding Arbitration and Class Waiver](#)

[FCC Compliance Statement](#)

[Trademarks](#)

[Copyright Notice](#)

Important Safety Instructions

Before using your Epson product, read and follow these safety instructions.

[General Printer Safety Instructions](#)

[Ink Cartridge Safety Instructions](#)

[LCD Screen Safety Instructions](#)

[Wireless Connection Safety Instructions](#)

Parent topic: [Notices](#)

General Printer Safety Instructions

- Be sure to follow all warnings and instructions marked on the printer.
- Use only the power cord that comes with the printer. Use of another cord may cause fires or shock. Do not use the cord with any other equipment.
- Place the printer near a wall outlet where the plug can be easily unplugged.
- Avoid plugging the printer into an outlet on the same circuit as a photo copier or air control system that regularly switches on and off, or on an outlet controlled by a wall switch or timer.
- Do not let the power cord become damaged or frayed.
- If you use an extension cord with the printer, make sure the total ampere rating of the devices plugged into the extension cord does not exceed the cord's ampere rating. Also, make sure the total ampere rating of all devices plugged into the wall outlet does not exceed the wall outlet's ampere rating.

- Always turn off the printer using the power button, and wait until the power light stops flashing before unplugging the printer or cutting off power to the electrical outlet.
- Place the printer on a flat, stable surface that extends beyond its base in all directions. It will not operate properly if it is tilted or at an angle.
- Leave enough space in front of the printer for the paper to be fully ejected.
- Avoid locations that are subject to rapid changes in heat or humidity, shocks or vibrations, or dust.
- Do not place the printer near a radiator or heating vent or in direct sunlight.
- Leave enough room around the printer for sufficient ventilation. Do not block or cover openings in the case or insert objects through the slots.
- Keep the printer away from potential sources of electromagnetic interference, such as loudspeakers or the base units of cordless telephones.
- Do not touch the flat white cable inside the printer.
- Do not move the print head by hand; this may damage the printer.
- Do not spill liquid on the printer.
- Do not use aerosol products that contain flammable gases inside or around the printer. Doing so may cause fire.
- Except as specifically explained in your documentation, do not attempt to service the printer yourself.
- Unplug the printer and refer servicing to qualified service personnel under the following conditions: if the power cord or plug is damaged; if liquid has entered the product; if the product has been dropped or the case damaged; if the product does not operate normally or exhibits a distinct change in performance. Adjust only those controls that are covered by the operating instructions.
- If damage occurs to the plug, replace the cord set or consult a qualified electrician. If there are fuses in the plug, make sure you replace them with fuses of the correct size and rating.
- Leave the ink cartridges installed. Removing the cartridges can dehydrate the print head and may prevent the printer from printing.
- When storing or transporting the printer, do not tilt it, stand it on its side, or turn it upside down; otherwise ink may leak from the cartridges.

Parent topic: [Important Safety Instructions](#)

Ink Cartridge Safety Instructions

- Keep ink cartridges out of the reach of children and do not drink the ink.

- Be careful when you handle used ink cartridges; there may be ink remaining around the ink supply port. If ink gets on your skin, wash it off with soap and water. If it gets in your eyes, flush them immediately with water.
- Do not put your hand inside the product or touch any cartridges during printing.
- Do not turn off the product during ink charging. If ink charging is incomplete, you may not be able to print.
- Install a new ink cartridge immediately after removing an expended one. Leaving cartridges uninstalled can dry out the print head and may prevent the product from printing.
- Do not remove or tear the label on the cartridge; this can cause leakage.
- Do not drop or knock ink cartridges against hard objects; this can cause leakage.
- Do not remove the transparent seal from the bottom of the cartridge. This may cause the cartridge to become unusable.
- Do not disassemble or modify the ink cartridge; you may not be able to print normally.
- Do not break the hooks on the side of the cartridge when removing it from the packaging.
- Do not touch the green IC chip on the side of the cartridge. This may prevent normal operation.
- Do not shake cartridges after opening their packages; this can cause them to leak.
- If you remove an ink cartridge for later use, protect the ink supply area from dirt and dust and store it in the same environment as the product. Note that there is a valve in the ink supply port, making covers or plugs unnecessary, but care is needed to prevent the ink from staining items that the cartridge touches. Do not touch the ink cartridge ink supply port or surrounding area.
- Use an ink cartridge before the date printed on its package.
- Do not dismantle an ink cartridge. This could damage the print head.
- Store ink cartridges in a cool, dark place; do not store the ink cartridges in high or freezing temperatures.
- Make sure to install all ink cartridges. The printer only works when all ink cartridges are properly installed.

Parent topic: [Important Safety Instructions](#)

LCD Screen Safety Instructions

- Use only a dry, soft cloth to clean the LCD screen. Do not use liquid or chemical cleansers.
- If the LCD screen is damaged, contact Epson. If the liquid crystal solution gets on your hands, wash them thoroughly with soap and water. If the liquid crystal solution gets into your eyes, flush them

immediately with water. If discomfort or vision problems remain after a thorough flushing, see a doctor immediately.

- Do not press too hard on the LCD screen or subject it to heavy impacts.
- Do not use a pointy or sharp object, such as a pen or your fingernail, to operate the LCD screen.
- If the LCD screen chips or cracks, do not touch or attempt to remove the broken pieces; contact Epson for support.
- Do not subject your product to sudden changes in temperature or humidity; this may cause condensation to develop inside the LCD screen and degrade its performance.
- The LCD screen may contain a few small bright or dark spots, and may display uneven brightness. These are normal and do not indicate that the screen is damaged in any way.

Parent topic: [Important Safety Instructions](#)

Wireless Connection Safety Instructions

Radio waves from this product may adversely affect the operation of medical equipment or automatically controlled devices, such as pacemakers, automatic doors or fire alarms. When using this product near such devices or inside a medical facility, follow the directions from authorized staff members at the facility, and follow all posted warnings and directions on the device to avoid causing an accident.

Parent topic: [Important Safety Instructions](#)

Important Privacy Notice (Printer Serial Number)

As part of setup, your product's serial number will be sent to a secure Epson server so that you can be eligible to participate in programs we may offer from time to time, including the Epson ink replenishment program. You will have a separate opportunity to consent to participating in such programs.

If you have any questions concerning this process, you can contact us by using the [Privacy Feedback Form](#), or you can write to:

Epson America, Inc.

Attn: Privacy Coordinator

3131 Katella Avenue

Los Alamitos, CA 90720

Parent topic: [Notices](#)

Binding Arbitration and Class Waiver

1. DISPUTES, BINDING INDIVIDUAL ARBITRATION, AND WAIVER OF CLASS ACTIONS AND CLASS ARBITRATIONS

1.1 **Disputes.** The terms of this Section 1 shall apply to all Disputes between you and Epson. The term "Dispute" is meant to have the broadest meaning permissible under law and includes any dispute, claim, controversy or action between you and Epson arising out of or relating to this Agreement, Epson branded products (hardware and including any related software), or other transaction involving you and Epson, whether in contract, warranty, misrepresentation, fraud, tort, intentional tort, statute, regulation, ordinance, or any other legal or equitable basis. "DISPUTE" DOES NOT INCLUDE IP CLAIMS, or more specifically, a claim or cause of action for (a) trademark infringement or dilution, (b) patent infringement, (c) copyright infringement or misuse, or (d) trade secret misappropriation (an "IP Claim"). You and Epson also agree, notwithstanding Section 1.6, that a court, not an arbitrator, may decide if a claim or cause of action is for an IP Claim.

1.2 **Binding Arbitration.** You and Epson agree that all Disputes shall be resolved by binding arbitration according to this Agreement. **ARBITRATION MEANS THAT YOU WAIVE YOUR RIGHT TO A JUDGE OR JURY IN A COURT PROCEEDING AND YOUR GROUNDS FOR APPEAL ARE LIMITED.**

Pursuant to this Agreement, binding arbitration shall be administered by JAMS, a nationally recognized arbitration authority, pursuant to its code of procedures then in effect for consumer related disputes, but excluding any rules that permit joinder or class actions in arbitration (for more detail on procedure, see Section 1.6 below). You and Epson understand and agree that (a) the Federal Arbitration Act (9 U.S.C. §1, et seq.) governs the interpretation and enforcement of this Section 1, (b) this Agreement memorializes a transaction in interstate commerce, and (c) this Section 1 shall survive termination of this Agreement.

1.3 **Pre-Arbitration Steps and Notice.** Before submitting a claim for arbitration, you and Epson agree to try, for sixty (60) days, to resolve any Dispute informally. If Epson and you do not reach an agreement to resolve the Dispute within the sixty (60) days, you or Epson may commence an arbitration. Notice to Epson must be addressed to: Epson America, Inc., ATTN: Legal Department, 3131 Katella Ave., Los Alamitos, CA 90720 (the "Epson Address"). The Dispute Notice to you will be sent to the most recent address Epson has in its records for you. For this reason, it is important to notify us if your address changes by emailing us at EAILEgal@ea.epson.com or writing us at the Epson Address above. Notice of the Dispute shall include the sender's name, address and contact information, the facts giving rise to the Dispute, and the relief requested (the "Dispute Notice"). Following receipt of the Dispute Notice, Epson and you agree to act in good faith to resolve the Dispute before commencing arbitration.

1.4 **Small Claims Court.** Notwithstanding the foregoing, you may bring an individual action in the small claims court of your state or municipality if the action is within that court's jurisdiction and is pending only in that court.

1.5 WAIVER OF CLASS ACTIONS AND CLASS ARBITRATIONS. YOU AND EPSON AGREE THAT EACH PARTY MAY BRING DISPUTES AGAINST THE OTHER PARTY ONLY IN AN INDIVIDUAL CAPACITY, AND NOT AS A PLAINTIFF OR CLASS MEMBER IN ANY CLASS OR REPRESENTATIVE PROCEEDING, INCLUDING WITHOUT LIMITATION FEDERAL OR STATE CLASS ACTIONS, OR CLASS ARBITRATIONS. CLASS ACTION LAWSUITS, CLASS-WIDE ARBITRATIONS, PRIVATE ATTORNEY-GENERAL ACTIONS, AND ANY OTHER PROCEEDING WHERE SOMEONE ACTS IN A REPRESENTATIVE CAPACITY ARE NOT ALLOWED. ACCORDINGLY, UNDER THE ARBITRATION PROCEDURES OUTLINED IN THIS SECTION, AN ARBITRATOR SHALL NOT COMBINE OR CONSOLIDATE MORE THAN ONE PARTY'S CLAIMS WITHOUT THE WRITTEN CONSENT OF ALL AFFECTED PARTIES TO AN ARBITRATION PROCEEDING.

1.6 Arbitration Procedure. If you or Epson commences arbitration, the arbitration shall be governed by the rules of JAMS that are in effect when the arbitration is filed, excluding any rules that permit arbitration on a class or representative basis (the "JAMS Rules"), available at <http://www.jamsadr.com> or by calling 1-800-352-5267, and under the rules set forth in this Agreement. All Disputes shall be resolved by a single neutral arbitrator, and both parties shall have a reasonable opportunity to participate in the selection of the arbitrator. The arbitrator is bound by the terms of this Agreement. The arbitrator, and not any federal, state or local court or agency, shall have exclusive authority to resolve all disputes arising out of or relating to the interpretation, applicability, enforceability or formation of this Agreement, including any claim that all or any part of this Agreement is void or voidable. Notwithstanding this broad delegation of authority to the arbitrator, a court may determine the limited question of whether a claim or cause of action is for an IP Claim, which is excluded from the definition of "Disputes" in Section 1.1 above. The arbitrator shall be empowered to grant whatever relief would be available in a court under law or in equity. The arbitrator may award you the same damages as a court could, and may award declaratory or injunctive relief only in favor of the individual party seeking relief and only to the extent necessary to provide relief warranted by that party's individual claim. In some instances, the costs of arbitration can exceed the costs of litigation and the right to discovery may be more limited in arbitration than in court. The arbitrator's award is binding and may be entered as a judgment in any court of competent jurisdiction.

You may choose to engage in arbitration hearings by telephone. Arbitration hearings not conducted by telephone shall take place in a location reasonably accessible from your primary residence, or in Orange County, California, at your option.

a) Initiation of Arbitration Proceeding. If either you or Epson decides to arbitrate a Dispute, both parties agree to the following procedure:

(i) Write a Demand for Arbitration. The demand must include a description of the Dispute and the amount of damages sought to be recovered. You can find a copy of a Demand for Arbitration at <http://www.jamsadr.com> ("Demand for Arbitration").

(ii) Send three copies of the Demand for Arbitration, plus the appropriate filing fee, to: JAMS, 500 North State College Blvd., Suite 600 Orange, CA 92868, U.S.A.

(iii) Send one copy of the Demand for Arbitration to the other party (same address as the Dispute Notice), or as otherwise agreed by the parties.

b) Hearing Format. During the arbitration, the amount of any settlement offer made shall not be disclosed to the arbitrator until after the arbitrator determines the amount, if any, to which you or Epson is entitled. The discovery or exchange of non-privileged information relevant to the Dispute may be allowed during the arbitration.

c) Arbitration Fees. Epson shall pay, or (if applicable) reimburse you for, all JAMS filings and arbitrator fees for any arbitration commenced (by you or Epson) pursuant to provisions of this Agreement.

d) Award in Your Favor. For Disputes in which you or Epson seeks \$75,000 or less in damages exclusive of attorney's fees and costs, if the arbitrator's decision results in an award to you in an amount greater than Epson's last written offer, if any, to settle the Dispute, Epson will: (i) pay you \$1,000 or the amount of the award, whichever is greater; (ii) pay you twice the amount of your reasonable attorney's fees, if any; and (iii) reimburse you for any expenses (including expert witness fees and costs) that your attorney reasonably accrues for investigating, preparing, and pursuing the Dispute in arbitration. Except as agreed upon by you and Epson in writing, the arbitrator shall determine the amount of fees, costs, and expenses to be paid by Epson pursuant to this Section 1.6d).

e) Attorney's Fees. Epson will not seek its attorney's fees and expenses for any arbitration commenced involving a Dispute under this Agreement. Your right to attorney's fees and expenses under Section 1.6d) above does not limit your rights to attorney's fees and expenses under applicable law; notwithstanding the foregoing, the arbitrator may not award duplicative awards of attorney's fees and expenses.

1.7 Opt-out. You may elect to opt-out (exclude yourself) from the final, binding, individual arbitration procedure and waiver of class and representative proceedings specified in this Agreement by sending a written letter to the Epson Address within thirty (30) days of your assent to this Agreement (including without limitation the purchase, download, installation of the Software or other applicable use of Epson Hardware, products and services) that specifies (i) your name, (ii) your mailing address, and (iii) your request to be excluded from the final, binding individual arbitration procedure and waiver of class and representative proceedings specified in this Section 1. In the event that you opt-out consistent with the procedure set forth above, all other terms shall continue to apply, including the requirement to provide notice prior to litigation.

1.8 Amendments to Section 1. Notwithstanding any provision in this Agreement to the contrary, you and Epson agree that if Epson makes any future amendments to the dispute resolution procedure and class action waiver provisions (other than a change to Epson's address) in this Agreement, Epson will obtain your affirmative assent to the applicable amendment. If you do not affirmatively assent to the applicable amendment, you are agreeing that you will arbitrate any Dispute between the parties in accordance with the language of this Section 1 (or resolve disputes as provided for in Section 1.7, if you timely elected to opt-out when you first assented to this Agreement).

1.9 Severability. If any provision in this Section 1 is found to be unenforceable, that provision shall be severed with the remainder of this Agreement remaining in full force and effect. **The foregoing shall not apply to the prohibition against class or representative actions as provided in Section 1.5. This means that if Section 1.5 is found to be unenforceable, the entire Section 1 (but only Section 1) shall be null and void.**

Parent topic: [Notices](#)

FCC Compliance Statement

For United States Users

This equipment has been tested and found to comply with the limits for a Class B digital device, pursuant to Part 15 of the FCC Rules. These limits are designed to provide reasonable protection against harmful interference in a residential installation. This equipment generates, uses, and can radiate radio frequency energy and, if not installed and used in accordance with the instructions, may cause harmful interference to radio or television reception. However, there is no guarantee that interference will not occur in a particular installation. If this equipment does cause interference to radio and television reception, which can be determined by turning the equipment off and on, the user is encouraged to try to correct the interference by one or more of the following measures:

- Reorient or relocate the receiving antenna.
- Increase the separation between the equipment and receiver.
- Connect the equipment into an outlet on a circuit different from that to which the receiver is connected.
- Consult the dealer or an experienced radio/TV technician for help.

WARNING

The connection of a non-shielded equipment interface cable to this equipment will invalidate the FCC Certification or Declaration of this device and may cause interference levels which exceed the limits established by the FCC for this equipment. It is the responsibility of the user to obtain and use a shielded equipment interface cable with this device. If this equipment has more than one interface connector, do not leave cables connected to unused interfaces. Changes or modifications not expressly approved by the manufacturer could void the user's authority to operate the equipment.

For Canadian Users

CAN ICES-3(B)/NMB-3(B)

Parent topic: [Notices](#)

Trademarks

EPSON® is a registered trademark, EPSON Exceed Your Vision is a registered logomark, and Epson Connect™ is a trademark of Seiko Epson Corporation.

Epson StoreSM is a service mark of Epson America, Inc.

Windows is a registered trademark of Microsoft Corporation in the United States and/or other countries.

Apple, App Store, Mac, macOS, and OS X are trademarks of Apple Inc., registered in the U.S. and other countries.

Google® is a registered trademark and Android™ is a trademark of Google LLC.

Wi-Fi Direct® is a registered trademark of Wi-Fi Alliance®.

General Notice: Other product names used herein are for identification purposes only and may be trademarks of their respective owners. Epson disclaims any and all rights in those marks.



Parent topic: [Notices](#)

Copyright Notice

All rights reserved. No part of this publication may be reproduced, stored in a retrieval system, or transmitted in any form or by any means, electronic, mechanical, photocopying, recording, or otherwise, without the prior written permission of Seiko Epson Corporation. The information contained herein is designed only for use with this Epson product. Epson is not responsible for any use of this information as applied to other products.

Neither Seiko Epson Corporation nor its affiliates shall be liable to the purchaser of this product or third parties for damages, losses, costs, or expenses incurred by purchaser or third parties as a result of: accident, misuse, or abuse of this product or unauthorized modifications, repairs, or alterations to this product, or (excluding the U.S.) failure to strictly comply with Seiko Epson Corporation's operating and maintenance instructions.

Seiko Epson Corporation shall not be liable for any damages or problems arising from the use of any options or any consumable products other than those designated as Original Epson Products or Epson Approved Products by Seiko Epson Corporation.

Seiko Epson Corporation shall not be held liable for any damage resulting from electromagnetic interference that occurs from the use of any interface cables other than those designated as Epson approved Products by Seiko Epson Corporation.

This information is subject to change without notice.

[A Note Concerning Responsible Use of Copyrighted Materials](#)

[Default Delay Times for Power Management for Epson Products](#)

[Copyright Attribution](#)

Parent topic: [Notices](#)

A Note Concerning Responsible Use of Copyrighted Materials

Epson encourages each user to be responsible and respectful of the copyright laws when using any Epson product. While some countries' laws permit limited copying or reuse of copyrighted material in certain circumstances, those circumstances may not be as broad as some people assume. Contact your legal advisor for any questions regarding copyright law.

Parent topic: [Copyright Notice](#)

Default Delay Times for Power Management for Epson Products

This product will enter sleep mode after a period of nonuse. This is to ensure that the product meets Energy Star standards of energy efficiency. More energy savings can be achieved by setting the time to sleep to a shorter interval.

Parent topic: [Copyright Notice](#)

Copyright Attribution

© 2020 Epson America, Inc.

11/20

CPD-58636R1

Parent topic: [Copyright Notice](#)