

Alienware AW3423DW Monitor User's Guide

Monitor Model: AW3423DW
Regulatory Model: AW3423DWb

A L I E N W A R E™ 

Notes, cautions, and warnings

-  **NOTE:** A NOTE indicates important information that helps you make better use of your computer.
-  **CAUTION:** A CAUTION indicates potential damage to hardware or loss of data if instructions are not followed.
-  **WARNING:** A WARNING indicates a potential for property damage, personal injury, or death.

© 2022 Dell Inc. or its subsidiaries. All rights reserved. Dell, EMC, and other trademarks are trademarks of Dell Inc. or its subsidiaries. Other trademarks may be trademarks of their respective owners.

2022 - 02

Rev. A00

Contents

Safety instructions	6
About your monitor	7
Package contents	7
Product features	9
Identifying parts and controls	10
Front view	10
Top view	11
Back view	11
Rear and bottom view	12
Monitor specifications	15
Resolution specifications	17
Supported video modes	17
HDMI preset display modes	17
Electrical specifications	19
Physical characteristics	20
Environmental characteristics	21
Pin assignments	22
Plug-and-Play capability	23
Universal Serial Bus (USB) interface	24
USB 3.2 Gen 1 (5 Gbps) upstream connector	24
USB 3.2 Gen 1 (5 Gbps) downstream connector	25
USB ports	25
QD-OLED monitor quality and pixel policy	26
Ergonomics	26
Handling and moving your display	28
Maintenance guidelines	29
Cleaning your monitor	29

Setting up the monitor	31
Attaching the stand	31
Connecting the computer	35
Removing the monitor stand	36
Attaching the VESA adapter (optional)	38
Operating the monitor	39
Turn on the monitor	39
Using the joystick	39
Using the On-Screen Display (OSD) menu	40
Accessing the Menu Launcher	40
Accessing the menu system	42
OSD warning message	57
Setting the maximum resolution	61
Using the tilt, swivel, and vertical extension	62
Tilt and swivel extensions	62
Vertical extension	62
Using AlienFX application	63
Prerequisites	63
Installing AWCC through Windows update	63
Installing AWCC from the Dell Support website	63
Navigating the AlienFX window	64
Creating a theme	66
Setting lighting effects	67
Troubleshooting	72
Self-test	72
Built-in diagnostics	73
Common problems	74
Product specific problems	77
Universal Serial Bus (USB) specific problems	80

Appendix 81
 FCC notices (U.S. only) and other regulatory information..... 81
 Contact Dell..... 81
 EU product database for energy label and product information sheet 81

Safety instructions

⚠ WARNING: Use of controls, adjustments, or procedures other than those specified in this documentation may result in exposure to shock, electrical hazards, and/or mechanical hazards.

- Place the monitor on a solid surface and handle it carefully. The screen is fragile and can be damaged if dropped or hit sharply.
- Always be sure that your monitor is electrically rated to operate with the AC power available in your location.
- Keep the monitor in room temperature. Excessive cold or hot conditions can have an adverse effect on the liquid crystal of the display.
- Do not subject the monitor to severe vibration or high impact conditions. For example, do not place the monitor inside a car trunk.
- Unplug the monitor when it is going to be left unused for an extended period of time.
- To avoid electric shock, do not attempt to remove any cover or touch the inside of the monitor.





For information on safety instructions, see the *Safety, Environmental, and Regulatory Information* (SERI) document.

About your monitor

Package contents

Your monitor ships with the components shown in the following table. If any component is missing, contact Dell technical support. For more information, see [Contact Dell](#).

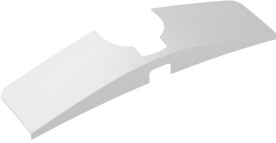
 **NOTE: Some components may be optional and may not ship with your monitor. Some features or media may not be available in certain countries.**

Component image	Component description
	Display
	Stand riser
	Stand base
	I/O cover
	VESA adapter

	<p>Screw (M4) x 4 (for locking a purchased wall-mount kit or 3rd-party arm on the VESA adapter)</p>
	<p>Power cable (varies by country)</p>
	<p>DisplayPort to DisplayPort 1.4 cable (1.8 meters)</p>
	<p>Mini-DisplayPort to DisplayPort 1.4 cable (1.8 meters)</p>
	<p>HDMI 2.0 cable (1.8 meters)</p>
	<p>USB 3.2 Gen 1 (5 Gbps) upstream cable (enables the USB ports on the monitor, 1.8 meters)</p>
	<ul style="list-style-type: none"> ▪ Quick Start Guide ▪ Factory calibration report ▪ Safety, Environmental, and Regulatory Information ▪ Alienware Welcome Card

Product features

The **Alienware AW3423DW** is a Quantum Dot–Organic Light Emitting Diode (QD–OLED) display that uses Oxide TFT as active element. The monitor features include:

- 86.82 cm (34.18 in.) viewable area (measured diagonally). Resolution: Up to 3440 x 1440 through DisplayPort and HDMI, with full-screen support or lower resolutions, supporting a high refresh rate of 175 Hz.
- NVIDIA G-SYNC ULTIMATE certified monitor that delivers tear free, stutter free and ultra-low latency gameplay.
- Color gamut of 149% sRGB and DCI-P3 99.3%.
- Tilt, swivel, and height adjustment capabilities.
- Removable stand and Video Electronics Standards Association (VESA) mounting holes (100 mm x 100 mm) using VESA adapter for flexible mounting solutions.
- Digital connectivity through 1 DisplayPort and 2 HDMI ports.
- The monitor is equipped with:
 - One SuperSpeed USB 5 Gbps (USB 3.2 Gen 1) Type B upstream port
 - One SuperSpeed USB 5 Gbps (USB 3.2 Gen 1) Type-A downstream charging port
 - Three SuperSpeed USB 5 Gbps (USB 3.2 Gen 1) Type-A downstream ports
- Plug-and-play capability if supported by your computer.
- On-Screen Display (OSD) adjustments for ease of setup and screen optimization.
- AW3423DW offers a couple of preset modes for user's own preference, including:
 - Creator
 - First-Person Shooter (FPS)
 - Multiplayer Online Battle Arena/Real-Time Strategy (MOBA/RTS)
 - Role-Playing Game (RPG)
 - Racing (SPORTS)
 - Three customizable game modes

In addition, key enhanced gaming features such as Timer, Frame Rate, and Display Alignment are provided to help improve gamer's performance and provide best-in game advantage.

- Security-lock slot.

- Power consumption ≤ 0.5 W in Standby Mode.
- VESA DisplayHDR 400 True Black.
- Optimize eye comfort with a flicker-free screen and low blue light feature.
- The Monitor uses Low Blue Light panel and is compliant with TÜV Rheinland (Hardware Solution) at factory reset or default setting. This built-in low blue light solution reduces hazardous blue light emissions by adjusting display parameters, without sacrificing true-to-life colors.

⚠ WARNING: The possible long-term effects of blue light emission from the monitor may cause damage to the eyes, including eye fatigue, digital eye strain, and so on. ComfortView Plus feature is designed to reduce the amount of blue light emitted from the monitor to optimize eye comfort.

Identifying parts and controls

Front view

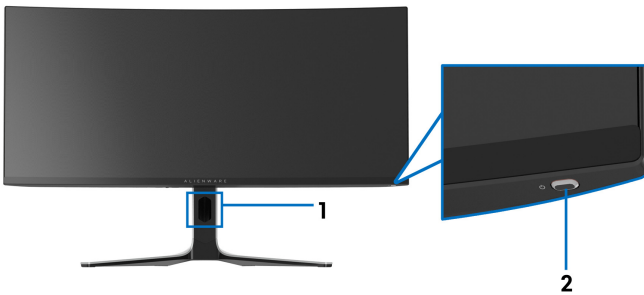

Label	Description	Use
1	Cable-management slot (on the front side of the stand)	To organize the cables neatly.
2	Power button (with LED indicator)	To turn the monitor on or off. Solid blue light indicates that the monitor is turned on and functioning normally. Blinking white light indicates that the monitor is in Standby Mode.

Top view

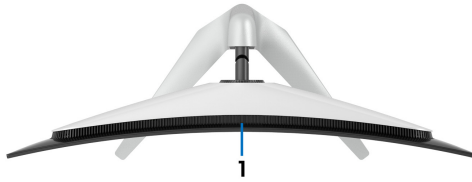

Label	Description	Use
1	Ambient light sensor	Detects ambient light and adjusts the brightness of the display accordingly. For more information, see Ambient Light Sensor .

Back view

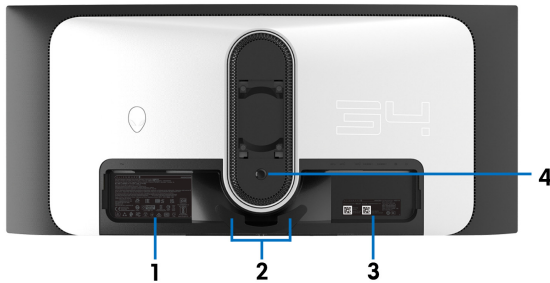

Back view without monitor stand

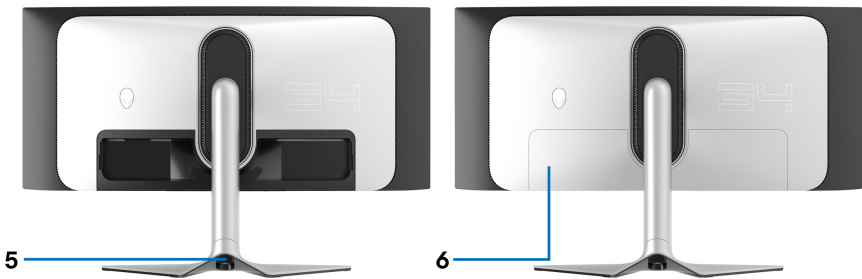

Back view with monitor stand



Label	Description	Use
1	Regulatory label	Lists the regulatory approvals.
2	Cable-management clips (2)	To organize the cables neatly.
3	Barcode, serial number, and Service Tag label	See this label if you need to contact Dell for technical support. The Service Tag is a unique alphanumeric identifier that enables Dell service technicians to identify the hardware components in your monitor and access warranty information.
4	Stand release button	Releases the stand from the monitor.
5	Cable-management slot (at the back of the stand)	To organize cables by routing them through this slot.
6	I/O cover	Protects the I/O ports.

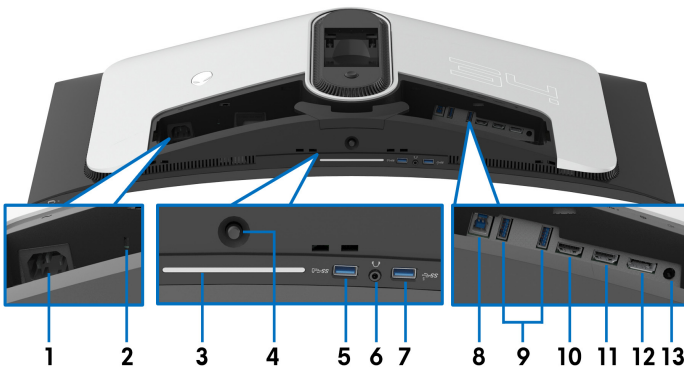



Rear and bottom view

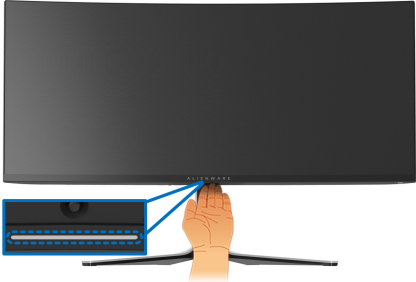

Rear and bottom view without monitor stand

Label	Description	Use
1	Power connector	Connect the power cable (shipped with your monitor).
2	Security-lock slot (based on Kensington Security Slot)	Secure the monitor with a security lock (security lock not included).

Label	Description	Use														
3	Downlights	<p>When the monitor setup is complete, tap the touch sensor at the bottom of the display to turn the downlights on or off.</p> 														
<p> NOTE: The factory setting is on, so the downlights are active if the power cable is connected. To change the default settings, see AlienFX Lighting.</p> <p> NOTE: When Lighting Effects, such as Spectrum, Comet, or Rainbow Cycle, is activated, the downlights are turned off.</p> <table border="1" data-bbox="258 831 1014 1118"> <thead> <tr> <th data-bbox="258 831 510 946" rowspan="2">Monitor state</th> <th colspan="2" data-bbox="510 831 1014 879">Downlights status</th> </tr> <tr> <th data-bbox="510 879 762 946">When Lighting Effects is deactivated</th> <th data-bbox="762 879 1014 946">When Lighting Effects is activated</th> </tr> </thead> <tbody> <tr> <td data-bbox="258 946 510 1002">On</td> <td data-bbox="510 946 762 1002">Enabled</td> <td data-bbox="762 946 1014 1002">Disabled</td> </tr> <tr> <td data-bbox="258 1002 510 1058">No Signal</td> <td data-bbox="510 1002 762 1058">Enabled</td> <td data-bbox="762 1002 1014 1058">Disabled</td> </tr> <tr> <td data-bbox="258 1058 510 1118">Standby</td> <td data-bbox="510 1058 762 1118">Disabled</td> <td data-bbox="762 1058 1014 1118">Disabled</td> </tr> </tbody> </table>			Monitor state	Downlights status		When Lighting Effects is deactivated	When Lighting Effects is activated	On	Enabled	Disabled	No Signal	Enabled	Disabled	Standby	Disabled	Disabled
Monitor state	Downlights status															
	When Lighting Effects is deactivated	When Lighting Effects is activated														
On	Enabled	Disabled														
No Signal	Enabled	Disabled														
Standby	Disabled	Disabled														
4	Joystick	Use it to control the OSD menu. For more information, see Operating the monitor .														

Label	Description	Use
5	SuperSpeed USB 5 Gbps (USB 3.2 Gen 1) Type-A downstream port with Power Charging	<p>Connect to charge your USB device.</p> <p> NOTE: To use this port, you must connect the USB cable (shipped with your monitor) to the USB-upstream port on the monitor and to your computer.</p> <p> NOTE: To avoid signal interference, when a wireless USB device has been connected to a USB downstream port, it is not recommended to connect any other USB devices to the adjacent port.</p>
6	Headphone port	<p>Connect the headphone or speakers.</p> <p> WARNING: The possible long-term effect of listening to audio at high volume through the headphones may cause damage to your hearing ability.</p>
7, 9	SuperSpeed USB 5 Gbps (USB 3.2 Gen 1) Type-A downstream port (3)	<p>Connect your USB 3.2 Gen 1 (5 Gbps) device.</p> <p> NOTE: To use these ports, you must connect the USB cable (shipped with your monitor) to the USB-upstream port on the monitor and to your computer.</p> <p> NOTE: To avoid signal interference, when a wireless USB device is connected to a USB downstream port, it is not recommended to connect any other USB devices to the adjacent port.</p>
8	SuperSpeed USB 5 Gbps (USB 3.2 Gen 1) Type-B upstream port	<p>Connect the USB cable (shipped with your monitor) to this port and your computer to enable the USB ports on your monitor.</p>
10	HDMI port (HDMI 1)	<p>Connect your computer with the HDMI cable (one HDMI cable is shipped with your monitor).</p>

Label	Description	Use
11	HDMI port (HDMI 2)	Connect your computer with the HDMI cable (one HDMI cable is shipped with your monitor).
12	DisplayPort	Connect your computer with one of the following cables shipped with your monitor: <ul style="list-style-type: none"> ▪ DisplayPort–DisplayPort cable ▪ Mini-DisplayPort–DisplayPort cable
13	Line-out port	Connect your speakers.  NOTE: This port does not support headphones.

Monitor specifications

Description	Value
Screen type	Color Active Matrix
Panel technology	QD OLED
Aspect ratio	21:9
Viewable image	
Diagonal:	868.21 mm (34.18 in.)
Width (active area)	800.10 mm (31.50 in.)
Height (active area)	337.10 mm (13.27 in.)
Total area	269,713.71 mm ² (418.01 in. ²)
Pixel pitch	0.23 mm x 0.23 mm
Pixel per inch (PPI)	110
Viewing angle:	
Vertical	178° (typical)
Horizontal	178° (typical)
Luminance output	250 cd/m ² (typical) 1000 cd/m ² (HDR peak)
Contrast ratio	1 million: 1 at (SDR) and (HDR)
Faceplate coating	Anti reflection
Backlight	OLED

Description	Value
Response time	0.1 ms gray-to-gray
Curvature	1800R (typical)
Color depth	1.07 billion colors (10 bit)
Color gamut	149% sRGB and DCI-P3 99.3%
Integrated devices	<ul style="list-style-type: none"> ▪ SuperSpeed USB 5 Gbps (USB 3.2 Gen 1) hub (with one USB 3.2 Gen 1 (5 Gbps) upstream port) ▪ 4 x SuperSpeed USB 5 Gbps (USB 3.2 Gen 1) downstream port (including 1 port which supports power-charging)
Connectivity	<ul style="list-style-type: none"> ▪ 1 x DisplayPort version 1.4 with HDCP 2.2 (rear) ▪ 2 x HDMI port version 2.0 with HDCP 2.2 (rear) ▪ 1 x USB 3.2 Gen 1 (5 Gbps) upstream port (rear) ▪ 4 x USB 3.2 Gen 1 (5 Gbps) downstream ports (bottom: 2; rear: 2) ▪ 1 x headphone port (bottom) ▪ 1 x audio line-out port (rear)
Border width (edge of monitor to active area)	
Top	4.65 mm
Left/Right	10.99 mm/10.99 mm
Bottom	20.60 mm
Adjustability	
Height adjustable stand	0 mm to 110 mm
Tilt	-5° to 21°
Swivel	-20° to 20°
Slant adjust	-5° to 5°
 NOTE: Do not mount or use this monitor in portrait (vertical) orientation or inverse (180°) landscape mount as it may damage the monitor.	
Security	Security-lock slot (cable lock sold separately)

Resolution specifications

Description	Value
Horizontal scan range	<ul style="list-style-type: none"> DisplayPort 1.4: 31 kHz to 274 kHz (automatic) HDMI 2.0: 30 kHz to 150 kHz (automatic)
Vertical scan range	<ul style="list-style-type: none"> DisplayPort 1.4: 1 Hz to 175 Hz (automatic) HDMI 2.0: 24 Hz to 120 Hz (automatic)
Maximum preset resolution	<ul style="list-style-type: none"> DisplayPort: 3440 x 1440 at 175 Hz HDMI: 3440 x 1440 at 100 Hz

Supported video modes

Description	Value
Video display capabilities (HDMI and DisplayPort playback)	480p, 576p, 720p, 1080p, QHD

HDMI preset display modes

Display mode	Horizontal frequency (kHz)	Vertical frequency (Hz)	Pixel clock (MHz)	Sync polarity (Horizontal/Vertical)
VESA, 640 x 480	31.50	59.90	25.20	-/-
VESA, 800 x 600	37.90	60.30	40	+/+
VESA, 1024 x 768	48.40	60	65	-/-
640 x 480p	31.48	60	25.18	-/-
720 x 480p	31.50	60	27.03	-/-
720 x 576p	31.25	50	27	-/-
1280 x 720p at 50 Hz	37.50	50	74.25	+/+
1280 x 720p at 60 Hz	45	60	74.25	+/+
1920 x 1080p at 50 Hz	56.25	50	148.50	+/+
1920 x 1080p at 60 Hz	67.50	60	148.50	+/+
1920 x 1080p at 120 Hz	135	120	297	+/+

2560 x 1440 at 60 Hz	88.79	59.95	241.50	+/-
2560 x 1440 at 120 Hz	183	120	497.75	+/-
3440 x 1440 at 50 Hz	73.68	49.99	265.25	+/-
3440 x 1440 at 60 Hz	88.82	59.97	319.75	+/-
3440 x 1440 at 100 Hz	150.97	99.98	543.50	+/-

DisplayPort preset display modes

Display mode	Horizontal frequency (kHz)	Vertical frequency (Hz)	Pixel clock (MHz)	Sync polarity (Horizontal/Vertical)
VESA, 640 x 480	31.50	59.90	25.20	-/-
VESA, 800 x 600	37.90	60.30	40	+/+
VESA, 1024 x 768	48.40	60	65	-/-
3440 x 1440 at 60 Hz	88.82	59.97	319.75	+/-
3440 x 1440 at 100 Hz	150.97	99.98	543.50	+/-
3440 x 1440 at 120 Hz	182.98	119.99	658.74	+/-
3440 x 1440 at 144 Hz	222.15	143.97	799.74	+/-
3440 x 1440 at 175 Hz	274.16	174.96	986.99	+/-

 **NOTE: This monitor supports NVIDIA G-SYNC ULTIMATE. For more information about the graphic cards that support NVIDIA G-SYNC ULTIMATE feature, see www.geforce.com.**

 **NOTE: To get the full NVIDIA G-SYNC ULTIMATE functionalities and experience, ensure that the monitor is directly connected to the HDMI port or DisplayPort with direct output from NVIDIA graphics card on your computer.**

Electrical specifications

Description	Value
Video input signals	HDMI 2.0/DisplayPort 1.4, 600 mV for each differential line, 100 Ω input impedance per differential pair
AC input voltage/frequency/current	100 VAC to 240 VAC/50 Hz or 60 Hz \pm 3 Hz/3 A (typical)
Inrush current	<ul style="list-style-type: none">▪ 120 V: 40 A (maximum) at 0°C (cold start)▪ 240 V: 80 A (maximum) at 0°C (cold start)
Power consumption	<ul style="list-style-type: none">▪ 0.3 W (Off mode)¹▪ 0.5 W (Standby Mode)¹▪ 42.3 W (On mode)¹▪ 200 W (Max.)²▪ 47.6 W (P^{on})³▪ 149.8 kWh (TEC)³

¹ As defined in EU 2019/2021 and EU 2019/2013.

² Maximum brightness and contrast setting with maximum power loading on all USB ports.

³ P^{on}: Power consumption of On Mode measured with reference to Energy Star test method.

TEC: Total Energy Consumption in kWh measured with reference to Energy Star test method.

This document is informational only and reflects laboratory performance. Your product may perform differently, depending on the software, components and peripherals you ordered and shall have no obligation to update such information.

Accordingly, the customer should not rely upon this information in making decisions about electrical tolerances or otherwise. No warranty as to accuracy or completeness is expressed or implied.

Physical characteristics

Description	Value
Signal cable type	<ul style="list-style-type: none"> ▪ Digital: HDMI, 19 pins ▪ Digital: DisplayPort, 20 pins ▪ Universal Serial Bus: USB, 9 pins
<p> NOTE: Dell monitors are designed to work optimally with the video cables that are shipped with your monitor. As Dell does not have control over different cable suppliers in the market, the type of material, connector, and process used to manufacture these cables, Dell does not guarantee video performance of cables that are not shipped with your Dell monitor.</p>	
Dimensions (with stand):	
Height (extended)	525.57 mm (20.69 in.)
Height (compressed)	415.57 mm (16.36 in.)
Width	815.25 mm (32.10 in.)
Depth	305.71 mm (12.04 in.)
Dimensions (without stand):	
Height	364.15 mm (14.34 in.)
Width	815.25 mm (32.10 in.)
Depth	137.11 mm (5.40 in.)
Stand dimensions:	
Height (extended)	411.81 mm (16.21 in.)
Height (compressed)	382.13 mm (15.04 in.)
Width	430.72 mm (16.96 in.)
Depth	305.71 mm (12.04 in.)
Weight:	
Weight with packaging	15.90 kg (35.05 lb)
Weight with stand assembly and cables	10.37 kg (22.86 lb)
Weight without stand assembly (For wall mount or VESA mount considerations - no cables)	6.92 kg (15.26 lb)
Weight of stand assembly	2.96 kg (6.53 lb)

Environmental characteristics

Description	Value
Compliant standards	
<ul style="list-style-type: none"> ▪ RoHS-compliant ▪ Arsenic-free glass and mercury-free for the panel only 	
Temperature:	
Operating	0°C to 40°C (32°F to 104°F)
Non-operating	<ul style="list-style-type: none"> ▪ Storage: -20°C to 60°C (-4°F to 140°F) ▪ Shipping: -20°C to 60°C (-4°F to 140°F)
Humidity:	
Operating	10% to 80% (non-condensing)
Non-operating	<ul style="list-style-type: none"> ▪ Storage: 10% to 90% (non-condensing) ▪ Shipping: 10% to 90% (non-condensing)
Altitude:	
Operating	5,000 m (16,404 ft) (maximum)
Non-operating	12,192 m (40,000 ft) (maximum)
Thermal dissipation	<ul style="list-style-type: none"> ▪ 684 BTU/hour (maximum) ▪ 144.67 BTU/hour (typical)

Pin assignments

DisplayPort connector

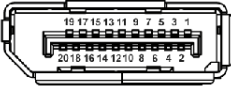

Pin number	20-pin side of the connected signal cable
1	ML3 (n)
2	GND
3	ML3 (p)
4	ML2 (n)
5	GND
6	ML2 (p)
7	ML1 (n)
8	GND
9	ML1 (p)
10	ML0 (n)
11	GND
12	ML0 (p)
13	GND
14	GND
15	AUX (p)
16	GND
17	AUX (n)
18	Hot Plug Detect
19	Re-PWR
20	+3.3 V DP_PWR

HDMI connector

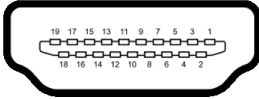

Pin number	19-pin side of the connected signal cable
1	TMDS DATA 2+
2	TMDS DATA 2 SHIELD
3	TMDS DATA 2-
4	TMDS DATA 1+
5	TMDS DATA 1 SHIELD
6	TMDS DATA 1-
7	TMDS DATA 0+
8	TMDS DATA 0 SHIELD
9	TMDS DATA 0-
10	TMDS CLOCK+
11	TMDS CLOCK SHIELD
12	TMDS CLOCK-
13	CEC
14	Reserved (N.C. on device)
15	DDC CLOCK (SCL)
16	DDC DATA (SDA)
17	DDC/CEC Ground
18	+5 V POWER
19	HOT PLUG DETECT

Plug-and-Play capability

You can connect the monitor to any Plug-and-Play compatible computer. The monitor automatically provides the computer with its Extended Display Identification Data (EDID) using Display Data Channel (DDC) protocols so that the computer can configure itself and optimize the monitor settings. Most monitor installations are automatic; you can select different settings, if required. For more information about changing the monitor settings, see [Operating the monitor](#).

Universal Serial Bus (USB) interface

This section provides information about the USB ports that are available on the monitor.

NOTE: This monitor is SuperSpeed USB 5 Gbps (USB 3.2 Gen 1) compatible.

Transfer speed	Data rate	Power consumption*
Super-Speed	5 Gbps	4.5 W (maximum each port)
High speed	480 Mbps	4.5 W (maximum each port)
Full speed	12 Mbps	4.5 W (maximum each port)

*Up to 2 A on USB downstream port (with  battery icon) with battery charging version-compliant devices or normal USB devices.

USB 3.2 Gen 1 (5 Gbps) upstream connector

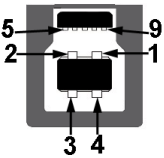

Pin number	9-pin side of the connector
1	VCC
2	D-
3	D+
4	GND
5	SSTX-
6	SSTX+
7	GND
8	SSRX-
9	SSRX+

USB 3.2 Gen 1 (5 Gbps) downstream connector





Pin number	9-pin side of the connector
1	VCC
2	D-
3	D+
4	GND
5	SSRX-
6	SSRX+
7	GND
8	SSTX-
9	SSTX+

USB ports

Port	Location
1 x upstream	rear
2 x downstream	rear
2 x downstream	bottom

Power charging port - the port with  icon; supports up to 2 A fast-charging capability if the device is BC1.2 compatible.

-  **NOTE: SuperSpeed USB 5 Gbps (USB 3.2 Gen 1) functionality requires a SuperSpeed USB 5 Gbps (USB 3.2 Gen 1)-capable computer.**
-  **NOTE: The USB ports on the monitor work only when the monitor is turned on or in Standby mode. If you turn off the monitor and then turn it on, the attached devices may take a few seconds to resume normal functionality.**

QD-OLED monitor quality and pixel policy

During the QD-OLED monitor manufacturing process, it is not uncommon for one or more pixels to become fixed in an unchanging state, which are hard to see and do not affect the display quality or usability. For more information about Dell Monitor Quality and Pixel Policy, see www.dell.com/pixelguidelines.

Ergonomics

△ **CAUTION: Improper or prolonged usage of keyboard may result in injury.**

△ **CAUTION: Viewing the monitor screen for extended periods of time may result in eye strain.**

For comfort and efficiency, observe the following guidelines when setting up and using your computer workstation:

- Position your computer so that the monitor and keyboard are directly in front of you as you work. Special shelves are commercially available to help you correctly position your keyboard.
- To reduce the risk of eye strain and neck/arm/back/shoulder pain from using the monitor for long periods of time, we suggest you to:
 1. Set the distance of the screen between 20 to 28 in. (50 - 70 cm) from your eyes.
 2. Blink frequently to moisten your eyes or wet your eyes with water after prolonged usage of the monitor.
 3. Take regular and frequent breaks for 20 minutes every two hours.
 4. Look away from your monitor and gaze at a distant object at 20 feet away for at least 20 seconds during the breaks.
 5. Perform stretches to relieve tension in the neck, arm, back, and shoulders during the breaks.
- Ensure that the monitor screen is at eye level or slightly lower when you are sitting in front of the monitor.
- Adjust the tilt of the monitor, its contrast, and brightness settings.
- Adjust the ambient lighting around you (such as overhead lights, desk lamps, and the curtains or blinds on nearby windows) to minimize reflections and glare on the monitor screen.
- Use a chair that provides good lower-back support.
- Keep your forearms horizontal with your wrists in a neutral, comfortable position while using the keyboard or mouse.
- Always leave space to rest your hands while using the keyboard or mouse.

- Let your upper arms rest naturally on both sides.
- Ensure that your feet are resting flat on the floor.
- When sitting, make sure that the weight of your legs is on your feet and not on the front portion of your seat. Adjust your chair's height or use a footrest if necessary to maintain a proper posture.
- Vary your work activities. Try to organize your work so that you do not have to sit and work for extended periods of time. Try to stand or get up and walk around at regular intervals.
- Keep the area under your desk clear of obstructions and cables or power cords that may interfere with comfortable seating or present a potential trip hazard.

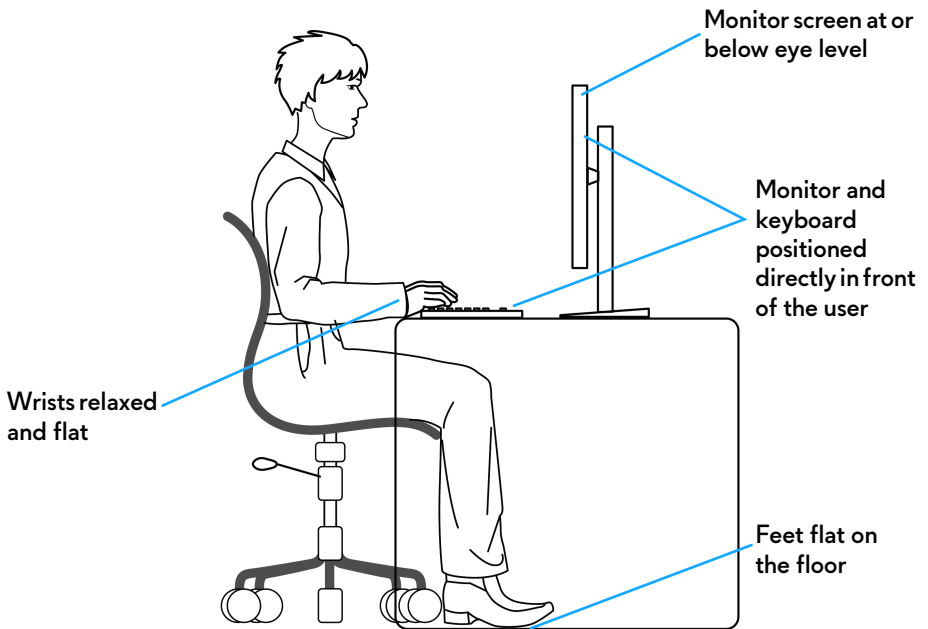

Handling and moving your display

To ensure that the monitor is handled safely when lifting or moving it, follow the guidelines mentioned below:

- Before moving or lifting the monitor, turn off your computer and the monitor.
- Disconnect all cables from the monitor.
- Place the monitor in the original box with the original packing materials.
- Hold the bottom edge and the side of the monitor firmly without applying excessive pressure when lifting or moving the monitor.

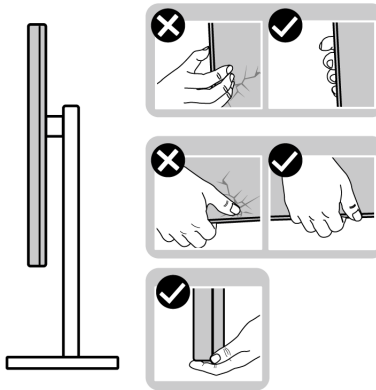

- When lifting or moving the monitor, ensure that the screen is facing away from you and do not press on the display area to avoid any scratches or damage.

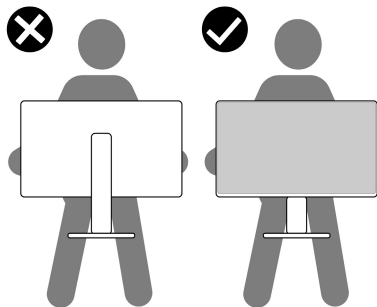

- When transporting the monitor, avoid any sudden shock or vibration to it.

- When lifting or moving the monitor, do not turn the monitor upside down while holding the stand base or stand riser. This may result in accidental damage to the monitor or cause personal injury.

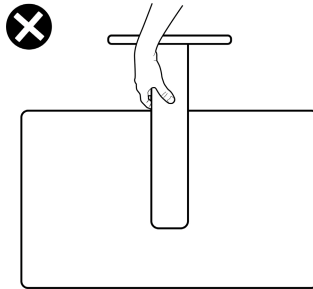

Maintenance guidelines

Cleaning your monitor

- ⚠ **WARNING:** Using improper methods when cleaning the monitor can result in a physical damage to the screen or the body of your Dell monitor.
- ⚠ **CAUTION:** Read and follow the [Safety instructions](#) before cleaning the monitor.
- ⚠ **WARNING:** Before cleaning the monitor, unplug the monitor power cable from the electrical outlet.

For best practices, follow the instructions in the list below when unpacking, cleaning, or handling your monitor:

- To clean the Dell monitor screen, lightly dampen a soft, clean cloth with water. If possible, use a special screen-cleaning tissue or solution suitable for the Dell Monitor screen.
- Using available dry cloth, gently wipe the film surface in one direction at a time to remove stain and dust.
- ⚠ **CAUTION:** Do not use detergents or other chemicals such as benzene, thinner, ammonia, abrasive cleaners, or compressed air.
- ⚠ **CAUTION:** Using chemicals for cleaning may cause changes in the appearance of the monitor, such as color fading, milky film on the monitor, deformation, uneven dark shade, and peeling of screen area.

 **WARNING: Do not spray the cleaning solution or even water directly on the monitor surface. Doing so will allow liquids to accumulate at the bottom of the display panel and corrode the electronics resulting in permanent damage. Instead, apply the cleaning solution or water to a soft cloth and then clean the monitor.**

 **NOTE: Monitor damage due to improper cleaning methods and the use of benzene, thinner, ammonia, abrasive cleaners, alcohol, compressed air, detergent of any kind will lead to a Customer Induced Damage (CID). CID is not covered under the standard Dell warranty.**

- If you notice white powder when you unpack your monitor, wipe it off with a cloth.
- Handle your monitor with care as a darker-colored monitor may get scratched and show white scuff marks more than a lighter-colored monitor.
- To help maintain the best image quality on your monitor, use a dynamically changing screen saver and turn off your monitor when not in use.

Setting up the monitor

Attaching the stand

 **NOTE:** The stand is not factory-installed.

 **NOTE:** The following instructions are only applicable for the stand that was shipped with your monitor. If you are attaching a stand that you purchased from any other source, follow the setup instructions that were included with the stand.

 **CAUTION:** The following steps are important to protect your curved screen. Follow the instructions to complete the installation.

1. Remove the stand riser, stand base, I/O cover, and VESA adapter from the packaging cushion.

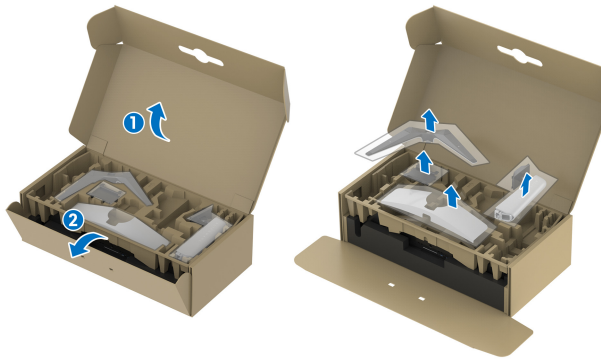

 **NOTE:** The graphics are used for illustration purposes only. The appearance of the package cushion may vary.

2. Align and place the stand riser on the stand base.
3. Open the screw handle at the bottom of the stand base and turn it clockwise to secure the stand assembly.
4. Close the screw handle.



- 5.** Open the protective cover on the monitor to access the VESA slot on the display back cover.



- 6.** Carefully insert the tabs on the stand riser into the slots on the display back cover and lower the stand assembly to snap it into place.

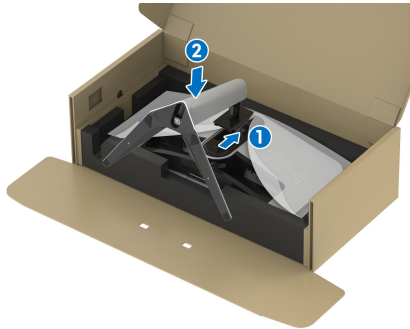

- 7.** Route the power cable through the cable-management slot on the stand and then through the cable-management clip behind the display.

- 8.** Connect the power cable to the monitor.

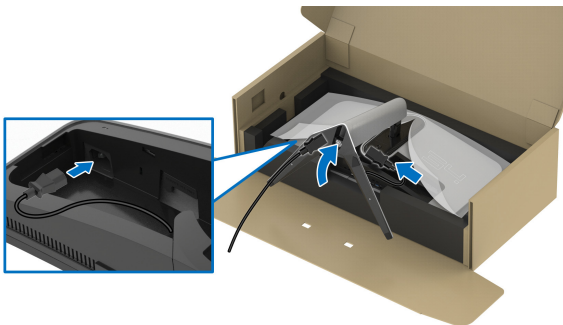

9. Route the required cables through the cable-management slot on the stand, such as HDMI cable, DisplayPort cable, USB 3.2 Gen 1 (5 Gbps) upstream and downstream cables, and so on.

NOTE: The USB 3.2 Gen 1 (5 Gbps) cables are not shipped with your display and sold separately.

10. Connect the required cables to the monitor.

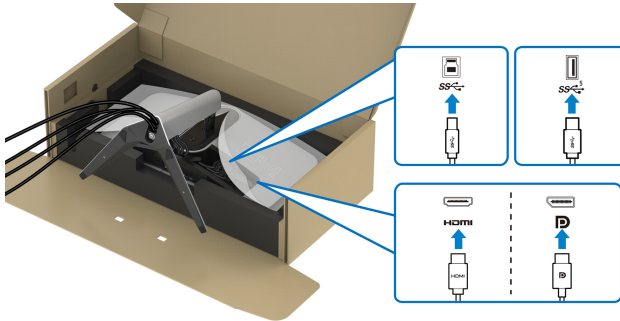

NOTE: Dell monitors are designed to work optimally with the Dell-supplied cables inside the box. Dell does not guarantee the video quality and performance when using non-Dell cables.

NOTE: Route each cable neatly so that the cables are organized before the I/O cover is attached.

CAUTION: Do not plug the power cable into the wall outlet or turn on the monitor until you are instructed to do so.

NOTE: If you want to secure your monitor to a table using the Kensington lock, connect the Kensington lock cable to the security-lock slot at this step. For more information about using the Kensington lock (sold separately), see the documentation that is shipped with the lock. The following image is for illustration purposes only. The appearance of the lock may vary.

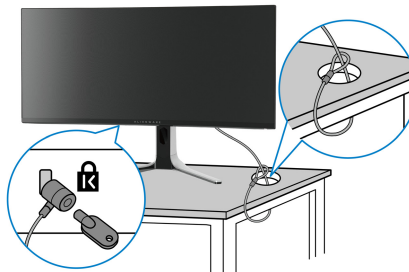

11. Hold the stand riser and lift the monitor carefully, then place it on a flat surface.

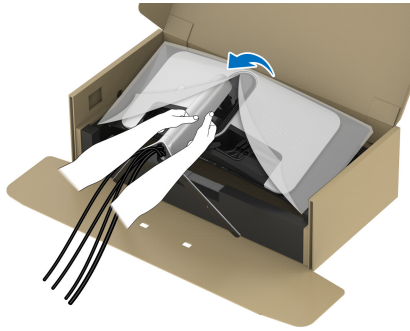

⚠ CAUTION: Hold the stand riser firmly when lifting the monitor to avoid any accidental damage.

12. Lift the protective cover from the monitor.

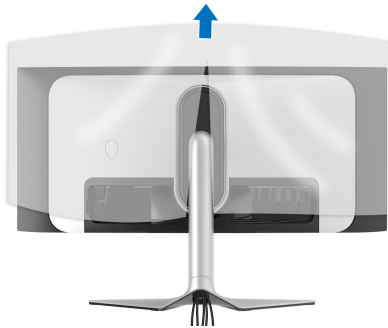

13. Slide the tabs on the I/O cover into the slots on the display back cover until it snaps into place.

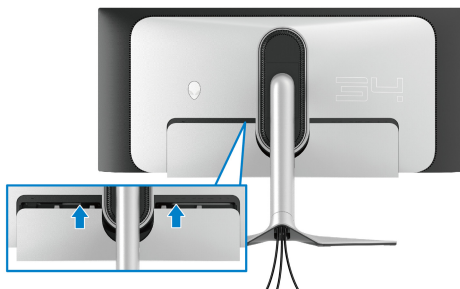

🔍 NOTE: Ensure that all cables pass through the I/O cover and cable-management slot on the stand riser.

Connecting the computer

⚠ WARNING: Before you begin any of the procedures in this section, follow the [Safety instructions](#).

✍ NOTE: Do not connect all cables to the computer at the same time.

✍ NOTE: The images are for illustration purposes only. The appearance of the computer may vary.

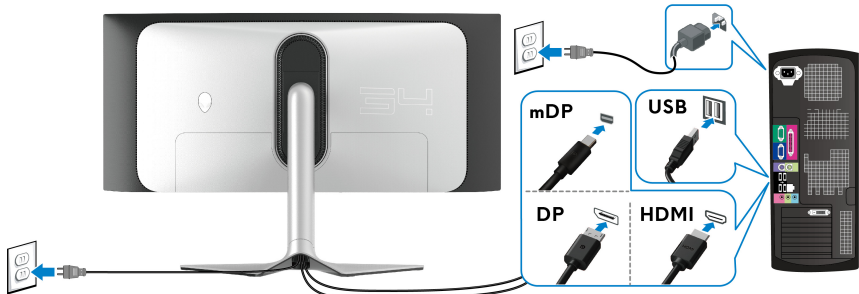

To connect your monitor to the computer:



1. Connect the other end of the DisplayPort cable (or Mini-DisplayPort to DisplayPort) or HDMI cable to your computer.
2. Connect the other end of the USB 3.2 Gen 1 upstream cable to an appropriate USB 3.2 Gen 1 port on your computer.
3. Connect the USB peripherals to the SuperSpeed USB 5 Gbps (USB 3.2 Gen 1) downstream ports at the bottom of the monitor.
4. Plug the power cables for your computer and monitor into a wall outlet.
5. Turn on the monitor and the computer.

If your monitor displays an image, installation is complete. If it does not display an image, see [Common problems](#).

Removing the monitor stand

-  **NOTE:** To prevent scratches on the display when removing the stand, ensure that the monitor is placed on a soft, clean surface.
-  **NOTE:** The following instructions are applicable only for removing the stand that was shipped with your monitor. If you are removing a stand that you purchased from any other source, follow the setup instructions that were included with the stand.

To remove the stand:

1. Turn off the monitor.
2. Disconnect the cables from the computer.
3. Place the monitor on a soft cloth or cushion.
4. Carefully slide and remove the I/O cover from the monitor.

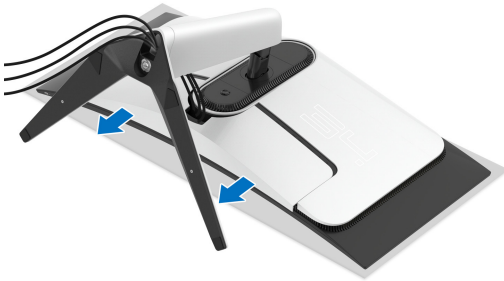

5. Disconnect the cables from the monitor and slide them out through the cable-management slot on the stand riser.

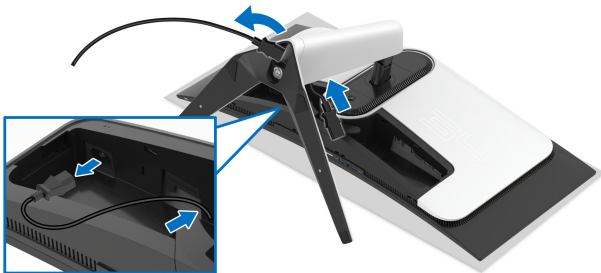

6. Press and hold the stand release button.

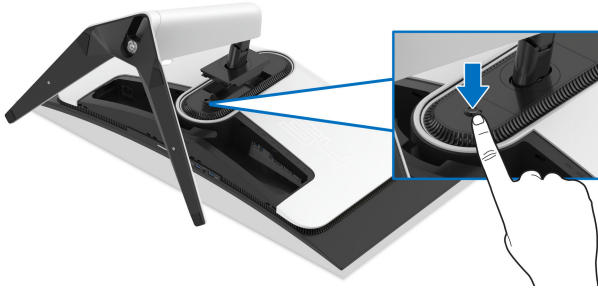

7. Lift the stand up and away from the monitor.



Attaching the VESA adapter (optional)

By installing the supplied VESA adapter onto the back of the display, you can attach a wall-mount kit or 3rd-party arm (sold separately) to the monitor.

NOTE: The wall-mount kit or 3rd-party arm is not shipped with this monitor.

1. Place the monitor panel on a soft cloth or cushion on a stable flat surface.
2. Remove the monitor stand. (See [Removing the monitor stand.](#))
3. Attach the supplied VESA adapter to the monitor.
 - a. Insert the tabs on the VESA adapter into the slots on the display back cover.
 - b. Lower the VESA adapter to snap it into place.

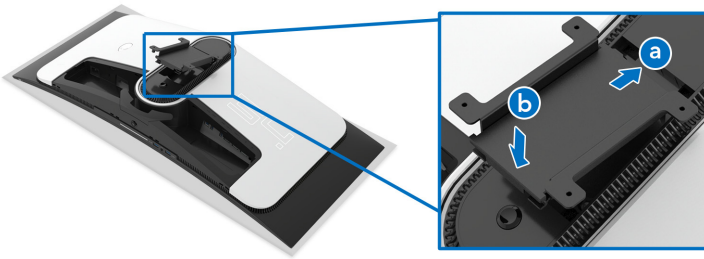

4. Using a Phillips crosshead screwdriver, tighten the wall mounting kit (100 mm x 100 mm) to the VESA adapter with four screws (M4 x 10 mm, shipped with the monitor).

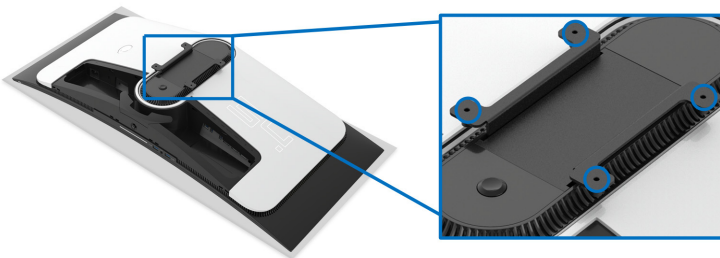

5. Mount the monitor on the wall by following the instructions that come with the purchased wall-mount kit/3rd-party arm.

NOTE: For use only with UL-listed wall mount bracket with minimum weight or load bearing capacity of 27.68 kg.

Operating the monitor

Turn on the monitor

Press the power button to turn on the monitor.

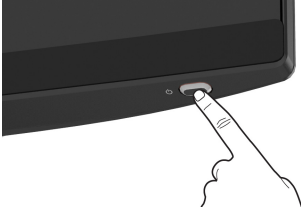

Using the joystick

Use the joystick at the bottom of the monitor to make On-Screen Display (OSD) adjustments.

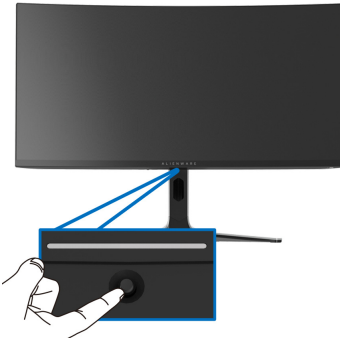



1. Press the joystick to launch the Menu Launcher.
2. Move the joystick forward/backward/left/right to toggle between options.
3. Press the joystick again to confirm the settings and exit.

Joystick

Description



- When the OSD menu is on, press the joystick to confirm the selection or save the settings.
 - When the OSD menu is off, press the joystick to launch the Menu Launcher. See [Accessing the Menu Launcher](#).
-

Joystick	Description
	<ul style="list-style-type: none"> For 2-way (right and left) directional navigation. Move right to enter the submenu. Move left to exit from the current menu. Increases (right) or decreases (left) the parameters of selected menu item.
	<ul style="list-style-type: none"> For 2-way (forward and backward) directional navigation. Toggles between the menu items. Increases (backward) or decreases (forward) the parameters of selected menu item.

Using the On-Screen Display (OSD) menu

Accessing the Menu Launcher

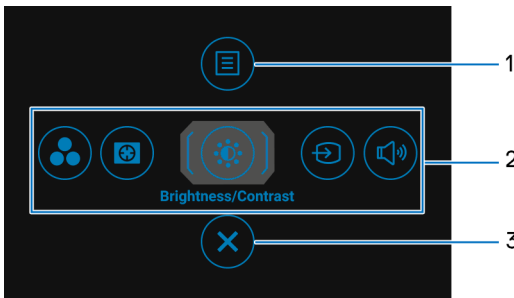

When you move or press the joystick, the Menu Launcher appears at the bottom center of the screen, allowing you to access the OSD menu and shortcut functions.

To select a function, move the joystick.



The following table describes the Menu Launcher functions:

Label	Icon	Description
1	 Menu	To launch the OSD main menu. See Accessing the menu system .

Label	Icon	Description
2	 <p>Shortcut functions</p>	<p>When you move the joystick to the left or right to toggle between the shortcut functions, the selected item will be highlighted and shifted to the center position. Press the joystick to enter its submenu. After you change the settings by moving the joystick, press the joystick to save the changes before exiting.</p> <ul style="list-style-type: none"> ▪ Preset Modes: To choose a preferred color mode from the list of preset modes. ▪ Dark Stabilizer: To access the Dark Stabilizer adjustment slider. ▪ Brightness/Contrast: To access the adjustment sliders of brightness and contrast. ▪ Input Source: To choose an input source from the list of video signals that may be connected to your monitor. ▪ Volume: To access the Volume adjustment slider. <p> NOTE: You can set your preferred shortcut keys. See Personalize for details.</p>

3	 <p>Exit</p>	To exit the Menu Launcher.
---	--	----------------------------

When you move or press the joystick, the OSD Status Bar appears at the top center of the screen, displaying the current settings of some OSD functions.

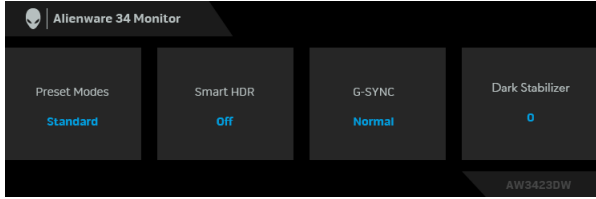

 **NOTE: The Smart HDR state is enabled automatically when your display detects HDR content. It cannot be enabled manually.**

Accessing the menu system

After you change the settings, press the joystick to save the changes before proceeding to another menu or exit the OSD menu.

 **NOTE:** To exit the current menu item and return to the previous menu, follow the direction icon displayed at the bottom-right corner of the OSD.

Icon	Menu and submenus	Description
	Game	Use this menu to personalize your visual gameplay experience.

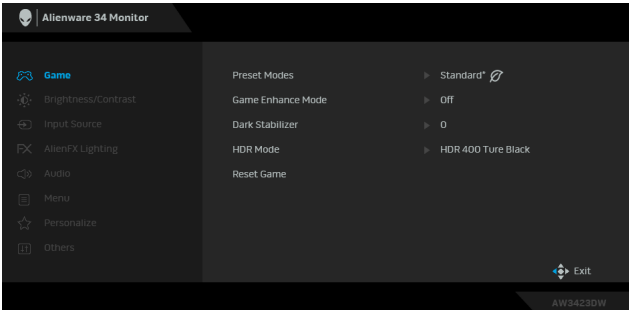

Preset Modes Allows you to choose from the list of preset color modes.

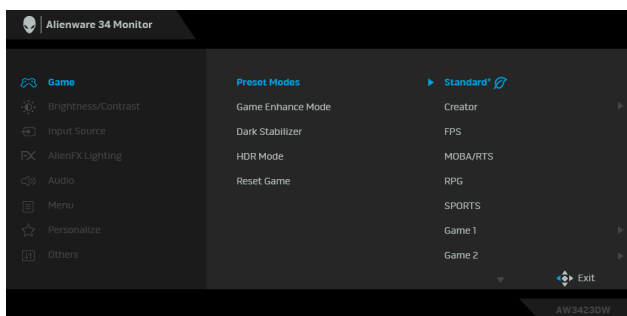

- **Standard***: Loads the monitor's default color settings. This is the default preset mode. (* means DisplayHDR-compliant)
- **Creator**: Allows you to set **Color Space** to **DCI-P3** or **sRGB** and adjust the **Gamma** level (between 1.8 and 2.6).

Icon	Menu and submenus	Description
	Preset Modes	<ul style="list-style-type: none"> ▪ FPS: Loads color settings ideal for First-Person Shooter (FPS) games. ▪ MOBA/RTS: Loads color settings ideal for Multiplayer Online Battle Arena (MOBA) and Real-Time Strategy (RTS) games. ▪ RPG: Loads color settings ideal for Role-Playing Games (RPG). ▪ SPORTS: Loads color settings ideal for sports games. ▪ Game 1/Game 2/Game 3: Enables you to customize the settings of color (R/G/B/C/M/Y) and Dark Stabilizer for your gaming needs. ▪ Warm: Presents colors at lower color temperatures. The screen appears warmer with a red/yellow tint. ▪ Cool: Presents colors at higher color temperatures. The screen appears cooler with a blue tint. ▪ Custom Color: Enables you to manually adjust the color settings. Use the joystick to adjust the three colors (R, G, B) values and create your own preset color modes.

Icon	Menu and submenus	Description
------	-------------------	-------------



Game Enhance Mode

The feature offers three available functions to enhance your gameplay experience.

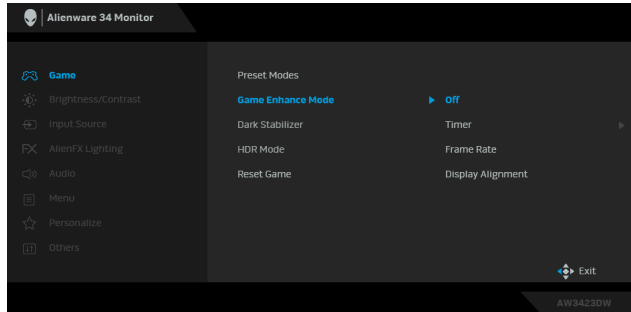

- **Off:** Select to disable the functions under **Game Enhance Mode**.
- **Timer:** Allows you to disable or enable the timer at the upper left corner of the display. The timer shows the time elapsed since the game starts. Select an option from the time-interval list to keep you aware of the remaining time.
- **Frame Rate:** Select to display the current frames per second when playing games. The higher the rate, the smoother the motion appears.
- **Display Alignment:** Select to help ensure the perfect alignment of the video contents from multiple displays. Pressing the joystick again will exit the **Display Alignment** mode.

Icon	Menu and submenus	Description
------	-------------------	-------------



Dark Stabilizer

The feature improves the visibility in the dark gaming scenarios. The higher the value (between 0 to 3), the better visibility in dark area of the display image.

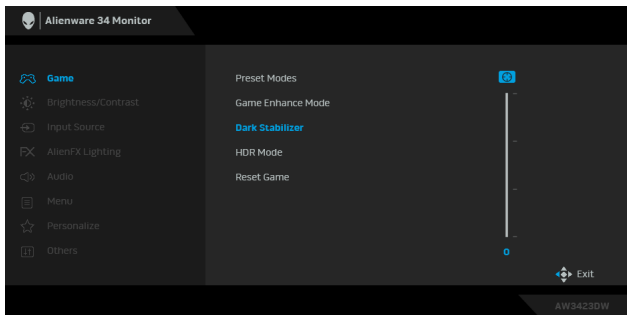

HDR Mode Allows you to set the HDR mode to **HDR 400 True Black** or **HDR Peak 1000**. Press the joystick to confirm the selection.

Reset Game Resets all settings under the **Game** menu to the factory defaults.

Icon	Menu and submenus	Description
------	-------------------	-------------



Brightness/Contrast

Use this menu to activate **Brightness/Contrast** adjustment.

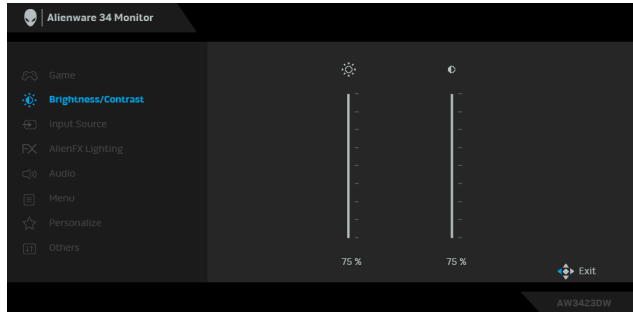

Brightness **Brightness** adjusts the luminance of the backlight. Move the joystick backward to increase the brightness level or move the joystick forward to decrease the brightness level (minimum 0/maximum 100).

Contrast Adjust **Brightness** first, and then adjust **Contrast** only if further adjustment is necessary. Move the joystick backward to increase the contrast level or move the joystick forward to decrease the contrast level (minimum 0/maximum 100). The **Contrast** feature adjusts the degree of difference between darkness and lightness on the monitor screen.

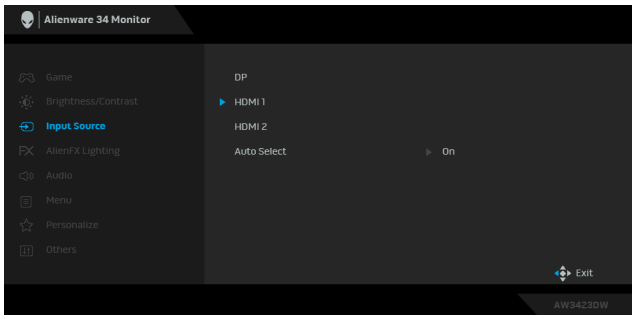
Icon	Menu and submenus	Description
	Input Source	Use this menu to select between the different video signals that may be connected to your monitor.
		
DP	Select the DP input when you are using the DisplayPort (DP) connector. Press the joystick to confirm the selection.	
HDMI 1	Select the HDMI 1 or HDMI 2 input when you are using the HDMI connector. Press the joystick to confirm the selection.	
HDMI 2		
Auto Select	Automatically scans for available input sources. Press the joystick to confirm the selection.	

Icon	Menu and submenus	Description
------	-------------------	-------------



AlienFX Lighting

Adjusts the LED light settings for the Alienware logo, ring strip, downlights, and Power button.

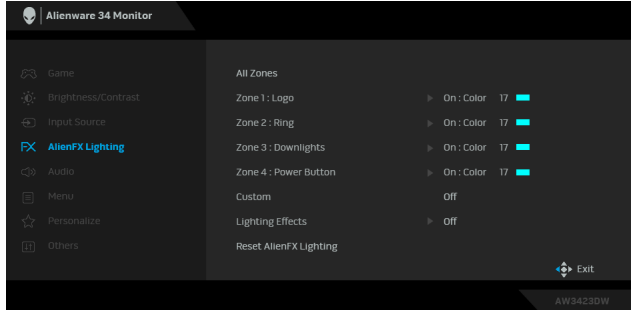

Before making any adjustments, select any or all of these four zones from the submenus. The following illustrations indicate the lighting zones.

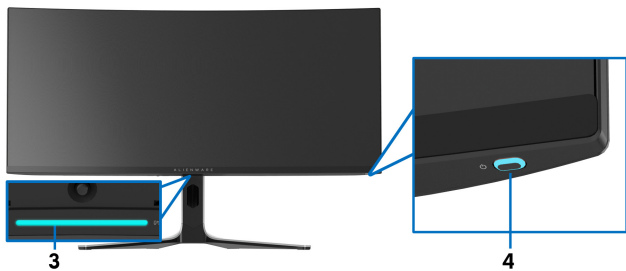

Icon	Menu and submenus	Description
------	-------------------	-------------

FX

- All Zones**
- Zone 1: Logo**
- Zone 2: Ring**
- Zone 3: Downlights**
- Zone 4: Power Button**

To specify an LED lighting color for the selected zone, select **On**, move the joystick to highlight **Custom Color**, and press the joystick to enter its submenu.

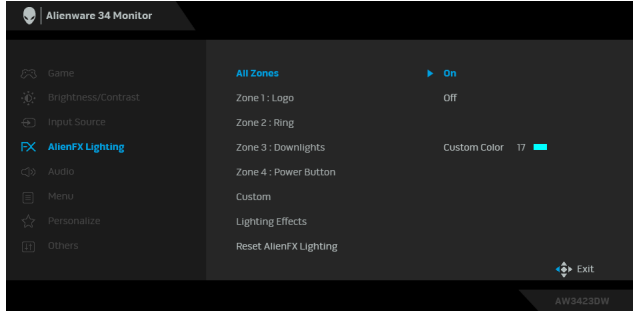

Then move the joystick to make a selection from the list of 20 available colors.

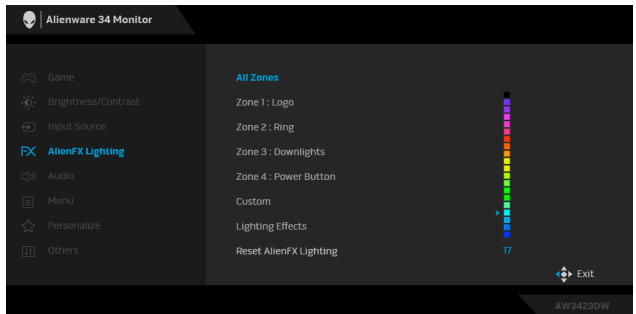

Icon	Menu and submenus	Description
------	-------------------	-------------





The following table depicts the color number and the RGB codes used for the 20 LED colors.

No.	R	G	B
1	0	0	0
2	28	0	178
3	51	0	178
4	178	0	178
5	167	16	113
6	178	0	50
7	178	0	0
8	178	38	0
9	178	63	0
10	178	105	0
11	119	178	0
12	69	178	0
13	40	178	0
14	0	178	0
15	0	178	9
16	0	178	24
17	0	173	121
18	0	85	165
19	0	43	178
20	0	0	178

To turn off the light for **All Zones/Zone 1/Zone 2/Zone 3**, select **Off**.

For **Zone 4**, you may specify to turn off the light when the monitor is in on or standby mode.

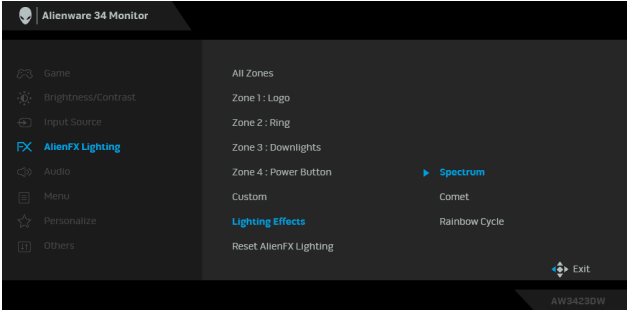

 **NOTE: These functions are disabled when Spectrum, Comet, or Rainbow Cycle (under Lighting Effects) is activated.**

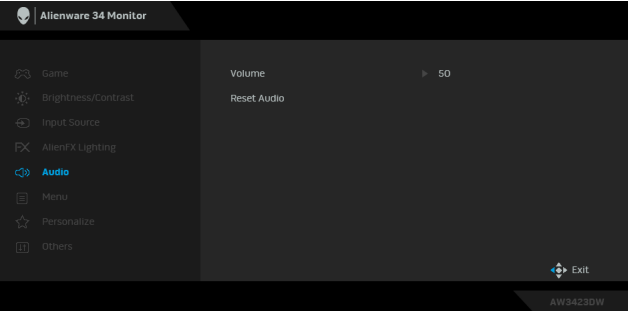
Icon	Menu and submenus	Description
FX	Custom	It is a read-only menu. When you use Color or/and Lighting Effects to make LED lighting adjustments, this menu status shows Off ; when you make the LED lighting adjustments through AlienFX application, the status shows On .
	Lighting Effects	<p>The default setting is Off. You can choose a lighting effect for the LED lights from the provided options.</p>  <ul style="list-style-type: none"> ▪ Spectrum: Select to make AlienFX lights of four zones glow and change colors in the sequence of the color spectrum: red, orange, yellow, green, blue, indigo, and violet. ▪ Comet: Select to let the LED lights glow like the shimmering comet. Move the joystick to highlight Custom Color, and press the joystick to enter its submenu. Then move the joystick to make a selection from the list of 20 available colors. ▪ Rainbow Cycle: Select to deliver the rainbow effect with the LED lights. <p> NOTE: When any of the above options is selected, those functions under AlienFX Lighting (except Reset AlienFX Lighting) will be turned off.</p>
	Reset AlienFX Lighting	Resets all settings under the AlienFX Lighting menu to the factory defaults.

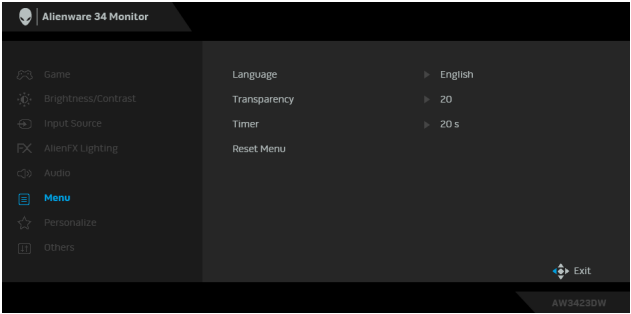
Icon	Menu and submenus	Description
	Audio	
	Volume	Move the joystick to adjust the volume level of headphone output (minimum 0/maximum 100).
	Reset Audio	Resets all settings under the Audio menu to the factory defaults.

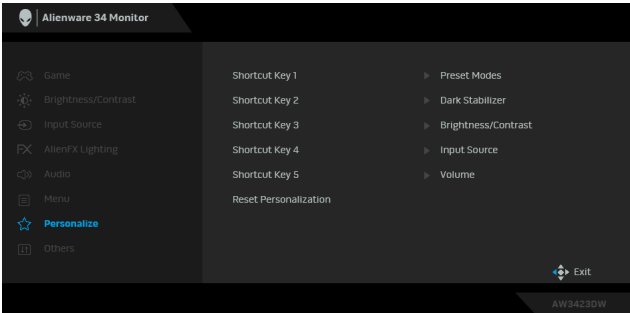
Icon	Menu and submenus	Description
	Menu	Use this menu to adjust the settings of the OSD, such as, the languages of the OSD, the amount of time the menu remains on screen, and so on.
		
	Language	Sets the OSD display to one of the eight languages: English, Spanish, French, German, Brazilian Portuguese, Russian, Simplified Chinese, or Japanese.
	Transparency	Move the joystick to change the menu transparency (minimum 0/maximum 100).
	Timer	Sets the length of time for the OSD to remain active after your last operation with the joystick. Move the joystick to adjust the slider in 1 second increment, from 5 to 60 seconds.
	Reset Menu	Resets all settings under the Menu menu to the factory defaults.

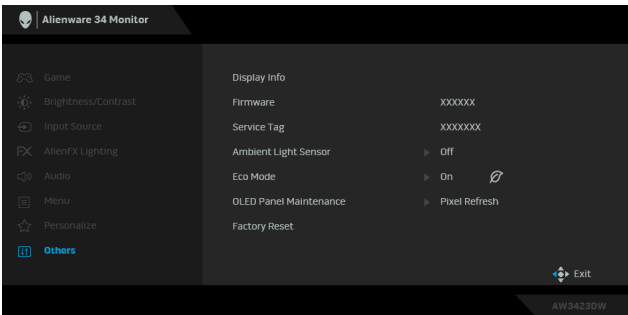
Icon	Menu and submenus	Description
☆	Personalize	
Shortcut Key 1	Allows you to choose a feature from Preset Modes, Game Enhance Mode, Dark Stabilizer, Brightness/Contrast, Input Source, or Volume and set it as a shortcut key. Press the joystick to confirm the selection.	
Shortcut Key 2		
Shortcut Key 3		
Shortcut Key 4		
Shortcut Key 5		
Reset Personalization	Resets all settings under the Personalize menu to the factory defaults.	

Icon	Menu and submenus	Description
	Others	
	Display Info	Displays the monitor's current settings.
	Firmware	Displays the firmware version of your monitor.
	Service Tag	Displays the Service Tag of your monitor. The Service Tag is a unique alphanumeric identifier that is required when you contact Dell technical support, access warranty information, search for latest drivers on Dell support website and so on.
	Ambient Light Sensor	When you set it to On , the monitor automatically adjusts the brightness of the display based on ambient light conditions. The default setting is Off .
		 NOTE: When HDR content is displayed, this option is disabled.
	Eco Mode	When the computer goes into standby mode, the Eco Mode enables the monitor to go into Standby mode as well. The default setting is On . Selecting Off may prevent the monitor from going into Standby mode.
		 NOTE: Pressing the joystick may wake up the monitor after it goes into Standby mode.

Icon	Menu and submenus	Description
	OLED Panel Maintenance	<p>The feature prevents the screen from image retention by offering these functions:</p> <ul style="list-style-type: none"> ▪ Pixel Refresh: To reduce temporary image retention on the screen, you can manually activate this function after using the monitor for a couple of hours. Alternatively, the function will be activated automatically when you have used the monitor for 4 hours/20 hours. The process takes approximately 7 minutes to complete. <ul style="list-style-type: none"> ✎ NOTE: The power LED indicator blinks slowly in green during the refresh process. ✎ NOTE: If the accumulated usage time exceeds 4 hours, Pixel Refresh will be activated automatically when the monitor goes into Standby mode. ▪ Panel Refresh: To prevent permanent image retention caused by static content when you use the monitor for 1500 hours, you can manually activate this function to refresh the pixels. Alternatively, the function will be activated automatically when the accumulated usage time exceeds the factory default setting (1500 hours). The process takes approximately an hour to complete. <ul style="list-style-type: none"> ✎ NOTE: The power LED indicator blinks slowly in red during the refresh process. ✎ NOTE: To obtain a better performance of Panel Refresh, activate the function within a temperature range of 0°C to 45°C.
	Factory Reset	Resets all OSD settings to the factory defaults.

OSD warning message

When you adjust the **Brightness** level above the default level for the first time, the following message appears:

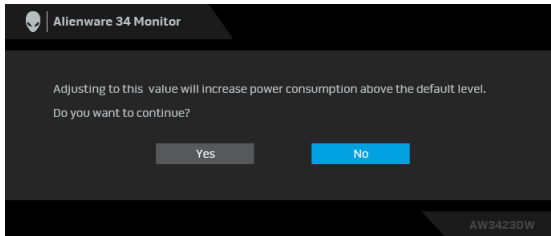

NOTE: If you select **Yes**, the message will not appear the next time you changes the **Brightness** setting.

When you change the default setting of power saving features for the first time, such as **Eco Mode** or **Preset Modes**, the following message appears:

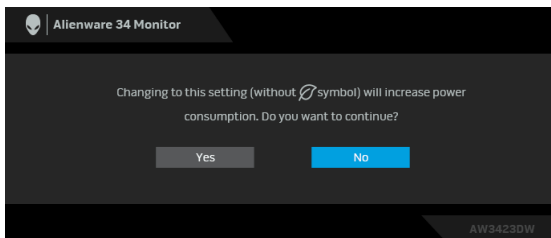

NOTE: If you select **Yes** for either of the features mentioned above, the message will not appear the next time you change the settings of these features. When you perform a factory reset, the message will appear again.

When the monitor goes into Standby mode, the following message appears:

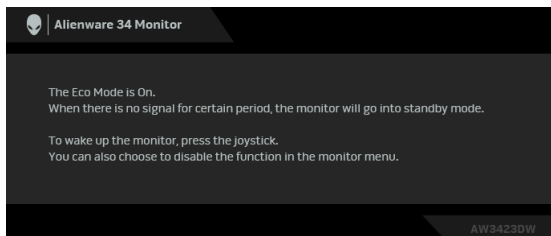

When Eco Mode is On

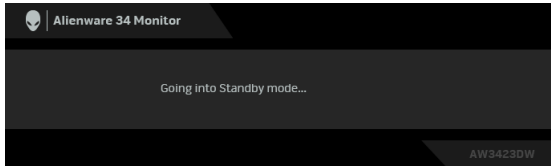

When Eco Mode is Off

Activate the computer and wake up the monitor to gain access to the **OSD**. When **Pixel Refresh** is selected, the following message appears:

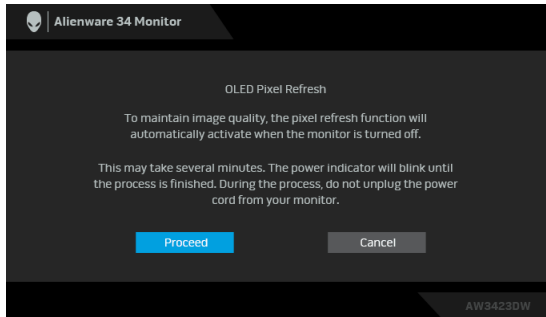

Once you select **Proceed**, the monitor will be turned off and the refresh process will run automatically. The process takes approximately seven minutes to complete.

When the monitor is turned on after four hours of cumulative usage, the **Pixel Refresh** function runs automatically and notifies you with the following message:

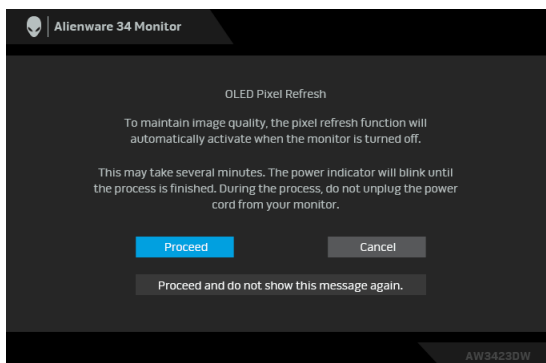

Select **Proceed**, and the refresh process will run automatically after the monitor is turned off. The process takes approximately seven minutes to complete.

When the monitor is turned on after twenty hours of cumulative usage, the **Pixel Refresh** function runs automatically and notifies you with the following message:

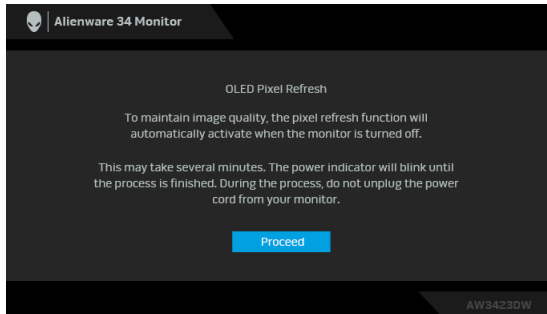

Select **Proceed**, and the refresh process will run automatically after the monitor is turned off. The process takes approximately seven minutes to complete.

When **Panel Refresh** is selected or the cumulative usage time of the monitor is more than 1500 hours, the following message appears:

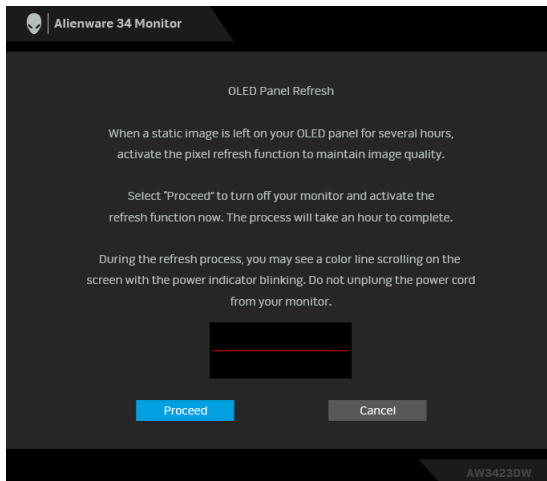

Select **Proceed**, and the refresh process will run automatically. The process takes approximately an hour to complete.

If you press the power button during the process of running **Pixel Refresh** or **Panel Refresh**, the following message appears:

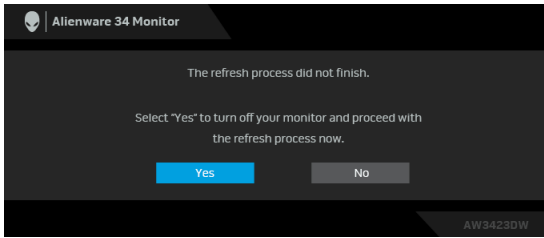

When **Factory Reset** is selected, the following message appears:

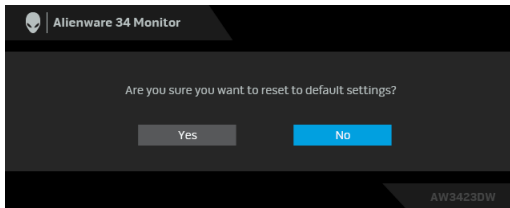

See [Troubleshooting](#) for more information.

Setting the maximum resolution

 **NOTE:** The steps may vary slightly depending on the version of Windows you have.

To set the maximum resolution for the monitor:

In Windows 8.1:

1. For Windows 8.1, select the Desktop tile to switch to classic desktop.
2. Right-click on the desktop and click **Screen resolution**.
3. If you have more than one monitor connected, ensure that you select **AW3423DW**.
4. Click the **Screen Resolution** dropdown list and select **3440 x 1440**.
5. Click **OK**.

In Windows 10 and Windows 11:

1. Right-click on the desktop and click **Display settings**.
2. If you have more than one monitor connected, ensure to select **AW3423DW**.
3. Click the **Display resolution** dropdown list and select **3440 x 1440**.
4. Click **Keep changes**.

If you do not see 3440 x 1440 as an option, you must update your graphics driver to the latest version. Depending on your computer, complete one of the following procedures:

If you have a Dell desktop or a laptop:

- Go to <https://www.dell.com/support>, enter your service tag, and download the latest driver for your graphics card.

If you are using a non-Dell computer (laptop or desktop):

- Go to the support site for your computer and download the latest graphic drivers.
- Go to your graphics card website and download the latest graphic drivers.

Using the tilt, swivel, and vertical extension

- NOTE:** The following instructions are applicable only for attaching the stand that was shipped with your monitor. If you are attaching a stand that you purchased from any other source, follow the setup instructions that were included with the stand.

Tilt and swivel extensions

With the stand attached to the monitor, you can tilt and swivel the monitor for the most comfortable viewing angle.

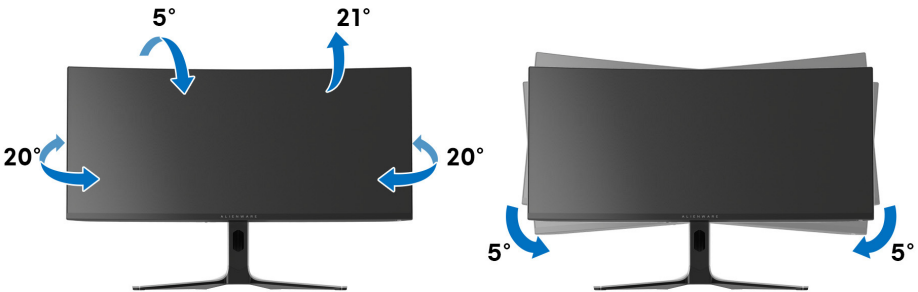

- NOTE:** The stand is not factory-installed.
- NOTE:** The slant angle of this monitor is between -5° and $+5^\circ$, not allowing for pivot movements.

Vertical extension

- NOTE:** The stand extends vertically up to 110 mm. The following figure illustrates how to extend the stand vertically.



Using AlienFX application

You can configure the LED lighting effects across multiple distinct zones on your Alienware monitor through AlienFX in Alienware Command Center (AWCC).

 **NOTE: If you have an Alienware Gaming Desktop or Laptop, you can directly access AWCC to control the lightings.**

 **NOTE: For more information, see Alienware Command Center Online Help.**

Prerequisites

Before installing the AWCC on a non-Alienware system:

- Ensure that the OS of your computer is Windows 10 R3 or later.
- Ensure your Internet connection is active.
- Ensure that the supplied USB 3.2 Gen 1 (5 Gbps) upstream cable is connected to both the Alienware monitor and the computer.

Installing AWCC through Windows update

1. The AWCC application is downloaded and will be automatically installed. The installation takes a few minutes to complete.
2. Navigate to the program folder to ensure that the installation is successful. Alternatively, you can find the AWCC application in the **Start** menu.
3. Launch AWCC and perform the following steps to download the additional software components:
 - In the **Settings** window, click **Windows Update**, and then click **Check for updates** to check the Alienware driver update progress.
 - If the driver update is not responding in your computer, install AWCC from the Dell Support website.

Installing AWCC from the Dell Support website

1. Enter AW3423DW in the query field at www.dell.com/support/drivers, and download the latest version of the following items:
 - Alienware Command Center Application
 - Alienware Gaming Monitor Communication Driver
2. Navigate to the folder in which you saved the setup files.
3. Double-click the setup file and follow the on-screen instructions to complete the installation.

Navigating the AlienFX window

With the Alienware Command Center, AlienFX enables you to control the LED lighting colors and transition effects for your Alienware monitor.

In the AWCC home screen, click **FX** in the top menu bar to access the home screen of AlienFX.



The following table describes the functions and features on the home screen:

Callout	Function	Description
A	CREATE NEW THEME...	Click + and then enter a name in the text box to add a theme.
B	Edit controls	<ul style="list-style-type: none">▪ EDIT: Provides options for you to customize lighting settings for your theme.▪ GO DIM: Makes the light dimmer.▪ GO DARK: Turns off the light.
C	Theme components	You can use these components (LIGHTING, MACROS, SETTINGS) to make the selected theme as an active theme.
D	THEMES list	Displays the themes in list view or grid view.
E	Background controls	Adjusts the background animation effects.
F	Help	Click to access the AWCC Online Help.
G	Window controls	You can use the buttons to minimize, maximize, or restore the size of the window. When × is selected, the application will close.

When you start to customize a theme, you should see the following screen:



Screen with the front view of monitor

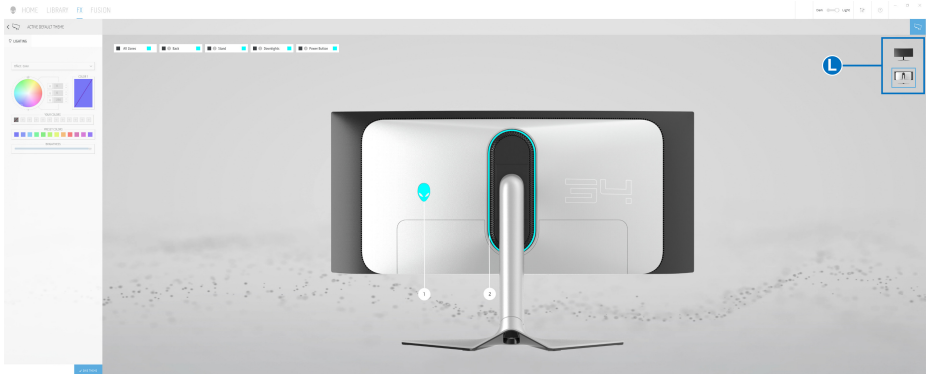

Screen with the back view of monitor

The following table describes the functions and features on the screen:

Callout	Function	Description
H	LIGHTING panel	Use the controls in this panel to set up lighting effects for a theme. See Setting lighting effects for details.
I	SAVE THEME	Click to save all adjustments and changes for the theme.
J	Zone selection	To make adjustments for a single zone, click the specific check box. To make adjustments for all zones, select the All Zones check box.

Callout	Function	Description
K	Live preview	The lighting zones are with numbered callouts. You may select a single zone by clicking the number on the image. When you make lighting adjustments, the preview of the monitor displays the new effects simultaneously.
L	Thumbnails	Displays the thumbnails of the Alienware monitors connected to your computer. The image displayed in the live preview area is selected from this thumbnail list.

Creating a theme

To create a theme with your preferred lighting settings:

1. Launch AWCC.
2. Click **FX** in the top menu bar to access the home screen of AlienFX.
3. In the top-left corner of the window, click  to create a new theme.
4. In the **CREATE NEW THEME** text box, type the theme name.
5. Specify the lighting zone(s) for which you want to make lighting adjustments by:
 - selecting the zone check box(es) above the live preview area, or
 - clicking the numbered callout on the image of monitor
6. In the **LIGHTING** panel, select your preferred lighting effects from the drop-down list. See [Setting lighting effects](#) for details.

 **NOTE: Some effects are available for All Zones only, such as Spectrum, Static Default Blue, Rainbow Cycle, Blink, Comet, Breathing RGB, and Racing.**

7. Repeat step 5 and step 6 to make more configuration options available to your preference.
8. When done, click **SAVE THEME**. A toast notification appears in the right-bottom corner of the screen.

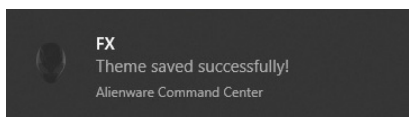

Setting lighting effects

The **LIGHTING** panel provides various lighting effects. You may click **Effect** to open a drop-down menu with available options.



NOTE: The options displayed may vary depending on the lighting zone(s) you specified.

The following table provides an overview of different options:

Morph	Description
	<p>The effect changes the light color into another through a seamless transition.</p> <p>To adjust the morph:</p> <ol style="list-style-type: none"> 1. Pick a preferred color from the color palette or the list of PRESET COLORS. The selected color and its RGB color codes will be displayed on the right field. <p>NOTE: To change the color, use the up and down arrow buttons beside the R/G/B boxes to edit the color codes.</p> <ol style="list-style-type: none"> 2. To add the selected color to the list of YOUR COLORS for quick access in the future, click . At most 12 colors can be added to the list. 3. Repeat the previous steps to specify Color 2 to be the ending light color. 4. Drag the BRIGHTNESS slider to adjust the brightness of the color. 5. Drag the TEMPO slider to adjust the transition speed.

Pulse

Description

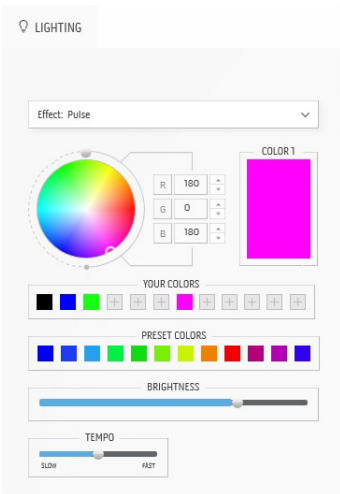

The effect makes the light flash with a short pause.
To adjust the pulse:

1. Pick a preferred color from the color palette or the list of **PRESET COLORS**. The selected color and its RGB color codes will be displayed on the right field.

 **NOTE: To change the color, use the up and down arrow buttons beside the R/G/B boxes to edit the color codes.**

2. To add the selected color to the list of **YOUR COLORS** for quick access in the future, click . At most 12 colors can be added to the list.

 **NOTE: To remove an existing color chip from the list, right-click on it.**

3. Drag the **BRIGHTNESS** slider to adjust the brightness of the color.
4. Drag the **TEMPO** slider to adjust the pulsing speed.

Color

Description

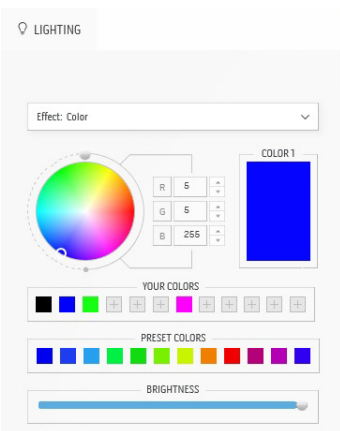

The effect makes the LED light in a single static color.

To adjust the color:

1. Pick a preferred color from the color palette or the list of **PRESET COLORS**. The selected color and its RGB color codes will be displayed on the right field.

 **NOTE: To change the color, use the up and down arrow buttons beside the R/G/B boxes to edit the color codes.**

2. To add the selected color to the list of **YOUR COLORS** for quick access in the future, click . At most 12 colors can be added to the list.

 **NOTE: To remove an existing color chip from the list, right-click on it.**

3. Drag the **BRIGHTNESS** slider to adjust the brightness of the color.

Spectrum

Description

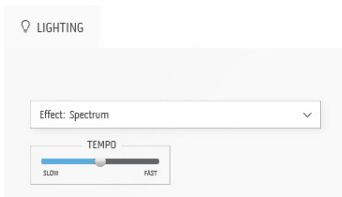

The effect makes the light change in sequence of spectrum: red, orange, yellow, green, blue, indigo, and violet.

You can drag the **TEMPO** slider to adjust the transition speed.

 **NOTE: The option is available only when you select All Zones to make lighting adjustments.**

Breathing

Description

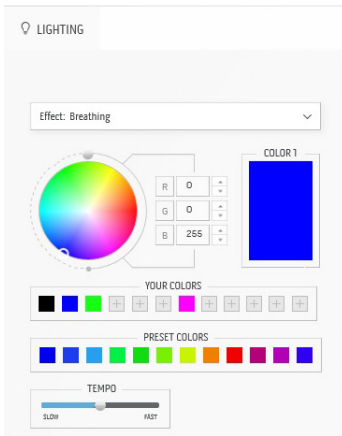

The effect makes the light change from bright to dim.

To adjust the breathing:

1. Pick a preferred color from the color palette or the list of **PRESET COLORS**. The selected color and its RGB color codes will be displayed on the right field.

 **NOTE: To change the color, use the up and down arrow buttons beside the R/G/B boxes to edit the color codes.**

2. To add the selected color to the list of **YOUR COLORS** for quick access in the future, click . At most 12 colors can be added to the list.
3. Drag the **TEMPO** slider to adjust the transition speed.

Static Default Blue

Description

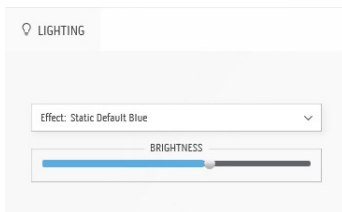

This effect makes the lights glow solid blue.

You can drag the **BRIGHTNESS** slider to change the intensity of the color from strong to light.

 **NOTE: The option is available only when you select All Zones to make lighting adjustments.**

Rainbow Cycle

Description

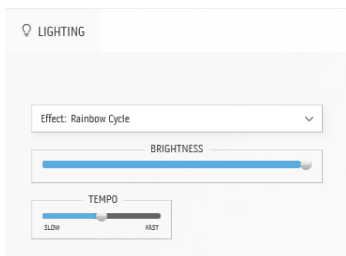

This effect makes the lights change in the sequence of rainbow colors.

You can drag the **BRIGHTNESS** slider to change the intensity of the color from strong to light.

You can drag the **TEMPO** slider to adjust the transition speed.

 **NOTE: The option is available only when you select All Zones to make lighting adjustments.**

Blink

Description

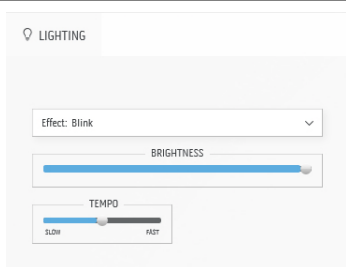

This effect makes the lights blink rapidly with RGB colors.

You can drag the **BRIGHTNESS** slider to change the intensity of the color from strong to light.

You can drag the **TEMPO** slider to adjust the transition speed.

 **NOTE: The option is available only when you select All Zones to make lighting adjustments.**

Comet

Description

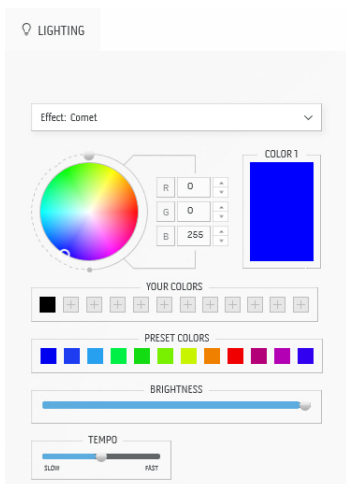

Select to deliver a dynamic comet light effect.

To make the adjustments:

1. Pick a preferred color from the color palette or the list of **PRESET COLORS**. The selected color and its RGB color codes will be displayed on the right field.

 **NOTE: To change the color, use the up and down arrow buttons beside the R/G/B boxes to edit the color codes.**

2. To add the selected color to the list of **YOUR COLORS** for quick access in the future, click . At most 12 colors can be added to the list.

 **NOTE: To remove an existing color chip from the list, right-click on it.**

3. Drag the **BRIGHTNESS** slider to adjust the brightness of the color.
4. Drag the **TEMPO** slider to adjust the pulsing speed.

Breathing RGB

Description

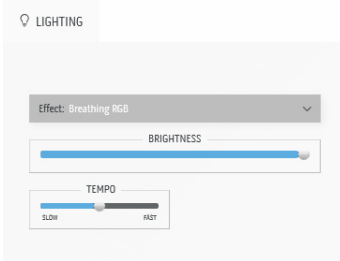

Select to apply a breathing RGB light effect.

You can drag the **BRIGHTNESS** slider to change the intensity of the color from strong to light.

You can drag the **TEMPO** slider to adjust the transition speed.

 **NOTE: The option is available only when you select All Zones to make lighting adjustments.**

Racing

Description

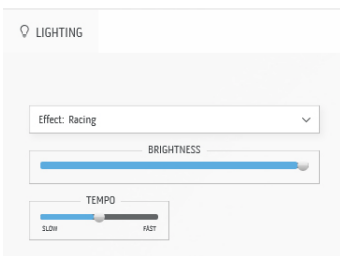

This effect makes the lights flash in a fast cycle of RGB colors.

You can drag the **BRIGHTNESS** slider to change the intensity of the color from strong to light.

You can drag the **TEMPO** slider to adjust the transition speed.

 **NOTE: The option is available only when you select All Zones to make lighting adjustments.**

Troubleshooting

⚠ WARNING: Before you begin any of the procedures in this section, follow the [Safety instructions](#).

Self-test

Your monitor provides a self-test feature that allows you to check whether your monitor is functioning properly. If your monitor and computer are properly connected but the monitor screen remains dark, run the monitor self-test by performing the following steps:

1. Turn off both your computer and the monitor.
2. Unplug the video cable from the computer.
3. Turn on the monitor.

📌 NOTE: A dialog box should appear on the screen, indicating that the monitor is working correctly and it is not receiving a video signal. While in self-test mode, the power LED blinks white (default color).

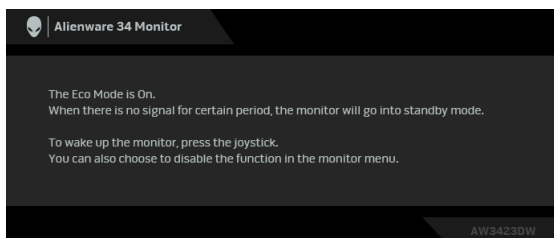

When Eco Mode is On

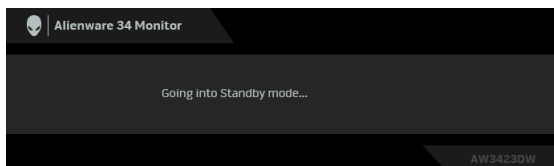

When Eco Mode is Off

📌 NOTE: This dialog box also appears during normal operation, if the video cable is disconnected or damaged.

4. Turn off your monitor and reconnect the video cable; then turn on both your computer and the monitor.

After performing the above steps, if the monitor displays no video output, then the problem may be with the graphics card or the computer.

Built-in diagnostics

Your monitor has a built-in diagnostic tool that helps you determine if the screen abnormality you are experiencing is an inherent problem with your monitor, or with your computer and video card.

 **NOTE: You can run the built-in diagnostics only when the video cable is unplugged and the monitor is in self-test mode.**

To run the built-in diagnostics:

1. Ensure that the screen is clean (no dust particles on the surface of the screen).
2. Move and hold the joystick left for five seconds. A gray screen appears after one second.
3. Observe if the screen has any defects or abnormalities.
4. Press the joystick. The color of the screen changes to red.
5. Observe if the screen has any defects or abnormalities.
6. Repeat steps 4 and 5 to inspect the display in green, blue, black, and white screens.

The test is complete when the white screen appears. To exit, press the joystick again.

If you do not detect any screen abnormalities upon using the built-in diagnostic tool, the monitor is functioning properly. Check the video card and computer.

Common problems

The following table contains general information about common monitor problems you might encounter and the possible solutions:

Common symptoms	What you experience	Possible solutions
No video/ power LED off	No picture	<ul style="list-style-type: none">▪ Ensure that the video cable connecting the monitor and the computer is properly connected and secure.▪ Verify that the power outlet is functioning properly using any other electrical equipment.▪ Ensure that the power button is depressed fully.▪ Ensure that the correct input source is selected in the Input Source menu.
No video/ power LED on	No picture or no brightness	<ul style="list-style-type: none">▪ Increase brightness and contrast controls in the Brightness/Contrast menu.▪ Perform monitor self-test feature check.▪ Check for bent or broken pins in the video cable connector.▪ Run the built-in diagnostics.▪ Ensure that the correct input source is selected in the Input Source menu.
Poor focus	Picture is fuzzy, blurry, or ghosting	<ul style="list-style-type: none">▪ Eliminate video extension cables.▪ Reset the monitor to factory settings.▪ Change the video resolution to the correct aspect ratio.
Shaky/jittery video	Wavy picture or fine movement	<ul style="list-style-type: none">▪ Reset the monitor to factory settings.▪ Check environmental factors.▪ Relocate the monitor and test in another room.

Common symptoms	What you experience	Possible solutions
Missing pixels	OLED screen has spots	<ul style="list-style-type: none"> ▪ Cycle power On-Off. ▪ Pixel that is permanently off is a natural defect that can occur in OLED technology. ▪ For more information on Dell Monitor Quality and Pixel Policy, see Dell support site: www.dell.com/pixelguidelines.
Stuck-on pixels	OLED screen has bright spots	<ul style="list-style-type: none"> ▪ Cycle power On-Off. ▪ Pixel that is permanently off is a natural defect that can occur in OLED technology. ▪ For more information on Dell Monitor Quality and Pixel Policy, see Dell support site: www.dell.com/pixelguidelines.
Brightness problems	Picture too dim or too bright	<ul style="list-style-type: none"> ▪ Reset the monitor to factory settings. ▪ Adjust brightness and contrast controls in the Brightness/Contrast menu.
Geometric distortion	Screen not centered correctly	Reset the monitor to factory settings.
Horizontal/vertical lines	Screen has one or more lines	<ul style="list-style-type: none"> ▪ Reset the monitor to factory settings. ▪ Perform monitor self-test feature check and determine if these lines are also in self-test mode. ▪ Check for bent or broken pins in the video cable connector. ▪ Run the built-in diagnostics.
Synchronization problems	Screen is scrambled or appears torn	<ul style="list-style-type: none"> ▪ Reset the monitor to factory settings. ▪ Perform monitor self-test feature check to determine if the scrambled screen appears in self-test mode. ▪ Check for bent or broken pins in the video cable connector. ▪ Restart the computer in the <i>safe mode</i>.

Common symptoms	What you experience	Possible solutions
Safety related issues	Visible signs of smoke or sparks	<ul style="list-style-type: none"> Do not perform any troubleshooting steps. Contact Dell immediately.
Intermittent problems	Monitor malfunctions on and off	<ul style="list-style-type: none"> Ensure that the video cable connecting the monitor to the computer is connected properly and is secure. Reset the monitor to factory settings. Perform monitor self-test feature check to determine if the intermittent problem occurs in self-test mode.
Missing color	Picture missing color	<ul style="list-style-type: none"> Perform monitor self-test feature check. Ensure that the video cable connecting the monitor to the computer is connected properly and is secure. Check for bent or broken pins in the video cable connector.
Wrong color	Picture color not good	<ul style="list-style-type: none"> Change the settings of the Preset Modes in the Game menu OSD depending on the application. Adjust R/G/B value under Custom Color in the Game menu OSD. Run the built-in diagnostics.
Wrong color in HDR mode	Color banding in the pictures	Try to lower down the frequency (DP: 3440 x 1440 at 144 Hz, HDMI: 3440 x 1440 at 60 Hz).

Product specific problems

Specific symptoms	What you experience	Possible solutions
Screen image is too small	Image is centered on screen, but does not fill entire viewing area	Reset the monitor to factory settings.
Cannot adjust the monitor with the joystick	OSD does not appear on the screen	Turn off the monitor, unplug the power cord, plug it back, and then turn on the monitor.
No input signal when user controls are pressed	No picture, the LED light is white	<ul style="list-style-type: none">▪ Check the signal source. Ensure that the computer is not in the power saving mode by moving the mouse or pressing any key on the keyboard.▪ Check whether the signal cable is plugged in properly. Re-plug the signal cable if necessary.▪ Reset the computer or video player.
The picture does not fill the entire screen	The picture cannot fill the height or width of the screen	<ul style="list-style-type: none">▪ Due to different video formats (aspect ratio), the monitor may display in full screen.▪ Run the built-in diagnostics.
The displayed pictures appear incorrectly when the DP/HDMI cable is connected through a USB-C adapter or dock to your laptop or desktop	Display will freeze, has black screen or display abnormal screen	Do not use a USB-C adapter or dock. Connect the DP/HDMI cable directly to your laptop or desktop.

Specific symptoms	What you experience	Possible solutions
Screen flickering	There are some noticeable flickering in the displayed pictures	<ul style="list-style-type: none"> ▪ Use the native resolution of your monitor (3440 x 1440 at 60 Hz) or higher refresh rate. ▪ If the variable refresh rate (VRR) of your device is turned on, turn off variable refresh rate (VRR). ▪ If you are using an NVIDIA graphics card and G-Sync is turned on, turn off G-Sync. ▪ If you are using an AMD graphics card and Free-Sync is turned on, turn off Free-Sync. ▪ Update the graphics card driver and firmware to the latest version. ▪ Change the cable connecting the monitor to the computer. A defective cable can cause the signal to break while being transmitted across the wire. ▪ Check the surroundings. Electromagnetic fields can cause screen flickering. If there is another device plugged into the same power strip as the monitor, try to remove it.

Specific symptoms	What you experience	Possible solutions
Image retention from a static image left on the monitor for a long period of time	Faint shadow from the static image displayed appears on the screen	<ul style="list-style-type: none"> ▪ Set the screen to turn off after a few minutes of screen idle time. These can be adjusted in Windows Power Options or Mac Energy Saver setting.
Unevenness in luminance or color of the screen images	Visible spots (bright or dark) or lines or Mura appear on the screen	<ul style="list-style-type: none"> ▪ Alternatively, use a dynamically changing screensaver. ▪ Perform the function of Pixel Refresh or Panel Refresh. See OLED Panel Maintenance.
In the HDR Peak 1000 mode, the displayed images are dimmer than they are in the HDR 400 True Black mode	The HDR Peak 1000 mode is ideal for the HDR content with a peak brightness of 1000 nits. When displaying non-HDR content, such as browsers and editors, the brightness level in the HDR Peak 1000 mode is observed to be lower as compared to that in the HDR 400 True Black mode due to the luminance control method of OLED panels.	<ul style="list-style-type: none"> ▪ For displaying non-HDR content, such as Office applications, disable the HDR display feature in Windows display settings. ▪ For displaying HDR videos or games with a maximum peak brightness of 1000 nits, set HDR Mode to HDR Peak 1000. ▪ For displaying HDR videos or games which meet the DisplayHDR 400 True Black standard, set HDR Mode to HDR 400 True Black.

Universal Serial Bus (USB) specific problems

Specific symptoms	What you experience	Possible solutions
USB interface is not working	USB peripherals are not working	<ul style="list-style-type: none">▪ Check that your monitor is turned on.▪ Reconnect the upstream cable to your computer.▪ Reconnect the USB peripherals (downstream connector).▪ Switch off and then turn on the monitor again.▪ Reboot the computer.▪ Some USB devices like external portable HDD require higher electric current; connect the device directly to the computer system.
SuperSpeed USB 5 Gbps (USB 3.2 Gen 1) interface is slow	SuperSpeed USB 5 Gbps (USB 3.2 Gen 1) peripherals working slowly or not working at all	<ul style="list-style-type: none">▪ Check that your computer is SuperSpeed USB 5 Gbps (USB 3.2 Gen 1)-compatible.▪ Some computers have USB 3.2, USB 2.0, and USB 1.1 ports. Ensure that the correct USB port is used.▪ Reconnect the upstream cable to your computer.▪ Reconnect the USB peripherals (downstream connector).▪ Reboot the computer.
Wireless USB peripherals stop working when a USB 3.2 device is plugged in	Wireless USB peripherals responding slowly or only working as the distance between itself and its receiver decreases	<ul style="list-style-type: none">▪ Increase the distance between the USB 3.2 peripherals and the wireless USB receiver.▪ Position your wireless USB receiver as close as possible to the wireless USB peripherals.▪ Use a USB-extender cable to position the wireless USB receiver as far away as possible from the USB 3.2 port.

Appendix

FCC notices (U.S. only) and other regulatory information

For FCC notices and other regulatory information, see the regulatory compliance website located at www.dell.com/regulatory_compliance.

Contact Dell

For customers in the United States, call 800-WWW-DELL (800-999-3355).

 **NOTE: If you do not have an active Internet connection, you can find contact information on your purchase invoice, packing slip, bill, or Dell product catalog.**

Dell provides several online and telephone-based support and service options. Availability varies by country and product, and some services may not be available in your area.

- Online technical assistance: www.dell.com/support/monitors
- Contacting Dell: www.dell.com/contactdell

EU product database for energy label and product information sheet

AW3423DW: <https://eprel.ec.europa.eu/qr/1049154>