

# ***Nikon***

DIGITAL CAMERA

# COOLPIX P900



## Reference Manual



<b>Introduction</b>	<b>➔ ii</b>
<b>Table of Contents</b>	<b>➔ xiv</b>
<b>Parts of the Camera</b>	<b>➔ 1</b>
<b>Preparing for Shooting</b>	<b>➔ 9</b>
<b>Basic Shooting and Playback Operations</b>	<b>➔ 16</b>
<b>Shooting Features</b>	<b>➔ 26</b>
<b>Functions That Can Be Set with the MENU (Menu) Button</b>	<b>➔ 49</b>
<b>Using Location Data Functions</b>	<b>➔ 59</b>
<b>Using the Wi-Fi (Wireless LAN) Function</b>	<b>➔ 60</b>
<b>Connecting the Camera to a TV, Printer, or Computer</b>	<b>➔ 61</b>
<b>Reference Section</b>	<b>➔ 61</b>
<b>Technical Notes and Index</b>	<b>➔ 61</b>

# Introduction





## Read This First

To get the most from this Nikon product, be sure to read “For Your Safety” (📖vi-viii), “<Important> Notes About Location Data Functions (GPS/GLONASS)” (📖xi) and “Wi-Fi (Wireless LAN Network)” (📖xii), and all other instructions thoroughly and keep them where they will be read by all who use the camera.

- If you want to start using the camera right away, see “Preparing for Shooting” (📖9) and “Basic Shooting and Playback Operations” (📖16).

## Other Information

- Symbols and Conventions

Symbol	Description
	This icon marks cautions and information that should be read before using the camera.
	This icon marks notes and information that should be read before using the camera.
	These icons mark other pages containing relevant information;  : “Reference Section”,  : “Technical Notes and Index.”

- SD, SDHC, and SDXC memory cards are referred to as “memory cards” in this manual.
- The setting at the time of purchase is referred to as the “default setting.”
- The names of menu items displayed in the camera monitor, and the names of buttons or messages displayed on a computer monitor appear in bold.
- In this manual, images are sometimes omitted from monitor display samples so that monitor indicators can be more clearly shown.

## Information and Precautions

### Life-Long Learning

As part of Nikon's "Life-Long Learning" commitment to ongoing product support and education, continually updated information is available online at the following websites:

- For users in the U.S.A.: <http://www.nikonusa.com/>
- For users in Europe and Africa: <http://www.europe-nikon.com/support/>
- For users in Asia, Oceania, and the Middle East: <http://www.nikon-asia.com/>

Visit these websites to keep up-to-date with the latest product information, tips, answers to frequently asked questions (FAQs), and general advice on digital imaging and photography. Additional information may be available from the Nikon representative in your area. Visit the website below for contact information.

<http://imaging.nikon.com/>

### Use Only Nikon Brand Electronic Accessories

Nikon COOLPIX cameras are designed to the highest standards and include complex electronic circuitry. Only Nikon brand electronic accessories (including battery chargers, batteries, AC adapters and, USB cables) certified by Nikon specifically for use with this Nikon digital camera are engineered and proven to operate within the operational and safety requirements of this electronic circuitry.

THE USE OF NON-NIKON ELECTRONIC ACCESSORIES COULD DAMAGE THE CAMERA AND MAY VOID YOUR NIKON WARRANTY.

The use of third-party rechargeable Li-ion batteries not bearing the Nikon holographic seal could interfere with normal operation of the camera or result in the batteries overheating, igniting, rupturing, or leaking.

**Holographic seal:** Identifies this device as an authentic Nikon product.



For more information about Nikon brand accessories, contact a local authorized Nikon dealer.

### Before Taking Important Pictures

Before taking pictures on important occasions (such as at weddings or before taking the camera on a trip), take a test shot to ensure that the camera is functioning normally. Nikon will not be held liable for damages or lost profits that may result from product malfunction.

## About the Manuals

- No part of the manuals included with this product may be reproduced, transmitted, transcribed, stored in a retrieval system, or translated into any language in any form, by any means, without Nikon's prior written permission.
- Illustrations and monitor content shown in this manual may differ from the actual product.
- Nikon reserves the right to change the specifications of the hardware and software described in these manuals at any time and without prior notice.
- Nikon will not be held liable for any damages resulting from the use of this product.
- While every effort was made to ensure that the information in these manuals is accurate and complete, we would appreciate it were you to bring any errors or omissions to the attention of the Nikon representative in your area (address provided separately).

## Notice Concerning Prohibition of Copying or Reproduction

Note that simply being in possession of material that was digitally copied or reproduced by means of a scanner, digital camera or other device may be punishable by law.

### • Items prohibited by law from being copied or reproduced

Do not copy or reproduce paper money, coins, securities, government bonds or local government bonds, even if such copies or reproductions are stamped "Sample." The copying or reproduction of paper money, coins, or securities which are circulated in a foreign country is prohibited. Unless the prior permission of the government was obtained, the copying or reproduction of unused postage stamps or post cards issued by the government is prohibited.

The copying or reproduction of stamps issued by the government and of certified documents stipulated by law is prohibited.

### • Cautions on certain copies and reproductions

The government has issued cautions on copies or reproductions of securities issued by private companies (shares, bills, checks, gift certificates, etc.), commuter passes, or coupon tickets, except when a minimum of necessary copies are to be provided for business use by a company. Also, do not copy or reproduce passports issued by the government, licenses issued by public agencies and private groups, ID cards and tickets, such as passes and meal coupons.

### • Comply with copyright notices

The copying or reproduction of copyrighted creative works such as books, music, paintings, woodcut prints, maps, drawings, movies, and photographs is governed by national and international copyright laws. Do not use this product for the purpose of making illegal copies or to infringe copyright laws.

## Disposing of Data Storage Devices

Please note that deleting images or formatting data storage devices such as memory cards does not completely erase the original image data. Deleted files can sometimes be recovered from discarded storage devices using commercially available software, potentially resulting in the malicious use of personal image data. Ensuring the privacy of such data is the user's responsibility.

Before discarding a data storage device or transferring ownership to another person, erase all data using commercial deletion software, or format the device, set **Record location data** to **Off** in **Location data options** (0094), and then completely refill it with images containing no private information (for example, images of empty sky). Care should be taken to avoid injury or damage to property when physically destroying data storage devices.

For the COOLPIX P900, the log data saved on the memory card is handled in the same way as other data. To erase the log data that is obtained but not stored on the memory card, select **Create log** → **End log** → **Erase log**.

To delete the Wi-Fi settings, select **Restore default settings** in the Wi-Fi options menu (0092).

## For Your Safety

To prevent damage to your Nikon product or injury to yourself or to others, read the following safety precautions in their entirety before using this equipment. Keep these safety instructions where all those who use the product will read them.

The consequences that could result from failure to observe the precautions listed in this section are indicated by the following symbol:



This icon marks warnings, information that should be read before using this Nikon product, to prevent possible injury.

### WARNINGS



#### **Turn off in the event of malfunction**

Should you notice smoke or an unusual smell coming from the camera or Charging AC Adapter, unplug the Charging AC Adapter and remove the battery immediately, taking care to avoid burns. Continued operation could result in injury. After removing or disconnecting the power source, take the equipment to a Nikon-authorized service representative for inspection.



#### **Do not disassemble**

Touching the internal parts of the camera or Charging AC Adapter could result in injury. Repairs should be performed only by qualified technicians. Should the camera or Charging AC Adapter break open as the result of a fall or other accident, take the product to a Nikon-authorized service representative for inspection, after unplugging the product and/or removing the battery.



#### **Do not use the camera or Charging AC Adapter in the presence of flammable gas**

Do not use electronic equipment in the presence of flammable gas, as this could result in explosion or fire.



#### **Handle the camera strap with care**

Never place the strap around the neck of an infant or child.



#### **Keep out of reach of children**

Particular care should be taken to prevent infants from putting the battery or other small parts into their mouths.



#### **Do not remain in contact with the camera, Charging AC Adapter, or AC adapter for extended periods while the devices are on or in use**

Parts of the devices become hot. Leaving the devices in direct contact with the skin for extended periods may result in low-temperature burns.



 **Do not leave the product where it will be exposed to extremely high temperatures, such as in an enclosed automobile or in direct sunlight**

Failure to observe this precaution could cause damage or fire.

 **Keep the sun out of the frame**

Keep the sun well out of the frame when shooting backlit subjects. Sunlight focused into the camera when the sun is in or close to the frame could cause a fire.

 **Observe caution when handling the battery**

The battery may leak, overheat, or explode if improperly handled. Observe the following precautions when handling the battery for use in this product:

- Before replacing the battery, turn the product off. If you are using the Charging AC Adapter/AC adapter, be sure it is unplugged.
- Use only a Rechargeable Li-ion Battery EN-EL23 (included). Charge the battery by using a camera that supports battery charging. To perform this operation, use the Charging AC Adapter EH-71P (included) and USB Cable UC-E21 (included). The Battery Charger MH-67P (available separately) is also available to charge the battery without using a camera.
- When inserting the battery, do not attempt to insert it upside down or backwards.
- Do not short or disassemble the battery or attempt to remove or break the battery insulation or casing.
- Do not expose the battery to flame or to excessive heat.
- Do not immerse in or expose to water.
- Put the battery in a plastic bag, etc. in order to insulate it before transporting. Do not transport or store with metal objects such as necklaces or hairpins.
- The battery is prone to leakage when fully discharged. To avoid damage to the product, be sure to remove the battery when no charge remains.
- Discontinue use immediately should you notice any change in the battery, such as discoloration or deformation.
- If liquid from the damaged battery comes in contact with clothing or skin, rinse immediately with plenty of water.

 **Observe the following precautions when handling the Charging AC Adapter**

- Keep dry. Failure to observe this precaution could result in fire or electric shock.
- Dust on or near the metal parts of the plug should be removed with a dry cloth. Continued use could result in fire.
- Do not handle the plug or go near the Charging AC Adapter during lightning storms. Failure to observe this precaution could result in electric shock.

- Do not damage, modify, forcibly tug or bend the USB cable, place it under heavy objects, or expose it to heat or flames. Should the insulation be damaged and the wires become exposed, take it to a Nikon-authorized service representative for inspection. Failure to observe these precautions could result in fire or electric shock.
- Do not handle the plug or Charging AC Adapter with wet hands. Failure to observe this precaution could result in electric shock.
- Do not use with travel converters or adapters designed to convert from one voltage to another or with DC-to-AC inverters. Failure to observe this precaution could damage the product or cause overheating or fire.

 **Use the appropriate power supply (battery, Charging AC Adapter, AC adapter, USB cable)**

Using a power supply other than those provided or sold by Nikon could result in damage or malfunction.

 **Use appropriate cables**

When connecting cables to the input and output jacks, use only the cables provided or sold by Nikon for the purpose, to maintain compliance with product regulations.

 **Do not touch the moving parts of the lens**

Failure to observe this precaution could result in injury.

 **Handle moving parts with care**

Be careful that your fingers or other objects are not pinched by the lens cover or other moving parts.

 **Using the flash close to your subject's eyes could cause temporary visual impairment**

The flash should be no less than 1 meter (3 ft 4 in.) from the subject. Particular care should be observed when photographing infants.

 **Do not operate the flash with the flash window touching a person or object**

Failure to observe this precaution could result in burns or fire.

 **Avoid contact with liquid crystal**

Should the monitor break, care should be taken to avoid injury caused by broken glass and to prevent liquid crystal from the monitor touching the skin or entering the eyes or mouth.

 **Follow the instructions of airline and hospital personnel**

# Notices

## Notices for Customers in the U.S.A.

### **IMPORTANT SAFETY INSTRUCTIONS - SAVE THESE INSTRUCTIONS.**

### **DANGER - TO REDUCE THE RISK OF FIRE OR ELECTRIC SHOCK, CAREFULLY FOLLOW THESE INSTRUCTIONS**

For connection to a supply not in the U.S.A., use an attachment plug adapter of the proper configuration for the power outlet if needed.

The power supply unit is intended to be correctly orientated in a vertical or floor mount position.

### **Federal Communications Commission (FCC) Radio Frequency Interference Statement**

This equipment has been tested and found to comply with the limits for a Class B digital device, pursuant to Part 15 of the FCC rules. These limits are designed to provide reasonable protection against harmful

interference in a residential installation. This equipment generates, uses, and can radiate radio frequency energy and, if not installed and used in accordance with the instructions, may cause harmful interference to radio communications. However, there is no guarantee that interference will not occur in a particular installation. If this equipment does cause harmful interference to radio or television reception, which can be determined by turning the equipment off and on, the user is encouraged to try to correct the interference by one or more of the following measures:

- Reorient or relocate the receiving antenna.
- Increase the separation between the equipment and receiver.
- Connect the equipment into an outlet on a circuit different from that to which the receiver is connected.
- Consult the dealer or an experienced radio/television technician for help.



## **CAUTIONS**

### **Modifications**

The FCC requires the user to be notified that any changes or modifications made to this device that are not expressly approved by Nikon Corporation may void the user's authority to operate the equipment.

### **Interface Cables**

Use the interface cables sold or provided by Nikon for your equipment. Using other interface cables may exceed the limits of Class B Part 15 of the FCC rules.

## Notice for Customers in the State of California

### WARNING

Handling the cord on this product will expose you to lead, a chemical known to the State of California to cause birth defects or other reproductive harm.

### Wash hands after handling.

Nikon Inc.,

1300 Walt Whitman Road, Melville, New York 11747-3064, U.S.A.

Tel: 631-547-4200

## Notice for Customers in Canada

CAN ICES-3 B / NMB-3 B

## Notices for Customers in Europe

### CAUTIONS

**RISK OF EXPLOSION IF BATTERY IS REPLACED BY AN INCORRECT TYPE.**

**DISPOSE OF USED BATTERIES ACCORDING TO THE INSTRUCTIONS.**

This symbol indicates that electrical and electronic equipment is to be collected separately.

The following apply only to users in European countries:

- This product is designated for separate collection at an appropriate collection point. Do not dispose of as household waste.
- Separate collection and recycling helps conserve natural resources and prevent negative consequences for human health and the environment that might result from incorrect disposal.
- For more information, contact the retailer or the local authorities in charge of waste management.



This symbol on the battery indicates that the battery is to be collected separately.

The following apply only to users in European countries:

- All batteries, whether marked with this symbol or not, are designated for separate collection at an appropriate collection point. Do not dispose of as household waste.
- For more information, contact the retailer or the local authorities in charge of waste management.



## <Important> Notes About Location Data Functions (GPS/GLONASS)

### ● Location name data of this camera

Before using the location data functions, make sure to read "USER LICENSE AGREEMENT FOR LOCATION NAME DATA" (📄22) and agree to the terms.

- The location name information (Points of Interest: POI) are as of April 2014. The location name information will not be updated.
- Use the location name information only as a guide.
- The location name information (Points of Interest: POI) of the People's Republic of China ("China") and the Republic of Korea are not provided for the COOLPIX P900.

### ● Notes about record location data functions and log recording

- Use information measured by the camera as a guideline only. This information cannot be used for navigation of an airplane, car, and person or land survey applications.
- When **Record location data** in **Location data options** of the location data options menu is set to **On** or during log recording, record location data functions and log recording function will continue to operate even after the camera is turned off (🔌40).
- An individual may be identified from still images or movies that have been recorded with location data. Observe caution when you transfer still images or movies recorded with location data, or log files to a third party or upload them to a network such as the Internet where the public can view them. Make sure to read "Disposing of Data Storage Devices" (📖).

### ● Using the camera overseas

- Before taking the camera with location data functions overseas for travel, consult your travel agency or embassy of the country you are visiting to confirm whether there is any restriction on use. For example, you cannot record location data logs without permission from the government in China. Set **Record location data** to **Off**.
- The location data may not function properly in China and on the borders between China and neighboring countries (as of December 2014).

## Wi-Fi (Wireless LAN Network)

This product is controlled by the United States Export Administration Regulations, and you are required to obtain permission from the United States government if you export or re-export this product to any country to which the United States embargoes goods. The following countries were subject to embargo: Cuba, Iran, North Korea, Sudan, and Syria. Since the target countries are subject to change, please contact the United States Department of Commerce for the latest information.

### **Restrictions on Wireless Devices**

The wireless transceiver included in this product conforms to wireless regulations in the country of sale and is not for use in other countries (products purchased in the EU or EFTA can be used anywhere within the EU and EFTA). Nikon does not accept liability for use in other countries. Users who are unsure as to the original country of sale should consult with their local Nikon service center or Nikon-authorized service representative. This restriction applies to wireless operation only and not to any other use of the product.

### **Notice for Customers in the U.S.A. and Canada**

#### **Federal Communications Commission (FCC) and Industry of Canada (IC)**

#### **Declaration of Conformity**

This device complies with Part 15 of FCC Rules and Industry Canada licence-exempt RSS standard(s). Operation is subject to the following two conditions: (1) this device may not cause interference, and (2) this device must accept any interference, including interference that may cause undesired operation of this device.

#### **FCC/IC RF Exposure Statement**

This transmitter must not be co-located or operated in conjunction with any other antenna or transmitter.

The available scientific evidence does not show that any health problems are associated with using low power wireless devices. There is no proof, however, that these low power wireless devices are absolutely safe. Low power wireless devices emit low levels of radio frequency energy (RF) in the microwave range while being used. Whereas high levels of RF can produce health effects (by heating tissue), exposure of low-level RF that does not produce heating effects causes no known adverse health effects. Many studies of low-level RF exposures have not found any biological effects. Some studies have suggested that some biological effects might occur, but such findings have not been confirmed by additional research.

COOLPIX P900, which is equipped with a DW092 (FCC ID:EW4DW092/IC ID:4634A-3149EC) Wireless LAN Module, has been tested and found to comply with FCC/IC radiation exposure limits set forth for an uncontrolled environment and meets the FCC radio frequency (RF) Exposure Guidelines in Supplement C to OET65 and RSS-102 of the IC radio frequency (RF) Exposure rules. Please refer to the SAR test report that was uploaded to FCC website.

### **Declaration of Conformity (Europe)**

Hereby, Nikon Corporation, declares that COOLPIX P900 is in compliance with the essential requirements and other relevant provisions of Directive 1999/5/EC. The declaration of conformity may be consulted at [http://imaging.nikon.com/support/pdf/DoC\\_P900.pdf](http://imaging.nikon.com/support/pdf/DoC_P900.pdf).

### **Notice for Customers in Jamaica**

This product contains a Type Approved Module by Jamaica: "SMA – DW092"

### **Precautions when Using Radio Transmissions**

Always keep in mind that radio transmission or reception of data is subject to interception by third parties. Note that Nikon is not responsible for data or information leaks that may occur during data transfer.

### **Personal Information Management and Disclaimer**





































- User information registered and configured on the product, including wireless LAN connection settings and other personal information, is susceptible to alteration and loss resulting from operational error, static electricity, accident, malfunction, repair or other handling. Always keep separate copies of important information. Nikon is not responsible for any direct or indirect damages or lost profits resulting from alteration or loss of content that is not attributable to Nikon.
- Before discarding this product or transferring it to another owner, perform **Reset all** in the setup menu (📖57) to delete all user information registered and configured with the product, including wireless LAN connection settings and other personal information.

# Table of Contents

Introduction .....	ii
Read This First .....	ii
Other Information.....	ii
Information and Precautions.....	iii
For Your Safety .....	vi
WARNINGS .....	vi
Notices .....	ix
<Important> Notes About Location Data Functions (GPS/GLONASS) .....	xi
Wi-Fi (Wireless LAN Network).....	xii
<hr/>	
Parts of the Camera .....	1
The Camera Body.....	1
The Monitor .....	3
Switching the Information Displayed in the Monitor ( <b>DISP</b> Button).....	3
For Shooting.....	4
For Playback.....	7
<hr/>	
Preparing for Shooting.....	9
How to Attach the Camera Strap and Lens Cap .....	9
Insert the Battery and Memory Card .....	10
Removing the Battery or Memory Card.....	10
Charge the Battery .....	11
Opening and Adjusting the Angle of the Monitor .....	13
Turn the Camera On and Set the Display Language, Date, and Time .....	14
<hr/>	
Basic Shooting and Playback Operations .....	16
Shooting with  (Auto) Mode.....	16
Using the Flash.....	18
Switching Between the Monitor and Viewfinder.....	19
Using the Zoom .....	20
The Shutter-release Button.....	21
Recording Movies .....	21
Play Back Images.....	22
Delete Images .....	23
Changing the Shooting Mode .....	24
Functions That Can Be Set Using the Multi Selector (for Shooting).....	25



Shooting Features .....	26
📷 (Auto) Mode .....	26
Scene Mode (Shooting Suited to Scenes) .....	27
Special Effects Mode (Applying Effects When Shooting) .....	28
<b>P, S, A, M</b> Modes (Setting the Exposure for Shooting) .....	30
<b>U</b> (User Settings) Mode .....	34
Saving Settings in <b>U</b> Mode (Save User Settings) .....	35
Flash Mode .....	36
Self-timer .....	38
Smile Timer (Shooting Smiling Faces Automatically) .....	39
Focus Mode .....	40
Using Manual Focus .....	42
Exposure Compensation (Adjusting Brightness) .....	44
Functions That Can Be Set with the Fn (Function) Button .....	45
Functions That Cannot Be Used Simultaneously When Shooting .....	46
<hr/>	
Functions That Can Be Set with the <b>MENU</b> (Menu) Button .....	49
The Shooting Menu .....	51
Common Options .....	51
For <b>P, S, A, M, U</b> modes .....	51
The Movie Menu .....	54
The Playback Menu .....	55
The Image Selection Screen .....	56
The Setup Menu .....	57
<hr/>	
Using Location Data Functions .....	59
<hr/>	
Using the Wi-Fi (Wireless LAN) Function .....	60
Installing the Software on the Smart Device .....	60
<hr/>	
Connecting the Camera to a TV, Printer, or Computer .....	61

<b>Hints and Notes About the Scene Mode</b> .....	 3
Shooting with Easy Panorama.....	 10
Playback with Easy Panorama.....	 12
Shooting Time-lapse Movies.....	 13
<b>Default Settings (Flash, Focus mode, Etc.)</b> .....	 15
<b>Focusing</b> .....	 18
Using Target Finding AF.....	 18
Using Face Detection.....	 19
Using Skin Softening.....	 20
Subjects Not Suitable for Autofocus.....	 20
Focus Lock.....	 21
<b>The Control Range of the Shutter Speed (P, S, A, M Modes)</b> .....	 22
<b>Playback Zoom</b> .....	 23
<b>Thumbnail Playback/Calendar Display</b> .....	 24
<b>Viewing and Deleting Images Captured Continuously (Sequence)</b> .....	 25
Viewing Images in a Sequence.....	 25
Deleting Images in a Sequence.....	 26
<b>Editing Images (Still Images)</b> .....	 26
Before Editing Images.....	 26
Quick Retouch: Enhancing Contrast and Saturation.....	 27
D-Lighting: Enhancing Brightness and Contrast.....	 27
Skin Softening: Softening Skin Tones.....	 28
Filter Effects: Applying Digital Filter Effects.....	 29
Small Picture: Reducing the Size of an Image.....	 30
Crop: Creating a Cropped Copy.....	 31
<b>Recording and Playing Back Movies</b> .....	 32
<b>Capturing Still Images While Recording Movies</b> .....	 35
<b>Operations During Movie Playback</b> .....	 36
<b>Editing Movies</b> .....	 37
Extracting Only the Desired Portion of a Movie.....	 37
Saving a Frame from a Movie as a Still Image.....	 38
<b>Recording the Location Data on the Image</b> .....	 39
<b>Recording the Log of Movement Information</b> .....	 42
Ending Log to Save it on Memory Cards.....	 44
<b>Connecting to a Smart Device (Wi-Fi)</b> .....	 45
<b>Preselecting Images in the Camera That You Want to Transfer to a Smart Device</b> .....	 47
<b>Connecting the Camera to a TV (Playback on a TV)</b> .....	 48

<b>Connecting the Camera to a Printer (Direct Print)</b> .....	89
Connecting the Camera to a Printer .....	89
Printing Images One at a Time .....	50
Printing Multiple Images .....	51
<b>Using ViewNX-i (Transferring Images to a Computer)</b> .....	53
Installing ViewNX-i .....	53
Transferring Images to a Computer .....	53
<b>The Shooting Menu (The Common Shooting Options)</b> .....	56
Image Quality .....	56
Image Size .....	57
<b>The Shooting Menu (P, S, A or M Mode)</b> .....	58
Picture Control (COOLPIX Picture Control) .....	58
Custom Picture Control (COOLPIX Custom Picture Control).....	62
White Balance (Adjusting Hue) .....	63
Metering .....	66
Continuous Shooting .....	67
ISO Sensitivity .....	71
Exposure Bracketing.....	72
AF Area Mode .....	73
Autofocus Mode .....	76
Flash Exp. Comp. ....	76
Noise Reduction Filter .....	77
Active D-Lighting .....	77
Multiple Exposure .....	78
Zoom Memory.....	80
Startup Zoom Position.....	81
M Exposure Preview .....	81
<b>The Movie Menu</b> .....	82
Movie Options.....	82
Autofocus Mode.....	85
Electronic VR .....	86
Wind Noise Reduction .....	86
Zoom Microphone .....	87
Frame Rate .....	87
<b>The Playback Menu</b> .....	88
Mark for Wi-Fi Upload .....	88
Slide Show .....	89
Protect.....	90
Rotate Image .....	90
Sequence Display Options.....	91
Choose Key Picture .....	91

<b>The Wi-Fi Options Menu</b> .....	92
Operating the Text Input Keyboard .....	93
<b>The Location Data Options Menu</b> .....	94
Location Data Options.....	94
Updating the A-GPS File .....	95
Points of Interest (POI) (Recording and Displaying Location Name Information).....	96
Set Clock from Satellite.....	97
<b>The Setup Menu</b> .....	98
Time Zone and Date .....	98
Slot Empty Release Lock .....	100
Monitor Settings.....	101
EVF Auto Toggle (Automatically Switching the Display to the Viewfinder) .....	103
Date Stamp .....	103
Vibration Reduction .....	104
AF Assist .....	105
Digital Zoom .....	105
Assign Side Zoom Control.....	106
Sound Settings .....	106
Auto Off .....	107
Format Card .....	107
Language .....	107
Charge by Computer.....	108
Toggle Av/Tv Selection .....	109
Reset File Numbering .....	109
Peaking.....	110
Reset All .....	110
Firmware Version .....	110
<b>Error Messages</b> .....	111
<b>File Names</b> .....	115
<b>Optional Accessories</b> .....	116
<b>Shooting with Remote Control ML-L3</b> .....	117
<b>Principle Functions of the Controls</b> .....	119













---

---

Technical Notes and Index.....		1
--------------------------------	--	---

---

---

<b>Caring for the Product .....</b>		2
The Camera.....		2
The Battery .....		3
The Charging AC Adapter.....		4
Memory Cards.....		5
<b>Cleaning and Storage.....</b>		6
Cleaning.....		6
Storage .....		6
<b>Troubleshooting .....</b>		7
<b>Specifications .....</b>		16
Approved Memory Cards.....		20
<b>USER LICENSE AGREEMENT FOR LOCATION NAME DATA .....</b>		22
<b>Index.....</b>		28



A series of horizontal dashed lines spanning the width of the page, intended for handwriting practice.

# Parts of the Camera

## The Camera Body

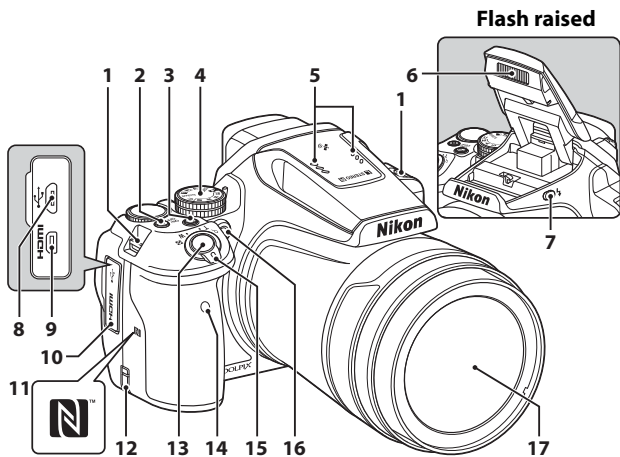

- |           |  |            |           |  |          |
|-----------|--|------------|-----------|--|----------|
| <b>1</b>  | Eyelet for camera strap.....                     | 9          | <b>11</b> | N-Mark (NFC antenna).....                                      | 46       |
| <b>2</b>  | Power switch/power-on lamp<br>(charge lamp)..... | 11, 14, 18 | <b>12</b> | Power connector cover (for<br>optional AC adapter).....        | 116      |
| <b>3</b>  | <b>Fn</b> (function) button ...                  | 45,  120   | <b>13</b> | Shutter-release button<br>.....                                | 17,  120 |
| <b>4</b>  | Mode dial.....                                   | 16, 24     | <b>14</b> | Infrared receiver (for optional<br>Remote Control ML-L3) ..... | 117      |
| <b>5</b>  | Microphone (stereo).....                         | 54,  32    |           | Zoom control .....   | 20       |
| <b>6</b>  | Flash.....                                       | 36         |           | <b>W</b> : wide-angle.....                                     | 20, 22   |
| <b>7</b>  | (flash pop-up) button.....                       | 36         |           | <b>T</b> : telephoto .....                                     | 20, 22   |
| <b>8</b>  | Micro-USB connector .....                        | 11, 61     | <b>15</b> | : thumbnail playback   | 24       |
| <b>9</b>  | HDMI micro connector (Type D)<br>.....           | 61         |           | : playback zoom .....  | 23       |
| <b>10</b> | Connector cover.....                             | 11, 61     |           | Self-timer lamp.....   | 38       |
|           |  |            | <b>16</b> | Red-eye reduction lamp .....                                   | 37       |
|           |  |            |           | AF-assist illuminator.....                                     | 57       |
|           |  |            | <b>17</b> | Lens   |          |

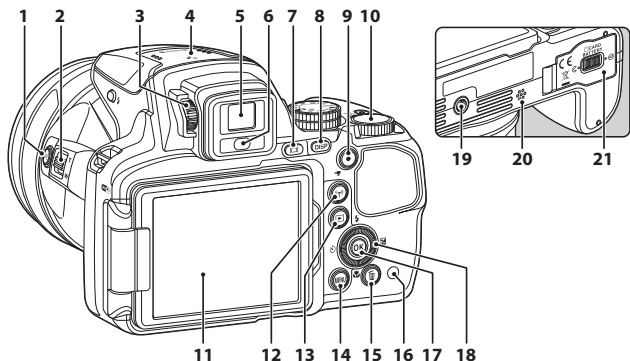

<b>1</b>	(snap-back zoom) button ..... 21	<b>12</b>	(Wi-Fi) button..... 60,  45
<b>2</b>	Side zoom control ..... 20 <b>W</b> : wide-angle..... 20 <b>T</b> : telephoto ..... 20	<b>13</b>	(playback) button ..... 22
<b>3</b>	Diopter adjustment control ..... 19	<b>14</b>	<b>MENU</b> (menu) button ..... 49, 51, 54, 55, 57
<b>4</b>	Positioning antenna.....  40	<b>15</b>	(delete) button ..... 23
<b>5</b>	Electronic viewfinder..... 19	<b>16</b>	Infrared receiver (for optional Remote Control ML-L3) .....  117
<b>6</b>	Eye sensor ..... 19	<b>17</b>	(apply selection) button ..... 50,  119,  122
<b>7</b>	(monitor) button ..... 19	<b>18</b>	Rotary multi selector (multi selector)* ..... 25,  119,  121
<b>8</b>	<b>DISP</b> (display) button..... 3	<b>19</b>	Tripod socket
<b>9</b>	(movie-record) button ..... 21,  32	<b>20</b>	Speaker ..... 57,  36
<b>10</b>	Command dial ..... 30, 32,  120,  122	<b>21</b>	Battery-chamber/memory card slot cover ..... 10
<b>11</b>	Monitor..... 4, 13		

\* Also referred to as the “multi selector” in this manual.



# The Monitor

The information that is displayed in the monitor during shooting and playback changes depending on the camera's settings and state of use.

## Switching the Information Displayed in the Monitor (DISP Button)

To switch the information displayed in the monitor during shooting and playback, press the **DISP** (display) button.

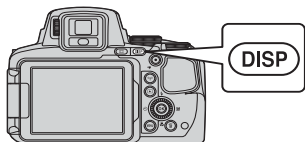

### For Shooting



**Show information**  
Display the image and the shooting information.

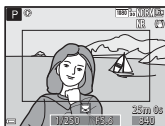

**Movie frame**  
Display the range of a movie in a frame.



**Hide information**  
Display the image only.



### Histogram, Framing Grid and Virtual Horizon for Shooting

Each setting can be set using **Monitor settings** in the setup menu (📖57).

- To display a histogram or virtual horizon in **P**, **S**, **A** or **M** shooting mode, set **AF area mode** (📖52) to one of the manual options.
- The histogram or virtual horizon cannot be displayed in  (auto) mode or some scene modes.

### For Playback



**Show information**  
Display the image and photo information.

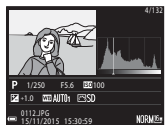

**Tone level information (except movies)**  
Display a histogram, tone level and shooting information (📖8).



**Hide information**  
Display the image only.

# For Shooting

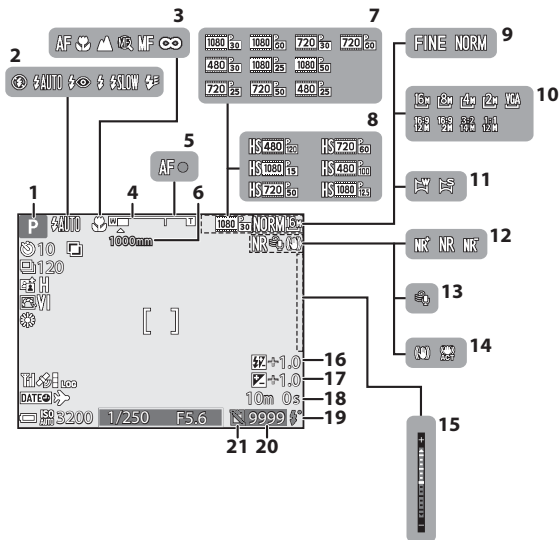

<b>1</b>	Shooting mode.....	24	<b>13</b>	Wind noise reduction.....	54
<b>2</b>	Flash mode .....	36	<b>14</b>	Vibration reduction icon.....	57
<b>3</b>	Focus mode.....	40	<b>14</b>	Electronic VR icon.....	54
<b>4</b>	Zoom indicator.....	20, 41	<b>15</b>	Exposure indicator .....	32
<b>5</b>	Focus indicator .....	17	<b>16</b>	Flash exp. comp.....	52
<b>6</b>	Zoom memory .....	53	<b>17</b>	Exposure compensation value ...	44
<b>7</b>	Movie options (normal speed movies).....	54	<b>18</b>	Remaining movie recording time .....	32, 33
<b>8</b>	Movie options (HS movies).....	54	<b>19</b>	Ready light.....	36
<b>9</b>	Image quality.....	51	<b>20</b>	Number of exposures remaining (still images).....	16, 56
<b>10</b>	Image size.....	51		Enable release icon (when no memory card is inserted) .....	57, 100, 9
<b>11</b>	Easy panorama .....	27, 10			
<b>12</b>	Noise reduction filter.....	52			

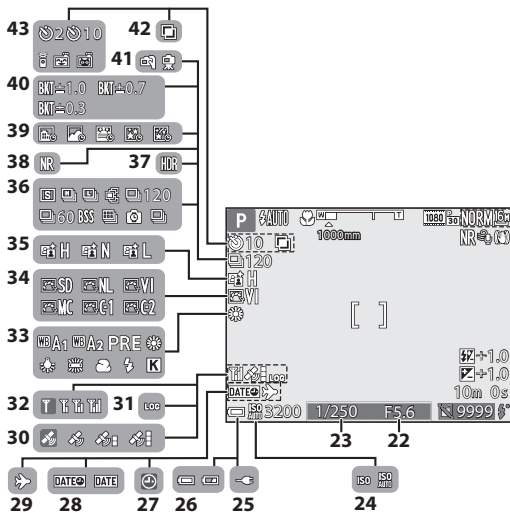

<b>22</b>	Aperture value.....	30	<b>35</b>	Active D-Lighting.....	52
<b>23</b>	Shutter speed.....	30	<b>36</b>	Continuous shooting mode.....	52, 8
<b>24</b>	ISO sensitivity .....	52	<b>37</b>	Backlighting (HDR).....	27, 7
<b>25</b>	Charging AC adapter connection indicator		<b>38</b>	Noise reduction burst/single shot.....	4, 5
<b>26</b>	Battery level indicator .....	16	<b>39</b>	Time-lapse movie.....	27, 13
<b>27</b>	"Date not set" indicator.....	57, 8	<b>40</b>	Exposure bracketing .....	52
<b>28</b>	Date stamp .....	57	<b>41</b>	Hand-held/tripod.....	3
<b>29</b>	Travel destination icon .....	57	<b>42</b>	Multiple exposure .....	52
<b>30</b>	Location data reception .....	59		Self-timer indicator.....	38
<b>31</b>	Log display.....	42	<b>43</b>	Remote control.....	117
<b>32</b>	Wi-Fi communication indicator.....	60, 45		Smile timer.....	39
<b>33</b>	White balance .....	51		Pet portrait auto release ...	38, 8
<b>34</b>	COOLPIX Picture Control.....	51			

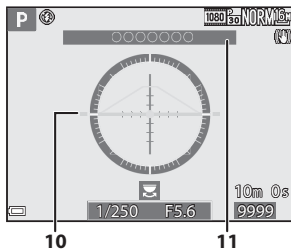
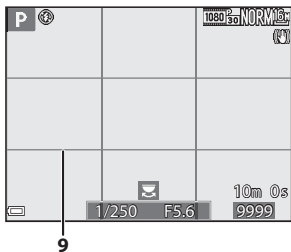
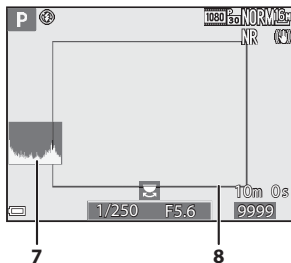
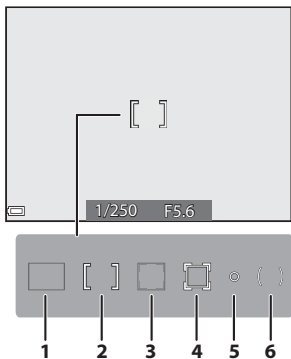

- 1** Focus area (target finding AF) .....45, 52, 18
- 2** Focus area (center/manual) .....27, 28, 45, 52, 21
- 3** Focus area (face detection, pet detection) .....39, 45, 52, 8, 19
- 4** Focus area (subject tracking) .....45, 52, 75
- 5** Spot metering area .....52
- 6** Center-weighted area .....52

- 7** View/hide histograms .....3, 101
- 8** Framing border (**Moon** or **Bird-watching** scene mode, or snapshot zoom) .....21, 9
- 9** View/hide framing grid .....3, 101
- 10** Virtual horizon .....3, 101, 102
- 11** Location name information (POI information) .....59, 41

# For Playback

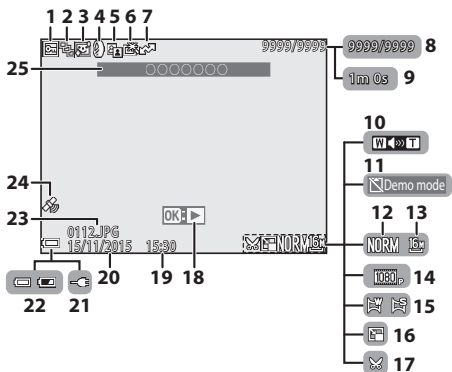

<b>1</b>	Protect icon.....	55	<b>14</b>	Movie options.....	54
<b>2</b>	Sequence display (when <b>Individual pictures</b> is selected) .....	56, 91	<b>15</b>	Easy panorama indicator.....	12
<b>3</b>	Skin softening icon.....	55	<b>16</b>	Small picture icon.....	55
<b>4</b>	Filter effects icon.....	55	<b>17</b>	Crop icon.....	23
<b>5</b>	D-Lighting icon.....	55		Easy panorama playback guide .....	12, 122
<b>6</b>	Quick retouch icon.....	55	<b>18</b>	Sequence playback guide .....	25, 122
<b>7</b>	Wi-Fi upload reservation icon .....	88		Movie playback guide.....	32
<b>8</b>	Current image number/ total number of images		<b>19</b>	Time of recording.....	14
<b>9</b>	Movie length or elapsed playback time		<b>20</b>	Date of recording.....	14
<b>10</b>	Volume indicator.....	36	<b>21</b>	Charging AC adapter connection indicator	
<b>11</b>	Enable release icon (when no memory card is inserted) .....	57, 100	<b>22</b>	Battery level indicator.....	16
<b>12</b>	Image quality.....	51	<b>23</b>	File number and type.....	115
<b>13</b>	Image size.....	51	<b>24</b>	Recorded location data indicator.....	94
			<b>25</b>	Location name information (POI information).....	41

## Tone level information display

You can check for loss of contrast detail in highlights and shadows from the histogram that is displayed, or the flashing display for each tone level. These provide guidelines when adjusting the image brightness with functions such as exposure compensation.

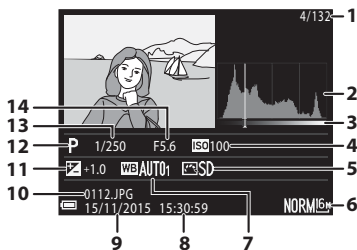

<b>1</b>	Current image number/ total number of images	<b>8</b>	Time of recording .....	14	
<b>2</b>	Histogram <sup>1</sup>	<b>9</b>	Date of recording.....	14	
<b>3</b>	Tone level <sup>2</sup>	<b>10</b>	File number and type.....	115	
<b>4</b>	ISO sensitivity.....	52	<b>11</b>	Exposure compensation value... 44	
<b>5</b>	COOLPIX Picture Control .....	51	<b>12</b>	Shooting mode .....	24
<b>6</b>	Image quality/Image size.....	51	<b>13</b>	Shutter speed.....	30
<b>7</b>	White balance .....	51	<b>14</b>	Aperture value .....	30

<sup>1</sup> A histogram is a graph showing the distribution of tones in the image. The horizontal axis corresponds to pixel brightness, with dark tones to the left and bright tones to the right. The vertical axis shows the number of pixels.

<sup>2</sup> The tone level indicates the brightness level. When the tone level to check is selected using the multi-selector ◀▶ or rotating it, the area of the image that corresponds to the selected tone level flashes.

# Preparing for Shooting

## How to Attach the Camera Strap and Lens Cap

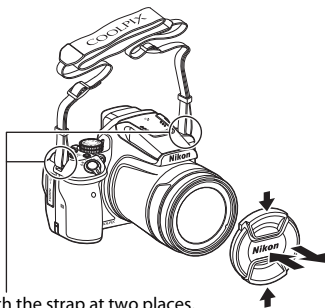
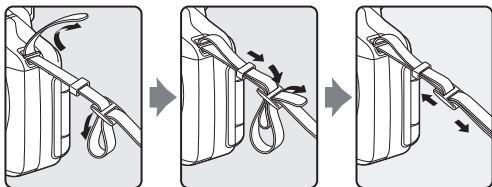

Attach the strap at two places.

### **Lens Cap**

At times when you are not shooting images, attach the lens cap to the lens to protect it.

## Insert the Battery and Memory Card

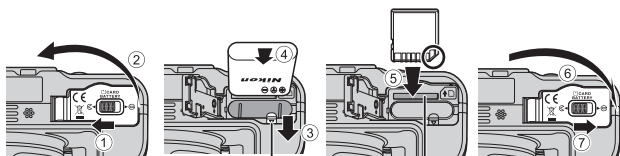

Battery latch

Memory card slot

- With the battery's positive and negative terminals oriented correctly, move the orange battery latch (③), and fully insert the battery (④).
- Slide the memory card in until it clicks into place (⑤).
- Be careful not to insert the battery or memory card upside-down or backward, as this could cause a malfunction.

### ✓ Formatting a Memory Card

The first time you insert a memory card that has been used in another device into this camera, make sure to format it with this camera. Insert the memory card into the camera, press the **MENU** button, and select **Format card** in the setup menu (📖57).

## Removing the Battery or Memory Card

Turn the camera off and make sure that the power-on lamp and monitor have turned off, and then open the battery-chamber/memory card slot cover.

- Move the battery latch to eject the battery.
- Gently push the memory card into the camera to partially eject the memory card.
- Be careful when handling the camera, battery, and memory card immediately after using the camera, as they may become hot.



# Charge the Battery

- 1 With the battery installed, connect the camera to an electrical outlet.

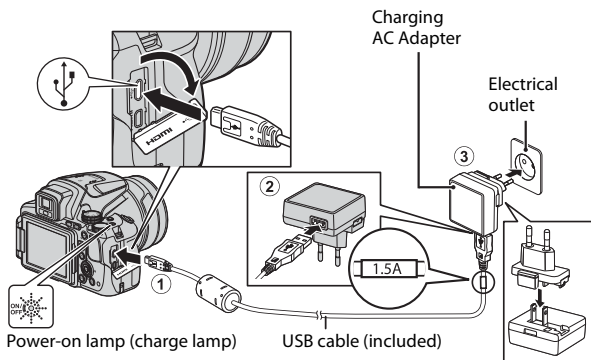

If a plug adapter\* is included with your camera, securely connect it to the Charging AC Adapter. Once the two are connected, attempting to forcibly remove the plug adapter could damage the product.

\* The shape of the plug adapter varies according to the country or region in which the camera was purchased.

This step can be omitted if the plug adapter comes permanently bonded to the charging AC adapter.

- The power-on lamp (charge lamp) slowly flashes green to indicate that the battery is charging.
- When charging is complete, the power-on lamp turns off. It takes about 3 hours and 40 minutes to charge a fully exhausted battery.
- The battery cannot be charged when the power-on lamp quickly flashes green, possibly due to one of the reasons described below.
  - The ambient temperature is not suited to charging.
  - The USB cable or Charging AC Adapter is not properly connected.
  - The battery is damaged.

- 2 Disconnect the charging AC adapter from the electrical outlet and then disconnect the USB cable.

### **Notes About the USB Cable**

- Do not use a USB cable other than the UC-E21. Using a USB cable other than the UC-E21 could result in overheating, fire or electric shock.
- Make sure that the plugs are properly oriented. Do not insert or remove the plugs at an angle when connecting or disconnecting them.

### **Notes About Charging the Battery**

Do not, under any circumstances, use another make or model of AC adapter other than Charging AC Adapter EH-71P, and do not use a commercially available USB-AC adapter or a battery charger for a mobile phone. Failure to observe this precaution could result in overheating or in damage to the camera.

### **Charging Using a Computer or Battery Charger**

- You can also charge the battery by connecting the camera to a computer.
- You can use the Battery Charger MH-67P (available separately) to charge the battery without using the camera.

## Opening and Adjusting the Angle of the Monitor

Changing the orientation of the monitor is useful when shooting with the camera in a high or a low position, or when taking selfies. For normal shooting, fold the monitor against the camera body with the screen facing out (3).

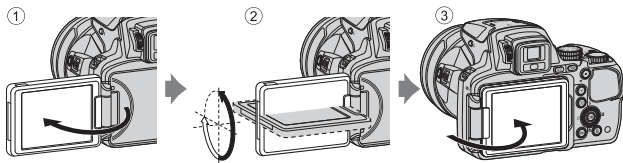

When you are not using or carrying the camera, fold the monitor against the camera body with the screen facing inward to prevent scratches or contamination.

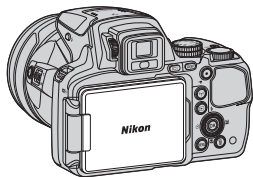

### ✓ Notes About the Monitor

When moving the monitor, do not apply excessive force and turn slowly within the monitor's adjustable range so that the connection will not be damaged.

# Turn the Camera On and Set the Display Language, Date, and Time

When the camera is turned on for the first time, the language-selection screen and the date and time setting screen for the camera clock are displayed.

## 1 Press the power switch to turn on the camera.

- The monitor turns on.
- To turn the camera off, press the power switch again.

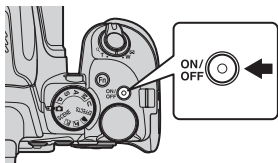

## 2 Use the multi selector ▲▼ to select the desired language and press the OK button.

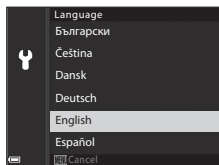

## 3 Select Yes and press the OK button.

## 4 Select your home time zone and press the OK button.

- Press ▲ to display ☀ above the map and enable daylight saving time. Press ▼ to disable it.

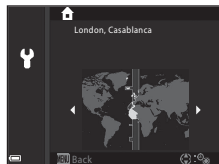

## 5 Use ▲▼ to select the date format and press the OK button.

## 6 Set the date and time, and press the **OK** button.

- Use ◀▶ to select a field and then use ▲▼ to set the date and time.
- Select the minute field and press the **OK** button to confirm the setting.

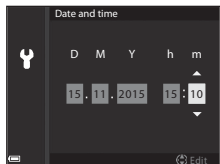

## 7 When the confirmation dialog is displayed, use ▲▼ to select **Yes** and press the **OK** button.

- When settings are finished, the lens extends.

### **Changing the Language or the Date and Time Setting**

- You can change these settings using the **Language** and **Time zone and date** settings in the **Y** setup menu (📖57).
- You can enable or disable daylight saving time in the **Y** setup menu by selecting **Time zone and date** followed by **Time zone**. Enabling day light saving time moves the clock forward one hour, and disabling it moves the clock back one hour.

### **The Clock Battery**



- The camera's clock is powered by a built-in backup battery. The backup battery charges when the main battery is inserted into the camera or when the camera is connected to an optional AC adapter, and it can run the clock for several days after about 10 hours of charging.
- If the camera's backup battery becomes exhausted, the date and time setting screen is displayed when the camera is turned on. Set the date and time again (📖14).

# Basic Shooting and Playback Operations

## Shooting with (Auto) Mode

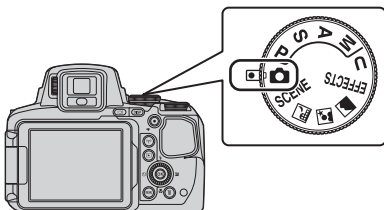
- 1 Rotate the mode dial to .



- The camera is set to  (auto) mode and general shooting can be performed.
- Press the **DISP** (display) button to switch the information displayed in the monitor during shooting and playback.
- Battery level indicator
  - : The battery level is high.
  - : The battery level is low.



Battery level indicator

Number of exposures remaining

- 2 Hold the camera steady.

- Keep fingers and other objects away from the lens, flash, AF-assist illuminator, microphone, and speaker.

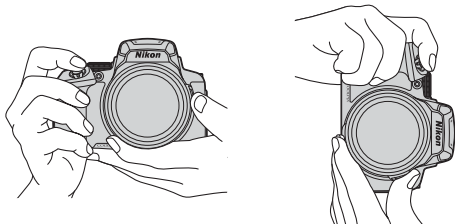

### 3 Frame the picture.

- Move the zoom control or the side zoom control to change the zoom lens position.
- When the subject is lost at the telephoto zoom position, press the  (snap-back zoom) button to temporarily widen the angle of view so that you can frame the subject more easily.

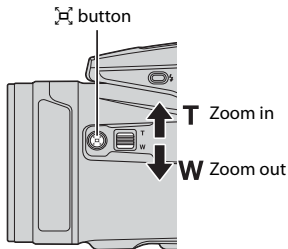
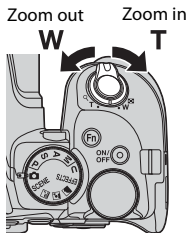

### 4 Press the shutter-release button halfway.

- When the subject is in focus, the focus area or focus indicator is displayed in green.
- When you are using digital zoom, the camera focuses in the center of the frame and the focus area is not displayed.
- If the focus area or focus indicator flashes, the camera is unable to focus. Modify the composition and try pressing the shutter-release button halfway again.

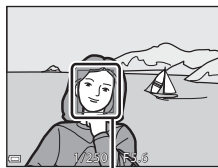
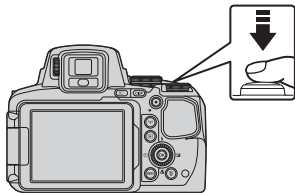

Focus area

- ### 5 Without lifting your finger, press the shutter-release button the rest of the way down.





## ✓ Notes About Saving Images or Movies

The indicator showing the number of exposures remaining or the indicator showing the remaining recording time flashes while images or movies are being saved. **Do not open the battery-chamber/memory card slot cover or remove the battery or memory card** while an indicator is flashing. Doing this could result in loss of data, or in damage to the camera or the memory card.

## 📎 The Auto Off Function

- When no operations are performed for about one minute, the monitor turns off, the camera enters standby mode, and then the power-on lamp flashes. The camera turns off after remaining in standby mode for about three minutes.
- To turn the monitor back on while the camera is in standby mode, perform an operation such as pressing the power switch or shutter-release button.

## 📎 When Using a Tripod

- We recommend using a tripod to stabilize the camera in the following situations:
  - When shooting in dim lighting with the flash mode set to  (off)
  - When the zoom is at a telephoto position
- When using a tripod to stabilize the camera during shooting, set **Vibration reduction** to **Off** in the setup menu ( 57) to prevent potential errors caused by this function.

## Using the Flash

In situations where a flash is needed, such as in dark locations or when the subject is backlit, press the  (flash pop-up) button to raise the flash.

- When not using the flash, gently push to lower the flash until it clicks shut.

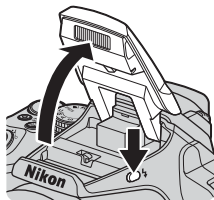



## Switching Between the Monitor and Viewfinder

You can use the viewfinder when bright light under the open sky makes it difficult to see the monitor.

- When you bring your face close to the viewfinder, the eye sensor responds to it and the viewfinder turns on while the monitor turns off (default setting).
- You can also press the  button to switch the display between the monitor and viewfinder.

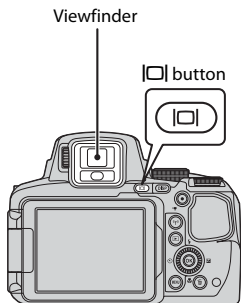

## Diopter Adjustment of the Viewfinder

When the image in the viewfinder is difficult to see, adjust by rotating the diopter adjustment control while looking through the viewfinder.

- Take care not to scratch your eye with your fingertips or nails.

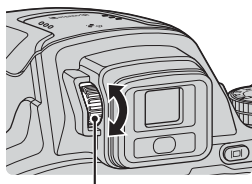

Diopter adjustment control

### Notes About Checking and Adjusting Image Colors

Use the monitor on the back of the camera because the monitor has higher color reproducibility than the viewfinder.

## Using the Zoom

When you move the zoom control, the zoom lens position changes.

- To zoom in: Move toward **T**
- To zoom out: Move toward **W**
- Rotating the zoom control all the way in either direction adjusts the zoom quickly.
- The zoom can also be operated by moving the side zoom control toward **T** or **W**.

The function of the side zoom control can be set in the **Assign side zoom control** in the setup menu (p.57).

- A zoom indicator is displayed on the shooting screen when the zoom control is moved.
- Digital zoom, which allows you to further magnify the subject up to approximately 4x the maximum optical zoom ratio, can be activated by moving and holding the zoom control toward **T** when the camera is zoomed in to the maximum optical zoom position.

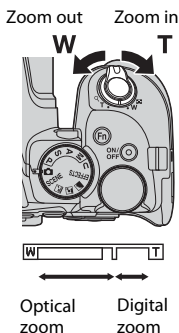





### Digital Zoom

The zoom indicator changes to blue when the digital zoom is activated, and it changes to yellow when the zoom magnification is increased further.

- Zoom indicator is blue: Image quality is not noticeably reduced by using the Dynamic Fine Zoom.
- Zoom indicator is yellow: There may be cases in which image quality is noticeably reduced.
- The indicator remains blue across a wider area when the image size is smaller.
- The zoom indicator may not change to blue when using certain continuous shooting settings or other settings.

## Using the Snap-back Zoom

When the subject is lost at the telephoto zoom position, press the  (snap-back zoom) button to temporarily widen the angle of view so that you can frame the subject more easily.

- While pressing the  button, frame the subject inside the framing border of the shooting screen. To widen the angle of view further, move the zoom control toward **W** while pressing the  button.
- Release the  button to return to the original zoom position.
- Snap-back zoom is not available during movie recording.

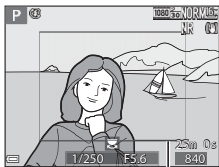
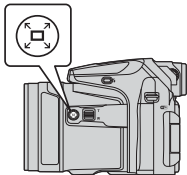

Framing border

## The Shutter-release Button

Press halfway





To set focus and exposure (shutter speed and aperture value), press the shutter-release button lightly until you feel a slight resistance. Focus and exposure remain locked while the shutter-release button is pressed halfway.

Press all the way



Press the shutter-release button all the way to release the shutter and take a picture. Do not use force when pressing the shutter-release button, as this may result in camera shake and blurred images. Press the button gently.

## Recording Movies

Display the shooting screen and press the  (movie-record) button to start recording a movie. Press the  button again to end recording.

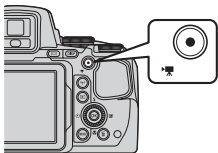



# Play Back Images

- 1** Press the  (playback) button to enter playback mode.

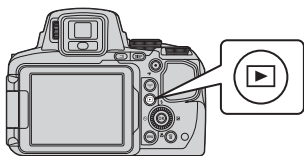
- If you press and hold down the  button while the camera is turned off, the camera turns on in playback mode.



- 2** Use the multi selector to select an image to display.

- Press and hold down  to scroll through the images quickly.
- Images can also be selected by rotating the multi selector.
- Press the **DISP** button to switch between showing and hiding the photo information or shooting information that is displayed in the monitor.
- To play back a recorded movie, press the  button.
- To return to shooting mode, press the  button or shutter-release button.

Display the previous image

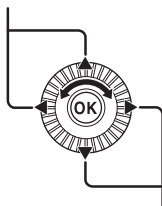

Display the next image



- Move the zoom control toward **T** () in full-frame playback mode to zoom in on an image.







- In full-frame playback mode, move the zoom control toward **W** () to switch to thumbnail playback mode and display multiple images on the screen.

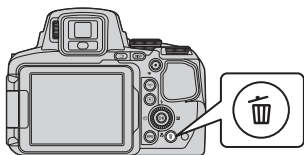

# Delete Images

- 1 Press the  (delete) button to delete the image currently displayed in the monitor.



- 2 Use the multi selector   to select the desired deletion method and press the  button.

- To exit without deleting, press the **MENU** button.
- When **Erase selected images** is selected, see "The Image Selection Screen" (p.56).

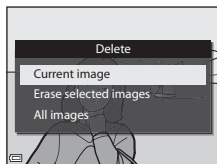

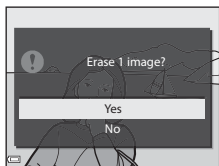

- 3 Select **Yes** and press the  button.

- Deleted images cannot be recovered.



## Deleting Images Captured Continuously (Sequence)

- Images captured continuously are saved as a sequence, and only the first image of the sequence (the key picture) is displayed in playback mode (default setting).
- If you press the  button while a key picture is displayed for a sequence of images, all images in the sequence are deleted.
- To delete individual images in a sequence, press the  button to display them one at a time and press the  button.

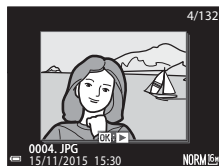

## Deleting the Image Captured While in Shooting Mode

When using shooting mode, press the  button to delete the last image that was saved.





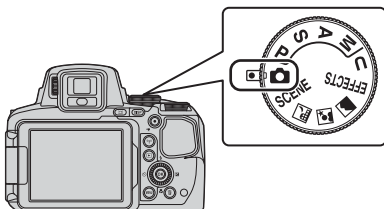

## Changing the Shooting Mode

You can change to the following shooting modes by rotating the mode dial.







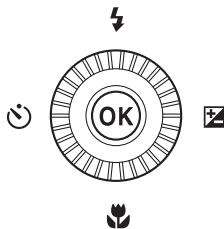

- **📷 (Auto) mode**  
Used for general shooting.
- **SCENE, 🌃, 🌃, 🏞️ (Scene) modes**  
Camera settings are optimized according to the scene that you select.
  - **SCENE:** Press the **MENU** button and select a scene. When using **Scene auto selector**, the camera automatically recognizes the shooting scene when you frame a picture, making it easier to take pictures in accordance with the scene.  
When using time-lapse movie, the camera automatically captures still images at a specified interval to create time-lapse movies that are approximately 10 seconds long.
  - 🌃 (night landscape): Use this mode to shoot night landscapes.
  - 🌃 (night portrait): Use this mode to shoot evening and night portraits that include background scenery.
  - 🏞️ (landscape): Use this mode to shoot landscapes.
- **EFFECTS (Special effects) mode**  
Effects can be applied to images during shooting. Press the **MENU** button and select an effect.
- **P, S, A, M modes**  
Select these modes for greater control over shutter speed and aperture value.
- **U (User settings) mode**  
Setting combinations that are frequently used for shooting can be saved. The saved settings can be immediately retrieved for shooting simply by rotating the mode dial to **U**.

## Functions That Can Be Set Using the Multi Selector (for Shooting)

When the shooting screen is displayed, you can press the multi selector        to set the functions described below.



-  **Flash mode**  
When the flash is raised, the flash mode can be set according to shooting conditions.
-  **Self-timer/Remote control/Smile timer**  
The self-timer can be selected from 10 seconds or 2 seconds.  
When smile timer is selected, the camera detects a smiling face and automatically releases the shutter.  
When one of the remote control options is selected, the shutter can be released with the Remote Control ML-L3 (available separately)  117).
-  **Focus mode**  
According to the distance to the subject, **AF** (autofocus),  (macro close-up) or  (infinity) can be set. When the shooting mode is **P**, **S**, **A**, **M** or **U**, **EFFECTS**, or **Sports**, **Fireworks show**, **Bird-watching** or **Time-lapse movie** (night sky, star trails) scene mode, **MF** (manual focus) can be set.
-  **Exposure compensation**  
You can adjust overall image brightness.

The functions that can be set vary depending on the shooting mode.

# Shooting Features





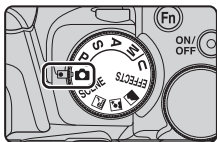

## (Auto) Mode

Used for general shooting.

- The camera detects the main subject and focuses on it (target finding AF). If a human face is detected, the camera automatically sets focus priority on it.
- See “Focusing” ( 18) for more information.



### Functions Available in (Auto) Mode

- Flash mode ( 36)
- Self-timer ( 38)
- Smile timer ( 39)
- Focus mode ( 40)
- Exposure compensation ( 44)
- Shooting menu ( 51)



## Scene Mode (Shooting Suited to Scenes)

When a scene is selected, camera settings are automatically optimized for the selected scene.

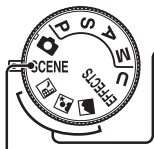

Night landscape (📷3)<sup>1,2</sup>, Night portrait (📷3), Landscape (📷4)<sup>1,2</sup>

Rotate the mode dial to 📷, 📷 or 📷 and take pictures.

### SCENE (Scene)

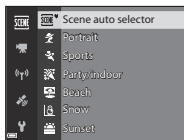
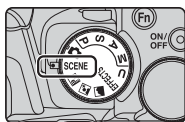

Press the **MENU** button to display the scene menu and select one of the following scenes using the multi selector.

📷 Scene auto selector (default setting) (📷4)	🏛️ Museum (📷6) <sup>1</sup>
👤 Portrait	🎆 Fireworks show (📷6) <sup>3</sup>
🏃 Sports (📷5) <sup>1</sup>	🖨️ Black and white copy (📷6) <sup>1</sup>
🎉 Party/indoor (📷5) <sup>1</sup>	📷 Backlighting (📷7) <sup>1</sup>
🏖️ Beach <sup>1</sup>	📷 Easy panorama (📷10) <sup>1</sup>
❄️ Snow <sup>1</sup>	🐕 Pet portrait (📷8)
🌅 Sunset <sup>1,2,3</sup>	🌕 Moon (📷9) <sup>1,2,3</sup>
🌆 Dusk/dawn <sup>1,2,3</sup>	🐦 Bird-watching (📷9) <sup>1</sup>
👁️ Close-up (📷5)	📷 Time-lapse movie (📷13) <sup>3,4</sup>
🍴 Food (📷6)	

<sup>1</sup> The camera focuses on the area in the center of the frame. The position of the area cannot be moved.

<sup>2</sup> The camera focuses at infinity.

<sup>3</sup> Use of a tripod is recommended. Set **Vibration reduction** to **Off** in the setup menu (📖57) when using a tripod to stabilize the camera during shooting.

<sup>4</sup> The camera automatically captures still images at a specified interval to create time-lapse movies that are approximately 10 seconds long.

## Special Effects Mode (Applying Effects When Shooting)

Effects can be applied to images during shooting.

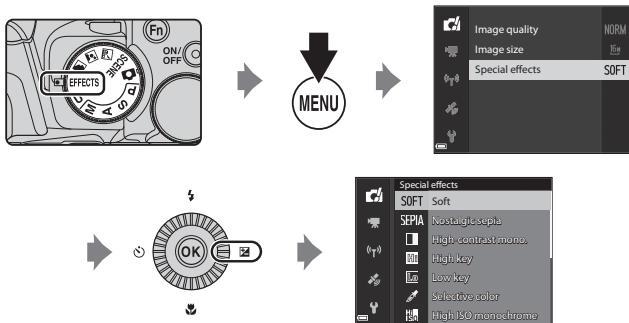

Press the **MENU** (menu) button to display the special effects menu and select an effect using the multi selector.

Type	Description
Soft* (default setting)	Softens the image by adding a slight blur to the entire image.
Nostalgic sepia*	Adds a sepia tone and reduces the contrast to simulate the qualities of an old photograph.
High-contrast mono.	Creates a black-and-white photograph with a clear contrast.
High key	Gives the entire image a bright tone.
Low key	Gives the entire image a dark tone.
Selective color	Keeps only a selected color and makes other colors black-and-white.
High ISO monochrome	Creates monotone (black-and-white) images by intentionally taking pictures with high ISO sensitivity. This setting is effective when shooting subjects in low lighting conditions. <ul style="list-style-type: none"> <li>The images captured may contain noise (randomly-spaced bright pixels, spots or lines).</li> </ul>

Type	Description
Cross process	Creates images with an unusual hue by converting a positive color image into negative or negative color image into positive.

\* Certain **Movie options** (📖54) are not available.

- The camera focuses on the area in the center of the frame. The position of the area cannot be moved.
- When **Selective color** or **Cross process** is selected, rotate the command dial to select the desired color, and press the **OK** button to apply the color. To change the color selection, press the **OK** button again.



## Functions Available in Special Effects Mode

- Flash mode (📖36)
- Self-timer (📖38)
- Focus mode (📖40)
- Exposure compensation (📖44)
- Shooting menu (📖51)

# P, S, A, M Modes (Setting the Exposure for Shooting)

Images can be shot with greater control by setting the shooting menu (📖51) items in addition to setting the shutter speed or aperture value manually according to shooting conditions and requirements.

- The focus area for autofocus differs depending on the setting of **AF area mode** (📖52).
- When set to **Target finding AF** (default setting), the camera detects the main subject and focuses on it. If a human face is detected, the camera automatically sets focus priority on it.

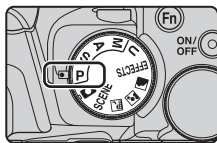

Rotate the command dial or multi selector to set the shutter speed and aperture value.

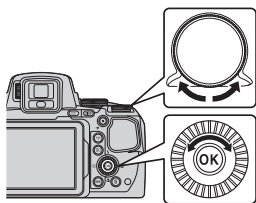

Command dial

Multi selector

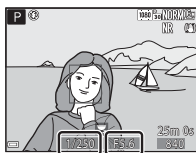

Shutter speed

Aperture value

Exposure mode	Shutter speed	Aperture value
<b>P</b> Programmed auto (📖32)	Automatically adjusted (flexible program is enabled by the command dial).	
<b>S</b> Shutter-priority auto (📖32)	Adjusted by the command dial.	Automatically adjusted.
<b>A</b> Aperture-priority auto (📖32)	Automatically adjusted.	Adjusted by the multi selector.
<b>M</b> Manual (📖32)	Adjusted by the command dial.	Adjusted by the multi selector.



## More Information

See "Toggle Av/Tv selection" (📖58) for more information.

## Exposure

The procedure for shooting images at the desired brightness (exposure) by adjusting the shutter speed or aperture value is called "determine exposure." The sense of dynamism and amount of background defocus in images to be shot vary depending on the combinations of shutter speed and aperture value even if the exposure is the same.

### Adjusting the Shutter Speed



Faster 1/1000 s



Slower 1/30 s

### Adjusting the Aperture Value



Larger aperture (Small f-number)  
f/2.8



Smaller aperture (Large f-number)  
f/8



#### The Control Range of the Shutter Speed

The control range of the shutter speed differs depending on the zoom position, aperture, or ISO sensitivity setting.



#### Aperture Value (F-number) and Zoom

Large apertures (expressed by small f-numbers) let more light into the camera, and small apertures (large f-numbers) let less light.

The aperture value of this camera also changes depending on the zoom position.

## P (Programmed auto)

Use for automatic control of the exposure by the camera.

- Different combinations of shutter speed and aperture value can be selected without changing the exposure by rotating the command dial (“flexible program”). While flexible program is in effect, a flexible program mark (**⌘**) is displayed next to the mode indicator (**P**) in the upper left of the monitor.
- To cancel flexible program, rotate the command dial until the flexible program mark (**⌘**) is no longer displayed. Changing the shooting mode, or turning off the camera, also cancels flexible program.

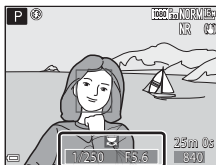

## S (Shutter-priority auto)

Use to shoot fast-moving subjects at a fast shutter speed, or use to emphasize the movements of a moving subject at a slow shutter speed.

- The shutter speed can be adjusted by rotating the command dial.

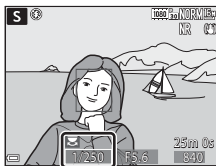

## A (Aperture-priority auto)

Use to bring subjects including both the foreground and background into focus or blur the subject's background intentionally.

- The aperture value can be adjusted by rotating the multi selector.

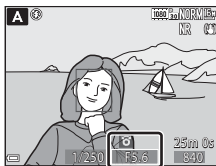

## M (Manual)

Use to control the exposure according to shooting requirements.

- When adjusting the aperture value or shutter speed, the degree of deviation from the exposure value measured by the camera is displayed in the exposure indicator of the monitor. The degree of deviation in the exposure indicator is displayed in EVs (-2 to +2 EV in increments of 1/3 EV).
- The shutter speed can be adjusted by rotating the command dial and the aperture value can be adjusted by rotating the multi selector.

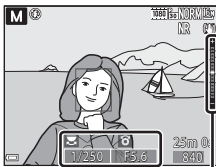

Exposure indicator

## ✓ Notes About Shooting

- When zooming is performed after the exposure is set, exposure combinations or aperture value may be changed.
- When the subject is too dark or too bright, it may not be possible to obtain the appropriate exposure. In such cases, the shutter speed indicator or aperture value indicator flashes when the shutter-release button is pressed halfway (except when the **M** mode is used). Change the shutter speed setting or aperture value.

## ✓ Notes About ISO Sensitivity

When **ISO sensitivity** (📖52) is set to **Auto** (default setting) or **Fixed range auto**, the ISO sensitivity in **M** mode is fixed at ISO 100.

## Functions Available in P, S, A, M Modes

- Flash mode (📖36)
- Self-timer (📖38)
- Smile timer (📖39)
- Focus mode (📖40)
- Exposure compensation (📖44)
- Shooting menu (📖51)
- Functions That Can Be Set Using the **Fn** (Function) Button (📖45)

## U (User Settings) Mode

Setting combinations that are frequently used for shooting (User settings) can be saved in **U**. Shooting is possible in **P** (programmed auto), **S** (shutter-priority auto), **A** (aperture-priority auto) or **M** (manual).

Rotate the mode dial to **U** to retrieve the settings saved in **Save user settings**.

- Frame the subject and shoot with these settings, or change the settings as required.
- The setting combinations that are retrieved when the mode dial is rotated to **U** can be changed as many times as you want in **Save user settings**.

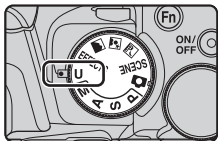

The following settings can be saved.

### General Settings

- Shooting modes **P, S, A, M** (📖30)
- Zoom position (📖20)
- Flash mode (📖36)
- Self-timer (📖38)
- Focus mode (📖40)
- Exposure compensation (📖44)
- Fn button (📖45)

### Shooting menu

- Image quality (📖51)
- Image size (📖51)
- Picture Control (📖51)
- Custom Picture Control (📖51)
- White balance (📖51)
- Metering (📖52)
- Continuous (📖52)
- ISO sensitivity (📖52)
- Exposure bracketing (📖52)
- AF area mode (📖52)
- Autofocus mode (📖52)
- Flash exp. comp. (📖52)
- Noise reduction filter (📖52)
- Active D-Lighting (📖52)
- Multiple exposure (📖52)
- Zoom memory (📖53)
- Startup zoom position (📖53)
- M exposure preview (📖53)



## Saving Settings in U Mode (Save User Settings)

The frequently used settings for shooting can be changed and saved in **U**.

**1** Rotate the mode dial to one of **P**, **S**, **A** or **M** shooting mode that you want to save in **U** mode.

- You can also rotate the mode dial to **U** to save settings (at the time of purchase, the default setting of **P** shooting mode is saved).

**2** Change to a frequently used combination of shooting settings.

- See [□34](#) for settings details.
- The flexible program (when set to **P**), shutter speed (when set to **S** or **M**), or aperture value (when set to **A** or **M**) settings will also be saved.

**3** Press the **MENU** (menu) button to display the shooting menu.



**4** Use the multi selector **▲▼** to select **Save user settings**, and press the **OK** button.

- The current settings are saved.

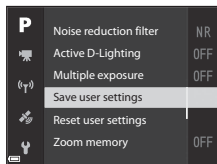

### **The Clock Battery**

If the internal clock battery ([□15](#)) is exhausted, the settings saved in **U** will be reset. Writing down any important setting is recommended.

### **Resetting U (User Settings) Mode**

If **Reset user settings** is selected in the shooting menu, the settings that are saved in the user settings are restored to their default values. The shooting mode is set to **P**.

# Flash Mode

When the flash is raised, the flash mode can be set according to shooting conditions.

## 1 Press the (flash pop-up) button to raise the flash.

- When the flash is lowered, flash operation is disabled and  is displayed.

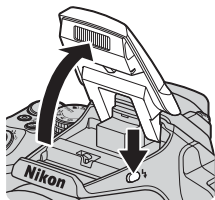

## 2 Press the multi selector (⚡).

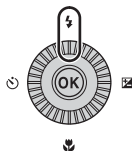

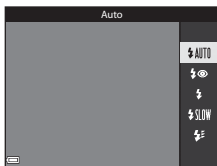

## 3 Select the desired flash mode (see 37) and press the button.

- If the setting is not applied by pressing the  button within a few seconds, the selection will be canceled.



## **The Ready Light**

While the flash is charging,  flashes. The camera cannot shoot images.

If charging is complete,  is displayed steadily when you press the shutter-release button halfway.

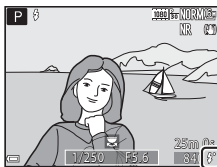

Ready light

## Available Flash Modes



### Auto

The flash fires when necessary, such as in dim lighting.

- The flash mode indicator is only displayed immediately after setting in the shooting screen.



### Auto with red-eye reduction/Red-eye reduction

Reduce red-eye in portraits caused by the flash (📖37).

- When **Red-eye reduction** is selected, the flash fires whenever a picture is taken.



### Fill flash/Standard flash

The flash fires whenever a picture is taken.



### Slow sync

Suited to evening and night portraits that include background scenery. Fill flash fires to illuminate the main subject; slow shutter speeds are used to capture background at night or under dim lighting.



### Rear-curtain sync

Fill flash fires just before the shutter closes, creating the effect of a stream of light behind moving subjects.



## The Flash Mode Setting

- The available flash modes differ depending on the shooting mode. The flash mode setting may not be available in some shooting modes.
- When the shooting mode is **P**, **S**, **A**, **M** or **U**, Auto cannot be selected.
- The setting applied in the following situations is saved in the camera's memory even after the camera is turned off.
  - When shooting mode **P**, **S**, **A** or **M** is used
  - When ⚡👁️ (auto with red-eye reduction) is selected in 📷 (auto) mode



## Auto with Red-eye Reduction/Red-eye Reduction

The red-eye reduction lamp glows before the main flash to reduce the red-eye effect. In addition, if the camera detects red-eye while saving an image, the affected area is processed to reduce red-eye before the image is saved.

Note the following when shooting:

- Because the red-eye reduction lamp glows, more time than usual is required until the shutter is released after you press the shutter-release button.
- More time than usual is required to save images.
- Red-eye reduction may not produce the desired results in some situations.
- In rare cases, red-eye reduction may be applied to areas of an image unnecessarily. In these cases, select another flash mode and take the picture again.

# Self-timer

The camera is equipped with a self-timer that releases the shutter 10 seconds or 2 seconds after you press the shutter-release button. Set **Vibration reduction** to **Off** in the setup menu (📖57) when using a tripod to stabilize the camera during shooting.

- 1 Press the multi selector ◀ (🕒).

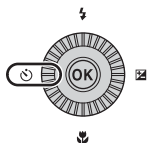

- 2 Select the desired self-timer mode, and press the **OK** button.

- 🕒 **10s** (10 seconds): Use on important occasions, such as weddings.
- 🕒 **2s** (2 seconds): Use to prevent camera shake.
- 📷 / 📷 **10s** (10 seconds) / 📷 **2s** (2 seconds): Use the Remote Control ML-L3 (available separately) to release the shutter (🔗117).
- If the setting is not applied by pressing the **OK** button within a few seconds, the selection will be canceled.
- When the shooting mode is **Pet portrait** scene mode, 📷 (pet portrait auto release) is displayed (🔗8). The self-timer cannot be used.



- 3 Frame the picture and press the shutter-release button halfway.

- Focus and exposure are set.

## 4 Press the shutter-release button the rest of the way down.

- Countdown starts. The self-timer lamp flashes and then glows steadily about one second before the shutter is released.
- When the shutter is released, the self-timer is set to **OFF**.
- To stop the countdown, press the shutter-release button again.

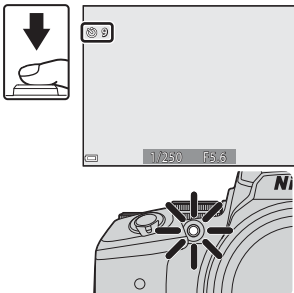

## Smile Timer (Shooting Smiling Faces Automatically)

When the camera detects a smiling face, you can take a picture automatically without pressing the shutter-release button.

- This function can be used when the shooting mode is (auto), **P**, **S**, **A**, **M** or **U**, or **Portrait** or **Night portrait** scene mode.

## 1 Press the multi selector ◀ (☺).

- Change any flash mode, exposure, or shooting menu settings before pressing ◀.

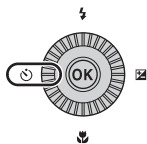

## 2 Select (smile timer), and press the button.

- If the setting is not applied by pressing the button within a few seconds, the selection will be canceled.

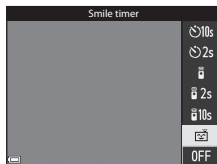

### 3 Frame the picture and wait for the subject to smile without pressing the shutter-release button.

- Point the camera at a human face.
- If the camera detects that the face framed by the double border is smiling, the shutter is automatically released.
- Whenever the camera detects a smiling face, it automatically releases the shutter.

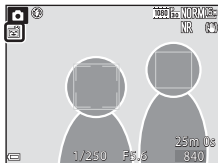

### 4 End automatic shooting.

- To end automatic shooting with smile timer, return to step 1 and select **OFF**.

#### ✓ Notes About Smile Timer

Under some shooting conditions, the camera may be unable to detect faces or detect smiles (👁️ 19). The shutter-release button can also be used for shooting.

#### 📌 When the Self-timer Lamp Flashes

When using smile timer, the self-timer lamp flashes when the camera detects a face and flashes quickly immediately after the shutter is released.

## Focus Mode

Set the focus mode according to the distance to the subject.

### 1 Press the multi selector ▼ (👉).

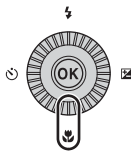

### 2 Select the desired focus mode and press the OK button.

- If the setting is not applied by pressing the OK button within a few seconds, the selection will be canceled.

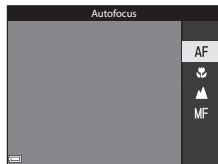

## Available Focus Modes

AF

### Autofocus



The camera automatically adjusts the focus according to the distance to the subject. Use when the distance from the subject to the lens is 50 cm (1 ft 8 in.) or more, or 5.0 m (16 ft 5 in.) or more at the maximum telephoto zoom position.

- The focus mode icon on the shooting screen is displayed only immediately after the setting is made.



### Macro close-up

Set when taking close-up pictures.

When the zoom ratio is set to a position where  and the zoom indicator is displayed in green, the camera can focus on subjects as close as approximately 10 cm (4 in.) from the lens. When the zoom is at the position where  is displayed, the camera can focus on subjects as close as approximately 1 cm (0.4 in.) from the lens.



### Infinity

Use when shooting distant scenes through window glass or when shooting landscapes.

The camera automatically adjusts the focus near infinity.

- The camera may not be able to focus on nearby objects.



### Infinity

Use when shooting the sky and the fireworks show.

MF

### Manual focus

The focus can be adjusted on any subject at a distance from approximately 1 cm (0.4 in.) to infinity ( $\infty$ ) from the lens (42). The closest distance at which the camera can focus varies depending on the zoom position.



### Notes About Shooting with the Flash

The flash may be unable to light the entire subject at distances of less than 50 cm (1 ft 8 in.).



### Focus Mode Setting

- The setting may not be available with some shooting modes (15).
- For shooting modes **P**, **S**, **A** and **M**, the setting is saved in the camera's memory even after the camera is turned off.

# Using Manual Focus

Available when the shooting mode is **P**, **S**, **A**, **M** or **U**, special effects mode, or **Sports**, **Fireworks show**, **Bird-watching** or **Time-lapse movie** (night sky, star trails) scene mode.

- 1 Press the multi selector  $\blacktriangledown$  () , select **MF** (manual focus), and then press the **OK** button.

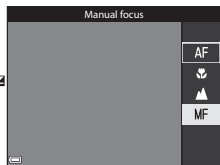
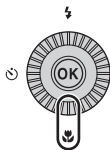

- 2 Use the multi selector to adjust the focus while checking the enlarged view.

- An enlarged view of the center area of the image is displayed. Press  $\blacktriangleleft$  to switch the view between 2x and 4x.
- Rotate the multi selector clockwise to focus on near subjects, or counterclockwise to focus on far subjects. The focus can be adjusted in higher detail by rotating the multi selector slowly or rotating the command dial.
- When  $\blacktriangleright$  is pressed, the camera focuses on the subject in the center of the frame with autofocus. The manual focus can be operated after the camera focuses with autofocus.
- Focusing is assisted by highlighting areas that are in focus in white (peaking) (43). Press  $\blacktriangle\blacktriangledown$  to adjust the peaking level.
- Press the shutter-release button halfway to confirm the composition of the picture. Press the shutter-release button all the way to take the picture.

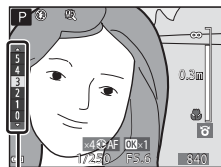

Peaking level

- 3 Press the **OK** button.

- The set focus is locked.
- Press the shutter-release button all the way to take the picture.
- To readjust the focus, press the **OK** button to display the screen in step 2.

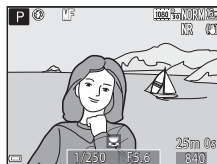



## MF (Manual Focus)

- The digits displayed for the gauge on the right of the monitor in step 2 serve as a guideline for the distance to a subject that is in focus when the gauge is near the center.
- The actual range at which the subject can be in focus varies depending on the aperture value and zoom position. To see whether the subject is in focus, check the image after shooting.
- Set **Assign side zoom control** in the setup menu (57) to **Manual focus** to focus by using the side zoom control instead of the multi selector in step 2.

## Peaking

- The range of the contrast level considered to be in focus can be changed by adjusting the peaking level. It is effective to set the level low for high contrast subjects, and high for low contrast subjects.
- Peaking highlights high contrast areas of the image in white. Depending on the shooting conditions, highlighting may not work properly or areas that are not in focus may be highlighted.
- You can disable the peaking display using **Peaking** in the setup menu (57).

# Exposure Compensation (Adjusting Brightness)

You can adjust overall image brightness.

- 1 Press the multi selector ► (⊕).

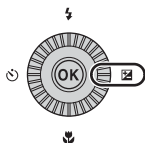

- 2 Select a compensation value and press the **OK** button.

- To brighten the image, set a positive (+) value.
- To darken the image, set a negative (-) value.
- The compensation value is applied, even without pressing the **OK** button.

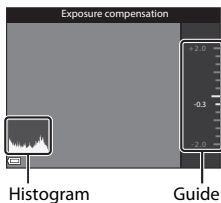

## Exposure Compensation Value

- If the setting is applied in **P**, **S** or **A** mode, it will remain saved in the camera's memory even after the camera is turned off.
- When the shooting mode is **Fireworks show** scene mode (🎆) or **M** (manual) (📖32), exposure compensation cannot be used.
- When the exposure compensation is set while using a flash, the compensation is applied to both the background exposure and to the flash output.

## Using the Histogram

A histogram is a graph showing the distribution of tones in the image. Use as a guide when using exposure compensation and shooting without the flash.

- The horizontal axis corresponds to pixel brightness, with dark tones to the left and bright tones to the right. The vertical axis shows the number of pixels.
- Increasing exposure compensation value shifts tone distribution to the right, and decreasing it shifts tone distribution to the left.

# Functions That Can Be Set with the Fn (Function) Button

The following functions can be also set by pressing the **Fn** (function) button instead of displaying the corresponding menu by pressing the **MENU** (menu) button.

- This function can be used when the shooting mode is **P**, **S**, **A**, **M** or **U**.

Image quality (📖51)	Continuous (📖52)
Image size (📖51)	ISO sensitivity (📖52)
Picture Control (📖51)	AF area mode (📖52)
White balance (📖51)	Vibration reduction (📖57)
Metering (📖52)	

## 1 Press the **Fn** (function) button when the shooting screen is displayed.

- The **Fn** **Fn button** function menu or the setting items of the function (default setting is **Continuous**) that was last assigned to the **Fn** (function) button can be selected.



## 2 Use the multi selector to select a menu item.

- To assign another function, select the **Fn** **Fn button** function menu and press the **OK** button. Then, select the desired function from the displayed menu.



## 3 After you finish assigning the function, press the **OK** button or **Fn** button.

- The camera returns to the shooting screen.

## Functions That Cannot Be Used Simultaneously When Shooting

Some functions cannot be used with other menu settings.

Restricted function	Setting	Description
Flash mode	Focus mode (p40)	When  (infinity) or  (infinity) is selected, the flash is not available.
	Continuous (p52)	The flash is not available (except for <b>Intvl timer shooting</b> ).
	Exposure bracketing (p52)	The flash is not available.
Self-timer/ Remote control/Smile timer	Focus mode (p40)	When a setting other than <b>AF</b> (autofocus) is selected, smile timer is set to <b>OFF</b> .
	AF area mode (p52)	When <b>Subject tracking</b> is selected, the self-timer/smile timer/remote control is not available.
Focus mode	Smile timer (p39)	When smile timer is selected, the focus mode is fixed at <b>AF</b> (autofocus).
	AF area mode (p52)	When <b>Subject tracking</b> is selected, <b>MF</b> (manual focus) is not available.
Image quality	Continuous (p52)	When <b>Pre-shooting cache</b> is selected, <b>Image quality</b> is fixed at <b>Normal</b> .
Image size	Continuous (p52)	<p><b>Image size</b> is set as follows depending on the continuous shooting setting:</p> <ul style="list-style-type: none"> <li>• <b>Pre-shooting cache:</b>  (image size: 1280 × 960 pixels)</li> <li>• <b>Continuous H: 120 fps:</b>  (image size: 640 × 480 pixels)</li> <li>• <b>Continuous H: 60 fps:</b>  (image size: 1920 × 1080 pixels)</li> <li>• <b>Multi-shot 16:</b>  (image size: 2560 × 1920 pixels)</li> </ul>
Picture Control	AF area mode (p52)	When <b>Subject tracking</b> is selected, <b>Monochrome</b> cannot be set.
	Active D-Lighting (p52)	When using <b>Active D-Lighting, Contrast</b> in manual adjustment cannot be adjusted.
White balance	Picture Control (p51)	When <b>Monochrome</b> is selected, <b>White balance</b> is fixed at <b>Auto (normal)</b> .
Metering	Active D-Lighting (p52)	When <b>Active D-Lighting</b> is set to any mode other than <b>Off</b> , <b>Metering</b> is reset to <b>Matrix</b> .

Restricted function	Setting	Description
Continuous/ Exposure bracketing	Continuous (📖52)/Exposure bracketing (📖52)	<b>Continuous</b> and <b>Exposure bracketing</b> are not available simultaneously.
	Self-timer (📖38)/Remote control (🔌117)	<ul style="list-style-type: none"> <li>When self-timer/remote control is used, a single image is shot even if <b>Continuous H</b>, <b>Continuous L</b>, <b>Pre-shooting cache</b>, or <b>BSS</b> has been set. If <b>Intvl timer shooting</b> is set, shooting finishes automatically after one image is shot.</li> <li><b>Exposure bracketing</b> is not available.</li> </ul>
	Smile timer (📖39)	<ul style="list-style-type: none"> <li>When the camera detects smiling faces and the shutter is released, only one image is shot. If <b>Intvl timer shooting</b> is set, shooting finishes automatically after one image is shot.</li> <li><b>Exposure bracketing</b> is not available.</li> </ul>
	Picture Control (📖51)	When <b>Monochrome</b> is selected, <b>Exposure bracketing</b> is not available.
	Multiple exposure (📖52)	Not available simultaneously.
ISO sensitivity	Continuous (📖52)	When <b>Pre-shooting cache</b> , <b>Multi-shot 16</b> , <b>Continuous H: 120 fps</b> or <b>Continuous H: 60 fps</b> is selected, <b>ISO sensitivity</b> is fixed at <b>Auto</b> .
AF area mode	Smile timer (📖39)	The camera captures images using face detection regardless of the applied <b>AF area mode</b> option.
	Focus mode (📖40)	<ul style="list-style-type: none"> <li>When a setting other than <b>Subject tracking</b> is selected and <b>▲</b> (infinity) is selected as the focus mode for shooting, the camera focuses at infinity regardless of the applied <b>AF area mode</b> option.</li> <li>When set to <b>MF</b> (manual focus), the <b>AF area mode</b> cannot be set.</li> </ul>
	Picture Control (📖51)	When <b>Monochrome</b> is selected, <b>Subject tracking</b> cannot be set.
	White balance (📖51)	When <b>Target finding AF</b> is selected, and if the white balance is set to <b>Preset manual</b> , <b>Incandescent</b> , <b>Fluorescent</b> or <b>Choose color temp.</b> , or fine adjustment of white balance is performed, the camera focuses on a face or selects one or more of the 9 focus areas containing the subject closest to the camera.









Restricted function	Setting	Description
Autofocus mode	Smile timer (📖39)	When smile timer is selected, the autofocus mode operates using the <b>Single AF</b> setting.
	Focus mode (📖40)	When the focus mode is set to ▲ (infinity), the autofocus mode operates using the <b>Single AF</b> setting.
Active D-Lighting	ISO sensitivity (📖52)	When <b>ISO sensitivity</b> is set to <b>1600, 3200,</b> or <b>6400, Active D-Lighting</b> is not available.
Multiple exposure	Continuous (📖52)	Not available simultaneously.
	Exposure bracketing (📖52)	Not available simultaneously.
Monitor settings	Smile timer (📖39)	The virtual horizon is not displayed when smile timer is selected.
	AF area mode (📖52)	<ul style="list-style-type: none"> <li>The virtual horizon is not displayed when <b>Face priority</b> is selected.</li> <li>The virtual horizon is not displayed when <b>Subject tracking</b> is selected. After the subject has been registered (during subject tracking), the histogram is not displayed.</li> <li>The virtual horizon and histogram are not displayed when <b>Target finding AF</b> is selected.</li> </ul>
Date stamp	Continuous (📖52)	When <b>Pre-shooting cache, Continuous H: 120 fps</b> or <b>Continuous H: 60 fps</b> is selected, date and time cannot be stamped on images.
Digital zoom	Smile timer (📖39)	When smile timer is selected, digital zoom is not available.
	Continuous (📖52)	When <b>Multi-shot 16</b> is selected, digital zoom is not available.
	AF area mode (📖52)	When <b>Subject tracking</b> is selected, digital zoom is not available.
	Zoom memory (📖53)	When <b>Zoom memory</b> is set to <b>On</b> , digital zoom is not available.
Shutter sound	Continuous (📖52)	When <b>Continuous H, Continuous L, Pre-shooting cache, Continuous H: 120 fps, Continuous H: 60 fps, BSS,</b> or <b>Multi-shot 16</b> is selected, shutter sound is disabled.
	Exposure bracketing (📖52)	Shutter sound is disabled.

### ✓ Notes About Digital Zoom

- Depending on the shooting mode or the current settings, digital zoom may not be available (📷105).
- When digital zoom is in effect, selectable options for AF area mode or metering mode are restricted.

# Functions That Can Be Set with the MENU (Menu) Button

You can set the menus listed below by pressing the **MENU** (menu) button.

-  **SCENE**, , ,  **EFFECTS**, **P**, **S**, **A**, **M**, **U** **Shooting menu**  
Available by pressing the **MENU** button when the shooting screen is displayed.  
Allows you to change the settings for shooting such as the combination of the image size and image quality.  
Menu icons and options that can be set differ depending on the shooting mode.
-  **Playback menu**  
Available by pressing the **MENU** button when viewing images in full-frame playback mode or thumbnail playback mode.  
Allows you to edit images, play slide shows, etc.
-  **Movie menu**  
Available by pressing the **MENU** button when the shooting screen is displayed.  
Allows you to change movie recording settings.
-  **Wi-Fi options menu**  
Allows you to configure Wi-Fi settings for connecting the camera and a smart device.
-  **Location data options menu**  
Allows you to configure settings for the location data functions.  
When **Record location data** in **Location data options** is set to **On**, the camera starts receiving signals from the positioning satellites.
-  **Setup menu**  
Allows you to adjust basic camera functions such as date and time, display language, etc.

## 1 Press the **MENU** (menu) button.

- The menu is displayed.

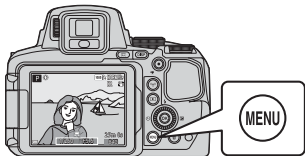

## 2 Press the multi selector



- The current menu icon is displayed in yellow.

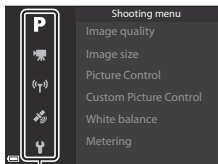

Menu icons

## 3 Select a menu icon and press the **OK** button.

- The menu options become selectable.

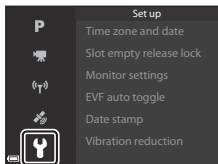

## 4 Select a menu option and press the **OK** button.

- Certain menu options cannot be set depending on the current shooting mode or the state of the camera.
- Items can also be selected by rotating the multi selector.

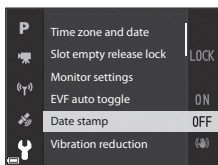

## 5 Select a setting and press the **OK** button.

- The setting you selected is applied.
- When you are finished using the menu, press the **MENU** button.
- When a menu is displayed, you can switch to shooting mode by pressing the shutter-release button or **(\*)** button.

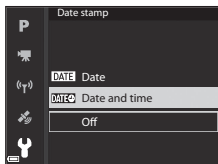



# The Shooting Menu

Enter shooting mode → MENU button

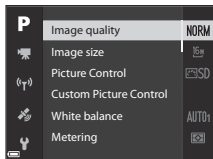

















## Common Options

Option	Description	
Image quality	Allows you to set the image quality (compression ratio) of images to be saved. <ul style="list-style-type: none"><li>• Default setting: <b>Normal</b></li></ul>	56
Image size	Allows you to set the image size of images to be saved. <ul style="list-style-type: none"><li>• Default setting:  <b>4608×3456</b></li></ul>	57

## For P, S, A, M, U modes

Option	Description	
Picture Control (COOLPIX Picture Control)	Allows you to change the settings for image recording according to the shooting scene or your preferences. <ul style="list-style-type: none"><li>• Default setting: <b>Standard</b></li></ul>	58
Custom Picture Control (COOLPIX Custom Picture Control)	Allows you to customize the settings of COOLPIX Picture Control and register them in <b>Custom 1</b> or <b>Custom 2</b> of <b>Picture Control</b> .	62
White balance	Allows you to adjust white balance to suit the weather conditions or light source in order to make the colors in images match what you see with your eyes. <ul style="list-style-type: none"><li>• Default setting: <b>Auto (normal)</b></li></ul>	63







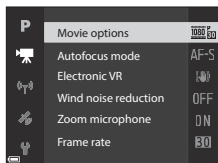

Option	Description	
Metering	Allows you to set the method that the camera uses to measure the brightness of the subject. • Default setting: <b>Matrix</b>	 66
Continuous	Allows you to select single or continuous shooting. • Default setting: <b>Single</b>	 67
ISO sensitivity	Allows you to control the camera's sensitivity to light. • Default setting: <b>Auto</b> When <b>Auto</b> is selected, <b>ISO</b> is displayed in the monitor while shooting if ISO sensitivity increases. • In <b>M</b> (manual) mode, when set to <b>Auto</b> or <b>Fixed range auto</b> , the ISO sensitivity is fixed at ISO 100.	 71
Exposure bracketing	The exposure (brightness) can be changed automatically during continuous shooting. • Default setting: <b>Off</b>	 72
AF area mode	Allows you to change the method of how the camera selects the focus area for autofocus. • Default setting: <b>Target finding AF</b>	 73
Autofocus mode	Allows you to select either <b>Single AF</b> , which focuses only when the shutter-release button is pressed halfway, or <b>Full-time AF</b> , which continues focusing even when the shutter-release button is not pressed halfway. • Default setting: <b>Full-time AF</b>	 76
Flash exp. comp.	Allows you to adjust the flash output. • Default setting: <b>0.0</b>	 76
Noise reduction filter	Allows you to set the strength of the noise reduction function that is normally performed when saving images. • Default setting: <b>Normal</b>	 77
Active D-Lighting	Allows you to prevent loss of contrast details in highlights and shadows to make the contrasts in images match what you see with your eyes. • Default setting: <b>Off</b>	 77
Multiple exposure	Allows you to combine two to three images and save them as a single image. • Default setting: - Multiple exposure mode: <b>Off</b> - Auto gain: <b>On</b>	 78
Save user settings	Allows you to save the current settings in mode dial <b>U</b> (  34).	35

Option	Description	
Reset user settings	Allows you to reset the settings saved to mode dial <b>U</b> .	35
Zoom memory	When the zoom control is moved, the zoom position (equivalent to focal length/angle of view in 35mm [135] format) is switched to the positions that have been selected by setting the check box to on in this menu option. • Default setting: <b>Off</b>	 80
Startup zoom position	Allows you to set the zoom position (equivalent to focal length/angle of view in 35mm [135] format) for when the camera is turned on. • Default setting: <b>24 mm</b>	 81
M exposure preview	Allows you to set whether or not to reflect the brightness to the shooting screen when the exposure is changed in <b>M</b> (manual) mode. • Default setting: <b>Off</b>	 81

# The Movie Menu

Enter shooting mode → MENU button →  menu icon →  button









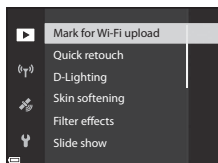







Option	Description	
Movie options	Select the movie type. Select normal speed to record movies at normal speed, or HS (high speed) to record movies that play in slow or fast motion. • Default setting:  <b>1080/30p</b> or  <b>1080/25p</b>	 82
Autofocus mode	Select either <b>Single AF</b> , which locks focus when movie recording begins, or <b>Full-time AF</b> , which continues focusing during movie recording. • Default setting: <b>Single AF</b>	 85
Electronic VR	Set whether or not to perform electronic VR when recording movies. • Default setting: <b>On</b>	 86
Wind noise reduction	Set whether or not to reduce wind noise during movie recording. • Default setting: <b>Off</b>	 86
Zoom microphone	In accordance with the angle of view, the camera records sounds over a wide area at the wide-angle zoom position, and records sounds in the limited area at the telephoto zoom position. • Default setting: <b>On</b>	 87
Frame rate	Select the frame rate used when recording movies.	 87

# The Playback Menu

Press the  button (playback mode) → MENU button



Option	Description	
Mark for Wi-Fi upload <sup>1</sup>	Allows you to select images in the camera that you want to transfer to a smart device in advance before transferring them.	 88
Quick retouch <sup>2</sup>	Allows you to create retouched copies in which contrast and saturation have been enhanced.	 27
D-Lighting <sup>2</sup>	Allows you to create copies with enhanced brightness and contrast, brightening dark portions of an image.	 27
Skin softening <sup>2</sup>	Detects faces in images and allows you to create a copy with softer facial skin tones.	 28
Filter effects <sup>2</sup>	Allows you to apply a variety of effects using digital filters.	 29
Slide show	Allows you to view images in an automated slide show.	 89
Protect <sup>1</sup>	Allows you to protect selected images and movies from accidental deletion.	 90
Rotate image <sup>1</sup>	Allows you to rotate the displayed image to portrait or landscape orientation.	 90
Small picture <sup>2</sup>	Allows you to create a reduced-size copy of images.	 30

Option	Description	
Sequence display options	Allows you to select whether to display only the key picture for a sequence of images captured continuously or to display the sequence as individual images. <ul style="list-style-type: none"> <li>When only the key picture is displayed for a sequence, press the  button to display each image in the sequence. Press the multi selector  to return to the key picture display.</li> </ul>	 91
Choose key picture <sup>1</sup>	Allows you to change the key picture for images captured in sequence.	 91

<sup>1</sup> Select an image on the image selection screen. See “The Image Selection Screen” ( 56) for more information.



<sup>2</sup> Edited images are saved as separate files. Some images may not be edited.

## The Image Selection Screen

When an image selection screen such as the one shown on the right is displayed while operating the camera, follow the procedures described below to select the images.



### 1 Use the multi selector or rotate it to select the desired image.

- Move the zoom control ( 1) toward **T** () to switch to full-frame playback, or **W** () to switch to thumbnail playback.
- Only one image can be selected for **Rotate image** and **Choose key picture**. Proceed to step 3.

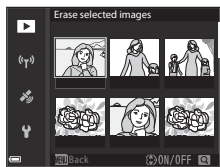

### 2 Use to select **ON** or **OFF**.

- When **ON** is selected, an icon is displayed under the selected image. Repeat steps 1 and 2 to select additional images.











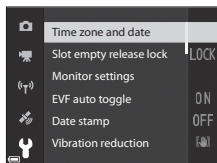



### 3 Press the button to apply the image selection.









- When a confirmation dialog is displayed, follow the on-screen instructions to operate.

## The Setup Menu

Press the MENU button →  menu icon →  button





Option	Description	
Time zone and date	Allows you to set the camera clock.	 98
Slot empty release lock	Allows you to set the operation of the shutter button when the memory card is not inserted in the camera.	 100
Monitor settings	Allows you to adjust post-shooting image review, monitor brightness, and photo information display settings.	 101
EVF auto toggle	Allows you to set whether or not to automatically switch the display to the viewfinder when you bring your face close to the viewfinder.	 103
Date stamp	Allows you to imprint the shooting date and time on images.	 103
Vibration reduction	Allows you to select the vibration reduction setting used when shooting.	 104
AF assist	Allows you to enable or disable the AF-assist illuminator.	 105
Digital zoom	Allows you to set whether or not to use digital zoom.	 105
Assign side zoom control	Allows you to select the function to be performed during shooting when the side zoom control is moved.	 106
Sound settings	Allows you to adjust sound settings.	 106
Auto off	Allows you to set the amount of time that passes before the monitor turns off to save power.	 107





Option	Description	
Format card	Allows you to format the memory card.	 107
Language	Allows you to change the camera's display language.	 107
Charge by computer	Allows you to set whether or not the battery in the camera is charged when the camera is connected to a computer.	 108
Toggle Av/Tv selection	Allows you to switch the method for setting the flexible program, shutter speed or aperture value.	 109
Reset file numbering	Allows you to reset the sequential numbering of file numbers when <b>Yes</b> is selected.	 109
Peaking	Allows you to set whether or not to highlight areas that are in focus in white on the image displayed in the monitor when operating manual focus.	 110
Reset all	Allows you to reset the camera's settings to their default values.	 110
Firmware version	View the current camera firmware version.	 110



# Using Location Data Functions

When **Record location data** in **Location data options** of the  (location data options) menu (94) is set to **On**, the camera starts receiving signals from the positioning satellites.

Location data reception can be checked on the shooting screen.

-  or : Signals are being received from four or more satellites, or from three satellites, and positioning is being performed.
- : Signals are being received, but positioning is not possible.
- : Signals are not received.

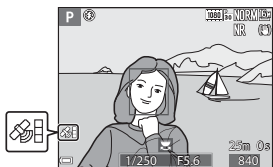

## Recording the Shooting Location Data on the Image

- When shooting while positioning is being performed, the obtained location data (latitude and longitude) are recorded on the images to be shot.
- The recorded location data can be checked on a map with ViewNX-i after transferring the image to a computer (53).

## Recording the Log

- When selecting **Start log** in **Create log** in the location data options menu, while positioning is being performed, the location data of places you visit with the camera is recorded at the certain interval.
- After the recorded log is saved to a memory card by using **Save log** in the location data options menu, view the log with software that can display log data.
- Log data is NMEA format-compliant. However, display in all NMEA format-compliant software or on all NMEA format-compliant cameras is not guaranteed.

## Displaying POI Information

- When **Embed POI** in **Points of interest (POI)** of the location data options menu is set to **On**, the nearest location name information for the current position is also recorded on the images to be shot.
- When **Display POI** of the location data options menu is set to **On**, the nearest location name information for the current position is displayed on the shooting screen, and the location name information recorded on the image is displayed on the playback screen.

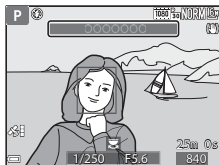

# Using the Wi-Fi (Wireless LAN) Function

You can perform the following functions if you install the dedicated software “Wireless Mobile Utility” on your smart device that runs on Android OS or iOS, and connect it to the camera.

## Take Photos

You can save images to a smart device by pressing the shutter-release button of the camera or remotely releasing the camera shutter from the smart device.

- Operations cannot be performed on the camera during remote control operation. The shooting mode is set to  (auto) mode and the focus area is set to the center of the frame, regardless of the camera’s settings.

## View Photos

Images that are saved in the camera’s memory card can be transferred and viewed on your smart device. You can also preselect the images in the camera that you want to transfer to your smart device.

### Notes About Security Settings

No security settings such as password are configured for the camera at the time of purchase. We strongly recommend performing the required security settings before using the Wi-Fi function. Use **Options** in the Wi-Fi options menu ( 49) to perform the security settings.

## Installing the Software on the Smart Device

- 1 Use your smart device to connect to the Google Play Store, App Store or other online apps marketplace and search for “Wireless Mobile Utility.”

- Check the user’s manual provided with your smart device for further details.

- 2 Check the description and other information and install the software.

### User’s Manual for Wireless Mobile Utility

Download the user’s manual from the website below.

- Android OS: <http://nikonimglib.com/ManDL/WMAU/>
- iOS: <http://nikonimglib.com/ManDL/WMAU-ios/>

To establish a connection with the camera, press the  (Wi-Fi) button on the camera, and turn on the Wi-Fi function of the smart device, and then start the “Wireless Mobile Utility” while **Negotiating... Please wait.** is displayed on the camera.

# Connecting the Camera to a TV, Printer, or Computer

You can enhance your enjoyment of images and movies by connecting the camera to a TV, printer, or computer.

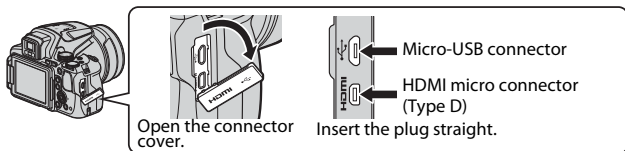

- Before connecting the camera to an external device, make sure the remaining battery level is sufficient and turn the camera off. Before disconnecting, make sure to turn the camera off.
- If the AC Adapter EH-67A (available separately) is used, this camera can be powered from an electrical outlet. Do not use any other make or model of AC adapter as it may cause the camera to heat up or malfunction.
- For information about the connection methods and subsequent operations, refer to the documentation included with the device in addition to this document.

### Viewing images on a TV



Images and movies captured with the camera can be viewed on a TV.

Connection method: Connect a commercially available HDMI cable to the TV's HDMI input jack.

### Printing images without using a computer



If you connect the camera to a PictBridge-compatible printer, you can print images without using a computer.

Connection method: Connect the camera directly to the printer's USB port with the included USB cable.

### Viewing images on a computer



You can transfer images and movies to a computer for viewing.

Connection method: Connect the camera to the computer's USB port with the USB cable.

- Before connecting to a computer, install ViewNX-i on the computer.
- If any USB devices that draw the power from the computer are connected, disconnect them from the computer before you connect the camera to it. Connecting the camera and other USB-powered devices to the same computer simultaneously may cause a camera malfunction or excessive power supply from the computer, which could damage the camera or memory card.



# Reference Section

The Reference Section provides detailed information and hints about using the camera.

## Shooting

---

Hints and Notes About the Scene Mode.....		3
Default Settings (Flash, Focus mode, Etc.).....		15
Focusing .....		18
The Control Range of the Shutter Speed (P, S, A, M Modes) .....		22

## Playback

---

Playback Zoom .....		23
Thumbnail Playback/Calendar Display.....		24
Viewing and Deleting Images Captured Continuously (Sequence) .....		25
Editing Images (Still Images) .....		26

## Movie

---

Recording and Playing Back Movies.....		32
Capturing Still Images While Recording Movies .....		35
Operations During Movie Playback.....		35
Editing Movies .....		37

## Location Data Functions

---

Recording the Location Data on the Image.....		39
Recording the Log of Movement Information.....		42







## Connection

---

Connecting to a Smart Device (Wi-Fi) .....		45
Preselecting Images in the Camera That You Want to Transfer to a Smart Device.....		47
Connecting the Camera to a TV (Playback on a TV) .....		48
Connecting the Camera to a Printer (Direct Print) .....		49
Using ViewNX-i (Transferring Images to a Computer) .....		53





## Menu

---

The Shooting Menu (The Common Shooting Options) .....	 56
The Shooting Menu ( <b>P</b> , <b>S</b> , <b>A</b> or <b>M</b> Mode) .....	 58
The Movie Menu .....	 82
The Playback Menu.....	 88
The Wi-Fi Options Menu .....	 92
The Location Data Options Menu .....	 94
The Setup Menu.....	 98





## Additional Information

---





Error Messages .....	 111
File Names.....	 115
Optional Accessories.....	 116
Shooting with Remote Control ML-L3 .....	 117
Principle Functions of the Controls .....	 119

## Hints and Notes About the Scene Mode

### Night landscape

- Press the **MENU** button to select  **Hand-held** or  **Tripod** in **Night landscape**.
-  **Hand-held** (default setting):
  - Press the shutter-release button all the way to capture a series of images which are combined into a single image and saved.
  - Once the shutter-release button is pressed all the way, hold the camera still until a still image is displayed. After taking a picture, do not turn the camera off before the monitor switches to the shooting screen.
  - The angle of view (i.e., the area visible in the frame) seen in the saved image is narrower than that seen in the monitor at the time of shooting.
-  **Tripod**:
  - One image is captured at a slow shutter speed when the shutter-release button is pressed all the way.
  - Vibration reduction is disabled regardless of the **Vibration reduction** setting in the setup menu (📖57).

### Night portrait













- Press the **MENU** button to select  **Hand-held** or  **Tripod** in **Night portrait**.
- One image is captured at a slow shutter speed. Compared to using  **Tripod**, when  **Hand-held** is selected, the camera sets a slightly faster shutter speed in accordance with the shooting conditions to prevent camera shake.
- When  **Tripod** is selected, vibration reduction is disabled regardless of the **Vibration reduction** setting in the setup menu (📖57).
- The flash always fires. Raise the flash before shooting.

## Landscape

- Press the **MENU** button to select **Noise reduction burst** or **Single shot** in **Landscape**.
- **Noise reduction burst**: This enables you to shoot a sharp landscape with a minimum of noise.
  - Press the shutter-release button all the way to capture a series of images which are combined into a single image and saved.
  - Once the shutter-release button is pressed all the way, hold the camera still until a still image is displayed. After taking a picture, do not turn the camera off before the monitor switches to the shooting screen.
  - The angle of view (i.e., the area visible in the frame) seen in the saved image is narrower than that seen in the monitor at the time of shooting.
- **Single shot** (default setting): Saves images with emphasized outlines and contrast.
  - One image is captured when the shutter-release button is pressed all the way.

## SCENE → Scene auto selector

- When you point the camera at the subject, the camera automatically recognizes the optimum scene mode from the list below and adjusts the shooting settings accordingly.

	Portrait (for taking close-up portraits of one or two people)
	Portrait (for taking portraits of large numbers of people, or images in which the background takes up a large portion of the frame)
	Landscape
	Night portrait (for taking close-up portraits of one or two people)
	Night portrait (for taking portraits of large numbers of people, or images in which the background takes up a large portion of the frame)
	Night landscape <ul style="list-style-type: none"><li>• The camera shoots images continuously and combines and saves them as a single image in the same way as when <b>Hand-held</b> in  (night landscape) (3) is selected.</li></ul>
	Close-up
	Backlighting (for taking pictures of subjects other than people)
	Backlighting (for taking portrait pictures)
	Other shooting scenes

- Depending on shooting conditions, the camera may not select the desired scene mode. In this case, select another shooting mode (24).



## SCENE → Sports





- While the shutter-release button is held all the way down, the camera shoots up to about 7 images continuously at a rate of about 7 fps (when image quality is set to **Normal** and image size is set to  **4608x3456**).
- The frame rate for continuous shooting may become slow depending on the current image quality setting, image size setting, the memory card used, or shooting condition.
- Focus, exposure, and hue are fixed at the values determined with the first image in each series.

## SCENE → Party/indoor

- To avoid the effects of camera shake, hold the camera steady. Set **Vibration reduction** to **Off** in the setup menu (57) when using a tripod to stabilize the camera during shooting.

## SCENE → Close-up

On the screen displayed when  **Close-up** is selected, select **Noise reduction burst** or **Single shot**.

- **Noise reduction burst:** This enables you to shoot a sharp image with a minimum of noise.
  - Press the shutter-release button all the way to capture a series of images which are combined into a single image and saved.
  - Once the shutter-release button is pressed all the way, hold the camera still until a still image is displayed. After taking a picture, do not turn the camera off before the monitor switches to the shooting screen.
  - If the subject moves or there is a significant camera shake during continuous shooting, the image may be distorted, overlapped, or blurred.
  - The angle of view (i.e., the area visible in the frame) seen in the saved image is narrower than that seen in the monitor at the time of shooting.
- **Single shot** (default setting): Saves images with emphasized outlines and contrast.
  - One image is captured when the shutter-release button is pressed all the way.
- The focus mode (40) setting is changed to  (macro close-up) and the camera automatically zooms to the closest position at which it can focus.
- You can move the focus area. Press the  button, use the multi selector  or rotate it to move the focus area, and press the  button to apply the setting.

## SCENE → 🍴 Food

- The focus mode (📖40) setting is changed to 🍷 (macro close-up) and the camera automatically zooms to the closest position at which it can focus.
- You can adjust hue by using the command dial. The hue setting is saved in the camera's memory even after the camera is turned off.
- You can move the focus area. Press the Ⓞ button, use the multi selector ▲▼◀▶ or rotate it to move the focus area, and press the Ⓞ button to apply the setting.



## SCENE → 🏛️ Museum

- The camera captures a series of up to 10 images while the shutter-release button is held all the way down, and the sharpest image in the series is automatically selected and saved (BSS (Best Shot Selector)).
- The flash does not fire.

## SCENE → 🎆 Fireworks show

- The shutter speed is fixed at about 4 seconds.

## SCENE → 🖼️ Black and white copy

- Use together with 🍷 (macro close-up) focus mode (📖40) when shooting subjects that are close to the camera.

## SCENE → Backlighting

- On the screen displayed when  **Backlighting** is selected, select **On** or **Off** to enable or disable the high dynamic range (HDR) function based on the type of image you want to capture.
- **Off** (default setting): The flash fires to prevent the subject from being hidden in shadow. Shoot images with the flash raised.
- **On**: Use when taking pictures with very bright and dark areas in the same frame.

### **Notes About HDR**

- Use of a tripod is recommended. Set **Vibration reduction** in the setup menu (57) to **Off** when using a tripod to stabilize the camera.
- When the shutter-release button is pressed all the way, the camera shoots images continuously and saves the following two images.
  - A non-HDR composite image
  - An HDR composite image in which the loss of details in highlights or shadows is minimized
- If there is only enough memory to save one image, an image processed by D-Lighting (55) at the time of shooting, in which dark areas of the image are corrected, is the only image saved.
- Once the shutter-release button is pressed all the way, hold the camera still until a still image is displayed. After taking a picture, do not turn the camera off before the monitor switches to the shooting screen.
- The angle of view (i.e., the area visible in the frame) seen in the saved image is narrower than that seen in the monitor at the time of shooting.
- Depending on the shooting conditions, dark shadows may appear around bright subjects and bright areas may appear around dark subjects.

## SCENE → 🐾 Pet portrait

- When you point the camera at a dog or cat, the camera detects the pet's face and focuses on it. By default, the shutter is automatically released when a dog or cat face is detected (pet portrait auto release).
- On the screen displayed when 🐾 **Pet portrait** is selected, select  **Single** or  **Continuous**.
  - **Single**: Whenever a dog or cat face is detected, the camera captures 1 image.
  - **Continuous**: Whenever a dog or cat face is detected, the camera captures 3 images continuously.

### **Pet Portrait Auto Release**

- Press the multi selector ◀ (🔊) to change the **Pet portrait auto release** setting.
  - : The camera automatically releases the shutter when it detects a dog or cat face.
  - **Off**: The camera does not release the shutter automatically, even if a dog or cat face is detected. Press the shutter-release button. The camera also detects human faces when **Off** is selected.
- **Pet portrait auto release** is set to **Off** after 5 bursts have been taken.
- Shooting is also possible by pressing the shutter-release button, regardless of the **Pet portrait auto release** setting.

### **Focus Area**

- When the camera detects a face, the face is displayed inside a yellow border. When the camera acquires focus on a face displayed inside a double border (focus area), the double border changes to green. If no faces are detected, the camera focuses on the area in the center of the frame.
- Under some shooting conditions, the pet face may not be detected and other subjects may be displayed inside a border.

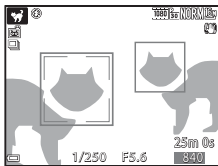

## SCENE → 🌕 Moon

- You can adjust hue by using the command dial. The hue setting is saved in the camera's memory even after the camera is turned off.
- Adjust the brightness with exposure compensation (📷44) according to shooting conditions such as the waxing and waning of the moon and shooting requirements.
- At the wide-angle zoom position, the framing border is displayed to indicate the angle of view equivalent to that of 2000 mm lens (in 35mm [135] format). The angle of view becomes equivalent to that of 2000 mm lens by pressing the **OK** button.



## SCENE → 🐦 Bird-watching

- On the screen displayed when 🐦 **Bird-watching** is selected, select **[S] Single** or **[📷] Continuous**.
- **[S] Single**: One image is shot each time the shutter-release button is pressed.
- **[📷] Continuous**: While the shutter-release button is held all the way down, images are captured continuously.
  - The frame rate for continuous shooting is about 7 fps and the maximum number of continuous shots is about 7 (when image quality is set to **Normal** and image size is set to **[📷] 4608x3456**).
- At the wide-angle zoom position, the framing border is displayed to indicate the angle of view equivalent to that of 800 mm lens (in 35mm [135] format). The angle of view becomes equivalent to that of 800 mm lens by pressing the **OK** button.

# Shooting with Easy Panorama

Rotate the mode dial to **SCENE** → **MENU** button →  Easy panorama →  button

## 1 Select **Normal (180°)** or **Wide (360°)** as the shooting range and press the button.

- When the camera is readied in the horizontal position, the image size (width × height) is as follows.
  -  **Normal (180°)**:  
4800 × 920 when moved horizontally,  
1536 × 4800 when moved vertically
  -  **Wide (360°)**:  
9600 × 920 when moved horizontally,  
1536 × 9600 when moved vertically

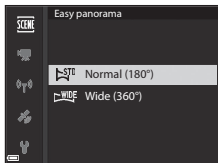



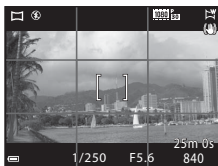

## 2 Frame the first edge of the panorama scene, and then press the shutter-release button halfway to focus.

- The zoom position is fixed at wide-angle.
- The camera focuses in the center of the frame.



## 3 Press the shutter-release button all the way, and then remove your finger from the shutter-release button.

-     are displayed to indicate the direction of camera movement.



## 4 Move the camera in one of the four directions until the guide indicator reaches the end.

- When the camera detects which direction it is moving in, shooting begins.
- Shooting ends when the camera captures the specified shooting range.
- Focus and exposure are locked until shooting ends.

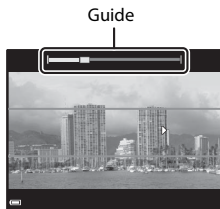

### Example of Camera Movement

- Using your body as the axis of rotation, move the camera slowly in an arc, in the direction of the marking (△▽◀▶).
- Shooting stops if the guide does not reach the edge within about 15 seconds (when **STANDARD Normal (180°)** is selected) or within about 30 seconds (when **HIDE Wide (360°)** is selected) after shooting starts.



### ✓ Notes About Easy Panorama Shooting

- The range of the image seen in the saved image is narrower than that seen in the monitor at the time of shooting.
- If the camera is moved too quickly or shaken too much, or if the subject is too uniform (e.g. walls or darkness), an error may occur.
- If shooting is stopped before the camera reaches the half-way point in the panorama range, a panorama image is not saved.
- If more than half of the panorama range is captured but shooting ends before reaching the edge of the range, the range not captured is recorded and displayed in gray.

## Playback with Easy Panorama

Switch to playback mode (📖22), display an image captured using easy panorama in full-frame playback mode, and then press the **OK** button to scroll the image in the direction that was used when shooting.

- Rotate the multi selector to scroll forward or backward quickly.

Playback controls are displayed in the monitor during playback.

Use the multi selector **◀▶** to select a control, and then press the **OK** button to perform the operations described below.



Function	Icon	Description
Rewind		Hold down the <b>OK</b> button to scroll backward quickly.*
Advance		Hold down the <b>OK</b> button to scroll forward quickly.*
Pause		Pause playback. The operations listed below can be performed while paused.
		Hold down the <b>OK</b> button to rewind.*
		Hold down the <b>OK</b> button to scroll.*
		Resume automatic scrolling.
End		Switch to full-frame playback mode.

\* These operations can also be performed by rotating the multi selector.

### ✓ Notes About Easy Panorama Images

- The images cannot be edited on this camera.
- This camera may not be able to scroll the playback of, or zoom in on, easy panorama images captured with another make or model of digital camera.

### ✓ Notes About Printing Panorama Images

The entire image may not be able to be printed depending on the printer's settings. Additionally, printing may not be possible depending on the printer.







## Shooting Time-lapse Movies

The camera can automatically capture still images at a specified interval to create time-lapse movies that are approximately 10 seconds long.

- When the **Frame rate** setting of the movie menu is set to **30 fps (30p/60p)**, 300 images are captured and saved with **1080p/30p**. When set to **25 fps (25p/50p)**, 250 images are captured and saved with **1080p/25p**.



Rotate the mode dial to **SCENE** → **MENU** button →  Time-lapse movie →  button

Type (scene/required shooting time)	Interval time	
	30 fps (30p/60p)	25 fps (25p/50p)
 Cityscape (10 minutes) <sup>1</sup> (default setting)	2 s	2.4 s
 Landscape (25 minutes) <sup>1</sup>	5 s	6 s
 Sunset (50 minutes) <sup>1</sup>	10 s	12 s
 Night sky (150 minutes) <sup>2</sup>	30 s	36 s
 Star trails (150 minutes) <sup>3</sup>	30 s	36 s

<sup>1</sup> The camera focuses on the area in the center of the frame.

<sup>2</sup> Suited for recording the movement of stars.

<sup>3</sup> Star movement appears as lines of light due to image processing.

- Use the multi selector   to select a type, and press the  button.

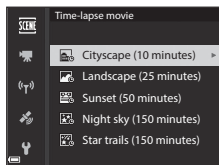

- Select whether or not to fix exposure (brightness), and press the  button. (except Night sky and Star trails)

- When **AE-L on** is selected, the exposure used for the first image is used for all images. When the brightness changes drastically like at dusk, **AE-L off** is recommended.

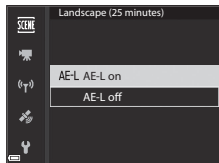

**3** Stabilize the camera by using a tool such as a tripod.

**4** Press the shutter-release button to capture the first image.

- Set exposure compensation (📖44) before releasing the shutter for the first image. Exposure compensation cannot be changed after the first image is captured. Focus and hue are fixed when the first image is captured.
- The shutter is automatically released for the second and subsequent images.
- The monitor may turn off while the camera is not capturing images.
- Shooting ends automatically when 300 or 250 images are captured.
- Press the **OK** button to end shooting before the required shooting time elapses and create a time-lapse movie.
- Sound and still images cannot be saved.





































**✓ Notes About Time-lapse Movie**

- Do not exchange the memory card until shooting is complete.
- Use a fully charged battery to prevent the camera from turning off unexpectedly.
- Time-lapse movies cannot be recorded by pressing the **▶** button.
- Do not rotate the mode dial to a different setting until shooting is complete.
- Vibration reduction is disabled regardless of the **Vibration reduction** setting in the setup menu (📖57).

## Default Settings (Flash, Focus mode, Etc.)

The default settings for each shooting mode are listed below.

	Flash mode (  36)	Self-timer (  38)	Focus mode (  40)	Exposure compensation (  44)
 (auto)	 AUTO	OFF <sup>1</sup>	AF <sup>2</sup>	0.0
<b>EFFECTS</b> (special effects)	 AUTO <sup>3</sup>	OFF	AF	0.0
<b>P, S, A, M</b>		OFF <sup>1</sup>	AF	0.0
<b>U</b> (user settings)		OFF <sup>1</sup>	AF	0.0
Scene				
 (night landscape)	 <sup>4</sup>	OFF	 <sup>4</sup>	0.0
 (night portrait)	  <sup>5</sup>	OFF <sup>1</sup>	AF <sup>4</sup>	0.0
 (landscape)	 <sup>4</sup>	OFF	 <sup>4</sup>	0.0
 (scene auto selector)	 AUTO <sup>6</sup>	OFF	AF <sup>4</sup>	0.0
 (portrait)	 	OFF <sup>1</sup>	AF <sup>4</sup>	0.0
 (sports)	 <sup>4</sup>	OFF <sup>4</sup>	AF <sup>7</sup>	0.0
 (party/indoor)	  <sup>8</sup>	OFF	AF <sup>4</sup>	0.0
 (beach)	 AUTO	OFF	AF <sup>9</sup>	0.0
 (snow)	 AUTO	OFF	AF <sup>9</sup>	0.0
 (sunset)	 <sup>4</sup>	OFF	 <sup>4</sup>	0.0
 (dusk/dawn)	 <sup>4</sup>	OFF	 <sup>4</sup>	0.0
 (close-up)	 AUTO <sup>10</sup>	OFF	 <sup>4</sup>	0.0
 (food)	 <sup>4</sup>	OFF	 <sup>4</sup>	0.0
 (museum)	 <sup>4</sup>	OFF	AF <sup>9</sup>	0.0
 (fireworks show)	 <sup>4</sup>	OFF <sup>4</sup>	 <sup>11</sup>	0.0 <sup>4</sup>
 (black and white copy)	 AUTO	OFF	AF <sup>9</sup>	0.0
 (backlighting)	  <sup>12</sup>	OFF	AF <sup>4</sup>	0.0

	Flash mode (  36)	Self-timer (  38)	Focus mode (  40)	Exposure compensation (  44)
 (easy panorama)	 <sup>4</sup>	OFF <sup>4</sup>	AF <sup>4</sup>	0.0
 (pet portrait)	 <sup>4</sup>	 <sup>13</sup>	AF <sup>9</sup>	0.0
 (moon)	 <sup>4</sup>	 2s	 <sup>4</sup>	0.0
 (bird-watching)	 <sup>4</sup>	OFF	AF <sup>14</sup>	0.0
 (time-lapse movie)	 <sup>4</sup>	OFF	AF/  <sup>15</sup>	0.0

<sup>1</sup> Smile timer can also be selected.

<sup>2</sup> MF (manual focus) cannot be selected.

<sup>3</sup> The flash is fixed at  (off) when High ISO monochrome is selected.

<sup>4</sup> Cannot be changed.

<sup>5</sup> Cannot be changed. The flash mode setting is fixed at fill flash with slow sync and red-eye reduction.

<sup>6</sup> Cannot be changed. The camera automatically selects the flash mode appropriate for the scene it has selected.



<sup>7</sup> AF (autofocus) or MF (manual focus) can be selected.

<sup>8</sup> May switch to slow sync with red-eye reduction flash mode.

<sup>9</sup> AF (autofocus) or  (macro close-up) can be selected.

<sup>10</sup> The flash is fixed at  (off) when using **Noise reduction burst**.

<sup>11</sup>  (infinity) or MF (manual focus) can be selected.

<sup>12</sup> When **HDR** is set to **Off**, the flash mode is fixed at  (fill flash). When **HDR** is set to **On**, the flash mode is fixed at  (off).

<sup>13</sup> Pet portrait auto release (8) can be set to on or off. Self-timer and remote control cannot be used.

































<sup>14</sup> Can be selected from AF (autofocus),  (infinity) or MF (manual focus).

<sup>15</sup> The focus is fixed at AF (autofocus) when using **Cityscape (10 minutes)**, or  (infinity) when using **Landscape (25 minutes)** or **Sunset (50 minutes)**.

 (infinity) or MF (manual focus) can be selected when using **Night sky (150 minutes)** or **Star trails (150 minutes)**.

## The Flash Mode Setting

The available flash modes differ depending on the shooting mode.

Flash mode		SCENE 	EFFECTS <sup>2</sup>	P	S	A	M
 <b>AUTO</b> Auto		1		-	-	-	-
 Auto with red-eye reduction				-	-	-	-
Red-eye reduction	-		-				
 Fill flash				-	-	-	-
Standard flash	-		-				
 <b>SLOW</b> Slow sync						-	
 Rear-curtain sync							

<sup>1</sup> Availability depends on the setting. See “Default Settings (Flash, Focus mode, Etc.)” (p.15) for more information.

<sup>2</sup> The flash is fixed at  (off) when High ISO monochrome is selected.

# Focusing

The focus area varies depending on the shooting mode.

## Using Target Finding AF

In  (auto) mode, or when **AF area mode** (📖52) in **P, S, A, M** or **U** mode is set to **Target finding AF**, the camera focuses in the manner described below when you press the shutter-release button halfway.

- The camera detects the main subject and focuses on it. When the subject is in focus, the focus area is displayed in green. If a human face is detected, the camera automatically sets focus priority on it.

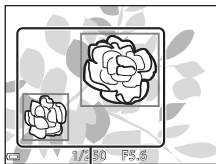

Focus areas

- If no main subject is detected, the camera automatically selects one or more of the 9 focus areas containing the subject closest to the camera. When the subject is in focus, the focus areas that are in focus are displayed in green.

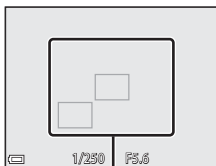



Focus areas

### ✓ Notes About Target Finding AF

- Depending on shooting conditions, the subject that the camera determines to be the main subject may vary.
- The main subject may not be detected when using certain **White balance** or **Picture Control** settings.
- The camera may not detect the main subject appropriately in the following situations:
  - When the subject is very dark or bright
  - When the main subject lacks clearly defined colors
  - When the shot is framed so that the main subject is on the edge of the monitor
  - When the main subject is composed of a repeating pattern

## Using Face Detection

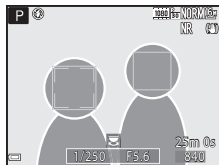

In the following settings, the camera uses face detection to automatically focus on human faces.

-  (night portrait), **Scene auto selector** or **Portrait** scene mode (📖27)
-  (smile timer) (📖39)
- When **AF area mode** (📖52) is set to **Face priority**



If the camera detects more than one face, a double border is displayed around the face that the camera focuses on, and single borders are displayed around the other faces.

If the shutter-release button is pressed halfway when no faces are detected:

- When **Scene auto selector** is selected, the focus area changes depending on the scene.
- In  (night portrait) and **Portrait**, the camera focuses on the area in the center of the frame.
- When  (smile timer) is selected, the camera focuses on the subject in the center of the frame.
- When **AF area mode** is set to **Face priority**, the camera selects the focus area containing the subject closest to the camera.

### Notes About Face Detection

- The camera's ability to detect faces depends on a variety of factors, including the direction in which the faces are looking.
- The camera cannot detect faces in the following situations:
  - When faces are partially hidden by sunglasses or otherwise obstructed
  - When faces take up too much or too little of the frame

### Viewing Images Captured Using Face Detection

During playback, the camera automatically rotates images according to the orientation of the faces that were detected at the time of shooting (except for images captured using **Continuous** (📖52) or **Exposure bracketing** (📖52)).

## Using Skin Softening

When the shutter is released while using one of the shooting modes listed below, the camera detects human faces and processes the image to soften facial skin tones (up to 3 faces).

-  (night portrait), **Scene auto selector** or **Portrait** scene mode (27)
- Skin softening can also be applied to saved images (55).

### **Notes About Skin Softening**

- It may take more time than usual to save images after shooting.
- Under some shooting conditions, the desired skin softening results may not be achieved, and skin softening may be applied to areas of the image where there are no faces.

## Subjects Not Suitable for Autofocus

The camera may not focus as expected in the following situations. In rare cases, the subject may not be in focus despite the fact that the focus area or the focus indicator is displayed in green:

- Subject is very dark
- Objects of sharply differing brightness are included in the scene (e.g. the sun behind the subject makes that subject appear very dark)
- No contrast between the subject and surroundings (e.g. a portrait subject wearing a white shirt is standing in front of a white wall)
- Several objects are at different distances from the camera (e.g. the subject is inside a cage)
- Subjects with repeating patterns (window blinds, buildings with multiple rows of similarly shaped windows, etc.)
- Subject is moving rapidly

In the situations noted above, try pressing the shutter-release button halfway to refocus several times, or focus on another subject positioned at the same distance from the camera as the actual desired subject, and use focus lock (21).

The camera can also focus using manual focus (41, 42).



## Focus Lock

Use focus lock to capture creative compositions even when the focus area is set to the center of the frame.

- 1 Position the subject in the center of the frame and press the shutter-release button halfway.

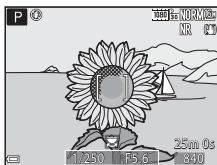

- The camera focuses on the subject and the focus area is displayed in green.
- Exposure is also locked.

- 2 Without lifting your finger, recompose the picture.

- Make sure to maintain the same distance between the camera and the subject.

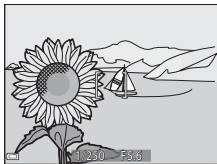

- 3 Press the shutter-release button the rest of the way down to take the picture.



### Moving the Focus Area to the Desired Position

In **P**, **S**, **A** or **M** shooting mode, the focus area can be moved using the multi-selector by setting **AF area mode** in the shooting menu (51) to one of the manual options.

## The Control Range of the Shutter Speed (P, S, A, M Modes)

The control range of the shutter speed differs depending on the zoom position, aperture, or ISO sensitivity setting. Additionally, the control range changes in the following continuous shooting settings.

Setting		Control range
ISO sensitivity (📖52) <sup>1</sup>	Auto <sup>2</sup> , Fixed range auto <sup>2</sup>	1/4000 <sup>3</sup> –1 s ( <b>P, S, A</b> modes) 1/4000 <sup>3</sup> –15 s ( <b>M</b> mode)
	ISO 100	1/4000 <sup>3</sup> –8 s ( <b>P, S, A</b> modes) 1/4000 <sup>3</sup> –15 s ( <b>M</b> mode)
	ISO 200	1/4000 <sup>3</sup> –4 s ( <b>P, S, A</b> modes) 1/4000 <sup>3</sup> –8 s ( <b>M</b> mode)
	ISO 400	1/4000 <sup>3</sup> –4 s
	ISO 800	1/4000 <sup>3</sup> –2 s
	ISO 1600	1/4000 <sup>3</sup> –1 s
	ISO 3200, 6400	1/4000 <sup>3</sup> –1/2 s
Continuous (📖52)	Continuous H, Continuous L, BSS	1/4000 <sup>3</sup> –1/30 s
	Pre-shooting cache, Continuous H: 120 fps	1/4000–1/125 s
	Continuous H: 60 fps	1/4000–1/60 s
	Multi-shot 16	1/4000–1/30 s
	Intvl timer shooting	Same as when <b>Single</b> is set

<sup>1</sup> The ISO sensitivity setting is restricted depending on the continuous shooting setting (📖46).

<sup>2</sup> In **M** mode, the ISO sensitivity is fixed at ISO 100.

<sup>3</sup> The maximum shutter speed value is 1/4000 second when the aperture value is set to f/8 at the maximum wide-angle position. The shutter speed becomes slower when the zoom position moves to the telephoto zoom position and the aperture is larger. The shutter speed is 1/2500 second when the aperture value is set to maximum f/8 at the maximum telephoto zoom position.

## Playback Zoom

Moving the zoom control toward **T** (Q playback zoom) in full-frame playback mode (📖22) zooms in on the image.

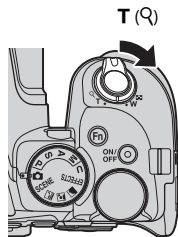

Full-frame Playback

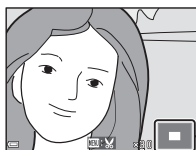

Image is zoomed in.

- You can change the magnification rate by moving the zoom control toward **W** (📐) or **T** (Q). The zoom can also be adjusted by rotating the command dial.
- To view a different area of the image, press the multi selector ▲▼◀▶.
- If you are viewing an image that was captured using face detection or pet detection, the camera zooms in on the face detected at the time of shooting (except images captured using **Continuous** or **Exposure bracketing**). To zoom in on an area of the image where there are no faces, adjust the magnification rate and then press ▲▼◀▶.
- When a zoomed image is displayed, press the **OK** button to return to full-frame playback mode.



### Cropping Images

When a zoomed image is displayed, you can press the **MENU** button to crop the image to include only the visible portion and save it as a separate file (📖31).

## Thumbnail Playback/Calendar Display

Moving the zoom control toward **W** (🗪) thumbnail playback) in full-frame playback mode (📖22) displays images as thumbnails.

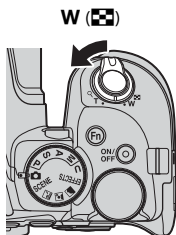

- You can change the number of thumbnails displayed by moving the zoom control toward **W** (🗪) or **T** (🔍).
- While using thumbnail playback mode, use the multi selector ▲▼◀▶ or rotate it to select an image, and then press the **OK** button to display that image in full-frame playback mode.
- While using calendar display mode, use ▲▼◀▶ or rotate it to select a date, and then press the **OK** button to display the images captured on that day.

### ✓ Notes About Calendar Display

Images captured when the camera's date is not set are treated as images captured on January 1, 2015.

# Viewing and Deleting Images Captured Continuously (Sequence)

## Viewing Images in a Sequence

Images captured continuously are saved as a sequence.

The first image of a sequence is used as the key picture to represent the sequence when displayed in full-frame playback mode or thumbnail playback mode (default setting).

To display each image in the sequence individually, press the **OK** button.

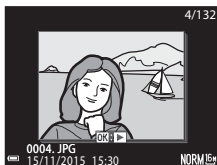

After pressing the **OK** button, the operations listed below are available.

- To display the previous or next image, rotate the multi selector or press **◀▶**.
- To display images that are not included in the sequence, press **▲** to return to the key picture display.
- To display images in a sequence as thumbnails, or to play them back in a slide show, set **Sequence display options to Individual pictures** in the playback menu (**91**).



### **✓** Sequence Display Options

Images captured continuously with cameras other than this camera cannot be displayed as a sequence.

### **🔗** Playback Menu Options Available When Using Sequence

- When images in a sequence are displayed in full-frame playback mode, press the **MENU** button to select functions in playback menu (**55**).
- If you press the **MENU** button when a key picture is displayed, the following settings can be applied to all images in the sequence:
  - Mark for Wi-Fi upload, Protect

## Deleting Images in a Sequence

When the  (delete) button is pressed for images in a sequence, the images that are deleted vary depending on how the sequences are displayed.

- When the key picture is displayed:
  - **Current image:** All images in the displayed sequence are deleted.
  - **Erase selected images:** When a key picture is selected on the erase selected images screen (56), all images in that sequence are deleted.
  - **All images:** All images on the memory card are deleted.
- When images in a sequence are displayed in full-frame playback mode:
  - **Current image:** The image currently displayed is deleted.
  - **Erase selected images:** Images that are selected in the sequence are deleted.
  - **Entire sequence:** All images in the displayed sequence are deleted.

## Editing Images (Still Images)

### Before Editing Images

You can easily edit images on this camera. Edited copies are saved as separate files.



Edited copies are saved with the same shooting date and time as the original.





#### Restrictions on Image Editing

- An image can be edited up to 10 times. A still image created by editing a movie can be edited up to 9 times.
- You may not be able to edit images of a certain size or with certain editing functions.

## Quick Retouch: Enhancing Contrast and Saturation



Press the  button (playback mode) → Select an image → MENU button  
→ Quick retouch →  button

Use the multi selector ▲▼ to select the desired effect level and press the  button.

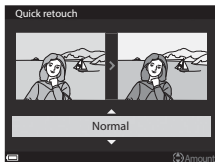
- The edited version is displayed on the right.
- To exit without saving the copy, press .



## D-Lighting: Enhancing Brightness and Contrast



Press the  button (playback mode) → Select an image → MENU button  
→ D-Lighting →  button

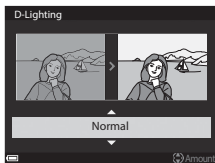

Use the multi selector ▲▼ to select the desired effect level and press the  button.

- The edited version is displayed on the right.
- To exit without saving the copy, press .





# Skin Softening: Softening Skin Tones

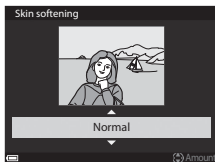

Press the  button (playback mode) → Select an image → **MENU** button → Skin softening →  button

- 1 Use the multi selector   to select the desired effect level and press the  button.

- To exit without saving the copy, press .



- 2 Preview the result and press the  button.

- The edited face is zoomed in.
- When more than one face has been edited, press   to switch the face that is displayed.
- To change the effect level, press the **MENU** button and return to step 1.
- An edited copy is created.





## **Notes About Skin Softening**

- Up to 12 faces, in order of proximity to the center of the frame, can be enhanced.
- Depending on the direction in which faces are looking, or the brightness of faces, the camera may be unable to accurately detect faces, or the skin softening function may not perform as expected.
- If no faces are detected, a warning is displayed and the screen returns to the playback menu.



## Filter Effects: Applying Digital Filter Effects

Press the  button (playback mode) → Select an image → MENU button → Filter effects →  button

Option	Description
Soft portrait	Blurs the background of human subjects. When no human subjects are detected, keeps the area in the center of the frame in focus and blurs the surrounding area.
Selective color	Keeps only a selected image color and makes other colors black-and-white.
Cross screen	Produces star-like rays of light that radiate outward from bright objects such as sunlight reflections and city lights. Suitable for night scenes.
Fisheye	Creates images that look like they were shot with a fisheye lens. Suitable for images shot in macro mode.
Miniature effect	Creates images that look like close-up photos of a diorama. Suitable for images shot while looking down from a high location, with the main subject near the center of the frame.
Painting	Creates images with the ambience of paintings.
Vignette	Lowers the peripheral light intensity from the center to the edges of an image.
Photo illustration	Emphasizes outlines and reduces the number of colors to create images with the ambience of illustrations.
Portrait (color + B&W)	Makes colors of the background of human subjects black-and-white. When no human subjects are detected, keeps colors of the area in the center of the frame and makes the surrounding area black-and-white.

**1** Use the multi selector  to select the desired filter effect and press the  button.

- When effects other than **Selective color** are selected, proceed to step 3.

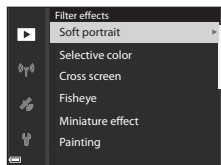

- 2 Use ▲▼ to select the color to keep and press the **OK** button.



- 3 Preview the result and press the **OK** button.

- An edited copy is created.
- To exit without saving the copy, press ◀.



## Small Picture: Reducing the Size of an Image

Press the **▶** button (playback mode) → Select an image → **MENU** button → Small picture → **OK** button

- 1 Use the multi selector ▲▼ to select the desired copy size and press the **OK** button.

- When the aspect ratio of the image is 16:9, the image is reduced to 640 x 360 in size. Press the **OK** button to proceed to step 2.

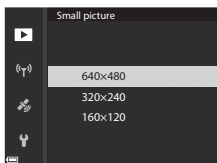

- 2 Select **Yes** and press the **OK** button.

- An edited copy is created (compression ratio of approximately 1:16).

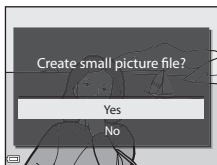

### **✓** Notes About Small Picture

When the aspect ratio of the image is 3:2 or 1:1, the image cannot be edited.

## Crop: Creating a Cropped Copy

**1** Move the zoom control to enlarge the image (👁️23).

**2** Adjust the image so that only the portion that you want to keep is displayed, and then press the **MENU** (menu) button.

- Move the zoom control toward **T** (📐) or **W** (📏) to adjust the magnification rate. Set a magnification rate at which 📏:📐 is displayed.
- Use the multi selector ▲▼◀▶ to scroll to the portion of the image that you want to display.



**3** Check the image and press the **OK** button.

- To change the portion you want to keep, return to step 2 by pressing ◀.
- To exit without saving the cropped image, press the **MENU** button.



**4** Select **Yes** and press the **OK** button.

- An edited copy is created.



### Image Size

- The aspect ratio (horizontal to vertical) of the cropped copy is the same as the original.
- When the image size of the cropped copy is 320 × 240 or smaller, the image is displayed at a smaller size during playback.

# Recording and Playing Back Movies

## 1 Display the shooting screen.

- Check the remaining amount of movie recording time.

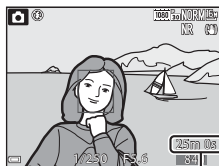

Remaining movie recording time

## 2 Press the **MOVIE** (movie-record) button to start movie recording.

- The camera focuses on the subject in the center of the frame.
- Press **OK** button to pause recording, and press **OK** button again to resume recording (except when an HS movie option is selected in **Movie options**). Recording automatically ends if it remains paused for about five minutes.

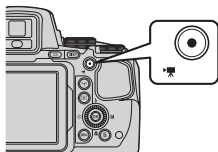

- You can capture a still image by pressing the shutter-release button while recording a movie (35).

## 3 Press the **MOVIE** (movie-record) button again to end recording.

## 4 Select a movie in full-frame playback mode and press the **OK** button to play it back.

- An image with a movie options icon is a movie.

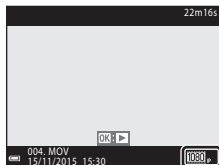

Movie options

## Area Captured in Movies

- The area that is captured in a movie varies depending on the **Movie options** or **Electronic VR** settings in the movie menu.
- Press the **DISP** button and display the movie frame (📖3) to check the range of a movie in a frame before movie recording.

## Focusing During Movie Recording

- The focus can be adjusted during movie recording in the following manner in accordance with the **Autofocus mode** (📖54) setting of the movie menu.
  - **AF-S Single AF** (default setting): The focus is locked when movie recording starts. To perform the autofocus function during movie recording, press the multi selector ◀.
  - **AF-F Full-time AF**: The focus is adjusted repeatedly even during movie recording.
- When the focus mode (📖40) is **MF** (manual focus), adjust the focus manually. The focus can be adjusted while recording movies by rotating the multi selector counterclockwise to focus on far subjects or clockwise to focus on near subjects.

## Exposure Locking

- When the multi selector ▶ is pressed during movie recording, the exposure is locked. To unlock, press ▶ again.

## Maximum Movie Recording Time

Individual movie files cannot exceed 4 GB in size or 29 minutes in length, even when there is sufficient free space on the memory card for longer recording.

- The remaining recording time for a single movie is displayed on the shooting screen.
- Recording may end before either limit is reached if camera temperature becomes elevated.
- The actual remaining recording time may vary depending on the movie content, subject movement, or type of memory card.
- Memory cards with an SD Speed Class rating of 6 or faster are recommended when recording movies (📖20). Movie recording may stop unexpectedly when a memory card with a lower Speed Class rating is used.

### ✓ Notes About Camera Temperature

- The camera may become hot when recording movies for an extended period of time or when the camera is used in a hot area.
- If the inside of the camera becomes extremely hot when recording movies, the camera will automatically stop recording. The amount of time remaining until the camera stops recording (📖10s) is displayed. After the camera stops recording, it turns itself off. Leave the camera off until the inside of the camera has cooled.

## Notes About Movie Recording

### ✓ Notes About Saving Images or Movies

The indicator showing the number of exposures remaining or the indicator showing the remaining recording time flashes while images or movies are being saved. **Do not open the battery-chamber/memory card slot cover or remove the battery or memory card** while an indicator is flashing. Doing this could result in loss of data, or in damage to the camera or the memory card.

### ✓ Notes About Recorded Movies

- The zoom indicator is not displayed during movie recording.
- There may be some degradation in image quality when digital zoom is used. If you zoom in on the subject while recording a movie, the zoom motion temporarily stops at the position where optical zoom is changed to digital zoom.
- The sounds of zoom control operation, zoom, autofocus lens drive movement, vibration reduction, and aperture operation when brightness changes may be recorded.
- The following phenomena may be seen in the monitor while recording movies. These phenomena are saved in the recorded movies.
  - Banding may occur in images under fluorescent, mercury-vapor, or sodium-vapor lighting.
  - Subjects that move quickly from one side of the frame to the other, such as a moving train or car, may appear skewed.
  - The entire movie image may be skewed when the camera is panned.
  - Lighting or other bright areas may leave residual images when the camera is moved.
- Depending on the distance to the subject or the amount of zoom applied, colored stripes may appear on subjects with repeating patterns (fabrics, lattice windows, etc.) during movie recording and playback. This occurs when the pattern in the subject and the layout of the image sensor interfere with each other; it is not a malfunction.



### ✓ Notes About Autofocus for Movie Recording

Autofocus may not perform as expected (📷20). Should this occur, focus using manual focus (📖41, 42) or try the following:

1. Set **Autofocus mode** in the movie menu to **Single AF** (default setting) before starting movie recording.
2. Frame another subject (positioned at the same distance from the camera as the intended subject) in the center of the frame, press the ● (📷) button to start recording, and modify the composition.

## Capturing Still Images While Recording Movies

If the shutter-release button is pressed all the way while recording a movie, one frame is saved as a still image. Movie recording continues while the still image is being saved.

- A still image can be captured when  is displayed in the monitor. When  is displayed, a still image cannot be captured.
- The image size of the still images to be saved is determined by the type (image size) () of the original movie.



### Notes About Capturing Still Images During Movie Recording

- Still images cannot be saved during movie recording in the following situations:
  - When movie recording is paused
  - When the remaining movie recording time is less than 5 seconds
  - When **Movie options** () is set to **480p 480/30p**, **480p 480/25p** or HS movie
- The frames of a movie that were recorded when a still image was being captured may not play back smoothly.
- The sounds of operating the shutter-release button when saving a still image may be heard in the recorded movie.
- If the camera moves when the shutter-release button is pressed, the image may be blurred.

## Operations During Movie Playback

To adjust the volume, move the zoom control while a movie is playing (📖1).

Rotate the multi selector or the command dial to advance or rewind.

Playback controls are displayed in the monitor.







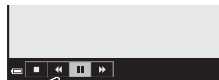

The operations described below can be performed by using the multi selector  to select a control and then pressing the **OK** button.



Volume indicator



When paused

Function	Icon	Description
Rewind		Hold down the <b>OK</b> button to rewind the movie.
Advance		Hold down the <b>OK</b> button to advance the movie.
Pause		Pause playback. The operations listed below can be performed while paused.
		 Rewind the movie one frame. Hold down the <b>OK</b> button for continuous rewinding.*
		 Advance the movie one frame. Hold down the <b>OK</b> button for continuous advancing.*
		 Resume playback.
		 Extract the desired portion of a movie and save it as a separate file.
	 Extract a single frame of a movie and save it as a still image.	
End		Return to full-frame playback mode.

\* The movie can also be advanced or rewound by one frame by rotating the multi selector or command dial.







## Editing Movies

When editing movies, use a sufficiently charged battery to prevent the camera from turning off during editing. When the battery level indicator is , movie editing is not possible.



### Extracting Only the Desired Portion of a Movie

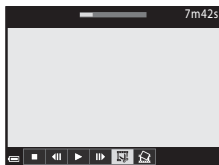

The desired portion of a recorded movie can be saved as a separate file.

**1** Play back a desired movie and pause at the start point of the portion that you want to extract (36).

**2** Use the multi selector  to select the  control, and then press the  button.







**3** Use  to select  (choose start point).

- Use  or rotate the command dial to move the start point.
- To cancel editing, select  (back), and press the  button.



**4** Use  to select  (choose end point).

- Use  or rotate the command dial to move the end point.
- To preview the specified portion, use  to select  and then press the  button. Press the  button again to stop previewing.

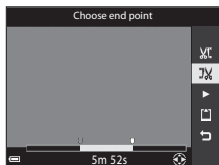

## 5 Use ▲▼ to select (save) and press the button.

- Follow the instructions on the screen to save the movie.

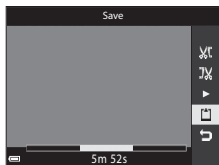





### **Notes About Movie Extracting**



- A movie that was created by editing cannot be edited again.
- The actual trimmed portion of a movie may differ slightly from the portion selected using the start and end points.
- Movies cannot be trimmed so that they are less than two seconds long.

## Saving a Frame from a Movie as a Still Image

The desired frame of a recorded movie can be extracted and saved as a still image.

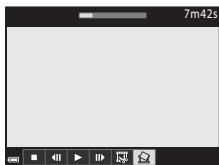

- Pause a movie and display the frame to be extracted (36).
- Use the multi selector  to select the  control and press the  button.



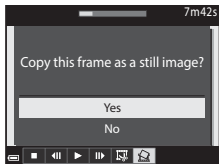

- Select **Yes** when a confirmation dialog is displayed, and press the  button to save the image.
- The still image is saved with **Normal** as the image quality. The image size is determined by the type (image size) (82) of the original movie.



### **Restrictions on Extracting Still Images**

Still images cannot be extracted from a movie recorded with  **480/30p**,  **480/30p**, or an HS movie option.

# Recording the Location Data on the Image

Press the **MENU** button →  menu icon → Location data options →  button



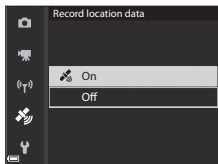

Set **Time zone and date** ()98) correctly before using the location data functions.

## 1 Set Record location data to On.

- After the settings are complete, press the **MENU** button or shutter-release button to exit the menu.
- To receive signals easily, operate in an open-air area.



## 2 Check the location data reception on the shooting screen.

-  or : Signals are being received from four or more satellites, or from three satellites, and positioning is being performed. The location data is recorded on the image.
- : Signals are being received, but positioning is not possible. If the location data was obtained within the last one minute, it is recorded on the image.
- : Signals are not received. The location data is not recorded on the image.

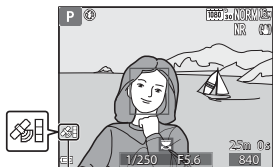

Location data reception

## 3 Shoot images while positioning is being performed.

- The location data is recorded on shot images.
- The recorded location data can be checked on a map with ViewNX-i after transferring the image to a computer ()53).

## Notes About Location Data Functions

- Before using the location data functions, read “<Important> Notes About Location Data Functions (GPS/GLONASS)” (📖xi).
- It takes a few minutes to obtain location data when positioning is performed for the first time or in a situation where positioning cannot be performed for a long period of time, or just after the battery is replaced.  
Using the latest A-GPS file can shorten the time needed for obtaining the location data (🔋94).
- Positions of the positioning satellites change constantly.  
You may not be able to determine the position or it may take some time depending on your location and the time.  
To use the location data functions, use the camera in an open-air area with few obstacles in the sky.  
Signal receiving will be smoother if the positioning antenna (📖2) is facing the sky.
- The following locations which block or reflect signals may result in failed or inaccurate positioning.
  - Inside buildings or underground locations
  - Between high-rise buildings
  - Under overpasses
  - Inside tunnels
  - Near high-voltage electrical power lines
  - Between clusters of trees
- Using a mobile phone of 1.5 GHz band near this camera may disrupt positioning.
- When carrying this camera around while positioning, do not place it in a metal bag. Positioning cannot be performed if the camera is covered with metal materials.
- When there is a significant difference in the signals from the positioning satellites, there could be a deviation of up to several hundred meters.
- Be aware of your surroundings when positioning.
- The shooting date and time that is displayed when playing back images is determined by the camera's internal clock at the time of shooting.  
The time when location data is obtained will be recorded on images, but it will not be displayed on the camera.
- The location data for the first frame will be recorded on a series of images shot using continuous shooting.

## Battery Drain While Recording Location Data and Log Recording

- When **Record location data** is set to **On**, record location data functions will continue to operate at the specified interval for approximately 6 hours even after the camera is turned off. Also, record location data functions and log recording function will continue to operate during log recording (🔋42) even after the camera is turned off.
- When **Record location data** is set to **On** or during log recording, the battery power will drain faster than usual.



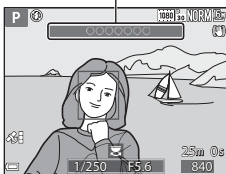

## Points of Interest (POI) Information

- POI information is location name information for landmarks (facilities) and other details.
- When **Display POI** in **Points of interest (POI)** (96) of the location data options menu is set to **On**, the nearest location name information for the current position is displayed during shooting (only when positioning is being performed).
- When **Embed POI** is set to **On**, location name information can be recorded on the image during shooting (only when positioning is being performed).
- If the location name information was recorded on the image during shooting, this information is displayed when **Display POI** is set to **On** during playback.
- The location name information may not be displayed depending on the setting level in **Level of detail** of **Points of interest (POI)**. Also, certain landmark names may not be registered, or the landmark name may be different.



Location name information  
(POI information)





## Images with Recorded Location Data

- The  icon is displayed during playback for images which have the location data recorded (7).
- Images which have the location data recorded can be checked on a map with ViewNX-i after transferring them to a computer (53).
- The actual place of shooting may differ from the location data recorded on the image files due to the accuracy of the location data obtained and a difference in the geodetic system used.
- The location data and POI information recorded on images can be erased using **Erase location data** in **Location data options** (94). The erased information cannot be recovered.

# Recording the Log of Movement Information

Press the **MENU** button →  menu icon → Create log →  button

- 1 Use the multi selector   to select **Log interval**, and press the  button.

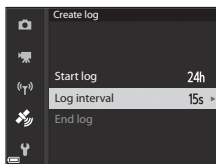

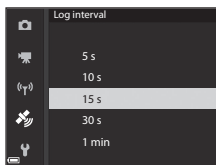

- 2 Select the intervals of log recording, and press the  button.

- The default setting is **15 s**.

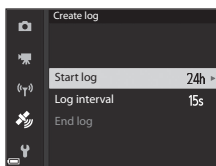

- 3 Select **Start log**, and press the  button.



- 4 Select the duration that the log will be recorded, and press the  button.

- Log recording starts. Press the **MENU** button to exit the menu.
- **LOG** is displayed on the shooting screen during log recording (105).
- When a preset time has elapsed, log recording ends automatically, and the log data is temporarily stored in the camera.  
When log recording ends, save it to a memory card (144).

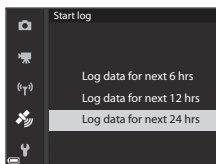



## Notes About Log Recording

- If the date and time are not set, the log cannot be recorded.
- Use a fully charged battery to prevent the camera from turning off during log recording. When the battery power becomes exhausted, log recording ends.
- Even when the camera is turned off, log recording is continuously performed until the preset time has elapsed if there is still time remaining for log recording.
- Log recording ends due to the operations below even when there is time remaining for log recording.
  - The battery is removed
  - **Record location data** in **Location data options** is set to **Off**
  - **Reset all** in the setup menu is performed
  - The setting of the internal clock (time zone or date and time) is changed
  - **End log** is selected in **Create log** of the location data options menu (6-44)
- Log recording is paused during the operations below.
  - During continuous shooting
  - During movie recording
  - When connected with a USB cable or HDMI cableLog recording is resumed when the above operations are finished.
- The log data cannot be recorded when positioning cannot be performed at all during log recording.
- After recording log data, save it to a memory card (6-44). New logs cannot be recorded if the log data remains in the camera.

# Ending Log to Save it on Memory Cards

After the obtained log is saved to a memory card by using **Save log** in the location data options menu, view the log with software that can display log data.

Press the **MENU** button →  menu icon → Create log →  button

**1** When log recording is completed, select **End log** on the screen, and press the  button.

- Ending log can also be performed before the preset time elapses.

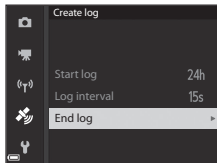

**2** Select **Save log**, and press the  button.

- The log data is saved to a memory card.
- To confirm that the log data is saved to the memory card, select **View log** of the location data options menu.
- See 115 for information about storage destination and file name of log data.

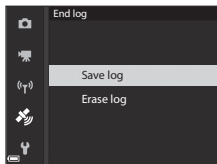

## To Erase Log Data

- To erase the log data that is temporarily stored in the camera, select **Erase log** in step 2.
- To erase the log data that is stored on the memory card, press the  button in **View log** of the location data options menu to select either function.
  - **Selected log**: The selected log data is erased.
  - **All logs**: All log data stored on the memory card is erased.

## Location Data Log

Log data is NMEA format-compliant. However, display in all NMEA format-compliant software or on all NMEA format-compliant cameras is not guaranteed.



# Connecting to a Smart Device (Wi-Fi)

- 1 Press the **(Wi-Fi)** (Wi-Fi) button on the camera.

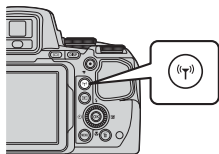

- The screen shown on the right is displayed.
- If no connection confirmation is received from the smart device within 3 minutes, the message **No access.** is displayed and the camera returns to the Wi-Fi options screen.
- You can also select **Connect to smart device** in the Wi-Fi options menu to display the screen shown on the right.

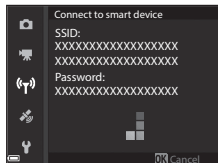

- 2 Set the Wi-Fi setting on the smart device to On.

- Check the user's manual provided with your smart device for further details.
- After the network names (SSIDs) that can be used for the smart device are displayed, select the SSID displayed on the camera.
- When the **Auth./encryp.** is set to **WPA2-PSK-AES** in the Wi-Fi options menu, the message for entering a password is displayed. Enter the password that is displayed on the camera.

- 3 Start the "Wireless Mobile Utility" installed on the smart device, while **Negotiating... Please wait.** is displayed on the camera.

- The screen for selecting "Take photos" or "View photos" is displayed.
- When the message "Cannot connect to camera." is displayed, return to step 1 and retry the procedure.
- See "Installing the Software on the Smart Device" (📖60).

## When Take photos Is Selected

You can capture still images using the two methods described below.

- Release the shutter on the camera and save the captured images to a smart device.
- Use a smart device to remotely release the camera shutter and save images to the smart device.

## ✓ Notes About Shooting

- When Wi-Fi is connected, **Intvl timer shooting** in **Continuous** cannot be used.
- Operations cannot be performed on the camera during remote control operation. The shooting mode is set to  (auto) mode and the focus area is set to the center of the frame, regardless of the camera's settings.

## 📎 Touching an NFC-compatible Smart Device to the Camera for a Wi-Fi Connection

When you use a smart device that is compatible with near field communication (NFC) functions and runs on Android OS, you can establish a Wi-Fi connection and start the “Wireless Mobile Utility” by touching the NFC antenna on the smart device to the  (N-Mark) on the camera.

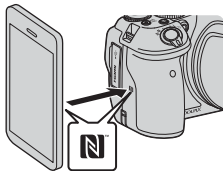

## To Terminate the Wi-Fi Connection

Perform one of the operations described below.

- Turn off the camera.
- Select **Disable Wi-Fi** in the Wi-Fi options menu of the camera (except during remote control operation).
- Set the Wi-Fi setting on the smart device to Off.

## ✓ Notes About Wi-Fi Connection

- Wi-Fi connection operations are disabled in the following situations:
  - When no memory card is inserted in the camera
  - When the camera is connected to a TV, printer, or computer
  - While recording movies
  - When the camera is connected to a smart device
- If the battery level is low, the Wi-Fi connection is terminated.
- Select **Disable Wi-Fi** in areas where the use of radio waves is prohibited.
- When Wi-Fi is connected, **Auto off** is disabled.
- When Wi-Fi is connected, the battery drains faster than normal.

## 📎 Security Settings

If no security settings (encryption and password) are configured for the camera's Wi-Fi function, unauthorized third parties may access the network and cause harm. We strongly recommend performing the required security settings before using the Wi-Fi function.

Use **Options** in the Wi-Fi options menu (92) to perform the security settings.

# Preselecting Images in the Camera That You Want to Transfer to a Smart Device

You can preselect images in the camera that you want to transfer to a smart device. Movies cannot be preselected for transfer.

## 1 Select images to transfer.

You can preselect the images to transfer to a smart device in the following menus:

- **Mark for Wi-Fi upload** in the playback menu (0088)
- **Upload from camera** in the Wi-Fi options menu (0092)

When using **Upload from camera**, the SSID and password of the camera are displayed after images are selected.

## 2 Connect the camera and smart device (0045).

- Tapping “View photos” in the “Wireless Mobile Utility” displays the confirmation screen to transfer the specified images to the smart device.

### Preselecting Images to Transfer During Playback

While the camera is in playback mode, press the (T) button or use the NFC function to establish a Wi-Fi connection, and preselect the displayed images that you want to transfer.

- You can preselect one image at a time in full-frame playback mode. You can preselect all images in the sequence when the key picture is displayed for images in a sequence.
- You can preselect the currently selected image in thumbnail playback mode. You can preselect all images in the sequence when the key picture is displayed for images in a sequence.
- You can preselect all the images captured on the selected date in calendar display playback mode.

This operation is not available when you use **Connect to smart device** in the Wi-Fi options menu to establish the Wi-Fi connection.

# Connecting the Camera to a TV (Playback on a TV)

## 1 Turn off the camera and connect it to the TV.

- Make sure that the plugs are properly oriented. Do not insert or remove the plugs at an angle when connecting or disconnecting them.

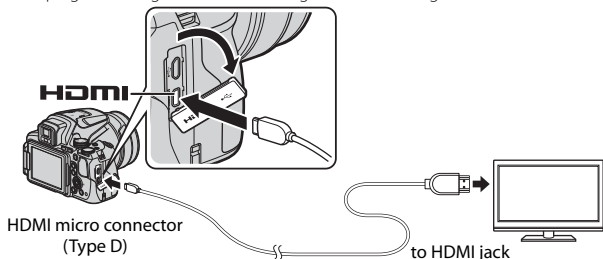

## 2 Set the TV's input to external input.

- See the documentation provided with your TV for details.

## 3 Press and hold down the (playback) button to turn on the camera.

- Images are displayed on the TV.
- The camera monitor does not turn on.



# Connecting the Camera to a Printer (Direct Print)

Users of PictBridge-compatible printers can connect the camera directly to the printer and print images without using a computer.

## Connecting the Camera to a Printer

- 1 Turn on the printer.
- 2 Turn off the camera and connect it to the printer using the USB cable.
  - Make sure that the plugs are properly oriented. Do not insert or remove the plugs at an angle when connecting or disconnecting them.

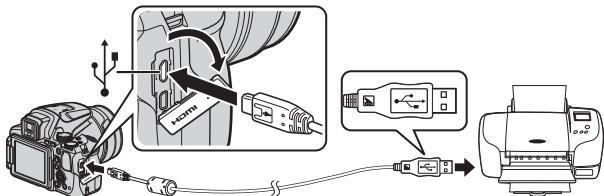

- 3 The camera is automatically turned on.
  - The **PictBridge** startup screen (①) is displayed in the camera monitor, followed by the **Print selection** screen (②).

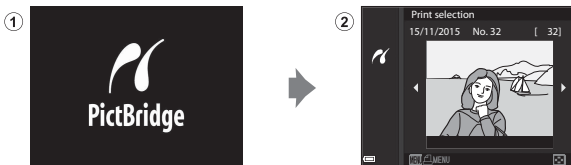

### ✓ If the PictBridge Startup Screen Is Not Displayed

When **Auto** is selected for **Charge by computer** (➡ 108), it may be impossible to print images with direct connection of the camera to some printers.

If the PictBridge startup screen is not displayed after the camera is turned on, turn the camera off and disconnect the USB cable. Set **Charge by computer** to **Off** and reconnect the camera to the printer.

## Printing Images One at a Time

- 1 Use the multi selector ◀▶ to select the desired image and press the **OK** button.

- Move the zoom control toward **W** (📐) to switch to thumbnail playback or **T** (🔍) to switch to full-frame playback.

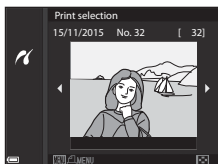

- 2 Use ▲▼ to select **Copies** and press the **OK** button.

- Use ▲▼ to set the desired number of copies (up to 9) and press the **OK** button.

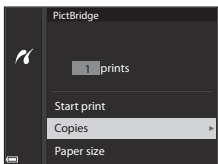

- 3 Select **Paper size** and press the **OK** button.

- Select the desired paper size and press the **OK** button.
- To print with the paper size setting configured on the printer, select **Default**.
- The paper size options available on the camera vary depending on the printer that you use.

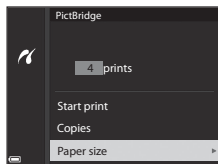

- 4 Select **Start print** and press the **OK** button.

- Printing starts.

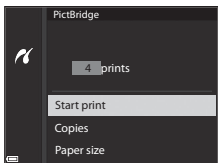

## Printing Multiple Images

- 1 When the **Print selection** screen is displayed, press the **MENU** (menu) button.

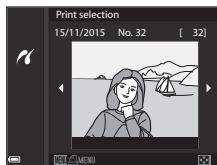

- 2 Use the multi selector ▲▼ to select **Paper size** and press the **OK** button.
  - Select the desired paper size and press the **OK** button.
  - To print with the paper size setting configured on the printer, select **Default**.
  - The paper size options available on the camera vary depending on the printer that you use.
  - To exit the print menu, press the **MENU** button.

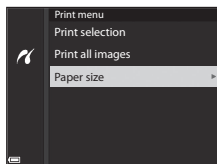

- 3 Select **Print selection** or **Print all images** and press the **OK** button.

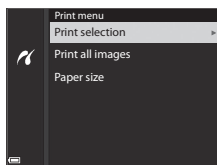

## Print selection

Select images (up to 99) and the number of copies (up to 9) of each.

- Use the multi selector ◀▶ to select images, and use ▲▼ to specify the number of copies to be printed.
- Images selected for printing are indicated by 🖨️ and the number of copies to be printed. To cancel the print selection, set the number of copies to 0.
- Move the zoom control toward **T** (🔍) to switch to full-frame playback or **W** (📐) to switch to thumbnail playback.
- Press the **OK** button when setting is complete. When the screen for confirming the number of print copies is displayed, select **Start print** and press the **OK** button to start printing.



## Print all images

One copy each of all images saved on the memory card is printed.

- When the screen for confirming the number of print copies is displayed, select **Start print** and press the **OK** button to start printing.



# Using ViewNX-i (Transferring Images to a Computer)

## Installing ViewNX-i

ViewNX-i is free software that enables you to transfer images and movies to your computer for viewing.

To install ViewNX-i, download the latest version of the ViewNX-i installer from the following website and follow the onscreen instructions to complete installation.

ViewNX-i: <http://nikonimglib.com/nvnx-i/>

For system requirements and other information, see the Nikon website for your region.

## Transferring Images to a Computer

### 1 Prepare a memory card that contains images.

You can use any of the methods below to transfer images from the memory card to a computer.

- **SD memory card slot/card reader:** Insert the memory card into the card slot of your computer or the card reader (commercially available) that is connected to the computer.
- **Direct USB connection:** Turn the camera off and ensure that the memory card is inserted in the camera. Connect the camera to the computer using the USB cable.

The camera automatically turns on.

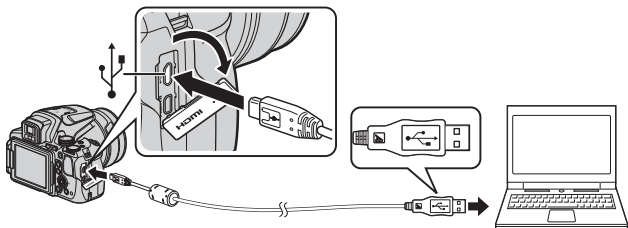

If a message is displayed prompting you to choose a program, select Nikon Transfer 2.

- **When using Windows 7**

If the dialog shown at right is displayed, follow the steps below to select Nikon Transfer 2.

- 1 Under **Import pictures and videos**, click **Change program**. A program selection dialog will be displayed; select **Import File using Nikon Transfer 2** and click **OK**.
- 2 Double-click **Import File**.



- **When using Windows 8.1**

If the dialog shown at right is displayed, click the dialog and then click **Import File/ Nikon Transfer 2**.

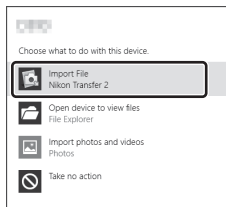

If the memory card contains a large number of images, it may take a while for Nikon Transfer 2 to start. Wait until Nikon Transfer 2 starts.

### **Notes About Connecting the USB Cable**

Operation is not guaranteed if the camera is connected to the computer via a USB hub.

## 2 After Nikon Transfer 2 starts, click **Start Transfer**.



- Image transfer begins. When image transfer is complete, ViewNX-i starts and the transferred images are displayed.
- Consult online help for more information on using ViewNX-i.

## 3 Terminate the connection.

- If you are using a card reader or card slot, choose the appropriate option in the computer operating system to eject the removable disk corresponding to the memory card and then remove the memory card from the card reader or card slot.
- If the camera is connected to the computer, turn the camera off and disconnect the USB cable.

# The Shooting Menu (The Common Shooting Options)

- See “**U** (User Settings) Mode” (📖34) for information about **Save user settings** and **Reset user settings**.

## Image Quality

Enter shooting mode\* → MENU button → shooting mode menu icon → Image quality → OK button

- \* The image quality can be set in any shooting mode. The setting is also applied to other shooting modes (except shooting mode **U** and **Easy panorama** scene mode).

Set the image quality (compression ratio) used when saving images. Lower compression ratios result in higher quality images, but the number of images that can be saved is reduced.

Option		Description
<b>FINE</b>	Fine	Finer image quality than <b>Normal</b> . Compression ratio of about 1:4
<b>NORM</b>	Normal (default setting)	Normal image quality, suitable for most applications. Compression ratio of about 1:8

### ✓ Notes About Image Quality

This function may not be available to use in combination with other functions (📖46).

### 📎 Number of Images That Can Be Saved

- The approximate number of images that can be saved can be checked in the monitor when shooting (📖16).
- Note that due to JPEG compression, the number of images that can be saved may vary greatly depending on the image content, even when using memory cards with the same capacity and the same image quality and image size settings. In addition, the number of images that can be saved may vary depending on the make of the memory card.
- If the number of exposures remaining is 10,000 or more, the number of exposures remaining display shows “9999.”



# Image Size

Enter shooting mode\* → MENU button → shooting mode menu icon → Image size →  button

\* The image size can be set in any shooting mode. The setting is also applied to other shooting modes (except shooting mode **U** and **Easy panorama** scene mode).

Set the image size (number of pixels) used when saving images.

The larger the image size, the larger the size at which it can be printed, but the number of images that can be saved is reduced.

Option*	Aspect ratio (horizontal to vertical)
 4608×3456 (default setting)	4:3
 3264×2448	4:3
 2272×1704	4:3
 1600×1200	4:3
 640×480	4:3
 4608×2592	16:9
 1920×1080	16:9
 4608×3072	3:2
 3456×3456	1:1

\* The numerical values indicate the number of pixels that are captured.  
Example:  **4608×3456** = approx. 16 megapixels, 4608 × 3456 pixels

## Notes About Printing Images at 1:1 Aspect Ratio

Change the printer setting to “Border” when printing images at a 1:1 aspect ratio. Some printers may not be able to print images at a 1:1 aspect ratio.

## Notes About Image Size







This function may not be available to use in combination with other functions (46).

# The Shooting Menu (P, S, A or M Mode)

## Picture Control (COOLPIX Picture Control)

Rotate the mode dial to **P, S, A, M** or **U** → MENU button → **P, S, A, M** or **U** menu icon → Picture Control →  button

Change the settings for image recording according to the shooting scene or your preferences. Sharpness, contrast and saturation can be adjusted in detail.

Option	Description
 <b>Standard</b> (default setting)	Standard processing for balanced results. Recommended for most situations.
 <b>Neutral</b>	Minimal processing for natural results. Select for images that will later be processed or retouched.
 <b>Vivid</b>	Images are enhanced for a vivid, photoprint effect. Select for images that emphasize primary colors, such as blue, red, and green.
 <b>Monochrome</b>	Shoots monochrome photographs such as in black-and-white or sepia.
 <b>Custom 1*</b>	Changes to the setting of <b>Custom 1</b> in COOLPIX Custom Picture Control.
 <b>Custom 2*</b>	Changes to the setting of <b>Custom 2</b> in COOLPIX Custom Picture Control.

\* Only displayed when the setting customized in **Custom Picture Control** (62) has been registered.

### **COOLPIX Picture Control**

- The COOLPIX Picture Control function of this camera cannot be used with other makes of cameras, Picture Control function of software such as Capture NX-D, Picture Control Utility 2, etc.
- This function may not be available to use in combination with other functions (46).

## Customizing Existing COOLPIX Picture Controls: Quick Adjust and Manual Adjust

COOLPIX Picture Control can be customized using Quick adjust, which allows for balanced adjustment of sharpness, contrast, saturation and other image editing components, or manual adjust, which allows for detailed adjustment of the components individually.

- 1 Use the multi selector ▲▼ to select the desired type of COOLPIX Picture Control and press the **OK** button.

- Items can also be selected by rotating the multi selector.

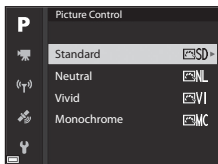

- 2 Use ▲▼ to highlight the desired option (0-60) and use ◀▶ to select a value.

- Press the **OK** button to set the value.
- To change the adjusted values to the default setting, select **Reset** and press the **OK** button.

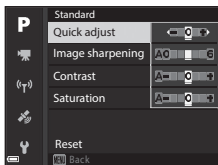

## Types of Quick Adjust and Manual Adjust

Option	Description
Quick adjust <sup>1</sup>	<p>Adjusts the sharpness, contrast and saturation levels automatically.</p> <p>Setting to the – side reduces the effect of the selected COOLPIX Picture Control, and setting to the + side emphasizes its effect.</p> <ul style="list-style-type: none"><li>• Default setting: <b>0</b></li></ul>
Image sharpening	<p>Controls how much outlines are sharpened during shooting. The higher the number, the sharper the image, and the lower the number, the softer the image.</p> <p>Select <b>A</b> (auto) for automatic adjustment.</p> <ul style="list-style-type: none"><li>• Default setting: <b>3</b> for <b>Standard</b> or <b>Monochrome</b>, <b>2</b> for <b>Neutral</b> and <b>4</b> for <b>Vivid</b></li></ul>
Contrast	<p>Controls the contrast.</p> <p>Setting to the – side gives the image a softer appearance, and setting to the + side gives it a harder appearance. Select lower values to prevent highlights in portrait subjects from being “washed out” in direct sunlight, higher values to preserve detail in misty landscapes and other low contrast subjects.</p> <p>Select <b>A</b> (auto) for automatic adjustment.</p> <ul style="list-style-type: none"><li>• Default setting: <b>0</b></li></ul>
Saturation <sup>2</sup>	<p>Controls the vividness of colors.</p> <p>Setting to the – side reduces the vividness, and setting to the + side increases the vividness.</p> <p>Select <b>A</b> (auto) for automatic adjustment.</p> <ul style="list-style-type: none"><li>• Default setting: <b>0</b></li></ul>
Filter effects <sup>3</sup>	<p>Simulates the effect of color filters on monochrome photographs.</p> <ul style="list-style-type: none"><li>• <b>OFF</b>: Filter effects are not used.</li><li>• <b>Y</b> (yellow), <b>O</b> (orange), <b>R</b> (red): Enhance contrast. Can be used to tone down the brightness of the sky in landscape photographs. The contrast is strengthened in the order <b>Y</b> → <b>O</b> → <b>R</b>.</li><li>• <b>G</b> (green): Softens skin tones. Suitable for portraits.</li><li>• Default setting: <b>OFF</b></li></ul>



Option	Description
Toning <sup>3</sup>	Controls the tint used in monochrome photographs from <b>B&amp;W</b> (black-and-white), <b>Sepia</b> , and <b>Cyanotype</b> (blue-tinted monochrome). Pressing the multi selector ▼ when <b>Sepia</b> or <b>Cyanotype</b> is selected enables you to select a saturation level. Press ◀▶ to adjust the saturation. <ul style="list-style-type: none"> <li>• Default setting: <b>B&amp;W</b> (black-and-white)</li> </ul>

<sup>1</sup> Quick adjust is not available in **Neutral**, **Monochrome**, **Custom 1** and **Custom 2**.  
 The values set manually are disabled if quick adjust is used after manual setting.

<sup>2</sup> Not displayed for **Monochrome**.

<sup>3</sup> Only displayed for **Monochrome**.

### **Notes About Image Sharpening**

The effects of **Image sharpening** cannot be previewed in the monitor during shooting. Check the results in playback mode.

### **Contrast, Saturation and A (Auto)**

Results for contrast and saturation vary with the exposure, and the position and size of the subject in the frame.

## Custom Picture Control (COOLPIX Custom Picture Control)

Rotate the mode dial to **P, S, A, M** or **U** → MENU button → **P, S, A, M** or **U** menu icon → Custom Picture Control → **OK** button

Customize the settings of COOLPIX Picture Control (62) and register them in **Custom 1** or **Custom 2** of **Picture Control**.

- 1 Use the multi selector ▲▼ to select **Edit and save**, and press the **OK** button.

- Select **Delete** to delete a registered COOLPIX Custom Picture Control.

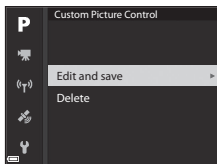

- 2 Select the original COOLPIX Picture Control (62) to be edited, and press the **OK** button.

- 3 Use ▲▼ to highlight the desired option and use ◀▶ to select a value (62).

- The options are the same as those for adjusting the COOLPIX Picture Control.
- Press the **OK** button when you finish adjustment.
- To change the adjusted values to the default setting, select **Reset** and press the **OK** button.

- 4 Select the registration destination and press the **OK** button.



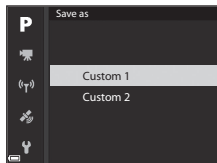





- **Custom 1** or **Custom 2** becomes selectable in **Picture Control** or **Custom Picture Control**.
- To change the adjusted values, select **Custom 1** or **Custom 2** in **Picture Control** or **Custom Picture Control**.



## White Balance (Adjusting Hue)



Rotate the mode dial to **P, S, A, M** or **U** → MENU button → **P, S, A, M** or **U** menu icon → White balance →  button

Adjust white balance to suit the light source or weather conditions in order to make the colors in images match what you see with your eyes.

Option	Description
<b>AUTO1</b> Auto (normal) (default setting)	White balance is automatically adjusted. When set to <b>Auto (warm lighting)</b> , the images are preserved with warm colors if they are shot under an incandescent light source. When using the flash, white balance is adjusted according to the flash lighting condition.
<b>AUTO2</b> Auto (warm lighting)	
<b>PRE</b> Preset manual	Use when the desired result is not achieved with <b>Auto (normal), Auto (warm lighting), Incandescent</b> , etc. (  65).
 Daylight*	Use under direct sunlight.
 Incandescent*	Use under incandescent lighting.
 Fluorescent	Use under most types of fluorescent lighting. Choose one of <b>1</b> (cool-white fluorescent), <b>2</b> (day white fluorescent) and <b>3</b> (daylight fluorescent).
 Cloudy*	Use under overcast skies.
 Flash*	Use with the flash.
 Choose color temp.	Use to directly specify color temperature (  64).

\* Fine adjustments in 7 steps are available. Apply positive (+) to increase blue hue and negative (-) to increase red hue.

### Notes About White Balance

- Lower the flash when white balance is set to any setting other than **Auto (normal), Auto (warm lighting)** or **Flash** (18).
- This function may not be available to use in combination with other functions (46).

## Color Temperature

Color temperature is an objective measure of colors of light sources which are expressed in the unit of absolute temperature (K: Kelvin). Light sources with lower color temperatures appear more reddish, while light sources with higher color temperatures appear more bluish.

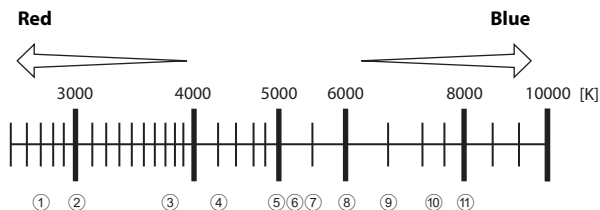

- |  |                                   |
|--|-----------------------------------|
| ① Sodium-vapor lamps: 2700K                      | ⑦ Flash: 5400K                    |
| ② Incandescent/<br>Warm-white fluorescent: 3000K | ⑧ Cloudy: 6000K                   |
| ③ White fluorescent: 3700K                       | ⑨ Daylight fluorescent: 6500K     |
| ④ Cool-white fluorescent: 4200K                  | ⑩ High temp. mercury-vapor: 7200K |
| ⑤ Day white fluorescent: 5000K                   | ⑪ Shade: 8000K                    |
| ⑥ Direct sunlight: 5200K                         |                                   |

## Using Preset Manual

Use the procedure below to measure the white balance value under the lighting used during shooting.

**1** Place a white or gray reference object under the lighting that will be used during shooting.

**2** Use the multi selector ▲▼ to select **Preset manual**, and press the **OK** button.

- The lens extends to the zoom position for measurement.

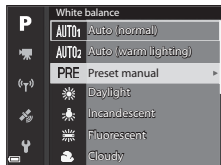

**3** Select **Measure**.

- To apply the last measured value, select **Cancel**.

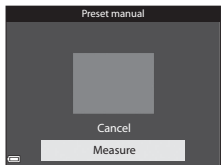

**4** Frame the white or gray reference object in the measuring window, and press the **OK** button to measure the value.

- The shutter is released and measurement is complete (no image is saved).

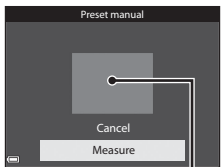

Measuring window

### ✓ Notes About Preset Manual



A white balance value for flash lighting cannot be measured with **Preset manual**. When shooting using the flash, set **White balance** to **Auto (normal)**, **Auto (warm lighting)** or **Flash**.

# Metering

Rotate the mode dial to **P, S, A, M** or **U** → MENU button → **P, S, A, M** or **U** menu icon → Metering →  button

The process of measuring the brightness of the subject to determine the exposure is known as “metering.”

Use this option to set the method of how the camera meters exposure.

Option	Description
 <b>Matrix</b> (default setting)	The camera uses a wide area of the screen for metering. Recommended for typical shooting.
 <b>Center-weighted</b>	The camera meters the entire frame but assigns greatest weight to the subject in the center of the frame. The classic metering for portraits; it preserves background details while letting lighting conditions in the center of the frame determine exposure.*
 <b>Spot</b>	The camera meters the area shown by the circle in the center of the frame. This can be used when the subject is much lighter or darker than the background. Ensure that the subject is within the area shown by the circle when shooting.*

\* To set focus and exposure for off-center subjects, change **AF area mode** to manual and set the focus area to the center of the frame, and then use focus lock (21).

## Notes About Metering











- When digital zoom is in effect, **Center-weighted** or **Spot** is selected depending on the magnification of an enlargement.
- This function may not be available to use in combination with other functions (46).







## Display on the Shooting Screen

When **Center-weighted** or **Spot** is selected, the metering range guide (6) is displayed (except when digital zoom is used).

## Continuous Shooting

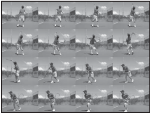
Rotate the mode dial to **P, S, A, M** or **U** → MENU button → **P, S, A, M** or **U** menu icon → Continuous →  button

Option	Description
 Single (default setting)	One image is captured each time the shutter-release button is pressed.
 Continuous H	While the shutter-release button is held all the way down, images are captured continuously. <ul style="list-style-type: none"><li>• The frame rate for continuous shooting is about 7 fps and the maximum number of continuous shots is about 7 (when image quality is set to <b>Normal</b> and image size is set to  <b>4608x3456</b>).</li></ul>
 Continuous L	While the shutter-release button is held all the way down, images are captured continuously. <ul style="list-style-type: none"><li>• The frame rate for continuous shooting is about 2 fps and the maximum number of continuous shots is about 200 (when image quality is set to <b>Normal</b> and image size is set to  <b>4608x3456</b>).</li></ul>
 Pre-shooting cache	Pre-shooting cache shooting begins when the shutter-release button is pressed halfway. When the shutter-release button is pressed the rest of the way down, the camera saves the current image as well as the images captured immediately before the button is pressed (  69). Pre-shooting cache makes it easy to capture perfect moments. <ul style="list-style-type: none"><li>• The frame rate for continuous shooting is about 15 fps and the maximum number of continuous shots is 20 (including a maximum of 5 frames captured in the pre-shooting cache).</li><li>• The image quality is fixed at <b>Normal</b> and the image size is fixed at  (1280 × 960 pixels).</li></ul>
 Continuous H: 120 fps	Each time the shutter-release button is pressed all the way, images are captured at a high speed rate. <ul style="list-style-type: none"><li>• The frame rate for continuous shooting is about 120 fps and the maximum number of continuous shots is 60.</li><li>• Image size is fixed at  <b>640x480</b>.</li></ul>

Option	Description
 <b>Continuous H: 60 fps</b>	Each time the shutter-release button is pressed all the way, images are captured at a high speed rate. <ul style="list-style-type: none"> <li>• The frame rate for continuous shooting is about 60 fps and the maximum number of continuous shots is 60.</li> <li>• Image size is fixed at  <b>1920x1080</b>.</li> </ul>
<b>BSS (Best Shot Selector)</b>	While the shutter-release button is held all the way down, the camera captures a series of up to 10 images and automatically saves the sharpest image. Use when shooting a stationary subject in a place where flash photography is prohibited and camera shake is likely to occur.
 <b>Multi-shot 16</b>	Each time the shutter-release button is pressed all the way, the camera captures a series of 16 images and saves it as a single image.  <ul style="list-style-type: none"> <li>• The frame rate for continuous shooting is about 30 fps.</li> <li>• Image size is fixed at  (2560 x 1920 pixels).</li> <li>• Digital zoom is not available.</li> </ul>
 <b>Intvl timer shooting</b>	The camera shoots still images automatically at the specified interval (  69).

## Notes About Continuous Shooting

- Focus, exposure and white balance are fixed at the values determined with the first shot in each series.
- It may take some time to save the images after shooting.
- When ISO sensitivity increases, noise may appear in captured images.
- The frame rate may become slower depending on the image quality, image size, memory card type or shooting conditions.
- When using **Multi-shot 16**, **Continuous H: 120 fps** or **Continuous H: 60 fps**, banding or variance in brightness or hue may occur in images that were captured under lighting that flashes quickly at high speeds, such as fluorescent, mercury-vapor, or sodium-vapor lighting.
- This function may not be available to use in combination with other functions (46).



## Pre-shooting Cache

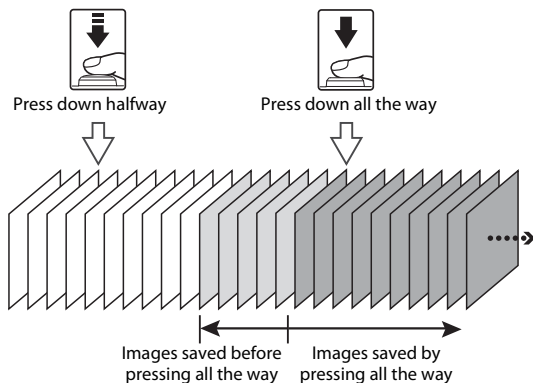

When the shutter-release button is pressed halfway or all the way down, images are saved as described below.



- The pre-shooting cache icon () on the shooting screen changes to green while the shutter-release button is pressed halfway.

## Interval Timer Shooting

Rotate the mode dial to **P, S, A, M** or **U** → MENU button → **P, S, A, M** or **U** menu icon → Continuous → 

- 1 Use the multi selector  to select  **Intvl timer shooting**, and then press the 

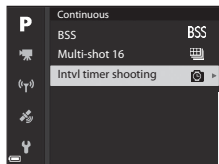

## 2 Set the desired interval between each shot.

- Use ◀▶ to select an item, and use ▲▼ to set the time.
- Press the **OK** button when setting is complete.

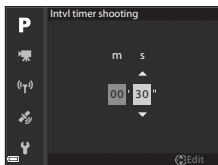

## 3 Press the **MENU** (menu) to display the shooting screen.

## 4 Press the shutter-release button to shoot the first image.

- The shutter is automatically released at the specified interval to shoot subsequent images.
- The monitor turns off and the power-on lamp flashes during the intervals between shots (when the battery is used).

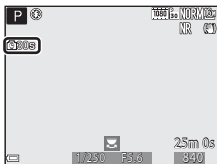

## 5 When the desired number of images have been captured, press the shutter-release button.

- Shooting ends.
- Shooting ends automatically when the memory card becomes full.

### **✓** Notes About Interval Timer Shooting

- To prevent the camera from turning off unexpectedly during shooting, use a fully charged battery.
- If the AC Adapter EH-67A (available separately; ) is used, this camera can be powered from an electrical outlet. Do not, under any circumstances, use an AC adapter other than the EH-67A. Failure to observe this precaution could result in overheating or damage to the camera.
- Do not rotate the mode dial to a different setting while performing interval timer shooting.
- If the shutter speed is slow and saving an image takes time compared to the specified interval, some of the shots during Interval timer shooting may be canceled.

# ISO Sensitivity

Rotate the mode dial to **P, S, A, M** or **U** → MENU button → **P, S, A, M** or **U** menu icon → ISO sensitivity →  button

A higher ISO sensitivity allows darker subjects to be captured. Additionally, even with subjects of similar brightness, pictures can be taken at faster shutter speeds, and blurring caused by camera shake and subject movement can be reduced.

- When a higher ISO sensitivity is set, images may contain noise.

Option	Description
ISO sensitivity	<ul style="list-style-type: none"><li>• <b>Auto</b> (default setting): Sensitivity is automatically selected from the range of ISO 100 to 1600.</li><li>• <b>Fixed range auto</b>: The range in which the camera automatically adjusts ISO sensitivity can be selected from <b>ISO AUTO 400 ISO 100-400</b> or <b>ISO AUTO 800 ISO 100-800</b>.</li><li>• <b>100 to 6400</b>: ISO sensitivity is fixed at the specified value.</li></ul>
Minimum shutter speed	<p>Set the shutter speed at which ISO sensitivity starts to be automatically adjusted when the shooting mode is <b>P</b> or <b>A</b>. If the exposure is insufficient with the shutter speed that is set here, the ISO sensitivity is increased automatically to obtain the correct exposure.</p> <ul style="list-style-type: none"><li>• The setting is enabled when <b>ISO sensitivity</b> is set to <b>Auto</b> or <b>Fixed range auto</b>.</li><li>• If the exposure is still insufficient even after ISO sensitivity is increased, the shutter speed slows down.</li><li>• Default setting: <b>None</b></li></ul>

## Notes About ISO Sensitivity

- In **M** (manual) mode, when set to **Auto, ISO 100-400** or **ISO 100-800**, the ISO sensitivity is fixed at ISO 100.
- This function may not be available to use in combination with other functions (46).

## ISO Sensitivity Display on the Shooting Screen

- When **Auto** is selected, **ISO** is displayed when the ISO sensitivity increases.
- When **ISO 100-400** or **ISO 100-800** is selected, the maximum value for ISO sensitivity is displayed.



## Exposure Bracketing

Rotate the mode dial to **P**, **S** or **A** → MENU button → **P**, **S** or **A** menu icon → Exposure bracketing →  button

The exposure (brightness) can be changed automatically during continuous shooting. This is effective for shooting when it is difficult to adjust the picture brightness.

Option	Description
Off (default setting)	Exposure bracketing is not performed.
$\pm 0.3$	When the shutter-release button is pressed all the way, 3 shots are taken in sequence and the camera varies exposure by 0, -0.3, and +0.3 over the shots.
$\pm 0.7$	When the shutter-release button is pressed all the way, 3 shots are taken in sequence and the camera varies exposure by 0, -0.7, and +0.7 over the shots.
$\pm 1.0$	When the shutter-release button is pressed all the way, 3 shots are taken in sequence and the camera varies exposure by 0, -1.0, and +1.0 over the shots.





### Notes About Exposure Bracketing



- **Exposure bracketing** is not available in **M** (manual) mode.
- When exposure compensation (44) and  $\pm 0.3$ ,  $\pm 0.7$  or  $\pm 1.0$  in **Exposure bracketing** are set simultaneously, the combined exposure compensation values are applied.
- This function may not be available to use in combination with other functions (46).

## AF Area Mode

Rotate the mode dial to **P, S, A, M** or **U** → MENU button → **P, S, A, M** or **U** menu icon → AF area mode → **OK** button

Set how the camera selects the focus area for autofocus.

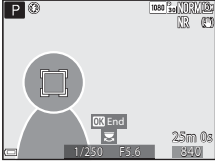
Option	Description
<p> Face priority</p>	<p>When the camera detects a human face, it focuses on that face. See “Using Face Detection” (19) for more information.</p> <p>When framing a composition with no human subjects or detected faces, the camera automatically selects one or more of the 9 focus areas containing the subject closest to the camera.</p> <div data-bbox="632 317 915 529" data-label="Image"> </div> <p data-bbox="660 544 774 569">Focus area</p>
<p> Manual (spot)</p> <p> Manual (normal)</p> <p> Manual (wide)</p>	<p>Use the multi selector  or rotate it to move the focus area to where you want to focus.</p> <p>To use the multi selector to configure the flash mode or other settings, press the <b>OK</b> button. To return to moving the focus area, press the <b>OK</b> button again.</p> <div data-bbox="632 642 915 854" data-label="Image"> </div> <p data-bbox="650 860 847 885">Focus area (center)</p> <p data-bbox="726 889 912 943">Scope of movable focus area</p> <div data-bbox="632 972 915 1185" data-label="Image"> </div> <p data-bbox="632 1191 837 1215">Focus area (moved)</p>

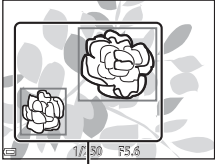
Option	Description
 Subject tracking	<p>Use this function to take pictures of moving subjects. Register the subject on which the camera focuses. The focus area automatically moves to track the subject. See "Using Subject Tracking" (👓75) for more information.</p> 
 Target finding AF (default setting)	<p>When the camera detects the main subject, it focuses on that subject. See "Using Target Finding AF" (👓18).</p>  <p style="text-align: center;">Focus areas</p>

### ✓ Notes About AF Area Mode

- When digital zoom is in effect, the camera focuses on the area in the center of the frame regardless of the **AF area mode** setting.
- This function may not be available to use in combination with other functions (📖46).

## Using Subject Tracking

Rotate the mode dial to **P, S, A, M** or **U** → MENU button → **P, S, A, M** or **U** menu icon → AF area mode → **OK** button →  Subject tracking → **OK** button → MENU button

### 1 Register a subject.

- Align the subject that you want to track with the border in the center of the monitor and press the **OK** button.
- When the subject is registered, a yellow border (focus area) is displayed around it and the camera begins tracking the subject.
- If the subject cannot be registered, the border is displayed in red. Change the composition and try registering the subject again.
- To cancel subject registration, press the **OK** button.
- If the camera can no longer track the registered subject, the focus area disappears. Register the subject again.

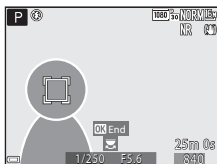
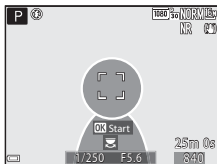

### 2 Press the shutter-release button fully to take the picture.

- If the shutter-release button is pressed while the focus area is not displayed, the camera focuses on the subject in the center of the frame.

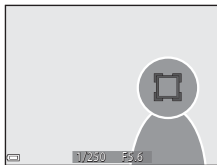

### Notes About Subject Tracking

- If you perform operations such as zooming while the camera is tracking the subject, the registration is canceled.
- Subject tracking may not be possible in certain shooting conditions.

## Autofocus Mode

Rotate the mode dial to **P, S, A, M** or **U** → MENU button → **P, S, A, M** or **U** menu icon → Autofocus mode →  button

Set how the camera focuses when shooting still images.

Option	Description
<b>AF-S</b> Single AF	The camera focuses only when the shutter-release button is pressed halfway.
<b>AF-F</b> Full-time AF (default setting)	The camera continues focusing even when the shutter-release button is not pressed halfway. The sound of lens drive movement is heard while the camera focuses.

### Notes About Autofocus Mode

This function may not be available to use in combination with other functions (46).

### Autofocus Mode for Movie Recording

Autofocus mode for movie recording can be set with **Autofocus mode** (85) in the movie menu.

## Flash Exp. Comp.

Rotate the mode dial to **P, S, A, M** or **U** → MENU button → **P, S, A, M** or **U** menu icon → Flash exp. comp. →  button

Adjust the flash output.

Use this option when the flash is too bright or too dark.



Option	Description
+0.3 to +2.0	The flash output is increased from +0.3 to +2.0 EV, in increments of 1/3 EV, to make the main subject of the frame appear brighter.
0.0 (default setting)	The flash output is not adjusted.
-0.3 to -2.0	The flash output is reduced from -0.3 to -2.0 EV, in increments of 1/3 EV, to prevent unwanted highlights or reflections.



## Noise Reduction Filter

Rotate the mode dial to **P, S, A, M** or **U** → MENU button → **P, S, A, M** or **U** menu icon → Noise reduction filter →  button



Set the strength of the noise reduction function that is normally performed when saving images.

Option	Description
 High	Performs noise reduction at a level higher than the standard strength.
 Normal (default setting)	Performs noise reduction at the standard strength.
 Low	Performs noise reduction at a level lower than the standard strength.

## Active D-Lighting

Rotate the mode dial to **P, S, A, M** or **U** → MENU button → **P, S, A, M** or **U** menu icon → Active D-Lighting →  button

Details in highlights and shadows are preserved, and the natural contrast that is seen with the naked eye is well reproduced in the image captured. This is particularly effective for shooting scenes with high contrast, such as brightly lit outdoor scenery from a dark room or shaded subjects at a sunny seaside.

Option	Description
 High  Normal  Low	Set the effect level.
<b>OFF</b> Off (default setting)	Active D-Lighting is not applied.

### Notes About Active D-Lighting

- Additional time is required to save images after shooting.
- This function may not be available to use in combination with other functions (□46).

### Active D-Lighting Versus D-Lighting

The **Active D-Lighting** option in the shooting menu reduces exposure before shooting to adjust the dynamic range properly. The **D-Lighting** () option in the playback menu readjusts the dynamic range properly in images captured.

## Multiple Exposure

Rotate the mode dial to **P, S, A, M** or **U** → MENU button → **P, S, A, M** or **U** menu icon → Multiple exposure → **OK** button

The camera combines two to three images and saves them as a single image.

Option	Description
Multiple exposure mode	Shoots images in multiple exposure mode when set to <b>On</b> . <ul style="list-style-type: none"><li>• Individual images are also saved.</li><li>• Default setting: <b>Off</b></li></ul>
Auto gain	Set whether or not to automatically adjust the brightness of the image when combining images. <ul style="list-style-type: none"><li>• Default setting: <b>On</b></li></ul>

### ✓ Notes About Multiple Exposure

- It may take some time to combine images.
- Multiple exposure is terminated if the auto off function (📖57) triggers the standby mode during shooting. When shooting with a long interval between shots, setting a longer time for the auto off function is recommended.
- This function may not be available to use in combination with other functions (📖46).
- When shooting at a slow shutter speed in multiple exposure mode, noise (bright spots) may appear in saved images.

## Multiple Exposure Shooting

Rotate the mode dial to **P, S, A, M** or **U** → MENU button → **P, S, A, M** or **U** menu icon → Multiple exposure → **OK** button

- 1 Use the multi selector ▲▼ to select **Multiple exposure mode**, and then press the **OK** button.

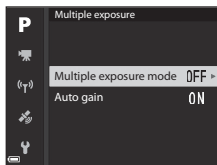

- 2 Select **On**, and then press the **OK** button.

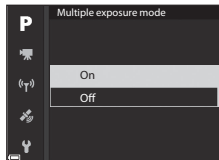

- 3 Press the **MENU** (menu) button to display the shooting screen.

- 4 Press the shutter-release button to shoot the first image.

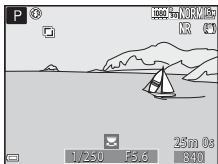

- 5 Press the shutter-release button to shoot the second image.

- Frame the picture while looking at the first image displayed translucently.
- When shooting the second image, the combined image of the first and second images is saved, and displayed translucently.
- To end multiple exposure at the second image, set **Multiple exposure mode** to **Off** or change the mode dial to any mode other than **P**, **S**, **A**, **M** or **U**.

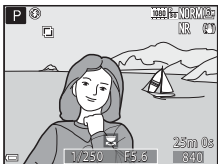







- 6 Press the shutter-release button to shoot the third image.

- The combined image of the first to third images is saved and multiple exposure ends.
- It may take some time until the third image is shot.

## Zoom Memory

Rotate the mode dial to **P, S, A, M** or **U** → MENU button → **P, S, A, M** or **U** menu icon → Zoom memory →  button

Option	Description
On	<p>When the zoom control is moved, the zoom position (equivalent to focal length/angle of view in 35mm [135] format) is switched to the positions that have been selected by setting the check box to on in this menu option.</p> <ul style="list-style-type: none"><li>Choose the focal length with the multi selector , and then press the  button to set the check box to on [] or off.</li></ul> <p>The following settings are available: <b>24 mm, 28 mm, 35 mm, 50 mm, 85 mm, 105 mm, 135 mm, 200 mm, 300 mm, 400 mm, 500 mm, 600 mm, 800 mm, 1000 mm, 1200 mm, 1400 mm, 1600 mm, 1800 mm</b> and <b>2000 mm</b>.</p> <ul style="list-style-type: none"><li>Default setting: On [] for all the check boxes</li><li>To finish setting, press the multi selector .</li><li>The zoom position set in the <b>Startup zoom position</b> is automatically set to on [<li>The zoom memory function cannot be used with the side zoom control.</li></li></ul>
Off (default setting)	The zoom position can be moved to any position, including the positions that can be set with <b>On</b> .



### Notes About Zoom Operation

- When more than one focal length has been set, move the zoom control to switch to the focal length closest to that before the operation. To switch to a different focal length, release the zoom control and then move it again.
- Set **Zoom memory** to **Off** when using the digital zoom.

## Startup Zoom Position

Rotate the mode dial to **P, S, A, M** or **U** → MENU button → **P, S, A, M** or **U** menu icon → Startup zoom position →  button

Set the zoom position (equivalent to focal length/angle of view in 35mm [135] format) for when the camera is turned on.

The following settings are available: **24 mm** (default setting), **28 mm**, **35 mm**, **50 mm**, **85 mm**, **105 mm** and **135 mm**.

---

## M Exposure Preview



Rotate the mode dial to **P, S, A, M** or **U** → MENU button → **P, S, A, M** or **U** menu icon → M exposure preview →  button



Set whether or not to reflect the brightness to the shooting screen when the exposure is changed in **M** (manual) mode.

Option	Description
On	Reflects the brightness to the shooting screen.
Off (default setting)	Does not reflect the brightness to the shooting screen.

# The Movie Menu





## Movie Options

Enter shooting mode → MENU button →  menu icon → Movie options  
→  button

Select the desired movie option to record. Select normal speed movie options to record at normal speed, or HS movie options () to record in slow or fast motion. The movie options that can be selected vary depending on the **Frame rate** setting (.

- Memory cards with an SD Speed Class rating of 6 or faster are recommended for recording movies (.



### Normal Speed Movie Options

	Option (Image size/ Frame rate, File format)	Image size	Aspect ratio (horizontal to vertical)
	1080/30p (default setting) 1080/25p	1920 × 1080	16:9
	1080/60p 1080/50p	1920 × 1080	16:9
	720/30p 720/25p	1280 × 720	16:9
	720/60p 720/50p	1280 × 720	16:9
	480/30p 480/25p	640 × 480	4:3

## HS Movie Options

Recorded movies are played back in fast or slow motion.

See “Playing Back in Slow Motion and Fast Motion” (884).

Option	Image size Aspect ratio (horizontal to vertical)	Description
 HS 480/4x*	640 × 480 4:3	1/4-speed slow motion movies <ul style="list-style-type: none"> <li>Max. recording time: 7 minutes 15 seconds (playback time: 29 minutes)</li> </ul>
 HS 720/2x	1280 × 720 16:9	1/2-speed slow motion movies <ul style="list-style-type: none"> <li>Max. recording time: 14 minutes 30 seconds (playback time: 29 minutes)</li> </ul>
 HS 1080/ 0.5x	1920 × 1080 16:9	2x speed fast motion movies <ul style="list-style-type: none"> <li>Max. recording time: 29 minutes (playback time: 14 minutes 30 seconds)</li> </ul>

\* The setting is not available when using certain special effects.

### Notes About HS Movie

- Sound is not recorded.
- Zoom position, focus, exposure, and white balance are locked when movie recording starts.



## Playing Back in Slow Motion and Fast Motion

When recording at normal speed:

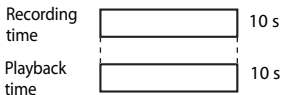

When recording at  $\frac{480p}{24}$  HS 480/4x, or  $\frac{480p}{100}$  HS 480/4x:

Movies are recorded at 4x normal speed.

They are played back in slow motion at 4x slower speed.

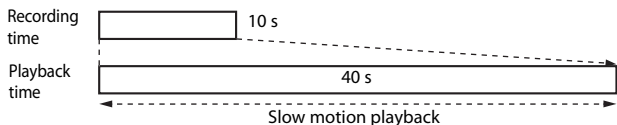

When recording at  $\frac{1080p}{15}$  HS 1080/0.5x, or  $\frac{1080p}{25}$  HS 1080/0.5x:

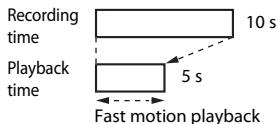

Movies are recorded at 1/2 normal speed.

They are played back in fast motion at 2x faster speed.





## Autofocus Mode

Enter shooting mode → MENU button →  menu icon → Autofocus mode →  button



Set how the camera focuses when recording movies.

Option	Description
AF-S Single AF (default setting)	Focus is locked when movie recording starts. Select this option when the distance between the camera and the subject will remain fairly consistent.
AF-F Full-time AF	The camera focuses continuously. Select this option when the distance between the camera and subject will change significantly during recording. The sound of the camera focusing may be heard in the recorded movie. Use of <b>Single AF</b> is recommended to prevent the sound of the camera focusing from interfering with recording.

### **Autofocus Mode**

- When an HS movie option is selected in **Movie options**, the setting is fixed at **Single AF**.
- This function may not be available to use in combination with other functions.

## Electronic VR

Enter shooting mode → MENU button →  menu icon → Electronic VR →  button



Set whether or not to perform electronic VR when recording movies.

Option	Description
On (default setting)	Performs electronic VR. <ul style="list-style-type: none"><li>• The angle of view (i.e., the area seen in the frame) becomes narrower.</li><li>• When <b>Vibration reduction</b> is set to <b>Normal</b> or <b>Active</b> in the setup menu (57), optical vibration reduction is performed simultaneously.</li></ul>
Off	Does not perform electronic VR.

### Notes About Electronic VR

When an HS movie option is selected in **Movie options**, the setting is fixed at **Off**.

## Wind Noise Reduction



Enter shooting mode → MENU button →  menu icon → Wind noise reduction →  button

Option	Description
On	Reduces the sound that is produced when wind passes over the microphone during movie recording. Other sounds may become difficult to hear during playback.
Off (default setting)	Wind noise reduction is disabled.

### Notes About Wind Noise Reduction

When an HS movie option is selected in **Movie options**, the setting is fixed at **Off**.

## Zoom Microphone



Enter shooting mode → MENU button →  menu icon → Zoom microphone →  button

Option	Description
On (default setting)	In accordance with the angle of view, the camera records sounds over a wide area at the wide-angle zoom position, and records sounds in the limited area at the telephoto zoom position.
Off	Zoom microphone is disabled.

### Notes About Zoom Microphone

When an HS movie option is selected in **Movie options**, the setting is fixed at **Off**.

## Frame Rate

Enter shooting mode → MENU button →  menu icon → Frame rate →  button

Select the frame rate used when recording movies. When the frame rate setting is switched, options that can be set in **Movie options** (82) change.



Option	Description
30 fps (30p/60p)	Suited for playback on a TV using the NTSC standard.
25 fps (25p/50p)	Suited for playback on a TV using the PAL standard.

## The Playback Menu

See “Editing Images (Still Images)” (📷26) for information about image editing functions.

---

### Mark for Wi-Fi Upload



Press the  button (playback mode) → MENU button → Mark for Wi-Fi upload →  button

Select still images in the camera that you want to transfer to a smart device in advance before transferring them. Movies cannot be selected.

On the image selection screen (56), select or deselect images for the Mark for Wi-Fi upload function.



Note that when you select **Reset all** (📷110) in the setup menu or **Restore default settings** (📷92) in the Wi-Fi options menu, the Mark for Wi-Fi upload settings that you made are canceled.

## Slide Show

Press the  button (playback mode) → MENU button → Slide show →  button



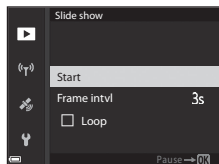

Play back images one by one in an automated “slide show.” When movie files are played back in the slide show, only the first frame of each movie is displayed.

### 1 Use the multi selector to select **Start** and press the button.

- The slide show begins.
- To change the interval between images, select **Frame intvl**, press the  button, and specify the desired interval time before selecting **Start**.
- To repeat the slide show automatically, select **Loop** and press the  button before selecting **Start**.
- The maximum playback time is up to about 30 minutes even if **Loop** is enabled.





### 2 End or restart the slide show.



- The screen shown on the right is displayed after the slide show ends or is paused. To exit the show, select  and then press the  button. To resume the slide show, select  and then press the  button.



### Operations During Playback

- Use the multi selector  to display the previous/next image. Press and hold to rewind/fast forward.
- Press the  button to pause or end the slide show.

## Protect



Press the  button (playback mode) → MENU button → Protect →  button

The camera protects selected images from accidental deletion.

Select images to protect or cancel protection from the image selection screen (56).



Note that formatting the memory card permanently deletes all data including protected files (107).

## Rotate Image

Press the  button (playback mode) → MENU button → Rotate image →  button

Specify the orientation in which saved images are displayed during playback. Still images can be rotated 90 degrees clockwise or 90 degrees counterclockwise.

Images that were saved in the “tall” orientation can be rotated up to 180 degrees in either direction.

Select an image from the image selection screen (56). When the Rotate image screen is displayed, use the multi selector  or rotate it to rotate the image 90 degrees.

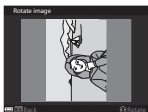

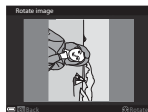

Rotate 90 degrees counterclockwise



Rotate 90 degrees clockwise

Press the  button to finalize display orientation, and save orientation information with the image.

## Sequence Display Options



Press the  button (playback mode) → MENU button → Sequence display options →  button

Select the method used to display images in the sequence (25).

Option	Description
Individual pictures	Displays each image in a sequence individually.  is displayed on the playback screen.
Key picture only (default setting)	Displays only the key picture for images in a sequence.

Settings are applied to all sequences, and the setting is saved in the camera's memory even if the camera is turned off.

## Choose Key Picture

Press the  button (playback mode) → display a sequence for which you want to change the key picture → MENU button → Choose key picture →  button







Specify a different image in the sequence as the key picture.

- When the key picture selection screen is displayed, select an image (56).

# The Wi-Fi Options Menu

Press the MENU button →  menu icon →  button

Configure the Wi-Fi (wireless LAN) settings to connect the camera and a smart device.

Option	Description
Connect to smart device	Select when wirelessly connecting the camera and a smart device. See "Connecting to a Smart Device (Wi-Fi)" (  ) for more information.
Upload from camera	Select when wirelessly connecting the camera and a smart device. See "Preselecting Images in the Camera That You Want to Transfer to a Smart Device" (  ) for more information. <ul style="list-style-type: none"><li>The images to transfer can be selected on the image selection screen before establishing a Wi-Fi connection ()56, )88). The SSID and password of the camera are displayed on the screen after images are selected.</li></ul>
Disable Wi-Fi	Select to terminate the wireless connection between the camera and a smart device. See "To Terminate the Wi-Fi Connection" (  ) for more information.
Options	<b>SSID:</b> Change the SSID. The SSID configured here is displayed on the smart device. Set a 1- to 24-character alphanumeric SSID.
	<b>Auth./encryp.:</b> Select whether or not to encrypt the communications between the camera and the connected smart device. Communications are not encrypted when <b>Open</b> (default setting) is selected. <ul style="list-style-type: none"><li>When <b>WPA2-PSK-AES</b> is set, the message for entering a password is displayed when the camera is connected to smart device ()45).</li></ul>
	<b>Password:</b> Set an 8- to 16-character alphanumeric password.
	<b>Channel:</b> Select the channel used for wireless connections.
	<b>Subnet mask:</b> Use the default setting ( <b>255.255.255.0</b> ) under normal conditions.
	<b>DHCP server IP address:</b> Use the default setting ( <b>192.168.0.10</b> ) under normal conditions.
Current settings	Display the current settings.
Restore default settings	Restore the Wi-Fi settings to their default values. The wireless connection is terminated if this option is performed while Wi-Fi is connected.



# Operating the Text Input Keyboard

## Character Input for SSID and Password

- Use the multi selector ▲▼◀▶ to select alphanumeric characters. Press the OK button to enter the selected character in the text field and move the cursor to the next space.
- To move the cursor in the text field, select ← or → on the keyboard, and press the OK button.
- To delete one character, press the 🗑️ button.
- To apply the setting, select ↵ on the keyboard and press the OK button.

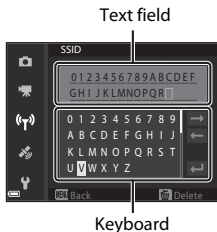



## Character Input for Channel, Subnet mask and DHCP server IP address



- Use the multi selector ▲▼ to set the numbers. To move to the next digit, press ▶ or the OK button. To return to the previous digit, press ◀.
- To apply the setting, select the last digit and press the OK button.



# The Location Data Options Menu

## Location Data Options

Press the **MENU** button →  menu icon → Location data options →  button

Option	Description
Record location data	When set to <b>On</b> , signals are received from the positioning satellites, and positioning starts (  39). <ul style="list-style-type: none"><li>• Default setting: <b>Off</b></li></ul>
Update A-GPS file	A memory card is used to update the A-GPS (assist GPS) file. Using the latest A-GPS file can shorten the time needed for obtaining the location data. <ul style="list-style-type: none"><li>• See "Updating the A-GPS File" (95) for more information.</li></ul>
Erase location data	The location data and POI information recorded on images are erased. <ul style="list-style-type: none"><li>• The deleted location data or POI information cannot be recovered.</li><li>• The location data of images captured with cameras other than this camera cannot be erased.</li></ul>

## Updating the A-GPS File

Download the latest A-GPS file from the website below, and use it to update the file.

<http://nikonimglib.com/agps3/>

- The A-GPS file for the COOLPIX P900 is only available from the website above.

---

**1** Download the latest A-GPS file to the computer from the website.

---

**2** Use a card reader or other device to copy the downloaded file to the “NCFL” folder of the memory card.

- The “NCFL” folder is located directly under the memory card root directory. If the memory card does not have “NCFL” folder, create a new folder.

---

**3** Insert the memory card containing the copied file into the camera.

---

**4** Turn on the camera.

---

**5** Press the **MENU** (menu) button to display the location data options menu, and use the multi selector to select **Location data options**.

---



**6** Select **Update A-GPS file**, and update the file.

- About 2 minutes are needed to update the A-GPS file.



### **Notes About Updating A-GPS File**

- The A-GPS file is disabled when a position is determined for the first time after the camera is purchased. The A-GPS file becomes active from the second operation for determining a location.
- The validity period of the A-GPS file can be checked on the update screen. If the validity period has expired, it is displayed in gray.
- Once the validity period of the A-GPS file has expired, obtaining the location data will not become faster. Updating of the A-GPS file before using the location data functions is recommended.

## Points of Interest (POI) (Recording and Displaying Location Name Information)

Press the **MENU** button →  menu icon → Points of interest (POI) →  button

Configure the POI (points of interest, location name information) settings.



Option	Description
Embed POI	Set whether or not to record the location name information on the images to be shot. <ul style="list-style-type: none"><li>• Default setting: <b>Off</b></li><li>• The location name information can be recorded on both still images and movies.</li></ul>
Display POI	Set whether or not to display the location name information on the shooting screen or playback screen (  6, 7). <ul style="list-style-type: none"><li>• If <b>Embed POI</b> was set to <b>On</b> when an image was captured, the location name information for the image is displayed on the playback screen.</li><li>• Default setting: <b>Off</b></li></ul>
Level of detail	Set the display level of the location name information. A higher display level shows more detailed regional information. <ul style="list-style-type: none"><li>• When set to level 1: country names are displayed.</li><li>• When set to levels 2 to 5: the information displayed varies depending on the country.</li><li>• When set to level 6: landmark names (facilities) are displayed.</li></ul>
Edit POI	If <b>Update POI</b> is selected during playback mode, the location name information recorded on the image can be changed. Before pressing the <b>MENU</b> button, select the image to change the location name information. <ul style="list-style-type: none"><li>• When level 6 is selected, press the multi selector  to change the landmark name.</li><li>• To change the POI information level, press the multi selector .</li></ul> If <b>Remove POI</b> is selected, the location name information recorded on the image is deleted.



### POI Display



If there is no location name information at the set display level, no information may be displayed.

## Set Clock from Satellite

Press the **MENU** button →  menu icon → Set clock from satellite → 

Signals from the positioning satellites are used to set the date and time of the camera's internal clock. Check the positioning status before setting the clock using this option.

### **Notes About Set Clock from Satellite**

- To set the camera's internal clock, positioning must have been done successfully (39).
- Date/time adjustment by **Set clock from satellite** is set according to the time zone set in **Time zone and date** (57, 98) of the setup menu. Check the time zone before setting **Set clock from satellite**.
- The date/time set using **Set clock from satellite** is not as accurate as radio clocks. Use **Time zone and date** in the setup menu to set the time if it is not accurate in **Set clock from satellite**.

# The Setup Menu

## Time Zone and Date

Press the **MENU** button → **Y** menu icon → Time zone and date → **OK** button

Set the camera clock.

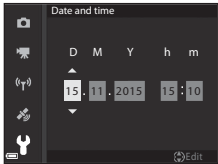
Option	Description
Date and time	<ul style="list-style-type: none"><li>• Select a field: Press the multi selector ◀▶.</li><li>• Edit the date and time: Press ▲▼. Date and time can also be changed by rotating the multi selector or command dial.</li><li>• Apply the setting: Select the minute field setting and press the <b>OK</b> button or ▶.</li></ul> 
Date format	Select <b>Year/Month/Day</b> , <b>Month/Day/Year</b> , or <b>Day/Month/Year</b> .
Time zone	Set time zone and daylight saving time. <ul style="list-style-type: none"><li>• When <b>Travel destination</b> (✈) is set after having set the home time zone (🏠), the time difference between the travel destination and the home time zone is automatically calculated, and the date and time are saved for the selected region.</li></ul>

## Setting the Time Zone

- 1 Use the multi selector ▲▼ to select **Time zone** and press the **OK** button.

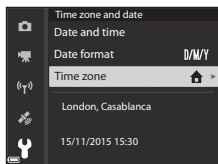

- 2** Select  **Home time zone** or  **Travel destination** and press the  button.



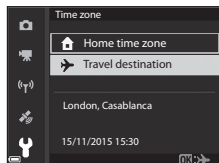

- The date and time displayed in the monitor changes depending on whether the home time zone or travel destination is selected.

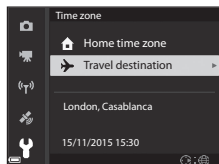

- 3** Press .



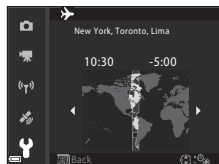

- 4** Use   to select the time zone.

- Press  to enable daylight saving time function, and  is displayed. Press  to disable the daylight saving time function.
- Press the  button to apply the time zone.
- If the correct time is not displayed for the home or travel destination time zone setting, set the appropriate time in **Date and time**.



## Slot Empty Release Lock

Press the **MENU** button →  menu icon → Slot empty release lock → 













Set whether or not the shutter can be released when no memory card is inserted in the camera.

Option	Description
Release locked (default setting)	Unless a memory card is inserted in the camera, the shutter cannot be released.
Enable release	Even when no memory card is inserted in the camera, the shutter can be released. However, <b>Demo mode</b> is displayed on the image captured when no memory card is inserted and the image cannot be printed or saved on a memory card, although the image is displayed on the monitor.



# Monitor Settings

Press the **MENU** button →  menu icon → Monitor settings →  button

Option	Description
Image review	Set whether or not to display the captured image immediately after shooting. <ul style="list-style-type: none"><li>• Default setting: <b>On</b></li></ul>
Monitor options	Adjust the monitor brightness and hue. <ul style="list-style-type: none"><li>• Use the multi selector   to adjust brightness,   to adjust hue and then press the  button.</li><li>• Default setting: Brightness <b>3</b> Hue <b>0</b></li><li>• Cannot be set when the viewfinder is used.</li></ul>
EVF options	Adjust the viewfinder brightness and hue. <ul style="list-style-type: none"><li>• Use the multi selector   to adjust brightness,   to adjust hue and then press the  button.</li><li>• Default setting: Brightness <b>2</b> Hue <b>0</b></li><li>• Cannot be set when the monitor is used.</li></ul>
View/hide framing grid	Set whether or not to display a boxed guide for framing on the shooting screen. <ul style="list-style-type: none"><li>• Default setting: <b>Off</b></li></ul>
View/hide histograms	Set whether or not to display a graph that shows the brightness distribution in the image (  44) on the shooting screen. <ul style="list-style-type: none"><li>• Default setting: <b>Off</b></li></ul>
Virtual horizon	Set whether or not to display a virtual horizon on the shooting screen (  102). <ul style="list-style-type: none"><li>• Default setting: <b>Off</b></li></ul>

## Notes About View/Hide Framing Grid

When the enlarged center of the image is displayed in **MF** (manual focus), the framing grid is not displayed.

## Notes About View/Hide Histograms

Histograms are not displayed in the following situations:

-  (auto) mode
- When recording a movie
- When the enlarged center of the image is displayed in **MF** (manual focus)
- When shooting with easy panorama
- When the flash mode, self-timer or focus mode menu is displayed

## Virtual Horizon

The virtual horizon for rolling and pitching directions is displayed on the monitor using a built-in tilt sensor.

The virtual horizon can be displayed when **AF area mode** is set to **Manual (spot)**, **Manual (normal)** or **Manual (wide)** in **P**, **S**, **A** or **M** mode, and in some scene modes or special effects modes with the focus area set to the center of the frame.

- When the camera is in a normal position (without inclination), for the rolling direction, the reference line on the virtual horizon display changes to green. As for the pitching direction, ● in the center changes to green.
- One graduation of the virtual horizon represents 5 degrees for the rolling direction, and 10 degrees for the pitching direction.



The camera is in a normal position for both rolling and pitching directions.



The camera tilts to the rolling direction.



The camera tilts to the pitching direction.

### ✓ Notes About Virtual Horizon

The virtual horizon is not displayed in the following situations:

- 📷 (auto) mode
- When the scene mode is set to 🌙 (night portrait), **Scene auto selector**, **Portrait**, **Food**, **Easy panorama**, or **Pet portrait**
- When recording a movie
- When smile timer is selected

### 📎 Precision of the Virtual Horizon

Note that an error becomes large if the camera is tilted forward or backward greatly. If the camera is tilted to the unmeasurable extent, the graduations of the virtual horizon turns off.

## EVF Auto Toggle (Automatically Switching the Display to the Viewfinder)

Press the **MENU** button → **Y** menu icon → EVF auto toggle → **OK** button

Option	Description
On (default setting)	When you bring your face close to the viewfinder, the eye sensor responds to it and the display is automatically switched from the monitor to viewfinder.
Off	Even when you bring your face close to the viewfinder, the display is not switched to the viewfinder.

## Date Stamp

Press the **MENU** button → **Y** menu icon → Date stamp → **OK** button

The shooting date and time can be stamped on images when shooting.





Option	Description
<b>DATE</b> Date	Date is stamped on images.
<b>DATE</b>  Date and time	Date and time are stamped on images.
Off (default setting)	Date and time are not stamped on images.

## Notes About Date Stamp

- Stamped dates form a permanent part of image data and cannot be deleted. The date and time cannot be stamped on images after they have been captured.
- The date and time cannot be stamped in the following situations:
  - When the scene mode is set to **Night landscape** (when set to **Hand-held**), **Night portrait** (when set to **Hand-held**), **Sports, Museum, Backlighting** (when **HDR** is set to **On**), **Easy panorama**, **Pet portrait** (when set to **Continuous**), or **Bird-watching** (when set to **Continuous**)
  - When **Pre-shooting cache**, **Continuous H: 120 fps** or **Continuous H: 60 fps** is selected for **Continuous** ()
  - When recording movies
  - When saving still images during movie recording
  - When extracting still images from a movie during movie playback
- The stamped date and time may be difficult to read when using a small image size.



---

## Vibration Reduction

Press the **MENU** button →  menu icon → **Vibration reduction** →  button

Select the vibration reduction setting used when shooting.

Select **Off** when using a tripod to stabilize the camera during shooting.

Option	Description
 <b>Normal</b> (default setting)	Compensates camera shake that commonly occurs when shooting at telephoto zoom positions or slow shutter speeds. The camera automatically detects the panning direction and only compensates for vibration caused by camera shake. When the camera is panned horizontally, for example, vibration reduction only reduces vertical shake. If the camera is panned vertically, vibration reduction only compensates for horizontal shake.
 <b>Active</b>	Camera shake is automatically compensated during shooting if a comparatively large camera shake is likely to occur when shooting from a car or under poor foothold conditions.
<b>Off</b>	Compensation is not performed.

## Notes About Vibration Reduction

- After turning on the camera or after switching from playback mode to shooting mode, wait for the shooting mode screen to be displayed completely before taking pictures.
- Images in the camera monitor may be displayed blurry immediately after shooting.
- Vibration reduction may be unable to completely eliminate the effects of camera shake in some situations.

## AF Assist

Press the MENU button → Y menu icon → AF assist → OK button

Option	Description
Auto (default setting)	The AF-assist illuminator automatically lights up when you press the shutter-release button under dim lighting. The illuminator has a range of about 5.0 m (16 ft) at the maximum wide-angle position and about 5.0 m (16 ft) at the maximum telephoto position. <ul style="list-style-type: none"><li>Note that for some scene modes or focus areas, the AF-assist illuminator may not light.</li></ul>
Off	The AF-assist illuminator does not light.

## Digital Zoom



Press the MENU button → Y menu icon → Digital zoom → OK button

Option	Description
On (default setting)	Digital zoom is enabled.
Off	Digital zoom is disabled.



### Notes About Digital Zoom

- Digital zoom cannot be used in the following scene modes.
  - Scene auto selector, Portrait, Night portrait, Easy panorama, Pet portrait**
- Digital zoom cannot be used in other shooting modes when using certain settings (48).

## Assign Side Zoom Control

Press the MENU button →  menu icon → Assign side zoom control →  button

Choose the function to be performed during shooting when the side zoom control is moved.



Option	Description
Zoom (default setting)	When shooting, use the side zoom control (  20) to adjust the zoom.
Manual focus	When the focus mode is set to <b>MF</b> (manual focus), use the side zoom control to focus (  42). <ul style="list-style-type: none"><li>• Move the side zoom control toward <b>T</b> to focus on distant subjects.</li><li>• Move the side zoom control toward <b>W</b> to focus on near subjects.</li></ul>

## Sound Settings

Press the MENU button →  menu icon → Sound settings →  button

Option	Description
Button sound	When <b>On</b> (default setting) is selected, the camera produces one beep when operations are performed, two beeps when focus is acquired on the subject, and three beeps when an error occurs. <ul style="list-style-type: none"><li>• Sounds are disabled when using <b>Pet portrait</b> or <b>Bird-watching</b> scene mode.</li></ul>
Shutter sound	When <b>On</b> (default setting) is selected, the shutter sound is produced when the shutter is released. <ul style="list-style-type: none"><li>• The shutter sound is not produced when using continuous shooting mode, when recording movies, or when using <b>Easy panorama</b>, <b>Pet portrait</b> or <b>Bird-watching</b> scene mode.</li></ul>

## Auto Off

Press the **MENU** button →  menu icon → Auto off →  button

Set the amount of time that elapses before the camera enters standby mode (18).

You can select **30 s**, **1 min** (default setting), **5 min**, or **30 min**.



### Setting the Auto Off Function

The time that passes before the camera enters standby mode is fixed in the following situations:

- When a menu is displayed: 3 minutes (when auto off is set to **30 s** or **1 min**)
- When the AC adapter is connected: 30 minutes

---

## Format Card

Press the **MENU** button →  menu icon → Format card →  button

Use this option to format a memory card.



**Formatting the memory cards permanently deletes all data. Data that has been deleted cannot be recovered.** Make sure to save important images to a computer before formatting.

To start formatting, select **Format** on the screen that is displayed and press the  button.

- Do not turn the camera off or open the battery-chamber/memory card slot cover during formatting.



---

## Language

Press the **MENU** button →  menu icon → Language →  button

Select a language for display of camera menus and messages.

## Charge by Computer

Press the MENU button →  menu icon → Charge by computer →  button

Option	Description
AUTO Auto (default setting)	When the camera is connected to a computer that is running (61), the battery inserted into the camera is automatically charged using power supplied by the computer.
Off	The battery inserted into the camera is not charged when the camera is connected to a computer.

### Notes About Charging with a Computer

- When connected to a computer, the camera turns on and starts charging. If the camera is turned off, charging stops.
- About 6 hours and 10 minutes are required to charge a fully exhausted battery. Charging time increases when images are transferred while the battery is charging.
- The camera turns off automatically if there is no communication with the computer for 30 minutes after the battery has finished charging.



### When the Power-on Lamp (Charge Lamp) Quickly Flashes Green

Charging cannot be performed, possibly due to one of the reasons described below.

- The ambient temperature is not suited to charging. Charge the battery indoors with an ambient temperature of 5°C to 35°C (41°F to 95°F).
- The USB cable is not connected correctly or the battery is faulty. Make sure the USB cable is connected correctly or replace the battery if necessary.
- The computer is in sleep mode and is not supplying power. Wake up the computer.
- The battery cannot be charged because the computer cannot supply power to the camera due to the computer's settings or its specifications.





## Toggle Av/Tv Selection

Press the **MENU** button →  menu icon → Toggle Av/Tv selection → 

Switch the method for setting the flexible program, shutter speed or aperture value when shooting mode is set to **P, S, A, M** or **U**.

Option	Description
Do not toggle selection (default setting)	Use the command dial to set the flexible program or shutter speed, and the multi selector to set the aperture value.
Toggle selection	Use the multi selector to set the flexible program or shutter speed, and the command dial to set the aperture value.

## Reset File Numbering

Press the **MENU** button →  menu icon → Reset file numbering → 

When **Yes** is selected, the sequential numbering of file numbers is reset ( 115). After resetting, a new folder is created and the file number for the next image captured starts with "0001."

### Notes About Reset File Numbering

**Reset file numbering** cannot be applied when the folder number reaches 999 and there are images in the folder. Insert a new memory card or format the memory card ( 107).

### Folders for Storing Files

Still images and movies shot or recorded with this camera are saved in folders of the memory card.



- Sequential numbers are added to folder names in ascending order, starting with "100" and ending with "999" (the folder names are not displayed on the camera).
- A new folder is created in the following situations:
  - When the number of files in a folder reaches 200
  - When a file in a folder is numbered "9999"
  - When **Reset file numbering** is performed
- A new folder is created each time a series of images are captured using interval timer shooting, and the images are saved in that folder with file numbers starting with "0001."

## Peaking

Press the **MENU** button →  menu icon → Peaking →  button

Option	Description
On (default setting)	When operating <b>MF</b> (manual focus), focusing is assisted by highlighting areas that are in focus in white on the image displayed in the monitor (  42, 43).
Off	Peaking is disabled.

## Reset All

Press the **MENU** button →  menu icon → Reset all →  button

When **Reset** is selected, the camera's settings are restored to their default values.

- Some settings, such as **Time zone and date** or **Language**, are not reset.
- User settings that were saved in **U** of the mode dial are not reset. To reset these settings, use **Reset user settings** ( 35).



### Resetting File Numbering

To reset file numbering to "0001", delete all images saved on the memory card before selecting **Reset all**. **Reset file numbering** can also be used to reset to "0001" ( 109).









## Firmware Version







Press the **MENU** button →  menu icon → Firmware version →  button













View the current camera firmware version.









## Error Messages

Refer to the table below if an error message is displayed.

Display	Cause/Solution	
Battery temperature is elevated. The camera will turn off. The camera will turn off to prevent overheating.	The camera turns off automatically. Wait until the battery has cooled before resuming use.	-
Memory card is write protected.	The write-protect switch is in the "lock" position. Slide the write-protect switch to the "write" position.	-
This card cannot be used.	An error occurred while accessing the memory card.	10,  20
This card cannot be read.	<ul style="list-style-type: none"> <li>• Use an approved memory card.</li> <li>• Check that the terminals are clean.</li> <li>• Confirm that the memory card is correctly inserted.</li> </ul>	
Card is not formatted. Format card?	The memory card has not been formatted for use in the camera. Formatting deletes all data saved on the memory card. If you need to keep copies of any images, make sure to select <b>No</b> and save the copies to a computer or other medium before formatting the memory card. Select <b>Yes</b> and press the  button to format the memory card.	10,  5
Out of memory.	Delete images or insert a new memory card.	10, 23
Image cannot be saved.	An error occurred while saving the image. Insert a new memory card or format the memory card.	10,  107
	The camera has run out of file numbers. Insert a new memory card or format the memory card.	10,  107
Image cannot be modified.	Check that the images can be edited.	 26,  13
Cannot record movie.	A time-out error occurred while saving the movie on the memory card. Select a memory card with a faster write speed.	 20

Display	Cause/Solution	
Cannot reset file numbering.	File numbering cannot be reset because the sequential number of a folder has reached the upper limit. Insert a new memory card or format the memory card.	10,  107
Memory contains no images.	Insert a memory card that contains images.	10
File contains no image data.	The file was not created or edited with this camera. The file cannot be viewed on this camera. View the file using a computer or the device used to create or edit this file.	-
All images are hidden.	<ul style="list-style-type: none"> <li>There are no images available for a slide show, etc.</li> <li>There are no images that can be displayed on the image selection screen for deletion.</li> </ul>	-
This image cannot be deleted.	The image is protected. Disable protection.	 90
Raise the flash.	<ul style="list-style-type: none"> <li>When the scene mode is <b>Scene auto selector</b>, you can capture an image even if the flash is lowered but the flash will not fire.</li> <li>When the scene mode is <b>Night portrait</b> or <b>Backlighting</b> with <b>HDR</b> set to <b>Off</b>, you must raise the flash to capture an image.</li> </ul>	 4   3,  7
Failed to set clock from satellite.	The camera clock was not set correctly. Change the location or time and determine the location again.	-
No A-GPS file found on card.	An A-GPS file that can be updated is not found on the memory card. Check the following items: <ul style="list-style-type: none"> <li>Whether the memory card is inserted</li> <li>Whether the A-GPS file is stored on the memory card</li> <li>Whether the A-GPS file saved on the memory card is more recent than the A-GPS file saved in the camera</li> <li>Whether the A-GPS file is still valid</li> </ul>	-
Update failed.	Unable to update A-GPS file. The A-GPS file may be corrupted. Download the file from the website once more.	 95

Display	Cause/Solution	
Cannot save to card.	A memory card is not inserted. Insert a memory card.	10
	The maximum number of log data events that can be saved per day is 36.	–
	Log has not been obtained.	 43
	The maximum number of log data events that can be saved in one memory card is 100. Replace the memory card with a new one or delete log data that is no longer required from the memory card.	10,  44
No access.	The camera could not receive the communication signal from the smart device. Wirelessly connect the camera and smart device again. <ul style="list-style-type: none"> <li>Press the  button.</li> <li>Touch an NFC-compatible smart device to the camera.</li> <li>Select <b>Connect to smart device</b> in the Wi-Fi options menu.</li> </ul>	 45,  92
Could not connect.	The camera failed to establish the connection while receiving the communication signals from the smart device. Select a different channel for <b>Channel in Options</b> in the Wi-Fi options menu and establish the wireless connection again.	 45,  92
Wi-Fi connection terminated.	The Wi-Fi connection is terminated in the following situations: <ul style="list-style-type: none"> <li>Poor connectivity.</li> <li>The battery level is low.</li> <li>A cable or a memory card is inserted or removed.</li> </ul> Use a fully charged battery, disconnect the TV, computer or printer and establish the wireless connection again.	 45,  92
Lens error. Try again after turning the camera off and on.	If the error persists, contact your retailer or Nikon-authorized service representative.	 7
Communications error	An error occurred while communicating with the printer. Turn the camera off and reconnect the USB cable.	 49
System error	An error occurred in the camera's internal circuitry. Turn the camera off, remove and reinsert the battery, and turn the camera on. If the error persists, contact your retailer or Nikon-authorized service representative.	 7

Display	Cause/Solution	
Printer error: check printer status.	After solving the problem, select <b>Resume</b> and press the  button to resume printing.*	–
Printer error: check paper.	Load the specified size of paper, select <b>Resume</b> , and press the  button to resume printing.*	–
Printer error: paper jam.	Remove the jammed paper, select <b>Resume</b> , and press the  button to resume printing.*	–
Printer error: out of paper.	Load the specified size of paper, select <b>Resume</b> , and press the  button to resume printing.*	–
Printer error: check ink.	There is a problem with the printer's ink. Check the ink, select <b>Resume</b> , and press the  button to resume printing.*	–
Printer error: out of ink.	Replace the ink cartridge, select <b>Resume</b> , and press the  button to resume printing.*	–
Printer error: file corrupt.	There is a problem with the image file to be printed. Select <b>Cancel</b> and press the  button to cancel printing.	–

\* See the documentation provided with your printer for further guidance and information.

## File Names

Images or movies are assigned file names as follows.

### File name: DSCN0001.JPG

(1) (2) (3)

(1) Identifier	<p>Not shown on the screen of the camera.</p> <ul style="list-style-type: none"><li>• DSCN: Original still images, movies, still images created by the movie editing function</li><li>• SSCN: Small picture copies</li><li>• RSCN: Cropped copies</li><li>• FSCN: Images created by an image editing function other than crop and small picture, movies created by the movie editing function</li></ul>
(2) File number	<p>Assigned in ascending order, starting with "0001" and ending with "9999."</p> <ul style="list-style-type: none"><li>• A new folder is created each time a series of images are captured using interval timer shooting, and the images are saved in that folder with file numbers starting with "0001."</li></ul>
(3) Extension	<p>Indicates file format.</p> <ul style="list-style-type: none"><li>• .JPG: Still images</li><li>• .MOV: Movies</li></ul>



### Log Data Saved on Memory Cards

The log data is saved in the "NCFL" folder.

- The file names consist of "N", "date (the last two digits of the year, month, and day in YYMMDD format)", "identification number (0 to 9 or A to Z)" and "extension (.log)".

Example: the first location data log recorded on 15 November 2015 is N1511150.log

- Up to 36 files can be recorded a day and up to 100 files can be recorded on a memory card.

## Optional Accessories

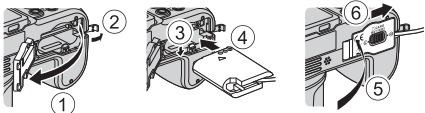
Battery Charger	<b>Battery Charger MH-67P</b> It takes about 3 hours and 20 minutes to charge a fully exhausted battery.
AC Adapter	<b>AC Adapter EH-67A</b> (connect as shown)  Before closing the battery-chamber/memory card slot cover, fully insert the power connector cable into the slot in the battery chamber. If part of the cable protrudes from the slots, the cover or cable may be damaged when the cover is closed.
Remote Control*	<b>Remote Control ML-L3</b>
Filter	<b>67mm screw-on filter (Nikon product)</b>

\* Setting a longer **Auto off** time (🔌 107) is recommended when using the remote control function.

Availability may vary with country or region.  
See our website or brochures for the latest information.



## Shooting with Remote Control ML-L3

Use the Remote Control ML-L3 (available separately) (📷116) to release the shutter. Set **Vibration reduction** (📷104) in the setup menu to **Off** when using a tripod to stabilize the camera.

- 1 Press the multi selector ◀ (📷).

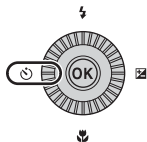

- 2 Select remote control mode and press the **OK** button.

- 📷: Press the transmission button on the remote control to shoot instantly (remote instant shooting).
- 📷 **10s** (10 seconds) and 📷 **2s** (2 seconds): Press the transmission button on the remote control to shoot with the selected seconds delay (self-timer remote control).
- If the **OK** button is not pressed within a few seconds, the selection will be canceled.

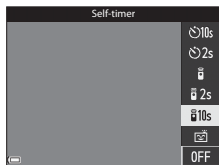

- 3 Frame the picture.

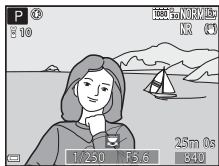

#### 4 Aim the transmitter at the infrared receiver on the front of the camera (📖1) and press the transmission button.

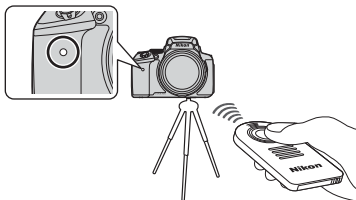

- Press the transmission button from a distance of 5 m (16 ft) or less.
- In the remote instant shooting mode, once the subject is in focus, the shutter is released.
- When the time for self-timer is set to **10s** (10 seconds) or **2s** (2 seconds), the self-timer lamp flashes when the subject is in focus, and then about 1 second before the shutter is released, the lamp stops flashing and remains lit. To stop the self-timer before an image is captured, press the transmission button again.
- In the self-timer remote control mode, the remote control mode is set to **1** (remote instant shooting) when the shutter is released.

### Replacing the Battery for Remote Control ML-L3 (3V CR2025 Lithium Battery)

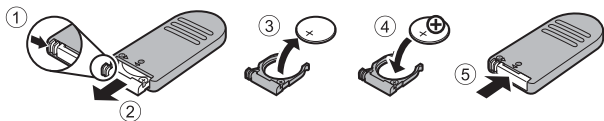











- When changing the remote control battery, make sure that the battery's positive (+) and negative (-) terminals are oriented correctly.
- Make sure to read and follow the warnings of "For Your Safety" (📖vi).











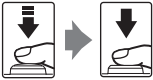

#### ✓ Notes About the Remote Control





- The remote control may not function even from a distance of 5 m (16 ft) or less when shooting in backlit conditions.
- The setting may not be changed when using certain settings of other functions.

# Principle Functions of the Controls



















## For Shooting















Control	Main Function	
 <p>Mode dial</p>	<p>Change the shooting mode.</p>	24
 <p>Zoom control</p>	<p>Move toward <b>T</b> (Q) (telephoto) to zoom in closer to the subject, and move toward <b>W</b> (W) (wide-angle) to zoom out and view a larger area.</p>	20
 <p>Snap-back zoom button</p>	<p>Widen the angle of view temporarily.</p>	21
 <p>Side zoom control</p>	<p>Use the function assigned in <b>Assign side zoom control</b>.</p> <ul style="list-style-type: none"> <li>• Zoom: Move toward <b>T</b> (Q) (telephoto) to zoom in closer to the subject, and move toward <b>W</b> (W) (wide-angle) to zoom out and view a larger area.</li> <li>• Manual focus: When the focus mode is set to <b>MF</b> (manual focus), adjust the focus.</li> </ul>	20, 57 41, 42
 <p>Multi selector</p>	<ul style="list-style-type: none"> <li>• While the shooting screen is displayed: Display the following setting screens by pressing: <ul style="list-style-type: none"> <li>- Up (▲):  (flash mode)</li> <li>- Left (◀):  (self-timer/remote control/smile timer)</li> <li>- Down (▼):  (focus mode)</li> <li>- Right (▶):  (exposure compensation)</li> </ul> </li> <li>• When the shooting mode is <b>A</b> or <b>M</b>: Rotate the multi selector to set the aperture value.</li> <li>• While the setting screen is displayed: Select an item using ▲▼◀▶ or by rotating the multi selector; apply the selection by pressing the <b>OK</b> button.</li> </ul>	25 30, 32 50





Control	Main Function	
 <p>Command dial</p>	<ul style="list-style-type: none"> <li>• When the shooting mode is <b>P</b>: Set the flexible program.</li> <li>• When the shooting mode is <b>S</b> or <b>M</b>: Set the shutter speed.</li> </ul>	30, 32 30, 32
 <p>MENU (menu) button</p>	Display and hide the menu.	49, 51, 54, 55, 57
 <p>Shutter-release button</p>	<p>When pressed halfway (i.e., if you stop pressing when you feel resistance slightly): Set focus and exposure.</p> <p>When pressed all the way (i.e., if you press the button all the way down): Release the shutter.</p>	17, 21
 <p>movie-record button</p>	Start and stop movie recording.	 32
 <p>Fn (function) button</p>	<p>When the shooting mode is <b>P</b>, <b>S</b>, <b>A</b>, <b>M</b> or <b>U</b>: Display or close the setting menus such as <b>Continuous</b> or <b>Vibration reduction</b>.</p>	45
 <p> (monitor) button</p>	Switch between the monitor and viewfinder.	19
 <p>DISP (display) button</p>	Switch the information displayed in the monitor.	3
 <p> (Wi-Fi) button</p>	Turn on the Wi-Fi function and connect the camera and a smart device.	60,  45

Control	Main Function	
  (playback) button	Play back images.	22
  (delete) button	Delete the last image that was saved.	23

## For Playback

Control	Main Function	
  (playback) button	<ul style="list-style-type: none"> <li>When the camera is turned off, press and hold this button to turn the camera on in playback mode.</li> <li>Return to shooting mode.</li> </ul>	22 22
 Zoom control	<ul style="list-style-type: none"> <li>Move toward <b>T</b> () to zoom in on the image, and move toward <b>W</b> () to display images as thumbnails or the calendar.</li> <li>Adjust the volume for movie playback.</li> </ul>	 23,  24   36
 Multi selector	<ul style="list-style-type: none"> <li>While the playback screen is displayed: Change the displayed image using up () left () down () right () or by rotating the multi selector.</li> <li>While the setting screen is displayed: Select an item using  or by rotating the multi selector.</li> <li>While an enlarged image is displayed: Move the display area.</li> </ul>	22 50  23

Control	Main Function	
 OK (apply selection) button	<ul style="list-style-type: none"> <li>• Display individual images of a sequence in full-frame playback mode.</li> <li>• Scroll an image shot with Easy panorama.</li> <li>• Play back movies.</li> <li>• Switch from thumbnail playback or zoomed image display to full-frame playback.</li> <li>• While the setting screen is displayed, apply the selection.</li> </ul>	56,  25  12  32  23,  24  50
 Command dial	Switch the magnification of an enlarged image.	 23
 MENU (menu) button	Display and hide the menu.	49, 55
 (delete) button	Delete images.	23
 (monitor) button	Switch between the monitor and viewfinder.	19
 DISP (display) button	Switch the information displayed in the monitor.	3
 (Wi-Fi) button	Turn on the Wi-Fi function and connect the camera and a smart device.	60,  45

Control	Main Function	
 Shutter-release button	Return to shooting mode.	-
  (movie-record) button		



A series of horizontal dashed lines spanning the width of the page, intended for handwriting practice. There are 15 lines in total, starting from the first line below the pen illustration and extending to the bottom of the page.





# Technical Notes and Index

<b>Caring for the Product</b> .....	2
The Camera.....	2
The Battery.....	3
The Charging AC Adapter .....	4
Memory Cards.....	5
<b>Cleaning and Storage</b> .....	6
Cleaning.....	6
Storage .....	6
<b>Troubleshooting</b> .....	7
<b>Specifications</b> .....	16
Approved Memory Cards .....	20
<b>USER LICENSE AGREEMENT FOR LOCATION NAME DATA</b> .....	22
<b>Index</b> .....	28

## Caring for the Product

Observe the precautions described below in addition to the warnings in “For Your Safety” (☞vi-viii) when using or storing the device.

### The Camera

#### Do Not Apply Strong Impact to the Camera

The product may malfunction if subjected to strong shock or vibration. In addition, do not touch or apply force to the lens or lens cover.

#### Keep Dry

The device will be damaged if immersed in water or subjected to high humidity.

#### Avoid Sudden Changes in Temperature

Sudden changes in temperature, such as when entering or leaving a heated building on a cold day, can cause condensation to form inside the device. To prevent condensation, place the device in a carrying case or a plastic bag before exposing it to sudden changes in temperature.

#### Keep Away from Strong Magnetic Fields

Do not use or store this device in the vicinity of equipment that generates strong electromagnetic radiation or magnetic fields. Doing so could result in loss of data or camera malfunction.

#### Do Not Point the Lens at Strong Light Sources for Extended Periods

Avoid pointing the lens at the sun or other strong light sources for extended periods when using or storing the camera. Intense light may cause the image sensor to deteriorate or produce a white blur effect in photographs.

#### Turn the Product Off Before Removing or Disconnecting the Power Source or Memory Card

Do not remove the battery while the product is on, or while images are being saved or deleted. Forcibly cutting power in these circumstances could result in loss of data or in damage to product memory or internal circuitry.

## Notes About the Monitor

- Monitors and electronic viewfinders are constructed with extremely high precision; at least 99.99% of pixels are effective, with no more than 0.01% being missing or defective. Hence while these displays may contain pixels that are always lit (white, red, blue, or green) or always off (black), this is not a malfunction and has no effect on images recorded with the device.
- Images in the monitor may be difficult to see under bright lighting.
- Do not apply pressure to the monitor, as this could cause damage or malfunction. Should the monitor break, care should be taken to avoid injury caused by broken glass and to prevent the liquid crystal from the display touching the skin or entering the eyes or mouth.

## Do not Attach a Commercially Available Step-up Ring, Etc. to the Lens

Attaching accessories other than the provided lens cap or the Nikon 67mm screw-on filter could cause a malfunction.

## The Battery

### Precautions for Use

- Note that the battery may become hot after use.
- Do not use the battery at ambient temperatures below 0°C (32°F) or above 40°C (104°F) as this could cause damage or malfunction.
- If you notice any abnormalities such as excessive heat, smoke, or an unusual smell coming from the battery, immediately discontinue use and consult your retailer or Nikon-authorized service representative.
- After removing the battery from the camera or optional battery charger, put the battery in a plastic bag, etc. in order to insulate it.

### Charging the Battery

Check the battery level before using the camera and replace or charge the battery if necessary.

- Charge the battery indoors with an ambient temperature of 5°C to 35°C (41°F to 95°F) before use.
- A high battery temperature may prevent the battery from charging properly or completely, and may reduce battery performance. Note that the battery may become hot after use; wait for the battery to cool before charging. When charging the battery inserted into this camera using the Charging AC Adapter or a computer, the battery is not charged at battery temperatures below 0°C (32°F) or above 50°C (122°F).
- Do not continue charging once the battery is fully charged as this will result in reduced battery performance.
- The battery temperature may increase during charging. However, this is not a malfunction.

### Carrying Spare Batteries

Whenever possible, carry fully charged spare batteries when taking pictures on important occasions.

## Using the Battery When Cold

On cold days, the capacity of batteries tends to decrease. If an exhausted battery is used at a low temperature, the camera may not turn on. Keep spare batteries in a warm place and exchange as necessary. Once warmed, a cold battery may recover some of its charge.

## Battery Terminals

Dirt on the battery terminals may prevent the camera from functioning. Should the battery terminals become dirty, wipe them off with a clean, dry cloth before use.

## Charging an Exhausted Battery

Turning the camera on or off while an exhausted battery is inserted in the camera may result in reduced battery life. Charge the exhausted battery before use.

## Storing the Battery

- Always remove the battery from the camera or optional battery charger when it is not being used. Minute amounts of current are drawn from the battery while it is in the camera, even when not in use. This may result in excessive battery drain and complete loss of function.
- Recharge the battery at least once every six months and completely exhaust it before returning it to storage.
- Put the battery in a plastic bag, etc. in order to insulate it and store it in a cool place. The battery should be stored in a dry location with an ambient temperature of 15°C to 25°C (59°F to 77°F). Do not store the battery in hot or extremely cold locations.

## Battery Life

A marked drop in the time a fully charged battery retains its charge, when used at room temperature, indicates that the battery needs to be replaced. Purchase a new battery.

## Recycling Used Batteries

Replace the battery when it no longer holds a charge. Used batteries are a valuable resource. Please recycle used batteries in accordance with local regulations.

## The Charging AC Adapter

- The Charging AC Adapter EH-71P is for use only with compatible devices. Do not use with another make or model of device.
- Do not use any USB cable other than the UC-E21. Using a USB cable other than the UC-E21 could result in overheating, fire or electric shock.
- Do not, under any circumstances, use another make or model of AC adapter other than Charging AC Adapter EH-71P, and do not use a commercially available USB-AC adapter or a battery charger for a mobile phone. Failure to observe this precaution could result in overheating or in damage to the camera.
- The EH-71P is compatible with AC 100–240 V, 50/60 Hz electrical outlets. When using in other countries, use a plug adapter (commercially available) as necessary. For more information about plug adapters, consult your travel agency.

# Memory Cards

## Precautions for Use

- Use only Secure Digital memory cards. See “Approved Memory Cards” (🔦:20) for recommended memory cards.
- Be sure to follow the precautions described in the documentation included with the memory card.
- Do not put labels or stickers on memory cards.

## Formatting

- Do not format the memory card using a computer.
- The first time you insert a memory card that has been used in another device into this camera, be sure to format it with this camera. We recommend formatting new memory cards with this camera before using them with this camera.
- **Note that formatting a memory card permanently deletes all images and other data on the memory card.** Be sure to make copies of any images you wish to keep before formatting the memory card.
- If the message **Card is not formatted. Format card?** is displayed when the camera is turned on, the memory card must be formatted. If there is data that you do not want to delete, select **No**. Copy the necessary data to a computer, etc. If you want to format the memory card, select **Yes**. The confirmation dialog will be displayed. To start formatting, press the **OK** button.
- Do not perform the following during formatting, while data is being written to or deleted from the memory card, or during data transfer to a computer. Failure to observe this precaution could result in the loss of data or in damage to the camera or memory card:
  - Open the battery-chamber/memory card slot cover to remove/insert the battery or memory card.
  - Turn off the camera.
  - Disconnect the AC adapter.

# Cleaning and Storage

## Cleaning

Do not use alcohol, thinner, or other volatile chemicals.

Lens/ viewfinder	Avoid touching glass parts with your fingers. Remove dust or lint with a blower (typically a small device with a rubber bulb attached to one end that is pumped to produce a stream of air out the other end). To remove fingerprints or other stains that cannot be removed with a blower, wipe the lens with a soft cloth, using a spiral motion that starts at the center of the lens and working toward the edges. If this fails, clean the lens using a cloth lightly dampened with commercial lens cleaner.
Monitor	Remove dust or lint with a blower. To remove fingerprints and other stains, clean the monitor with a soft, dry cloth, being careful not to apply pressure.
Body	Use a blower to remove dust, dirt, or sand, then wipe gently with a soft, dry cloth. After using the camera at the beach or other sandy or dusty environment, wipe off any sand, dust, or salt with a dry cloth lightly dampened with fresh water and dry thoroughly. <b>Note that foreign matter inside the camera could cause damage not covered by the warranty.</b>

## Storage

Remove the battery if the camera will not be used for an extended period. To prevent mold or mildew, take the camera out of storage at least once a month.

Turn the camera on and release the shutter a few times before putting the camera away again. Do not store the camera in any of the following locations:





- Places that are poorly ventilated or subject to humidity of over 60%
- Exposed to temperatures above 50°C (122°F) or below -10°C (14°F)
- Next to equipment that produces strong electromagnetic fields, such as televisions or radios





For storing the battery, follow the precautions in “The Battery” (🔋:3) in “Caring for the Product” (🔧:2).

# Troubleshooting



If the camera fails to function as expected, check the list of common problems below before consulting your retailer or Nikon-authorized service representative.

## Power, Display, Settings Issues







Problem	Cause/Solution	
The camera is on but does not respond.	<ul style="list-style-type: none"> <li>• Wait for recording to end.</li> <li>• If the problem persists, turn the camera off. If the camera does not turn off, remove and reinsert the battery or batteries or, if you are using an AC adapter, disconnect and reconnect the AC adapter. Note that although any data currently being recorded will be lost, data that have already been recorded will not be affected by removing or disconnecting the power source.</li> </ul>	-
The camera cannot be turned on.	The battery is exhausted.	10, 11, 
The camera turns off without warning.	<ul style="list-style-type: none"> <li>• The camera automatically turns off to save power (auto off function).</li> <li>• The camera and battery may not work properly at low temperatures.</li> <li>• The inside of the camera has become hot. Leave the camera off until the inside of the camera has cooled, and then try turning it on again.</li> </ul>	18  -
The monitor or viewfinder is blank.	<ul style="list-style-type: none"> <li>• The camera is off.</li> <li>• The battery is exhausted.</li> <li>• The camera automatically turns off to save power (auto off function).</li> <li>• You cannot turn on both the monitor and viewfinder at the same time. It may take a while to switch between the monitor and viewfinder.</li> <li>• The camera is connected to a TV or computer.</li> <li>• Interval timer shooting or time-lapse movie shooting is in progress.</li> <li>• The camera and smart device are connected using Wi-Fi connection and the camera is operated by remote control.</li> </ul>	14 16 18 - -  13,  69 -









Problem	Cause/Solution	
The camera becomes hot.	The camera may become hot when used for an extended period of time such as to shoot movies, or when used in a hot environment; this is not a malfunction.	-
The battery inserted in the camera cannot be charged.	<ul style="list-style-type: none"> <li>• Confirm all connections.</li> <li>• When connected to a computer, the camera may not charge for any of the reasons described below.                             <ul style="list-style-type: none"> <li>- <b>Off</b> is selected for <b>Charge by computer</b> in the setup menu.</li> <li>- Battery charging stops if the camera is turned off.</li> <li>- Battery charging is not possible if the camera's display language and date and time have not been set, or the date and time were reset after the camera's clock battery was exhausted. Use the charging AC adapter to charge the battery.</li> <li>- Battery charging may stop when the computer enters sleep mode.</li> <li>- Depending on the computer specifications, settings, and status, battery charging may not be possible.</li> </ul> </li> </ul>	11 49, 58 - 14, 15 - -
The monitor is hard to read.	<ul style="list-style-type: none"> <li>• The ambient light is too bright. Move to a darker place or use the viewfinder.</li> <li>• Adjust the monitor brightness.</li> <li>• The monitor is dirty. Clean the monitor.</li> </ul>	19 49, 57  6
Image in the viewfinder is difficult to see.	Adjust the viewfinder using the diopter adjustment control.	19
 flashes on the screen.	<ul style="list-style-type: none"> <li>• If the camera clock has not been set,  flashes on the shooting screen, and images and movies saved before the clock is set are dated "00/00/0000 00:00" and "01/01/2015 00:00" respectively. Set the correct time and date for <b>Time zone and date</b> in the setup menu.</li> </ul>	5, 57
Date and time of recording are not correct.	<ul style="list-style-type: none"> <li>• The camera clock is not as accurate as ordinary watches or clocks. Periodically compare the time of the camera clock with that of a more accurate timepiece and reset as required.</li> </ul>	
No information displayed in monitor.	Shooting and photo information may be hidden. Press the <b>DISP</b> button until information is displayed.	3
<b>Date stamp</b> not available.	<b>Time zone and date</b> has not been set in the setup menu.	49, 57



















Problem	Cause/Solution	
Date not stamped on images even when <b>Date stamp</b> is enabled.	<ul style="list-style-type: none"> <li>The current shooting mode does not support <b>Date stamp</b>.</li> <li>A function that restricts the Date stamp function is enabled.</li> <li>The date cannot be stamped on movies.</li> </ul>	49, 57 46 –
Screen for setting time zone and date is displayed when the camera is turned on.	The clock battery is exhausted; all settings were restored to their default values.	15,  :8
The camera settings reset.		
<b>Reset file numbering</b> cannot be done.	Although a new folder is created on the memory card by resetting file numbering, etc., if the sequential number of a folder name (which is not displayed on the camera) reaches the upper limit ("999"), reset is not possible. Change the memory card, or format the memory card.	49, 58,  109
The camera makes sound.	When <b>Autofocus mode</b> is set to <b>Full-time AF</b> or while in some shooting modes, the camera may produce an audible focusing sound.	24, 49, 52, 54

## Shooting Issues





Problem	Cause/Solution	
Cannot switch to shooting mode.	Disconnect the HDMI cable or USB cable.	61
Cannot take pictures or record movies.	<ul style="list-style-type: none"> <li>When the camera is in playback mode, press the  button, shutter-release button or  button.</li> <li>When menus are displayed, press the <b>MENU</b> button.</li> <li>When the scene mode is <b>Night portrait</b> or <b>Backlighting</b> with <b>HDR</b> set to <b>Off</b>, raise the flash.</li> <li>The flash is charging while  is flashing.</li> <li>The battery is exhausted.</li> <li>Insert a memory card with sufficient free space.</li> </ul>	1, 22 50 18,  3,  7 36 10, 11,  :3 –

Problem	Cause/Solution	
The camera cannot focus.	<ul style="list-style-type: none"> <li>The subject is too close. Try shooting using the <b>Scene auto selector</b> or <b>Close-up</b> scene mode, or the macro close-up focus mode.</li> <li>Incorrect focus mode setting. Check or change the setting.</li> <li>The subject is hard to focus on.</li> <li>Set <b>AF assist</b> in the setup menu to <b>Auto</b>.</li> <li>Subject is not in focus area when the shutter-release button is pressed halfway.</li> <li>The focus mode is set to <b>MF</b> (manual focus).</li> <li>Turn the camera off and then on again.</li> </ul>	24, 25, 40,  4,  5 40, 41   20 49, 57 17, 49, 52 40, 42 –
Colored stripes appear in the monitor when shooting.	Colored stripes may appear when shooting subjects with repeating patterns (such as window blinds); this is not a malfunction. The colored stripes will not appear in captured images or recorded movies. However, when using <b>Continuous H: 120 fps</b> or <b>HS 480/4x</b> , the colored stripes may be seen in the captured images and recorded movies.	–
Images are blurred.	<ul style="list-style-type: none"> <li>Use the flash.</li> <li>Enable vibration reduction.</li> <li>Use <b>BSS</b> (Best Shot Selector) of <b>Continuous</b>.</li> <li>Use a tripod to stabilize the camera (using the self-timer at the same time is more effective).</li> </ul>	18, 36 49, 57 49, 52,  6 38
Bright specks appear in images captured with flash.	Flash is reflecting off particles in air. Lower the flash, and set the flash mode to  (off).	36
Flash does not fire.	<ul style="list-style-type: none"> <li>A shooting mode where the flash cannot fire is selected.</li> <li>A function that restricts the flash is enabled.</li> </ul>	 15 46
Digital zoom cannot be used.	<ul style="list-style-type: none"> <li><b>Digital zoom</b> is set to <b>Off</b> in the setup menu.</li> <li>Digital zoom cannot be used with certain shooting modes or when using certain settings in other functions.</li> </ul>	49, 57 48, 57
<b>Image size</b> not available.	<ul style="list-style-type: none"> <li>A function that restricts the <b>Image size</b> option is enabled.</li> <li>When the scene mode is set to <b>Easy panorama</b>, the image size is fixed.</li> </ul>	46   10

Problem	Cause/Solution	
No sound when the shutter is released.	<b>Off</b> is selected for <b>Shutter sound</b> in <b>Sound settings</b> in the setup menu. No sound is produced with some shooting modes and settings, even when <b>On</b> is selected.	46, 49, 57
AF-assist illuminator does not light.	<b>Off</b> is selected for the <b>AF assist</b> option in the setup menu. AF-assist illuminator may not light depending on the position of the focus area or the current scene mode, even when <b>Auto</b> is selected.	49, 57
Images appear smeared.	The lens is dirty. Clean the lens.	 6
Colors are unnatural.	White balance or hue is not adjusted properly.	49, 51,  6
Randomly spaced bright pixels ("noise") appear in image.	The subject is dark and the shutter speed is too slow or ISO sensitivity is too high. Noise can be reduced by: <ul style="list-style-type: none"> <li>Using the flash</li> <li>Specifying a lower ISO sensitivity setting</li> </ul>	18, 36 49, 52
Bright spots appear in image.	When shooting at a slow shutter speed in multiple exposure mode, noise (bright spots) may appear in saved images.	–
Images are too dark (underexposed).	<ul style="list-style-type: none"> <li>The flash window is blocked.</li> <li>The subject is beyond the range of the flash.</li> <li>Adjust exposure compensation.</li> <li>Increase ISO sensitivity.</li> <li>The subject is backlit. Raise the flash, or set the scene mode to <b>Backlighting</b> with <b>HDR</b> set to <b>Off</b>.</li> </ul>	16  17 44 49, 52 18,  7
Images are too bright (overexposed).	Adjust exposure compensation.	44
Unexpected results when flash set to  (auto with red-eye reduction).	Use any scene mode other than <b>Night portrait</b> , and change the flash mode to any setting other than  (auto with red-eye reduction/red-eye reduction) and try taking the picture again.	36,  15
Skin tones are not softened.	<ul style="list-style-type: none"> <li>In some shooting conditions, facial skin tones may not be softened.</li> <li>For images containing 4 or more faces, try using <b>Skin softening</b> in the playback menu.</li> </ul>	 20 49, 55







Problem	Cause/Solution	
Saving images takes time.	<p>It may take more time to save images in the following situations:</p> <ul style="list-style-type: none"> <li>• When the noise reduction function is in operation</li> <li>• When the flash mode is set to  (auto with red-eye reduction/red-eye reduction)</li> <li>• When capturing images in the following scene modes. <ul style="list-style-type: none"> <li>- <b>Hand-held in Night landscape</b>  3</li> <li>- <b>Noise reduction burst in Landscape or Close-up</b>  4,  5</li> <li>- <b>Backlighting</b> (when <b>HDR</b> is set to <b>On</b>)  7</li> <li>- <b>Easy panorama</b>  10</li> </ul> </li> <li>• <b>Continuous</b> in the shooting menu is set to <b>Continuous H: 120 fps</b> or <b>Continuous H: 60 fps</b> 49, 52</li> <li>• When using smile timer while shooting 39</li> <li>• When using Active D-Lighting while shooting 49, 52</li> <li>• When using multiple exposure while shooting 49, 52</li> </ul>	<p>–</p> <p>37</p>
A ring-shaped belt or rainbow-colored stripe appears in the monitor or images.	<p>When shooting with backlighting or when a very strong light source (such as sunlight) is in the frame, a ring-shaped belt or rainbow-colored stripe (ghosting) may occur.</p> <p>Change the position of the light source, or frame the picture so that the light source does not enter the frame, and try again.</p>	<p>–</p>
Cannot select a setting/Selected setting is disabled.	<ul style="list-style-type: none"> <li>• Certain menu items are unavailable depending on the shooting mode. Menu items that cannot be selected are displayed in gray.</li> <li>• A function that restricts the selected function is enabled.</li> </ul>	<p>49</p> <p>–</p>







## Playback Issues

Problem	Cause/Solution	
File cannot be played back.	<ul style="list-style-type: none"> <li>• This camera may not be able to play back images saved with another make or model of digital camera.</li> <li>• This camera may not be able to play back data edited on a computer.</li> <li>• Files cannot be played back during interval timer shooting.</li> </ul>	<p style="text-align: center;">–</p> <p style="text-align: center;">–</p> <p style="text-align: center;">49, 52</p>
Cannot zoom in on image.	<ul style="list-style-type: none"> <li>• Playback zoom cannot be used with movies.</li> <li>• This camera may not be able to zoom in on images captured with another make or model of digital camera.</li> <li>• When zooming in on a small-sized image, the magnification rate shown on the screen may differ from the actual magnification rate of the image.</li> </ul>	<p style="text-align: center;">–</p>
Cannot edit image.	<ul style="list-style-type: none"> <li>• Some images cannot be edited. Images that have already been edited may not be edited again.</li> <li>• There is not enough free space on the memory card.</li> <li>• This camera is unable to edit images captured with other cameras.</li> <li>• Editing functions used for images are not available for movies.</li> </ul>	<p style="text-align: center;"> 12,</p> <p style="text-align: center;"> 26</p> <p style="text-align: center;">–</p> <p style="text-align: center;">–</p> <p style="text-align: center;">–</p>
Cannot rotate image.	This camera cannot rotate images captured with another make or model of digital camera.	<p style="text-align: center;">–</p>
Images are not displayed on TV.	<ul style="list-style-type: none"> <li>• A computer or printer is connected to the camera.</li> <li>• The memory card contains no images.</li> </ul>	<p style="text-align: center;">–</p>
Nikon Transfer 2 does not start when the camera is connected to a computer.	<ul style="list-style-type: none"> <li>• The camera is off.</li> <li>• The battery is exhausted.</li> <li>• The USB cable is not correctly connected.</li> <li>• The camera is not recognized by the computer.</li> <li>• The computer is not set to start Nikon Transfer 2 automatically. For more information about Nikon Transfer 2, refer to help information contained in ViewNX-i.</li> </ul>	<p style="text-align: center;">–</p> <p style="text-align: center;">49, 58,</p> <p style="text-align: center;">61</p> <p style="text-align: center;">61,</p> <p style="text-align: center;"> 53</p> <p style="text-align: center;">–</p> <p style="text-align: center;">–</p>
The PictBridge screen is not displayed when the camera is connected to a printer.	With some PictBridge-compatible printers, the PictBridge startup screen may not be displayed and it may be impossible to print images when <b>Auto</b> is selected for <b>Charge by computer</b> in the setup menu. Set <b>Charge by computer</b> to <b>Off</b> and reconnect the camera to the printer.	<p style="text-align: center;">49, 58</p>

Problem	Cause/Solution	
Images to be printed are not displayed.	The memory card contains no images.	-
Cannot select paper size with the camera.	<p>The camera cannot be used to select the paper size in the following situations, even when printing from a PictBridge-compatible printer. Use the printer to select the paper size.</p> <ul style="list-style-type: none"> <li>• The printer does not support the paper sizes specified by the camera.</li> <li>• The printer automatically selects the paper size.</li> </ul>	-

## Location Data Functions

Problem	Cause/Solution	
Unable to identify the location or it takes time to identify the location.	<ul style="list-style-type: none"> <li>• The camera may not be able to identify the location in some shooting environments. To use the location data functions, use the camera as much as possible in an open-air area.</li> <li>• When positioning for the first time or when positioning was unable to be performed for about two hours, it takes a few minutes to obtain the location data.</li> </ul>	 40   40
Unable to record location data on shot images.	When  or  is displayed on the shooting screen, the location data is not recorded. Before shooting images, check the location data reception.	59
Difference between the actual shooting location and recorded location data.	The acquired location data may deviate in some shooting environments. When there is a significant difference in the signals from the positioning satellites, there could be a deviation of up to several hundred meters.	 40
The recorded location name is different from the intended one or is not displayed.	The desired landmark name may not be registered, or a different landmark name may be registered.	-

Problem	Cause/Solution	
Unable to update the A-GPS file.	<ul style="list-style-type: none"> <li>• Check the following items.               <ul style="list-style-type: none"> <li>- Whether the memory card is inserted</li> <li>- Whether the A-GPS file is stored on the memory card</li> <li>- Whether the A-GPS file saved on the memory card is more recent than the A-GPS file saved in the camera</li> <li>- Whether the A-GPS file is still valid</li> </ul> </li> <li>• The A-GPS file may be corrupted. Download the file from the website once more.</li> </ul>	<p style="text-align: center;">-</p> <p style="text-align: right;">95</p>
Unable to select <b>Create log</b> in the location data options menu.	<p>Clock not set. Set date and time.</p>	<p style="text-align: right;">49, 57</p>
Unable to select <b>Start log</b> .	<ul style="list-style-type: none"> <li>• <b>Record location data</b> in the location data options menu is set to <b>Off</b>.</li> <li>• The camera is recording log data. To record a new log, select <b>End log</b>, and end the log currently being recorded.</li> </ul>	<p style="text-align: right;">39</p> <p style="text-align: right;">49, 44</p>
Unable to save log data.	<ul style="list-style-type: none"> <li>• Make sure that a memory card is inserted in the camera.</li> <li>• Up to 36 log data events can be recorded per day.</li> <li>• Log has not been obtained.</li> <li>• The total number of log data events that can be saved on a single memory card is up to 100. Delete log data that is no longer required from the memory card or replace the memory card with a new one.</li> </ul>	<p style="text-align: center;">-</p> <p style="text-align: center;">-</p> <p style="text-align: right;">43</p> <p style="text-align: right;">49, 44</p>

# Specifications

## Nikon COOLPIX P900 Digital Camera

Type	Compact digital camera
Number of effective pixels	16.0 million (Image processing may reduce the number of effective pixels.)
Image sensor	1/2.3-in. type CMOS; approx. 16.76 million total pixels
Lens	NIKKOR lens with 83× optical zoom
Focal length	4.3–357 mm (angle of view equivalent to that of 24–2000 mm lens in 35mm [135] format)
f/-number	f/2.8–6.5
Construction	16 elements in 12 groups (5 ED lens elements and 1 super ED lens element)
Digital zoom magnification	Up to 4× (angle of view equivalent to that of approx. 8000 mm lens in 35mm [135] format)
Vibration reduction	Lens shift (still images) Combination of lens shift and electronic VR (movies)
Autofocus (AF)	Contrast-detect AF
Focus range	<ul style="list-style-type: none"><li>• [W]: Approx. 50 cm (1 ft 8 in.)–∞, [T]: Approx. 5.0 m (16 ft 5 in.)–∞</li><li>• Macro close-up mode: Approx. 1 cm (0.4 in.)–∞ (wide-angle position)</li></ul> (All distances measured from center of front surface of lens)
Focus-area selection	Target finding AF, face priority, manual (spot), manual (normal), manual (wide), subject tracking
Viewfinder	Electronic viewfinder, 0.5 cm (0.2-in.) approx. 921k-dot LCD with the diopter adjustment function (–3 – +1 m <sup>-1</sup> )
Frame coverage (shooting mode)	Approx. 100% horizontal and vertical (compared to actual picture)
Frame coverage (playback mode)	Approx. 100% horizontal and vertical (compared to actual picture)
Monitor	7.5 cm (3-in.), approx. 921k-dot (RGBW), wide viewing angle TFT LCD with anti-reflection coating and 6-level brightness adjustment, vari-angle TFT LCD
Frame coverage (shooting mode)	Approx. 100% horizontal and vertical (compared to actual picture)
Frame coverage (playback mode)	Approx. 100% horizontal and vertical (compared to actual picture)



<b>Storage</b>		
Media		SD/SDHC/SDXC memory card
File system		DCF and Exif 2.3 compliant
File formats		Still images: JPEG Movies: MOV (Video: H.264/MPEG-4 AVC, Audio: LPCM stereo)
Image size (pixels)		<ul style="list-style-type: none"> <li>• 16 M <b>4608×3456</b></li> <li>• 8 M <b>3264×2448</b></li> <li>• 4 M <b>2272×1704</b></li> <li>• 2 M <b>1600×1200</b></li> <li>• VGA <b>640×480</b></li> <li>• 16:9 12 M <b>4608×2592</b></li> <li>• 16:9 2 M <b>1920×1080</b></li> <li>• 3:2 14 M <b>4608×3072</b></li> <li>• 1:1 12 M <b>3456×3456</b></li> </ul>
ISO sensitivity (Standard output sensitivity)		<ul style="list-style-type: none"> <li>• ISO 100–1600</li> <li>• ISO 3200, 6400 (available when using <b>P, S, A</b> or <b>M</b> mode)</li> <li>• Hi 1 (equivalent to ISO 12800) (available when using <b>High ISO monochrome</b> in special effects mode)</li> </ul>
<b>Exposure</b>		
Metering mode		Matrix, center-weighted, spot
Exposure control		Programmed auto exposure with flexible program, shutter-priority auto, aperture-priority auto, manual, exposure bracketing, exposure compensation (–2.0 EV – +2.0 EV in steps of 1/3 EV)
<b>Shutter</b>		
Speed		Mechanical and CMOS electronic shutter <ul style="list-style-type: none"> <li>• 1/4000*–1 s</li> <li>• 1/4000*–15 s (when ISO sensitivity is 100 in <b>M</b> mode)</li> </ul> * When the aperture value is set to f/8 (wide-angle position)
<b>Aperture</b>		
Range		Electronically-controlled 6-blade iris diaphragm 10 steps of 1/3 EV (W) ( <b>A, M</b> mode)
<b>Self-timer</b>		Can be selected from 10 s and 2 s
<b>Flash</b>		
Range (approx.) (ISO sensitivity: Auto)		[W]: Approx. 0.5–11.5 m (1 ft 8 in.–37 ft) [T]: Approx. 5.0–7.0 m (16 ft 5 in.–22 ft)
Flash control		TTL auto flash with monitor preflashes
Flash exposure compensation		In steps of 1/3 EV in the range between –2 and +2 EV

<b>Interface</b>	
USB connector	Micro-USB connector (Do not use any USB cable other than the UC-E21.), Hi-Speed USB <ul style="list-style-type: none"> <li>• Supports Direct Print (PictBridge)</li> </ul>
HDMI output connector	HDMI micro connector (Type D)
<b>Wireless LAN</b>	
Standards	IEEE 802.11 b/g/n (standard wireless LAN protocol)
Range (line of sight)	Approx. 10 m (10 yd)
Operating frequency	2412–2462 MHz (1–11 channels)
Authentication	Open system, WPA2-PSK
Access protocols	Infrastructure <ul style="list-style-type: none"> <li>• <b>GPS</b> Receiving frequency: 1575.42 MHz Geodetic system: WGS 84</li> <li>• <b>GLONASS</b> Receiving frequency: 1598.0625 MHz–1605.3750 MHz Geodetic system: WGS 84</li> </ul>
<b>Location data</b>	
<b>Supported languages</b>	
Arabic, Bengali, Bulgarian, Chinese (Simplified and Traditional), Czech, Danish, Dutch, English, Finnish, French, German, Greek, Hindi, Hungarian, Indonesian, Italian, Japanese, Korean, Marathi, Norwegian, Persian, Polish, Portuguese (European and Brazilian), Romanian, Russian, Serbian, Spanish, Swedish, Tamil, Telugu, Thai, Turkish, Ukrainian, Vietnamese	
<b>Power sources</b>	
One Rechargeable Li-ion Battery EN-EL23 (included) AC Adapter EH-67A (available separately)	
<b>Charging time</b>	
Approx. 3 h 40 min (when using Charging AC Adapter EH-71P and when no charge remains)	
<b>Battery life<sup>1</sup></b>	
Still images	Approx. 360 shots when using EN-EL23
Movie recording (actual battery life for recording) <sup>2</sup>	Approx. 1 h 20 min when using EN-EL23
<b>Tripod socket</b>	
1/4 (ISO 1222)	

<b>Dimensions (W × H × D)</b>	Approx. 139.5 × 103.2 × 137.4 mm (5.5 × 4.1 × 5.5 in.) (excluding projections)
<b>Weight</b>	Approx. 899 g (1 lb 15.8 oz) (including battery and memory card)
<b>Operating environment</b>	
<b>Temperature</b>	0°C–40°C (32°F–104°F)
<b>Humidity</b>	85% or less (no condensation)

- Unless otherwise stated, all figures assume a fully-charged battery and an ambient temperature of 23 ±3°C (73.4 ±5.4°F) as specified by the Camera and Imaging Products Association (CIPA).
- <sup>1</sup> Battery life may vary depending on conditions of use, such as the interval between shots or the length of time that menus and images are displayed.
  - <sup>2</sup> Individual movie files cannot exceed 4 GB in size or 29 minutes in length. Recording may end before this limit is reached if camera temperature becomes elevated.

## Rechargeable Li-ion Battery EN-EL23

<b>Type</b>	Rechargeable lithium-ion battery
<b>Rated capacity</b>	DC 3.8 V, 1850 mAh
<b>Operating temperature</b>	0°C–40°C (32°F–104°F)
<b>Dimensions (W × H × D)</b>	Approx. 34.9 × 47 × 10.5 mm (1.4 × 1.9 × 0.5 in.)
<b>Weight</b>	Approx. 34 g (1.2 oz)

## Charging AC Adapter EH-71P

<b>Rated input</b>	AC 100–240 V, 50/60 Hz, MAX 0.2 A
<b>Rated output</b>	DC 5.0 V, 1.0 A
<b>Operating temperature</b>	0°C–40°C (32°F–104°F)
<b>Dimensions (W × H × D)</b>	Approx. 55 × 22 × 54 mm (2.2 × 0.9 × 2.2 in.) (excluding plug adapter) For Argentina: Approx. 55 × 63 × 59 mm (2.2 × 2.5 × 2.4 in.) For Brazil: Approx. 55 × 67 × 59 mm (2.2 × 2.7 × 2.4 in.)
<b>Weight</b>	Approx. 48 g (1.7 oz) (excluding plug adapter) For Argentina: Approx. 73 g (2.6 oz) For Brazil: Approx. 70 g (2.5 oz)

- Nikon will not be held liable for any errors this manual may contain.
- The appearance of this product and its specifications are subject to change without notice.

## Approved Memory Cards

The following Secure Digital (SD) memory cards have been tested and approved for use in this camera.

- Memory cards with an SD Speed Class rating of 6 or faster are recommended for recording movies. When using a memory card with a lower Speed Class rating, movie recording may stop unexpectedly.

	SD memory card	SDHC memory card	SDXC memory card
SanDisk	-	4 GB, 8 GB, 16 GB, 32 GB	64 GB, 128 GB
TOSHIBA	-	4 GB, 8 GB, 16 GB, 32 GB	64 GB
Panasonic	2 GB	4 GB, 8 GB, 16 GB, 32 GB	64 GB
Lexar	-	8 GB, 16 GB, 32 GB	64 GB, 128 GB

- Contact the manufacturer for details on the above cards. We cannot guarantee camera performance when using memory cards made by other manufacturers.
- If you use a card reader, make sure that it is compatible with your memory card.

---

## Trademark Information

- Windows is either a registered trademark or trademark of Microsoft Corporation in the United States and/or other countries.
- Adobe, the Adobe logo, and Reader are either trademarks or registered trademarks of Adobe Systems Incorporated in the United States and/or other countries.
- SDXC, SDHC, and SD Logos are trademarks of SD-3C, LLC.



- PictBridge is a trademark.
- HDMI, HDMI logo and High-Definition Multimedia Interface are trademarks or registered trademarks of HDMI Licensing LLC.

## HDMI

- Wi-Fi and the Wi-Fi logo are trademarks or registered trademarks of the Wi-Fi Alliance.
- Android and Google Play are trademarks or registered trademarks of Google, Inc.
- The N-Mark is a trademark or registered trademark of NFC Forum, Inc. in the United States and in other countries.
- All other trade names mentioned in this manual or the other documentation provided with your Nikon product are trademarks or registered trademarks of their respective holders.

## AVC Patent Portfolio License

This product is licensed under the AVC Patent Portfolio License for the personal and non-commercial use of a consumer to (i) encode video in compliance with the AVC standard ("AVC video") and/or (ii) decode AVC video that was encoded by a consumer engaged in a personal and non-commercial activity and/or was obtained from a video provider licensed to provide AVC video. No license is granted or shall be implied for any other use. Additional information may be obtained from MPEG LA, L.L.C.

See <http://www.mpegla.com>.

## FreeType License (FreeType2)

Portions of this software are copyright © 2012 The FreeType Project (<http://www.freetype.org>). All rights reserved.

## MIT License (HarfBuzz)

Portions of this software are copyright © 2015 The HarfBuzz Project (<http://www.freedesktop.org/wiki/Software/HarfBuzz>). All rights reserved.

# USER LICENSE AGREEMENT FOR LOCATION NAME DATA

The location name data that is stored in this digital camera ("Data") is provided for your personal, internal use only and not for resale. It is protected by copyright, and is subject to the following terms and conditions which are agreed to by you, on the one hand, and Nikon Corporation ("Nikon") and its licensors (including their licensors and suppliers) on the other hand.

## Terms and Conditions

Personal Use Only. You agree to use this Data together with this digital camera and the image data taken by the digital camera for the solely personal, non-commercial purposes for which you were licensed, and not for service bureau, time-sharing or other similar purposes.

Accordingly, but subject to the restrictions set forth in the following paragraphs, you agree not to otherwise reproduce, copy, modify, decompile, disassemble or reverse engineer any portion of this Data, and may not transfer or distribute it in any form, for any purpose, except to the extent permitted by mandatory laws.

Restrictions. Except where you have been specifically licensed to do so by Nikon, and without limiting the preceding paragraph, you may not (a) use this Data with any products, systems, or applications installed or otherwise connected to or in communication with vehicles, capable of vehicle navigation, positioning, dispatch, real time route guidance, fleet management or similar applications; or (b) with or in communication with any positioning devices or any mobile or wireless-connected electronic or computer devices, including without limitation cellular phones, palmtop and handheld computers, pagers, and personal digital assistants or PDAs.

Warning. The Data may contain inaccurate or incomplete information due to the passage of time, changing circumstances, sources used and the nature of collecting comprehensive geographic data, any of which may lead to incorrect results.

No Warranty. This Data is provided to you "as is," and you agree to use it at your own risk. Nikon and its licensors (and their licensors and suppliers) make no guarantees, representations or warranties of any kind, express or implied, arising by law or otherwise, including but not limited to, content, quality, accuracy, completeness, effectiveness, reliability, fitness for a particular purpose, usefulness, use or results to be obtained from this Data, or that the Data or server will be uninterrupted or error-free.

Disclaimer of Warranty: NIKON AND ITS LICENSORS (INCLUDING THEIR LICENSORS AND SUPPLIERS) DISCLAIM ANY WARRANTIES, EXPRESS OR IMPLIED, OF QUALITY, PERFORMANCE, MERCHANTABILITY, FITNESS FOR A PARTICULAR PURPOSE OR NON-INFRINGEMENT. Some States, Territories and Countries do not allow certain warranty exclusions, so to that extent the above exclusion may not apply to you.

Disclaimer of Liability: NIKON AND ITS LICENSORS (INCLUDING THEIR LICENSORS AND SUPPLIERS) SHALL NOT BE LIABLE TO YOU: IN RESPECT OF ANY CLAIM, DEMAND OR ACTION, IRRESPECTIVE OF THE NATURE OF THE CAUSE OF THE CLAIM, DEMAND OR ACTION ALLEGING ANY LOSS, INJURY OR DAMAGES, DIRECT OR INDIRECT, WHICH MAY RESULT FROM THE USE OR POSSESSION OF THE INFORMATION; OR FOR ANY LOSS OF PROFIT, REVENUE, CONTRACTS OR SAVINGS, OR ANY OTHER DIRECT, INDIRECT, INCIDENTAL, SPECIAL OR CONSEQUENTIAL DAMAGES ARISING OUT OF YOUR USE OF OR INABILITY TO USE THIS INFORMATION, ANY DEFECT IN THE INFORMATION, OR THE BREACH OF THESE TERMS OR CONDITIONS, WHETHER IN AN ACTION IN CONTRACT OR TORT OR BASED ON A WARRANTY, EVEN IF NIKON OR ITS LICENSORS HAVE BEEN ADVISED OF THE POSSIBILITY OF SUCH DAMAGES. Some States, Territories and Countries do not allow certain liability exclusions or damages limitations, so to that extent the above may not apply to you.

Export Control. You agree not to export from anywhere any part of the Data or any direct product thereof except in compliance with, and with all licenses and approvals required under, applicable export laws, rules and regulations, including but not limited to the laws, rules and regulations administered by the Office of Foreign Assets Control of the U.S. Department of Commerce and the Bureau of Industry and Security of the U.S. Department of Commerce. To the extent that any such export laws, rules or regulations prohibit Nikon and its licensors from complying with any of its obligations hereunder to deliver or distribute Data, such failure shall be excused and shall not constitute a breach of this Agreement.

Entire Agreement. These terms and conditions constitute the entire agreement between Nikon (and its licensors, including their licensors and suppliers) and you pertaining to the subject matter hereof, and supersedes in their entirety any and all written or oral agreements previously existing between us with respect to such subject matter.

Governing Law. The above terms and conditions shall be governed by the laws of the Japan, without giving effect to (i) its conflict of laws provisions, or (ii) the United Nations Convention for Contracts for the International Sale of Goods, which is explicitly excluded; provided that in the event that the laws of the Japan is not deemed applicable to this Agreement for any reason in the country where you obtained the Data, this Agreement shall be governed with the laws of the country where you obtained the Data. You agree to submit to the jurisdiction of Japan for any and all disputes, claims and actions arising from or in connection with the Data provided to you hereunder.

Government End Users. If the Data supplied by HERE is being acquired by or on behalf of the United States government or any other entity seeking or applying rights similar to those customarily claimed by the United States government, the Data is a “commercial item” as that term is defined at 48 C.F.R. (“FAR”) 2.101, is licensed in accordance with the End-User Terms under which this Data was provided, and each copy of the Data delivered or otherwise furnished shall be marked and embedded as appropriate with the following “Notice of Use,” and shall be treated in accordance with such Notice:

NOTICE OF USE  
CONTRACTOR (MANUFACTURER/ SUPPLIER) NAME:  
HERE  
CONTRACTOR (MANUFACTURER/ SUPPLIER) ADDRESS:  
425 West Randolph Street, Chicago, Illinois 60606  
This Data is a commercial item as defined in  
FAR 2.101 and is subject to the End-User  
Terms under which this Data was provided.  
© 2014 HERE - All rights reserved.

If the Contracting Officer, federal government agency, or any federal official refuses to use the legend provided herein, the Contracting Officer, federal government agency, or any federal official must notify HERE prior to seeking additional or alternative rights in the Data.



## Notices related to licensed software copyright holders.

- Location name data for Japan



© 2013 ZENRIN CO., LTD. All rights reserved.  
This service uses POI data of ZENRIN CO., LTD.  
“ZENRIN” is a registered trademark of ZENRIN CO., LTD.

- Location name data except for Japan



Maps for Life

© 1987-2014 HERE  
All rights reserved.

**Austria:** © Bundesamt für Eich- und Vermessungswesen

**Belgium:** © - Distribution & Copyright CIRB

**Croatia/Cyprus/Estonia/Latvia/Lithuania/Moldova/Poland/Slovenia/Ukraine:** © EuroGeographics

**Denmark:** Contains data that is made available by the Danish Geodata Agency (FOT) Retrieved by HERE 01/2014

**Finland:** Contains data from the National Land Survey of Finland Topographic Database 06/2012. (Terms of Use available at [http://www.maanmittauslaitos.fi/en/NLS\\_open\\_data\\_licence\\_version1\\_20120501](http://www.maanmittauslaitos.fi/en/NLS_open_data_licence_version1_20120501)).

Contains data that is made available by Itella in accordance with the terms available at [http://www.itella.fi/liitteet/palvelutjatuotteet/yhteystietopalvelut/uusi\\_postal\\_code\\_services\\_service\\_description\\_and\\_terms\\_of\\_use.pdf](http://www.itella.fi/liitteet/palvelutjatuotteet/yhteystietopalvelut/uusi_postal_code_services_service_description_and_terms_of_use.pdf). Retrieved by HERE 09/2013

**France:** source: © IGN 2009 – BD TOPO ®

**Germany:** Die Grundlagendaten wurden mit Genehmigung der zuständigen Behörden entnommen

Contains content of , Bayerische Vermessungsverwaltung – [www.geodaten.bayern.de](http://www.geodaten.bayern.de) , licensed in accordance with <http://creativecommons.org/licenses/by/3.0/legalcode>

Contains content of “LGL, [www.lgl-bw.de](http://www.lgl-bw.de)”, licensed in accordance with <http://creativecommons.org/licenses/by/3.0/legalcode>

Contains content of “Stadt Köln – [offenedaten-koeln.de](http://offenedaten-koeln.de)”, licensed in accordance with <http://creativecommons.org/licenses/by/3.0/legalcode>

Contains Content of “Geoportal Berlin / ATKIS® Basis-DLM”, licensed in accordance with <http://www.stadtentwicklung.berlin.de/geoinformation/download/nutzlll.pdf>

Contains Content of “Geoportal Berlin / Karte von Berlin 1:5000 (K5-Farbausgabe)”, licensed in accordance with <http://www.stadtentwicklung.berlin.de/geoinformation/download/nutzlll.pdf>

**Great Britain:** Contains Ordnance Survey data © Crown copyright and database right 2010

Contains Royal Mail data © Royal Mail copyright and database right 2010

**Greece:** Copyright Geomatics Ltd.

**Italy:** La Banca Dati Italiana è stata prodotta usando quale riferimento anche cartografia numerica ed al tratto prodotta e fornita dalla Regione Toscana.

Contains data from Trasporto Passeggeri Emilia-Romagna- S.p.A.

Includes content of Comune di Bologna licensed under <http://creativecommons.org/licenses/by/3.0/legalcode> and updated by licensee July 1, 2013.

Includes content of Comune di Cesena licensed under <http://creativecommons.org/licenses/by/3.0/legalcode> and updated by licensee July 1, 2013.

Includes contents of Ministero della Salute, and Regione Sicilia, licensed under <http://www.formez.it/iold/> and updated by licensee September 1, 2013.

Includes contents of Provincia di Enna, Comune di Torino, Comune di Pisa, Comune di Trapani, Comune di Vicenza, Regione Lombardia, Regione Umbria, licensed under <http://www.dati.gov.it/iodl/2.0/> and updated by licensee September 1, 2013.

Includes content of GeoforUs, licensed in accordance with <http://creativecommons.org/licenses/by/3.0/legalcode>.

Includes content of Comune di Milano, licensed under <http://creativecommons.org/licenses/by/2.5/it/legalcode> and updated by licensee November 1, 2013.

Includes content of the "Comunità Montana della Carnia", licensed under <http://www.dati.gov.it/iodl/2.0/> and updated by licensee December 1, 2013.

Includes content of "Agenzia per la mobilità" licensed under <http://creativecommons.org/licenses/by/3.0/legalcode> and updated by licensee January 1, 2014.

Includes content of Regione Sardegna, licensed under <http://www.dati.gov.it/iodl/2.0/> and updated by licensee May 1, 2014.

Includes content of CISIS, licensed under <http://creativecommons.org/licenses/by/2.5/legalcode>.

**Norway:** Copyright © 2000; Norwegian Mapping Authority

Includes data under the Norwegian licence for Open Government data (NLOD), available at <http://data.norge.no/nlod/en/1.0>

Contains information copyrighted by © Kartverket, made available in accordance with <http://creativecommons.org/licenses/by/3.0/no/>.

Contains data under the Norwegian licence for Open Government data (NLOD) distributed by Norwegian Public Roads Administration (NPRA)

**Portugal:** Source: IgeoE – Portugal

**Spain:** Información geográfica propiedad del CNIG

Contains data that is made available by the Generalitat de Catalunya Government in accordance with the terms available at [http://www.gencat.cat/web/eng/avis\\_legal.htm](http://www.gencat.cat/web/eng/avis_legal.htm). Retrieved by HERE 05/2013.

Contains content of Centro Municipal de Informatica – Malaga, licensed in accordance with <http://creativecommons.org/licenses/by/3.0/legalcode>.

Contains content of Administración General de la Comunidad Autónoma de Euskadi, licensed in accordance with <http://creativecommons.org/licenses/by/3.0/legalcode>

Contains data made available by the Ayuntamiento de Santander, licensed in accordance with <http://creativecommons.org/licenses/by/3.0/es/legalcode.es>

Contains data of Ajuntament de Sabadell, licensed per <http://creativecommons.org/licenses/by/3.0/legalcode>, updated 4/2013

**Sweden:** Based upon electronic data © National Land Survey Sweden.

Contains public data, licensed under Go Open v1.0, available at <http://data.goteborg.se/goopen/Avtal%20GoOpen%201.0.0.pdf>

**Switzerland:** Topografische Grundlage: © Bundesamt für Landestopographie

**United Kingdom:** Contains public sector information licensed under the Open Government Licence v1.0 (see for the license <http://www.nationalarchives.gov.uk/doc/open-government-licence/>)

Adapted from data from the office for National Statistics licensed under the Open Government Licence v.1.0

**Canada:** This data includes information taken with permission from Canadian authorities, including © Her Majesty, © Queen's Printer for Ontario, © Canada Post, GeoBase®, © Department of Natural Resources Canada. All rights reserved.

**Mexico:** Fuente: INEGI (Instituto Nacional de Estadística y Geografía)

**United States:** ©United States Postal Service® 2013. Prices are not established, controlled or approved by the United States Postal Service®. The following trademarks and registrations are owned by the USPS: United States Postal Service, USPS, and ZIP+4.

Includes data available from the U.S. Geological Survey.

**Australia:** Copyright. Based on data provided under license from PSMA Australia Limited ([www.pasma.com.au](http://www.pasma.com.au)).

Product incorporates data which is © 2013 Telstra Corporation Limited, Intelomatics Australia Pty Ltd and HERE International LLC.

**Nepal:** Copyright © Survey Department, Government of Nepal.

**Sri Lanka:** This product incorporates original source digital data obtained from the Survey Department of Sri Lanka

© 2009 Survey Department of Sri Lanka

The data has been used with the permission of the Survey Department of Sri Lanka

**Israel:** © Survey of Israel data source

**Jordan:** © Royal Jordanian Geographic Centre.

**Mozambique:** Certain Data for Mozambique provided by Cenacarta © 2013 by Cenacarta

**Nicaragua:** The Pacific Ocean and Caribbean Sea maritime borders have not been entirely defined. Northern land border defined by the natural course of the Coco River (also known as Segovia River or Wangki River) corresponds to the source of information available at the moment of its representation.

**Réunion:** source: © IGN 2009 - BD TOPO ®

**Ecuador:** INSTITUTO GEOGRAFICO MILITAR DEL ECUADRO  
AUTORIZACION N° IGM-2011-01- PCO-01 DEL 25 DE ENERO DE 2011

**Guadeloupe:** source: © IGN 2009 - BD TOPO ®

**Guatemala:** Aprobado por el INSTITUTO GEOGRAFICO NACIONAL – Resolución del IGN No 186-2011

**French Guiana:** source: © IGN 2009 - BD TOPO ®

**Martinique:** source: © IGN 2009 - BD TOPO ®

# Index

## Symbols

Auto mode ..... 16, 26

**SCENE** Scene mode ..... 27

**A** Aperture-priority auto mode  
..... 30, 32

**S** Shutter-priority auto mode  
..... 30, 32

**EFFECTS** Special effects mode ..... 28

Landscape mode ..... 24, 4

**P** Programmed auto mode  
..... 30, 32

**M** Manual mode ..... 30, 32

Night portrait mode... 24, 3

Night landscape mode  
..... 24, 3

**U** (User settings) mode ..... 34

Playback zoom ..... 22, 23

**W** (Wide-angle) ..... 20

Thumbnail display  
..... 22, 24

**T** (Telephoto) ..... 20

Wi-Fi button  
..... 2, 60, 45, 47

Apply selection button  
..... 2, 122

Playback button ..... 22, 121

Delete button ..... 23, 26

(Movie-record) button  
..... 21, 32

**DISP** Display button ..... 3

**Fn** Function button... 45, 120

Flash pop-up button ..... 36

**MENU** Menu button  
..... 49, 51, 54, 55, 57

Monitor button ..... 19

Self-timer/Remote control/Smile  
timer ..... 25, 38, 39

Focus mode ..... 25, 40

Flash mode ..... 25, 36

Exposure compensation  
..... 25, 44

N-Mark ..... 46

**A**  
AC adapter ..... 61, 116

Active D-Lighting ..... 52, 77

AF area mode ..... 45, 52, 73

AF assist ..... 57, 105

Aperture value ..... 30

Aperture-priority auto mode  
..... 30, 32

Assign side zoom control  
..... 57, 106

Auto ..... 37

Auto off ..... 18, 57, 107

Auto with red-eye reduction ..... 37

Autofocus ..... 41, 52, 54, 20,  
 76, 85

Autofocus mode  
..... 52, 54, 76, 85

**B**  
Backlighting ..... 27, 7































































Battery ..... 10, 18

Battery charger ..... 12, 116

Battery level indicator ..... 16





Best Shot Selector ..... 6, 68

Bird-watching ..... 27, 9

- Black and white copy  ..... 27, 6  
 Brightness..... 57, 101  
 BSS..... 6, 68  
 Button sound..... 106  
**C**  
 Calendar display ..... 24  
 Charge by computer .. 58, 108  
 Charge lamp..... 1, 11  
 Charging AC adapter..... 11, 19  
 Choose key picture ..... 56, 91  
 Close-up  ..... 27, 5  
 Color temperature..... 64  
 Command dial  
 ..... 30, 120, 122  
 Computer..... 62, 53  
 Connector cover..... 1, 11, 61  
 Continuous ..... 45, 52, 67  
 Contrast..... 60  
 COOLPIX Custom Picture Control  
 ..... 51, 62  
 COOLPIX Picture Control  
 ..... 45, 51, 58  
 Create log ..... 59, 42  
 Crop..... 23, 31  
 Cross process..... 29  
 Custom Picture Control  
 ..... 51, 62  
**D**  
 Date and time ..... 14, 57, 98  
 Date stamp..... 57, 103  
 Daylight saving time..... 14, 99  
 Delete..... 23, 26  
 Digital zoom..... 20, 57, 105  
 Diopter adjustment control ..... 19  
 Direct Print ..... 62, 49  
 D-Lighting..... 55, 27  
 Dynamic Fine Zoom..... 20  
**E**  
 Easy panorama  ..... 27, 10  
 Editing movies..... 37  
 Editing still images..... 26  
 Electronic VR..... 4, 54, 86  
 EVF auto toggle ..... 57, 103  
 EVF options ..... 101  
 Exposure bracketing..... 52, 72  
 Exposure compensation..... 25, 44  
 Exposure mode ..... 30  
 Extension ..... 115  
 Extracting still images..... 38  
 Eye sensor ..... 2, 19  
 Eyelet for camera strap ..... 9  
**E**  
 Face detection ..... 19  
 Face priority ..... 73  
 Fast motion movies  
 ..... 83, 84  
 File name ..... 115  
 Fill flash ..... 37  
 Filter effects..... 55, 29, 60  
 Fireworks show  ..... 27, 6  
 Firmware version ..... 58, 110  
 Flash..... 36  
 Flash exp. comp. .... 52, 76  
 Flash mode..... 25, 36  
 Fn button setting ..... 45  
 Focal length..... 53, 80, 16  
 Focus..... 17, 18, 33,  
73, 76, 85  
 Focus area  
 ..... 6, 17, 8, 18, 73  
 Focus indicator ..... 4, 17

- Focus lock..... 21  
 Focus mode..... 25, 40  
 Food ..... 27, 66  
 Format..... 10, 58, 107  
 Format memory cards  
 ..... 10, 58, 107  
 Frame rate..... 54, 87  
 Full-frame playback  
 ..... 7, 22, 23, 24  
 Full-time AF  
 ..... 52, 54, 76, 85  
 Functions that cannot be used  
 simultaneously..... 46
- H**  
 HDMI micro connector..... 48  
 HDR..... 7  
 High ISO monochrome..... 28  
 High key..... 28  
 High-contrast monochrome..... 28  
 High-speed continuous..... 67  
 Histogram..... 8, 44, 57, 101  
 HS movie ..... 83, 84
- I**  
 Identifier..... 115  
 Image quality..... 45, 51, 56  
 Image selection screen ..... 56  
 Image sharpening ..... 60  
 Image size..... 45, 51, 57  
 Infinity..... 41  
 Infrared receiver..... 1, 2  
 Interval timer shooting  
 ..... 68, 69  
 ISO sensitivity..... 45, 52, 71
- L**  
 Language..... 58, 107
- Lens..... 6, 16  
 Lens cap ..... 9  
 Li-ion rechargeable battery  
 ..... 10, 19  
 Location data options  
 ..... 49, 39, 94  
 Low key..... 28
- M**  
 M exposure preview..... 53, 81  
 Macro close-up ..... 41  
 Manual focus..... 41, 42  
 Manual mode ..... 30, 32  
 Mark for Wi-Fi upload  
 ..... 55, 47, 88  
 Memory capacity..... 16, 32  
 Memory card..... 10, 5, 20  
 Metering..... 45, 52, 66  
 Micro-USB connector  
 ..... 11, 61, 49, 53  
 Minimum shutter speed ..... 71  
 Mode dial..... 16, 24  
 Monitor ..... 3, 13, 6  
 Monitor options ..... 101  
 Monitor settings..... 57, 101  
 Moon ..... 27, 9  
 Movie menu ..... 54, 82  
 Movie options..... 54, 82  
 Movie playback..... 22, 32  
 Movie recording..... 21, 32  
 Movie recording time remaining  
 ..... 32, 33  
 Multi selector  
 ..... 25, 119, 121  
 Multiple exposure ..... 52, 78  
 Multi-shot 16..... 68  
 Museum ..... 27, 6





















**N**

- Night landscape mode..... 27,  63
- Night portrait mode..... 27,  63
- N-Mark.....  46
- Noise reduction filter .... 52,  77
- Nostalgic sepia..... 28
- Number of exposures remaining  
..... 16,  56

**O**

- Optical zoom ..... 20
- Optional accessories.....  116







**P**

- Paper size .....  50,  51
- Party/indoor  ..... 27,  65
- Peaking..... 58,  110
- Pet portrait  ..... 27,  68
- PictBridge..... 62,  49
- Picture Control..... 45, 51,  58
- Playback..... 22,  32
- Playback menu ..... 55
- Playback mode ..... 22
- Playback zoom..... 22,  23
- Points of interest (POI)  
..... 59,  96
- Positioning antenna..... 2
- Power..... 14
- Power switch ..... 1, 14
- Power-on lamp..... 1, 18
- Preset manual .....  65
- Pre-shooting cache  
.....  67,  69
- Pressing halfway... 17, 21,  120
- Print .....  49,  50,  51
- Printer..... 61,  49
- Programmed auto mode.... 30, 32
- Protect..... 55,  90













**Q**

- Quick adjust .....  60
- Quick retouch..... 55,  27

**R**

- Ready light..... 4, 36
- Rear-curtain sync ..... 37
- Rechargeable battery..... 11
- Red-eye reduction ..... 37
- Remote control.... 25, 38,  117
- Reset all..... 58,  110
- Reset file numbering... 58,  109
- Reset user settings..... 35
- Rotary multi selector  
..... 25,  119,  121
- Rotate image..... 55,  90

**S**

- Saturation.....  60
- Save user settings..... 35
- Scene auto selector  ..... 24,  4
- Scene mode..... 27
- Selecting images ..... 56
- Selective color ..... 28
- Self-timer ..... 25, 38
- Self-timer lamp ..... 39, 40
- Sequence..... 23,  23,  25
- Sequence display options  
..... 56,  91
- Set clock from satellite .....  97
- Setup menu ..... 57,  98
- Shooting ..... 24,  32
- Shooting information..... 3
- Shooting menu  
..... 51,  56,  58
- Shooting mode ..... 24, 54
- Shutter sound.....  106

- Shutter speed..... 30, 22  
 Shutter-priority auto mode  
 ..... 30, 32  
 Shutter-release button  
 ..... 17, 21, 120, 123  
 Side zoom control ..... 17, 119  
 Single..... 52, 67  
 Single AF  
 ..... 52, 54, 76, 85  
 Skin softening  
 ..... 55, 20, 28  
 Slide show ..... 55, 89  
 Slot empty release lock  
 ..... 57, 100  
 Slow motion movies  
 ..... 83, 84  
 Slow sync ..... 37  
 Small picture ..... 55, 30  
 Smile timer ..... 25, 39  
 Snap-back zoom button..... 2, 21  
 Snow ..... 27  
 Soft..... 28  
 Sound settings..... 57, 106  
 Special effects mode..... 28  
 Sports ..... 27, 5  
 Standard flash..... 37  
 Startup zoom position  
 ..... 53, 81  
 Subject tracking..... 74, 75  
 Sunset ..... 27  
**I**  
 Target finding AF..... 18, 74  
 Telephoto ..... 20  
 Thumbnail display ..... 22, 24  
 Time difference ..... 99  
 Time zone ..... 14, 98  
 Time zone and date  
 ..... 14, 57, 98  
 Time-lapse movie ..... 13  
 Toggle Av/Tv selection  
 ..... 58, 109  
 Tone level ..... 8  
 Tone level information..... 3, 8  
 Toning ..... 61  
 TV ..... 61, 48  
**U**  
 Upload from camera  
 ..... 47, 92  
 USB cable  
 ..... 11, 62, 49, 53  
 User settings mode ..... 34  
**V**  
 Vibration reduction  
 ..... 45, 57, 104  
 View log..... 44  
 View/hide framing grid  
 ..... 6, 101  
 Viewfinder ..... 19, 6  
 ViewNX-i..... 62, 53  
 Virtual horizon  
 ..... 6, 101, 102  
 Volume ..... 36  
**W**  
 White balance..... 45, 51, 63  
 Wide-angle ..... 20  
 Wi-Fi button..... 2, 45, 47  
 Wi-Fi options ..... 60, 92  
 Wi-Fi options menu ..... 49, 92  
 Wind noise reduction ... 54, 86  
 Wireless LAN ..... 60



## Z

Zoom .....	20
Zoom control .....	20,  121
Zoom memory .....	53,  80
Zoom microphone.....	54,  87

No reproduction in any form of this manual, in whole or in part (except for brief quotation in critical articles or reviews), may be made without written authorization from NIKON CORPORATION.

**NIKON CORPORATION**

---

© 2015 Nikon Corporation



FX5A02(11)  
6MN49411-02