



HP Notebook PC (AMD)

** Models: 15-ba100 – 15-ba199*

** Models: 15-ba000 – 15-ba099*

** Models: 15-bf100 – 15-bf199*

** Models: 15-bf000 – 15-bf099*

** Models: 15-bf100 – 15-bf199*

** Models: 15-bg000 – 15-bg099*

HP 255 G5 Notebook PC

Maintenance and Service Guide

© Copyright 2016 HP Development Company, L.P.

AMD is a trademark of Advanced Micro Devices, Inc. Bluetooth is a trademark owned by its proprietor and used by HP Inc. under license. Intel is a trademark of Intel Corporation in the U.S. and other countries. Microsoft and Windows are U.S. registered trademarks of the Microsoft group of companies.

The following applies to HP systems with Intel Skylake or next-generation silicon chip-based system shipping with Windows 7 or Windows 10 Pro systems downgraded to Windows 7 Professional: This version of Windows running with the processor or chipsets used in this system has limited support from Microsoft. For more information about Microsoft's support, please see Microsoft's Support Lifecycle FAQ at <https://support.microsoft.com/lifecycle>

The information contained herein is subject to change without notice. The only warranties for HP products and services are set forth in the express warranty statements accompanying such products and services. Nothing herein should be construed as constituting an additional warranty. HP shall not be liable for technical or editorial errors or omissions contained herein.

Second Edition: August 2016

First Edition: April 2016

Document Part Number: 855440-002

Product notice

This guide describes features that are common to most models. Some features may not be available on your computer.

Not all features are available in all editions of Windows. This computer may require upgraded and/or separately purchased hardware, drivers, and/or software to take full advantage of Windows functionality. See <http://www.microsoft.com> for details.

Software terms

By installing, copying, downloading, or otherwise using any software product preinstalled on this computer, you agree to be bound by the terms of the HP End User License Agreement (EULA). If you do not accept these license terms, your sole remedy is to return the entire unused product (hardware and software) within 14 days for a refund subject to the refund policy of your place of purchase.

For any further information or to request a full refund of the computer, please contact your local point of sale (the seller).

Safety warning notice

⚠ WARNING! To reduce the possibility of heat-related injuries or of overheating the device, do not place the device directly on your lap or obstruct the device air vents. Use the device only on a hard, flat surface. Do not allow another hard surface, such as an adjoining optional printer, or a soft surface, such as pillows or rugs or clothing, to block airflow. Also, do not allow the AC adapter to contact the skin or a soft surface, such as pillows or rugs or clothing, during operation. The device and the AC adapter comply with the user-accessible surface temperature limits defined by the International Standard for Safety of Information Technology Equipment (IEC 60950-1).

Table of contents

1 Product description	1
HP Notebook PC models with AMD A12, A10, A8, A6, E2 processors	1
HP Notebook PC models with AMD A9 processors	6
HP 255 G5 Notebook PC models	9
2 External component identification	13
Display	13
Right side	14
Left side	15
Top	16
TouchPad	16
Lights	17
Button	18
Keys	19
Using the action keys	20
Bottom	21
Labels	22
3 Illustrated parts catalog	23
Computer major components	23
Mass storage devices	28
Miscellaneous parts	30
Display assembly subcomponents	31
4 Removal and replacement procedures preliminary requirements	33
Tools required	33
Service considerations	33
Plastic parts	33
Cables and connectors	33
Drive handling	34
Grounding guidelines	34
Electrostatic discharge damage	34
Packaging and transporting guidelines	35
Workstation guidelines	35

5 Removal and replacement procedures for Customer Self-Repair parts	37
Component replacement procedures	37
Battery	38
Optical drive	39
6 Removal and replacement procedures for Authorized Service Provider parts	41
Component replacement procedures	41
Bottom cover	42
WLAN module	44
Memory module	46
Optical drive board	48
Speakers	49
Hard drive	50
RTC battery	53
USB board	54
Solid-state drive (SSD)	55
Solid-state drive board	56
Heat sink assembly	57
Fan	60
TouchPad button board	62
System board	63
Display assembly	66
Power connector cable	73
Power button board	74
Top cover/keyboard	75
7 Using Setup Utility (BIOS) in Windows 7	77
Starting Setup Utility (BIOS)	77
Updating the BIOS	77
Determining the BIOS version	77
Downloading a BIOS update	77
8 Using Setup Utility (BIOS) in Windows 10	79
Starting Setup Utility (BIOS)	79
Updating Setup Utility (BIOS)	79
Determining the BIOS version	79
Downloading a BIOS update	80
9 Backing up, restoring, and recovering in Windows 7	81
Creating backups	81

Creating recovery media to recover the original system	81
What you need to know	81
Creating the recovery media	82
Creating system restore points	82
What you need to know	82
Creating a system restore point	82
Backing up system and personal information	82
Tips for a successful backup	83
What you need to know	83
Creating a backup using Windows Backup and Restore	83
Restore and recovery	84
Restoring to a previous system restore point	84
Restoring specific files	84
Restoring specific files using Windows Backup and Restore	84
Recovering the original system using HP Recovery Manager	84
What you need to know	84
Recovering using HP Recovery partition (select products only)	85
Recovering using the recovery media	85
Changing the computer boot order	85
10 Backing up, restoring, and recovering in Windows 10	87
Creating recovery media and backups	87
Creating HP Recovery media (select products only)	87
Using Windows tools	88
Restore and recovery	89
Recovering using HP Recovery Manager	89
What you need to know before you get started	89
Using the HP Recovery partition (select products only)	90
Using HP Recovery media to recover	90
Changing the computer boot order	91
Removing the HP Recovery partition (select products only)	91
11 Using HP PC Hardware Diagnostics (UEFI)	93
Downloading HP PC Hardware Diagnostics (UEFI) to a USB device	93
12 Specifications	95
Computer specifications	95
39.6-cm (15.6-in) display specifications	96
Hard drive specifications, hybrid drives	96
Hard drive specifications	97

M.2 solid-state drive specifications	98
DVD±RW SuperMulti DL Drive specifications	99
13 Statement of memory volatility	101
Nonvolatile memory usage	105
Questions and answers	107
Using HP Sure Start (select models only)	108
14 Power cord set requirements	109
Requirements for all countries	109
Requirements for specific countries and regions	110
15 Recycling	113
Index	115

1 Product description

HP Notebook PC models with AMD A12, A10, A8, A6, E2 processors

Category	Description	Non-touch	Non-touch	Non-touch	Non-touch	Non-touch	Touch	Touch
		Dis, A10 M1-70	UMA, A12, A10	Dis, A8, A6, E2 M1-70	Dis, A8, A6, E2 M1-30	UMA, A8, A6, E2	UMA, A12, A10	UMA, A8, A6, E2
Product name	HP Notebook PC Model numbers: 15-ba000 – 15-ba099 15-bf000 – 15-bf099 15-bg000 – 15-bg099	√	√	√	√	√	√	√
Processor	AMD Quad-Core A-Series Processor A12-9700P (2.5GHz, up to 3.4GHz), 1866MHz/2 MB L2, Quad 15W		√				√	
	AMD Quad-Core A-Series Processor A10-9600P (2.4GHz, up to 3.3GHz), 1866MHz/2 MB L2, Quad 15W	√	√				√	
	AMD Quad-Core A-Series Processor A8-7410 (2.2GHz, turbo up to 2.5GHz), 1600MHz/2MB L2, Quad 15W			√	√	√		√
	A6-7310 (2.0GHz, turbo up to 2.4GHz), 1600MHz/2MB L2, Quad 15W				√	√		√
	E2-7110 (1.8GHz), 1600MHz/2MB L2, Quad 15W					√		
Chipset	Integrated SoC FCH	√	√	√	√	√	√	√
Graphics	Internal graphics AMD Radeon™ R7 Graphics (A12 processor)		√				√	
	AMD Radeon™ R5 Graphics (A8 processor)	√	√	√	√	√	√	√
	AMD Radeon R4 Graphics (A6 processor)				√	√		√
	AMD Radeon R2 Graphics (E2 processor)					√		
	Switchable discrete graphics AMD Radeon R7 M440 R16M-M1-70 with up to 4096 MB of dedicated video memory (512Mx16 DDR3 x 4 PCs)	√		√				

		Non-touch	Non-touch	Non-touch	Non-touch	Non-touch	Touch	Touch
Category	Description	Dis, A10 M1-70	UMA, A12, A10	Dis, A8, A6, E2 M1-70	Dis, A8, A6, E2 M1-30	UMA A8, A6, E2	UMA, A12, A10	UMA A8, A6, E2
	AMD Radeon R7 M440 R16M-M1-70 with up to 2048 MB of dedicated video memory (256Mx16 DDR3 x 4 PCs)	√						
	AMD Radeon R5 M430 R16M-M1-30 with up to 4096 MB of dedicated video memory (512Mx16 DDR3 x 4 PCs)				√			
	Support HD Decode, DX12, HDMI, and PX7	√	√	√	√	√	√	√
Panel	39.6-cm (15.6-in), high-definition (HD), white light-emitting diode (WLED), SVA, BrightView (1366×768) display, slim 3.2 mm, eDP; typical brightness: 220 nits	√	√	√	√	√		
	39.6-cm (15.6-in), full high-definition (FHD), white light-emitting diode (WLED), SVA, AntiGlare (1920×1080) display, slim 3.2 mm; typical brightness: 220 nits							
	39.6-cm (15.6-in), high-definition (HD), white light-emitting diode (WLED), SVA, Anti glare (1366×768) display, slim 3.2 mm, eDP; typical brightness: 220 nits							
	39.6-cm (15.6-in), high-definition (HD), white light-emitting diode (WLED), SVA, AntiGlare (1920×1080) display, slim 3.2 mm, Touch-on Panel (TOP); typical brightness: 220 nits Touch solution, multitouch enabled							√
Memory	Two non-customer-accessible/non-upgradable memory module slots DDR4-1866 dual channel support (DDR4-2400 bridge to DDR4-2133, and DDR4-2133 downgrade to DDR4-1866) Supports up to 16 GB of system RAM in the following configurations: <ul style="list-style-type: none"> • 16384-MB total system memory (8192×2)[UMA models only] • 12288-MB total system memory (8192×1) + (4096×1) • 8192-MB total system memory (8192×1) or (4096×2) • 6144-MB total system memory (4096×1) + (2048×1) 	√	√				√	
	Two non-customer-accessible/upgradable memory module slots DDR3L-1600 single channel support			√	√	√		√
	DDR3L-1333 single channel support (DDR3L-1600 downgrade to DDR3L-1333)					√		

		Non-touch	Non-touch	Non-touch	Non-touch	Non-touch	Touch	Touch
Category	Description	Dis, A10 M1-70	UMA, A12, A10	Dis, A8, A6, E2 M1-70	Dis, A8, A6, E2 M1-30	UMA A8, A6, E2	UMA, A12, A10	UMA A8, A6, E2
	<p>Supports up to 16 GB of system RAM in the following configurations:</p> <ul style="list-style-type: none"> • 16384-MB total system memory (8192×2)[UMA models only] • 12288-MB total system memory (8192×1) + (4096×1) • 8192-MB total system memory (8192×1) or (4096×2) • 6144-MB total system memory (4096×1) + (2048×1) • 4096-MB total system memory (4096×1) • 2048-MB total system memory (2048×1) 			√	√	√		√
Hard drives	<p>Supports 6.35-cm (2.5-in) SATA hard drives in 9.5-mm (.37-in) and 7.0-mm (.28-in) thicknesses</p> <p>Single hard drive configurations:</p> <ul style="list-style-type: none"> • 2-TB, 5400-rpm, 9.5-mm • 1-TB, 5400-rpm, 9.5-mm • 500-GB, 5400-rpm, 7.2-mm <p>SSHD configuration:</p> <ul style="list-style-type: none"> • 1-TB, 5400-rpm + 8GB NAND Hybrid hard drive, 9.5mm <p>M.2 SATA-3 configurations:</p> <ul style="list-style-type: none"> • 256 GB • 128 GB 	√	√	√	√	√	√	√
Optical drive	<p>Fixed, serial ATA, 9.5-mm tray load</p> <p>DVD+/-RW Double-Layer SuperMulti</p> <p>Supports zero power optical drive</p> <p>Supports M-disc</p> <p>Supports configuration without optical drive</p>	√	√	√	√	√	√	√
Webcam/mic	<p>HP TrueVision HD: HD camera - activity LED, USB 2.0, BSI sensor, 720p by 30 frames per second</p> <p>HP Webcam— 640 x 480 by 24 frames per second</p> <p>Single digital microphone</p> <p>HP Noise Cancellation enabled</p>	√	√	√	√	√	√	√

Category	Description	Non-touch	Non-touch	Non-touch	Non-touch	Non-touch	Touch	Touch
		Dis, A10 M1-70	UMA, A12, A10	Dis, A8, A6, E2 M1-70	Dis, A8, A6, E2 M1-30	UMA A8, A6, E2	UMA, A12, A10	UMA A8, A6, E2
Audio	DTS Studio Sound Dual speakers	√	√	√	√	√	√	√
Ethernet	Integrated 10/100 network interface card (NIC)	√	√	√	√	√	√	√
Wireless Network	Integrated wireless options with single antenna (M.2/PCIe): Compatible with Miracast-certified devices Support for the following WLAN formats: <ul style="list-style-type: none"> Realtek RTL8723BE-VB 802.11b/g/n 1x1 Wi-Fi + BT4.0 Combo Adapter Realtek RTL8723BE 802.11b/g/n 1x1 Wi-Fi + BT4.0 Combo Adapter Broadcom BCM43142 802.11 b/g/n 1x1 Wi-Fi + BT4.0 Combo Adapter Realtek RTL8188EE-VJ 802.11b/g/n 1x1 Wi-Fi Adapter Realtek RTL8188EE 802.11b/g/n 1x1 Wi-Fi Adapter 	√	√	√	√	√	√	√
	Integrated wireless options with dual antennas (M.2/PCIe): Compatible with Miracast-certified devices Support for the following WLAN formats: <ul style="list-style-type: none"> Intel Dual Band Wireless-AC 3165 802.11 ac 1x1 WiFi + BT 4.2 Combo 	√	√	√	√	√	√	√
External media card	HP Multi-Format Digital Media Reader Support SD/SDHC/SDXC Push-Pull Insertion/Removal	√	√	√	√	√	√	√
Internal Card	One M.2 slot for WLAN	√	√	√	√	√	√	√
Ports	HDMI version 1.4b supporting 1920 × 1080 @ 60Hz Hot Plug/unplug and auto detect for correct output to wide-aspect vs. standard aspect video RJ-45 (Ethernet) USB 3.0 (1 port; left side) USB 2.0 (2 ports; 1 left side, 1 right side) AC Smart Pin adapter plug	√	√	√	√	√	√	√

		Non-touch	Non-touch	Non-touch	Non-touch	Non-touch	Touch	Touch
Category	Description	Dis, A10 M1-70	UMA, A12, A10	Dis, A8, A6, E2 M1-70	Dis, A8, A6, E2 M1-30	UMA A8, A6, E2	UMA, A12, A10	UMA A8, A6, E2
	Headphone/line out and microphone/line in combo jack							
Keyboard /pointing devices	Full-size "island style" keyboard with numeric keypad	√	√	√	√	√	√	√
	TouchPad with multi-touch gestures enabled							
	Taps enabled by default							
	Support Modern Trackpad Gestures							
Power	AC adapters	√	√	√	√	√	√	√
	65-W EM							
	65-W	√		√	√			
	45-W		√				√	√
	1 meter power cord	√	√	√	√	√	√	√
Batteries	4-cell, 41-Whr Li-ion battery	√	√	√	√	√	√	√
	3-cell, 31-Whr Li-ion battery		√				√	√
Security	fTPM 2.0	√	√	√	√	√	√	√
	Kensington Security Lock							
Operating system	Preinstalled	√	√	√	√	√	√	√
	<ul style="list-style-type: none"> Windows 10 Windows 10 Professional Windows 10 Home High End CPPP Windows 10 Home China Language Edition CPPP Windows 10 Home High End China Language Edition 							
	<ul style="list-style-type: none"> FreeDOS 2.0 	√	√	√	√	√		
	<ul style="list-style-type: none"> Windows 10 Home Value Notebook 				√	√		
Service	End-user replaceable parts	√	√	√	√	√	√	√
	<ul style="list-style-type: none"> AC adapter Battery Optical drive 							

HP Notebook PC models with AMD A9 processors

Category	Description	Non-touch	Touch
Product name	HP Notebook PC Model numbers: 15-ba000 – 15-ba199 15-bf000 – 15-bf199 15-bg000 – 15-bg199	√	√
Processor	AMD Quad-Core A-Series Processor A9-9410 (2.9GHz, up to 3.5GHz), 2133MHz/1 MB L2, Quad 15W	√	√
Chipset	Integrated SoC FCH	√	√
Graphics	Internal graphics AMD Radeon™ R5 Graphics (A8 processor) Support HD Decode, DX12, HDMI, and PX7	√	√
Panel	39.6-cm (15.6-in), high-definition (HD), white light-emitting diode (WLED), SVA, BrightView (1366×768) display, slim 3.2 mm, eDP; typical brightness: 220 nits 39.6-cm (15.6-in), full high-definition (FHD), white light-emitting diode (WLED), SVA, AntiGlare (1920×1080) display, slim 3.2 mm; typical brightness: 220 nits	√	
	39.6-cm (15.6-in), high-definition (HD), white light-emitting diode (WLED), SVA, AntiGlare (1920×1080) display, slim 3.2 mm, Touch-on Panel (TOP); typical brightness: 220 nits Touch solution, multitouch enabled		√
Memory	Two non-customer-accessible/non-upgradable memory module slots DDR4-1866 dual channel support (DDR4-2400 bridge to DDR4-2133, and DDR4-2133 downgrade to DDR4-1866) Supports up to 16 GB of system RAM in the following configurations: <ul style="list-style-type: none"> • 16384-MB total system memory (8192×2) • 12288-MB total system memory (8192×1) + (4096×1) • 8192-MB total system memory (8192×1) or (4096×2) • 6144-MB total system memory (4096×1) + (2048×1) • 4096-MB total system memory (4096×1) 	√	√
Hard drives	Supports 6.35-cm (2.5-in) SATA hard drives in 9.5-mm (.37-in) and 7.0-mm (.28-in) thicknesses Single hard drive configurations: <ul style="list-style-type: none"> • 2-TB, 5400-rpm, 9.5-mm • 1-TB, 5400-rpm, 9.5-mm • 500-GB, 5400-rpm, 7.2-mm SSHD configuration: <ul style="list-style-type: none"> • 1-TB, 5400-rpm + 8GB NAND Hybrid hard drive, 9.5mm 	√	√

Category	Description	Non-touch	Touch
	M.2 SATA-3 configurations: <ul style="list-style-type: none"> • 256 GB • 128 GB 		
Optical drive	Fixed, serial ATA, 9.5-mm tray load DVD+/-RW Double-Layer SuperMulti Supports zero power optical drive Supports M-disc Supports configuration without optical drive	√	√
Webcam/mic	HP TrueVision HD: HD camera - activity LED, USB 2.0, BSI sensor, f2.0, 720p by 30 frames per second HP Webcam– 640 x 480 by 24 frames per second Single digital microphone HP Noise Cancellation enabled	√	√
Audio	DTS Studio Sound Dual speakers	√	√
Ethernet	Integrated 10/100 network interface card (NIC)	√	√
Wireless Network	Integrated wireless options with single antenna (M.2/PCIe): Compatible with Miracast-certified devices Support for the following WLAN formats: <ul style="list-style-type: none"> • Realtek RTL8723BE-VB 802.11b/g/n 1x1 Wi-Fi + BT4.0 Combo Adapter • Realtek RTL8188EE-VJ 802.11b/g/n 1x1 Wi-Fi Adapter • Realtek RTL8188EE 802.11b/g/n 1x1 Wi-Fi Adapter 	√	√
	Integrated wireless options with dual antennas (M.2/PCIe): Compatible with Miracast-certified devices Support for the following WLAN formats: <ul style="list-style-type: none"> • Intel Dual Band Wireless-AC 3168 802.11 ac 1x1 WiFi + BT 4.2 Combo Adapter 	√	√
External media card	HP Multi-Format Digital Media Reader Support SD/SDHC/SDXC Push-Pull Insertion/Removal	√	√
Internal Card	One M.2 slot for WLAN	√	√
Ports	HDMI version 1.4b supporting 1920 ×1080 @ 60Hz Hot Plug/unplug and auto detect for correct output to wide-aspect vs. standard aspect video RJ-45 (Ethernet) USB 3.0 (1 port; left side) USB 2.0 (2 ports; 1 left side, 1 right side) AC Smart Pin adapter plug	√	√

Category	Description	Non-touch	Touch
	Headphone/line out and microphone/line in combo jack		
Keyboard/ pointing devices	Full-size "island style" keyboard with numeric keypad	√	√
	TouchPad with multi-touch gestures enabled		
	Taps enabled by default		
	Support Modern Trackpad Gestures		
Power	AC adapters	√	√
	65-W EM		
	65-W	√	
	45-W		√
	1 meter power cord	√	√
Batteries		√	√
	4-cell, 41-Whr Li-ion battery		
	3-cell, 31-Whr Li-ion battery	√	√
Security	fTPM 2.0	√	√
	Kensington Security Lock		
Operating system	Preinstalled	√	√
	<ul style="list-style-type: none"> • Windows 10 • Windows 10 Professional • Windows 10 Home High End • CPPP Windows 10 Home China Language Edition • CPPP Windows 10 Home High End China Language Edition 		
Service	• FreeDOS 2.0	√	
	End-user replaceable parts	√	√
	• AC adapter		
	• Battery		
	• Optical drive		

HP 255 G5 Notebook PC models

Category	Description
Product name	HP 255 G5 Notebook PC
Processor	<p>AMD Quad-Core A-Series Processor</p> <p>A8-7410 (2.2GHz, turbo up to 2.5GHz), 1600MHz/2MB L2, Quad 15W</p> <p>A6-7310 (2.0GHz, turbo up to 2.4GHz), 1600MHz/2MB L2, Quad 15W</p> <p>E2-7110 (1.8GHz), 1600MHz/2MB L2, Quad 15W</p>
Chipset	Integrated SoC FCH
Graphics	<p>Internal graphics</p> <p>AMD Radeon™ R5 Graphics (A8 processor)</p> <p>AMD Radeon R4 Graphics (A6 processor)</p> <p>AMD Radeon R2 Graphics (E2 processor)</p> <p>Support HD Decode, DX12, HDMI, and PX7</p>
Panel	<p>39.6-cm (15.6-in), high-definition (HD), white light-emitting diode (WLED), SVA BrightView (1366×768) display, slim 3.2 mm, eDP; typical brightness: 220 nits</p> <p>39.6-cm (15.6-in), high-definition (FHD), white light-emitting diode (WLED), SVA AntiGlare (1920×1080) display, slim 3.2 mm; typical brightness: 220 nits</p>
Memory	<p>Two non-customer-accessible/upgradable memory module slots</p> <p>DDR3L-1600 single channel support</p> <p>Supports up to 16 GB of system RAM in the following configurations:</p> <ul style="list-style-type: none"> • 16384-MB total system memory (8192×2) • 12288-MB total system memory (8192×1) + (4096×1) • 8192-MB total system memory (8192×1) or (4096×2) • 6144-MB total system memory (4096×1) + (2048×1) • 4096-MB total system memory (4096×1) • 2048-MB total system memory (2048×1)
Hard drives	<p>Supports 6.35-cm (2.5-in) SATA hard drives in 9.5-mm (.37-in) and 7.0-mm (.28-in) thicknesses</p> <p>Single hard drive configurations:</p> <ul style="list-style-type: none"> • 2-TB, 5400-rpm, 9.5-mm • 1-TB, 5400-rpm, 9.5-mm • 500-GB, 7200-rpm, 7.2-mm • 500-GB, 5400-rpm, 7.2-mm <p>SSHD configuration:</p> <ul style="list-style-type: none"> • 1-TB, 5400-rpm + 8GB NAND Hybrid hard drive, 9.5-mm <p>M.2 SATA-3 configuration:</p> <ul style="list-style-type: none"> • 256 GB • 128 GB
Optical drive	Fixed, serial ATA, 9.5-mm tray load

Category	Description
	<p>DVD+/-RW Double-Layer SuperMulti</p> <p>Supports zero power optical drive</p> <p>Supports M-disc</p> <p>Supports configuration without optical drive</p>
Webcam/mic	<p>HP TrueVision HD: HD camera - activity LED, USB 2.0, BSI sensor, 720p by 30 frames per second</p> <p>HP Webcam– 640 x 480 by 24 frames per second</p> <p>Single digital microphone</p> <p>HP Noise Cancellation enabled</p> <p>Supports voice recognition</p>
Audio	<p>DTS Studio Sound</p> <p>Dual speakers</p>
Ethernet	<p>Integrated 10/100/1000 network interface card (NIC)</p>
Wireless Network	<p>Integrated wireless options with single antenna (M.2/PCIe):</p> <p>Compatible with Miracast-certified devices</p> <p>Support for the following WLAN formats:</p> <ul style="list-style-type: none"> • Realtek RTL8723BE-VB 802.11b/g/n 1x1 Wi-Fi + BT4.0 Combo Adapter • Realtek RTL8723BE 802.11b/g/n 1x1 Wi-Fi + BT4.0 Combo Adapter • Broadcom BCM43142 802.11 b/g/n 1x1 Wi-Fi + BT4.0 Combo Adapter • Realtek RTL8188EE-VJ 802.11b/g/n 1x1 Wi-Fi Adapter • Realtek RTL8188EE 802.11b/g/n 1x1 Wi-Fi Adapter <p>Integrated wireless options with dual antennas (M.2/PCIe):</p> <p>Compatible with Miracast-certified devices</p> <p>Support for the following WLAN formats:</p> <ul style="list-style-type: none"> • Intel Dual Band Wireless-AC 3168 802.11 ac 1x1 WiFi + Bluetooth 4.2 Combo Adapter • Intel Dual Band Wireless-AC 3165 802.11 ac 1x1 WiFi + Bluetooth 4.2 Combo Adapter
External media card	<p>HP Multi-Format Digital Media Reader</p> <p>Support SD/SDHC/SDXC</p> <p>Push-Pull Insertion/Removal</p>
Internal Card	<p>One M.2 slot for WLAN</p>
Ports	<p>HDMI version 1.4b supporting 1920 ×1080 @ 60Hz</p> <p>VGA (Dsub 15 pin) supporting 1920 ×1200 @ 60Hz and 2560 ×1600 @ 60Hz</p> <p>Hot Plug/unplug and auto detect for correct output to wide-aspect vs. standard aspect video</p> <p>RJ-45 (Ethernet)</p> <p>USB 3.0 (1 port; left side)</p> <p>USB 2.0 (2 ports; 1 left side, 1 right side)</p> <p>AC Smart Pin adapter plug</p>

Category	Description
	Headphone/line out and microphone/line in combo jack
Keyboard/pointing devices	Full-size "island style" keyboard with numeric keypad TouchPad with multi-touch gestures enabled Taps enabled by default Support Modern Trackpad Gestures
Power	AC adapters 65-W EM 45-W 1 meter power cord Batteries 4-cell, 41-Whr Li-ion battery 3-cell, 31-Whr Li-ion battery
Security	fTPM 2.0 Kensington Security Lock
Operating system	Preinstalled <ul style="list-style-type: none"> • Windows 10 Professional Shape the Future MSNA Standard • Windows 10 Professional Shape the Future Value • Windows 10 • Windows 10 Professional • Windows 10 Home High End • Windows 10 Pro Downgrade to Windows 7 Pro • Windows 10 Pro Downgrade to Windows 7 Pro StF MSNA • FreeDOS 2.0
Service	End-user replaceable parts <ul style="list-style-type: none"> • AC adapter • Battery • Optical drive

2 External component identification

Display



Component	Description
(1) WLAN antennas*	Send and receive wireless signals to communicate with wireless local area networks (WLANs).
(2) Webcam light	On: The webcam is in use.
(3) Webcam	Records video and captures photographs. Some products allow you to video conference and chat online using streaming video. To use a webcam (integrated camera): <ul style="list-style-type: none">▲ Type <code>camera</code> in the taskbar search box, and then select Camera.
(4) Internal microphone	Records sound.

*The antennas are not visible from the outside of the computer. For optimal transmission, keep the areas immediately around the antennas free from obstructions.





For wireless regulatory notices, see the section of the *Regulatory, Safety, and Environmental Notices* that applies to your country or region.

To access this guide:

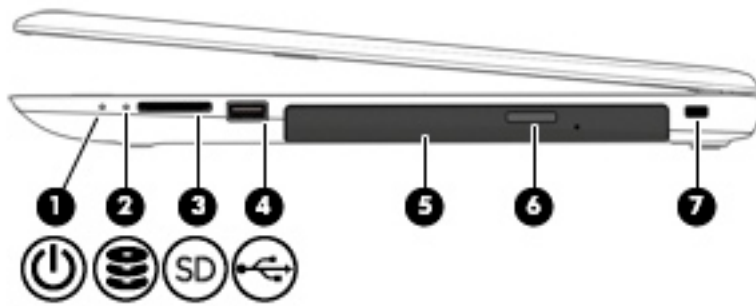
- ▲ Select the **Start** button, select **All apps**, select **HP Help and Support**, and then select **HP Documentation**.







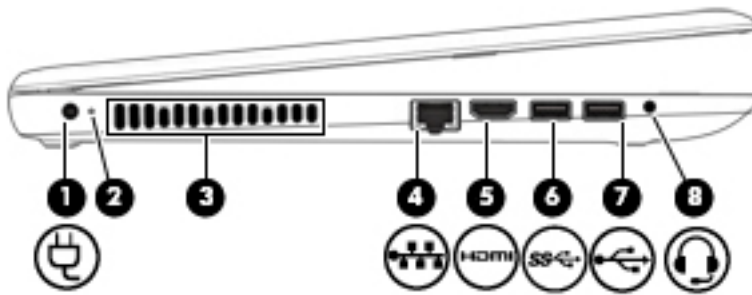

Right side



Component	Description
(1)  Power light	<ul style="list-style-type: none"> On: The computer is on. Blinking: The computer is in the Sleep state, a power-saving state. The computer shuts off power to the display and other unneeded components. Off: The computer is off or in Hibernation. Hibernation is a power-saving state that uses the least amount of power.
(2)  Drive light	<ul style="list-style-type: none"> Blinking white: The hard drive is being accessed.
(3)  Memory card reader	<p>Reads optional memory cards that enable you to store, manage, share, or access information.</p> <p>To insert a card:</p> <ol style="list-style-type: none"> Hold the card label-side up, with connectors facing the computer. Insert the card into the memory card reader, and then press in on the card until it is firmly seated. <p>To remove a card:</p> <ul style="list-style-type: none"> Pull the card out of the slot.
(4)  USB 2.0 port	Connects an optional USB device, such as a keyboard, mouse, external drive, printer, scanner or USB hub.
(5) Optical drive (select products only)	<p>Depending on your computer, reads an optical disc or reads and writes to an optical disc.</p> <p>NOTE: For disc compatibility information, type <code>help</code> in the taskbar search box, select Help and Support, and then type <code>disc compatibility</code> in the search box.</p>
(6) Optical drive eject button (select products only)	Releases the optical drive disc tray.
(7) Security cable slot	<p>Attaches an optional security cable to the computer.</p> <p>NOTE: The security cable is designed to act as a deterrent, but it may not prevent the computer from being mishandled or stolen.</p>

Left side



Component	Description
(1) 	Power connector Connects an AC adapter.
(2) 	AC adapter and battery light <ul style="list-style-type: none"> White: The AC adapter is connected and the battery is fully charged. Blinking white: The AC adapter is disconnected and the battery has reached a low battery level. Amber: The AC adapter is connected and the battery is charging. Off: The battery is not charging.
(3) 	Vent Enables airflow to cool internal components. NOTE: The computer fan starts up automatically to cool internal components and prevent overheating. It is normal for the internal fan to cycle on and off during routine operation.
(4) 	RJ-45 (network) jack/status lights Connects a network cable. <ul style="list-style-type: none"> White: The network is connected. Amber: Activity is occurring on the network.
(5) 	HDMI port Connects an optional video or audio device, such as a high-definition television, any compatible digital or audio component, or a high-speed High-Definition Multimedia Interface (HDMI) device.
(6) 	USB 3.0 port Connects an optional USB device, such as a keyboard, mouse, external drive, printer, scanner or USB hub.
(7) 	USB 2.0 port Connects an optional USB device, such as a keyboard, mouse, external drive, printer, scanner or USB hub.
(8) 	Audio-out (headphone)/Audio-in (microphone) combo jack Connects optional powered stereo speakers, headphones, earbuds, a headset, or a television audio cable. Also connects an optional headset microphone. This jack does not support optional standalone microphones.

Component	Description
	<p>WARNING! To reduce the risk of personal injury, adjust the volume before putting on headphones, earbuds, or a headset. For additional safety information, refer to the <i>Regulatory, Safety, and Environmental Notices</i>.</p> <p>To access this guide:</p> <ul style="list-style-type: none"> ▲ Select the Start button, select All apps, select HP Help and Support, and then select HP Documentation. <p>NOTE: When a device is connected to the jack, the computer speakers are disabled.</p>

Top

TouchPad

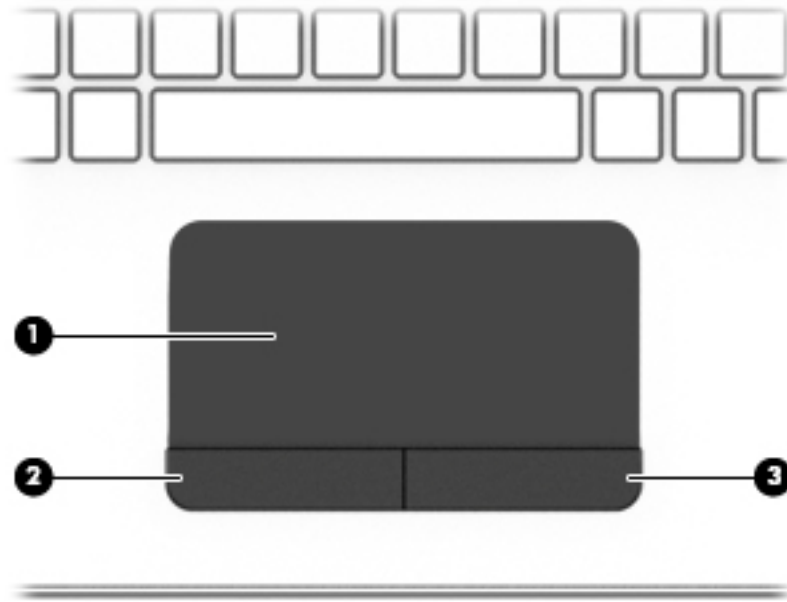

Component	Description	
(1)	TouchPad zone	Reads your finger gestures to move the pointer or activate items on the screen.
(2)	Left TouchPad button	Functions like the left button on an external mouse.
(3)	Right TouchPad button	Functions like the right button on an external mouse.

Lights

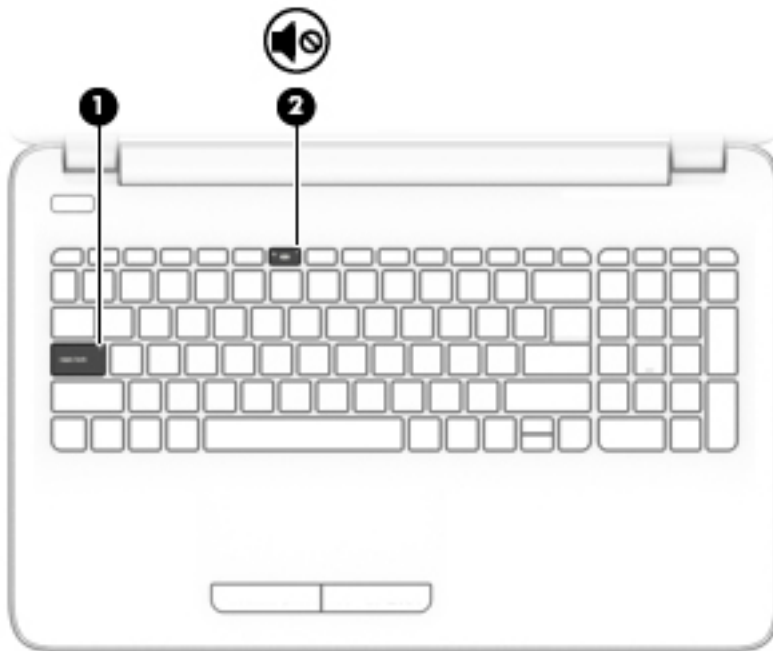

Component	Description
(1) Caps lock light	On: Caps lock is on, which switches the key input to all capital letters.
(2)  Mute light	<ul style="list-style-type: none">• Amber: Computer sound is off.• Off: Computer sound is on.

Button

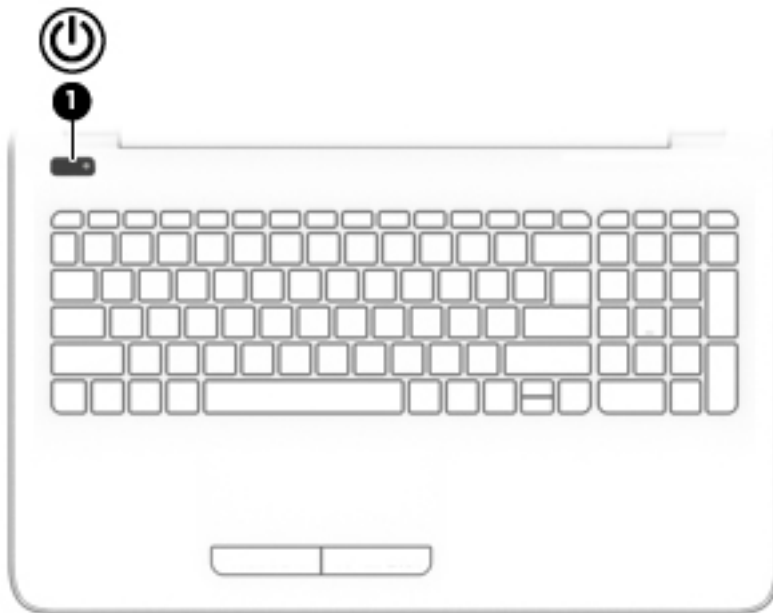

Component	Description
<p>(1)  Power button</p>	<ul style="list-style-type: none">• When the computer is off, press the button to turn on the computer.• When the computer is on, press the button briefly to initiate Sleep.• When the computer is in the Sleep state, press the button briefly to exit Sleep.• When the computer is in Hibernation, press the button briefly to exit Hibernation. <p>CAUTION: Pressing and holding down the power button results in the loss of unsaved information.</p> <p>If the computer has stopped responding and shutdown procedures are ineffective, press and hold the power button down for at least 5 seconds to turn off the computer.</p> <p>To learn more about your power settings, see your power options.</p> <p>▲ Type <code>power</code> in the taskbar search box, and then select Power and sleep settings.</p> <p>– or –</p> <p>Right-click the Start button, and then select Power Options.</p>



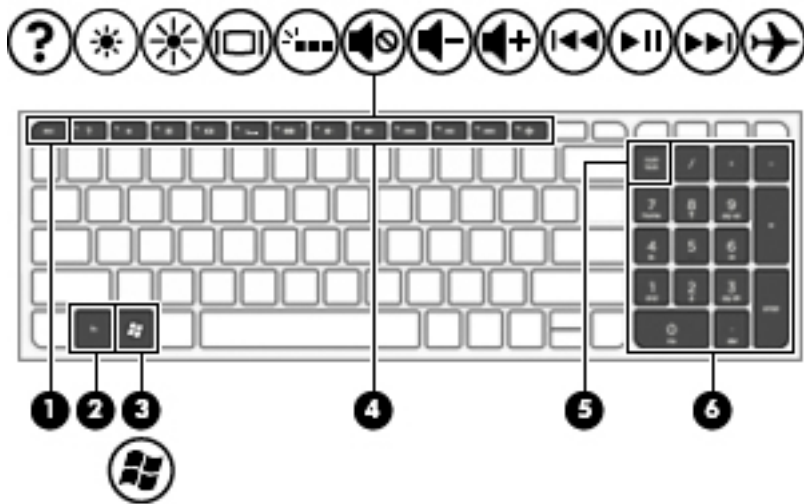







Keys



Component	Description
(1) esc key	Displays system information when pressed in combination with the fn key.
(2) fn key	Executes frequently used system functions when pressed in combination with the esc key, action keys, or the spacebar .
(3)  Windows key	Opens the Start menu. NOTE: Pressing the Windows key again will close the Start menu.
(4) Action keys	Execute frequently used system functions.
(5) num lock key	Alternates between the navigational and numeric functions on the integrated numeric keypad.
(6) Integrated numeric keypad	When num lock is on, the keypad can be used like an external numeric keypad.



Using the action keys

- An action key performs an assigned function.
- The icon on each action key illustrates the function for that key.
- To use an action key, press and hold the key.

Icon	Description
	Opens Help and Support, which provides tutorials, information about the Windows operating system and your computer, answers to questions, and updates to your computer. Help and Support also provides automated troubleshooting tools and access to support.
	Decreases the screen brightness incrementally as long as you hold down the key.
	Increases the screen brightness incrementally as long as you hold down the key.
	Switches the screen image between display devices connected to the system. For example, if a monitor is connected to the computer, repeatedly pressing this key alternates the screen image from the computer display to the monitor display to a simultaneous display on both the computer and the monitor.
	Mutes or restores speaker sound.
	Decreases speaker volume incrementally while you hold down the key.
	Increases speaker volume incrementally while you hold down the key.
	Plays the previous track of an audio CD or the previous section of a DVD or a Blu-ray Disc (BD).
	Starts, pauses, or resumes playback of an audio CD, a DVD, or a BD.
	Plays the next track of an audio CD or the next section of a DVD or a BD.
	Turns the airplane mode and wireless feature on or off. NOTE: The airplane mode key is also referred to as the wireless button. NOTE: A wireless network must be set up before a wireless connection is possible.

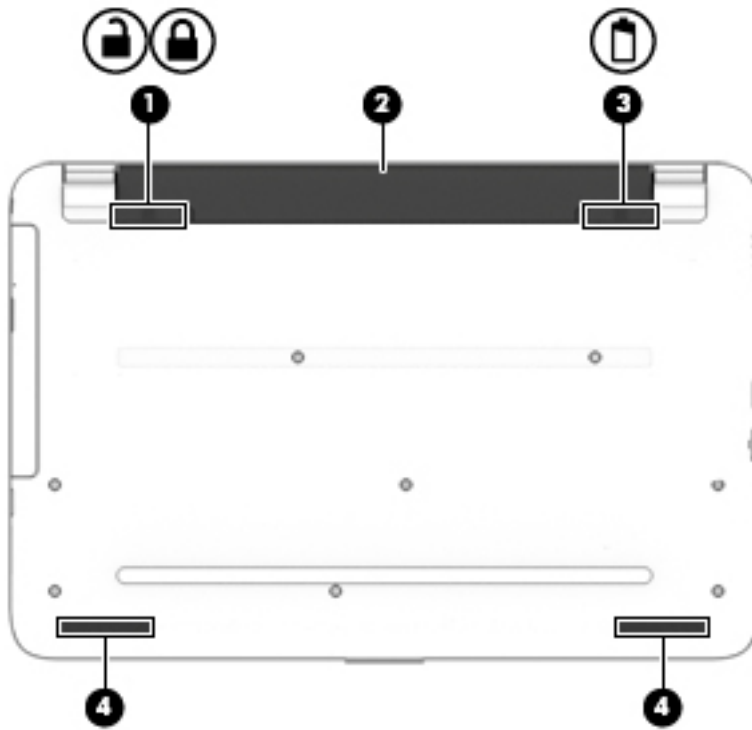
Bottom



Component	Description
(1)  	Battery lock Locks the battery in the battery bay.
(2)	Battery bay Holds the battery.
(3) 	Battery release latch Releases the battery.
(4)	Speakers (2) Produce sound.

Labels

The labels affixed to the computer provide information you may need when you troubleshoot system problems or travel internationally with the computer.

 **IMPORTANT:** Check the following locations for the labels described in this section: the bottom of the computer, inside the battery bay, under the service door, or on the back of the display.

- Service label—Provides important information to identify your computer. When contacting support, you will probably be asked for the serial number, and possibly for the product number or the model number. Locate these numbers before you contact support.

Your service label will resemble one of the examples shown below. Refer to the illustration that most closely matches the service label on your computer.

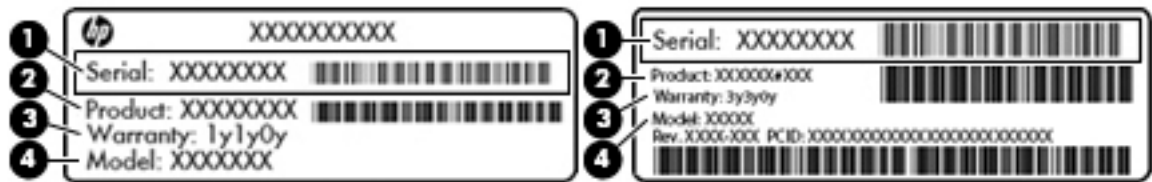

Component

-
- (1) Serial number

 - (2) Product number

 - (3) Warranty period

 - (4) Model number (select products only)
-

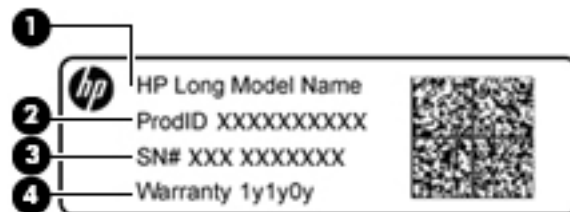

Component

-
- (1) Model name (select products only)

 - (2) Product number

 - (3) Serial number

 - (4) Warranty period
-

- Regulatory label(s)—Provide(s) regulatory information about the computer.
- Wireless certification label(s)—Provide(s) information about optional wireless devices and the approval markings for the countries or regions in which the devices have been approved for use.

3 Illustrated parts catalog

Computer major components

 **NOTE:** HP continually improves and changes product parts. For complete and current information on supported parts for your computer, go to <http://partsurfer.hp.com>, select your country or region, and then follow the on-screen instructions.

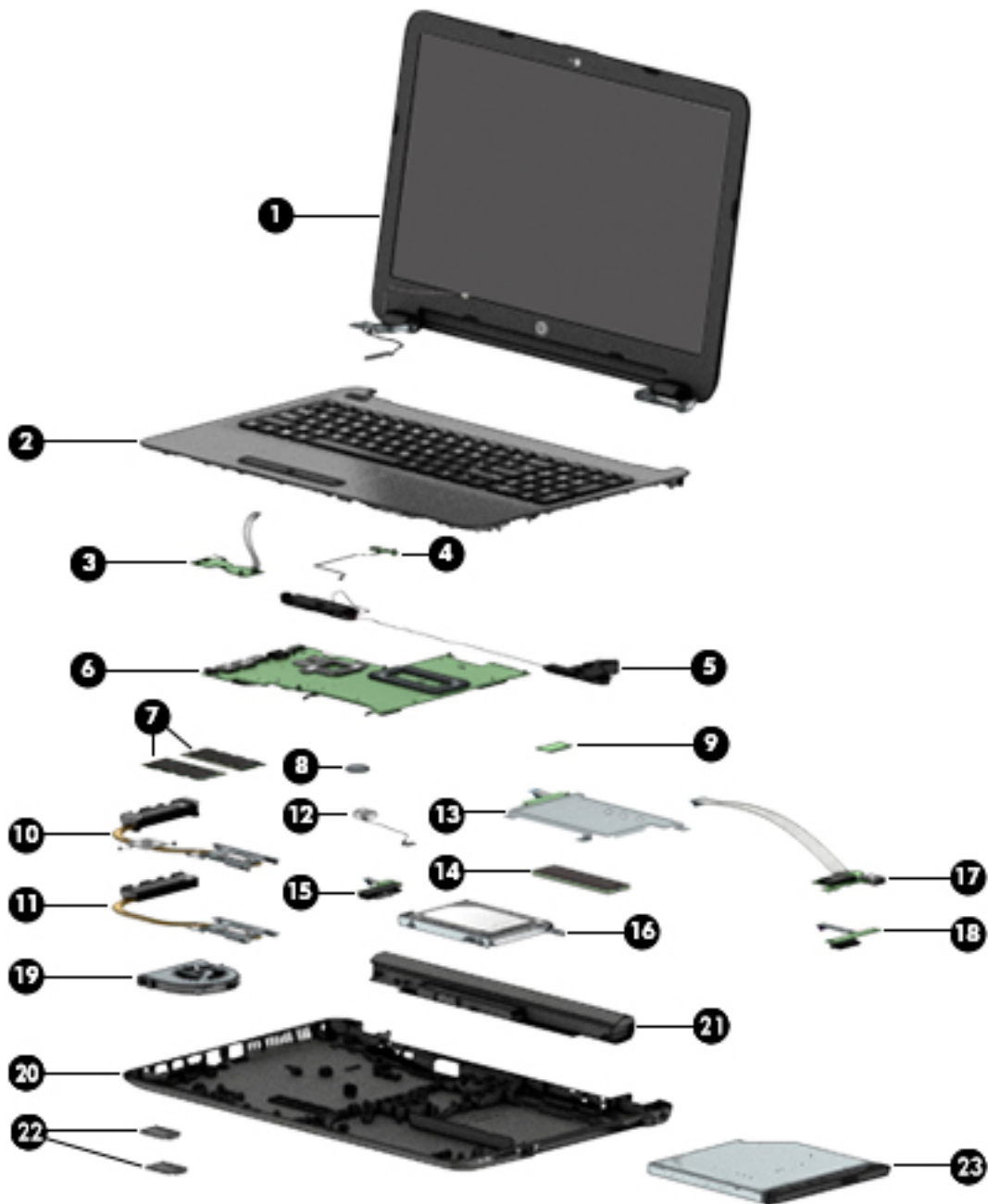

Item	Component	Spare part number
(1)	Display assembly (touch or non-touch) NOTE: For display assembly spare part information, see Display assembly subcomponents on page 31 .	not spared
(2)	Top cover/keyboard NOTE: For a detailed list of keyboard country codes, see Top cover/keyboard on page 75 . For use in HP Notebook PC models:	
	• Turbo silver	855022-xx1
	• White silver	855023-xx1
	• Red	855024-xx1
	• Teal	855025-xx1
	• Noble blue	855026-xx1
	• Iris purple models	901746-xx1
	• Powder blue models	908028-xx1
	• Soft lilac models	908029-xx1
	• Misty green models	908030-xx1
	For use in HP Notebook PC and HP 255 G5 Notebook PC models:	
	• Black models	855027-xx1
	• Black models, for use in Canada	902973-DB1
	• Silver models	905891-xx1
(3)	Touchpad button board (includes bracket and cables)	855011-001
(4)	Power button board (includes cable)	855012-001
(5)	Speakers (includes left and right speakers and cable)	813965-001
(6)	System board (includes replacement thermal materials) All system boards use the following part numbers: xxxxxx-001: Windows 7 or non-Windows operating systems xxxxxx-601: Windows 10 operating system	
	For use in HP Notebook models (discrete graphics memory; non-touch screen):	
	• AMD A10-9600P processor and 4 GB of discrete graphics memory (R7M1-70)	854959-xx1
	• AMD A10-9600P processor and 2 GB of discrete graphics memory (R7M1-70)	854960-xx1
	• AMD A8-7410 processor and 4 GB of discrete graphics memory (R7M1-70)	854963-xx1
	• AMD A8-7410 processor and 2 GB of discrete graphics memory (R5M1-30)	854964-xx1
	• AMD A6-7310 processor and 2 GB of discrete graphics memory (R5M1-30)	854967-xx1
	For use in HP Notebook models (UMA graphics memory; non-touch screen)::	
	• AMD A12-9700P processor	902570-xx1

Item	Component	Spare part number
	• AMD A10-9600P processor	854957-xx1
	• AMD A9-9410 processor	854969-xx1
	• AMD A8-7410 processor	854961-xx1
	• AMD A6-7310 processor	854965-xx1
	• AMD E2-7110 processor	854968-xx1
	For use in HP Notebook models (UMA graphics memory; touch screen)::	
	• AMD A10-9600P processor	854958-xx1
	• AMD A8-7410 processor	854962-xx1
	• AMD A6-7310 processor	854966-xx1
	For use in HP 255 G5 Notebook PC models (UMA graphics memory; non-touch screen):	
	• AMD A8-7410 processor	858587-xx1
	• AMD A6-7310 processor	858588-xx1
	• AMD E2-7110 processor	858589-xx1
(7)	Memory module	
	PC3L, 12800, 1600-MHz	
	For use in models with AMD A8, A6, E2 processors	
	• 8-GB	693374-005
	• 4 GB	691740-005
	• 2 GB	691739-005
	PC4, 17000, 2133-MHz	
	For use in models with AMD A10 and A9 processors	
	• 8-GB	820570-005
	• 4 GB	820569-005
	• 2 GB	851379-005
(8)	RTC battery	760828-001
(9)	WLAN module	
	Realtek RTL8723BE-VB 802.11b/g/n 1x1 Wi-Fi + BT4.0 Combo Adapter	855106-855
	Intel Dual Band Wireless-AC 3165 802.11 ac 1x1 WiFi + BT 4.2 Combo	806723-005
	Realtek RTL8188EE-VJ 802.11b/g/n 1x1 Wi-Fi Adapter	857334-855
	Realtek RTL8723BE 802.11b/g/n 1x1 Wi-Fi + BT4.0 Combo Adapter	792505-855
	Intel Dual Band Wireless-AC 3168 802.11 ac 1x1 WiFi + BT 4.2 Combo Adapter	863934-855
	Heat sink assembly (includes replacement thermal materials)	
(10)	For use in models with AMD A8, A6, E2 processors and discrete graphics memory	813948-001
	For use in models with AMD A10 processors and discrete graphics memory	854971-001

Item	Component	Spare part number
(11)	For use in models with AMD A8, A6, E2 processors and UMA graphics memory	813947-001
	For use in models with AMD A10 processors and UMA graphics memory	854970-001
	For use in models with AMD A9 processors and UMA graphics memory	908075-001
(12)	Power connector cable	813945-001
(13)	Solid-state drive board	850946-001
(14)	Solid-state drive , M.2 (not illustrated)	
	256 GB, for use in HP Notebook PC models	865902-007
	128 GB, for use in HP Notebook PC models	827560-021
	128 GB, for use in HP 255 G5 Notebook PC models	863015-001
(15)	Hard drive connector board	817878-001
(16)	Hard drive (does not include bracket, connector board, or cable)	
	NOTE: For HP Notebook models, the hard drive cable is available using spare part number 855003-001.	
	For HP 255 G5 models, the hard drive brackets and cable are available in the Hard Drive Hardware Kit, spare part number 859515-001 (ETB), and 859516-001 (non-ETB).	
	HP Notebook PC models:	
	• 2-TB, 5400-rpm, hybrid 8 GB SSD, 9.5 mm	801808-005
	HP Notebook PC and HP 255 G5 Notebook PC models:	
	• 1-TB, 5400-rpm, hybrid 8 GB SSD	731999-005
	• 1-TB, 5400-rpm, 2.5-inch	778192-005
	• 1-TB, 5400-rpm, 2.5-in (for use in India)	676423-855
	• 500-GB, 5400-rpm, 7-mm	778186-005
	HP 255 G5 Notebook PC models:	
	• 500-GB, 7200-rpm, 7-mm	703267-005
	(17)	USB board (includes cable)
(18)	Optical drive board	855007-001
(19)	Fan	813946-001
(20)	Bottom cover	
	For use in HP Notebook PC models:	
	• Models with an optical drive	854999-001
	• Models without an optical drive	857281-001
	For use in HP 255 G5 Notebook PC models:	
	• Models with an optical drive (gray)	859513-001
	• Models without an optical drive (gray)	859514-001
• Models with an optical drive (black)	906832-001	

Item	Component	Spare part number
	<ul style="list-style-type: none"> Models without an optical drive (black) 	906833-001
(21)	Battery	
	4-cell, 41-Whr, 2.8-Ah Li-ion battery	807957-001
	3-cell, 31-Whr, 2.8-Ah Li-ion battery	807956-001
(22)	Rubber Kit (includes rear left and right feet)	813963-001
(23)	Optical drive (DVD+/-RW Double-Layer SuperMulti; includes bracket and bezel)	
	Black	858505-001
	Gray	908491-001

Mass storage devices

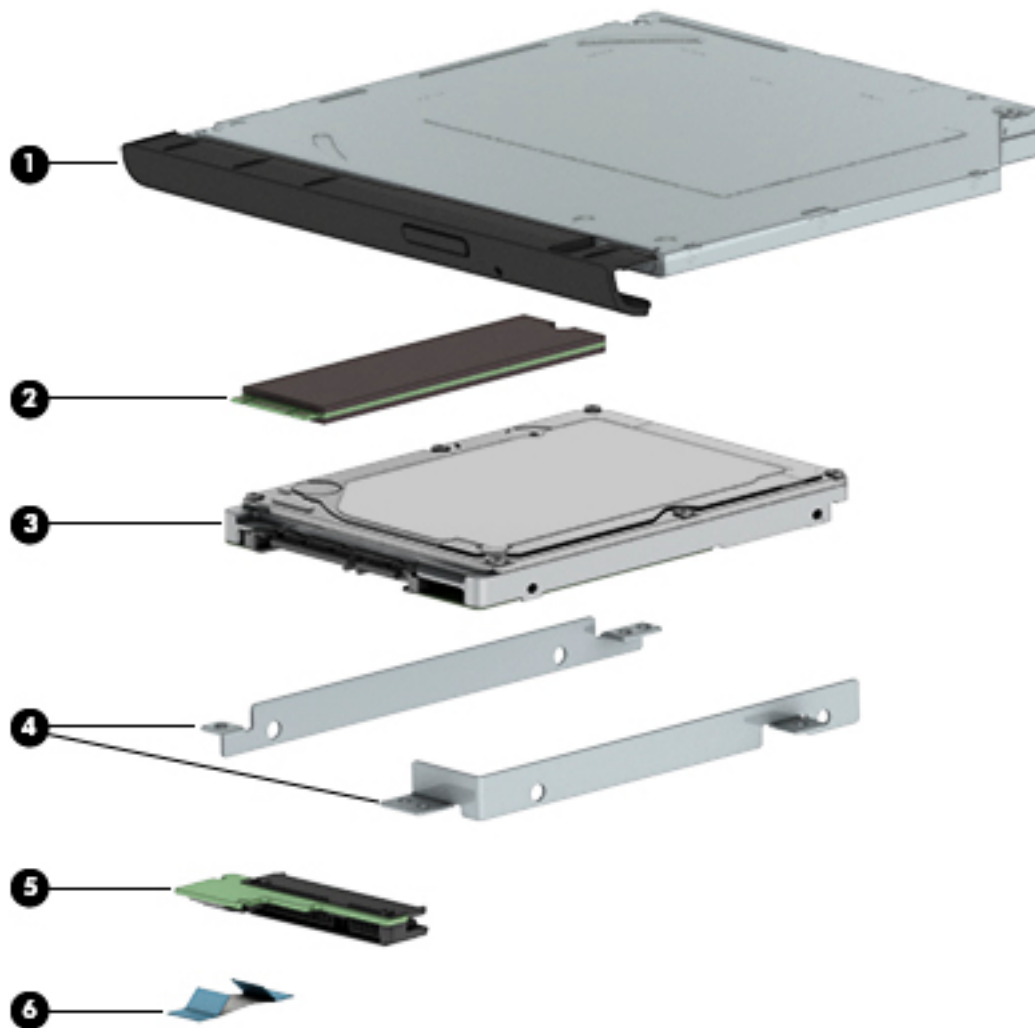

Item	Component	Spare part number
(1)	Optical drive (DVD+/-RW Double-Layer SuperMulti; includes bracket and bezel)	
	Black	858505-001
	Gray	908491-001
(2)	Solid-state drive , M.2, 128 GB	
	256 GB (for use in HP Notebook PC models)	865902-007
	128 GB (for use in HP Notebook PC models)	827560-021
	128 GB (for use in HP 255 G5 Notebook PC models)	863015-001
(3)	Hard drive , SATA; does not include brackets, connector board, or cable):	
	For use in HP Notebook PC models:	
	<ul style="list-style-type: none"> 2-TB, 5400-rpm, hybrid 8 GB SSD, 9.5 mm 	801808-005
	For use in HP Notebook PC and HP 255 G5 Notebook PC models:	

Item	Component	Spare part number
	<ul style="list-style-type: none"> 1-TB, 5400-rpm, hybrid 8 GB SSD 	731999-005
	<ul style="list-style-type: none"> 1-TB, 5400-rpm, 2.5-in 	778192-005
	<ul style="list-style-type: none"> 1-TB, 5400-rpm, 2.5-in (for use in India) 	676423-855
	<ul style="list-style-type: none"> 500-GB, 5400-rpm, 7-mm 	778186-005
	For use in HP 255 G5 Notebook PC models:	
	<ul style="list-style-type: none"> 500-GB, 7200-rpm, 7-mm 	703267-005
(4)	Hard drive brackets (HP 255 G5 models)	859515-001 (ETB) 859516-001 (non-ETB)
(5)	Hard drive connector board	817878-001
(6)	Hard drive cable for use in HP Notebook PC models	855003-001

Miscellaneous parts

Component	Spare part number
HP Smart AC adapter (4.5 mm, non-PFC)	
65-W, for use in HP Notebook PC and HP 255 G5 Notebook PC models	710412-001
65-W EM, for use in HP Notebook PC models	714635-850
65-W, for use in HP 255 G5 Notebook PC models	714657-001
45-W, for use in HP Notebook PC models	741553-850
45-W, for use in HP 255 G5 Notebook PC models	741727-001
Power cord (3-pin, black, 1.00-m):	
For use in Argentina	401300-007
For use in Australia	213356-008
For use in the People's Republic of China	286497-008
For use in Denmark	213353-008
For use in Europe (Austria, Belgium, Finland, France, Germany, the Netherlands, Norway and Sweden)	213350-009
For use in India	404827-003
For use in Israel	Power Cord
For use in Italy	213352-008
For use in Japan	349756-002
For use in North America	213349-009
For use in South Africa	361240-002
For use in South Korea	267836-008
For use in Switzerland	213354-008
For use in Taiwan	393313-003
For use in Thailand	285096-006
For use in the United Kingdom and Singapore	213351-008
Rubber Kit (includes front and rear feet)	813963-001
Screw Kit	855016-001
16 GB USB flash drive	905742-001
Carrying case, black/red Chroma sleeve	853427-001
Carrying case, gray/green Chroma sleeve	853427-041
Carrying case, teal Chroma sleeve	906250-001
HP X3000 wireless mouse	684978-001

Display assembly subcomponents

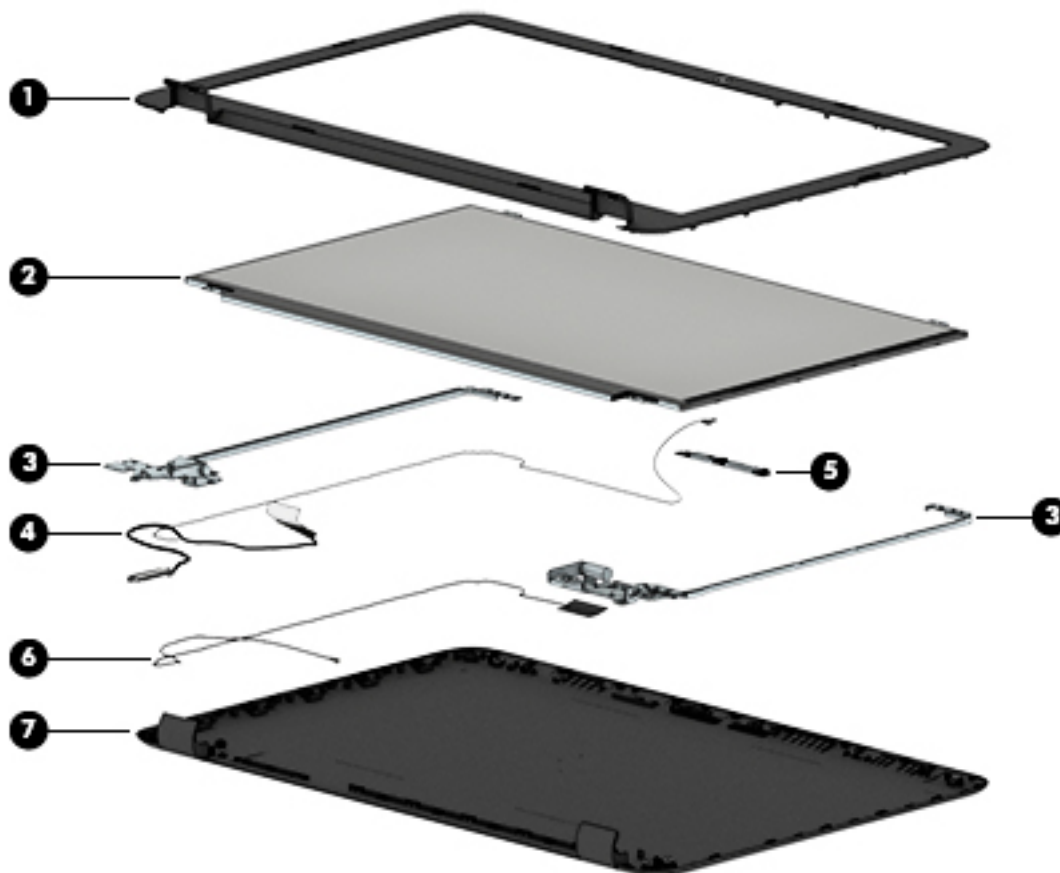

Item	Component	Spare part number
(1)	Display bezel (includes Mylar screw covers)	855000-001
(2)	Raw display panel (39.6-cm [15.6-in])	
	For use in HP Notebook PC models	
	<ul style="list-style-type: none"> FHD, for use in models with a non-touch screen (anti glare) 	798933-007
	<ul style="list-style-type: none"> HD, for use in models with a non-touch screen (anti glare) 	909185-002
	<ul style="list-style-type: none"> HD, for use in models with a touch screen (BrightView) 	809612-010
	<ul style="list-style-type: none"> HD, for use in models with a non-touch screen (BrightView) 	847654-003
	For use in HP Notebook PC and HP 255 G5 Notebook PC models:	
	<ul style="list-style-type: none"> FHD 	864127-001
	<ul style="list-style-type: none"> HD 	864128-001
(3)	Hinges (left and right)	855006-001
(4)	Display cable (includes display panel cable and webcam/microphone cable)	
	Non-touch screen	813943-001
	Touch screen	813944-001

Item	Component	Spare part number
(5)	Webcam/microphone module	
	For use in HP Notebook PC models:	
	• HD	709372-030
	• VGA	766523-019
	For use in HP Notebook PC and HP 255 G5 Notebook PC models:	
	• HD	861336-001
	• VGA	861337-001
(6)	Antenna (includes wireless antenna cable and transceiver)	
	Single	854985-001
	Dual	854986-001
(7)	Display enclosure:	
	For use in all HP Notebook models:	
	• Black models	854992-001
	• Turbo silver models	854987-001
	• Red models	854989-001
	• White silver models	854988-001
	• Noble blue models	854991-001
	• Teal models	854990-001
	• Iris purple models	901745-001
	• Powder blue models	908025-001
	• Soft lilac models	908026-001
	• Misty green models	908027-001
	For use in HP 255 G5 Notebook PC models:	
	• Black models	859511-001
	• Silver models	905913-001

4 Removal and replacement procedures preliminary requirements

Tools required

You will need the following tools to complete the removal and replacement procedures:

- Flat-bladed screwdriver
- Magnetic screwdriver
- Phillips P0 and P1 screwdrivers

Service considerations

The following sections include some of the considerations that you must keep in mind during disassembly and assembly procedures.

 **NOTE:** As you remove each subassembly from the computer, place the subassembly (and all accompanying screws) away from the work area to prevent damage.

Plastic parts

 **CAUTION:** Using excessive force during disassembly and reassembly can damage plastic parts. Use care when handling the plastic parts. Apply pressure only at the points designated in the maintenance instructions.

Cables and connectors

 **CAUTION:** When servicing the computer, be sure that cables are placed in their proper locations during the reassembly process. Improper cable placement can damage the computer.

Cables must be handled with extreme care to avoid damage. Apply only the tension required to unseat or seat the cables during removal and insertion. Handle cables by the connector whenever possible. In all cases, avoid bending, twisting, or tearing cables. Be sure that cables are routed in such a way that they cannot be caught or snagged by parts being removed or replaced. Handle flex cables with extreme care; these cables tear easily.

Drive handling

⚠ CAUTION: Drives are fragile components that must be handled with care. To prevent damage to the computer, damage to a drive, or loss of information, observe these precautions:

Before removing or inserting a hard drive, shut down the computer. If you are unsure whether the computer is off or in Hibernation, turn the computer on, and then shut it down through the operating system.

Before handling a drive, be sure that you are discharged of static electricity. While handling a drive, avoid touching the connector.

Before removing a diskette drive or optical drive, be sure that a diskette or disc is not in the drive and be sure that the optical drive tray is closed.

Handle drives on surfaces covered with at least one inch of shock-proof foam.

Avoid dropping drives from any height onto any surface.

After removing a hard drive, an optical drive, or a diskette drive, place it in a static-proof bag.

Avoid exposing an internal hard drive to products that have magnetic fields, such as monitors or speakers.

Avoid exposing a drive to temperature extremes or liquids.

If a drive must be mailed, place the drive in a bubble pack mailer or other suitable form of protective packaging and label the package "FRAGILE."

Grounding guidelines

Electrostatic discharge damage

Electronic components are sensitive to electrostatic discharge (ESD). Circuitry design and structure determine the degree of sensitivity. Networks built into many integrated circuits provide some protection, but in many cases, ESD contains enough power to alter device parameters or melt silicon junctions.

A discharge of static electricity from a finger or other conductor can destroy static-sensitive devices or microcircuitry. Even if the spark is neither felt nor heard, damage may have occurred.

An electronic device exposed to ESD may not be affected at all and can work perfectly throughout a normal cycle. Or the device may function normally for a while, then degrade in the internal layers, reducing its life expectancy.

⚠ CAUTION: To prevent damage to the computer when you are removing or installing internal components, observe these precautions:

Keep components in their electrostatic-safe containers until you are ready to install them.

Before touching an electronic component, discharge static electricity by using the guidelines described in this section.

Avoid touching pins, leads, and circuitry. Handle electronic components as little as possible.

If you remove a component, place it in an electrostatic-safe container.

The following table shows how humidity affects the electrostatic voltage levels generated by different activities.

⚠ CAUTION: A product can be degraded by as little as 700 V.

Typical electrostatic voltage levels			
Event	Relative humidity		
	10%	40%	55%
Walking across carpet	35,000 V	15,000 V	7,500 V
Walking across vinyl floor	12,000 V	5,000 V	3,000 V
Motions of bench worker	6,000 V	800 V	400 V
Removing DIPs from plastic tube	2,000 V	700 V	400 V
Removing DIPs from vinyl tray	11,500 V	4,000 V	2,000 V
Removing DIPs from Styrofoam	14,500 V	5,000 V	3,500 V
Removing bubble pack from PCB	26,500 V	20,000 V	7,000 V
Packing PCBs in foam-lined box	21,000 V	11,000 V	5,000 V

Packaging and transporting guidelines

Follow these grounding guidelines when packaging and transporting equipment:

- To avoid hand contact, transport products in static-safe tubes, bags, or boxes.
- Protect ESD-sensitive parts and assemblies with conductive or approved containers or packaging.
- Keep ESD-sensitive parts in their containers until the parts arrive at static-free workstations.
- Place items on a grounded surface before removing items from their containers.
- Always be properly grounded when touching a component or assembly.
- Store reusable ESD-sensitive parts from assemblies in protective packaging or non-conductive foam.
- Use transporters and conveyors made of antistatic belts and roller bushings. Be sure that mechanized equipment used for moving materials is wired to ground and that proper materials are selected to avoid static charging. When grounding is not possible, use an ionizer to dissipate electric charges.

Workstation guidelines

Follow these grounding workstation guidelines:

- Cover the workstation with approved static-shielding material.
- Use a wrist strap connected to a properly grounded work surface and use properly grounded tools and equipment.
- Use conductive field service tools, such as cutters, screwdrivers, and vacuums.
- When fixtures must directly contact dissipative surfaces, use fixtures made only of static-safe materials.
- Keep the work area free of nonconductive materials, such as ordinary plastic assembly aids and Styrofoam.
- Handle ESD-sensitive components, parts, and assemblies by the case or PCM laminate. Handle these items only at static-free workstations.
- Avoid contact with pins, leads, or circuitry.
- Turn off power and input signals before inserting or removing connectors or test equipment.

Equipment guidelines

Grounding equipment must include either a wrist strap or a foot strap at a grounded workstation.

- When seated, wear a wrist strap connected to a grounded system. Wrist straps are flexible straps with a minimum of one megohm $\pm 10\%$ resistance in the ground cords. To provide proper ground, wear a strap snugly against the skin at all times. On grounded mats with banana-plug connectors, use alligator clips to connect a wrist strap.
- When standing, use foot straps and a grounded floor mat. Foot straps (heel, toe, or boot straps) can be used at standing workstations and are compatible with most types of shoes or boots. On conductive floors or dissipative floor mats, use foot straps on both feet with a minimum of one megohm resistance between the operator and ground. To be effective, the conductive must be worn in contact with the skin.

The following grounding equipment is recommended to prevent electrostatic damage:

- Antistatic tape
- Antistatic smocks, aprons, and sleeve protectors
- Conductive bins and other assembly or soldering aids
- Nonconductive foam
- Conductive tabletop workstations with ground cords of one megohm resistance
- Static-dissipative tables or floor mats with hard ties to the ground
- Field service kits
- Static awareness labels
- Material-handling packages
- Nonconductive plastic bags, tubes, or boxes
- Metal tote boxes
- Electrostatic voltage levels and protective materials

The following table lists the shielding protection provided by antistatic bags and floor mats.

Material	Use	Voltage protection level
Antistatic plastics	Bags	1,500 V
Carbon-loaded plastic	Floor mats	7,500 V
Metallized laminate	Floor mats	5,000 V

5 Removal and replacement procedures for Customer Self-Repair parts

 **CAUTION:** The Customer Self-Repair program is not available in all locations. Installing a part not supported by the Customer Self-Repair program may void your warranty. Check your warranty to determine if Customer Self-Repair is supported in your location.

 **NOTE:** HP continually improves and changes product parts. For complete and current information on supported parts for your computer, go to <http://partsurfer.hp.com>, select your country or region, and then follow the on-screen instructions.

Component replacement procedures

 **NOTE:** Please read and follow the procedures described here to access and replace Customer Self-Repair parts successfully.

 **NOTE:** Details about your computer, including model, serial number, product key, and length of warranty, are on the service tag at the bottom of your computer. See [Labels on page 22](#) for details.

This chapter provides removal and replacement procedures for Customer Self-Repair parts.

There are as many as 3 screws that must be removed, replaced, or loosened when servicing Customer Self-Repair parts. Make special note of each screw size and location during removal and replacement.

Battery

Description	Spare part number
4-cell, 41-Whr, 2.8-Ah Li-ion battery	807957-001
3-cell, 31-Whr, 2.8-Ah Li-ion battery	807956-001

Before disassembling the computer, follow these steps:

1. Shut down the computer. If you are unsure whether the computer is off or in Hibernation, turn the computer on, and then shut it down through the operating system.
2. Disconnect all external devices connected to the computer.
3. Disconnect the power from the computer by first unplugging the power cord from the AC outlet and then unplugging the AC adapter from the computer.

To remove the battery:

1. Position the computer upside down on a flat surface.
2. Slide the battery lock latch **(1)** to unlock the battery, and then slide the battery release latch **(2)** to release the battery.



NOTE: The battery release latch automatically returns to its original position.

3. Remove the battery **(3)** from the computer.

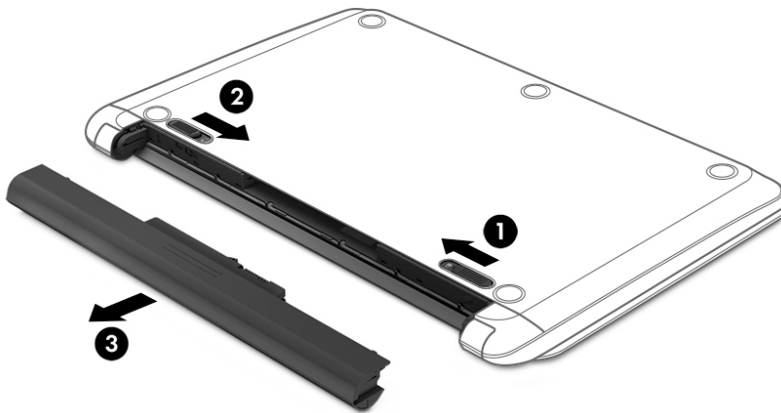

Optical drive



NOTE: Optical drive spare part kits include bracket and bezel.

Description	Spare part number
DVD+/-RW Double-Layer SuperMulti Drive, black	858505-001
DVD+/-RW Double-Layer SuperMulti Drive, gray	908491-001

Before removing the optical drive, follow these steps:

1. Shut down the computer. If you are unsure whether the computer is off or in Hibernation, turn the computer on, and then shut it down through the operating system.
2. Disconnect all external devices connected to the computer.
3. Disconnect the power from the computer by first unplugging the power cord from the AC outlet and then unplugging the AC adapter from the computer.
4. Remove the battery (see [Battery on page 38](#)).

To remove the optical drive:

1. Remove the Phillips PM2.5×8.0 screw **(1)** that secures the optical drive to the computer.
2. Remove the optical drive **(2)** by sliding it out of the optical drive bay.

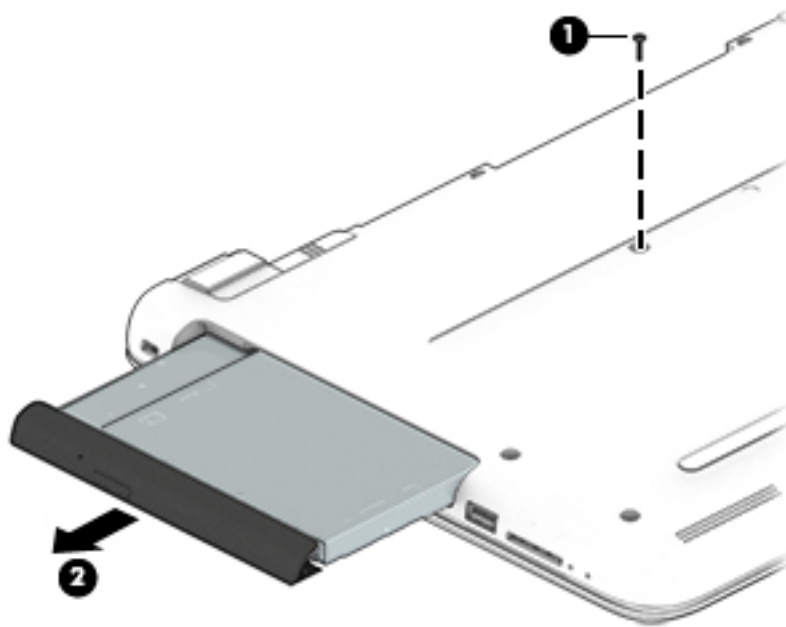

3. If it is necessary to replace the bracket on the rear of the optical drive, remove the two Phillips PM2.0×2.5 screws (1) that secure the bracket to the drive, and then remove the bracket (2).

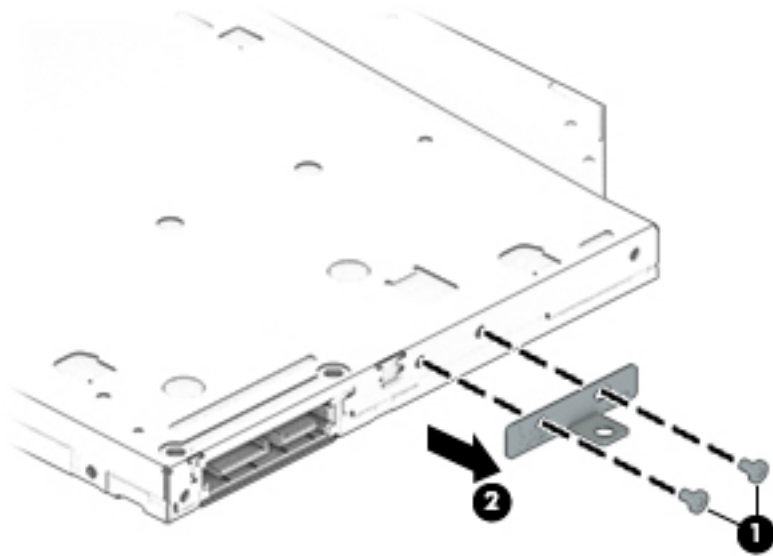

Reverse this procedure to reassemble and install the optical drive.

6 Removal and replacement procedures for Authorized Service Provider parts

 **CAUTION:** Components described in this chapter should only be accessed by an authorized service provider. Accessing these parts can damage the computer or void the warranty.

 **NOTE:** HP continually improves and changes product parts. For complete and current information on supported parts for your computer, go to <http://partsurfer.hp.com>, select your country or region, and then follow the on-screen instructions.

Component replacement procedures

 **NOTE:** Details about your computer, including model, serial number, product key, and length of warranty, are on the service tag at the bottom of your computer. See [Labels on page 22](#) for details.

This chapter provides removal and replacement procedures for Authorized Service Provider only parts.

There are as many as 54 screws that must be removed, replaced, or loosened when servicing Authorized Service Provider only parts. Make special note of each screw size and location during removal and replacement.

Bottom cover

Description	Spare part number
Bottom cover for use on HP Notebook models with an optical drive	854999-001
Bottom cover for use on HP Notebook models without an optical drive	857281-001
Bottom cover for use on HP 255 G5 Notebook PC models with an optical drive (gray)	859513-001
Bottom cover for use on HP 255 G5 Notebook PC models without an optical drive (gray)	859514-001
Bottom cover for use on HP 255 G5 Notebook PC models with an optical drive (black)	906832-001
Bottom cover for use on HP 255 G5 Notebook PC models without an optical drive (black)	906833-001

Before removing the bottom cover, follow these steps:

1. Shut down the computer. If you are unsure whether the computer is off or in Hibernation, turn the computer on, and then shut it down through the operating system.
2. Disconnect all external devices connected to the computer.
3. Disconnect the power from the computer by first unplugging the power cord from the AC outlet and then unplugging the AC adapter from the computer.
4. Remove the battery (see [Battery on page 38](#)).
5. Remove the optical drive (see [Optical drive on page 39](#)), if installed.

To remove the bottom cover:

1. Position the computer upside down with the front toward you.
2. Remove the two rubber bumpers from rear of the bottom of the computer (**1**)
3. Remove the 11 Phillips PM2.5×8.0 screws (**2**) that secure the bottom cover to the computer.

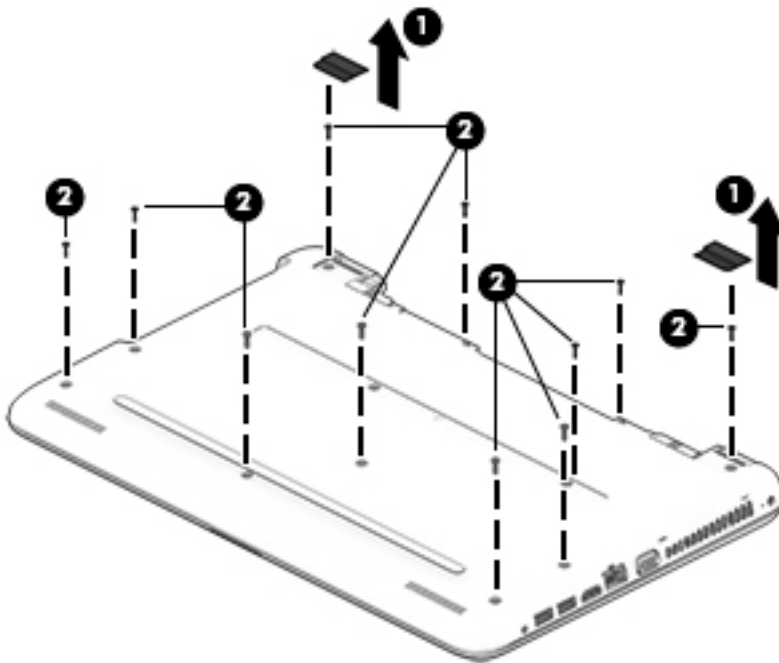

4. Start prying at the front of the computer and work around to the back to separate the bottom cover from computer.
5. Remove the bottom cover.

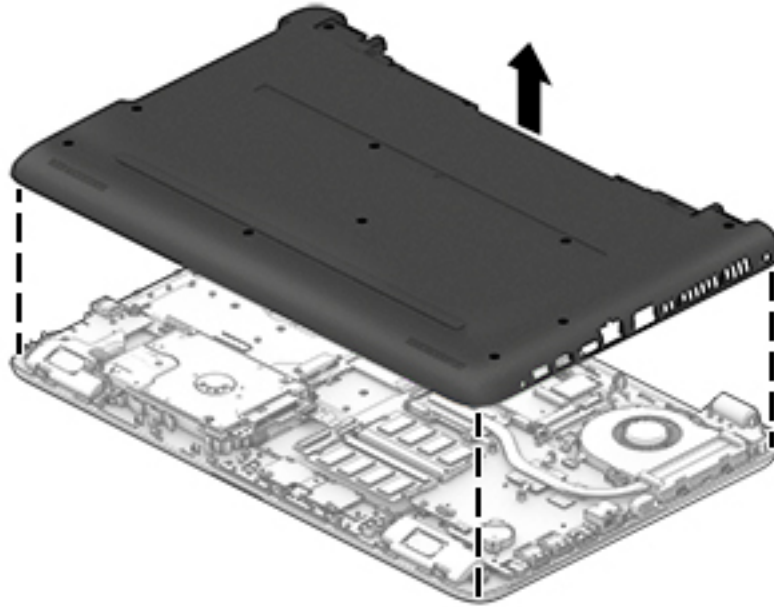

Reverse this procedure to install the bottom cover.

WLAN module

Description	Spare part number
Realtek RTL8723BE-VB 802.11b/g/n 1x1 Wi-Fi + BT4.0 Combo Adapter	855106-855
Intel Dual Band Wireless-AC 3165 802.11 ac 1x1 WiFi + BT 4.2 Combo	806723-005
Realtek RTL8188EE-VJ 802.11b/g/n 1x1 Wi-Fi Adapter	857334-855
Realtek RTL8723BE 802.11b/g/n 1x1 Wi-Fi + BT4.0 Combo Adapter	792505-855
Intel Dual Band Wireless-AC 3168 802.11 ac 1x1 WiFi + BT 4.2 Combo Adapter	863934-855

 **CAUTION:** To prevent an unresponsive system, replace the wireless module only with a wireless module authorized for use in the computer by the governmental agency that regulates wireless devices in your country or region. If you replace the module and then receive a warning message, remove the module to restore device functionality, and then contact support.

Before removing the WLAN module, follow these steps:

1. Shut down the computer. If you are unsure whether the computer is off or in Hibernation, turn the computer on, and then shut it down through the operating system.
2. Disconnect all external devices connected to the computer.
3. Disconnect the power from the computer by first unplugging the power cord from the AC outlet and then unplugging the AC adapter from the computer.
4. Remove the battery (see [Battery on page 38](#)).
5. Remove the optical drive (see [Optical drive on page 39](#)), if installed.
6. Remove the bottom cover (see [Bottom cover on page 42](#)).

To remove the WLAN module:

1. Disconnect the WLAN antenna cable **(1)** from the terminal on the WLAN module.



NOTE: The #1 WLAN antenna cable is connected to the WLAN module Main terminal.

2. Remove the Phillips PM2.0×3.0 screw **(2)** that secures the WLAN module to the system board. (The WLAN module tilts up.)

3. Remove the WLAN module by pulling the module away from the slot at an angle (3).

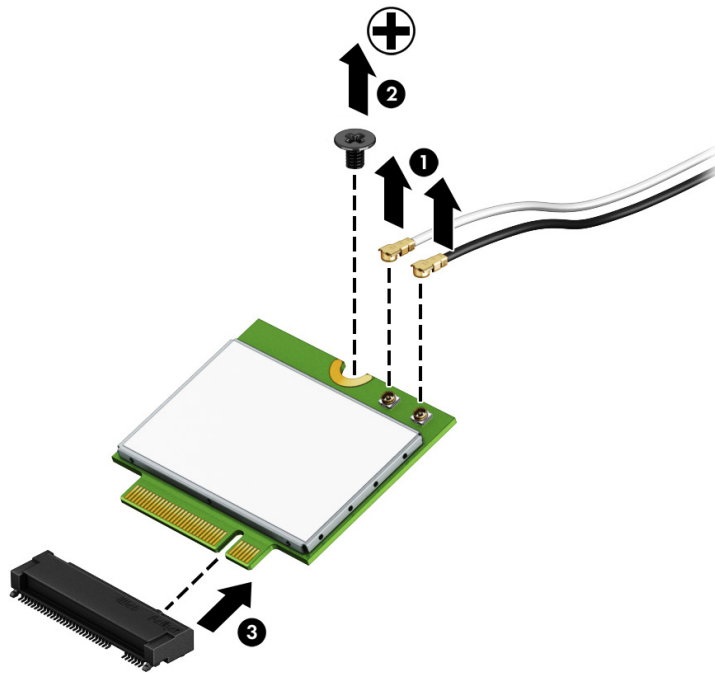

 **NOTE:** If the WLAN antennas are not connected to the terminals on the WLAN module, the protective sleeves must be installed on the antenna connectors, as shown in the following illustration.

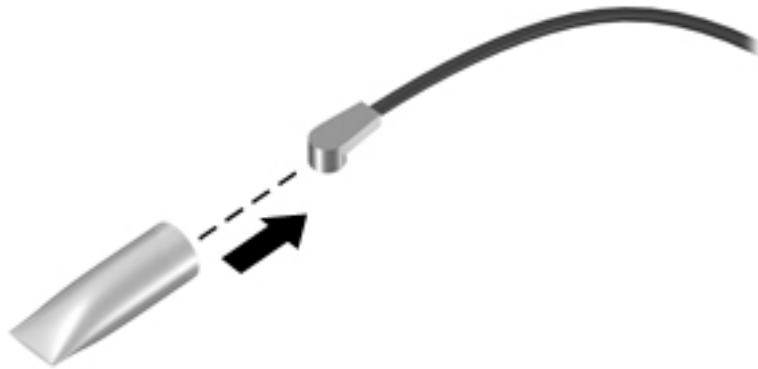

Reverse this procedure to install the WLAN module.

Memory module

Description	Spare part number
Memory module (PC3L, 12800, 1600-MHz)	
For use in models with AMD A8, A6, E2 processors:	
8-GB	693374-005
4-GB	691740-005
2-GB	691739-005
Memory module (PC4, 17000, 2133-MHz)	
For use in models with AMD A10 and A9 processors:	
8-GB	820570-005
4-GB	820569-005
2-GB	851379-005

Before removing a memory module, follow these steps:

1. Shut down the computer. If you are unsure whether the computer is off or in Hibernation, turn the computer on, and then shut it down through the operating system.
2. Disconnect all external devices connected to the computer.
3. Disconnect the power from the computer by first unplugging the power cord from the AC outlet and then unplugging the AC adapter from the computer.
4. Remove the battery (see [Battery on page 38](#)).
5. Remove the optical drive (see [Optical drive on page 39](#)), if installed.
6. Remove the bottom cover (see [Bottom cover on page 42](#)).

To remove a memory module:

1. Spread the retaining tabs **(1)** on each side of the memory module slot to release the memory module. (The memory module tilts up.)

2. Remove the memory module (2) by pulling it away from the slot at an angle.

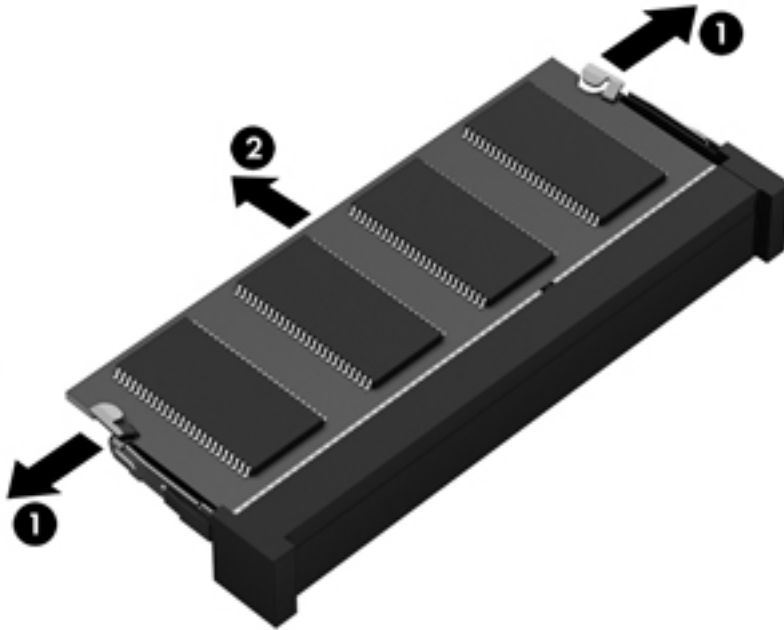

Reverse this procedure to install a memory module.

Optical drive board

Description	Spare part number
Optical drive board (includes cable)	855007-001

Before removing the optical drive board, follow these steps:

1. Shut down the computer. If you are unsure whether the computer is off or in Hibernation, turn the computer on, and then shut it down through the operating system.
2. Disconnect all external devices connected to the computer.
3. Disconnect the power from the computer by first unplugging the power cord from the AC outlet and then unplugging the AC adapter from the computer.
4. Remove the battery (see [Battery on page 38](#)).
5. Remove the optical drive (see [Optical drive on page 39](#)), if installed.
6. Remove the bottom cover (see [Bottom cover on page 42](#)).

To remove the optical drive board:

1. Disconnect the cable from the system board **(1)**.
2. Remove the Phillips PM2.0×2.4 screw **(2)** that secures the optical drive board to the computer.
3. Rotate the connector side of the board upward, and then pull the board and cable up and out of the computer **(3)**.

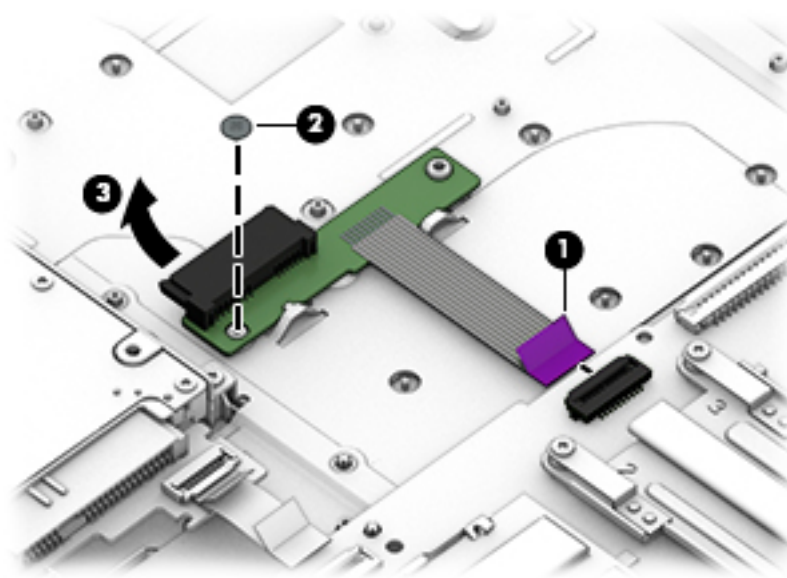

Reverse this procedure to install the optical drive board and cable.

Speakers

Description	Spare part number
Speakers (includes left and right speakers and cable)	813965-001

Before removing the speakers, follow these steps:

1. Shut down the computer. If you are unsure whether the computer is off or in Hibernation, turn the computer on, and then shut it down through the operating system.
2. Disconnect all external devices connected to the computer.
3. Disconnect the power from the computer by first unplugging the power cord from the AC outlet and then unplugging the AC adapter from the computer.
4. Remove the battery (see [Battery on page 38](#)).
5. Remove the optical drive (see [Optical drive on page 39](#)), if installed.
6. Remove the bottom cover (see [Bottom cover on page 42](#)).

To remove the speakers:

1. Disconnect the speaker cable from the system board (1).
2. Remove the cable from the routing path (2), and then lift up and remove the speakers from the computer (3).

 **NOTE:** The speakers are not secured with screws. Note the rubber gaskets (4) that help secure the speakers to the computer. When installing the speakers, make sure the gaskets are installed correctly.

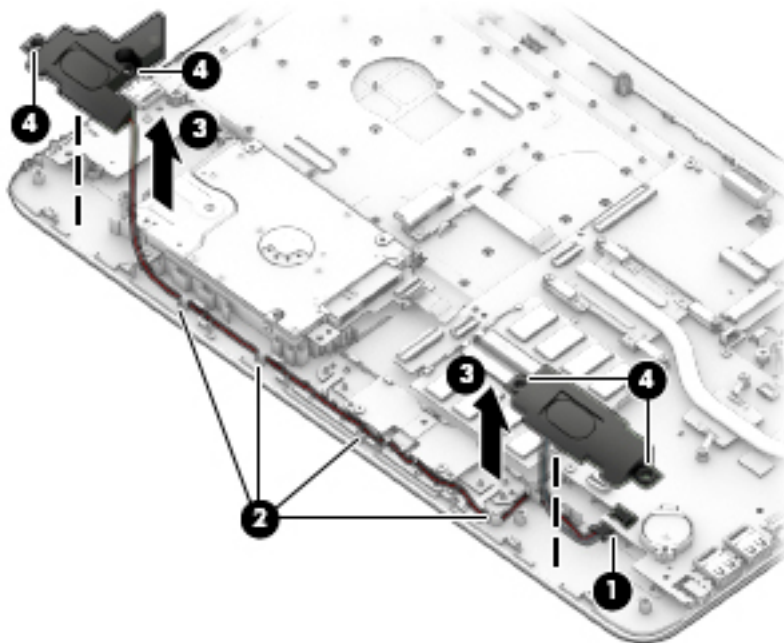

Reverse this procedure to install the speakers.

Hard drive



NOTE: The hard drive spare part kit does not include the hard drive bracket, cable, or connector board.

Description	Spare part number
Hard drive for use in HP Notebook PC models:	
2-TB, 5400-rpm, hybrid 8 GB SSD, 9.5 mm	801808-005
Hard drive for use in HP Notebook PC and HP 255 G5 Notebook PC models:	
1-TB, 5400-rpm, hybrid 8 GB SSD	731999-005
1-TB, 5400-rpm, 2.5-in	778192-005
1-TB, 5400-rpm, 2.5-in (for use in India)	676423-855
500-GB, 5400-rpm, 7-mm	778186-005
Hard drive for use in HP 255 G5 Notebook PC models:	
500-GB, 7200-rpm, 7-mm	703267-005
Hard drive connector board	817878-001
Hard drive cable for use in HP Notebook PC models	855003-001
Hard Drive Hardware Kit (ETB) for use in HP 255 G5 models	859515-001
Hard Drive Hardware Kit (non-ETB) for use in HP 255 G5 models	859516-001

Before removing the hard drive, follow these steps:

1. Shut down the computer. If you are unsure whether the computer is off or in Hibernation, turn the computer on, and then shut it down through the operating system.
2. Disconnect all external devices connected to the computer.
3. Disconnect the power from the computer by first unplugging the power cord from the AC outlet and then unplugging the AC adapter from the computer.
4. Remove the battery (see [Battery on page 38](#)).
5. Remove the optical drive (see [Optical drive on page 39](#)), if installed.
6. Remove the bottom cover (see [Bottom cover on page 42](#)).

To remove the hard drive:

1. Disconnect the hard drive cable from the system board **(1)**.
2. Remove the three Phillips PM2.0×3.0 screws **(2)** that secure the hard drive assembly to the computer.

3. Lift the hard drive assembly from the computer **(3)**.

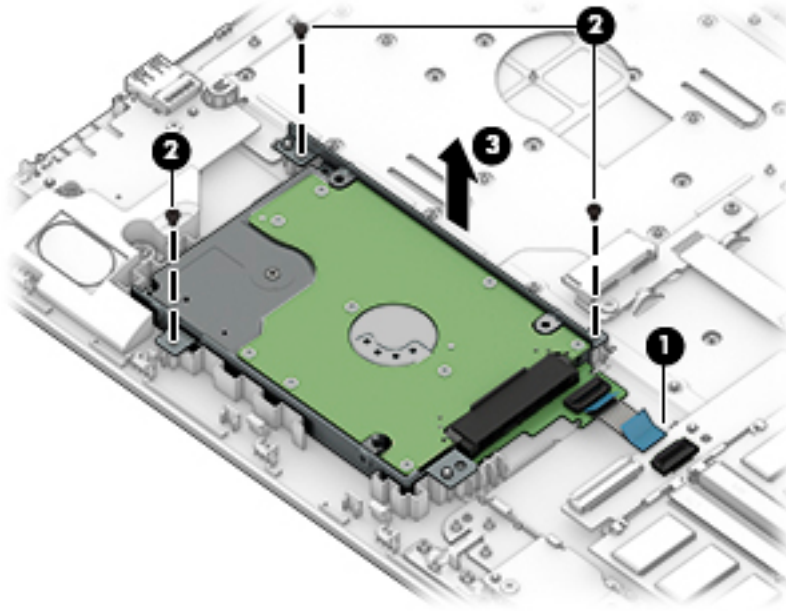

4. To remove the hard drive connector board, pull the connector away from the drive to remove it **(1)**.
5. To remove the hard drive cable from the connector board, disconnect the cable from the connector on the board and remove it **(2)**.

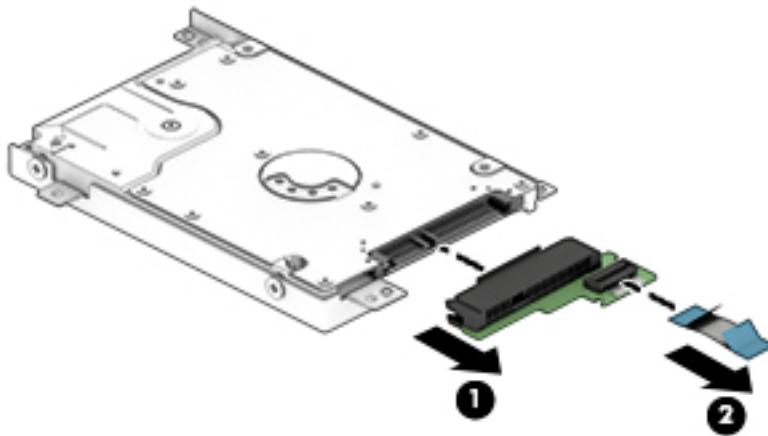

6. To remove the hard drive brackets, remove the two Phillips PM3.0×3.0 screws **(1)** that secure each bracket to the hard drive.

7. Remove the hard drive brackets from the hard drive (2).

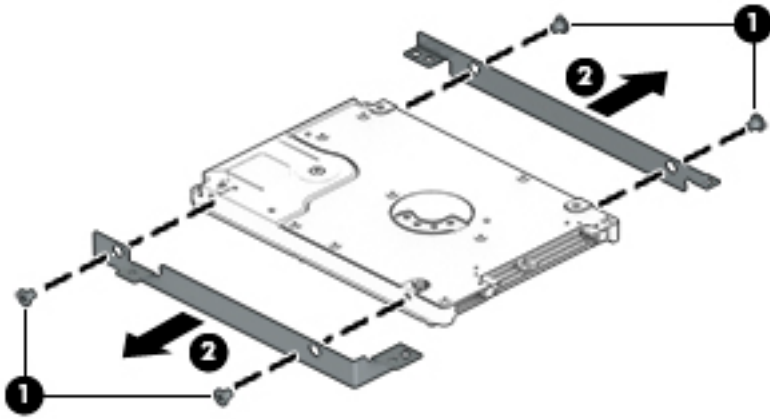

Reverse this procedure to reassemble and install the hard drive.

RTC battery

Description	Spare part number
RTC battery	760828-001

Before removing the RTC battery, follow these steps:

1. Shut down the computer. If you are unsure whether the computer is off or in Hibernation, turn the computer on, and then shut it down through the operating system.
2. Disconnect all external devices connected to the computer.
3. Disconnect the power from the computer by first unplugging the power cord from the AC outlet and then unplugging the AC adapter from the computer.
4. Remove the battery (see [Battery on page 38](#)).
5. Remove the optical drive (see [Optical drive on page 39](#)), if installed.
6. Remove the bottom cover (see [Bottom cover on page 42](#)).

To remove the RTC battery:

- ▲ Using a thin tool or screwdriver, disengage the battery from the socket **(1)**, and then remove the battery **(2)**.

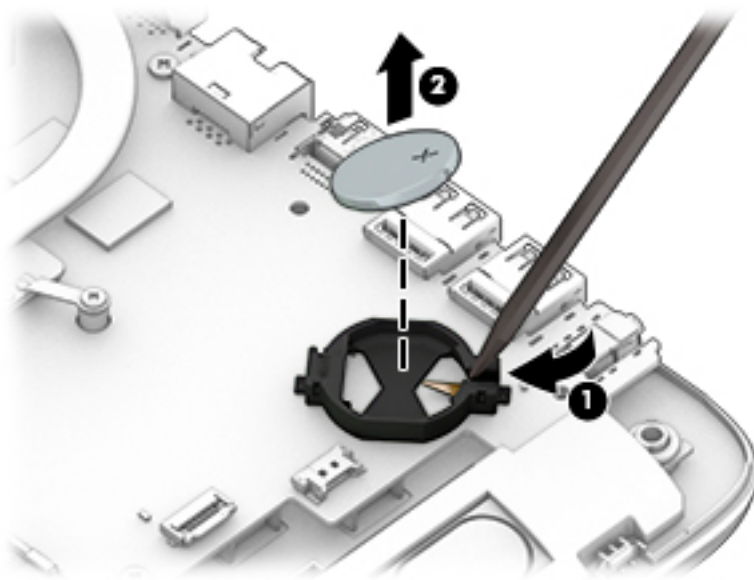

Reverse this procedure to install the RTC battery.

USB board

Description	Spare part number
USB board (includes cable)	855010-001

Before removing the USB board, follow these steps:

1. Shut down the computer. If you are unsure whether the computer is off or in Hibernation, turn the computer on, and then shut it down through the operating system.
2. Disconnect all external devices connected to the computer.
3. Disconnect the power from the computer by first unplugging the power cord from the AC outlet and then unplugging the AC adapter from the computer.
4. Remove the battery (see [Battery on page 38](#)).
5. Remove the optical drive (see [Optical drive on page 39](#)), if installed.
6. Remove the bottom cover (see [Bottom cover on page 42](#)).
7. Remove the hard drive, hard drive cable, and hard drive board (see [Hard drive on page 50](#)).

To remove the USB board:

1. Disconnect the USB board cable from the system board **(1)** and lift the cable to disengage the adhesive that secures it to the computer..
2. Remove the Phillips PM2.0×3.0 screw **(2)** that secures the USB board to the computer.
3. Remove the USB board and cable **(3)**.

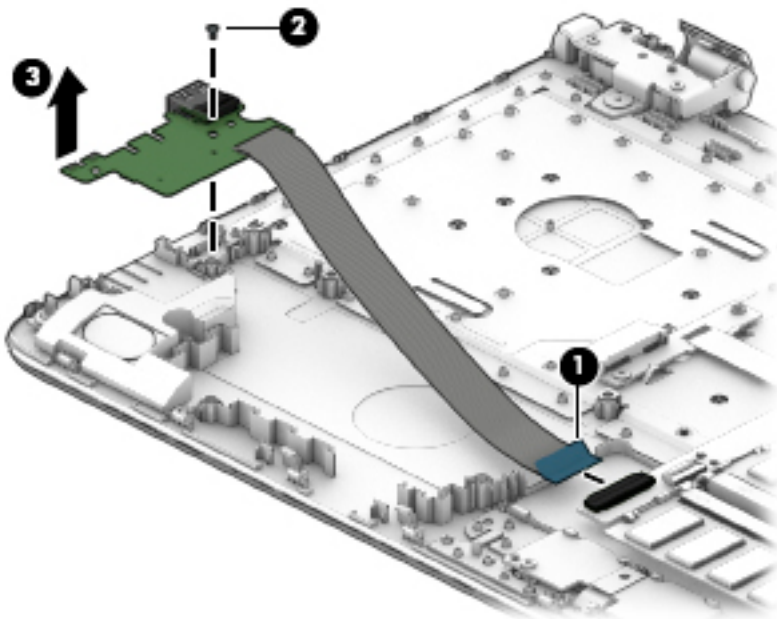

Reverse this procedure to install the USB board.

Solid-state drive (SSD)

Description	Spare part number
Solid-state drive, 256-GB, M.2, for use in HP Notebook PC models	865902-007
Solid-state drive, 128-GB, M.2, for use in HP Notebook PC models	827560-021
Solid-state drive, 128-GB, M.2, for use in HP 255 G5 Notebook PC models	863015-001

Before removing the solid-state drive, follow these steps:

1. Shut down the computer. If you are unsure whether the computer is off or in Hibernation, turn the computer on, and then shut it down through the operating system.
2. Disconnect all external devices connected to the computer.
3. Disconnect the power from the computer by first unplugging the power cord from the AC outlet and then unplugging the AC adapter from the computer.
4. Remove the battery (see [Battery on page 38](#)).
5. Remove the optical drive (see [Optical drive on page 39](#)), if installed.
6. Remove the bottom cover (see [Bottom cover on page 42](#)).

Remove the solid-state drive:

1. Remove the Phillips PM2.0×2.0 screw **(1)** that secures the drive to the system board.
2. Remove the drive **(2)** by pulling it away from the connector.

 **NOTE:** Solid-state drives are designed with notches to prevent incorrect insertion.

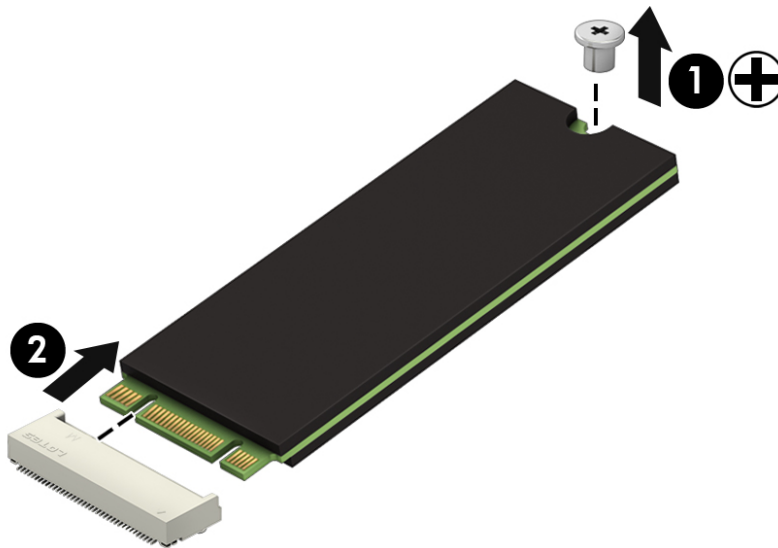

Reverse this procedure to reassemble and install the solid-state drive.

Solid-state drive board

Description	Spare part number
Solid-state drive board (includes cable)	850946-001

Before removing the solid-state drive board, follow these steps:

1. Shut down the computer. If you are unsure whether the computer is off or in Hibernation, turn the computer on, and then shut it down through the operating system.
2. Disconnect all external devices connected to the computer.
3. Disconnect the power from the computer by first unplugging the power cord from the AC outlet and then unplugging the AC adapter from the computer.
4. Remove the battery (see [Battery on page 38](#)).
5. Remove the optical drive (see [Optical drive on page 39](#)), if installed.
6. Remove the bottom cover (see [Bottom cover on page 42](#)).

To remove the solid-state drive board:

1. Disconnect the cable from the system board **(1)**.
2. Remove the three Phillips PM2.0×3.0 screws **(2)** that secure the solid-state drive board and holder to the computer.
3. Lift the board out of the computer **(3)**.

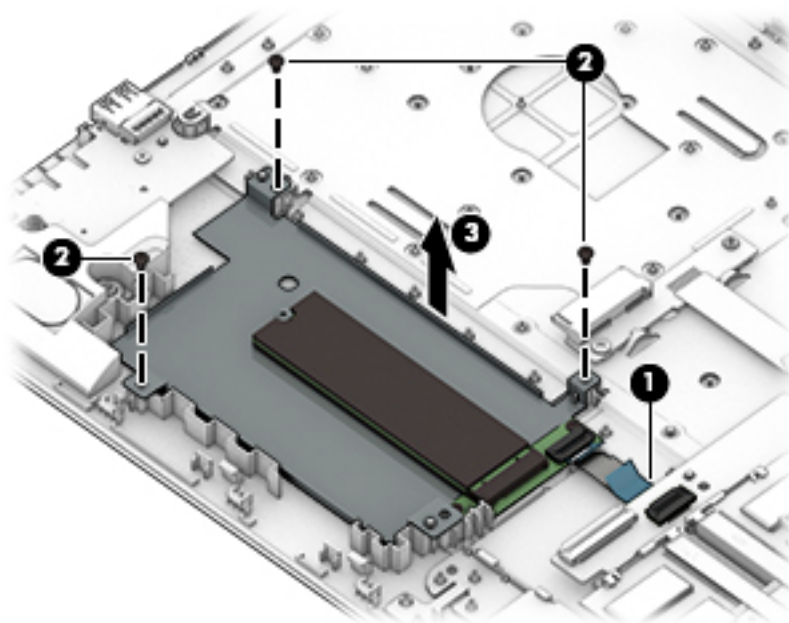

4. Remove the solid-state drive from the holder (see [Solid-state drive \(SSD\) on page 55](#)).

Reverse this procedure to install the solid-state drive board and cable.

Heat sink assembly



NOTE: The heat sink assembly spare part kit includes replacement thermal materials.

Description	Spare part number
Heat sink for use in models with AMD A8, A6, E2 processors and discrete graphics memory	813948-001
Heat sink for use in models with AMD A10 processors and discrete graphics memory	854971-001
Heat sink for use in models with AMD A8, A6, E2 processors and UMA graphics memory	813947-001
Heat sink for use in models with AMD A10 processors and UMA graphics memory	854970-001
Heat sink for use in models with AMD A9 processors and UMA graphics memory	908075-001



NOTE: To properly ventilate the computer, allow at least **7.6 cm (3.0 in)** of clearance on the left side of the computer. The computer uses an electric fan for ventilation. The fan is controlled by a temperature sensor and is designed to turn on automatically when high temperature conditions exist. These conditions are affected by high external temperatures, system power consumption, power management/battery conservation configurations, battery fast charging, and software requirements. Exhaust air is displaced through the ventilation grill located on the left side of the computer.

Before removing the heat sink assembly, follow these steps:

1. Shut down the computer. If you are unsure whether the computer is off or in Hibernation, turn the computer on, and then shut it down through the operating system.
2. Disconnect all external devices connected to the computer.
3. Disconnect the power from the computer by first unplugging the power cord from the AC outlet and then unplugging the AC adapter from the computer.
4. Remove the battery (see [Battery on page 38](#)).
5. Remove the optical drive (see [Optical drive on page 39](#)), if installed.
6. Remove the bottom cover (see [Bottom cover on page 42](#)).

To remove the heat sink assembly:

1. Refer to the following heat sink removal image that matches your computer.
2. Loosen the screws on the heat sink **(1)** that secure the heat sink assembly to the system board.

3. Remove the heat sink assembly from the system board (2).

 **NOTE:** Heat sink appearance may vary.

Discrete graphics

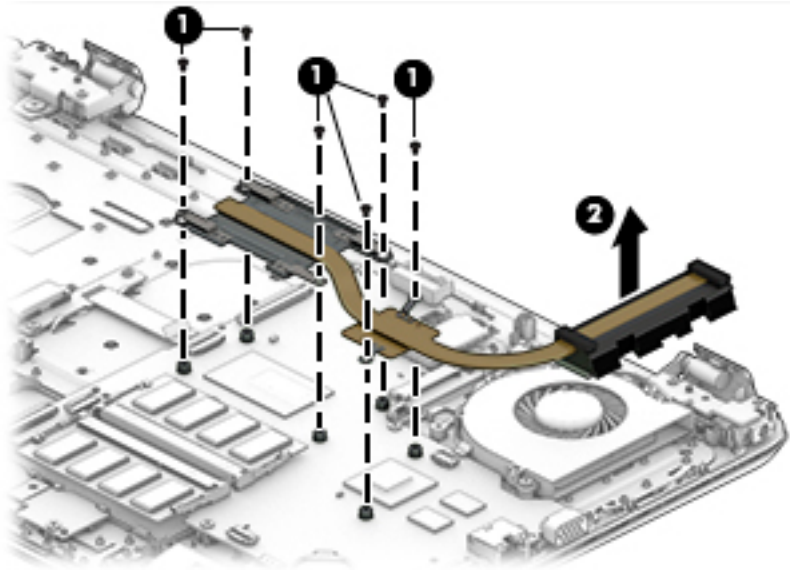

UMA graphics

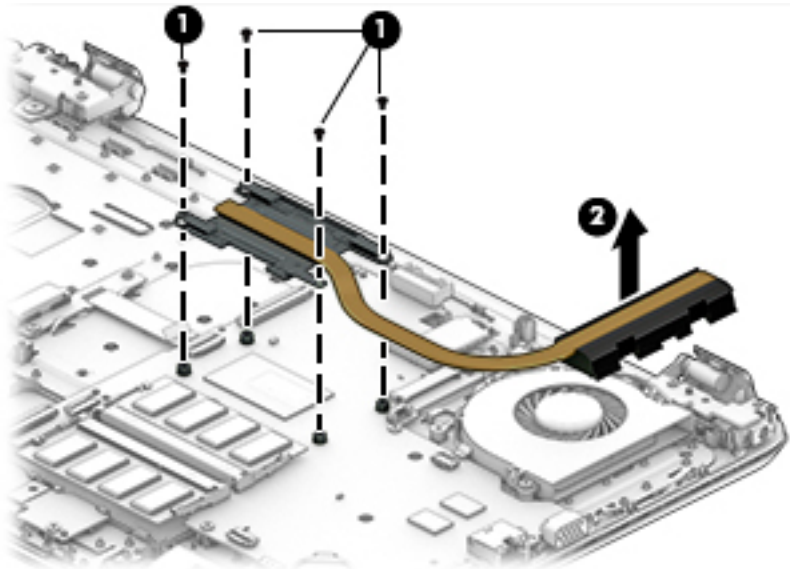

- **Discrete graphics** Thermal paste is used on the processor and associated heat sink area (1)(2), as well as the graphics chip and associated heat sink area (3)(4).

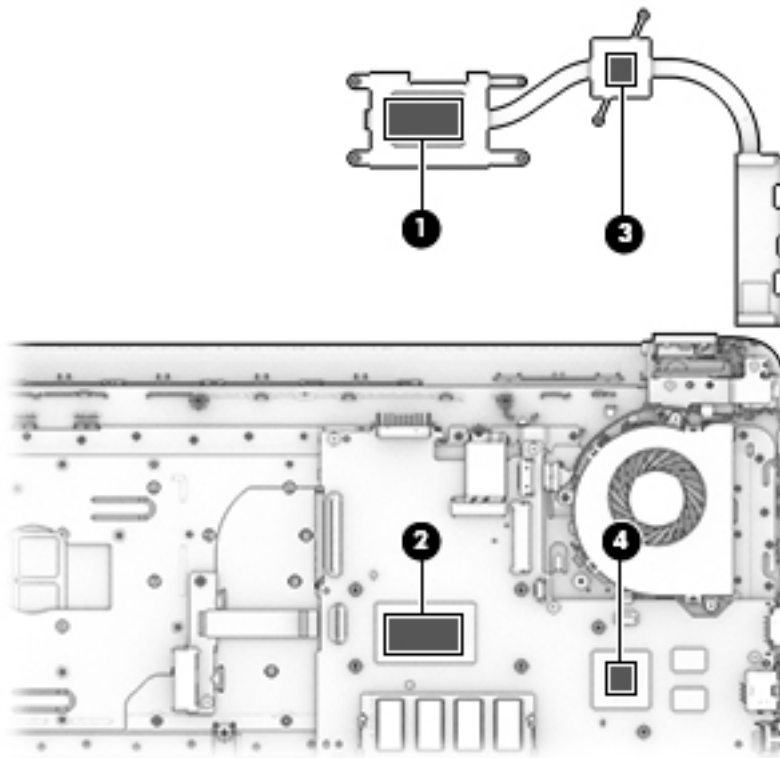

- **UMA graphics** Thermal paste is used on the heat sink (1) and the processor (2).

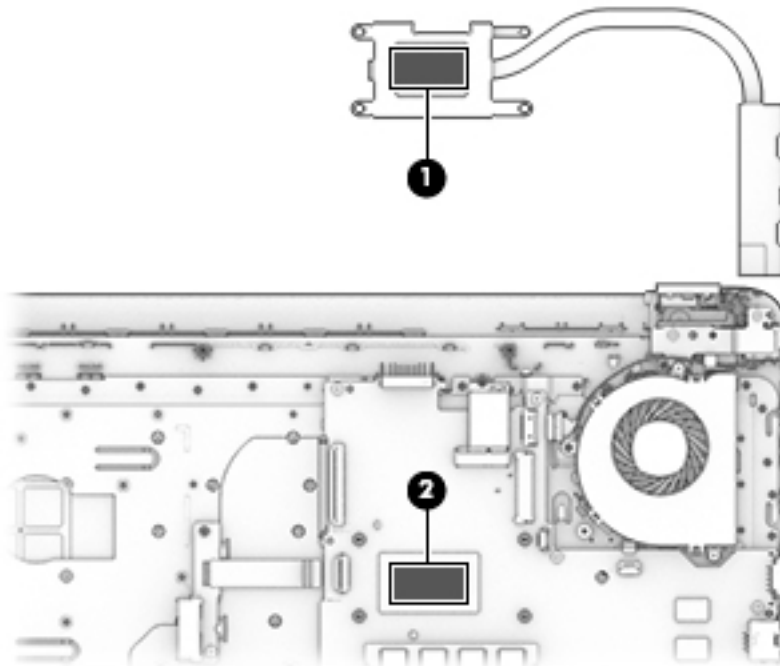

Reverse this procedure to reassemble and install the heat sink assembly.

Fan

Description	Spare part number
Fan	813946-001

 **NOTE:** To properly ventilate the computer, allow at least **7.6 cm** (3.0 in) of clearance on the left side of the computer. The computer uses an electric fan for ventilation. The fan is controlled by a temperature sensor and is designed to turn on automatically when high temperature conditions exist. These conditions are affected by high external temperatures, system power consumption, power management/battery conservation configurations, battery fast charging, and software requirements. Exhaust air is displaced through the ventilation grill located on the left side of the computer.

Before removing the fan/heat sink assembly, follow these steps:

1. Shut down the computer. If you are unsure whether the computer is off or in Hibernation, turn the computer on, and then shut it down through the operating system.
2. Disconnect all external devices connected to the computer.
3. Disconnect the power from the computer by first unplugging the power cord from the AC outlet and then unplugging the AC adapter from the computer.
4. Remove the battery (see [Battery on page 38](#)).
5. Remove the optical drive (see [Optical drive on page 39](#)), if installed.
6. Remove the bottom cover (see [Bottom cover on page 42](#)).

To remove the fan:

1. Disconnect the fan cable **(1)** from the system board.
2. Remove the two Phillips PM2.5×6.0 screws **(2)** that secure the fan to the computer.
3. If necessary, lift the plastic from the top of the clip that the cable routes under, and then remove the cable from under the clip.

4. Remove the fan from the computer (3).

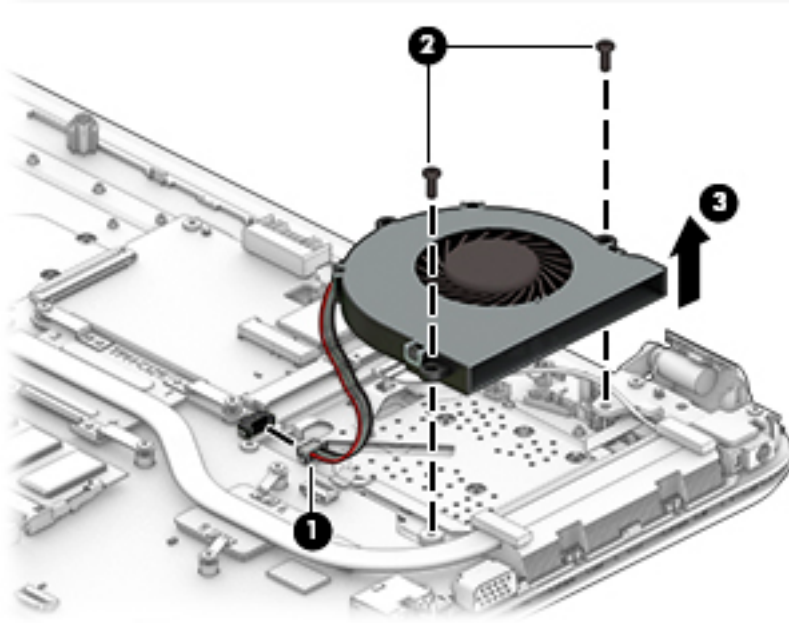

Reverse this procedure to install the fan.

TouchPad button board

Description	Spare part number
TouchPad button board (includes bracket and cables)	855011-001

Before removing the TouchPad button board, follow these steps:

1. Shut down the computer. If you are unsure whether the computer is off or in Hibernation, turn the computer on, and then shut it down through the operating system.
2. Disconnect all external devices connected to the computer.
3. Disconnect the power from the computer by first unplugging the power cord from the AC outlet and then unplugging the AC adapter from the computer.
4. Remove the battery (see [Battery on page 38](#)).
5. Remove the optical drive (see [Optical drive on page 39](#)), if installed.
6. Remove the bottom cover (see [Bottom cover on page 42](#)).
7. Remove the memory module (see [Memory module on page 46](#)).

To remove the TouchPad button board:

1. Disconnect the shorter cable from the TouchPad **(1)** and the longer cable from the system board **(2)**.
2. Remove the two Phillips PM2.0×3.0 screws **(3)** that secure the TouchPad button board to the computer.
3. Pull the TouchPad button board toward the bottom of the computer, and then remove the TouchPad and cables **(4)**.

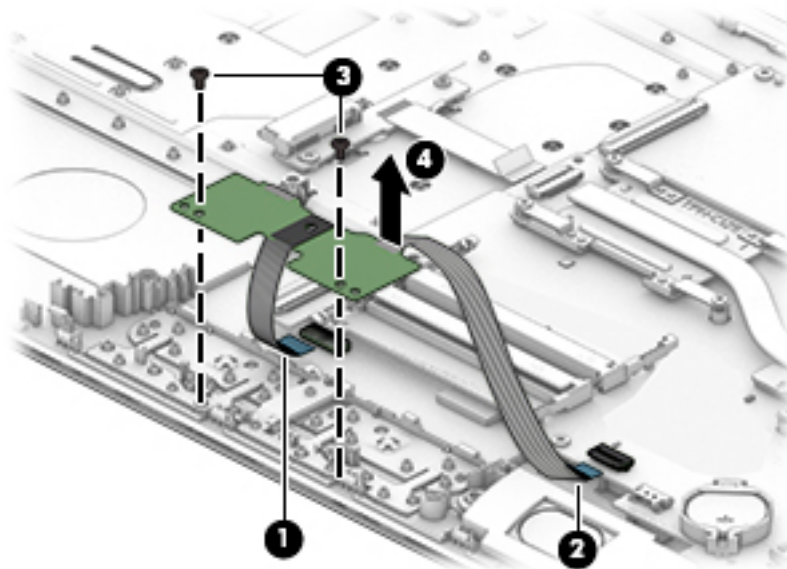

Reverse this procedure to install the TouchPad button board and cables.

System board



NOTE: The system board spare part kit includes replacement thermal materials.

Description	Spare part number
System board (includes replacement thermal materials):	
All system boards use the following part numbers:	
xxxxxx-001: Windows 7 or non-Windows operating systems	
xxxxxx-601: Windows 10 operating system	
For use in HP Notebook PC models (Discrete graphics memory; non-touch screen models):	
• AMD A10-9600P processor and 4 GB of discrete graphics memory (R7M1-70)	854959-xx1
• AMD A10-9600P processor and 2 GB of discrete graphics memory (R7M1-70)	854960-xx1
• AMD A8-7410 processor and 4 GB of discrete graphics memory (R7M1-70)	854963-xx1
• AMD A8-7410 processor and 2 GB of discrete graphics memory (R5M1-30)	854964-xx1
• AMD A6-7310 processor and 2 GB of discrete graphics memory (R5M1-30)	854967-xx1
For use in HP Notebook models (UMA graphics memory; non-touch screen)::	
• AMD A12-9700P processor	902570-xx1
• AMD A10-9600P processor	854957-xx1
• AMD A8-7410 processor	854961-xx1
• AMD A6-7310 processor	854965-xx1
• AMD E2-7110 processor	854968-xx1
For use in HP Notebook models (UMA graphics memory; touch screen)::	
• AMD A10-9600P processor	854958-xx1
• AMD A9-9410 processor	854969-xx1
• AMD A8-7410 processor	854962-xx1
• AMD A6-7310 processor	854966-xx1
For use in HP 255 G5 Notebook PC models (UMA graphics memory; non-touch screen):	
• AMD A8-7410 processor	858587-xx1
• AMD A6-7310 processor	858588-xx1
• AMD E2-7110 processor	858589-xx1

Before removing the system board, follow these steps:

1. Shut down the computer. If you are unsure whether the computer is off or in Hibernation, turn the computer on, and then shut it down through the operating system.
2. Disconnect all external devices connected to the computer.
3. Disconnect the power from the computer by first unplugging the power cord from the AC outlet and then unplugging the AC adapter from the computer.

4. Remove the battery (see [Battery on page 38](#)).
5. Remove the optical drive (see [Optical drive on page 39](#)), if installed.
6. Remove the bottom cover (see [Bottom cover on page 42](#)).
7. Remove the WLAN module (see [WLAN module on page 44](#)).
8. Remove the memory module (see [Memory module on page 46](#)).
9. Remove the solid-state drive (see [Solid-state drive \(SSD\) on page 55](#)).

To remove the system board:

1. Position the computer upright, and then disconnect the following cables from the system board:

- (1): Keyboard cable
- (2): Optical drive connector cable
- (3): Hard drive cable
- (4): USB board cable
- (5): TouchPad button board cable
- (6): Speaker cable
- (7): Fan cable
- (8): Power button board cable
- (9): Display cable
- (10): Power connector cable

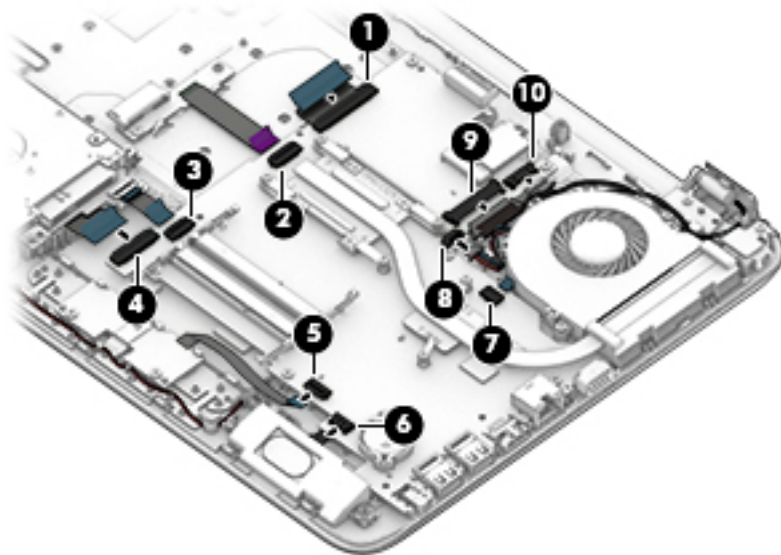

2. Remove the four Phillips PM2.5×3.0 screws (1) that secure the system board to the computer.

3. Lift the system board out of the computer (2).

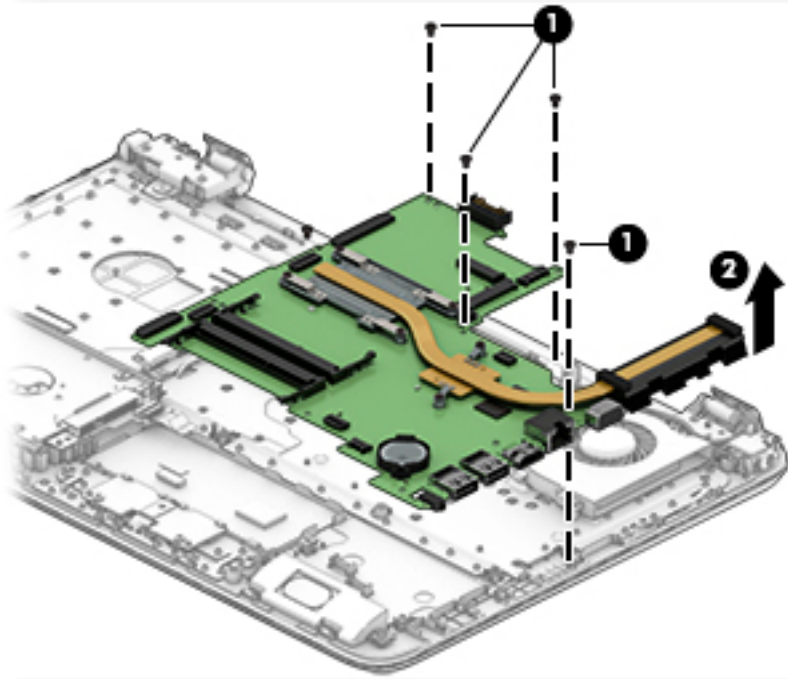

Reverse this procedure to install the system board.

Display assembly

This section describes removing the display assembly and disassembling display subcomponents. You must remove the display from the computer to disassemble display subcomponents.

Description	Spare part number
Raw display panel (39.6-cm [15.6-in])	
For use in HP Notebook PC models	
<ul style="list-style-type: none">FHD, for use in models with a non-touch screen (anti glare)	798933-007
<ul style="list-style-type: none">HD, for use in models with a non-touch screen (anti glare)	909185-002
<ul style="list-style-type: none">HD, for use in models with a touch screen (BrightView)	847654-003
<ul style="list-style-type: none">HD, for use in models with a non-touch screen (BrightView)	809612-010
For use in HP Notebook PC and HP 255 G5 Notebook PC models:	
<ul style="list-style-type: none">FHD	864127-001
<ul style="list-style-type: none">HD	864128-001
Antenna (includes wireless antenna cable and transceiver)	
Single	854985-001
Dual	854986-001
Display bezel	855000-001
Display cable	
For use in non-touch screen models (includes display panel cable and webcam/microphone cable)	813943-001
For use in touch screen models (includes display panel cable and webcam/microphone cable)	813944-001
Display enclosure for use in all HP Notebook PC models:	
Black models	854992-001
Red models	854989-001
White silver models	854988-001
Turbo silver models	854987-001
Noble blue models	854991-001
Teal models	854990-001
Iris purple models	901745-001
Powder blue models	908025-001
Soft lilac models	908026-001
Misty green models	908027-001
Display enclosure for use in HP 255 G5 Notebook PC models:	
Black models	859511-001
Silver models	905913-001
Hinges (left and right)	855006-001

Description	Spare part number
Webcam/microphone module for use in HP Notebook PC models:	
HD	709372-030
VGA	766523-019
Webcam/microphone for use in HP Notebook PC and HP 255 G5 Notebook PC models:	
HD	861336-001
VGA	861337-001

Before removing the display assembly, follow these steps:

1. Shut down the computer. If you are unsure whether the computer is off or in Hibernation, turn the computer on, and then shut it down through the operating system.
2. Disconnect all external devices connected to the computer.
3. Disconnect the power from the computer by first unplugging the power cord from the AC outlet and then unplugging the AC adapter from the computer.
4. Remove the battery (see [Battery on page 38](#)).
5. Remove the optical drive (see [Optical drive on page 39](#)), if installed.
6. Remove the bottom cover (see [Bottom cover on page 42](#)).
7. Remove the fan (see [Fan on page 60](#)).

To remove the display assembly:

1. Disconnect the wireless antennas from the WLAN module **(1)**.
2. Disconnect the display panel cable from the system board **(2)**.

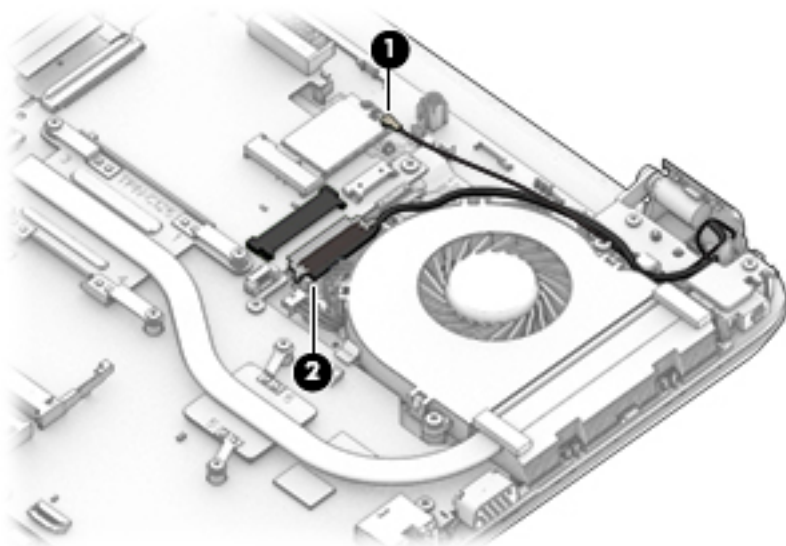

3. Position the computer with the display open and hanging down off the side of a table.
4. Remove the four Phillips PM2.5×6.5 screws **(1)** (two from each hinge) and one broadhead Phillips PM2.0×2.0 screw **(2)** (on the left hinge) that secures the display assembly to the computer.

5. Separate the display from the computer (3).

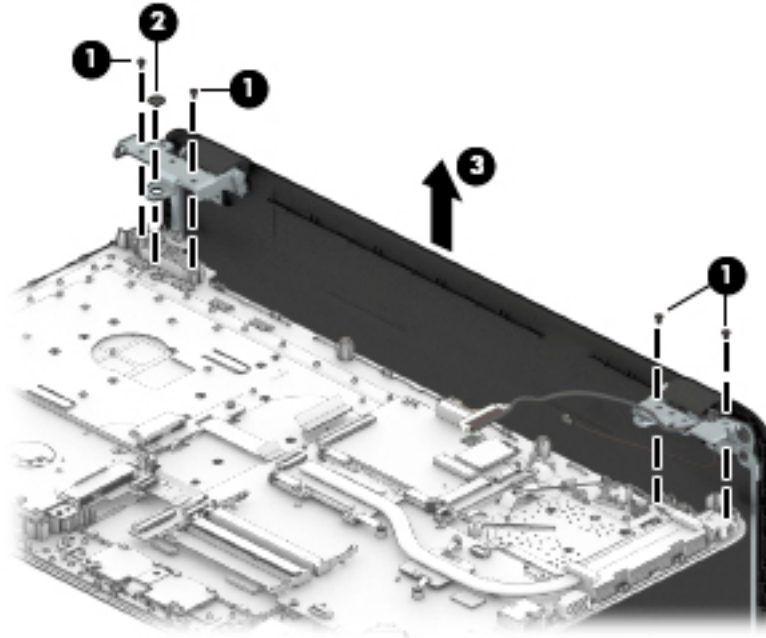

If it is necessary to replace any of the display assembly subcomponents:

1. To remove the display bezel:
 - a. Flex the inside of the top edge (1), the left and right edges (2), and the bottom edge (3) of the display bezel until the bezel disengages from the display enclosure.
 - b. Remove the display bezel (4).

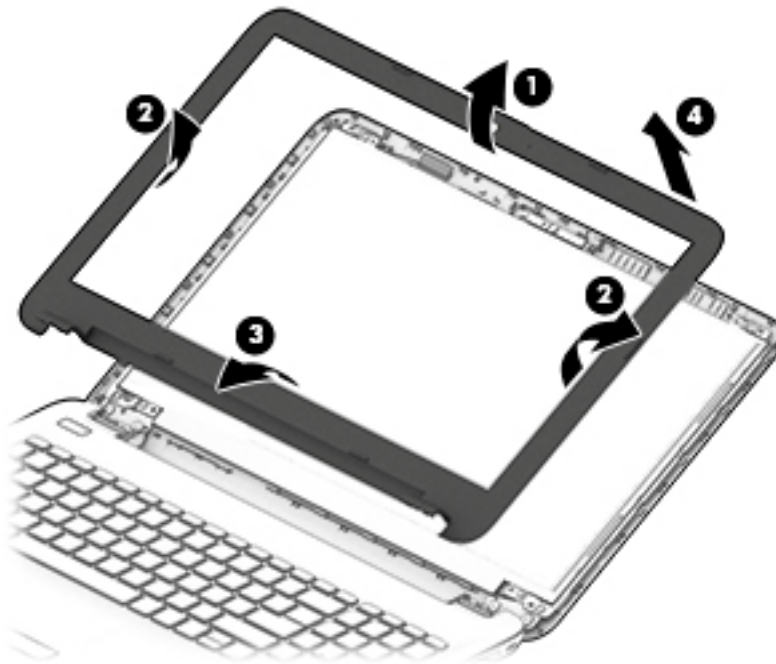

2. To remove the webcam/microphone module:

- a. Position the display assembly with the top edge toward you.
- b. Disconnect the cable **(1)** from the module.
- c. Remove the webcam/microphone module **(2)**. (The module is attached to the display enclosure with double-sided tape.)

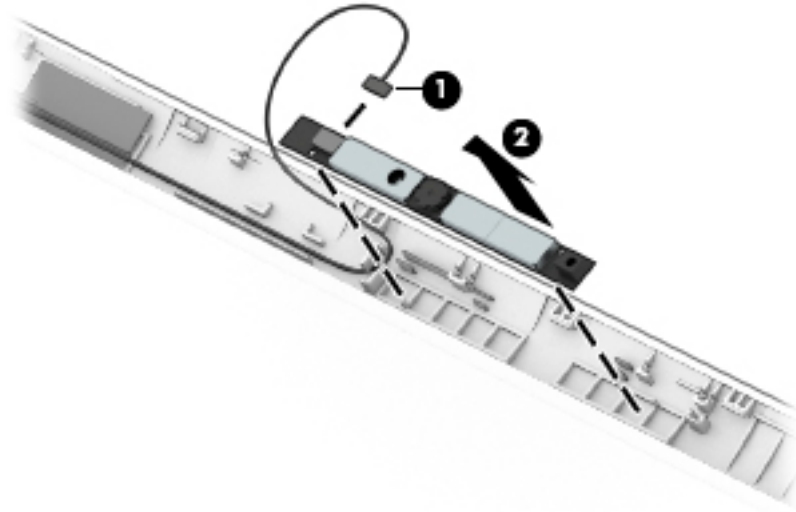

3. To remove the display panel:
 - a. Remove the four Phillips PM2.0×3.0 screws that secure the display panel to the enclosure.

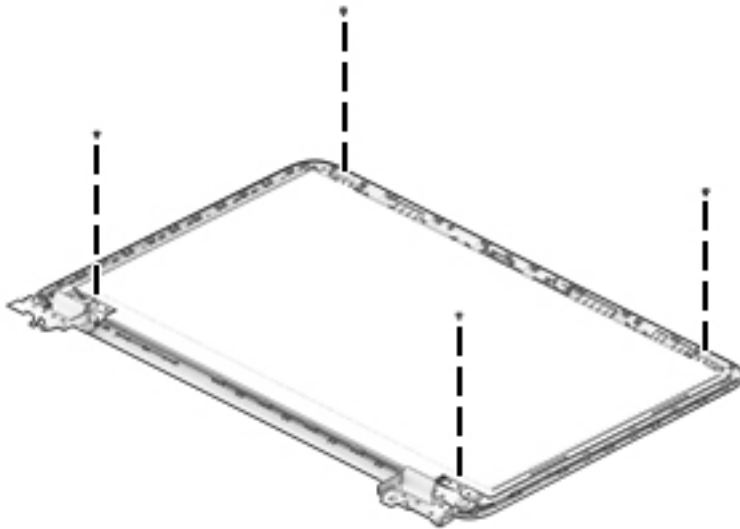

- b. Rotate the display panel onto the keyboard **(1)** to gain access to the display cable connection on the back of the panel.
- c. On the back of the display panel, release the adhesive strip **(2)** that secures the display panel cable to the display panel, and then disconnect the cable **(3)**.

- d. Remove the display panel from the computer.

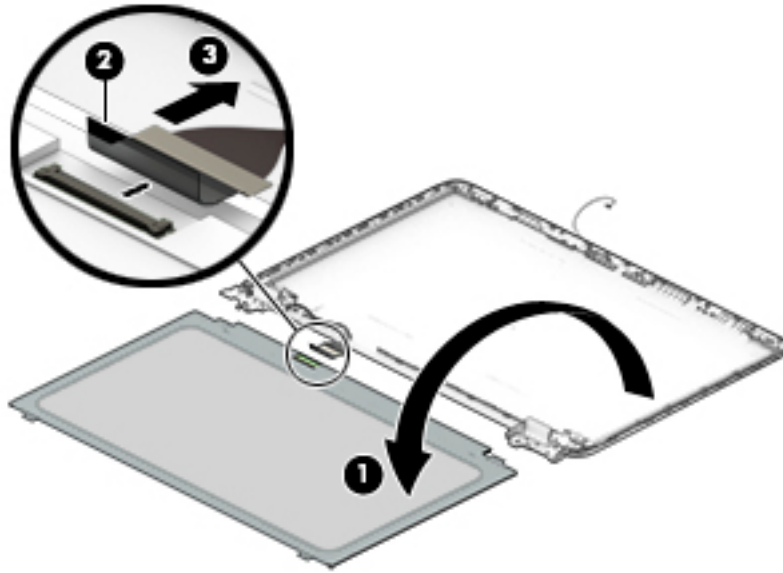

4. To remove the display hinges:
- For each hinge, remove the two Phillips PM2.5×3.5 screws (1) and the two broadhead Phillips PM2.5×2.5 screws (2) that secure each hinge to the display enclosure.
 - Remove the display hinges (3).

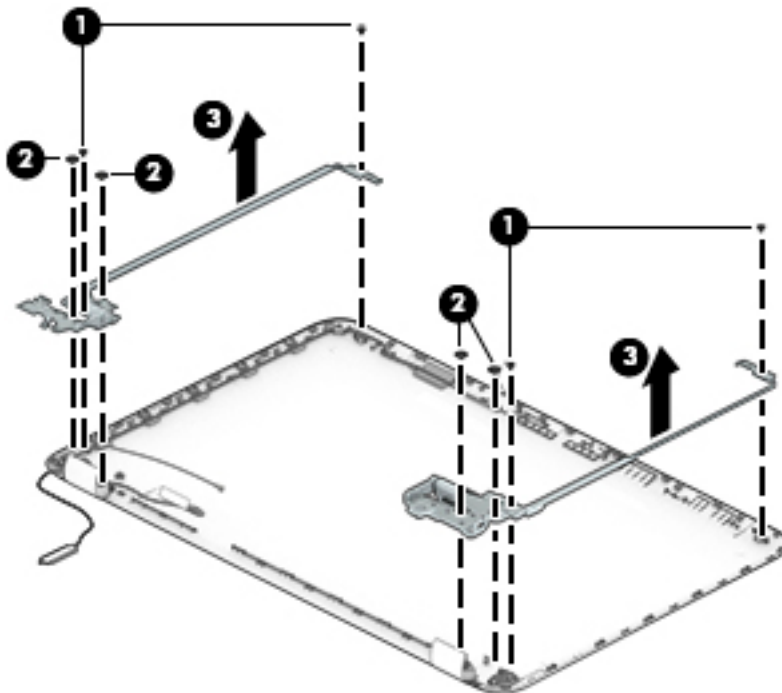

5. To remove the wireless antenna cables and transceivers, release the wireless antenna cables from the clips built into the display enclosure **(1)**, and then remove the cables **(2)**.

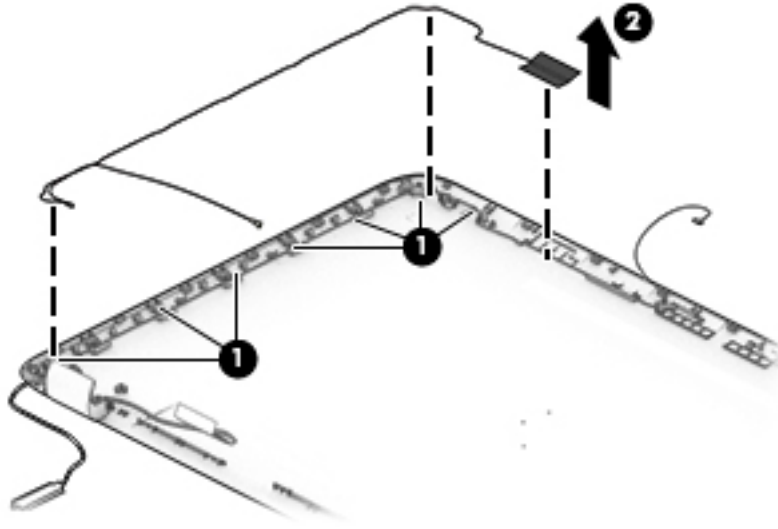

6. To remove the display/webcam cable, remove the cable from the clips built into the display enclosure **(1)**, and then remove the cable from the display enclosure **(2)**.

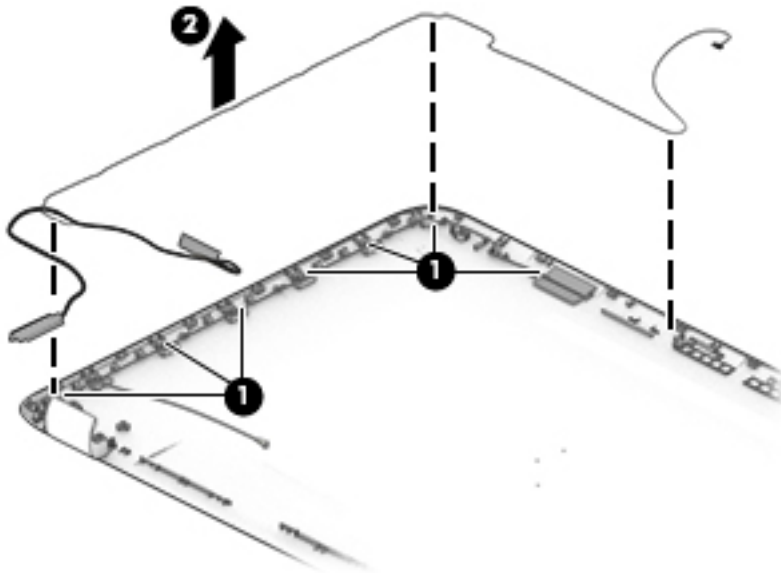

7. If replacing the display enclosure, be sure that the subcomponents (including the webcam/microphone module, the antenna receivers, and all associated cables and hardware) are transferred to the new enclosure.

8. Use the following image to determine proper cable routing for the display cable and the wireless antennas.

(1): Display hinge

(2): Display cable routing path

(3): Antenna cable routing path

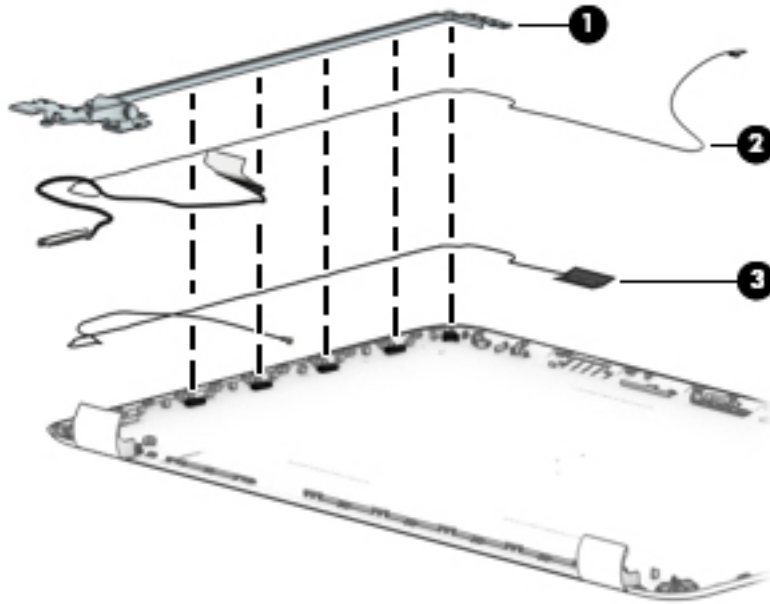

Reverse this procedure to reassemble and install the display assembly.

Power connector cable

Description	Spare part number
Power connector cable	813945-001

Before removing the power connector cable, follow these steps:

1. Shut down the computer. If you are unsure whether the computer is off or in Hibernation, turn the computer on, and then shut it down through the operating system.
2. Disconnect all external devices connected to the computer.
3. Disconnect the power from the computer by first unplugging the power cord from the AC outlet and then unplugging the AC adapter from the computer.
4. Remove the battery (see [Battery on page 38](#)).
5. Remove the optical drive (see [Optical drive on page 39](#)), if installed.
6. Remove the bottom cover (see [Bottom cover on page 42](#)).
7. Remove the display (see [Display assembly on page 66](#)).

To remove the power connector cable:

1. Disconnect the power connector cable from the system board **(1)**.
2. Remove the power connector cable **(2)**.

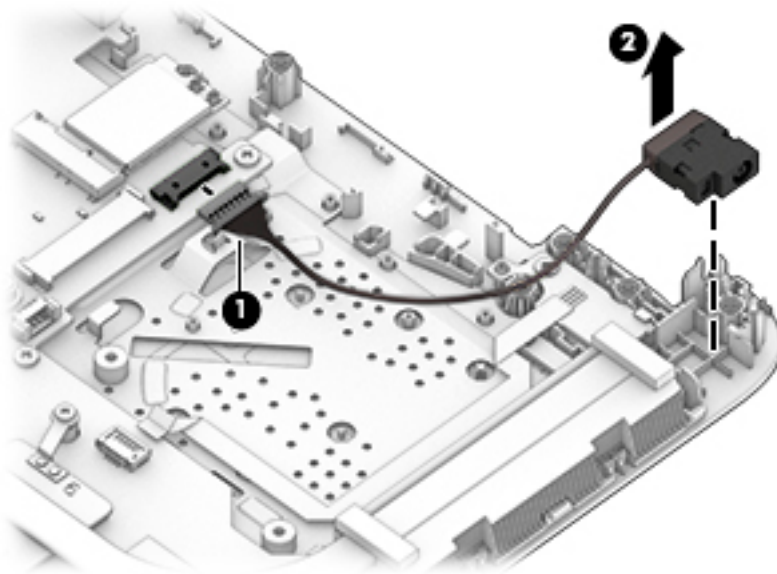

Reverse this procedure to install the power connector cable.

Power button board

Description	Spare part number
Power button board (includes cable)	855012-001

Before removing the power button board, follow these steps:

1. Shut down the computer. If you are unsure whether the computer is off or in Hibernation, turn the computer on, and then shut it down through the operating system.
2. Disconnect all external devices connected to the computer.
3. Disconnect the power from the computer by first unplugging the power cord from the AC outlet and then unplugging the AC adapter from the computer.
4. Remove the battery (see [Battery on page 38](#)).
5. Remove the optical drive (see [Optical drive on page 39](#)), if installed.
6. Remove the bottom cover (see [Bottom cover on page 42](#)).
7. Remove the display (see [Display assembly on page 66](#)).

To remove the power button board:

1. Disconnect the power button board cable from the system board **(1)**.
2. Remove the Phillips PM2.0×3.0 screw **(2)** that secures the power button board to the computer.
3. If necessary, lift the cable to disengage the adhesive that secures it to computer.
4. Note the tab **(3)** that secures the board. Rotate the bottom of the board upward to remove the board and cable from the computer **(4)**.

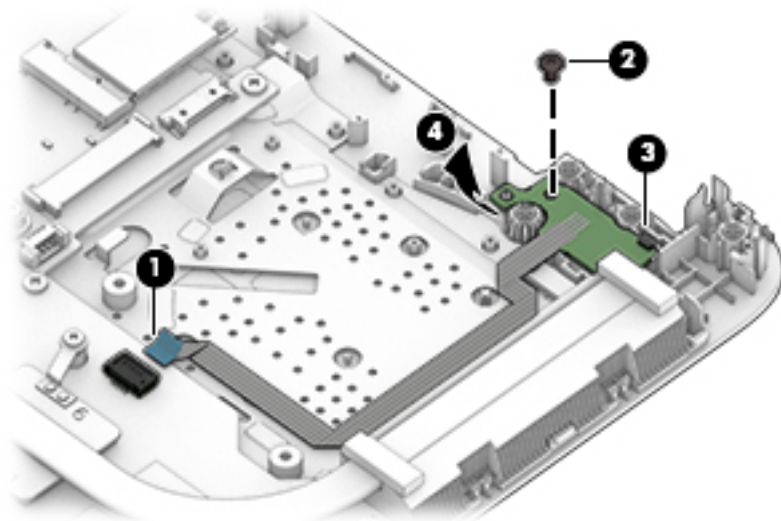

Reverse this procedure to install the power button board and cable.

Top cover/keyboard

The top cover/keyboard spare part remains after all other spare parts have been removed.

The top cover/keyboard spare part kit includes the keyboard, keyboard cable and the keyboard backlight cable.

In this section, the first table provides the main spare part number for the keyboard. The second table provides the country codes.



NOTE: All top cover/keyboard spare part kits include TouchPad.

Description	Spare part number
Top cover for use in HP Notebook PC models:	
Turbo silver models	855022-xx1
White silver models	855023-xx1
Red models	855024-xx1
Teal models	855025-xx1
Noble blue models	855026-xx1
Iris purple models	901746-xx1
Powder blue models	908028-xx1
Soft lilac models	908029-xx1
Misty green models	908030-xx1
Top cover for use in HP Notebook PC and HP 255 G5 Notebook PC models:	
Black models	855027-xx1
Black models, for use in Canada	902973-DB1
Silver models	905891-xx1

For use in country or region	Spare part number	For use in country or region	Spare part number	For use in country or region	Spare part number
Belgium	-A41	India	-002	Slovenia	-BA1
Bulgaria	-261	Israel	-BB1	South Korea	-AD1
Canada	-DB1	Italy	-061	Spain	-071
Czech Republic and Slovakia	-FL1	Japan	-291	Switzerland	-BG1
Denmark, Finland, and Norway	-DH1	The Netherlands	-B31	Taiwan	-AB1
France	-051	Portugal	-131	Thailand	-281
Germany	-041	Romania	-271	Turkey	-141

For use in country or region	Spare part number	For use in country or region	Spare part number	For use in country or region	Spare part number
Greece	-151	Russia	-251	United Kingdom	-031
Hungary	-211	Saudi Arabia	-171	United States	-001

7 Using Setup Utility (BIOS) in Windows 7

Setup Utility, or Basic Input/Output System (BIOS), controls communication between all the input and output devices on the system (such as disk drives, display, keyboard, mouse, and printer). Setup Utility (BIOS) includes settings for the types of devices installed, the startup sequence of the computer, and the amount of system and extended memory.

Starting Setup Utility (BIOS)

- ▲ To start Setup Utility (BIOS), turn on or restart the computer, quickly press **esc**, and then press **f10**.

 **NOTE:** Use extreme care when making changes in Setup Utility (BIOS). Errors can prevent the computer from operating properly.

Updating the BIOS

Updated versions of Setup Utility (BIOS) may be available on the HP website.

Most BIOS updates on the HP website are packaged in compressed files called *SoftPaqs*.

Some download packages contain a file named *Readme.txt*, which contains information regarding installing and troubleshooting the file.

Determining the BIOS version

To decide whether you need to update Setup Utility (BIOS), first determine the BIOS version on your computer.

BIOS version information (also known as *ROM date* and *System BIOS*) can be accessed by pressing **fn+esc** (if you are already in Windows) or by using Setup Utility (BIOS).

To use Setup Utility (BIOS):

1. Start Setup Utility (BIOS).
2. Use the arrow keys to select **Main**, and then make note of your current BIOS version.
3. To exit Setup Utility (BIOS) without saving your changes, use the tab key and the arrow keys to select **Exit > Exit Discarding Changes**, and then press **enter**.

To check for later BIOS versions, see [Downloading a BIOS update on page 77](#).

Downloading a BIOS update

 **CAUTION:** To reduce the risk of damage to the computer or an unsuccessful installation, download and install a BIOS update only when the computer is connected to reliable external power using the AC adapter. Do not download or install a BIOS update while the computer is running on battery power, docked in an optional docking device, or connected to an optional power source. During the download and installation, follow these instructions:

Do not disconnect power from the computer by unplugging the power cord from the AC outlet.

Do not shut down the computer or initiate Sleep or Hibernation.

Do not insert, remove, connect, or disconnect any device, cable, or cord.

1. Select **Start**, type `hp support assistant`, and then select the **HP Support Assistant** program.
2. Follow the on-screen instructions to identify your computer and access the BIOS update you want to download.
3. At the download area, follow these steps:
 - a. Identify the BIOS update that is later than the BIOS version currently installed on your computer. If the update is more recent than your BIOS version, make a note of the date, name, or other identifier. You may need this information to locate the update later, after it has been downloaded to your hard drive.
 - b. Follow the on-screen instructions to download your selection to the hard drive.

Make a note of the path to the location on your hard drive where the BIOS update is downloaded. You will need to access this path when you are ready to install the update.



NOTE: If you connect your computer to a network, consult the network administrator before installing any software updates, especially system BIOS updates.

BIOS installation procedures vary. Follow any instructions that are displayed on the screen after the download is complete. If no instructions are displayed, follow these steps:

1. Open Windows Explorer by selecting **Start > Computer**.
2. Double-click your hard drive designation. The hard drive designation is typically Local Disk (C:).
3. Using the hard drive path you recorded earlier, open the folder that contains the update.
4. Double-click the file that has an .exe extension (for example, *filename.exe*).

The BIOS installation begins.
5. Complete the installation by following the on-screen instructions.



NOTE: After a message on the screen reports a successful installation, you can delete the downloaded file from your hard drive.

8 Using Setup Utility (BIOS) in Windows 10

Setup Utility, or Basic Input/Output System (BIOS), controls communication between all the input and output devices on the system (such as disk drives, display, keyboard, mouse, and printer). Setup Utility (BIOS) includes settings for the types of devices installed, the startup sequence of the computer, and the amount of system and extended memory.

 **NOTE:** To start Setup Utility on convertible computers, your computer must be in notebook mode and you must use the keyboard attached to your notebook.

Starting Setup Utility (BIOS)

 **CAUTION:** Use extreme care when making changes in Setup Utility (BIOS). Errors can prevent the computer from operating properly.

- ▲ Turn on or restart the computer, quickly press **esc**, and then press **f10**.

Updating Setup Utility (BIOS)

Updated versions of Setup Utility (BIOS) may be available on the HP website.

Most BIOS updates on the HP website are packaged in compressed files called *SoftPaqs*.

Some download packages contain a file named *Readme.txt*, which contains information regarding installing and troubleshooting the file.

Determining the BIOS version

To decide whether you need to update Setup Utility (BIOS), first determine the BIOS version on your computer.

To reveal the BIOS version information (also known as *ROM date* and *System BIOS*), use one of these options.

- HP Support Assistant
 1. Type `support` in the taskbar search box, and then select the **HP Support Assistant** app.
– or –
Click the question mark icon in the taskbar.
 2. Select **My PC**, and then select **Specifications**.
- Setup Utility (BIOS)
 1. Start Setup Utility (BIOS) (see [Starting Setup Utility \(BIOS\) on page 79](#)).
 2. Select **Main**, select **System Information**, and then make note of the BIOS version.
 3. Select **Exit**, select **No**, and then follow the on-screen instructions.

To check for later BIOS versions, see [Downloading a BIOS update on page 80](#).

Downloading a BIOS update

 **CAUTION:** To reduce the risk of damage to the computer or an unsuccessful installation, download and install a BIOS update only when the computer is connected to reliable external power using the AC adapter. Do not download or install a BIOS update while the computer is running on battery power, docked in an optional docking device, or connected to an optional power source. During the download and installation, follow these instructions:

- Do not disconnect power from the computer by unplugging the power cord from the AC outlet.
- Do not shut down the computer or initiate Sleep.
- Do not insert, remove, connect, or disconnect any device, cable, or cord.

 **NOTE:** If your computer is connected to a network, consult the network administrator before installing any software updates, especially system BIOS updates.

1. Type `support` in the taskbar search box, and then select the **HP Support Assistant** app.
– or –
Click the question mark icon in the taskbar.
2. Click **Updates**, and then click **Check for updates and messages**.
3. Follow the on-screen instructions.
4. At the download area, follow these steps:
 - a. Identify the most recent BIOS update and compare it to the BIOS version currently installed on your computer. If the update is more recent than your BIOS version, make a note of the date, name, or other identifier. You may need this information to locate the update later, after it has been downloaded to your hard drive.
 - b. Follow the on-screen instructions to download your selection to the hard drive.

Make a note of the path to the location on your hard drive where the BIOS update is downloaded. You will need to access this path when you are ready to install the update.

BIOS installation procedures vary. Follow any instructions that appear on the screen after the download is complete. If no instructions appear, follow these steps:

1. Type `file` in the taskbar search box, and then select **File Explorer**.
2. Click your hard drive designation. The hard drive designation is typically Local Disk (C:).
3. Using the hard drive path you recorded earlier, open the folder that contains the update.
4. Double-click the file that has an `.exe` extension (for example, `filename.exe`).

The BIOS installation begins.
5. Complete the installation by following the on-screen instructions.

 **NOTE:** After a message on the screen reports a successful installation, you can delete the downloaded file from your hard drive.

9 Backing up, restoring, and recovering in Windows 7

Your computer includes tools provided by the operating system and HP to help you safeguard your information and retrieve it if ever needed.

Creating backups

1. Use HP Recovery Manager to create recovery media immediately after you set up the working computer.
2. As you add hardware and software programs, create system restore points.
3. As you add photos, video, music, and other personal files, create a backup of your system and personal information.

Creating recovery media to recover the original system

After you successfully set up the computer, you should create recovery discs or a recovery flash drive using HP Recovery Manager. You will need these recovery discs or recovery flash drive to perform a system recovery should the hard drive become corrupted. A system recovery reinstalls the original operating system, and then configures the settings for the default programs.

What you need to know

- Only one set of recovery media can be created. Handle these recovery tools carefully, and keep them in a safe place.
- HP Recovery Manager examines the computer and determines the required storage capacity for the flash drive or the number of blank DVD discs that will be required.

Use DVD-R, DVD+R, DVD-R DL, DVD+R DL discs or a flash drive. Do not use rewriteable discs such as CD ±RW, DVD±RW, double-layer DVD±RW, and BD-RE (rewritable Blu-ray) discs; they are not compatible with HP Recovery Manager software.
- If your computer does not include an integrated optical drive, you can use an optional external optical drive (purchased separately) to create recovery discs, or you can obtain recovery discs for your computer from the HP website. If you use an external optical drive, it must be connected directly to a USB port on the computer, not to a USB port on an external device, such as a USB hub.
- Be sure that the computer is connected to AC power before you begin creating the recovery media.
- The creation process can take up to an hour or more. Do not interrupt the creation process.
- Store the recovery media in a safe location, separate from the computer.
- If necessary, you can exit the program before you have finished creating the recovery media. The next time you open HP Recovery Manager, you will be prompted to continue the process.

Creating the recovery media

1. Select **Start** and type `recovery` in the search field. Select **HP Recovery Manager** from the list. Allow the action to continue, if prompted.
2. Click **Recovery Media Creation**.
3. Follow the on-screen instructions to continue.

To recover, see [Recovering the original system using HP Recovery Manager on page 84](#).

Creating system restore points

A system restore point is a snapshot of certain hard drive contents saved by Windows System Restore at a specific time. A restore point contains information such as registry settings that Windows uses. Restoring to a previous restore point allows you to reverse changes that have been made to the system since the restore point was created.

Restoring to an earlier system restore point does not affect data files saved or emails created since the last restore point, but it does affect software you may have installed.

For example, if you download a photo from a digital camera and then restore the computer to the state it was on the previous day, the photo remains on the computer.

However, if you install photo viewing software and then restore your computer to the state it was on the previous day, the software will be uninstalled, and you won't be able to use it.

What you need to know

- If you restore to a restore point and then change your mind, you can undo the restoration.
- You should create system restore points:
 - Before you add or change software or hardware
 - Periodically, whenever the computer is running normally
- System Restore also saves shadow copies of files that have been changed since the last restore point was created. For more information about using shadow copies to restore, see Help and Support.

Creating a system restore point

1. Select **Start > Control Panel > System and Security > System**.
2. In the left pane, click **System Protection**.
3. Click the **System Protection** tab.
4. Click **Create**, and follow the on-screen instructions.

To restore, see [Restoring to a previous system restore point on page 84](#).

Backing up system and personal information

Your computer stores information that is important to you, such as files, emails, and photos, and you will want to keep that information even if you download a virus or the system stops working properly. How completely you are able to recover your files depends on how recent your backup is. As you add new software and data files, you should create backups on a regular basis.

Tips for a successful backup

- Number backup discs before inserting them into the optical drive.
- Store personal files in the Documents, Music, Pictures, and Videos libraries, and back up these folders periodically.
- Save customized settings in a window, toolbar, or menu bar by taking a screen shot of your settings. The screen shot can be a time-saver if you have to re-enter your preferences.

To create a screen shot:

1. Display the screen you want to save.
2. Copy the screen image:
To copy only the active window, press **alt+prt sc**.
To copy the entire screen, press **prt sc**.
3. Open a word-processing document or graphics editing program, and then select **Edit > Paste**. The screen image is added to the document.
4. Save and print the document.

What you need to know

- You can back up your information to an optional external hard drive, a flash drive, a network drive, or discs.
- Connect the computer to AC power during backups.
- Allow enough time for the backup. Depending on files sizes, it may take more than an hour.
- Verify the amount of free space on your backup storage device before you back up.
- You should back up:
 - Before adding or changing software or hardware.
 - Before the computer is repaired or restored.
 - On a regular schedule to be sure you have recent copies of personal information.
 - After you add many files—for example, if you saved videos from a birthday party.
 - Before using antivirus software to remove a malicious program.
 - After adding information that is hard to replace, such as pictures, videos, music, project files, or data records.

Creating a backup using Windows Backup and Restore

Windows allows you to back up files using Windows Backup and Restore. You can select the level you want to back up, from individual folders to drives. The backups are compressed to save space. To back up:

1. Select **Start > Control Panel > System and Security > Backup and Restore**.
2. Follow the on-screen instructions to schedule and create a backup.



NOTE: Windows includes the User Account Control feature to improve the security of the computer. You may be prompted for your permission or password for tasks such as installing software, running utilities, or changing Windows settings. See Help and Support for more information.

To restore, see [Restoring specific files using Windows Backup and Restore on page 84](#).

Restore and recovery

Restoring to a previous system restore point

Sometimes installing a software program causes your computer or Windows to behave unpredictably. Usually uninstalling the software fixes the problems. If uninstalling does not fix the problems, you can restore the computer to a previous system restore point (created at an earlier date and time).

To restore to a previous system restore point, when the computer was running correctly:

1. Select **Start > Control Panel > System and Security > System**.
2. In the left pane, click **System Protection**.
3. Click the **System Protection** tab.
4. Click **System Restore**, and follow the on-screen instructions.

Restoring specific files

If files are accidentally deleted from the hard disk and they can no longer be restored from the Recycle Bin, or if files become corrupt, restoring specific files is useful. Restoring specific files is also useful if you ever choose to recover the original system using HP Recovery Manager. You can only restore specific files that you have backed up before.

Restoring specific files using Windows Backup and Restore

Windows allows you to restore files that were backed up using Windows Backup and Restore:

1. Select **Start > Control Panel > System and Security > Backup and Restore**.
2. Follow the on-screen instructions to restore your backup.



NOTE: Windows includes the User Account Control feature to improve the security of the computer. You may be prompted for your permission or password for tasks such as installing software, running utilities, or changing Windows settings. See Help and Support for more information.

Recovering the original system using HP Recovery Manager

HP Recovery Manager software allows you to repair or recover the computer to its original factory state.

What you need to know

- HP Recovery Manager recovers only software that was installed at the factory. For software not provided with this computer, you must either download the software from the manufacturer's website or reinstall the software from the disc provided by the manufacturer.
- A system recovery should be used as a final attempt to correct computer issues. If you have not already tried restore points (see [Restoring to a previous system restore point on page 84](#)) and partial restores (see [Restoring specific files on page 84](#)), try them before using HP Recovery Manager to recover your system.
- A system recovery must be performed if the computer hard drive fails or if all attempts to correct any functional computer issues fail.

- If the recovery media do not work, you can obtain recovery discs for your system from the HP website.
- The Minimized Image Recovery option is recommended for advanced users only. All hardware-related drivers and software are re-installed, but other software applications are not. Do not interrupt the process until it is complete, otherwise the recovery will fail.

Recovering using HP Recovery partition (select products only)

The HP Recovery partition (select products only), allows you to restore your system without the need for recovery discs or a recovery flash drive. This type of recovery can only be used if the hard drive is still working.

To check for the presence of a recovery partition, select **Start**, right-click **Computer** then select **Manage > Disk Management**. If the recovery partition is present, a Recovery drive is listed in the window.



NOTE: Recovery discs have been included if your computer did not ship with a recovery partition.

1. Access HP Recovery Manager in either of the following ways:
 - Select **Start** and type `recovery` in the search field. Select **HP Recovery Manager** from the list.
 - or –
 - Turn on or restart the computer, and then press `esc` while the “Press the ESC key for Startup Menu” message is displayed at the bottom of the screen. Then press `f11` while the “F11 (System Recovery)” message is displayed on the screen.
2. Click **System Recovery** in the **HP Recovery Manager** window.
3. Follow the on-screen instructions.

Recovering using the recovery media

1. If possible, back up all personal files.
2. Insert the first recovery disc into the optical drive on your computer or an optional external optical drive, and then restart the computer.

– or –

Insert the recovery flash drive into a USB port on your computer, and then restart the computer.



NOTE: If the computer does not automatically restart in HP Recovery Manager, change the computer boot order. See [Changing the computer boot order on page 85](#).

3. Press `f9` at system bootup.
4. Select the optical drive or the flash drive.
5. Follow the on-screen instructions.

Changing the computer boot order

To change the boot order for recovery discs:

1. Restart the computer.
2. Press `esc` while the computer is restarting, and then press `f9` for boot options.
3. Select **Internal CD/DVD ROM Drive** from the boot options window.

To change the boot order for a recovery flash drive:

1. Insert the flash drive into a USB port.
2. Restart the computer.
3. Press `esc` while the computer is restarting, and then press `f9` for boot options.
4. Select the flash drive from the boot options window.

10 Backing up, restoring, and recovering in Windows 10

This chapter provides information about the following processes. The information in the chapter is standard procedure for most products.

- Creating recovery media and backups
- Restoring and recovering your system

For additional information, refer to the HP support assistant app.

- ▲ Type `support` in the taskbar search box, and then select the **HP Support Assistant** app.

– or –

Click the question mark icon in the taskbar.

 **IMPORTANT:** If you will be performing recovery procedures on a tablet, the tablet battery must be at least 70% charged before you start the recovery process.

IMPORTANT: For a tablet with a detachable keyboard, connect the keyboard to the keyboard dock before beginning any recovery process.

Creating recovery media and backups

The following methods of creating recovery media and backups are available on select products only. Choose the available method according to your computer model.

- Use HP Recovery Manager to create HP Recovery media after you successfully set up the computer. This step creates a backup of the HP Recovery partition on the computer. The backup can be used to reinstall the original operating system in cases where the hard drive is corrupted or has been replaced. For information on creating recovery media, see [Creating HP Recovery media \(select products only\) on page 87](#). For information on the recovery options that are available using the recovery media, see [Using Windows tools on page 88](#).

- Use Windows tools to create system restore points and create backups of personal information.

For more information, see [Recovering using HP Recovery Manager on page 89](#).

 **NOTE:** If storage is 32 GB or less, Microsoft System Restore is disabled by default.

Creating HP Recovery media (select products only)

If possible, check for the presence of the Recovery partition and the Windows partition. From the **Start** menu, select **File Explorer**, and then select **This PC**.

- If your computer does not list the Windows partition and the Recovery partition, you can obtain recovery media for your system from support. See the *Worldwide Telephone Numbers* booklet included with the computer. You can also find contact information on the HP website. Go to <http://www.hp.com/support>, select your country or region, and follow the on-screen instructions.

You can use Windows tools to create system restore points and create backups of personal information, see [Using Windows tools on page 88](#).

- If your computer does list the Recovery partition and the Windows partition, you can use HP Recovery Manager to create recovery media after you successfully set up the computer. HP Recovery media can be used to perform system recovery if the hard drive becomes corrupted. System recovery reinstalls the original operating system and software programs that were installed at the factory and then configures the settings for the programs. HP Recovery media can also be used to customize the system or restore the factory image if you replace the hard drive.
 - Only one set of recovery media can be created. Handle these recovery tools carefully, and keep them in a safe place.
 - HP Recovery Manager examines the computer and determines the required storage capacity for the media that will be required.
 - To create recovery discs, your computer must have an optical drive with DVD writer capability, and you must use only high-quality blank DVD-R, DVD+R, DVD-R DL, or DVD+R DL discs. Do not use rewritable discs such as CD±RW, DVD±RW, double-layer DVD±RW, or BD-RE (rewritable Blu-ray) discs; they are not compatible with HP Recovery Manager software. Or, instead, you can use a high-quality blank USB flash drive.
 - If your computer does not include an integrated optical drive with DVD writer capability, but you would like to create DVD recovery media, you can use an external optical drive (purchased separately) to create recovery discs. If you use an external optical drive, it must be connected directly to a USB port on the computer; the drive cannot be connected to a USB port on an external device, such as a USB hub. If you cannot create DVD media yourself, you can obtain recovery discs for your computer from HP. See the *Worldwide Telephone Numbers* booklet included with the computer. You can also find contact information on the HP website. Go to <http://www.hp.com/support>, select your country or region, and follow the on-screen instructions.
 - Be sure that the computer is connected to AC power before you begin creating the recovery media.
 - The creation process can take an hour or more. Do not interrupt the creation process.
 - If necessary, you can exit the program before you have finished creating all of the recovery DVDs. HP Recovery Manager will finish burning the current DVD. The next time you start HP Recovery Manager, you will be prompted to continue.

To create HP Recovery media:



IMPORTANT: For a tablet with a detachable keyboard, connect the keyboard to the keyboard dock before beginning these steps.

1. Type `recovery` in the taskbar search box, and then select **HP Recovery Manager**.
2. Select **Create recovery media**, and then follow the on-screen instructions.

If you ever need to recover the system, see [Recovering using HP Recovery Manager on page 89](#).

Using Windows tools

You can create recovery media, system restore points, and backups of personal information using Windows tools.



NOTE: If storage is 32 GB or less, Microsoft System Restore is disabled by default.

For more information and steps, see the Get started app.

- ▲ Select the **Start** button, and then select the **Get started** app.

Restore and recovery

There are several options for recovering your system. Choose the method that best matches your situation and level of expertise:

 **IMPORTANT:** Not all methods are available on all products.

- Windows offers several options for restoring from backup, refreshing the computer, and resetting the computer to its original state. For more information see the Get started app.
 - ▲ Select the **Start** button, and then select the **Get started** app.
- If you need to correct a problem with a preinstalled application or driver, use the Reinstall drivers and/or applications option (select products only) of HP Recovery Manager to reinstall the individual application or driver.
 - ▲ Type `recovery` in the taskbar search box, select **HP Recovery Manager**, select **Reinstall drivers and/or applications**, and then follow the on-screen instructions.
- If you want to recover the Windows partition to original factory content, you can choose the System Recovery option from the HP Recovery partition (select products only) or use the HP Recovery media. For more information, see [Recovering using HP Recovery Manager on page 89](#). If you have not already created recovery media, see [Creating HP Recovery media \(select products only\) on page 87](#).
- On select products, if you want to recover the computer's original factory partition and content, or if you have replaced the hard drive, you can use the Factory Reset option of HP Recovery media. For more information, see [Recovering using HP Recovery Manager on page 89](#).
- On select products, if you want to remove the recovery partition to reclaim hard drive space, HP Recovery Manager offers the Remove Recovery Partition option.

For more information, see [Removing the HP Recovery partition \(select products only\) on page 91](#).

Recovering using HP Recovery Manager

HP Recovery Manager software allows you to recover the computer to its original factory state by using the HP Recovery media that you either created or that you obtained from HP, or by using the HP Recovery partition (select products only). If you have not already created recovery media, see [Creating HP Recovery media \(select products only\) on page 87](#).

What you need to know before you get started

- HP Recovery Manager recovers only software that was installed at the factory. For software not provided with this computer, you must either download the software from the manufacturer's website or reinstall the software from the media provided by the manufacturer.

 **IMPORTANT:** Recovery through HP Recovery Manager should be used as a final attempt to correct computer issues.

- HP Recovery media must be used if the computer hard drive fails. If you have not already created recovery media, see [Creating HP Recovery media \(select products only\) on page 87](#).
- To use the Factory Reset option (select products only), you must use HP Recovery media. If you have not already created recovery media, see [Creating HP Recovery media \(select products only\) on page 87](#).
- If your computer does not allow the creation of HP Recovery media or if the HP Recovery media does not work, you can obtain recovery media for your system from support. See the *Worldwide Telephone Numbers* booklet included with the computer. You can also find contact information from the HP

website. Go to <http://www.hp.com/support>, select your country or region, and follow the on-screen instructions.

 **IMPORTANT:** HP Recovery Manager does not automatically provide backups of your personal data. Before beginning recovery, back up any personal data you want to retain.

Using HP Recovery media, you can choose from one of the following recovery options:

 **NOTE:** Only the options available for your computer display when you start the recovery process.

- System Recovery—Reinstalls the original operating system, and then configures the settings for the programs that were installed at the factory.
- Factory Reset—Restores the computer to its original factory state by deleting all information from the hard drive and re-creating the partitions. Then it reinstalls the operating system and the software that was installed at the factory.

The HP Recovery partition (select products only) allows System Recovery only.

Using the HP Recovery partition (select products only)

The HP Recovery partition allows you to perform a system recovery without the need for recovery discs or a recovery USB flash drive. This type of recovery can be used only if the hard drive is still working.

To start HP Recovery Manager from the HP Recovery partition:

 **IMPORTANT:** For a tablet with a detachable keyboard, connect the keyboard to the keyboard dock before beginning these steps (select products only).

1. Type `recovery` in the taskbar search box, select **Recovery Manager**, and then select **HP Recovery Environment**.

- or -

For computers or tablets with keyboards attached, press **f11** while the computer boots, or press and hold **f11** as you press the power button.

For tablets without keyboards:

Turn on or restart the tablet, and then quickly hold down the volume down button; then select **f11**.

- or -

Turn on or restart the tablet, and then quickly hold down the Windows button; then select **f11**.

2. Select **Troubleshoot** from the boot options menu.
3. Select **Recovery Manager**, and then follow the on-screen instructions.

Using HP Recovery media to recover

You can use HP Recovery media to recover the original system. This method can be used if your system does not have an HP Recovery partition or if the hard drive is not working properly.

1. If possible, back up all personal files.
2. Insert the HP Recovery media, and then restart the computer.

 **NOTE:** If the computer does not automatically restart in HP Recovery Manager, change the computer boot order. See [Changing the computer boot order on page 91](#).

3. Follow the on-screen instructions.

Changing the computer boot order

If your computer does not restart in HP Recovery Manager, you can change the computer boot order, which is the order of devices listed in BIOS where the computer looks for startup information. You can change the selection to an optical drive or a USB flash drive.

To change the boot order:

 **IMPORTANT:** For a tablet with a detachable keyboard, connect the keyboard to the keyboard dock before beginning these steps.

1. Insert the HP Recovery media.
2. Access BIOS:

For computers or tablets with keyboards attached:

- ▲ Turn on or restart the computer or tablet, quickly press **esc**, and then press **f9** for boot options.

For tablets without keyboards:

- ▲ Turn on or restart the tablet, and then quickly hold down the volume down button; then select **f9**.
- or -

Turn on or restart the tablet, and then quickly hold down the Windows button; then select **f9**.

3. Select the optical drive or USB flash drive from which you want to boot.
4. Follow the on-screen instructions.

Removing the HP Recovery partition (select products only)

HP Recovery Manager software allows you to remove the HP Recovery partition to free up hard drive space.

 **IMPORTANT:** After you remove the HP Recovery partition, you will not be able to perform System Recovery or create HP recovery media from the HP Recovery partition. So before you remove the Recovery partition, create HP Recovery media; see [Creating HP Recovery media \(select products only\) on page 87](#).

 **NOTE:** The Remove Recovery Partition option is only available on products that support this function.

Follow these steps to remove the HP Recovery partition:

1. Type `recovery` in the taskbar search box, and then select **HP Recovery Manager**.
2. Select **Remove Recovery Partition**, and then follow the on-screen instructions.

11 Using HP PC Hardware Diagnostics (UEFI)

HP PC Hardware Diagnostics is a Unified Extensible Firmware Interface (UEFI) that allows you to run diagnostic tests to determine whether the computer hardware is functioning properly. The tool runs outside the operating system so that it can isolate hardware failures from issues that are caused by the operating system or other software components.

When HP PC Hardware Diagnostics (UEFI) detects a failure that requires hardware replacement, a 24-digit Failure ID code is generated. This ID code can then be provided to support to help determine how to correct the problem.

 **NOTE:** To start diagnostics on a convertible computer, your computer must be in notebook mode and you must use the keyboard attached.

To start HP PC Hardware Diagnostics (UEFI), follow these steps:

1. Turn on or restart the computer, and quickly press **esc**.
2. Press **f2**.

The BIOS searches three places for the diagnostic tools, in the following order:

- a. Connected USB drive

 **NOTE:** To download the HP PC Hardware Diagnostics (UEFI) tool to a USB drive, see [Downloading HP PC Hardware Diagnostics \(UEFI\) to a USB device on page 93](#).

- b. Hard drive
 - c. BIOS
3. When the diagnostic tool opens, select the type of diagnostic test you want to run, and then follow the on-screen instructions.

 **NOTE:** If you need to stop a diagnostic test, press **esc**.

Downloading HP PC Hardware Diagnostics (UEFI) to a USB device

 **NOTE:** The HP PC Hardware Diagnostics (UEFI) download instructions are provided in English only, and you must use a Windows computer to download and create the HP UEFI support environment because only .exe files are offered.

There are two options to download HP PC Hardware Diagnostics to a USB device.

Download the latest UEFI version

1. Go to <http://www.hp.com/go/techcenter/pcdiags>. The HP PC Diagnostics home page is displayed.
2. In the HP PC Hardware Diagnostics section, select the **Download** link, and then select **Run**.

Download any version of UEFI for a specific product

1. Go to <http://www.hp.com/support>.
2. Select **Get software and drivers**.

3. Enter the product name or number.

– or –

Select **Identify now** to let HP automatically detect your product.

4. Select your computer, and then select your operating system.
5. In the **Diagnostic** section, follow the on-screen instructions to select and download the UEFI version you want.

12 Specifications

Computer specifications

	Metric	U.S.
Dimensions (touch models)		
Depth	254.6 mm	10.02 in
Width	384.3 mm	15.13 in
Height	24.3 mm	0.96 in
Weight		
3 cell battery	1994 g	4.40 lb
4 cell battery	2040 g	4.50 lb
Input power		
Operating voltage and current	19.5 V dc @ 3.33 A – 65 W	
	19.5 V dc @ 2.31 A – 45 W	
Temperature		
Operating	5°C to 35°C	41°F to 95°F
Nonoperating	-20°C to 60°C	-4°F to 140°F
Relative humidity (noncondensing)		
Operating	10% to 90%	
Nonoperating	5% to 95%	
Maximum altitude (unpressurized)		
Operating	-15 m to 3,048 m	-50 ft to 10,000 ft
Nonoperating	-15 m to 12,192 m	-50 ft to 40,000 ft
NOTE: Applicable product safety standards specify thermal limits for plastic surfaces. The device operates well within this range of temperatures.		

39.6-cm (15.6-in) display specifications

	Metric	U.S.
Active diagonal size	39.6-cm	15.6-in
Resolution	1366x768 (HD) 1920x1080 (FHD)	
Surface treatment	BrightView	
Brightness	200 nits (touch) 220 nits (non-touch)	
Viewing angle	SVA	
Backlight	WLED	
Graphics adapter	eDP	
Thickness	3.2 mm (touch) 3.8 mm (non-touch)	

Hard drive specifications, hybrid drives

1000-GB*, 8 GB NAND hybrid SSD	
Dimensions	
Height	5 mm
Length	100.2 mm
Width	69.9 mm
Weight	70.0 g
Form Factor	2.5 inch
NAND flash memory	8 GB
Average seek time	12 ms
Formatted capacity	1,000,204,886 MB
User sectors per drive	1,953,525,168
Disk rotational speed	5400 rpm
Operating temperature	0°C to 60°C (32°F to 140°F)
*1 GB = 1 billion bytes when referring to hard drive storage capacity. Actual accessible capacity is less.	
NOTE: Certain restrictions and exclusions apply. Contact technical support for details.	

Hard drive specifications

	2-TB*	1-TB*	500-GB*
Dimensions			
Height	9.5 mm	9.5 mm	7.0 mm or 9.5 mm
Length	100.4 mm	100.4 mm	100.6 mm
Width	69.9 mm	69.9 mm	70.1 mm
Weight	130.0 g	107.0 g	92.0 g
Interface type	SATA	SATA	SATA
Transfer rate			
Synchronous (maximum)	300 MB/sec	300 MB/sec	300 MB/sec
Security	ATA security	ATA security	ATA security
Seek times (typical read, including setting)			
Single track	2.0 ms	2.0 ms	3 ms
Average (read/write)	12 ms	12 ms	13 ms
Maximum	22 ms	22 ms	24 ms
Logical blocks	3,907,029,168	1,953,525,168	1,048,576,000
Disk rotational speed	5400 rpm	5400 rpm	5400 rpm
Operating temperature	0°C to 60°C (32°F to 140°F)		
*1 GB = 1 billion bytes when referring to hard drive storage capacity. Actual accessible capacity is less.			
NOTE: Certain restrictions and exclusions apply. Contact technical support for details.			

M.2 solid-state drive specifications

	128-GB*	256-GB*
Dimensions		
Height	1 mm	1 mm
Length	50.8 mm	50.8 mm
Width	28.9 mm	28.9 mm
Weight	< 10 g	< 10 g
Interface type	ATA-7	ATA-7
Transfer rate		
Sequential Read	Up to 520 MB/s	Up to 540 MB/s
Random Read	Up to 60K IOPs	Up to 85K IOPs
Sequential Write	Up to 160 MB/s	Up to 280 MB/s
Random Write	Up to 34K IOPs	Up to 67K IOPs
Ready time, Maximum (to not busy)	1.0 s	1.0 s
Access times		
Logical	0.1 ms	0.1
Total logical sectors	250,069,680	500,118,192
Operating temperature		
Operating	0° to 70°C (32°F to 158°F)	0° to 70°C (32°F to 158°F)
Non-operating	-40° to 95°C (-40°F to 203°F)	-55° to 90°C (-67°F to 194°F)
*1 GB = 1 billion bytes when referring to hard drive storage capacity. Actual accessible capacity is less.		
NOTE: Certain restrictions and exclusions apply. Contact technical support for details.		

DVD±RW SuperMulti DL Drive specifications

Component	Value	
Applicable disc	Read: CD-DA, CD+(E)G, CD-MIDI, CD-TEXT, CD-ROM, CD-ROM XA, MIXED MODE CD, CD-I, CD-I Bridge (Photo-CD, Video CD), Multisession CD (Photo-CD, CD-EXTRA, Portfolio, CD-R, CD-RW), CD-R, CD-RW, DVD-ROM (DVD-5, DVD-9, DVD-10, DVD-18), DVD-R, DVD-RW, DVD+R, DVD+RW, DVD-RAM	Write: CD-R and CD-RW DVD+R, DVD+RW, DVD-R, DVD-RW, DVD-RAM
Center hole diameter	1.5 cm (0.59 in)	
Disc diameter		
Standard disc	12 cm (4.72 in)	
Mini disc	8 cm (3.15 in)	
Disc thickness	1.2 mm (0.047 in)	
Track pitch	0.74 μm	
Access time	CD	DVD
Random	< 175 ms	< 230 ms
Full stroke	< 285 ms	< 335 ms
Audio output level	Line-out, 0.7 Vrms	
Cache buffer	2 MB	
Data transfer rate		
24X CD-ROM	3,600 KB/sec	
8X DVD-ROM	10,800 KB/sec	
24X CD-R	3,600 KB/sec	
16X CD-RW	2,400 KB/sec	
8X DVD+R	10,800 KB/sec	
4X DVD+RW	5,400 KB/sec	
8X DVD-R	10,800 KB/sec	
4X DVD-RW	5,400 KB/sec	
2.4X DVD+R(9)	2,700 KB/sec	
5X DVD-RAM	6,750 KB/sec	
Transfer mode	Multiword DMA Mode	
Startup time	< 15 seconds	
Stop time	< 6 seconds	

13 Statement of memory volatility

The purpose of this chapter is to provide general information regarding nonvolatile memory in HP Business PCs. This chapter also provides general instructions for restoring nonvolatile memory that can contain personal data after the system has been powered off and the hard drive has been removed.

HP Business PC products that use Intel®-based or AMD®-based system boards contain volatile DDR memory. The amount of nonvolatile memory present in the system depends upon the system configuration. Intel-based and AMD-based system boards contain nonvolatile memory subcomponents as originally shipped from HP, assuming that no subsequent modifications have been made to the system and assuming that no applications, features, or functionality have been added to or installed on the system.

Following system shutdown and removal of all power sources from an HP Business PC system, personal data can remain on volatile system memory (DIMMs) for a finite period of time and will also remain in nonvolatile memory. Use the steps below to remove personal data from the PC, including the nonvolatile memory found in Intel-based and AMD-based system boards.

 **NOTE:** If your tablet has a keyboard base, connect to the keyboard base before beginning steps in this chapter.

Current BIOS steps

1. Follow steps (a) through (f) below to restore the nonvolatile memory that can contain personal data. Restoring or reprogramming nonvolatile memory that does not store personal data is neither necessary nor recommended.
 - a. Turn on or restart the computer, and then press **esc** while the "Press the ESC key for Startup Menu" message is displayed at the bottom of the screen.

 **IMPORTANT:** If the **Main** menu displays **Restore Defaults** instead of **Apply Factory Defaults and Exit**, go to [Legacy BIOS Steps on page 102](#).

 **NOTE:** If the system has a BIOS administrator password, enter the password at the prompt.
 - b. Select **Main**, select **Apply Factory Defaults and Exit**, and then select **Yes** to load defaults.
The computer will reboot.
 - c. During the reboot, press **esc** while the "Press the ESC key for Startup Menu" message is displayed at the bottom of the screen.

 **NOTE:** If the system has a BIOS administrator password, enter the password at the prompt.
 - d. Select the **Security** menu, select **Restore Security Settings to Factory Defaults**, and then select **Yes** to restore security level defaults.
The computer will reboot.
 - e. During the reboot, press **esc** while the "Press the ESC key for Startup Menu" message is displayed at the bottom of the screen.

 **NOTE:** If the system has a BIOS administrator password, enter the password at the prompt.
 - f. If an asset or ownership tag is set, select the **Security** menu and scroll down to the **Utilities** menu. Select **System IDs**, and then select **Asset Tracking Number**. Clear the tag, and then make the selection to return to the prior menu.

- g. If a DriveLock password is set, select the **Security** menu, and scroll down to **Hard Drive Utilities** under the **Utilities** menu. Select **Hard Drive Utilities**, select **DriveLock**, then uncheck the checkbox for **DriveLock password on restart**. Select **OK** to proceed.
- h. Select the **Main** menu, and then select **Reset BIOS Security to factory default**. Click **Yes** at the warning message.
The computer will reboot.
- i. During the reboot, press **esc** while the "Press the ESC key for Startup Menu" message is displayed at the bottom of the screen.

 **NOTE:** If the system has a BIOS administrator password, enter the password at the prompt.

- j. Select the **Main** menu, select **Apply Factory Defaults and Exit**, select **Yes** to save changes and exit, and then select **Shutdown**.
 - k. Reboot the system. If the system has a Trusted Platform Module (TPM) and/or fingerprint reader, one or two prompts will appear—one to clear the TPM and the other to Reset Fingerprint Sensor; press or tap **F1** to accept or **F2** to reject.
 - l. Remove all power and system batteries for at least 24 hours.
2. Complete one of the following:
- Remove and retain the storage drive.
 - or –
 - Clear the drive contents by using a third party utility designed to erase data from an SSD.
 - or –
 - Clear the contents of the drive by using the following BIOS Setup Secure Erase command option steps:

 **IMPORTANT:** If you clear data using Secure Erase, it cannot be recovered.

- a. Turn on or restart the computer, and then press **esc** while the "Press the ESC key for Startup Menu" message is displayed at the bottom of the screen.
- b. Select the **Security** menu and scroll down to the **Utilities** menu.
- c. Select **Hard Drive Tools**.
- d. Under **Utilities**, select **Secure Erase**, select the hard drive storing the data you want to clear, and then follow the on-screen instructions to continue.

Legacy BIOS Steps

Use the steps for older versions of BIOS.

 **NOTE:** If you already completed the steps in [Current BIOS steps on page 101](#), skip this section.

1. Follow steps (a) through (i) below to restore the nonvolatile memory that can contain personal data. Restoring or reprogramming nonvolatile memory that does not store personal data is neither necessary nor recommended.

 **NOTE:** If you have not already done so, access the BIOS menu.

- Turn on or restart the computer, and then press **esc** while the "Press the ESC key for Startup Menu" message is displayed at the bottom of the screen.

 **NOTE:** If the system has a BIOS administrator password, enter the password at the prompt.

- a. Select **Main**, select **Restore Defaults**, and then select **Yes** to load defaults.
 - b. Select the **Security** menu, select **Restore Security Level Defaults**, and then select **Yes** to restore security level defaults.
 - c. If an asset or ownership tag is set, select the **Security** menu and scroll down to the **Utilities** menu. Select **System IDs**, and then select **Asset Tracking Number**. Clear the tag, and then make the selection to return to the prior menu.
 - d. If a DriveLock password is set, select the **Security** menu, and scroll down to **Hard Drive Tools** under the **Utilities** menu. Select **Hard Drive Tools**, select **DriveLock**, then uncheck the checkbox for **DriveLock password on restart**. Select **OK** to proceed.
 - e. If an Automatic DriveLock password is set, select the **Security** menu, scroll down to **Hard Drive Tools** under the **Utilities** menu. Select **Hard Drive Tools**, scroll down to **Automatic DriveLock**, then select the desired hard drive and disable protection. At the automatic drive lock warning screen, select **Yes** to continue. Repeat this procedure if more than one hard drive has an Automatic DriveLock password.
 - f. Select the **Main** menu, and then select **Reset BIOS Security to factory default**. Click **Yes** at the warning message.
 - g. Select the **Main** menu, select **Save Changes and Exit**, select **Yes** to save changes and exit, and then select **Shutdown**.
 - h. Reboot the system. If the system has a Trusted Platform Module (TPM) and/or fingerprint reader, one or two prompts will appear—one to clear the TPM and the other to Reset Fingerprint Sensor; press or tap **F1** to accept or **F2** to reject.
 - i. Remove all power and system batteries for at least 24 hours.
2. Complete one of the following:
- Remove and retain the storage drive.
 - or –
 - Clear the drive contents by using a third party utility designed to erase data from an SSD.
 - or –
 - Clear the contents of the drive by using the following BIOS Setup Secure Erase command option steps:

 **IMPORTANT:** If you clear data using Secure Erase, it cannot be recovered.

- a. Turn on or restart the computer, and then press **esc** while the "Press the ESC key for Startup Menu" message is displayed at the bottom of the screen.
 - b. Select the **Security** menu and scroll down to the **Utilities** menu.
 - c. Select **Hard Drive Tools**.
 - d. Under **Utilities**, select **Secure Erase**, select the hard drive storing the data you want to clear, and then follow the on-screen instructions to continue.
- or –
- Clear the contents of the drive by using the following Disk Sanitizer command steps:

 **IMPORTANT:** If you clear data using Disk Sanitizer, it cannot be recovered.

 **NOTE:** The amount of time it takes for Disk Sanitizer to run can take several hours. Plug the computer into an AC outlet before starting.

- a. Turn on or restart the computer, and then press **esc** while the "Press the ESC key for Startup Menu" message is displayed at the bottom of the screen.
- b. Select the **Security** menu and scroll down to the **Utilities** menu.
- c. Select **Hard Drive Tools**.
- d. Under **Utilities**, select **Disk Sanitizer**, select the hard drive storing the data you want to clear, and then follow the on-screen instructions to continue.

Nonvolatile memory usage

Nonvolatile Memory Type	Amount (Size)	Does this memory store customer data?	Does this memory retain data when power is removed?	What is the purpose of this memory?	How is data input into this memory?	How is this memory write-protected?
HP Sure Start flash (select models only)	2 MBytes	No	Yes	Provides protected backup of critical System BIOS code, EC firmware, and critical PC configuration data for select platforms that support HP Sure Start. For more information, see Using HP Sure Start (select models only) on page 108.	Data cannot be written to this device via the host processor. The content is managed solely by the HP Sure Start Embedded Controller.	This memory is protected by the HP Sure Start Embedded Controller.
Real Time Clock (RTC) battery backed-up CMOS configuration memory	256 Bytes	No	Yes	Stores system date and time and noncritical data.	RTC battery backed-up CMOS is programmed using the Computer Setup (BIOS), or changing the Microsoft Windows date & time.	This memory is not write-protected.
Controller (NIC) EEPROM	64 KBytes (not customer accessible)	No	Yes	Stores NIC configuration and NIC firmware.	NIC EEPROM is programmed using a utility from the NIC vendor that can be run from DOS.	A utility is required to write data to this memory and is available from the NIC vendor. Writing data to this ROM in an inappropriate manner will render the NIC non-functional.
DIMM Serial Presence Detect (SPD) configuration data	256 Bytes per memory module, 128 Bytes programmable (not customer accessible)	No	Yes	Stores memory module information.	DIMM SPD is programmed by the memory vendor.	Data cannot be written to this memory when the module is installed in a PC. The specific write-protection method varies by memory vendor.
System BIOS	4 MBytes to 5 MBytes	Yes	Yes	Stores system BIOS code and PC configuration data.	System BIOS code is programmed at the factory. Code is updated when the system BIOS is updated. Configuration data and settings are input using the Computer Setup (BIOS) or a custom utility.	NOTE: Writing data to this ROM in an inappropriate manner can render the PC non-functional. A utility is required for writing data to this memory and is available on the HP website; go to http://www.hp.com/support . Select Find your product , and then follow

Nonvolatile Memory Type	Amount (Size)	Does this memory store customer data?	Does this memory retain data when power is removed?	What is the purpose of this memory?	How is data input into this memory?	How is this memory write-protected?
Intel Management Engine Firmware (present in only specific ZBook and EliteBook models. For more information, go to http://www.hp.com/support . Select Find your product , and then follow the on-screen instructions.)	1.5 MBytes or 5 MBytes	Yes	Yes	Stores Management Engine Code, Settings, Provisioning Data and iAMT third-party data store.	Management Engine Code is programmed at the factory. Code is updated via Intel secure firmware update utility. Unique Provisioning Data can be entered at the factory or by an administrator using the Management Engine (MEBx) setup utility. The third party data store contents can be populated by a remote management console or local applications that have been registered by an administrator to have access to the space.	the on-screen instructions. The Intel chipset is configured to enforce hardware protection to block all direct read/write access to this area. An Intel utility is required for updating the firmware. Only firmware updates digitally signed by Intel can be applied using this utility.
Bluetooth flash	2 Mbit	No	Yes	Stores Bluetooth configuration and firmware.	Bluetooth flash is programmed at the factory. Tools for writing data to this memory are not publicly available but can be obtained from the silicon vendor.	A utility is required for writing data to this memory and is made available through newer versions of the driver whenever the flash requires an upgrade.
802.11 WLAN EEPROM	4 Kbit to 8 Kbit	No	Yes	Stores configuration and calibration data.	802.11 WLAN EEPROM is programmed at the factory. Tools for writing data to this memory are not made public.	A utility is required for writing data to this memory and is typically not made available to the public unless a firmware upgrade is necessary to address a unique issue.
Web camera	64 Kbit	No	Yes	Stores webcam configuration and firmware.	Webcam memory is programmed using a utility from the device manufacturer that can be run from Windows.	A utility is required for writing data to this memory and is typically not made available to the public unless a firmware upgrade is necessary to address a unique issue.
Fingerprint reader	512 KByte flash	Yes	Yes	Stores fingerprint templates.	Fingerprint reader memory is programmed by user enrollment in HP ProtectTools Security Manager.	Only a digitally signed application can make the call to write to the flash.

Questions and answers

1. How can the BIOS settings be restored (returned to factory settings)?



IMPORTANT: Restore defaults does not securely erase any data on your hard drive. See question and answer 6 for steps to securely erase data.

Restore defaults does not reset the Custom Secure Boot keys. See question and answer 7 for information about resetting the keys.

- a. Turn on or restart the computer, and then press **esc** while the "Press the ESC key for Startup Menu" message is displayed at the bottom of the screen.
- b. Select **Main**, and then select **Restore defaults**.
- c. Follow the on-screen instructions.
- d. Select **Main**, select **Save Changes and Exit**, and then follow the on-screen instructions.

2. What is a UEFI BIOS, and how is it different from a legacy BIOS?

The Unified Extensible Firmware Interface (UEFI) BIOS is an industry-standard software interface between the platform firmware and an operating system (OS). It is a replacement for the older BIOS architecture, but supports much of the legacy BIOS functionality.

Like the legacy BIOS, the UEFI BIOS provides an interface to display the system information and configuration settings and to change the configuration of your computer before an OS is loaded. BIOS provides a secure run-time environment that supports a Graphic User Interface (GUI). In this environment, you can use either a pointing device (Touchscreen, TouchPad, pointing stick, or USB mouse) or the keyboard to navigate and make menu and configuration selections. The UEFI BIOS also contains basic system diagnostics.

The UEFI BIOS provides functionality beyond that of the legacy BIOS. In addition, the UEFI BIOS works to initialize the computer's hardware before loading and executing the OS; the run-time environment allows the loading and execution of software programs from storage devices to provide more functionality, such as advanced hardware diagnostics (with the ability to display more detailed system information) and advanced firmware management and recovery software.

HP has provided options in Computer Setup (BIOS) to allow you to run in legacy BIOS, if required by the operating system. Examples of this requirement would be if you upgrade or downgrade the OS.

3. Where does the UEFI BIOS reside?

The UEFI BIOS resides on a flash memory chip. A utility is required to write to the chip.

4. What kind of configuration data is stored on the DIMM Serial Presence Detect (SPD) memory module? How would this data be written?

The DIMM SPD memory contains information about the memory module, such as size, serial number, data width, speed/timing, voltage, and thermal information. This information is written by the module manufacturer and stored on an EEPROM. This EEPROM cannot be written to when the memory module is installed in a PC. Third-party tools do exist that can write to the EEPROM when the memory module is not installed in a PC. Various third-party tools are available to read SPD memory.

5. What is meant by "Restore the nonvolatile memory found in Intel-based system boards"?

This message relates to clearing the Real Time Clock (RTC) CMOS memory that contains PC configuration data.

6. How can the BIOS security be reset to factory defaults and data erased?

 **IMPORTANT:** Resetting will result in the loss of information.

These steps will not reset Custom Secure Boot Keys. See question and answer 7 for information about resetting the keys.

- a. Turn on or restart the computer, and then press **esc** while the "Press the ESC key for Startup Menu" message is displayed at the bottom of the screen.
- b. Select **Main**, and then select **Reset BIOS Security to Factory Default**.
- c. Follow the on-screen instructions.
- d. Select **Main**, select **Save Changes and Exit**, and then follow the on-screen instructions.

7. How can the Custom Secure Boot Keys be reset?

Secure Boot is a feature to ensure that only authenticated code can start on a platform. If you enabled Secure Boot and created Custom Secure Boot Keys, simply disabling Secure Boot will not clear the keys. You must also select to clear the Custom Secure Boot Keys. Use the same Secure Boot access procedure you used to create the Custom Secure Boot Keys, but make the selection to clear or delete all Secure Boot Keys.

- a. Turn on or restart the computer, and then press **esc** while the "Press the ESC key for Startup Menu" message is displayed at the bottom of the screen.
- b. Select the **Security** menu, select **Secure Boot Configuration**, and then follow the on-screen instructions.
- c. At the **Secure Boot Configuration** window, select **Secure Boot**, select **Clear Secure Boot Keys**, and then follow the on-screen instructions to continue.

Using HP Sure Start (select models only)

Select computer models are configured with HP Sure Start, a technology that continuously monitors your computer's BIOS for attacks or corruption. If the BIOS becomes corrupted or is attacked, HP Sure Start restores the BIOS to its previously safe state, without user intervention. Those select computer models ship with HP Sure Start configured and enabled. HP Sure Start is configured and already enabled so that most users can use the HP Sure Start default configuration. The default configuration can be customized by advanced users.

To access the latest documentation on HP Sure Start, go to <http://www.hp.com/support>. Select **Find your product**, and then follow the on-screen instructions.

14 Power cord set requirements

The wide-range input feature of the computer permits it to operate from any line voltage from 100 to 120 volts ac, or from 220 to 240 volts ac.

The 3-conductor power cord set included with the computer meets the requirements for use in the country or region where the equipment is purchased.

Power cord sets for use in other countries and regions must meet the requirements of the country or region where the computer is used.

Requirements for all countries

The following requirements are applicable to all countries and regions:

- The length of the power cord set must be at least **1.5 m** (5.0 ft) and no more than **2.0 m** (6.5 ft).
- All power cord sets must be approved by an acceptable accredited agency responsible for evaluation in the country or region where the power cord set will be used.
- The power cord sets must have a minimum current capacity of 10 A and a nominal voltage rating of 125 or 250 V ac, as required by the power system of each country or region.
- The appliance coupler must meet the mechanical configuration of an EN 60 320/IEC 320 Standard Sheet C13 connector for mating with the appliance inlet on the back of the computer.

Requirements for specific countries and regions

Country/region	Accredited agency	Applicable note number
Argentina	IRAM	1
Australia	SAA	1
Austria	OVE	1
Belgium	CEBEC	1
Brazil	ABNT	1
Canada	CSA	2
Chile	IMQ	1
Denmark	DEMKO	1
Finland	FIMKO	1
France	UTE	1
Germany	VDE	1
India	ISI	1
Israel	SII	1
Italy	IMQ	1
Japan	JIS	3
The Netherlands	KEMA	1
New Zealand	SANZ	1
Norway	NEMKO	1
The People's Republic of China	CCC	4
Saudi Arabia	SASO	7
Singapore	PSB	1
South Africa	SABS	1
South Korea	KTL	5
Sweden	SEMKO	1
Switzerland	SEV	1
Taiwan	BSMI	6
Thailand	TISI	1
The United Kingdom	ASTA	1
The United States	UL	2

1. The flexible cord must be Type H05VV-F, 3-conductor, 0.75mm² conductor size. Power cord set fittings (appliance coupler and wall plug) must bear the certification mark of the agency responsible for evaluation in the country or region where it will be used.
2. The flexible cord must be Type SVT/SJT or equivalent, No. 18 AWG, 3-conductor. The wall plug must be a two-pole grounding type with a NEMA 5-15P (15 A, 125 V ac) or NEMA 6-15P (15 A, 250 V ac) configuration. CSA or C-UL mark. UL file number must be on each element.

Country/region	Accredited agency	Applicable note number
		3. The appliance coupler, flexible cord, and wall plug must bear a “T” mark and registration number in accordance with the Japanese Dentori Law. The flexible cord must be Type VCTF, 3-conductor, 0.75mm ² or 1.25mm ² conductor size. The wall plug must be a two-pole grounding type with a Japanese Industrial Standard C8303 (7 A, 125 V ac) configuration.
		4. The flexible cord must be Type RVV, 3-conductor, 0.75mm ² conductor size. Power cord set fittings (appliance coupler and wall plug) must bear the CCC certification mark.
		5. The flexible cord must be Type H05VV-F 3X0.75mm ² conductor size. KTL logo and individual approval number must be on each element. Corset approval number and logo must be printed on a flag label.
		6. The flexible cord must be Type HVCTF 3X1.25mm ² conductor size. Power cord set fittings (appliance coupler, cable, and wall plug) must bear the BSMI certification mark.
		7. For 127 V ac, the flexible cord must be Type SVT or SJT 3 x 18 AWG, with plug NEMA 5-15P (15 A, 125 V ac), with UL and CSA or C-UL marks. For 240 V ac, the flexible cord must be Type H05VV-F 3X0.75/1.00mm ² conductor size, with plug BS 1363/A with BSI or ASTA marks.

15 Recycling

When a non-rechargeable or rechargeable battery has reached the end of its useful life, do not dispose of the battery in general household waste. Follow the local laws and regulations in your area for battery disposal.

HP encourages customers to recycle used electronic hardware, HP original print cartridges, and rechargeable batteries. For more information about recycling programs, see the HP Web site at <http://www.hp.com/recycle>.

Index

A

- AC adapter and battery 15
- action keys 20
 - identifying 19
- airplane mode key 20
- antenna
 - illustrated 32
- antennas
 - removing 71
- audio, product description 4, 7, 10
- audio-out (headphone)/audio-in (microphone) jack, identifying 15

B

- backups 81, 87
- battery
 - illustrated 27
 - removing 38
- battery cover, identifying 21
- battery lock, identifying 21
- battery release latch 21
- BIOS
 - determining version 77, 79
 - downloading an update 77, 80
 - starting the Setup Utility 79
 - updating 77, 79
- Bluetooth label 22
- boot order
 - changing 85, 91
- bottom 22
- bottom cover
 - illustrated 26
 - removing 42
 - spare part numbers 42
- buttons
 - left TouchPad 16
 - optical drive eject 14
 - power 18
 - right TouchPad 16

C

- cables, service considerations 33
- caps lock light, identifying 17
- chipset, product description 1, 6, 9

- components for the HP Notebook 15
 - computer model
 - bottom 21
 - display 13
 - left side 15
 - right side 14
 - top 16
 - computer major components, illustrated 23
 - computer specifications 95
 - connector, power 15
 - connectors, service considerations 33

D

- deleted files
 - restoring 84
- display assembly
 - illustrated 24
 - removing 66
- display assembly subcomponents
 - illustrated 31
 - removing 66
- display bezel
 - illustrated 31
 - removing 68
- display cable
 - illustrated 31
 - removing 70
- display enclosure
 - illustrated 32
 - removing 71
- display panel
 - illustrated 31, 66
 - product description 2, 6, 9
 - removing 69, 70
- display specifications 96
- drive light 14
- DVD±RW SuperMulti DL Drive
 - specifications 99

E

- electrostatic discharge 34
- equipment guidelines 36
- esc key, identifying 19

- Ethernet, product description 4, 7, 10
- external media cards 4, 7, 10

F

- fan
 - illustrated 26
 - removing 60
- fn key, identifying 19

G

- graphics, product description 1, 6, 9
- grounding guidelines 34
- guidelines
 - equipment 36
 - grounding 34
 - packaging 35
 - transporting 35
 - workstation 35

H

- hard drive
 - illustrated 26, 28
 - precautions 34
 - product description 3, 6, 9
 - removing 50
 - specifications 96, 97
- hard drive board
 - illustrated 26
- hard drive brackets
 - illustrated 29
 - removing 51
- hard drive connector
 - removing 51
- hard drive connector and cable
 - removing 51
- HDMI port
 - identifying 15
- heat sink assembly
 - illustrated 25
 - removing 25, 57
- hinges
 - illustrated 31
 - removing 69, 70

- HP PC Hardware Diagnostics (UEFI)
 - using 93
 - HP Recovery Manager 84
 - correcting boot problems 91
 - starting 90
 - HP Recovery media
 - creating 87
 - recovery 90
 - HP Recovery partition
 - recovery 90
 - removing 91
 - HP Sure Start 108
- I**
- integrated numeric keypad,
 - identifying 19
 - internal card
 - product description 4, 7, 10
 - internal microphone, identifying 13
- J**
- jacks
 - audio-out (headphone)/audio-in (microphone) 15
 - network 15
 - RJ-45 (network) 15
- K**
- keyboard
 - illustrated 24
 - product description 5, 8, 11
 - keys
 - action 19
 - airplane mode 20
 - esc 19
 - fn 19
 - Windows 19
- L**
- labels
 - Bluetooth 22
 - regulatory 22
 - serial number 22
 - service 22
 - wireless certification 22
 - WLAN 22
 - latch, battery release 21
 - lights
 - AC adapter and battery light 15
 - caps lock 17
 - drive 14
 - mute 17
 - power 14
 - RJ-45 (network) status 15
- M**
- M.2 solid-state drive
 - specifications 98
 - mass storage devices
 - illustrated 28
 - precautions 34
 - memory
 - nonvolatile 101
 - volatile 101
 - memory card reader, identifying 14
 - memory card, identifying 14
 - memory module
 - illustrated 25
 - product description 2, 6, 9
 - removing 46
 - microphone 3, 7, 10
 - minimized image recovery 90
 - minimized image, creating 89
 - model name 1, 6, 9
 - mute light, identifying 17
- N**
- network jack, identifying 15
 - nonvolatile memory 101
- O**
- operating system 5, 8, 11
 - optical drive
 - illustrated 27, 28
 - precautions 34
 - product description 3, 7, 9
 - removing 39
 - specifications 99
 - optical drive board
 - illustrated 26, 48
 - removing 48
 - optical drive eject button,
 - identifying 14
 - optical drive rear bracket
 - removing 40
 - optical drive, identifying 14
 - original system recovery 84, 89
- P**
- packaging guidelines 35
 - plastic parts, service
 - considerations 33
 - pointing device 5, 8, 11
 - ports
 - HDMI 15
 - product description 4, 7, 10
 - USB 2.0 14, 15
 - USB 3.0 15
 - power button board
 - illustrated 24
 - removing 74
 - power button, identifying 18
 - power connector cable
 - illustrated 26
 - removing 73
 - power connector, identifying 15
 - power cord
 - requirements for all countries 109
 - requirements for specific countries and regions 110
 - set requirements 109
 - spare part numbers 30
 - power lights, identifying 14
 - power requirements 5, 8, 11
 - processor
 - product description 1, 6, 9
 - product description
 - audio 4, 7, 10
 - chipset 1, 6, 9
 - display panel 2, 6, 9
 - Ethernet 4, 7, 10
 - external media cards 4, 7, 10
 - graphics 1, 6, 9
 - hard drive 3, 6, 9
 - internal card 4, 7, 10
 - keyboard 5, 8, 11
 - memory module 2, 6, 9
 - microphone 3, 7, 10
 - operating system 5, 8, 11
 - optical drive 3, 7, 9
 - pointing device 5, 8, 11
 - ports 4, 7, 10
 - power requirements 5, 8, 11
 - processor 1, 6, 9
 - product name 1, 6, 9
 - security 5, 8, 11
 - serviceability 5, 8, 11
 - video 3, 7, 10
 - wireless 4, 7, 10
 - product name 1, 6, 9

product name and number,
computer 22

R

recover

options 89

recovering from the recovery discs
85

recovering the original system 84

recovery 84

discs 88, 90

HP Recovery Manager 84, 89

media 90

starting 90

supported discs 88

system 89

USB flash drive 90

using HP Recovery media 88

recovery discs 81

recovery media 81

creating 87

creating using HP Recovery

Manager 88

recovery partition

removing 91

recovery, system 84

regulatory information

regulatory label 22

wireless certification labels 22

removal/replacement

preliminaries 33

procedures 37, 41

removing personal data from volatile

system memory 101

restore points 82

restoring the original system

creating recovery media 81

RJ-45 (network) jack, identifying 15

RJ-45 (network) status lights,

identifying 15

RTC battery

illustrated 25

removing 53

S

security cable slot, identifying 14

security, product description 5, 8,
11

serial number 22

serial number, computer 22

service considerations

cables 33

connectors 33

plastic parts 33

service labels, locating 22

serviceability, product description
5, 8, 11

slots

memory card reader 14

security cable 14

solid-state drive

illustrated 28

removal 55

spare part number 26, 28, 55

solid-state drive board

illustrated 26, 56

removing 56

speakers

identifying 21

illustrated 24

removing 49

specifications

computer 95

display 96

DVD±RW SuperMulti DL Drive 99

hard drive 96, 97

M.2 solid-state drive 98

optical drive 99

supported discs 81

supported discs, recovery 88

system board

removing 63

spare part number 24, 63

system memory, removing personal

data from volatile 101

system recovery 84, 89

system restore point

creating 88

system restore point, creating 87

system restore points 82

creating 82

T

tools required 33

top cover/keyboard

removing 75

TouchPad

buttons 16

TouchPad button board

removing 62

spare part number 24, 62

TouchPad zone, identifying 16

transporting guidelines 35

traveling with the computer 22

U

USB 2.0 port, identifying 14, 15

USB 3.0 port, identifying 15

USB board

removing 54

spare part number 26

V

vents, identifying 15

video, product description 3, 7, 10

W

webcam

identifying 13

webcam light, identifying 13

webcam/microphone cable

illustrated 31

removing 69, 70

webcam/microphone module

illustrated 32

removing 68

Windows

system restore point 87, 88

Windows Backup and Restore

restoring files 84

Windows key, identifying 19

Windows tools

using 88

wireless antenna

illustrated 32

wireless antennas

removing 71

wireless certification label 22

wireless, product description 4, 7,
10

WLAN antennas, identifying 13

WLAN device 22

WLAN label 22

WLAN module

illustrated 25

removing 44

workstation guidelines 35

