

Operating Instructions Functional Manual

LCD Projector Commercial Use

Model No. PT-LW375
PT-LW335
PT-LB425
PT-LB385
PT-LB355
PT-LB305

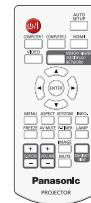
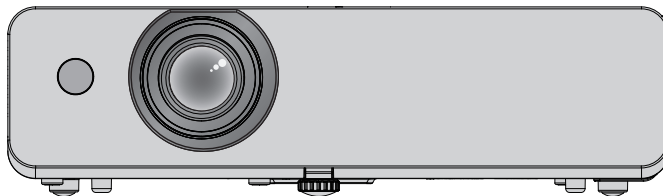

Thank you for purchasing this Panasonic product.

- Before operating this product, please read the instructions carefully, and save this manual for future use.
- Before using your projector, be sure to read “Read this first!” (➔ pages 4 to 12).

PJLink™

ENGLISH

DPQP1248ZA/X1

Contents

Read this first!4

Chapter 1 Preparation

Precautions for use	16
Intended use of the product.....	16
Cautions when transporting.....	16
Cautions when installing.....	16
Security	18
Notes on Using Wireless Connection.....	18
Application software supported by the projector ..	19
Storage.....	19
Disposal.....	19
Cautions on use	20
Accessories	21
Optional accessories	22
About your projector	23
Remote control	23
Projector body	24
Preparing the remote control	28
Inserting and Removing batteries.....	28
When using the multiple projectors	28

Chapter 2 Getting Started

Setting up	30
Installation mode	30
Parts for ceiling mount (Optional).....	30
Screen size and throw distance	31
Connecting	34
Before connecting	34
Connecting example : AV equipment	35
Connecting example : Computers	36

Chapter 3 Basic Operations

Powering on/off	39
Connecting the power cord	39
Power indicator.....	39
Powering On the Projector	40
Making adjustments and selections	40
Powering Off the Projector	41
Projecting	42
Selecting the input signal	42
How to adjust the state of the image	43
Adjusting adjustable foot	44
Basic operations by using the remote control	45
Performing automatic setup	45
Switching the aspect ratio of the image.....	45
Using the screen adjustment function	46
Using the status function	46
Using the freeze function.....	47
Using the AV mute function	47

Using the presentation timer function.....	47
Switching the brightness of the light source	47
Using the digital zoom function	48
Controlling the volume of the speaker.....	48
Switching the image mode	48
Using the mute function.....	48
Using the Daylight View Lite function	49
Setting the remote control ID numbers.....	49

Chapter 4 Settings

Menu Navigation	51
Navigating through the menu	51
Main menu.....	52
Sub-menu	53
[Display] menu	55
[Auto PC adj.]	55
[Fine sync]	55
[H Position]	55
[V Position]	56
[H.Size].....	56
[Aspect]	56
[Project way].....	56
[Menu position]	57
[Background display]	57
[System]	57
[Color adjust] menu	58
[Image mode]	58
[Contrast].....	58
[Brightness]	58
[Color].....	59
[Tint].....	59
[Color temp.].....	59
[Red] / [Green] / [Blue].....	59
[Sharpness]	60
[Daylight View].....	60
[Setting] menu	61
[On start].....	61
[Standby mode]	61
[High land]	61
[Lamp control].....	61
[Cooling fast]	62
[Closed caption].....	62
[Key lock].....	62
[Iris].....	63
[Sound]	63
[HDMI Setup].....	63
[Expand] menu	65
[Language]	65
[Auto setup]	65
[Keystone]	66
[Logo]	70
[Security]	72

[Power management]	73	Dimensions	115
[Filter counter]	74	Ceiling mount bracket safeguards.....	116
[Test pattern].....	75	Index	118
[Network]	75		
[Remote control]	76		
[Factory default].....	77		
[Memory Viewer] menu	78		
[Set slide].....	78		
[Slide transition effect]	78		
[Sort order]	78		
[Rotate].....	78		
[Best fit]	78		
[Repeat].....	79		
[Apply]	79		
[Info.] menu	80		
[Info.]	80		

Chapter 5 Operation of Function

About Memory Viewer function.....	82
What you can project with the Memory Viewer function.....	82
Cautions on using USB Memory	82
Displaying the Memory Viewer screen	83
Playing the pictures	83
Executing the slide	83
Termination of the Memory Viewer	83
USB Display function	84
When using on a Windows computer	84
When using on Mac.....	85
Network connection	86
When connecting via wired LAN	86
When connecting via wireless LAN	87
About Presenter Light	89
Web control function.....	90
Computer that can be used for setting	90
Accessing from the web browser	90

Chapter 6 Maintenance

Power/Warning Indicators	97
Maintenance/replacement.....	99
Before performing maintenance/replacement	99
Maintenance	99
Replacing the unit.....	101
Troubleshooting	104

Chapter 7 Appendix

Technical Information	106
Using the PJLink protocol.....	106
<SERIAL IN> terminal	107
List of compatible signals	110
Specifications	112

Read this first!

WARNING: THIS APPARATUS MUST BE EARTHED.

WARNING: To prevent damage which may result in fire or shock hazard, do not expose this appliance to rain or moisture.
This device is not intended for use in the direct field of view at visual display workplaces. To avoid incommoding reflexions at visual display workplaces this device must not be placed in the direct field of view.
The equipment is not intended for used at a video workstation in compliance BildscharbV.
The sound pressure level at the operator position is equal or less than 70 dB (A) according to ISO 7779.

WARNING:

1. Remove the plug from the mains socket when this unit is not in use for a prolonged period of time.
2. To prevent electric shock, do not remove cover. No user serviceable parts inside. Refer servicing to qualified service personnel.
3. Do not remove the earthing pin on the mains plug. This apparatus is equipped with a three prong earthing type mains plug. This plug will only fit an earthing-type mains socket. This is a safety feature. If you are unable to insert the plug into the mains socket, contact an electrician. Do not defeat the purpose of the earthing plug.

WARNING: TO REDUCE THE RISK OF FIRE OR ELECTRIC SHOCK, DO NOT EXPOSE THIS PRODUCT TO RAIN OR MOISTURE.

WARNING: RISK OF ELECTRIC SHOCK. DO NOT OPEN.



Indicated on the projector



The lightning flash with arrowhead symbol, within an equilateral triangle, is intended to alert the user to the presence of uninsulated “dangerous voltage” within the product’s enclosure that may be of sufficient magnitude to constitute a risk of electric shock to persons.



The exclamation point within an equilateral triangle is intended to alert the user to the presence of important operating and maintenance (servicing) instructions in the literature accompanying the product.

WARNING:



TURN THE POWER OFF AND DISCONNECT THE POWER PLUG FROM THE WALL OUTLET BEFORE REPLACING THE LAMP UNIT.

WARNING: Do not look at the light emitted from the lens while the projector is being used.

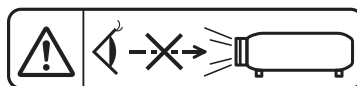

Indicated on the projector

Read this first!

WARNING: Do not place objects in front of the lens while the projector is being used.



Indicated on the projector

CAUTION: To assure continued compliance, follow the attached installation instructions. This includes using the provided power cord and shielded interface cables when connecting to computer or peripheral devices. Also, any unauthorized changes or modifications to this equipment could void the user's authority to operate this device.

This is a device to project images onto a screen, etc., and is not intended for use as indoor lighting in a domestic environment.

Directive 2009/125/EC

CAUTION (North/Middle/South America)

CAUTION: This equipment is equipped with a three-pin grounding-type power plug. Do not remove the grounding pin on the power plug. This plug will only fit a grounding-type power outlet. This is a safety feature. If you are unable to insert the plug into the outlet, contact an electrician. Do not defeat the purpose of the grounding plug.

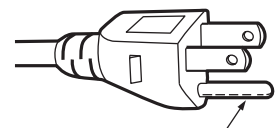

Do not remove

FCC NOTICE (USA)

Supplier's Declaration of Conformity

Model Number: PT-LW375 / PT-LW335 / PT-LB425 / PT-LB385 / PT-LB355 / PT-LB305
Trade Name: Panasonic
Responsible Party: Panasonic Corporation of North America
Address: Two Riverfront Plaza, Newark, NJ 07102-5490
General Contact: <http://www.panasonic.com/support>
Projector Contact: <https://panasonic.net/cns/projector/>

This device complies with Part 15 of the FCC Rules.

Operation is subject to the following two conditions:

(1) This device may not cause harmful interference, and (2) this device must accept any interference received, including interference that may cause undesired operation.

To assure continued compliance, follow the attached installation instructions and do not make any unauthorized modifications.

CAUTION:

This equipment has been tested and found to comply with the limits for a Class B digital device, pursuant to Part 15 of the FCC Rules. These limits are designed to provide reasonable protection against harmful interference in a residential installation. This equipment generates, uses and can radiate radio frequency energy and, if not installed and used in accordance with the instructions, may cause harmful interference to radio communications. However, there is no guarantee that interference will not occur in a particular installation. If this equipment does cause harmful interference to radio or television reception, which can be determined by turning the equipment off and on, the user is encouraged to try to correct the interference by one of the following measures:

- Reorient or relocate the receiving antenna.
- Increase the separation between the equipment and receiver.
- Connect the equipment into an outlet on a circuit different from that to which the receiver is connected.
- Consult the dealer or an experienced radio/BD technician for help.

The user may find the booklet "Something About Interference" available from FCC local regional offices helpful.

FCC Warning:

To assure continued FCC emission limit compliance, follow the attached installation instructions. This includes using the provided power cord and shielded interface cables when connecting to computer or peripheral devices. Also, any unauthorized changes or modifications to this equipment could void the user's authority to operate this device.

WARNING (USA and Canada)

- Not for use in a computer room as defined in the Standard for the Protection of Electronic Computer/Data Processing Equipment, ANSI/NFPA 75.
- For permanently connected equipment, a readily accessible disconnect device shall be incorporated in the building installation wiring.
- For pluggable equipment, the socket-outlet shall be installed near the equipment and shall be easily accessible.

NOTIFICATION (USA)

- This product has a High Intensity Discharge (HID) lamp that contains mercury. Disposal may be regulated in your community due to environmental considerations. For disposal or recycling information, please visit Panasonic website: <http://www.panasonic.com/environmental> or call 1-888-769-0149.

NOTIFICATION (Canada)

This class B digital apparatus complies with Canadian ICES-003.

Contains mercury / Contenu avec mercure

For more information on safe handling procedures, the measures to be taken in case of accidental breakage and safe disposal options visit:
ec.gc.ca/mercure-mercury/.
Dispose of or recycle in accordance with applicable laws.

Pour plus de renseignements sur les procédures de manutention sécuritaire, les mesures à prendre en cas de bris accidentel et les options d'élimination sécuritaire visitez:
ec.gc.ca/mercure-mercury/.
Mettez au rebut ou recyclez conformément aux lois applicables.

IMPORTANT: THE MOULDED PLUG (U.K. only)

FOR YOUR SAFETY, PLEASE READ THE FOLLOWING TEXT CAREFULLY.

This appliance is supplied with a moulded three pin mains plug for your safety and convenience. A 13 amp fuse is fitted in this plug. Should the fuse need to be replaced, please ensure that the replacement fuse has a rating of 13 amps and that it is approved by ASTA or BSI to BS1362.

Check for the ASTA mark  or the BSI mark  on the body of the fuse.

If the plug contains a removable fuse cover, you must ensure that it is refitted when the fuse is replaced. If you lose the fuse cover, the plug must not be used until a replacement cover is obtained. A replacement fuse cover can be purchased from an Authorised Service Center.

If the fitted moulded plug is unsuitable for the mains socket in your home, then the fuse should be removed and the plug cut off and disposed of safely. There is a danger of severe electrical shock if the cut off plug is inserted into any 13 amp socket.

If a new plug is to be fitted, please observe the wiring code as shown below.

If in any doubt, please consult a qualified electrician.

WARNING: THIS APPLIANCE MUST BE EARTHED.

IMPORTANT: The wires in this mains lead are coloured in accordance with the following code:

Green - and - Yellow:	Earth
Blue:	Neutral
Brown:	Live

As the colours of the wire in the mains lead of this appliance may not correspond with the coloured markings identifying the terminals in your plug, proceed as follows.

The wire which is coloured GREEN - AND - YELLOW must be connected to the terminal in the plug which is marked with the letter E or by the Earth symbol  or coloured GREEN or GREEN - AND - YELLOW.

The wire which is coloured BLUE must be connected to the terminal in the plug which is marked with the letter N or coloured BLACK.

The wire which is coloured BROWN must be connected to the terminal in the plug which is marked with the letter L or coloured RED.

How to replace the fuse: Open the fuse compartment with a screwdriver and replace the fuse.

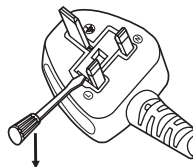

Importer's name and address within the European Union

Panasonic Marketing Europe GmbH

Panasonic Testing Centre

Winsbergring 15, 22525 Hamburg, Germany

WARNING:

■ POWER

The wall outlet or the circuit breaker shall be installed near the equipment and shall be easily accessible when problems occur. If the following problems occur, cut off the power supply immediately.

Continued use of the projector in these conditions will result in fire or electric shock.

- If foreign objects or water get inside the projector, cut off the power supply.
 - If the projector is dropped or the cabinet is broken, cut off the power supply.
 - If you notice smoke, strange smells or noise coming from the projector, cut off the power supply.
- Please contact an Authorized Service Center for repairs, and do not attempt to repair the projector yourself.

During a thunderstorm, do not touch the projector or the cable.

Electric shocks can result.

Do not do anything that might damage the power cord or the power plug.

If the power cord is used while damaged, electric shocks, short-circuits or fire will result.

- Do not damage the power cord, make any modifications to it, place it near any hot objects, bend it excessively, twist it, pull it, place heavy objects on top of it or wrap it into a bundle.

Ask an Authorized Service Center to carry out any repairs to the power cord that might be necessary.

Completely insert the power plug into the wall outlet and the power connector into the projector terminal.

If the plug is not inserted correctly, electric shocks or overheating will result.

- Do not use plugs which are damaged or wall outlets which are coming loose from the wall.

Do not use anything other than the provided power cord.

Failure to observe this will result in electric shocks or fire. Please note that if you do not use the provided power cord to ground the device on the side of the outlet, this may result in electric shocks.

Clean the power plug regularly to prevent it from becoming covered in dust.

Failure to observe this will cause a fire.

- If dust builds up on the power plug, the resulting humidity can damage the insulation.
 - If not using the projector for an extended period of time, pull the power plug out from the wall outlet.
- Pull the power plug out from the wall outlet and wipe it with a dry cloth regularly.

Do not handle the power plug and power connector with wet hands.

Failure to observe this will result in electric shocks.

Do not overload the wall outlet.

If the power supply is overloaded (ex., by using too many adapters), overheating may occur and fire will result.

■ ON USE/INSTALLATION

Do not place the projector on soft materials such as carpets or sponge mats.

Doing so will cause the projector to overheat, which can cause burns, fire or damage to the projector.

Do not set up the projector in humid or dusty places or in places where the projector may come into contact with oily smoke or steam.

Using the projector under such conditions will result in fire, electric shocks or components deterioration. Components deterioration (such as ceiling mount brackets) may cause the projector which is mounted on the ceiling to fall down.

Do not install this projector in a place which is not strong enough to take the full weight of the projector or on top of a surface which is sloped or unstable.

Failure to observe this will cause projector to fall down or tip over the projector, and severe injury or damage could result.

Installation work (such as ceiling mount bracket) should only be carried out by a qualified technician.

If installation is not carried out and secured correctly it can cause injury or accidents, such as electric shocks.

- Be sure to use the wire provided with the projector mount bracket for ceiling mount as an extra safety measure to prevent the projector from falling down (Install in a different location to the ceiling mount bracket).

Do not install the projector in a location where people pass through.

People may bump into the projector or trip on the power cord, which may result in fire, electric shock, or injury.

Do not cover the air intake/exhaust ports.

Doing so will cause the projector to overheat, which can cause fire or damage to the projector.

- Do not place the projector in narrow, badly ventilated places.
- Do not place the projector on cloth or papers, as these materials could be drawn into the air intake port.
- Provide at least 1 m (39-3/8") of space between any walls or objects and the exhaust port, and at least 50 cm (19-11/16") of space between any walls or objects and the intake port.

WARNING:

Do not place your hands or other objects close to the air exhaust port.

Doing so will cause burns or damage your hands or other objects.

- Heated air comes out of the air exhaust port. Do not place your hands or face, or objects which cannot withstand heat close to this port.

Do not look and place your skin into the lights emitted from the lens while the projector is being used.

Doing so can cause burns or loss of sight.

- Strong light is emitted from the projector's lens. Do not look or place your hands directly into this light.
- Be especially careful not to let young children look into the lens. In addition, turn off the power and disconnect the power plug when you are away from the projector.

Never attempt to remodel or disassemble the projector.

High voltages can cause fire or electric shocks.

- For any inspection, adjustment and repair work, please contact an Authorized Service Center.

Do not allow metal objects, flammable objects, or liquids to enter inside of the projector. Do not allow the projector to get wet.

Doing so may cause short circuits or overheating, and result in fire, electric shock, or malfunction of the projector.

- Do not place containers of liquid or metal objects near the projector.
- If liquid enters inside of the projector, consult your dealer.
- Particular attention must be paid to children.

Use the ceiling mount bracket specified by Panasonic.

Using the ceiling mount bracket other than the specified one will result in falling accidents.

- Attach the supplied safety cable to the ceiling mount bracket to prevent the projector from falling down.

Do not touch or remove the rubber cap at the bottom of the projector.

- Doing so will cause burns because the temperature is very high when the lamp is lighting and for a while after the lamp is turned off.

■ ACCESSORIES

Do not use or handle the batteries improperly, and refer to the following.

Failure to observe this will cause burns, batteries to leak, overheat, explode or catch fire.

- Do not use unspecified batteries.
- Do not charge dry cell batteries.
- Do not disassemble dry cell batteries.
- Do not heat the batteries or place them into water or fire.
- Do not allow the + and - terminals of the batteries to come into contact with metallic objects such as necklaces or hairpins.
- Do not store or carry batteries together with metallic objects.
- Store the batteries in a plastic bag and keep them away from metallic objects.
- Make sure the polarities (+ and -) are correct when inserting the batteries.
- Do not use a new battery together with an old battery or mix different types of batteries.
- Do not use batteries with the outer cover peeling away or removed.

Do not allow children to reach the batteries and the rubber cap that is removed from the bottom of the projector.

Accidentally swallowing them can cause physical harm.

- If swallowed, seek medical advice immediately.

If the battery fluid leaks, do not touch it with bare hands, and take the following measures if necessary.

- Battery fluid on your skin or clothing could result in skin inflammation or injury.
Rinse with clean water and seek medical advice immediately.
- Battery fluid coming in contact with your eyes could result in loss of sight.
In this case, do not rub your eyes. Rinse with clean water and seek medical advice immediately.

Do not remove unspecified screws during the lamp unit replacement.

Doing so can cause electric shocks, burns, or injury.

Do not disassemble the lamp unit.

If the lamp breaks, it could cause injury.

WARNING:

Lamp replacement

The lamp has high internal pressure. If improperly handled, an explosion and severe injury or accidents will result.

- The lamp can easily explode if struck against hard objects or dropped.
- Before replacing the lamp, be sure to disconnect the power plug from the wall outlet. Electric shocks or explosions can result if this is not done.
- When replacing the lamp, turn the power off and allow the lamp to cool for at least 1 hour before handling it otherwise it can cause burns.

Remove the depleted batteries from the remote control promptly.

- Leaving them in the unit may result in fluid leakage, overheating, or explosion of the batteries.

CAUTION:

■ **POWER**

When disconnecting the power cord, be sure to hold the power plug and power connector.

If the power cord itself is pulled, the lead will become damaged, and fire, short-circuits or serious electric shocks will result.

When not using the projector for an extended period of time, disconnect the power plug from the wall outlet.

Failure to do so may result in fire or electric shock.

Disconnect the power plug from the wall outlet before carrying out any cleaning and replacing the unit.

Electric shocks can result if this is not done.

■ **ON USE/INSTALLATION**

Do not place heavy objects on top of the projector.

Failure to observe this will cause the projector to become unbalanced and fall, which could result in damage or injury. The projector will be damaged or deformed.

Do not put your weight on this projector.

You could fall or the projector could break, and injury will result.

- Be especially careful not to let young children stand or sit on the projector.

Do not place the projector in extremely hot locations.

Doing so will cause the outer casing or internal components to deteriorate, or result in fire.

- Take particular care in locations exposed to direct sunlight or near stoves.

Do not place the projector where it may be affected by salt or corrosive gas.

Doing so may cause the projector to become faulty due to corrosion.

Do not place objects in front of the lens while the projector is being used.

Do not block the projection by placing an object in front of the projection lens.

Doing so can cause fire or damage to the object and can cause the projector to malfunction.

- Strong light is emitted from the projector's lens.

Do not stand in front of the lens while the projector is being used.

Doing so can cause damage and burns to clothing.

- Strong light is emitted from the projector's lens.

Always disconnect all cables before moving the projector.

Moving the projector with cables still attached can damage the cables, which will cause fire or electric shocks to occur.

When mounting the projector on the ceiling, keep mounting screws and power cord from contacting with metal parts inside the ceiling.

Contact with metal parts inside the ceiling can cause electric shocks.

Never plug headphones and earphones into <VARIABLE AUDIO OUT> terminal.

Excessive sound pressure from earphones and headphones can cause hearing loss.

■ **ACCESSORIES**

Do not use the old lamp unit.

If used it could cause lamp explosion.

CAUTION:

If the lamp has broken, ventilate the room immediately. Do not touch or bring your face close to the broken pieces.

Failure to observe this will cause the user to absorb the gas which was released when the lamp broke and which contains nearly the same amount of mercury as fluorescent lamps, and the broken pieces will cause injury.

- If you believe that you have absorbed the gas or that the gas has got into your eyes or mouth, seek medical advice immediately.
- Ask your dealer about replacing the lamp unit and check the inside of the projector.

When not using the projector for an extended period of time, remove the batteries from the remote control.

Failure to observe this will cause the batteries to leak, overheat, catch fire or explode, which may result in fire or contamination of surrounding area.

■ MAINTENANCE

Ask your dealer about cleaning inside the projector once a year.

Continuous use while dust is accumulated inside the projector may result in fire.

- For cleaning fee, ask your dealer.

To remove the battery

1. Press the guide and lift the cover.

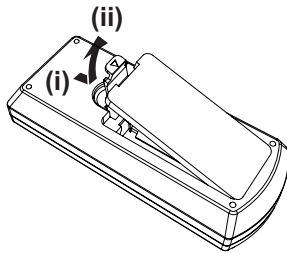

2. Remove the batteries.

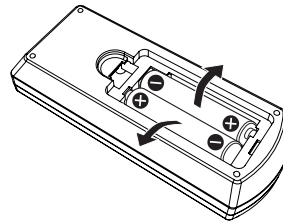

Brazil Only Brasil Apenas

■ Manuseio de baterias usadas



BRASIL

Após o uso, as pilhas e /ou baterias deverão ser entregues ao estabelecimento comercial ou rede de assistência técnica autorizada.

Cobrir os terminais positivo (+) e negativo (-) com uma fita isolante adesiva, antes de depositar numa caixa destinada para o recolhimento. O contato entre partes metálicas pode causar vazamentos, gerar calor, romper a blindagem e produzir fogo. (Fig. 1)

Fig. 1
Como isolar os terminais

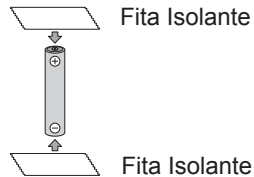

Não desmonte, não remova o invólucro, nem amasse a bateria. O gás liberado pela bateria pode irritar a garganta, danificar o lacre do invólucro ou o vazamento provocar calor, ruptura da blindagem e produzir fogo devido ao curto circuito dos terminais. Não incinere nem aqueça as baterias, elas não podem ficar expostas a temperaturas superiores a 100 °C (212 °F). O gás liberado pela bateria pode irritar a garganta, danificar o lacre do invólucro ou o vazamento provocar calor, ruptura da blindagem e produzir fogo devido ao curto circuito dos terminais provocado internamente.

Evite o contato com o líquido que vazar das baterias. Caso isto ocorra, lave bem a parte afetada com bastante água. Caso haja irritação, consulte um médico.

■ Remoção das baterias

1. Pressione a guia e levante a tampa.

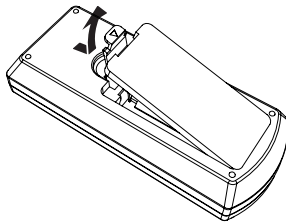

2. Remova as baterias.

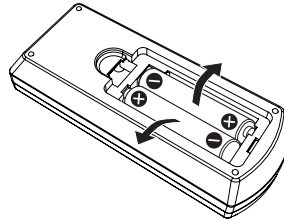

■ Trademarks

- Windows, Internet Explorer and Microsoft Edge are registered trademarks or trademarks of Microsoft Corporation in the United States and other countries.
- Mac, OS X, macOS, iPad, iPhone, iPod touch and Safari are trademarks of Apple Inc., registered in the United States and other countries.
- IOS is a trademark and registered trademark of Cisco in the United States and other countries and is used under license.
- Android is a trademark of Google Inc.
- The terms HDMI and HDMI High-Definition Multimedia Interface, and the HDMI Logo are trademarks or registered trademarks of HDMI Licensing Administrator, Inc. in the United States and other countries.
- Intel® is a trademark of Intel Corporation registered in the United States and/or other countries.
- Trademark PJLink is a trademark applied for trademark rights in Japan, the United States of America and other countries and areas.
- Adobe, Acrobat, and Reader are either registered trademarks or trademarks of Adobe Systems Incorporated in the United States and/or other countries.
- All other names, company names, and product names mentioned in this manual are trademarks or registered trademarks of their respective owners.

Please note that the ® and ™ symbols are not specified in this manual.

■ Software information regarding this product

This product incorporates the following software:

- (1) the software developed independently by or for Panasonic Corporation,
- (2) the software owned by third party and licensed to Panasonic Corporation,
- (3) the software licensed under the GNU General Public License, Version 2.0 (GPL V2.0),
- (4) the software licensed under the GNU LESSER General Public License, Version 2.1 (LGPL V2.1), and/or
- (5) open source software other than the software licensed under the GPL V2.0 and/or LGPL V2.1.

The software categorized as (3) - (5) are distributed in the hope that it will be useful, but WITHOUT ANY WARRANTY, without even the implied warranty of MERCHANTABILITY or FITNESS FOR A PARTICULAR PURPOSE. Please refer to the detailed terms and conditions thereof shown in the "Operating Instructions - Basic Guide" supplied with the product.

At least three (3) years from delivery of this product, Panasonic will give to any third party who contacts us at the contact information provided below, for a charge no more than our cost of physically performing source code distribution, a complete machine-readable copy of the corresponding source code covered under GPL V2.0, LGPL V2.1 or the other licenses with the obligation to do so, as well as the respective copyright notice thereof.

Contact Information: oss-cd-request@gg.jp.panasonic.com

Presenter Light uses the following software programs.

A portion of this software is based in part on the work of the Independent JPEG Group.

■ Illustrations in these operating instructions

- Illustrations of the projector, menu screen (OSD), and other parts may vary from the actual product.
- Illustrations displayed on the computer screen may differ depending on the computer type and its operating system.
- Illustrations of the projector with the power cord attached are only examples. The shape of the supplied power cords varies depending on the country where you purchased the product.

■ Page references

- Reference pages in this manual are indicated as : (➡ page 00).

■ Terms

- In this manual, the "Wireless remote control unit" accessory is referred to as the "Remote control".
- The <INPUT/ENTER> button on the control panel is functioned as the <ENTER> button when the menu screen is displayed.

The operating procedure of menu screen is described as "Press the <ENTER> button" in this manual in order to unify the control panel operation with the remote control operation.

Features of the Projector

Comfortable viewing in a bright environment

- ▶ The high contrast ratio 16 000 : 1 is achieved in a compact body.
- ▶ The low noise level 30 dB*1 supports comfortable viewing during quiet scenes.
- ▶ Supports comfortable viewing in a bright room by pressing the <DAYLIGHT VIEW> button on the remote control. (Daylight View Lite function)

*1 When [Lamp control] is set to [🔇 (Quiet)]

Abundant Image correction Function

(Only for PT-LW375, PT-LW335, PT-LB425, PT-LB385 and PT-LB355)

- ▶ H/V Keystone, Corner correction and Curved correction functions allow you to correct the image to fit the screen.

Reduced maintenance costs

- ▶ Maintenance costs are reduced by use of a recommended lamp replacement interval of 20 000 H*1.

*1 When [Lamp control] is constantly set to [💡 (Eco)] without switching to other modes
This time is only the target for replacement and not the warranty time.

Quick Steps

For details, see the corresponding pages.

1. **Set up your projector.**
(⇒ page 30)



2. **Connect with other devices.**
(⇒ page 34)



3. **Connect the power cord.**
(⇒ page 39)



4. **Power on.**
(⇒ page 40)



5. **Select the input signal.**
(⇒ page 42)



6. **Adjust the image.**
(⇒ page 43)

Chapter 1 Preparation

This chapter describes things you need to know or check before using the projector.

Precautions for use

Intended use of the product

The product is intended to project still/moving image signals from video equipment and computers onto a screen.

Cautions when transporting

- When transporting the projector, handle it with care and avoid excessive vibration and impacts. Doing so may damage the internal parts and result in malfunctions.
- Do not transport the projector with the adjustable foot extended. Doing so may damage the adjustable foot.
- (Only for PT-LW375, PT-LW335, PT-LB425, PT-LB385 and PT-LB355)
Do not move or transport the projector with the wireless module (Model No.: ET-WML100) of the optional accessories attached. Doing so may damage the wireless module.

Cautions when installing

■ Do not set up the projector outdoors.

The projector is designed for indoor use only.

■ Do not set up the projector in the following locations.

- Places where vibration and impacts occur such as in a car or vehicle: Doing so may cause damage to internal components or malfunction.
- Locations near the sea or areas affected by corrosive gas: Corrosion may damage internal components or cause the projector to malfunction.
- Near the exhaust of an air conditioner: Depending on the conditions of use, the screen may fluctuate in rare cases due to the heated air from the air exhaust port or the hot or cooled air. Make sure that the exhaust from the projector or other equipment, or the air from the air conditioner does not blow toward the front of the projector.
- Places with sharp temperature fluctuations such as near lights (studio lamps): Doing so may shorten the life of the lamp, or result in deformation of the outer case due to heat, which may cause malfunctions.
Follow the operating environment temperature of the projector.
- Near high-voltage power lines or near motors: Doing so may interfere with the operation of the projector.

■ Ask a qualified technician or your dealer for the installation work such as installing to a ceiling.

To ensure projector performance and safety, ask a qualified technician or your dealer when installing to a ceiling or in a high place.

■ Focus adjustment

The projection lens is thermally affected by the light from the light source, making the focus unstable in the period just after switching on the power. It is recommended that the images be projected continuously for at least 30 minutes before the focus is adjusted.

■ When using the projector in the elevation of below 700 m (2 297'), make sure [High land] is set to [Off].

Failure to do so may shorten the life of the internal parts and result in malfunctions.

■ When using the projector in the elevation of above 700 m (2 297') and below 1 400 m (4 593'), make sure [High land] is set to [On 1].

Failure to do so may shorten the life of the internal parts and result in malfunctions.

■ When using the projector in the elevation of above 1 400 m (4 593') and below 2 700 m (8 858'), make sure [High land] is set to [On 2].

Failure to do so may shorten the life of the internal parts and result in malfunctions.

■ Do not install the projector at elevations of 2 700 m (8 858') or higher above sea level.

Failure to do so may shorten the life of the internal parts and result in malfunctions.

■ Do not tilt the projector or place it on its side.

Do not tilt the projector body more than approximately ± 30 degrees vertically or ± 15 degrees horizontally. Over tilting may result in shortening the life of the components.

For PT-LB305, keystone correction in the horizontal direction is not supported. If the projector is tilted horizontally, horizontal trapezoidal distortion cannot be corrected.

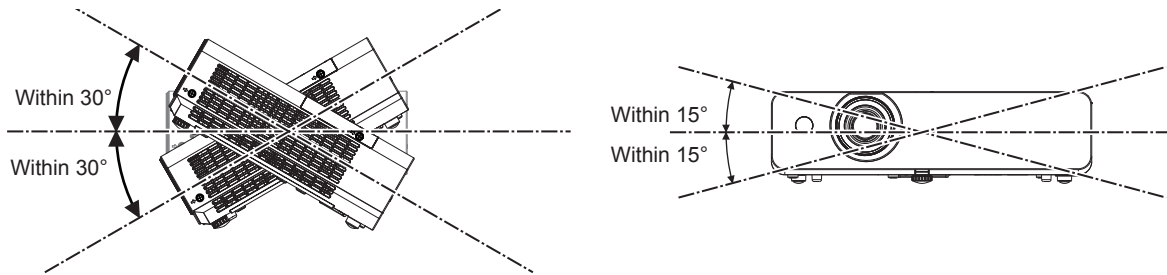

■ Cautions when setting the projectors

- Use the adjustable foot only for adjusting the angle. Using them for other purposes may damage the projector.
- When installing the projector with a method other than the floor installation or the ceiling installation using the ceiling mount bracket, use the four screw holes for ceiling mount (as shown in the figure) to fix the projector. In such case, make sure that there is no clearance between the screw holes for ceiling mount on the projector bottom and the setting surface by inserting spacers (metallic) between them.
- Use a torque screwdriver or Allen torque wrench to tighten the fixing screws to their specified tightening torques. Do not use electric screwdrivers or impact screwdrivers.

(Screw diameter: M4, tapping depth inside the projector: 10 mm (13/32"), screw tightening torque: $1.25 \pm 0.2 \text{ N}\cdot\text{m}$)

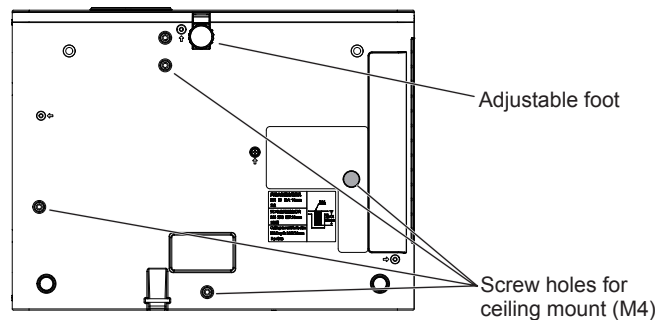

Positions of screw holes for ceiling mount and adjustable foot

- Do not stack the projectors.
- Do not use the projector supporting it by the top.
- Do not block the ventilation ports (intake and exhaust) of the projector.
- Avoid heating and cooling air from the air conditioning system directly blow to the ventilation ports (intake and exhaust) of the projector.

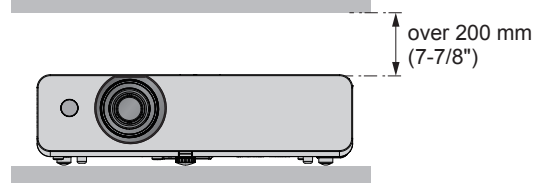
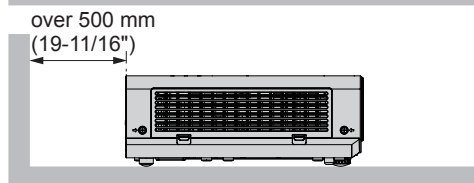
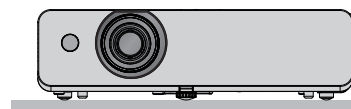
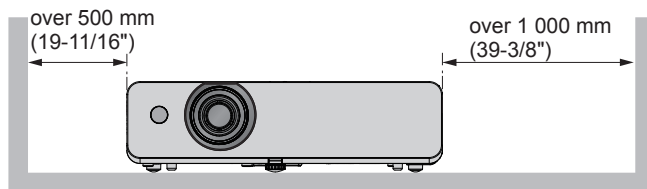
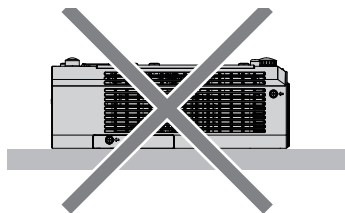
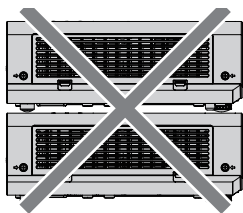

- Do not install the projector in a confined space.
When placing the projector in a confined space, a ventilation and/or air conditioning system is required. Exhaust heat may accumulate when the ventilation is not enough, triggering the protection circuit of the projector.
- Panasonic takes no responsibility for any damage to the product caused by an inappropriate choice of location for installing the projector, even if the warranty period of the product has not expired.

Security

Take safety measures against following incidents.

- Personal information being leaked via this product.
- Unauthorized operation of this product by a malicious third party.
- Interfering or stopping of this product by a malicious third party.

Take sufficient security measures.

- Make your password as difficult to guess as possible.
- Change your password periodically. The password can be set in [Expand] menu → [Security] → [PIN code change].
- Panasonic or its affiliate company never inquires a password directly to a customer. Do not tell your password in case you receive such an inquiry.
- The connecting network must be secured by firewall or others.
- Set a password for web control and restrict the users who can log in. A password for the web control can be set in the [General Setup] page of the web control screen.

Note

- LAN function is not available for PT-LB305.

■ Security when using the wireless LAN product

(Only for PT-LW375, PT-LW335, PT-LB425, PT-LB385 and PT-LB355)

The advantage of a wireless LAN is that information can be exchanged between a computer or other such equipment and a wireless access point using radio waves, instead of using a LAN cable, as long as you are within range for radio transmissions.

On the other hand, because the radio wave can travel through an obstacle (such as a wall) and is accessible from anywhere within a given range, following problems may occur if security setting is insufficient.

- Transmitted data may be intercepted

A malicious third party may intentionally intercept radio waves and monitor the following transmitted data.

- Personal information such as your ID, password, credit card number
- Content of an Email

- Illegally accessed

A malicious third party may access your personal or corporate network without authorization and engage in the following types of behavior.

- Retrieve personal and/or secret information (information leak)
- Spread false information by impersonating a particular person (spoofing)
- Overwrite intercepted communications and issue false data (tampering)
- Spread harmful software such as a computer virus and crash your data and/or system (system crash)

Since most wireless LAN adapters or access points are equipped with security features to take care of these problems, you can reduce the possibility of these problems occurring when using this product by making the appropriate security settings for the wireless LAN device.

Some wireless LAN devices may not be set for security immediately after purchase. To decrease the possibility of occurrence of security problems, be sure to make all security related settings according to the operation instructions supplied with each wireless LAN device before using a wireless LAN device.

Depending on the specifications of the wireless LAN, a malicious third party may be able to break security settings by special means.

Panasonic asks customers to thoroughly understand the risk of using this product without making security settings, and recommends that the customers make security settings at their own discretion and responsibility.

Notes on Using Wireless Connection

(Only for PT-LW375, PT-LW335, PT-LB425, PT-LB385 and PT-LB355)

Wireless connection function of the projector uses radio waves in the 2.4 GHz band.

A radio station license is not required, but be sure to read and fully understand the following items before use.

The wireless module (Model No.: ET-WML100) of optional accessories must be installed when you want to use the wireless LAN function of this projector.

■ Do not use near other wireless equipment.

The following equipment may use radio waves in the same band as the projector.

When the projector is used near these devices, radio wave interference may make communication impossible, or the

communication speed may become slower.

- Microwave ovens, etc.
- Industrial, chemical and medical equipment, etc.
- In-plant radio stations for identifying moving objects such as those used in factory manufacturing lines, etc.
- Designated low-power radio stations

■ If at all possible, avoid the use of cell phones, TV sets or radios near the projector.

Cell phones, TV sets, radios and similar devices use different radio bands from the projector, so there is no effect on wireless communication or the transmission and reception of these devices. However, radio waves from the projector may produce audio or video noise.

■ Wireless communication radio waves cannot penetrate steel reinforcements, metal, concrete, etc.

Communication is possible through walls and floors made from materials such as wood and glass (except glass containing wire mesh), but not through walls and floors made from steel reinforcements, metal, concrete, etc.

■ Do not use the projector as much as possible in a location where static electricity is generated.

The communication via wireless LAN or wired LAN may be prone to disruption when the projector is used in a location where static electricity or noise is generated.

There is a rare case that the LAN connection may not be established due to static electricity or noise, so in such case, turn off the projector, remove the source of problematic static electricity or noise, and turn the projector back on.

■ Using the projector outside the country

Note that depending on countries or regions there are restrictions on the channels and frequencies at which you can use the wireless LAN.

Application software supported by the projector

(Only for PT-LW375, PT-LW335, PT-LB425, PT-LB385 and PT-LB355)

The projector supports following application software. For details or downloading each application software, visit the Panasonic website (<https://panasonic.net/cns/projector/>).

• Multi Monitoring & Control Software

This application software monitors and controls the multiple display devices (projector and flat panel display) connected to an intranet.

• Early Warning Software

This plug-in software monitors the status of the display devices and their peripherals within an intranet, and notifies of abnormality of such equipment and detects the signs of possible abnormality. "Early Warning Software" is preinstalled in the "Multi Monitoring & Control Software". To use the early warning function of this plug-in software, install "Multi Monitoring & Control Software" in the PC to be used. By enabling the early warning function, it will notify of the approximate time to replace the consumables for the display devices, to clean each part of the display devices, and to replace the components of the display devices, allowing to execute maintenance in advance.

The early warning function can be used by registering maximum of 2048 display devices free of charge for 90 days after installing the "Multi Monitoring & Control Software" into a PC. To continuously use after the 90 days, it is necessary to purchase the license of "Early Warning Software" (ET-SWA100 Series) and perform the activation. Also, depending on the type of license, the number of display devices that can be registered for monitoring varies. For details, refer to the Operating Instructions of "Multi Monitoring & Control Software".

• Presenter Light Software

This application software compatible with Windows computers transmits the computer screen to the projector via wireless LAN or wired LAN.

• Wireless Projector

This application software for iOS/Android is used to project files such as PDF or image by transmitting to the projector via wireless LAN.

Storage

When storing the projector, keep it in a dry room.

Disposal

When disposing of the product, ask your local authority or dealer about the correct methods of disposal.

The lamp contains mercury. When disposing of the used lamp unit, ask your nearest local authorities or dealer about proper disposal of the unit.

Dispose of used batteries according to the instructions or your local disposal rule or guidelines.

Cautions on use

■ To get a good picture quality

In order to view a beautiful image in higher contrast, prepare an appropriate environment. Draw curtains or blinds over windows and turn off any lights near the screen to prevent outside light or light from indoor lamps from shining onto the screen.

■ Do not touch the surface of the projector lens with your bare hand.

If the surface of the lens becomes dirty from fingerprints or anything else, this will be magnified and projected onto the screen.

■ LCD Panel

The display unit of this projector comprises three LCD panels. Although an LCD panel is a product of high-precision technology, some of the pixels on the projected image may be missing or constantly lit. Please note that this is not a malfunction.

Displaying a still image for a longer time may result in an after-image on the LCD panels. If this happens, display the all white screen in the Test pattern for an hour or more.

■ Optical components

Operating the projector in an environment with high temperature or heavy exposure to dust or tobacco smoke will reduce the service life of the optical components, such as the LCD panel and polarizing plate, and may necessitate their replacement within less than one year of use. For details, consult your dealer.

■ Lamp

The luminous source of the projector is a mercury lamp with high internal pressure.

A high pressure mercury lamp has following characteristics.

- The brightness of the lamp will decrease by duration of usage.
- The lamp may burst with sound or shorten life by shock or chipping.
- The life of the lamp varies greatly depending on individual specificities and usage conditions. In particular, continuous use over 6 hours and frequent on/off switching of the power greatly deteriorate the lamp and affect the lamp life.
- In rare cases, the lamp burst shortly after the projection.
- The risk of bursting increases when the lamp is used beyond its replacement cycle. Make sure to replace the lamp unit consistently. ("When to replace the lamp unit" (➔ page 101), "Replacing the lamp unit" (➔ page 102))
- If the lamp bursts, gas contained inside of the lamp is released in a form of smoke.
- It is recommended to store replacement lamps for contingency.

■ Computer and external device connections

When connecting a computer or an external device, read this manual carefully regarding the use of power cords and shielded cables as well.

Accessories

Make sure the following accessories are provided with your projector. Numbers enclosed < > show the number of accessories.

Wireless remote control unit <1>

(For PT-LW375, PT-LW335,
PT-LB425, PT-LB385 and
PT-LB355)

(N2QAYA000116)

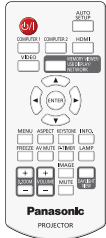

(For PT-LB305)
(N2QAYA000110)

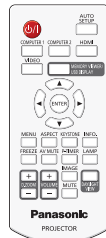

AAA/R03 or AAA/LR03 battery <2>

(for remote control unit)

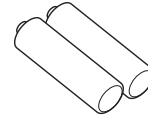

RGB signal cable <1>

(K1HY15YY0012)

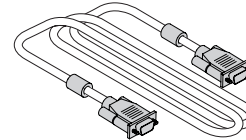

Power cord

(K2CG3YY00184)

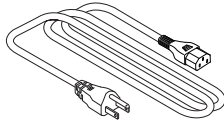

(K2CT3YY00079)

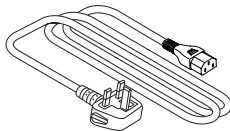

(K2CM3YY00039)

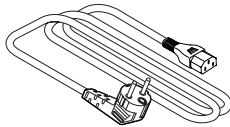

Attention

- After unpacking the projector, discard the power cord cap and packaging material properly.
- Do not use the supplied power cord for devices other than this projector.
- For lost accessories, consult your dealer.
- Store small parts in an appropriate manner, and keep them away from young children.

Note

- The type and number of the power cord depend on the country in which you purchased the product.
- The model numbers of accessories are subject to change without prior notice.

Optional accessories

Options	Model No.
Ceiling Mount Bracket	ET-PKL100H (for high ceilings) ET-PKL100S (for low ceilings) ET-PKL420B (Projector Mount Bracket)
Replacement Lamp Unit	ET-LAL510
Replacement Filter Unit	ET-RFL300
D-SUB - S Video conversion cable	ET-ADSV
Wireless Module ^{**2}	ET-WML100E / ET-WML100U
Early Warning Software (Basic license/3-year license)	ET-SWA100 series ^{*3}

*1 The Wireless Module is only for PT-LW375, PT-LW335, PT-LB425, PT-LB385 and PT-LB355.

*2 In this document, the alphabet letters at the end of the model numbers are omitted.

*3 The suffix of the Model No. differs according to the license type.

Note

- The model numbers of optional accessories are subject to change without prior notice.

About your projector

Remote control

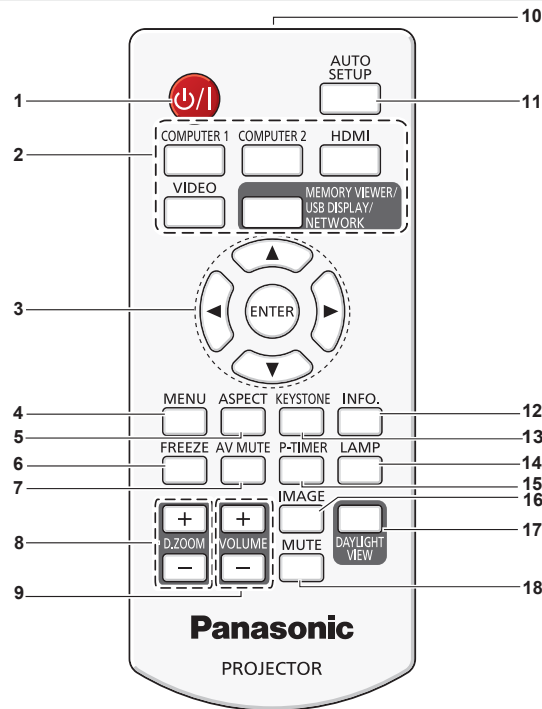

- 1 Power <⏻/▶> button (⏻ standby / ▶ power on)**
Sets the projector to the state where the projector is switched off (standby mode). Also starts projection when the power is switched off (standby mode).
- 2 Input selection buttons (<COMPUTER 1> / <COMPUTER 2>*1 / <HDMI> / <VIDEO> / <MEMORY VIEWER/USB DISPLAY/NETWORK>*2)**
Switches the input signal to project. (➔ page 42)

*1 The <COMPUTER 2> button is only for PT-LW375, PT-LW335, PT-LB425, PT-LB385 and PT-LB355, it is disabled for PT-LB305.

*2 The <MEMORY VIEWER/USB DISPLAY/NETWORK> button is only for PT-LW375, PT-LW335, PT-LB425, PT-LB385 and PT-LB355. The <MEMORY VIEWER/USB DISPLAY> button is for PT-LB305 and it is disabled.
- 3 <ENTER> button/▲▼◀▶ buttons**
Used to navigate through the menu screen.
- 4 <MENU> button**
Displays or hides the main menu. (➔ page 51)
When the sub menu is displayed, pressing it will return to the previous screen.
- 5 <ASPECT> button**
Switches the aspect ratio of the image.
- 6 <FREEZE> button**
Pauses the projected image and mute the audio temporarily. (➔ page 47)
- 7 <AV MUTE> button**
Used to turn off the audio and video temporarily. (➔ page 47)
- 8 <D.ZOOM +/-> buttons**
Zoom in and out the images. (➔ page 48)
- 9 <VOLUME +/-> buttons**
Adjusts the volume of the built-in speaker or audio output. (➔ page 48)
- 10 Remote control signal emitter**
- 11 <AUTO SETUP> button**
Executes Input search, Auto PC adj. and Auto Keystone correction at the same time. (➔ page 45)
- 12 <INFO.> button**
Displays the status of the projector. (➔ page 80)
- 13 <KEystone> button**
Corrects the distortion of the projected image. (➔ page 46)
- 14 <LAMP> button**
Switches the settings of [Lamp control]. (➔ pages 47, 61)
- 15 <P-TIMER> button**
Operate the P-timer function. (➔ page 47)
- 16 <IMAGE> button**
Switches the image mode. (➔ pages 48, 58)
- 17 <DAYLIGHT VIEW> button**
Used to correct the image when the projector is used in a bright surroundings. (➔ pages 49, 60)
- 18 <MUTE> button**
Used when temporarily turning off the audio. (➔ page 48)

Attention

- Do not drop the remote control.
 - Avoid contact with liquids.
 - Do not attempt to modify or disassemble the remote control.
 - Please observe the following contents that are described on the back of the remote control unit (see the right picture).
 - Do not use a new battery together with an old battery.
 - Do not use unspecified batteries.
 - Make sure the polarities (+ and -) are correct when inserting the batteries.
- In addition, please read the contents that are related to batteries in the "Read this first!".

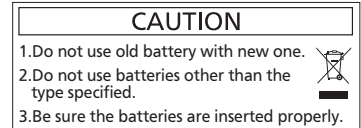

Caution label at the back of the remote control

Note

- The remote control can be used within a distance of about 5 m (16'4-13/16") if pointed directly at the remote control signal receiver. The remote control can control at angles of up to $\pm 30^\circ$ vertically and $\pm 30^\circ$ horizontally, but the effective control range may be reduced.
- If there are any obstacles between the remote control and the remote control signal receiver, the remote control may not operate correctly.
- You can operate the projector by reflecting the remote control signal on the screen. The operating range may differ due to the loss of light caused by the properties of the screen.
- When the remote control signal receiver is lit with a fluorescent light or other strong light source, the projector may become inoperative. Set the projector as far from the luminous source as possible.

Projector body

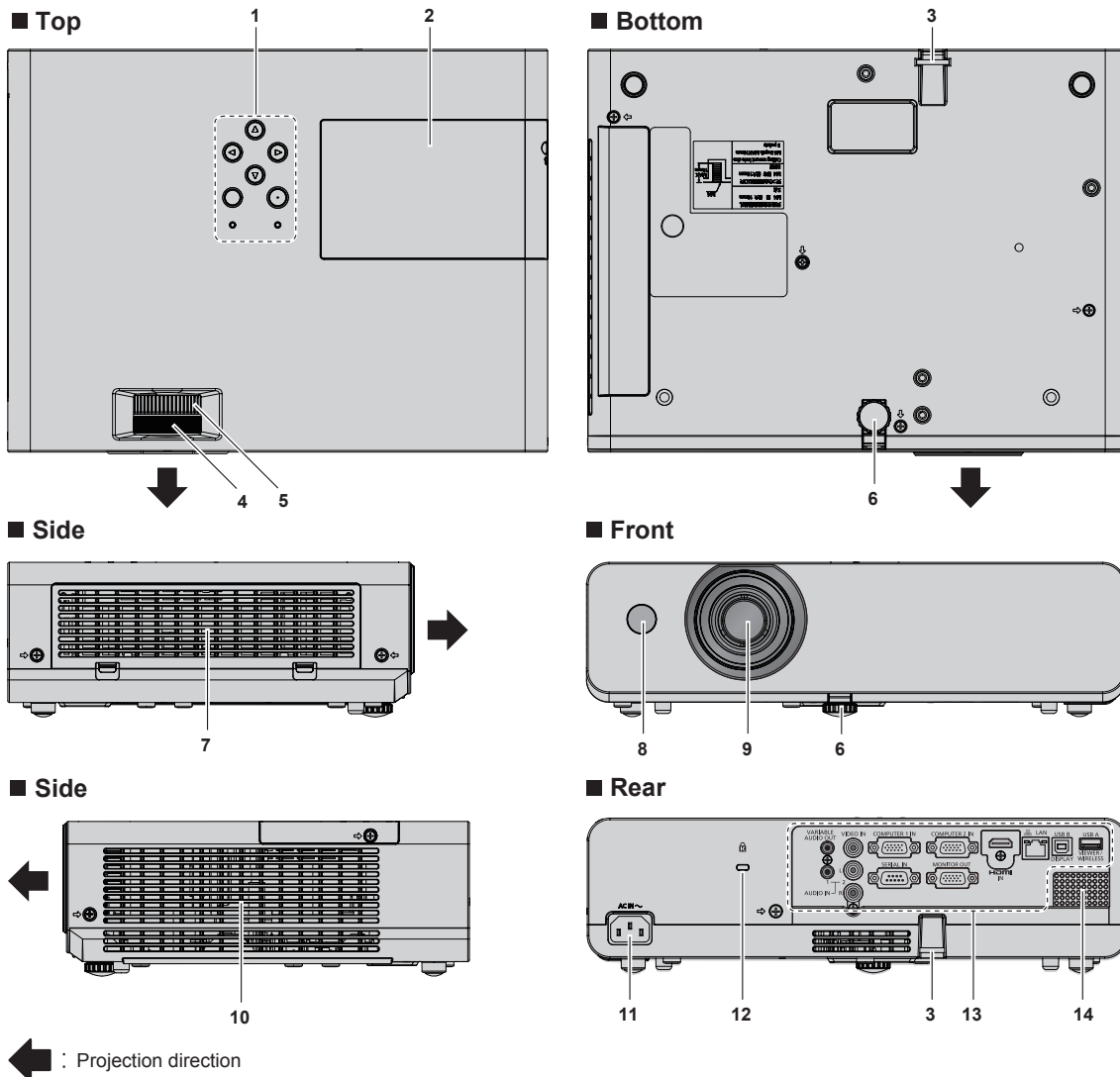

WARNING

Keep your hands and other objects away from the air exhaust port.

- Keep your hand and face away.
- Do not insert your finger.
- Keep heat-sensitive articles away.

Heated air from the air exhaust port can cause burns, injury, or deformations.

- | | |
|---|---|
| <p>1 Panel and Indicators (➔ page 25)</p> <p>2 Lamp cover (➔ page 102)
The lamp unit is located inside.</p> <p>3 Security Chain Hook
Attaches a burglar prevention cable, etc.</p> <p>4 Focus ring (Front)
Adjust the focus.</p> <p>5 Zoom ring (Back)
Adjust the zoom.</p> <p>6 Adjustable foot
Adjust the projection angle.</p> | <p>7 Air intake port / Air filter cover (➔ page 99)
The air filter unit is inside.</p> <p>8 Remote control signal receiver</p> <p>9 Projection Lens</p> <p>10 Air exhaust port</p> <p>11 <AC IN> terminal
Connect the supplied power cord.</p> <p>12 Security slot
This security slot is compatible with the Kensington security cables.</p> <p>13 Rear terminals</p> <p>14 Speaker</p> |
|---|---|

Attention

- Do not block the ventilation ports (intake and exhaust) of the projector.

■ Control panel and Indicators

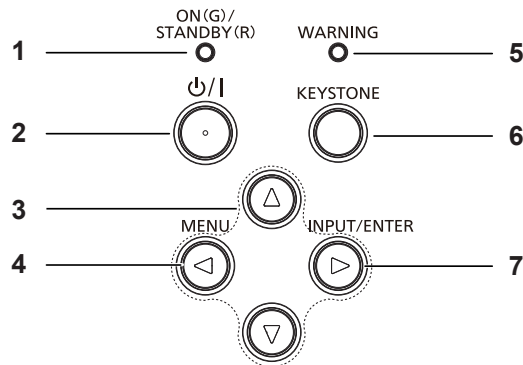

- | | |
|---|--|
| <p>1 Power indicator <ON(G)/STANDBY(R)>
Displays the status of the power.</p> <p>2 Power <⏻/⏻> button (⏻ standby / power on)
Sets the projector to the state where the projector is switched off (standby mode). Also starts projection when the power is switched off (standby mode).</p> <p>3 ▲▼◀▶ buttons
Used to select the menu items in the menu operation.</p> <p>4 <MENU> / ◀ button
Displays or hides the main menu. (➔ page 51)
When the sub menu is displayed, pressing it will return to the previous screen.</p> | <p>5 Warning indicator <WARNING>
Indicates the abnormal conditions of the projector.</p> <p>6 <KEYSTONE> button
Corrects the distortion of the projected image. (➔ page 46)</p> <p>7 <INPUT/ENTER> / ▶ button
Displays the input source menu. (➔ pages 42)
Determines or executes an item in the menu screen.</p> |
|---|--|

Note

- The <INPUT/ENTER> button on the control panel is functioned as the <ENTER> button when the menu screen is displayed. The operating procedure of menu screen is described as “Press the <ENTER> button” in this manual in order to unify the control panel operation with the remote control operation.

■ Connecting terminals

For PT-LW375, PT-LW335, PT-LB425, PT-LB385 and PT-LB355

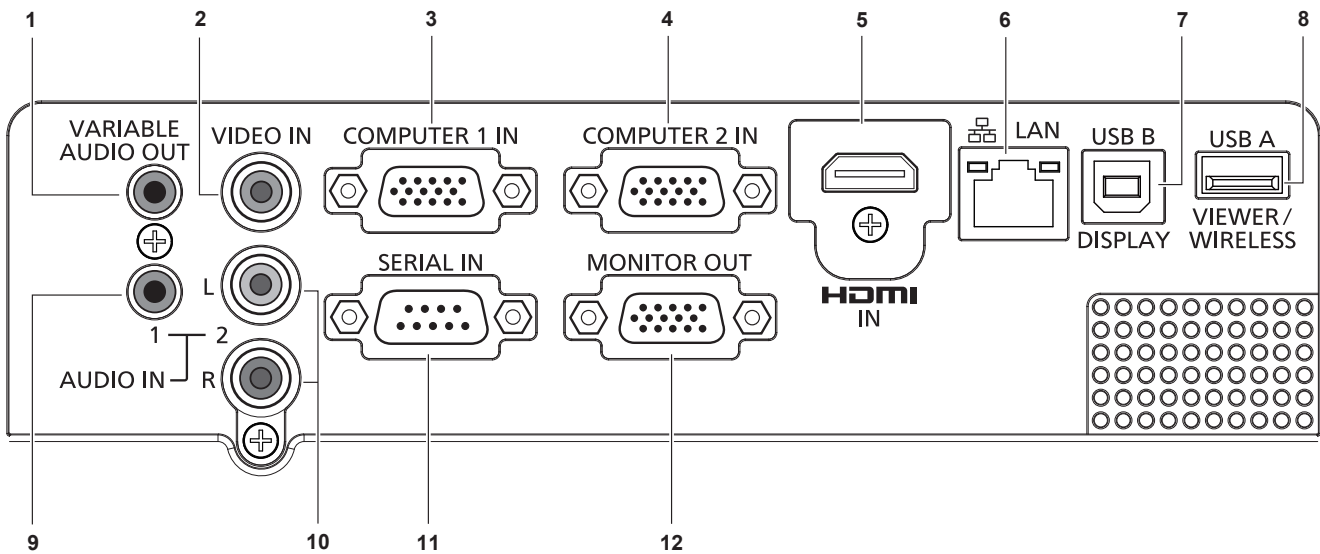

1 <VARIABLE AUDIO OUT> terminal

This is the terminal to output the audio signal input to the projector.

2 <VIDEO IN> terminal

This is the terminal to input video signals.

3 <COMPUTER 1 IN> terminal

This is the terminal to input RGB, YC_BC_R/YP_BP_R or Y/C signals.

4 <COMPUTER 2 IN> terminal

This is the terminal to input RGB signals.

5 <HDMI IN> terminal

This is the terminal to input HDMI signals.

6 <LAN> terminal

This is the LAN terminal to connect to the network.

7 <USB B (DISPLAY)> terminal

This terminal is used to connect the projector to the computer with a USB cable when you want to use the USB Display function.

8 <USB A (VIEWER/WIRELESS)> terminal

When using the Memory Viewer function, insert the USB memory directly to this terminal. (➔ page 82)

Please insert the wireless module (Model No.: ET-WML100) directly to this terminal when using the wireless LAN function. (➔ page 87)

9 <AUDIO IN 1> terminal

This is the terminal to input computer audio signals when Computer 1 input or Computer 2 input is selected.

In addition, if you have set [HDMI setup] → [Sound] to [Computer], it outputs the analog audio of the input signal which is input to <AUDIO IN 1> terminal when the HDMI input source is selected.

10 <AUDIO IN 2 (L/R)> terminal

This is the terminal to input audio signals when Video input, S-video input or Component input is selected. There are a left (L) terminal and a right (R) terminal.

11 <SERIAL IN> terminal

This is the RS-232C compatible terminal to externally control the projector by connecting a computer.

12 <MONITOR OUT> terminal

This is the terminal to output the RGB signals from <COMPUTER 1 IN> terminal or <COMPUTER 2 IN> terminal to external monitor.

This terminal will output the corresponding input signals when switching to Computer 1 or Computer 2 input.

Attention

- When a LAN cable is directly connected to the projector, the network connection must be made indoors.

For PT-LB305

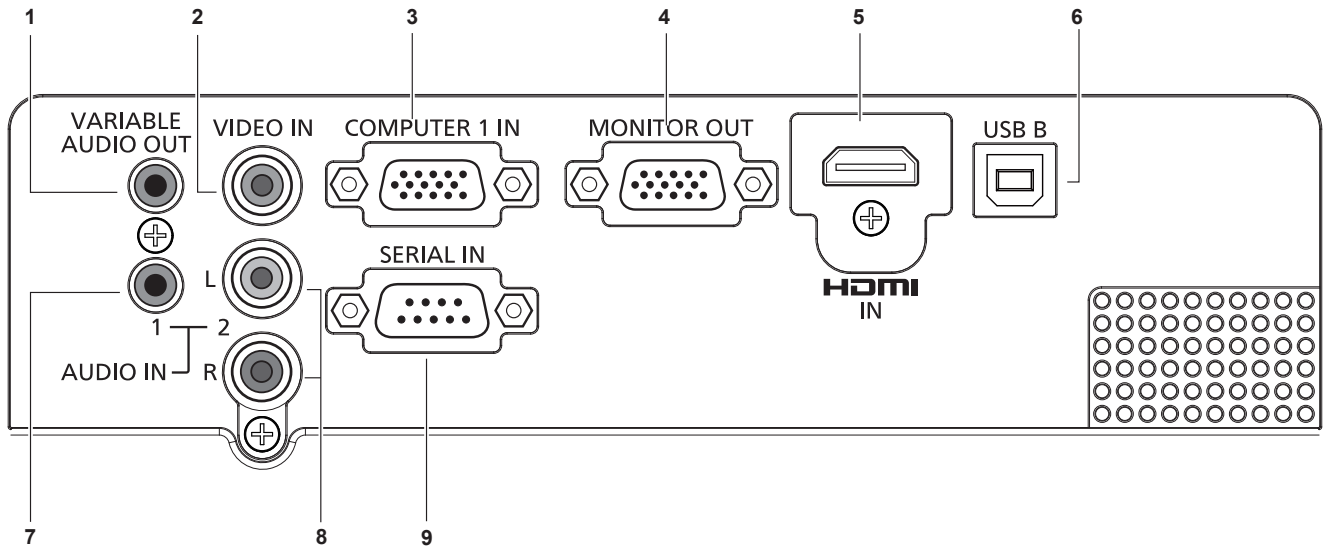

1 <VARIABLE AUDIO OUT> terminal

This is the terminal to output audio signal input to the projector.

2 <VIDEO IN> terminal

This is the terminal to input video signals.

3 <COMPUTER 1 IN> terminal

This is the terminal to input RGB, YP_BP_R/YC_BC_R or Y/C signals.

4 <MONITOR OUT> terminal

This is the terminal to output the RGB signals to external monitor.

5 <HDMI IN> terminal

This is the terminal to input HDMI signals.

6 <USB B> terminal

For service use.

7 <AUDIO IN 1> terminal

This is the terminal to input computer audio signals when the Computer input source is selected.

In addition, if you have set [HDMI setup] → [Sound] to [Computer], it outputs the analog audio of the input signal which is input to <AUDIO IN 1> terminal when the HDMI input source is selected.

8 <AUDIO IN 2 (L/R)> terminal

This is the terminal to input audio signals when Video input, S-video input or Component input is selected. There are a left (L) terminal and a right (R) terminal.

9 <SERIAL IN> terminal

This is the RS-232C compatible terminal to externally control the projector by connecting a computer.

Preparing the remote control

Inserting and Removing batteries

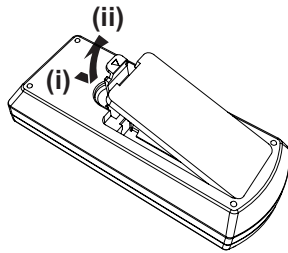

Fig. 1

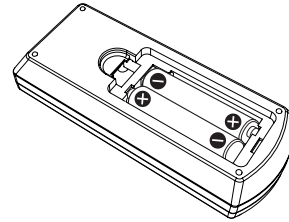

Fig. 2

- 1) Open the cover. (Fig. 1)
- 2) Insert batteries and close the cover (Insert the "⊖" side first.). (Fig. 2)
 - When removing the batteries, perform the steps in reverse order.

When using the multiple projectors

When you use the system with multiple projectors, you can operate all the projectors simultaneously or each projector individually using single remote control, if unique ID number is assigned to each projector.

When you want to set the ID number, at first you need to set the ID number of the projector, and then set the ID number on the remote control.

The factory default ID number of the unit (the projector and the remote control) is set to [ALL], you can control with this setting. If necessary, please set the ID number to the remote control and the projector.

About how to set the ID number of the remote control, please refer to "Setting the remote control ID numbers". (➔ page 49)

Note

- Set the ID number of the projector from the [Expand] menu → [Remote control]. (➔ page 76)

Chapter 2 **Getting Started**

This chapter describes things you need to do before using the projector such as the setup and connections.

Setting up

Installation mode

There are four ways to set up the projector. Set the [Display] menu → [Project way] (➔ page 56) depending on the installation location.

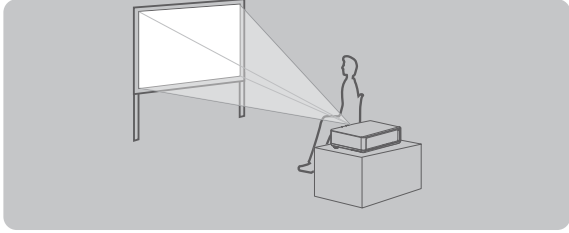
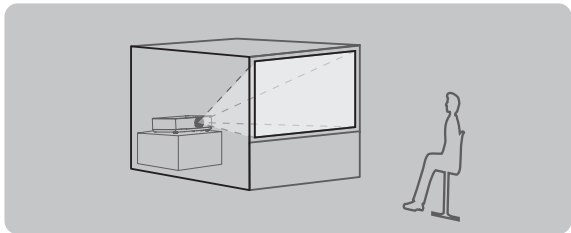
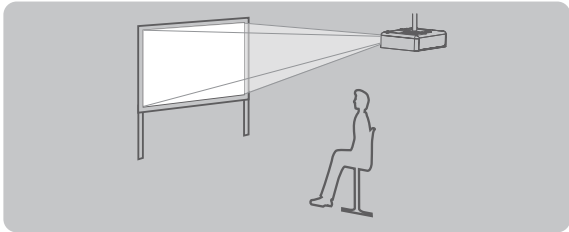
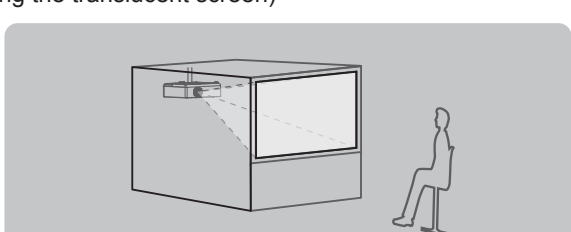
Setting on a desk/floor and projecting forward 		Setting on a desk/floor and projecting from rear (Using the translucent screen) 	
Menu item	Method	Menu item	Method
[Project way]	[Front]	[Project way]	[Rear]
Mounting on the ceiling and projecting forward 		Mounting on the ceiling and projecting from rear (Using the translucent screen) 	
Menu item	Method	Menu item	Method
[Project way]	[Ceiling/Front]	[Project way]	[Ceiling/Rear]

Parts for ceiling mount (Optional)

This requires an optional ceiling mount bracket. Be sure to use the Projector Mount Bracket together with the ceiling mount bracket for high ceilings or low ceilings.

Model No.: ET-PKL100H (for high ceilings), ET-PKL100S (for low ceilings), ET-PKL420B (Projector Mount Bracket)

- Use only the ceiling mount brackets specified for this projector.
- Refer to the Installation Instructions for the ceiling mount bracket when you install the bracket and the projector.

Attention

- To ensure projector performance and security, installation of the ceiling mount bracket must be carried out by your dealer or a qualified technician.

Screen size and throw distance

Refer to the screen size and projection distances to install the projector. Image size and image position can be adjusted in accordance with the screen size and screen position.

- Following illustration is prepared on the assumption that the projected image size and position have been aligned to fit full in the screen.

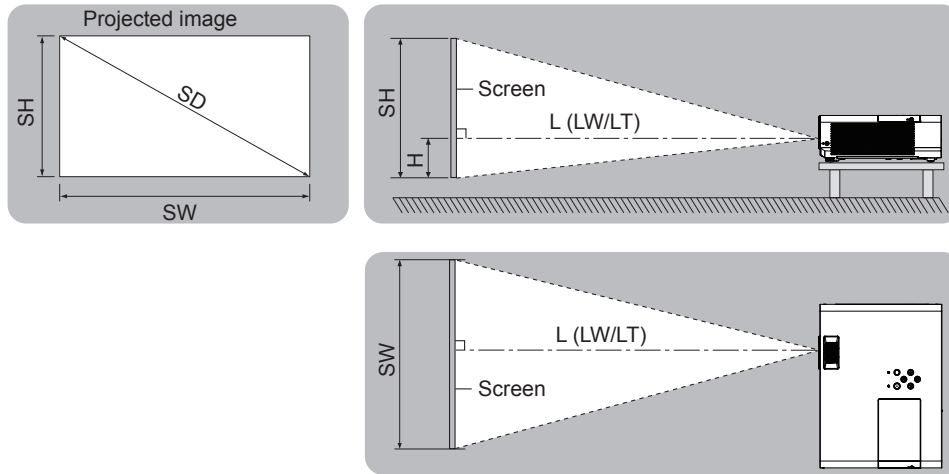

L (LW/LT) *1	Projection distance
SH	Image height
SW	Image width
H	Distance from the center of lens to the image lower end
SD	Projected image size

*1 LW : Minimum distance
LT : Maximum distance

Attention

- Before installing, please read "Precautions for use" (➔ page 16).

Projection distance

A ±5% error in listed projection distances may occur.

When [Keystone] is used, distance is corrected to become smaller than the specified image size.

For PT-LW375

(Unit: m)

Projection size Screen diagonal (SD)	16:10 aspect ratio			16:9 aspect ratio			4:3 aspect ratio		
	Minimum distance (LW)	Maximum distance (LT)	Height position (H)	Minimum distance (LW)	Maximum distance (LT)	Height position (H)	Minimum distance (LW)	Maximum distance (LT)	Height position (H)
0.76 (30")	0.9	1.1	0.027	1.0	1.2	0.008	1.1	1.3	0.065
1.02 (40")	1.3	1.5	0.036	1.3	1.6	0.011	1.4	1.7	0.087
1.27 (50")	1.6	1.9	0.046	1.6	2.0	0.014	1.8	2.2	0.109
1.52 (60")	1.9	2.3	0.055	2.0	2.4	0.017	2.2	2.6	0.131
1.78 (70")	2.2	2.7	0.063	2.3	2.8	0.019	2.5	3.0	0.152
2.03 (80")	2.6	3.1	0.072	2.6	3.2	0.022	2.9	3.5	0.174
2.29 (90")	2.9	3.5	0.082	3.0	3.6	0.025	3.3	3.9	0.196
2.54 (100")	3.2	3.8	0.091	3.3	4.0	0.028	3.6	4.4	0.218
3.05 (120")	3.8	4.6	0.109	4.0	4.8	0.033	4.4	5.2	0.261
3.81 (150")	4.8	5.8	0.137	4.9	5.9	0.041	5.4	6.6	0.327
5.08 (200")	6.4	7.7	0.181	6.6	7.9	0.054	7.3	8.7	0.435
6.35 (250")	8.0	9.7	0.227	8.3	9.9	0.068	9.1	10.9	0.544
7.62 (300")	9.6	11.6	0.272	9.9	11.9	0.082	10.9	13.1	0.653

Chapter 2 Getting Started - Setting up

For PT-LW335

(Unit: m)

Projection size	16:10 aspect ratio			16:9 aspect ratio			4:3 aspect ratio		
	Screen diagonal (SD)	Minimum distance (LW)	Maximum distance (LT)	Height position (H)	Minimum distance (LW)	Maximum distance (LT)	Height position (H)	Minimum distance (LW)	Maximum distance (LT)
0.76 (30")	0.9	1.1	0.027	1.0	1.2	0.008	1.1	1.3	0.065
1.02 (40")	1.3	1.5	0.036	1.3	1.6	0.011	1.4	1.7	0.087
1.27 (50")	1.6	1.9	0.046	1.6	2.0	0.014	1.8	2.2	0.109
1.52 (60")	1.9	2.3	0.055	2.0	2.4	0.017	2.2	2.6	0.131
1.78 (70")	2.2	2.7	0.063	2.3	2.8	0.019	2.5	3.0	0.152
2.03 (80")	2.5	3.1	0.072	2.6	3.1	0.022	2.9	3.5	0.174
2.29 (90")	2.9	3.4	0.082	3.0	3.5	0.025	3.3	3.9	0.196
2.54 (100")	3.2	3.8	0.091	3.3	3.9	0.028	3.6	4.3	0.218
3.05 (120")	3.8	4.6	0.109	3.9	4.7	0.033	4.3	5.2	0.261
3.81 (150")	4.8	5.8	0.137	4.9	5.9	0.041	5.4	6.5	0.327
5.08 (200")	6.4	7.7	0.181	6.6	7.9	0.054	7.3	8.7	0.435
6.35 (250")	8.0	9.6	0.227	8.2	9.9	0.068	9.1	10.9	0.544
7.62 (300")	9.6	11.6	0.272	9.9	11.9	0.082	10.9	13.1	0.653

For PT-LB425, PT-LB385, PT-LB355 and PT-LB305

(Unit: m)

Projection size	4:3 aspect ratio			16:9 aspect ratio		
	Screen diagonal (SD)	Minimum distance (LW)	Maximum distance (LT)	Height position (H)	Minimum distance (LW)	Maximum distance (LT)
0.76 (30")	0.9	1.1	0.065	1.0	1.2	0.008
1.02 (40")	1.2	1.4	0.087	1.3	1.6	0.011
1.27 (50")	1.5	1.8	0.109	1.6	2.0	0.014
1.52 (60")	1.8	2.2	0.131	2.0	2.4	0.017
1.78 (70")	2.1	2.5	0.152	2.3	2.8	0.019
2.03 (80")	2.4	2.9	0.174	2.6	3.2	0.022
2.29 (90")	2.7	3.3	0.196	3.0	3.6	0.025
2.54 (100")	3.0	3.6	0.218	3.3	4.0	0.028
3.05 (120")	3.6	4.4	0.261	4.0	4.8	0.033
3.81 (150")	4.5	5.5	0.327	4.9	5.9	0.041
5.08 (200")	6.1	7.3	0.435	6.6	7.9	0.054
6.35 (250")	7.6	9.1	0.544	8.3	9.9	0.068
7.62 (300")	9.1	10.9	0.653	9.9	11.9	0.082

Projection distance formulas

To use a screen size not listed in this manual, check the screen size SD (m) and use the respective formula to calculate projection distance.

The unit of all the formulae is m. (Values obtained by the following calculation formulae contain a slight error.)

If you want to calculate the projection distance with projected image size SD (unit: inch) by substituting, please assign 0.0254 times to the SD value.

For PT-LW375

	16:10 aspect ratio	16:9 aspect ratio	4:3 aspect ratio
Screen height (SH)	= $0.530 \times SD$	= $0.490 \times SD$	= $0.6 \times SD$
Screen width (SW)	= $0.848 \times SD$	= $0.872 \times SD$	= $0.8 \times SD$
Minimum distance (LW)	= $1.2692 \times SD - 0.025$	= $1.3045 \times SD - 0.025$	= $1.4369 \times SD - 0.025$
Maximum distance (LT)	= $1.5249 \times SD - 0.025$	= $1.5673 \times SD - 0.025$	= $1.7263 \times SD - 0.025$

For PT-LW335

	16:10 aspect ratio	16:9 aspect ratio	4:3 aspect ratio
Screen height (SH)	= $0.530 \times SD$	= $0.490 \times SD$	= $0.6 \times SD$
Screen width (SW)	= $0.848 \times SD$	= $0.872 \times SD$	= $0.8 \times SD$
Minimum distance (LW)	= $1.2660 \times SD - 0.02327$	= $1.3008 \times SD - 0.02327$	= $1.4332 \times SD - 0.02327$
Maximum distance (LT)	= $1.5195 \times SD - 0.02367$	= $1.5615 \times SD - 0.02367$	= $1.7202 \times SD - 0.02367$

For PT-LB425, PT-LB385, PT-LB355 and PT-LB305

	4:3 aspect ratio	16:9 aspect ratio
Screen height (SH)	= $0.6 \times SD$	= $0.490 \times SD$
Screen width (SW)	= $0.8 \times SD$	= $0.872 \times SD$
Minimum distance (LW)	= $1.1974 \times SD - 0.025$	= $1.3045 \times SD - 0.025$
Maximum distance (LT)	= $1.4386 \times SD - 0.025$	= $1.5673 \times SD - 0.025$

Connecting

Before connecting

- Before connecting, carefully read the operating instructions for the external device to be connected.
- Turn off the power switch of the devices before connecting cables.
- Take note of the following points before connecting the cables. Failure to do so may result in malfunctions.
 - When connecting a cable to a device connected to the projector or the projector itself, touch any nearby metallic objects to eliminate static electricity from your body before performing work.
 - Do not use unnecessarily long cables to connect to a device connected to the projector or to the projector body. The longer the cable, the more it is susceptible to noise. Since using a cable while it is wound makes it act like an antenna, it is more susceptible to noise.
 - When connecting cables, connect GND first, then insert the connecting terminal of the connecting device in a straight manner.
- If any connection cable is not supplied with the device, or if no optional cable is available for connection of the device, prepare a necessary system connection cable to suit the device.
- Video signals containing too much jitter may cause the images on the screen to randomly wobble or wafture. In this case, a time base corrector (TBC) must be connected.
- The projector accepts Video signals, Y/C signals and $Y C_B C_R / Y P_B P_R$ signals and analog RGB signals (synchronous signals are TTL level), and digital signal.
- Some computer models or graphics cards are not compatible with the projector.
- When using long cables to connect with each of equipment to the projector, there is a possibility that the image will not be output correctly unless a compensator is used.
- For details on what video signals the projector supports, see "List of compatible signals". (➔ page 110)

<COMPUTER 1 IN> terminal pin assignments and signal names

Outside view	Pin No.	Signal names	Pin No.	Signal names
	①	R/P _R /C	⑨	+5 V
	②	G/Y/Y	⑩	GND
	③	B/P _B	⑪	GND
	④	—	⑫	DDC data
	⑤	GND	⑬	HD/SYNC
	⑥	GND	⑭	VD
	⑦	GND	⑮	DDC clock
	⑧	GND		

<COMPUTER 2 IN> terminal pin assignments and signal names

(Only for PT-LW375, PT-LW335, PT-LB425, PT-LB385 and PT-LB355)

Outside view	Pin No.	Signal names	Pin No.	Signal names
	①	R	⑨	+5 V
	②	G	⑩	GND
	③	B	⑪	—
	④	—	⑫	DDC data
	⑤	GND	⑬	HD/SYNC
	⑥	GND	⑭	VD
	⑦	GND	⑮	DDC clock
	⑧	GND		

<MONITOR OUT> terminal pin assignments and signal names

Outside view	Pin No.	Signal names	Pin No.	Signal names
	①	R	⑨	—
	②	G	⑩	GND
	③	B	⑪	—
	④	—	⑫	—
	⑤	GND	⑬	HD/SYNC
	⑥	GND	⑭	VD
	⑦	GND	⑮	—
	⑧	GND		

<HDMI IN> terminal pin assignments and signal names

Outside view	Pin No.	Signal names	Pin No.	Signal names
<p>Even-numbered pins ② to ⑱</p> <p>Odd-numbered pins ① to ⑰</p>	①	T.M.D.S data 2+	⑪	T.M.D.S clock shield
	②	T.M.D.S data 2 shield	⑫	T.M.D.S clock -
	③	T.M.D.S data 2-	⑬	CEC
	④	T.M.D.S data 1+	⑭	—
	⑤	T.M.D.S data 1 shield	⑮	SCL
	⑥	T.M.D.S data 1-	⑯	SDA
	⑦	T.M.D.S data 0+	⑰	DDC/CEC GND
	⑧	T.M.D.S data 0 shield	⑱	+5 V
	⑨	T.M.D.S data 0-		Hot plug detection
	⑩	T.M.D.S clock +		

Connecting example : AV equipment

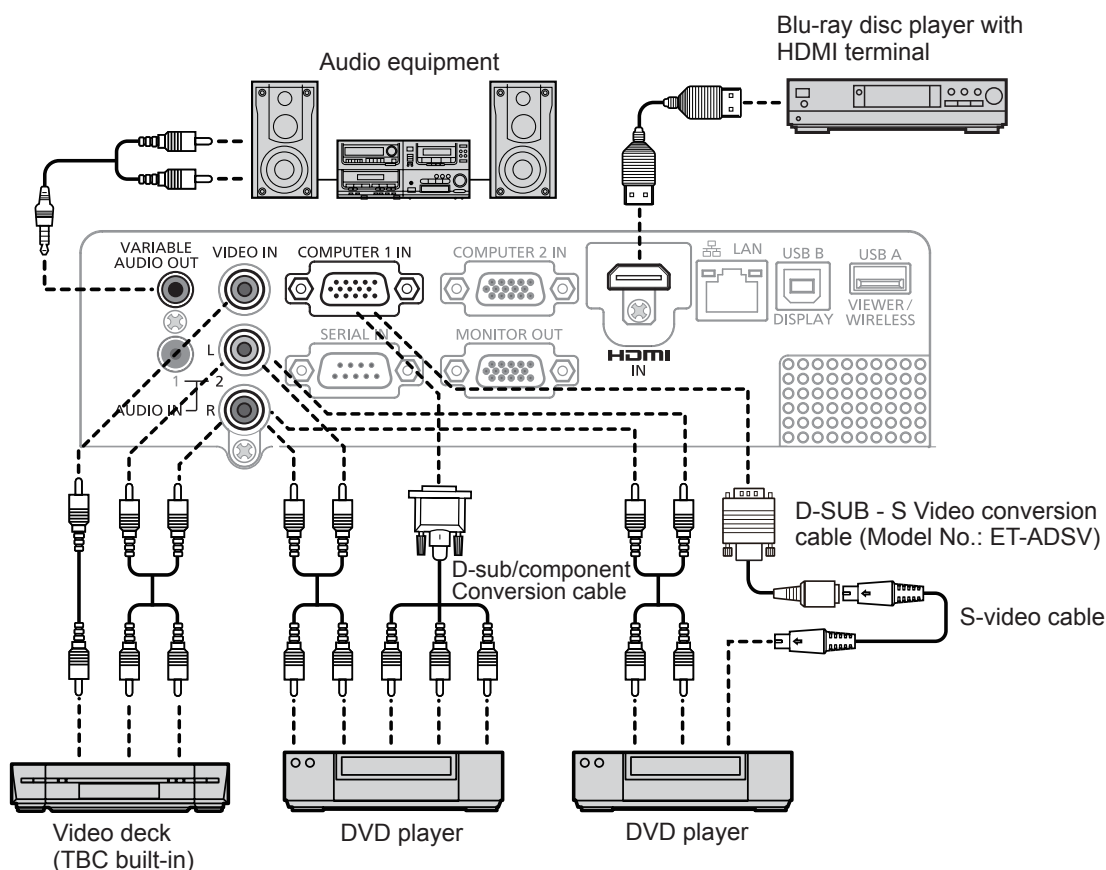

Attention

- Always use one of the following when connecting a VCR.
 - A VCR with built-in time base corrector (TBC).
 - A time base corrector (TBC) between the projector and the VCR.
- If nonstandard burst signals are connected, the image may be distorted. In such case, connect the time base corrector (TBC) between the projector and the external devices.

Note

- For an HDMI cable, use an HDMI High Speed cable that conforms to HDMI standards. If a cable that does not conform to HDMI standards is used, images may be interrupted or may not be projected.
- This projector does not support the VIERA link (HDMI).
- When the <VARIABLE AUDIO OUT> terminal is connected with cable, the sound will not be output from the built-in speaker.
- When input Y/C signal, the optional D-SUB - S Video Conversion cable (Model No.: ET-ADSV) is required.

Connecting example : Computers

■ For PT-LW375, PT-LW335, PT-LB425, PT-LB385 and PT-LB355

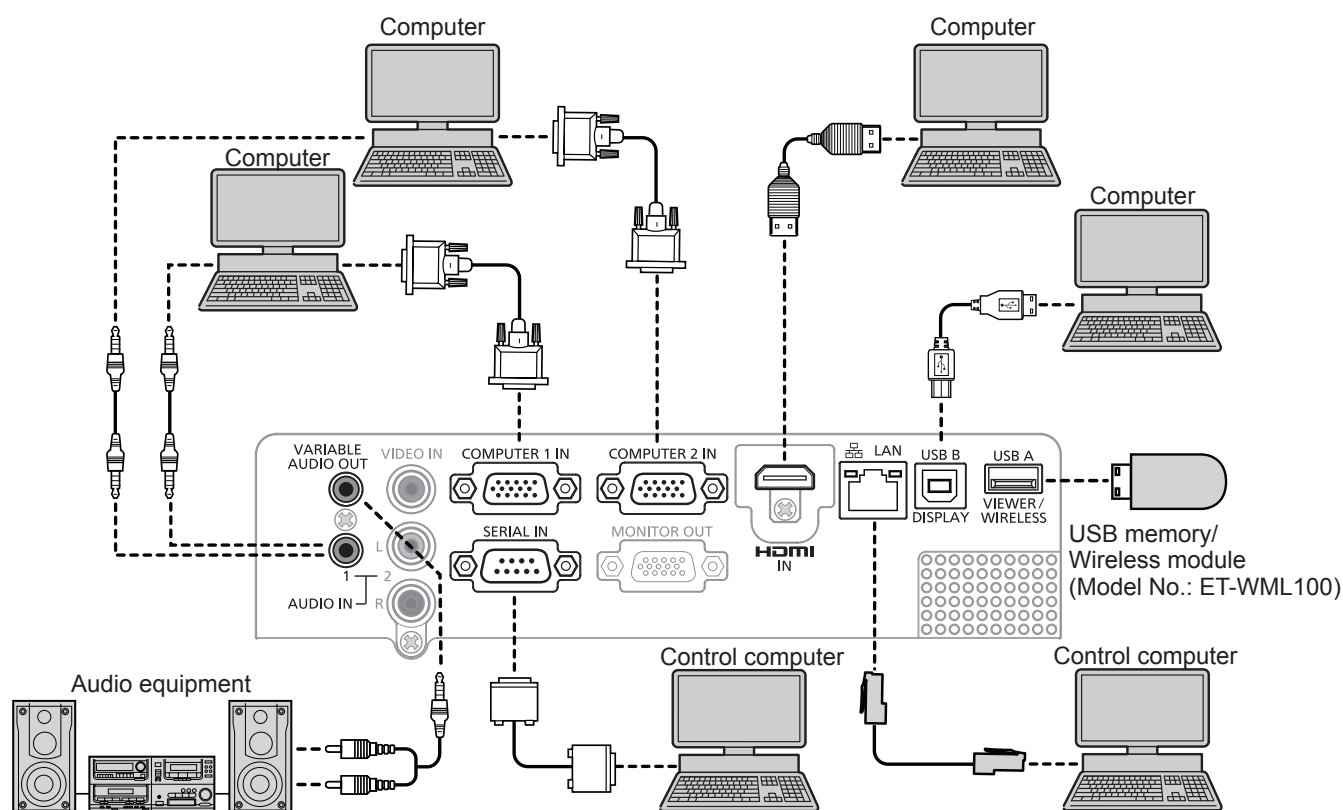

■ For PT-LB305

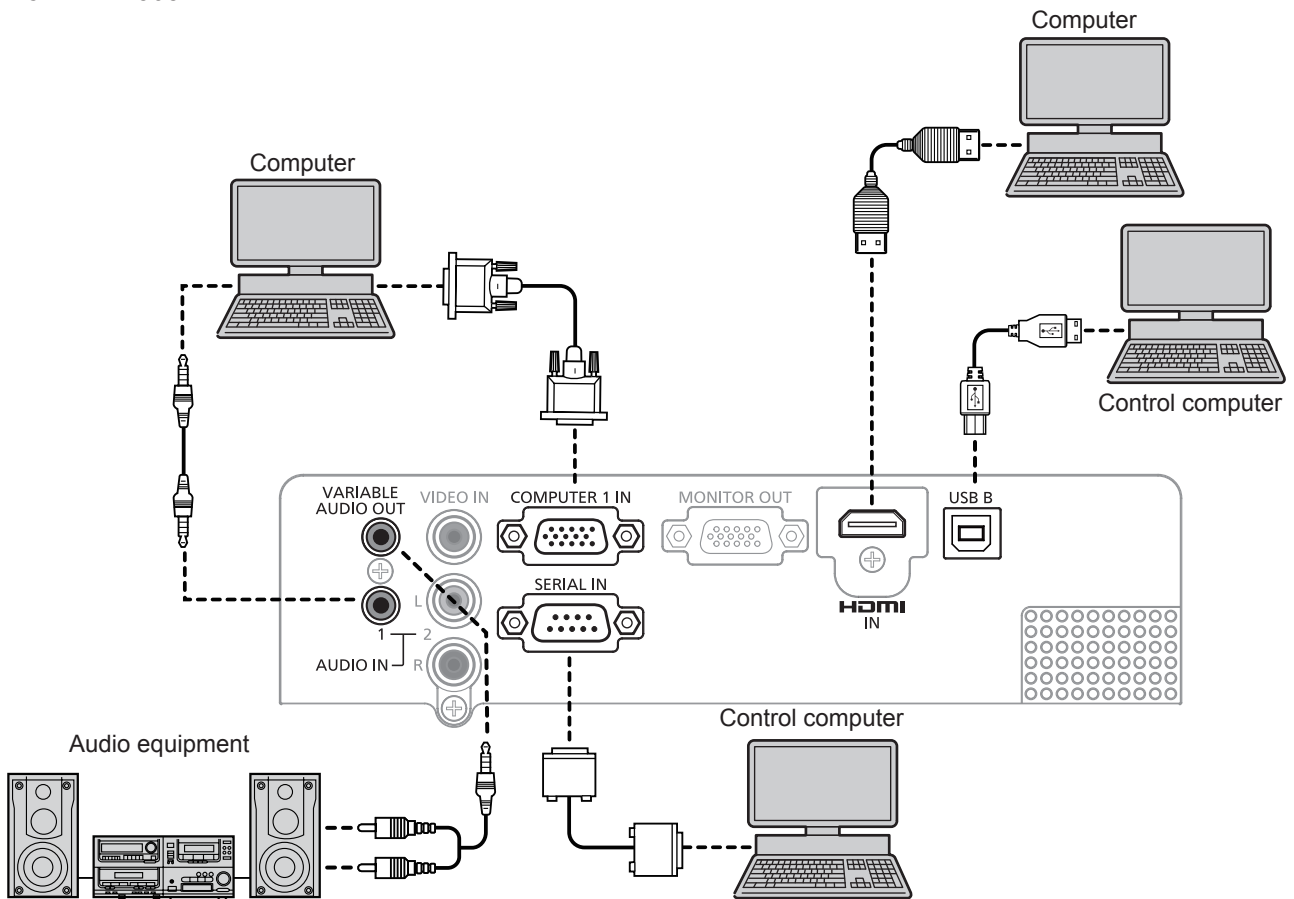

Attention

- When connecting the projector to a computer or an external device, use the power cord supplied with each device and commercially available shielded cables.

Note

- For an HDMI cable, use an HDMI High Speed cable that conforms to HDMI standards. If a cable that does not conform to HDMI standards is used, images may be interrupted or may not be projected.
- If you operate the projector using the computer with the resume feature (last memory), you may have to reset the resume feature to operate the projector.
- When the <VARIABLE AUDIO OUT> terminal is connected with cable, the sound will not be output from the built-in speaker.
- Attach the optional wireless module (Model No.: ET-WML100) or USB memory directly to the <USB A (VIEWER/WIRELESS)> terminal of this projector without using a USB extension cable or USB hub.
- If the video signal from the DVI-D terminal of the external device (such as a computer) is connected to the <HDMI IN> terminal by using a conversion cable, you need to set the [Setting] menu → [HDMI setup] → [Sound] to [Computer] (◆ page 64) and input the audio signal to the <AUDIO IN 1> terminal.

Chapter 3 **Basic Operations**

This chapter describes basic operations to start with.

Powering on/off

Connecting the power cord

Make sure that the supplied power cord is securely fixed to the <AC IN> terminal of the projector body to prevent it from being removed easily.

For details of power cord handling, refer to “Read this first!” (➔ page 4).

Attaching

- 1) Check the shapes of the <AC IN> terminal on the back of the projector body and the power cord connector and insert the connector completely in the correct direction.

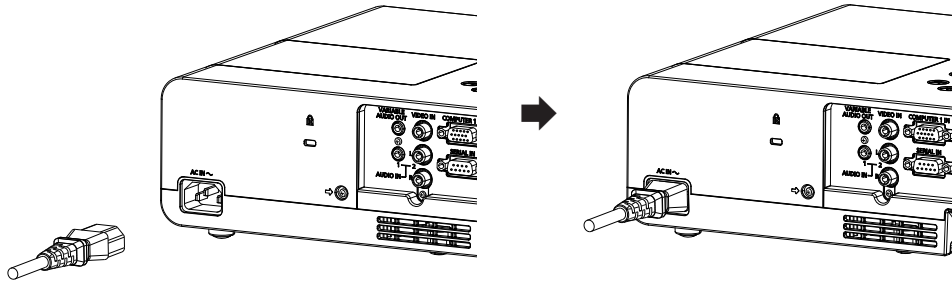

Removing

- 1) Confirm that the projector is in standby mode, and remove the power plug from the outlet.
- 2) Remove the power cord connector from the <AC IN> terminal.

Power indicator

The power indicator <ON(G)/STANDBY(R)> informs you the status of the power. Confirm the status of the power indicator <ON(G)/STANDBY(R)> before operating the projector.

Power indicator <ON(G)/STANDBY(R)>

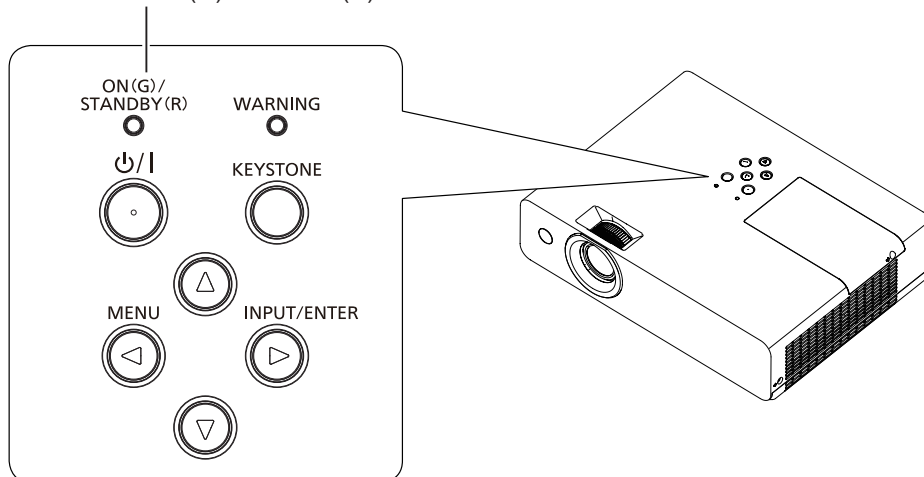

Indicator status		Status
No illumination		The power plug is not connected to the outlet.
Red	Lighting	The projector is turned off. (In standby mode)
	Blinking	The projector is preparing to project. The projector will project image after a while. The projector is preparing to be switched off. The power is switched off after a while. (Changes to the standby mode.)
Green	Lighting	Projecting.
	Blinking	The luminous lamp is turned off. The [Expand] menu → [Power management] is set to [Ready].
Orange	Lighting	Internal malfunction is detected. For details, refer to “Power/Warning Indicators”. (➔ page 97)
	Blinking	

Powering On the Projector

Before switching on the projector, make sure all the other devices are correctly connected. (➔ page 34)

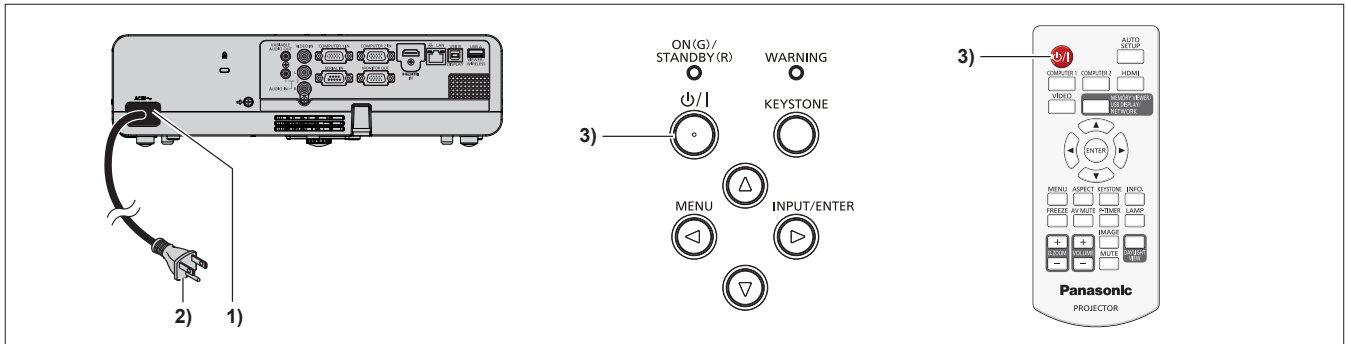

- 1) **Connect the power cord to the projector body.**
- 2) **Connect the power plug to an outlet.**
 - The power indicator <ON(G)/STANDBY(R)> lights in red, and the projector will enter the standby mode.
- 3) **Press the power <⏻/|> button.**
 - The power indicator <ON(G)/STANDBY(R)> lights in green and the image is soon projected on the screen.

Making adjustments and selections

It is recommended that images are projected continuously for at least 30 minutes before the focus is adjusted.

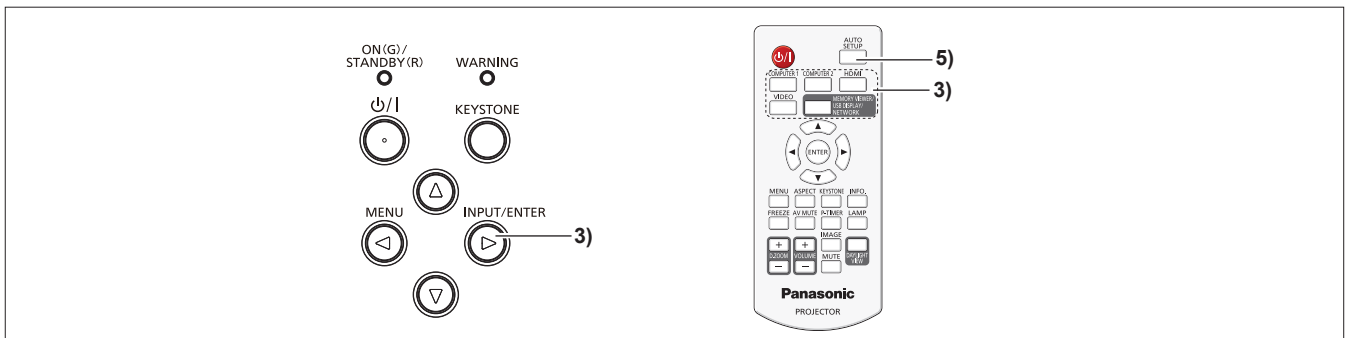

- 1) **Roughly adjust the focus of the image with the focus ring. (➔ page 43)**
- 2) **Change the settings of the [Display] menu → [Project way] depending on the installation mode. (➔ page 56)**
 - Refer to “Navigating through the menu” (➔ page 51) for the operation of the menu screen.
- 3) **Press the <INPUT/ENTER> button on the control panel or the input selection (<COMPUTER 1>, <COMPUTER 2>, <HDMI>, <VIDEO>, <MEMORY VIEWER/USB DISPLAY/NETWORK>) buttons on the remote control to select the input signal.**
 - The <COMPUTER 2> button is only for PT-LW375, PT-LW335, PT-LB425, PT-LB385 and PT-LB355, it is disabled for PT-LB305.
 - The <MEMORY VIEWER/USB DISPLAY/NETWORK> button is only for PT-LW375, PT-LW335, PT-LB425, PT-LB385 and PT-LB355. The <MEMORY VIEWER/USB DISPLAY> button is for PT-LB305 and it is disabled.
- 4) **Adjust the projection angle of the projector with the adjustable foot. (➔ page 44)**
- 5) **If the input signal is an analog RGB signal, press the <AUTO SETUP> button.**
- 6) **Adjust the size of the image to match the screen with the zoom ring.**
- 7) **Adjust the focus with the focus ring again.**
- 8) **Adjust the size of the image to match the screen with the zoom ring again.**

Powering Off the Projector

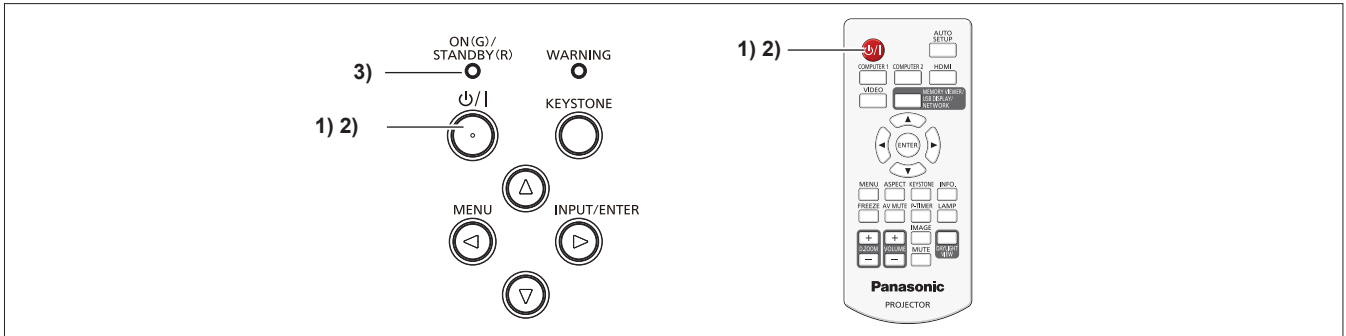

- 1) **Press the power <⏻/> button.**
 - The power-off confirmation screen is displayed.
- 2) **Press the power <⏻/> button again.**
 - Projection of the image will stop, and the power indicator <ON(G)/STANDBY(R)> blinks in red. (The fan keeps running.)
- 3) **Wait until the power indicator <ON(G)/STANDBY(R)> lights in red.**
 - The projector enters standby mode when the power indicator <ON(G)/STANDBY(R)> lights in red.
- 4) **Disconnect the plug of the power cord from the outlet.**

Note

- While the power indicator <ON(G)/STANDBY(R)> is blinking in red, the lamp is being cooled down and the projector cannot be turned on. Wait until the power indicator <ON(G)/STANDBY(R)> lights in red to turn on the projector again.
- When packing the projector for transportation and storage, please make sure that the power indicator is off.
- Even if the power is turned off by pressing the power <⏻/> button, the projector consumes power if the power plug is connected to the outlet.
When the [Setting] menu → [Standby mode] is set to [Eco], use of some functions is restricted, but the power consumption during standby mode can be conserved.

Projecting

Check the connections of the peripheral devices (➔ page 34) and connection of the power cord (➔ page 39) and switch on the power (➔ page 40) to start the projector. Select the image and adjust the state of the image.

Selecting the input signal

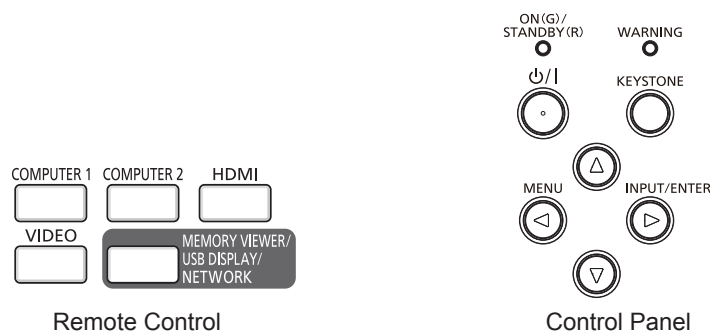

The input for projection can be switched. Method to switch the input is as follows.

- Press the input selection buttons on the remote control and directly specify the input to project.
- Press the <INPUT/ENTER> button on the control panel to display the input selection screen and select the input to project from the list.

When using the remote control

The input for projection can be switched directly by pressing the input selection button on the remote control.

1) Press the input selection (<COMPUTER 1>, <COMPUTER 2>, <HDMI>, <VIDEO>, <MEMORY VIEWER/USB DISPLAY/NETWORK>) buttons.

- The <COMPUTER 2> button is only for PT-LW375, PT-LW335, PT-LB425, PT-LB385 and PT-LB355, it is disabled for PT-LB305.
- The <MEMORY VIEWER/USB DISPLAY/NETWORK> button is only for PT-LW375, PT-LW335, PT-LB425, PT-LB385 and PT-LB355. The <MEMORY VIEWER/USB DISPLAY> button is for PT-LB305 and it is disabled.

<COMPUTER 1>	Switches to Computer 1 input or Component input. Switches to the other input when one input has already been selected. The image of the signal input to the <COMPUTER 1 IN> terminal is projected.
<COMPUTER 2>	Switches to Computer 2 input. The image of the signal input to the <COMPUTER 2 IN> terminal is projected.
<HDMI>	Switches to HDMI input. The image of the signal input to the <HDMI IN> terminal is projected.
<VIDEO>	Switches to Video input or S-video input. Switches to the other input when one input has already been selected. The image of the signal input to the <VIDEO IN> terminal is projected when Video input is selected. The image of the Y/C signal input to the <COMPUTER 1 IN> terminal is projected when S-video input is selected.
<MEMORY VIEWER/USB DISPLAY/NETWORK>	Switches to Memory Viewer input, USB Display input or Network input. If one of the inputs has been selected, the input will switch each time you press the button.

Attention

- Images may not be projected properly depending on the connected device and DVD, video tape, etc. to be played. Select a system format that is suitable for the input signal in [Display] menu → [System] (➔ page 57).
- Check the aspect ratio of the screen and the image and select the optimum aspect ratio under the [Display] menu → [Aspect] (➔ page 56).

Note

- If the Memory Viewer input is selected, the still image stored in the USB memory can be projected using the Memory Viewer function. For details, please refer to “About Memory Viewer function” (➔ page 82).
- If the projector has been connected to a computer with a USB converting cable and the USB Display input is selected, the computer screen and audio can be output using the USB display function. For details, please refer to “USB Display function” (➔ page 84).
- If Network input is selected, the image from a computer (including iPad / iPhone / iPod touch and Android device) can be transferred via wireless LAN/wired LAN to the projector by using the Panasonic image transfer application software. For details about the image transfer application software “Presenter Light” and “Wireless Projector”, refer to the Panasonic website (<https://panasonic.net/cns/projector/>).

When using the control panel

The input for projection can be selected by displaying the input screen with the control panel.

1) Press the <INPUT/ENTER> button.

- The Input screen is displayed.

For PT-LW375, PT-LW335, PT-LB425,
PT-LB385 and PT-LB355

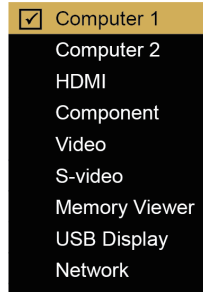

For PT-LB305



2) Press ▲▼ to select one item and then press the <ENTER> button.

- The selected input signal will be projected.

How to adjust the state of the image

If the projected image or the position is not correct when the positioning of the projector and the screen is correctly installed, adjust the focus, projection angle and zoom.

1) Adjust the projection angle.

- Place the projector on a level surface so that the projected image does not tilt to the left or right.
- If the projected image is located below the screen, extend the adjustable foot to adjust the position of projected image. For details, see “Adjusting adjustable foot” (➔ page 44).
- Adjust from the [Expand] menu → [Keystone] (➔ page 66) when the projected image is distorted.

2) Adjust the zoom and the focus.

- Rotate the zoom ring to adjust the projected image size to fit the screen.
- Rotate the focus ring to adjust the focus of the projected image.

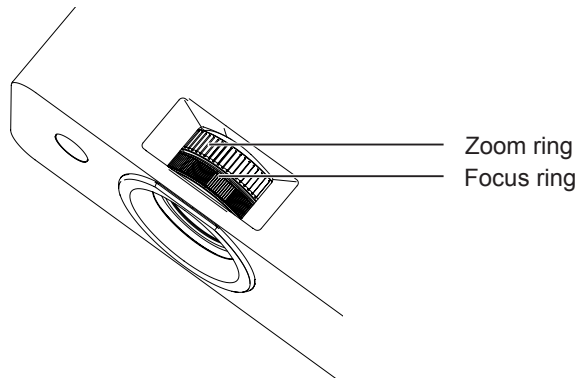

Note

- It is recommended that the images are projected continuously for at least 30 minutes before the focus is adjusted.
- When the focus is adjusted, the projection screen size also changes slightly. Depending on the image projection situation, repeat Steps 1) and 2) to adjust to the best projection condition.

Adjusting adjustable foot

By pressing the adjustable foot lock with your finger, the adjustable foot lock is released and becomes free. It will be locked when you release the finger. Lift the front side of the projector while pressing the adjustable foot lock with your finger, and release your finger until the projection position is aligned.

For slight adjustment, rotate the adjustable foot.

Rotate the adjustable foot to extend it as shown in the figure, and rotate it in the opposite direction to contract it.

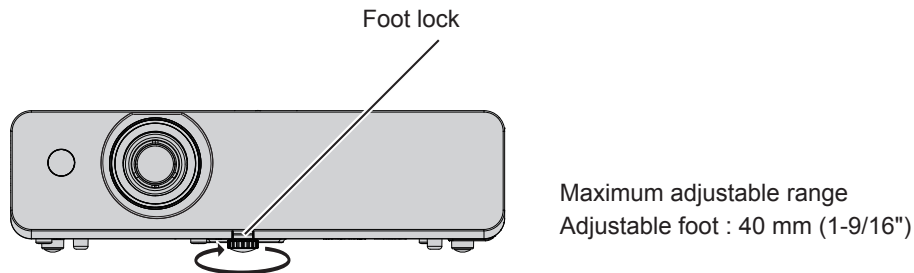

Attention

- Heated air comes out of the air exhaust port while the lamp is lit. Do not touch the air exhaust port directly when you adjust the adjustable foot.
- Adjust from the [Expand] menu → [Keystone] (➔ page 66) when the projected image is distorted.

Basic operations by using the remote control

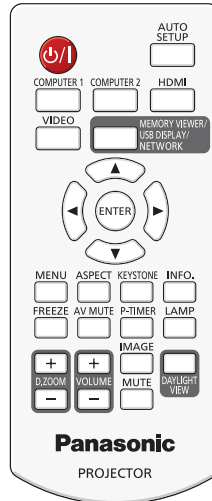

Performing automatic setup

The Input search function, Auto PC adjustment function and Auto Keystone correction function can be performed simultaneously.

Input search is a function to automatically detect the input signal and switch the input.

The Auto PC adjustment function can be used to automatically adjust the clock phase, image position (horizontal / vertical) and dot clock when the still image analog RGB signal is input. (Analog RGB signal is a signal structured with dots just like the computer signal.)

The Auto Keystone correction function automatically corrects vertical trapezoidal distortion.

It is recommended to input an image with bright white borders at the edges and high-contrast black and white characters when the Auto PC adjustment function is being performed. Avoid using images that include halftones or gradation, such as photographs and computer graphics.



1) Press the <AUTO SETUP> button on the remote control.

Note

- For settings of the functions to be performed during automatic setup execution, refer to the [Expand] menu → [Auto setup] (➔ page 65).
- It may not be correctly adjusted even when the Auto PC adjustment function is performed. In such a case, adjust the following settings.
 - For clock phase: [Display] menu → [Fine sync] (➔ page 55)
 - For horizontal image position: [Display] menu → [H Position] (➔ page 55)
 - For vertical image position: [Display] menu → [V Position] (➔ page 56)
 - For dot clock: [Display] menu → [H.Size] (➔ page 56)
- If trapezoidal distortion remains, you can make adjustment by using the screen adjustment function. For details, refer to "Using the screen adjustment function" (➔ page 46).
You can also adjust it by using [Expand] menu → [Keystone] (➔ page 66).
- It may not be adjusted correctly depending on the computer model and the input signal.
- Images may be disrupted for a few seconds during automatic adjustment or automatic correction, but it is not a malfunction.
- If you press any button on the remote control during execution of automatic setup, automatic setup will be canceled.
- Even for signals compatible with Auto PC adj. function, the Auto PC adjustment may not work properly when the automatic setup is performed with moving picture input.

Switching the aspect ratio of the image

You can switch aspect ratios of the image.



1) Press the <ASPECT> button on the remote control.

Note

- For more details, refer to the [Display] menu → [Aspect] (➔ page 56).

Using the screen adjustment function

You can correct the trapezoidal distortion and the curved distortion of the projected image.

KEYSTONE



button

For PT-LW375, PT-LW335, PT-LB425, PT-LB385 and PT-LB355

1) Press the <KEYSTONE> button on the remote control.

- The selection screen of screen adjustment function is displayed.
- You can also press the <KEYSTONE> button on the control panel.

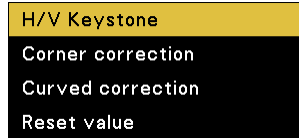

[H/V Keystone]	Select when the trapezoid of the projected image is distorted.
[Corner correction]	Select when the four corners of the projected image are distorted.
[Curved correction]	Select when the linearity is not uniform or the projected image is curved distortion.
[Reset value]	Return all adjusted values of the screen adjustment function to the factory default values.

2) Press ▲▼ to select [H/V Keystone], [Corner correction], or [Curved correction].

3) Press the <ENTER> button.

- The individual adjustment screen of the selected item is displayed.

4) Press ▲▼◀▶ to adjust.

For PT-LB305

1) Press the <KEYSTONE> button on the remote control.

- The [V Keystone] screen is displayed.



2) Press ▲▼ to adjust.

- When the [V Keystone] screen is displayed press the <KEYSTONE> button again, the corrected value will be canceled.

Note

- For more details, refer to the [Expand] menu → [Keystone] (➡ page 66).
- Press the <KEYSTONE> button on the control panel or on the remote control when the [H/V Keystone], [Corner correction] or [Curved correction] individual adjustment screen is displaying, the individual adjustment screen will switch as follows.
 - [H/V Keystone] ⇒ [Corner correction] (Upper left) ⇒ [Corner correction] (Upper right) ⇒ [Corner correction] (Lower right) ⇒ [Corner correction] (Lower left) ⇒ [Curved correction X/Y Gain] ⇒ [Curved correction X Offset] ⇒ [Curved correction Y Offset] ⇒ [H/V Keystone] ⇒ ...

Using the status function

Display the status of the projector.

INFO.



button

1) Press the <INFO.> button on the remote control.

- The [Info.] screen is displayed.

2) Press the <INFO.> button again.

- The [Info.] screen disappears.

Note

- For more details, refer to the [Info.] menu (➡ page 80).

Using the freeze function

You can freeze the projected image and stop the sound temporarily, regardless of the playing condition of the external device.

FREEZE

 button

1) **Press the <FREEZE> button on the remote control.**

- The video is paused and the audio is muted. The icon  is displayed on the screen during Freeze.

2) **Press the <FREEZE> button again.**

- The video playback resumes and the audio is unmuted.

Using the AV mute function

If the projector is not used for a certain period of time during the meeting intermission, for example, it is possible to turn off the audio and image temporarily.

AV MUTE

 button

1) **Press the <AV MUTE> button on the remote control.**

- The audio and image turn off.

2) **Press the <AV MUTE> button again.**

- The audio and image turn on.

Using the presentation timer function

You can operate the P-timer function.

Presentations, etc. can be performed while checking the elapsed time.

P-TIMER

 button

1) **Press the <P-TIMER> button on the remote control.**

- The count is started.
- The elapsed time is displayed at the bottom right of the projected image.

2) **Press the <P-TIMER> button again.**

- The count is stopped.

3) **Press the <P-TIMER> button again.**

- P-timer is finished.

Switching the brightness of the light source

This function allows you to switch the brightness of the light source.

LAMP

 button

1) **Press the <LAMP> button on the remote control.**

- It will switch each time you press the button, [ (Normal)] → [ (Eco)] → [ (Quiet)] → [ (Normal)] →....

Note

- For details, please refer to the [Setting] menu → [Lamp control] (➔ page 61).

Using the digital zoom function

(Only for still image-based signals input)

You can enlarge the center of the projected image. You can also change the location of the area to be enlarged.



buttons

1) Press the <D.ZOOM +> or <D.ZOOM -> button on the remote control.

- The [D. zoom] individual adjustment screen is displayed.
- Press ▲▼◀▶ on the remote control to move the display position after enlargement.

Operation	Adjustment	Adjustment range
Press the <D.ZOOM +> button.	Increases magnification.	0 ~ 33
Press the <D.ZOOM -> button.	Decreases magnification.	
Press the ▲▼ buttons after enlargement.	Moves the area to the top or the bottom.	-
Press the ◀▶ buttons after enlargement.	Moves the area to the left or the right.	

Note

- When the input signals change during digital zoom, the enlargement display of the digital zoom will be cancelled.

Controlling the volume of the speaker

You can adjust the volume of the audio output from the build-in speaker or the <VARIABLE AUDIO OUT> terminal.



buttons

1) Press the <VOLUME +> or <VOLUME -> button on the remote control.

<VOLUME +>	Increases the volume.
<VOLUME ->	Decreases the volume.

Switching the image mode

This function allows you to switch the image mode.

IMAGE



button

1) Press the <IMAGE> button on the remote control.

- It will switch each time you press the button, [Dynamic] → [Standard] → [Cinema] → [Blackboard(Green)] → [Colorboard] → [User image] → [Dynamic] →....

Note

- For details, please refer to the [Color adjust] menu → [Image mode] (➔ page 58).

Using the mute function

The audio from the built-in speaker or <VARIABLE AUDIO OUT> terminal will be turned off temporarily.

MUTE



button

1) Press the <MUTE> button on the remote control.

- The audio turns off.

2) Press the <MUTE> button again.

- The audio turns on.

Using the Daylight View Lite function

The Daylight View Lite function improves the vividness of the image even if it is projected under a bright light.



1) Press the <DAYLIGHT VIEW> button on the remote control.

- The Daylight View Lite function will be switched enable/disable each time you press the button.

Note

- For details, please refer to the [Color adjust] menu → [Daylight View] (➔ page 60).

Setting the remote control ID numbers

When you use the system with multiple projectors, you can operate all the projectors simultaneously or each projector individually by using single remote control, if unique ID number is assigned to each projector.

After setting the ID number of the projector, set the same ID number to the remote control.

There are seven different ID codes (ALL, Code 1~Code 6), the initial ID number is [ALL].



1) The ID numbers of the projector are set by pressing the <IMAGE> button one time to six times while holding down the <MENU> button.

- The number of times you press the <IMAGE> button corresponds to the desired ID code number. The number of times to press the <IMAGE> button is as follows:
Code 1= Once, Code 2= Twice, Code 3= 3 times, Code 4= 4 times, Code 5= 5 times, Code 6= 6 times.
- The ID code is changed when the <MENU> button is released.

Attention

- The ID number set on the remote control will be stored unless it is set again. However, it will be erased if the remote control is left with dead batteries. Set the same ID number again when the batteries are replaced.

Note

- Set the ID number of the projector from the [Expand] menu → [Remote control]. (➔ page 76)
- The ID code is reset to [ALL] (default) by pressing the <MENU> button and <IMAGE> button at the same time for five seconds or more.
- If the <IMAGE> button is pressed seven times or more, the operation is invalid, the ID code cannot be changed.

Chapter 4 Settings

This chapter describes the settings and adjustments you can make using the on-screen menu.

Menu Navigation

The on-screen menu (Menu) is used to perform various settings and adjustments of the projector.

Navigating through the menu

Operating procedure



- 1) Press the <MENU> button on the remote control or the control panel.
 - The main menu screen appears.

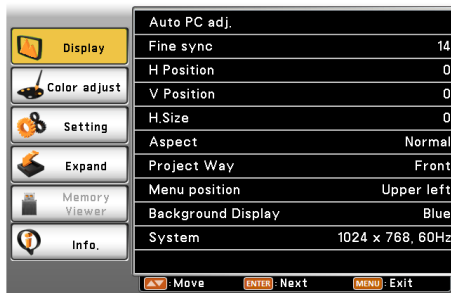

- 2) Press ▲▼ to select an item from the main menu.
 - The selected item is highlighted in orange.



- 3) Press the <ENTER> button.
 - The submenu is displayed, and submenu items become selectable.

(there is no lower menu under the submenu)

(there is lower menu under the submenu)

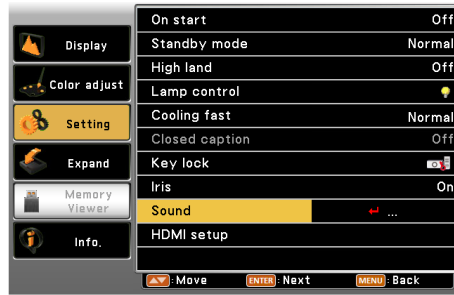
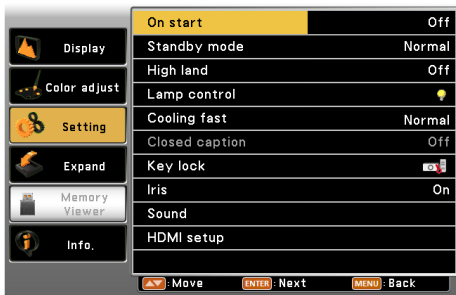

- Please perform step 4).
- If there is lower menu under the submenu, ◀ ... will be displayed. (except for [System] in [Display] menu)
- Please perform step 7).

- 4) Press ▲▼ to select a sub-menu item, press the <ENTER> button.
 - If the selected submenu can be set or adjusted, ⇅ will be displayed.

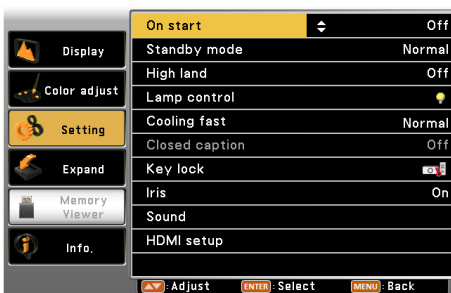

5) Press ▲▼ to switch or adjust settings.

- Some items will switch in order as follows each time you press ▲▼.

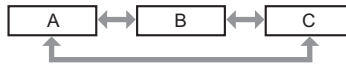

6) Press the <ENTER> button or the <MENU> button.

- The changed settings or the adjusted value is confirmed.

7) Press ▲▼ to select a sub-menu item, press the <ENTER> button.

- Switches to the next layer of the menu screen.

8) Press the <ENTER> button.

- If the selected item can be set or adjusted, ▲▼ will be displayed.

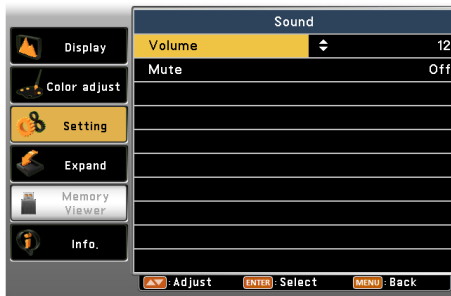

9) Press ▲▼ to switch or adjust settings.

- Some items will switch in order as follows each time you press ▲▼.

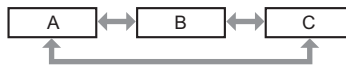

- The selected item will be displayed in a check mark.

10) Press the <ENTER> button or the <MENU> button.

- The changed settings or the adjusted value is confirmed.







Note

- Pressing the <MENU> button while the menu screen is displayed returns to the previous menu or exits the menu screen.
- Some items may not be adjusted or used for certain signal formats to be input to the projector. The menu items that cannot be adjusted or used are shown in gray characters, and they cannot be selected.
- Some items can be adjusted even if signals are not input.
- For menu items, refer to “Main menu” (➔ page 52) and “Sub-menu” (➔ page 53).

Main menu

The following items are in the main menu.

When a main menu item is selected, the screen changes to a submenu selection screen.

Main menu item		Page
	[Display]	55
	[Color adjust]	58
	[Setting]	61
	[Expand]	65
	[Memory Viewer]	78
	[Info.]	80

Sub-menu

The sub-menu screen of the selected main menu appears, and you can set and adjust the various items in the submenu.

[Display]

Sub-menu item	Factory default	Page
[Auto PC adj.] ^{*1}	-	55
[Fine sync] ^{*1}	-	55
[H Position] ^{*1}	-	55
[V Position] ^{*1}	-	56
[H.Size] ^{*1}	-	56
[Aspect]	[Normal]	56
[Project way]	[Front]	56
[Menu position]	[Upper left]	57
[Background display]	[Blue]	57
[System]	-	57

*1 Only for still image signals.

[Color adjust]

Sub-menu item	Factory default	Page
[Image mode]	[Standard]	58
[Contrast]	[32]	58
[Brightness]	[32]	58
[Color] ^{*1}	[32]	59
[Tint] ^{*1}	[32]	59
[Color temp.] ^{*2}	[Mid]	59
[Red]	[32]	59
[Green]	[32]	59
[Blue]	[32]	59
[Sharpness]	[8]	60
[Daylight View]	[Off]	60



*1 Only for video, Y/C and YC_BC_R/YP_BP_R signals

*2 Only for analog RGB signals and HDMI signals

Note

- The factory default settings may vary depending on the image mode.

[Setting]

Sub-menu item	Factory default	Page
[On start]	[Off]	61
[Standby mode]	[Eco]	61
[High land]	[Off]	61
[Lamp control]	[ (Normal)]	61
[Cooling fast]	[Normal]	62
[Closed caption]	[Off]	62
[Key lock]	[ (Off)]	62
[Iris]	[On]	63
[Sound]	-	63
[HDMI Setup]	-	63

[Expand] 

Sub-menu item	Factory default	Page
[Language]	[English]	65
[Auto setup]	-	65
[Keystone]	[Store]	66
[Logo]	-	70
[Security]	-	72
[Power management]	[Shut down]	73
[Filter counter]	-	74
[Test pattern]	[Off]	75
[Network]	-	75
[Remote control]	[ALL]	76
[Factory default]	-	77

[Memory Viewer]*1 

Sub-menu item	Factory default	Page
[Set slide]	-	78
[Slide transition effect]	[Slide right]	78
[Sort order]	[Name order]	78
[Rotate]	[No rotate]	78
[Best fit]	[Off]	78
[Repeat]	[Off]	79
[Apply]	-	79

*1 Only for PT-LW375, PT-LW335, PT-LB425, PT-LB385 and PT-LB355.

[Info.] 

Details (➔ page 80)

Note

- Some items may not be adjusted or used for certain signal formats to be input to the projector.
The menu items that cannot be adjusted or used are shown in gray characters, and they cannot be selected.
- Sub-menu items and factory default settings differ depending on the selected input.

[Display] menu

On the menu screen, select [Display] from the main menu, and select an item from the sub-menu. Refer to “Navigating through the menu” (➔ page 51) for the operation of the menu screen.

[Auto PC adj.]

(Only for still image signals input)

When the still image analog RGB signal is input, the image may flicker or shift up, down, left or right. In such a case, press the <AUTO SETUP> button to automatically adjust [Fine sync], [H Position], [V Position] and [H.Size] to an optimal state. Perform this function to achieve an optimal state that matches the image.

- 1) Press ▲▼ to select [Auto PC adj.].
- 2) Press the <ENTER> button.
 - [Please wait] screen is displayed, the Auto PC adj. function will be executed.

Note

- The projector executes the Auto PC adj. automatically when detecting image signals that are input to the projector for the first time.
- Automatic adjustment may not work depending on the model of the computer and the input signal.
- The [Auto PC adj.] cannot be operated when 720 x 480i, 720 x 576i, 720 x 480p, 720 x 576p, 1280 x 720p, 1920 x 1080i or 1920 x 1080p is displayed in the [Display] menu → [System], or when the digital signal is input.

[Fine sync]

(Only for still image signals input)

You can adjust the clock phase to achieve an optimal image when there is a flickering image or smeared outlines.

- 1) Press ▲▼ to select [Fine sync].
- 2) Press the <ENTER> button.
- 3) Press ▲▼ to adjust the level.
 - The adjustment values are 0 to +31. Adjust so that the amount of interference is at a minimum.

Note

- Certain signals may not be adjustable.
- Optimal value may not be achieved if the output from the input computer is unstable.
- To project a signal with dot clock frequency with 162 MHz or higher, noise may not disappear even if [Fine sync] is adjusted.
- [Fine sync] cannot be adjusted when a digital signal is input.

[H Position]

(Only for still image signals input)

Adjust the image position if the image projected on the screen is shifted left or right even when the positions of the projector and screen are correct.

- 1) Press ▲▼ to select [H Position].
- 2) Press the <ENTER> button.
- 3) Press ▲▼ to adjust the horizontal image position.

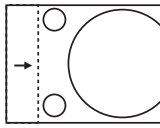
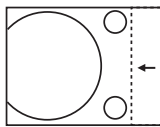
Orientation	Operation	Adjustment
Horizontal (left and right) adjustment.	Press the ▲ button.	The image position moves to the right. 
	Press the ▼ button.	The image position moves to the left. 

Note

- [H Position] is not available while the image is expanded in the digital zoom function.

[V Position]

(Only for still image signals input)

Adjust the image position if the image projected on the screen is shifted up or down even when the positions of the projector and screen are correct.

- 1) Press ▲▼ to select [V Position].
- 2) Press the <ENTER> button.
- 3) Press ▲▼ to adjust the vertical image position.

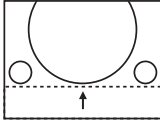
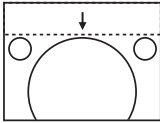
Orientation	Operation	Adjustment
Vertical (up and down) adjustment.	Press the ▲ button.	The image position moves up. 
	Press the ▼ button.	The image position moves down. 

Note

- [V Position] is not available while the image is expanded in the digital zoom function.

[H.Size]

(Only for still image signals input)

Use this function to adjust the dot clock and minimize the effect of interference caused by projection of patterns consisting of vertical stripes.

The projection of the vertical striped pattern may cause cyclic patterns (noise). Adjust so that the amount of interference is at a minimum.

- 1) Press ▲▼ to select [H.Size].
- 2) Press the <ENTER> button.
- 3) Press ▲▼ to adjust the level.
 - The adjustment values are -15 to +15.

Attention

- Set it before adjusting [Fine sync].

[Aspect]

You can switch the aspect ratio of the image.

- 1) Press ▲▼ to select [Aspect].
- 2) Press the <ENTER> button.
- 3) Press ▲▼ to switch the item.
 - The items will switch each time you press the button.

[Normal]	Projects the image at the maximum size while maintaining the aspect ratio of the input signal.
[Wide]	Projects the image at 16:9 aspect ratio.

Note

- When the Memory Viewer, the USB Display or the Network input is selected, [Aspect] cannot be selected.

[Project way]

Set the projection method in accordance with the installation status of the projector.

Change the projection method if the screen display is upside down or inverted.

- 1) Press ▲▼ to select [Project way].
- 2) Press the <ENTER> button.
- 3) Press ▲▼ to switch the item.
 - The items will switch each time you press the button.

[Front]	When installing the projector on the desk, etc. in front of the screen.
[Rear]	When installing the projector on the desk, etc. behind the screen (with a translucent screen).
[Ceiling/Front]	When installing the projector in front of the screen by using the Ceiling Mount Bracket for Projectors (optional).
[Ceiling/Rear]	When installing the projector behind the screen (with a translucent screen) by using the Ceiling Mount Bracket for Projectors (optional).

[Menu position]

Set the position of the menu screen (OSD).

- 1) Press ▲▼ to select [Menu position].
- 2) Press the <ENTER> button.
- 3) Press ▲▼ to change the menu position.
 - The items will switch each time you press the button.
[Upper left] → [Upper right] → [Center] → [Lower left] → [Lower right] → [Upper left] →...

[Background display]

Select the background screen when no input signal is detected.

- 1) Press ▲▼ to select [Background display].
- 2) Press the <ENTER> button.
- 3) Press ▲▼ to switch the item.
 - The items will switch each time you press the button.

[Blue]	Displays the entire projection area in blue.
[Black]	Displays the entire projection area in black.

[System]

The projector can automatically detect the input signal, but you can set the system format manually when an unstable signal is input.

- 1) Press ▲▼ to select [System].
- 2) Press the <ENTER> button.
 - The [System] screen is displayed.
- 3) Press ▲▼ to select the desired system.
 - The items will switch each time you press the button.

Input source	Mode	Description
for RGB signal	[1024 x 768, 60Hz], etc	The name of the automatically identified input signal is displayed and the system format for that signal is applied. Adjust the system format manually if the image is not adjusted correctly.
	[Auto]	If the input signal cannot be identified, [Auto] is displayed and the Auto PC adj. function is executed to achieve an optimum image. Adjust the system format manually if the image is not adjusted correctly.
for Video and Y/C signal	[Auto]	Normally, select [Auto]. It automatically identifies the signal as a TV format among [NTSC], [NTSC4.43], [PAL], [PAL-N], [SECAM] and [PAL60]. If a PAL-M type signal is input, select [PAL-M] manually.
	[PAL] / [SECAM] / [NTSC] / [NTSC4.43] / [PAL-M] / [PAL-N] / [PAL60]	If the image is not adjusted correctly even when [Auto] is selected, set the TV signal type manually.

- 4) Press the <ENTER> button.

[Color adjust] menu

On the menu screen, select [Color adjust] from the main menu, and select an item from the sub-menu. Refer to "Navigating through the menu" (➔ page 51) for the operation of the menu screen.

[Image mode]

You can switch to the desired picture mode suitable for the image source and the environment in which the projector is used.

- 1) Press ▲▼ to select [Image mode].
- 2) Press the <ENTER> button.
- 3) Press ▲▼ to switch the item.
 - The items will switch each time you press the button.

[Dynamic]	The light output is maximized for use in bright areas.
[Standard]	The picture becomes suitable for moving images in general.
[Cinema]	The picture becomes suitable for movie sources.
[Blackboard (Green)]	The picture becomes suitable for projecting on a black board (green board) such as classroom.
[Colorboard]	The picture becomes suitable for projecting on a color board. To select [Colorboard], press the <ENTER> button, the [Colorboard] screen is displayed. To select [Red], [Blue], [Green] or [Yellow], and press the <ENTER> button.
[User image]	Select this item if manual adjustment of the image is needed. If [User image] is selected, [Contrast], [Brightness], [Color], [Tint], [Color temp.], [Red], [Green], [Blue] or [Sharpness] can be adjusted manually. The adjusted values will be saved as the setting values of [User image].

- 4) Press the <ENTER> button.

Note

- Under an image mode other than [User image], if the items such as [Contrast] and [Brightness] are adjusted, [Image mode] will automatically switch to [User image] and the adjusted values will be saved as the setting values of [User image]. Note that the original setting values will be discarded if [User image] is selected.

[Contrast]

You can adjust the contrast of the colors.

- 1) Press ▲▼ to select [Contrast].
- 2) Press the <ENTER> button.
- 3) Press ▲▼ to adjust the level.

Operation	Adjustment	Adjustment range
Press the ▲ button.	Brightens the screen and makes the color deeper.	0 ~ +63
Press the ▼ button.	Darkens the screen and makes the color lighter.	

Attention

- Adjust [Brightness] first when you need to adjust [Brightness] and [Contrast].

[Brightness]

You can adjust the dark (black) part of the projected image.

- 1) Press ▲▼ to select [Brightness].
- 2) Press the <ENTER> button.
- 3) Press ▲▼ to adjust the level.

Operation	Adjustment	Adjustment range
Press the ▲ button.	Increases the brightness of the dark (black) parts of the screen.	0 ~ +63
Press the ▼ button.	Reduces the brightness of the dark (black) parts of the screen.	

[Color]

(Only for Video signals, Y/C signals and YC_BC_R/YP_BP_R signals)
You can adjust the color saturation of the projected image.

- 1) Press ▲▼ to select [Color].
- 2) Press the <ENTER> button.
- 3) Press ▲▼ to adjust the level.

Operation	Adjustment	Adjustment range
Press the ▲ button.	Deepens colors.	0 ~ +63
Press the ▼ button.	Weakens colors.	

[Tint]

(Only for YC_BC_R/YP_BP_R signals and NTSC/NTSC4.43/PAL60 signals of Video or Y/C format)
You can adjust the skin tone in the projected image.

- 1) Press ▲▼ to select [Tint].
- 2) Press the <ENTER> button.
- 3) Press ▲▼ to adjust the level.

Operation	Adjustment	Adjustment range
Press the ▲ button.	Adjusts skin tone toward greenish color.	0 ~ +63
Press the ▼ button.	Adjusts skin tone toward reddish purple.	

[Color temp.]

(Only for analog RGB signals and HDMI signals)
You can switch the color temperature if the white areas of the projected image are bluish or reddish.

- 1) Press ▲▼ to select [Color temp.].
- 2) Press the <ENTER> button.
- 3) Press ▲▼ to switch the item.
 - The items will switch each time you press the button.

[High]	Becomes a bluish image at [High]. Becomes a reddish image at [Low]. Selects the suitable natural color.
[Mid]	
[Low]	

[Red] / [Green] / [Blue]

You can adjust the white balance.

- 1) Press ▲▼ to select [Red] / [Green] / [Blue].
- 2) Press the <ENTER> button.
- 3) Press ▲▼ to adjust the level.

Menu	Operation	Adjustment	Adjustment range
[Red]	Press the ▲ button.	Deepen red tone.	0 ~ +63
	Press the ▼ button.	Lighten red tone.	
[Green]	Press the ▲ button.	Deepen green tone.	0 ~ +63
	Press the ▼ button.	Lighten green tone.	
[Blue]	Press the ▲ button.	Deepen blue tone.	0 ~ +63
	Press the ▼ button.	Lighten blue tone.	

[Sharpness]

You can adjust the sharpness of the projected image.

- 1) Press ▲▼ to select [Sharpness].
- 2) Press the <ENTER> button.
- 3) Press ▲▼ to adjust the level.

Operation	Adjustment	Adjustment range
Press the ▲ button.	Contours become sharper.	0 ~ +15
Press the ▼ button.	Contours become softer.	

[Daylight View]

The Daylight View Lite function improves the vividness of the image even if it is projected under a bright light.

- 1) Press ▲▼ to select [Daylight View].
- 2) Press the <ENTER> button.
- 3) Press ▲▼ to switch the item.
 - The items will switch each time you press the button.
 - You can also press the <DAYLIGHT VIEW> button on the remote control. (➡ page 49)

[On]	Corrects the vividness of the image.
[Off]	No correction.

Note

- [Daylight View] can be set under all image modes of [Dynamic], [Standard], [Cinema], [Blackboard (Green)], [Colorboard] and [User image].

[Setting] menu

On the menu screen, select [Setting] from the main menu, and select an item from the sub-menu. Refer to "Navigating through the menu" (➔ page 51) for the operation of the menu screen.

[On start]

Set the startup method which will be applied when the projector is powered on after connecting the power plug to outlet.

- 1) Press ▲▼ to select [On start].
- 2) Press the <ENTER> button.
- 3) Press ▲▼ to switch the item.
 - The items will switch each time you press the button.

[Off]	Starts up in the standby mode.
[On]	Starts the projection immediately.

[Standby mode]

Set the standby power consumption. Change the setting whether or not use the network function.

- 1) Press ▲▼ to select [Standby mode].
- 2) Press the <ENTER> button.
- 3) Press ▲▼ to switch the item.
 - The items will switch each time you press the button.

[Eco]	Select this item to reduce power consumption during standby.
[Normal] ^{*1}	Select this item to use the network function or the serial communication function during standby.

*1 For PT-LB305, network function is unavailable.

Note

- If [Standby mode] is set to [Eco], you cannot use network functions and some RS-232C commands.

[High land]

Change the setting according to the altitude in which you use the projector.

- 1) Press ▲▼ to select [High land].
- 2) Press the <ENTER> button.
- 3) Press ▲▼ to switch the item.
 - The items will switch each time you press the button.

[Off]	When using the projector in the elevation of below 700 m (2 297').
[On 1]	When using the projector in the elevation of above 700 m (2 297') and below 1 400 m (4 593').
[On 2]	When using the projector in the elevation of above 1 400 m (4 593') and below 2 700 m (8 858').

Note

- It is set to [Off] when using the projector in the elevation of below 700 m (2 297'). It is set to [On 1] when using the projector in the elevation of above 700 m (2 297') and below 1 400 m (4 593'). It is set to [On 2] when using the projector in the elevation of above 1 400 m (4 593') and below 2 700 m (8 858'). Failure to do so may shorten the life of the internal parts and result in malfunctions.
- Do not set the projector in the elevation of 2 700 m (8 858') or above, otherwise it may shorten the life of the internal parts and result in malfunctions.
- When it is set to [On 1] or [On 2], the fan noise becomes louder and fan speed increases.







[Lamp control]

Switch the brightness of the lamp according to the operating environment of the projector or the purpose.





- 1) Press ▲▼ to select [Lamp control].
- 2) Press the <ENTER> button.

3) Press ▲▼ to switch the item.

- The items will switch each time you press the button.
- You can also press the <LAMP> button on the remote control. (➡ page 47)

[ (Normal)]	Select this item when high luminance is required.
[ (Eco)]	Select this item for lower luminance than that in [ (Normal)] mode, and for extending the life of the luminous lamp.
[ (Quiet)]	Select this item for lower luminance than that in [ (Eco)] mode, and for lower noise. The expected life of the luminous lamp in this mode is shorter than that in [ (Eco)] mode and equivalent to that in [ (Normal)] mode.

Note

- Set it to [ (Quiet)] rather than [ (Eco)], set it to [ (Eco)] rather than [ (Normal)], when you want to reduce power consumption and operation noise.

[Cooling fast]

Switch the cooling fan's speed when the power is turned off and shorten the cooling time of the cooling fan.

1) Press ▲▼ to select [Cooling fast].

2) Press the <ENTER> button.

3) Press ▲▼ to switch the item.

- The items will switch each time you press the button.

[Normal]	Use this setting normally.
[60 Sec]	Use this setting when short cooling period of time is required.
[0 Sec]	The cooling fans stop immediately after power-off.

Note

- When it is set to [0 Sec], you cannot restart the projector immediately after the power-off. The lamp remains high temperature and needs to be cooled, so it sometimes takes longer time than usual for the lamp to light up again.
- When it is set to [60 Sec], the cooling fans' speed is faster and the motor noise is louder than [Normal] setting after the power-off.

[Closed caption]

(Only for NTSC input)

Set the closed caption.

1) Press ▲▼ to select [Closed caption].

2) Press the <ENTER> button.

3) Press ▲▼ to switch the item.

- The items will switch each time you press the button.

[Off]	Closed caption is not displayed.
[CC1]	Displays CC1 data.
[CC2]	Displays CC2 data.
[CC3]	Displays CC3 data.
[CC4]	Displays CC4 data.

Note



- Closed caption is a function that displays text information of video signals mainly used in North America. Captions may not be displayed depending on the connected devices or contents being played back.
- [Closed caption] can only be selected if an NTSC signal is input.
- If [Closed caption] is set to the item except for [Off], the brightness of image may be changed according to the external devices or the used content of the closed caption corresponding connection.
- Closed captions are not displayed when the menu screen is displayed.

[Key lock]

Enable/disable the button operations on the control panel and the remote control.

1) Press ▲▼ to select [Key lock].

- 2) Press the <ENTER> button.
- 3) Press ▲▼ to switch the item.
 - The items will switch each time you press the button.

[ (Off)]	Enables the button operations on the control panel or the remote control.
[ (Projector)]	Disables the button operations on the control panel.
[ (Remote control)]	Disables the button operations on the remote control.

[Iris]

Aperture correction and signal compensation are performed automatically based on the image to result in an image of optimum contrast.

- 1) Press ▲▼ to select [Iris].
- 2) Press the <ENTER> button.
- 3) Press ▲▼ to switch the item.
 - The items will switch each time you press the button.

[On]	Corrects the aperture.
[Off]	No aperture correction.

[Sound]

You can perform more detailed setting for Audio.

Adjusting the volume

- 1) Press ▲▼ to select [Sound].
- 2) Press the <ENTER> button.
 - The [Sound] screen is displayed.
- 3) Press ▲▼ to select [Volume].
- 4) Press the <ENTER> button.
- 5) Press ▲▼ to adjust the level.
 - You can also press the <VOLUME +/-> button on the remote control. (➔ page 48)

Operation	Adjustment	Range
Press the ▲ button.	Turns up the volume.	0 ~ +25
Press the ▼ button.	Turns down the volume.	

Setting the mute

- 1) Press ▲▼ to select [Sound].
- 2) Press the <ENTER> button.
 - The [Sound] screen is displayed.
- 3) Press ▲▼ to select [Mute].
- 4) Press the <ENTER> button.
- 5) Press ▲▼ to switch the item.
 - The items will switch each time you press the button.
 - You can also press the <MUTE> button on the remote control. (➔ page 48)

[On]	Audio is not output.
[Off]	Audio is output.

[HDMI Setup]

Switch the setting when the external equipment is connected to the <HDMI IN> terminal of the projector and the image is not projected correctly. Or switch the setting of the audio input.

[Image]

- 1) Press ▲▼ to select [HDMI Setup].
- 2) Press the <ENTER> button.
 - The [HDMI Setup] screen is displayed.
- 3) Press ▲▼ to select [Image].
- 4) Press the <ENTER> button.
- 5) Press ▲▼ to switch the item.
 - The items will switch each time you press the button.

[Auto]	Set the signal level automatically.
[64-940]	Select when the HDMI terminal of an external device (such as a blu-ray player) is connected to the <HDMI IN> terminal.
[0-1023]	Select when the DVI-D terminal output of an external device (such as a computer) is connected to the <HDMI IN> terminal via a conversion cable or similar cable. Select also when the HDMI terminal output of a computer or other device is connected to the <HDMI IN> terminal.

Note

- The optimal setting varies depending on the output setting of the connected external device. Refer to the operation instruction of the external device regarding the output of the external device.

[Sound]

- 1) Press ▲▼ to select [HDMI setup].
- 2) Press the <ENTER> button.
 - The [HDMI setup] screen is displayed.
- 3) Press ▲▼ to select [Sound].
- 4) Press the <ENTER> button.
- 5) Press ▲▼ to switch the item.
 - The items will switch each time you press the button.

[HDMI]	When HDMI input is selected, the sound of HDMI will be output.
[Computer]	When HDMI input is selected, the sound which is input to the <AUDIO IN 1> terminal will be output.

[Expand] menu

On the menu screen, select [Expand] from the main menu, and select an item from the sub-menu. Refer to “Navigating through the menu” (➔ page 51) for the operation of the menu screen.

[Language]

You can switch the language of the on-screen display.

- 1) Press ▲▼ to select [Language].
- 2) Press the <ENTER> button.
 - The [Language] screen is displayed. (It is displayed in 23 languages with three pages.)
- 3) Press ▲▼ to switch the language.
 - The languages will switch each time you press the button.



- 4) Press the <ENTER> button.
 - Various menus, settings, adjustment screens, control button names, etc., are displayed in the selected language.
 - The language can be changed to English, German, French, Italian, Spanish, Portuguese, Dutch, Swedish, Finnish, Norwegian, Danish, Polish, Hungarian, Czech, Russian, Turkish, Arabic, Kazakh, Vietnamese, Chinese, Korean, Japanese and Thai.

Note

- The on-screen display language of the projector is set to English by default and when [Expand] → [Factory default] is executed (➔ page 77).

[Auto setup]

Set whether to use the <AUTO SETUP> button on the remote control for automatically performing the Input search function, Auto PC adj. function and Auto keystone function.

- 1) Press ▲▼ to select [Auto setup].
- 2) Press the <ENTER> button.
 - The [Auto setup] screen is displayed.
- 3) Press ▲▼ to switch the item.
 - The items will switch each time you press the button.

[Input search]	This function is used to automatically detect the input signal and switch to the input.
[Auto PC adj.]	This function is used to adjust [Fine sync], [H Position], [V Position] and [H.Size] automatically when the still image analog RGB signal is input.
[Auto keystone]	This function is used to correct the vertical keystone of the projected image automatically.

[Input search]

Set whether to enable the Input search function.

- 1) Press ▲▼ to select [Auto setup].
- 2) Press the <ENTER> button.
 - The [Auto setup] screen is displayed.
- 3) Press ▲▼ to select [Input search].

4) Press the <ENTER> button.

5) Press ▲▼ to switch the item.

- The items will switch each time you press the button.

[On]	Enables automatic execution of the Input search function.
[Off]	Disables automatic execution of the Input search function.

[Auto PC adj.]

Set the operation of the Auto PC adj. function.

1) Press ▲▼ to select [Auto setup].

2) Press the <ENTER> button.

- The [Auto setup] screen is displayed.

3) Press ▲▼ to select [Auto PC adj.].

4) Press the <ENTER> button.

5) Press ▲▼ to switch the item.

- The items will switch each time you press the button.

[On]	Enables automatic execution of the Auto PC adj. function.
[Off]	Disables automatic execution of the Auto PC adj. function.

[Auto keystone]

Set the operation of the Auto keystone function.

1) Press ▲▼ to select [Auto setup].

2) Press the <ENTER> button.

- The [Auto setup] screen is displayed.

3) Press ▲▼ to select [Auto keystone].

4) Press the <ENTER> button.

5) Press ▲▼ to switch the item.

- The items will switch each time you press the button.

[Auto]	Detects tilting of the projector in real time and corrects vertical trapezoidal distortion, regardless of whether the <AUTO SETUP> button is pressed.
[Manual]	Enables automatic execution of the Auto keystone function.
[Off]	Disables automatic execution of the Auto keystone function.

Note

- [Input search], [Auto PC adj.] and [Auto Keystone] cannot be set to [Off] at the same time. Set at least one of them to an item other than [Off].
- In some times the auto keystone maybe correct image imperfectly, manual keystone is required.
- When the [Display] menu → [Project way] is set to [Ceiling/Front] or [Ceiling/Rear], [Auto PC adj.] will be fixed to [On] automatically and [Auto keystone] will be fixed to [Off].

[Keystone]

You can correct the trapezoidal distortion or curved distortion of the projected image by using the screen adjustment function.

1) Press ▲▼ to select [Keystone].

2) Press the <ENTER> button.

- The [Keystone] screen is displayed.

3) Press ▲▼ to select one item.

[Keystone]	Sets whether or not to keep the keystone correction even after the projector is turned off or the power cord is disconnected.
[V Keystone]^{*1}	Adjusts when the vertical trapezoid of the projected image is distorted.
[H/V Keystone]^{*2}	Adjusts when the horizontal or vertical trapezoid of the projected image is distorted.
[Corner correction]^{*2}	Adjusts when the four corners of the projected image are distorted.
[Curved correction]^{*2}	Adjusts when the linearity is not uniform or the vertical and horizontal lines are distorted.
[Reset value]^{*2}	Returns the corrected values to the factory default values.

*1 Only for PT-LB305.

*2 Only for PT-LW375, PT-LW335, PT-LB425, PT-LB385 and PT-LB355.

[Keystone]

Set whether or not to keep the keystone correction even after the projector is turned off or the power cord is disconnected.

- 1) Press ▲▼ to select [Keystone].
- 2) Press the <ENTER> button.
 - The [Keystone] screen is displayed.
- 3) Press ▲▼ to select [Keystone].
- 4) Press the <ENTER> button.
- 5) Press ▲▼ to switch the item.
 - The items will switch each time you press the button.

[Reset]	If the [Setting] menu → [Standby mode] is set to [Eco], the keystone correction will be canceled when you disconnect the power cord or turn off the projector. If the [Setting] menu → [Standby mode] is set to [Normal], the keystone correction will be canceled when you disconnect the power cord; the keystone correction will be kept when you turn off the projector.
[Store]	The keystone correction will be kept when you plug out the power cord or turn off the projector.

[V Keystone]

(Only for PT-LB305)

- 1) Press ▲▼ to select [Keystone].
- 2) Press the <ENTER> button.
 - The [Keystone] screen is displayed.
- 3) Press ▲▼ to select [V Keystone].
- 4) Press the <ENTER> button.
- 5) Press ▲▼ to correct the keystone.

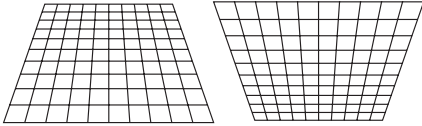
Operation	Adjustment	
Press the ▲ button.	The top becomes smaller.	
Press the ▼ button.	The bottom becomes smaller.	

[H/V Keystone]

(Only for PT-LW375, PT-LW335, PT-LB425, PT-LB385 and PT-LB355)

- 1) Press ▲▼ to select [Keystone].
- 2) Press the <ENTER> button.
 - The [Keystone] screen is displayed.
- 3) Press ▲▼ to select [H/V Keystone].
- 4) Press the <ENTER> button.
 - The [H/V Keystone] individual adjustment screen is displayed.

5) Press ▲▼◀▶ to adjust the item.

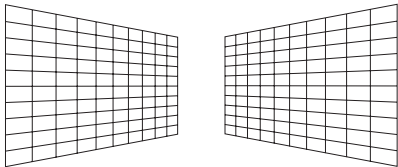
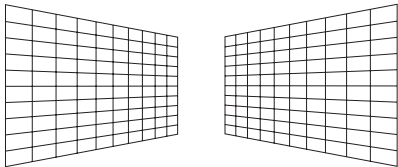
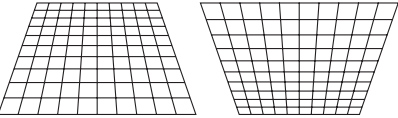
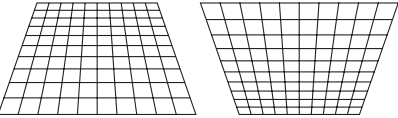
Items	Operation	Adjustment	
Horizontal	Press the ▶ button.	Adjusts the right of the keystone.	
	Press the ◀ button.	Adjusts the left of the keystone.	
Vertical	Press the ▲ button.	Adjusts the upper of the keystone.	
	Press the ▼ button.	Adjusts the bottom of the keystone.	

Note

- The red arrow indicates the direction in which distortion has been corrected while the white arrow indicates the direction in which distortion has not been corrected.
- The arrow disappears when correction reaches the maximum level.

[Corner correction]

(Only for PT-LW375, PT-LW335, PT-LB425, PT-LB385 and PT-LB355)

- 1) Press ▲▼ to select [Keystone].
- 2) Press the <ENTER> button.
 - The [Keystone] screen is displayed.
- 3) Press ▲▼ to select [Corner correction].
- 4) Press the <ENTER> button.
 - The corner correction arrows are displayed on the upper left corner of the projected image.
 - The corner to be adjusted switches in order of upper left → upper right → lower left → lower right each time you press the <KEYSTONE> button on the remote control or the control panel.
- 5) Press ▲▼◀▶ to adjust.

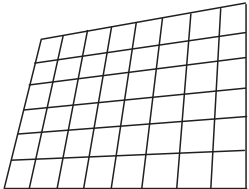
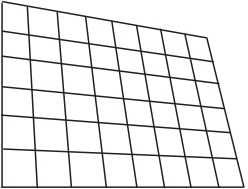
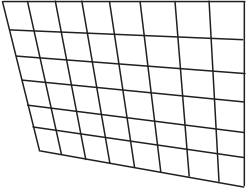
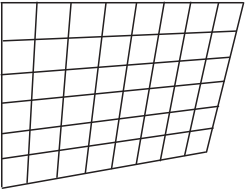
[Corner correction]			
Upper left 	Upper right 	Lower left 	Lower right 

Note

- The red arrow indicates the direction in which distortion has been corrected while the white arrow indicates the direction in which distortion has not been corrected.
- The arrow disappears when correction reaches the maximum level.

[Curved correction]

(Only for PT-LW375, PT-LW335, PT-LB425, PT-LB385 and PT-LB355)

- 1) Press ▲▼ to select [Keystone].
- 2) Press the <ENTER> button.
 - The [Keystone] screen is displayed.

3) Press ▲▼ to select [Curved correction].

4) Press the <ENTER> button.

- The [Curved correction] screen is displayed.
- The item switches in order of [Curved correction X/Y Gain] → [Curved correction X Offset] → [Curved correction Y Offset] each time you press the <KEystone> button on the remote control or the control panel.

5) Press ▲▼◀▶ to adjust the item.

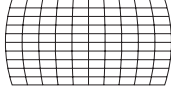
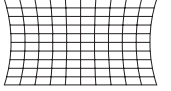
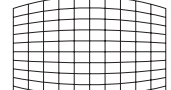
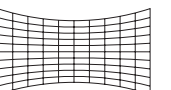
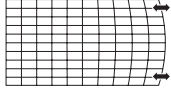
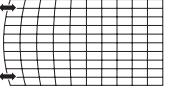
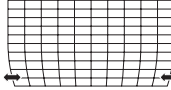
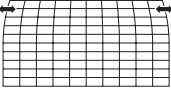
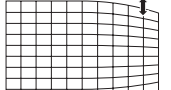
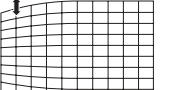
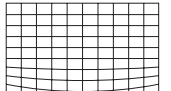
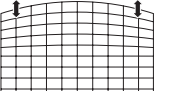
Items	Operation	Adjustment
[Curved correction X/Y Gain]	Press the ▶ button.	The left and right vertical lines will be bulge. 
	Press the ◀ button.	The left and right vertical lines will be dent. 
	Press the ▲ button.	The top and bottom horizontal lines will be bulge. 
	Press the ▼ button.	The top and bottom horizontal lines will be dent. 
[Curved correction X Offset]	Press the ▶ button.	Used to correct the right side vertical lines. Extend the top and bottom while keeping the center part as it is. 
	Press the ◀ button.	Used to correct the left side vertical lines. Extend the top and bottom while keeping the center part as it is. 
	Press the ▲ button.	Used to correct the both sides of the vertical lines. Extend the lower corners while keeping the center part and the upper part as they are. 
	Press the ▼ button.	Used to correct the both sides of the vertical lines. Extend the top corners while keeping the center part and the lower part as they are. 
[Curved correction Y Offset]	Press the ▶ button.	Used to correct the right side horizontal lines. Extend the top and bottom while keeping the center part as it is. 
	Press the ◀ button.	Used to correct the left side horizontal lines. Extend the top and bottom while keeping the center part as it is. 
	Press the ▲ button.	Used to correct the both sides of the horizontal lines. Extend the lower corners while keeping the center part and the upper part as they are. 
	Press the ▼ button.	Used to correct the both sides of the horizontal lines. Extend the top corners while keeping the center part and the lower part as they are. 

Note

- Either [H/V Keystone] or [Corner correction] setting value is valid. If the other item is adjusted after [H/V Keystone] or [Corner correction] was adjusted, the previous setting value will be reset.
- The [Curved correction X Offset] and the [Curved correction Y Offset] cannot be adjusted independently. After adjusting the [Curved correction X/Y Gain] at the beginning, please adjust the [Curved correction X Offset] and the [Curved correction Y Offset].
- Press the <KEystone> button on the control panel or on the remote control when the [H/V Keystone], [Corner correction] or [Curved correction] individual adjustment screen is displaying, the individual adjustment screen will switch as follows.
 - [H/V Keystone] ⇒ [Corner correction] (Upper left) ⇒ [Corner correction] (Upper right) ⇒ [Corner correction] (Lower right) ⇒ [Corner correction] (Lower left) ⇒ [Curved correction X/Y Gain] ⇒ [Curved correction X Offset] ⇒ [Curved correction Y Offset] ⇒ [H/V Keystone] ⇒ ...
- Correcting up to ±30° for the tilt in the vertical direction and ±15° for the tilt in the horizontal direction are available for adjustments with [Keystone]. However, the image quality will degrade and it will get harder to focus with more correction. Install the projector so that the correction will be as small as possible.
- Screen size will also change when [H/V Keystone] is used to perform various adjustments.
- Aspect ratio of the image size may shift depending on the correction.

Resetting the correction state of [Keystone]

(Only for PT-LW375, PT-LW335, PT-LB425, PT-LB385 and PT-LB355)

Cancel the state corrected with the screen adjustment function, and return to factory default.

- 1) Press ▲▼ to select [Keystone].
- 2) Press the <ENTER> button.
 - The [Keystone] screen is displayed.
- 3) Press ▲▼ to select [Reset value].
- 4) Press the <ENTER> button.
 - The state of the keystone correction is canceled.

[Logo]

Set logo selection, user logo registration and logo operation security.

- 1) Press ▲▼ to select [Logo].
- 2) Press the <ENTER> button.
 - The [Logo] screen is displayed.
- 3) Press ▲▼ to switch the item.
 - The items will switch each time you press the button.

[Logo select]	Select the logo to be displayed at projector start-up.
[Capture]	Register the user logo. The projected image will be captured and used as a logo to be displayed at projector start-up.
[Logo PIN code lock]	Prevent the logo from being changed by any person other than the administrator by setting a three-digit Logo PIN code.
[Logo PIN code change]	Change the Logo PIN code.

[Logo select]

Select the logo to be displayed at projector start-up.

- 1) Press ▲▼ to select [Logo].
- 2) Press the <ENTER> button.
 - The [Logo] screen is displayed.
- 3) Press ▲▼ to select [Logo select].
- 4) Press the <ENTER> button.
- 5) Press ▲▼ to switch the item.
 - The items will switch each time you press the button.

[Off]	Displays only the countdown at projector start-up.
[Default]	Displays the Panasonic logo and the countdown at projector start-up.
[User] ^{*1}	Displays only the image registered by the user at projector start-up.

*1 [User] will be unavailable when no user logo is registered.

Note

- [Logo Select] cannot be set if [Logo PIN code lock] is set to [On].

[Capture]

Register the user logo to be displayed at projector start-up.

- 1) Press ▲▼ to select [Logo].
- 2) Press the <ENTER> button.
 - The [Logo] screen is displayed.

- 3) **Press ▲▼ to select [Capture].**
 - Display the image you want to project at projector start-up.
- 4) **Press the <ENTER> button.**
- 5) **A confirmation screen is displayed, press ▲▼ to select [Yes] and then press the <ENTER> button.**
 - The captured image is registered as a user logo on this projector.
 - After capturing the image, the [Logo select] is set to [User]. The user logo will be displayed when the projector starts up next time.

Note

- Only supports still image-based computer (RGB) and still image-based HDMI signals input.
- Capture may not be available depending on the input signal.
- It is recommended to capture the same resolution signal as the display dots (panel resolution) of the projector.
 For PT-LW375, PT-LW335 : 1 280 x 800
 For PT-LB425, PT-LB385, PT-LB355 and PT-LB305 : 1 024 x 768
- [Capture] cannot be set if [Logo PIN code lock] is set to [On].
- The correction state of the [Keystone] will be canceled temporarily when the image is being captured.

[Logo PIN code lock]

Prevent the logo from being changed by any person other than the administrator by setting a three-digit Logo PIN code.

- 1) **Press ▲▼ to select [Logo].**
- 2) **Press the <ENTER> button.**
 - The [Logo] screen is displayed.
- 3) **Press ▲▼ to select [Logo PIN code lock].**
- 4) **Press the <ENTER> button.**
 - The [Logo PIN code] input screen is displayed.
- 5) **Press the <ENTER> button.**
- 6) **Enter the Logo PIN code you have set according to the steps in "Enter a Logo PIN code".**
 - To set the logo PIN code for the first time, you can enter the number (a three-digit number) you want to set according to the steps in "Enter a Logo PIN code".

■ Enter a Logo PIN code

- i) **Press ▲▼ to select a number from 0 to 9.**
- ii) **Press the <ENTER> button.**
 - The fixed number change to *, the cursor move to the next digit.
- iii) **Repeat the above steps, and enter a three-digit number.**
 - Move the cursor to [Set] after fixing the three-digit number.
- iv) **Press the <ENTER> button.**
 - Return to the [Logo] screen.
- 7) **Press ▲▼ to switch the item.**
 - The items will switch each time you press the button.

[On]	Select this item to disable setting or changing of [Logo select] and [Capture].
[Off]	Select this item to enable setting or changing of [Logo select] and [Capture]

Attention

- The initial Logo PIN code is "111".
- Change the Logo PIN code periodically that is hard to guess.

Note

- If you want to correct the digit, press the <MENU> button to reset the digit and then re-enter it.
- Press the <ENTER> button after moving the cursor to [Cancel] to return the menu screen.
- If you entered an incorrect digit, the digit (*) will turn red and reset, and then re-enter a digit.

[Logo PIN code change]

Change the Logo PIN code.

- 1) **Press ▲▼ to select [Logo].**
- 2) **Press the <ENTER> button.**
 - The [Logo] screen is displayed.
- 3) **Press ▲▼ to select [Logo PIN code change].**
- 4) **Press the <ENTER> button.**
 - The [Logo PIN code] input screen is displayed.
- 5) **Press the <ENTER> button.**
- 6) **Enter the Logo PIN code you have set according to the steps in “Enter a Logo PIN code” (➔ page 71).**
- 7) **Press the <ENTER> button.**
 - The [New logo PIN code] input screen is displayed.
- 8) **Enter the new Logo PIN code according to the steps in “Enter a Logo PIN code”.**

Note

- If you want to correct the digit, press ▲▼ to reset the digit and then press ▲▼ re-enter it.
- Press the <ENTER> button after moving the cursor to [Cancel] to return the menu screen.
- If you entered an incorrect digit, the digit (*) will turn red and reset, and then re-enter a digit.

[Security]

Set the PIN code to prevent the unauthorized operation by the third party. The [PIN code] input screen will be displayed when turn on the projector.

- 1) **Press ▲▼ to select [Security].**
- 2) **Press the <ENTER> button.**
 - The [Security] screen is displayed.
- 3) **Press ▲▼ to switch the item.**
 - The items will switch each time you press the button.

[PIN code lock]	Prevent the projector from being operated by any third party by setting a PIN code.
[PIN code change]	Change the PIN code.

Attention

- The initial PIN code is "111".
- Change the PIN code periodically that is hard to guess.
- To return the PIN code to the factory default setting, please consult your dealer.

[PIN code lock]

Prevent the projector from being operated by any third party by setting a three-digit PIN code.

- 1) **Press ▲▼ to select [Security].**
- 2) **Press the <ENTER> button.**
 - The [Security] screen is displayed.
- 3) **Press ▲▼ to select [PIN code lock].**
- 4) **Press the <ENTER> button.**
 - The [PIN code] input screen is displayed.
- 5) **Press the <ENTER> button.**
- 6) **Enter the PIN code you have set according to the steps in "Enter a PIN code".**
 - To set the PIN code for the first time, you can enter a number (three-digit number) you want to set according to the steps in “Enter a PIN code”.

■ Enter a PIN code

- i) Press ▲▼ to select a number from 0 to 9.
- ii) Press the <ENTER> button.
 - The fixed number change to *, the cursor move to the next digit.
- iii) Repeat the above steps, and enter a three-digit number.
 - Move the cursor to [Set] after fixing the three-digit number.
- iv) Press the <ENTER> button.
 - Return to the [Security] screen.

7) Press ▲▼ to switch the item.

- The items will switch each time you press the button.

[On]	The [PIN code] screen will be displayed when the projector is turned on. The projector cannot be operated without entering the PIN code.
[Off]	The projector can be operated without the PIN code.

Note

- If you want to correct the digit, press the <MENU> button to reset the digit and then re-enter it.
- Press the <ENTER> button after moving the cursor to [Cancel] to return the menu screen.
- If you entered an incorrect digit, the digit (*) will turn red and reset, and then re-enter a digit.

[PIN code change]

Change the PIN code.

- 1) Press ▲▼ to select [Security].
- 2) Press the <ENTER> button.
 - The [Security] screen is displayed.
- 3) Press ▲▼ to select [PIN code change].
- 4) Press the <ENTER> button.
 - The [PIN code] input screen is displayed.
- 5) Enter the PIN code you have set according to the steps in "Enter a PIN code" (⇒ page 73).
- 6) Press the <ENTER> button.
 - The [New PIN code] input screen is displayed.
- 7) Enter the New PIN code according to the steps in "Enter a PIN code".

[Power management]

Switch the projector to standby state or ready state when the no-signal status continues. You can select the standby state or ready state, the waiting time it takes for the power management function to work, as well as the waiting time before switching from the ready state to the standby state.

- 1) Press ▲▼ to select [Power management].
- 2) Press the <ENTER> button.
 - The [Power management] screen is displayed.
- 3) Press ▲▼ to select [Ready], [Shut down] or [Off].

[Ready]	When there is no signal input for 30 seconds, the countdown timer is displayed. When the time set in [Timer] has elapsed, the luminous lamp turns off and the projector enters the Ready state after cooling. If a signal is input in Ready mode, or when you press any button other than the power <⏻/> button, the luminous lamp turns on and the projector enters the projection state. Pressing the power <⏻/> button during the Ready state will enter the standby state. In addition, when the time set in [Ready countdown] has elapsed, the projector will switch from the Ready state to the standby state.
[Shut down]	When there is no signal input for 30 seconds, the countdown timer is displayed. When the time set in [Timer] has elapsed, the luminous lamp turns off and the projector enters the standby state after cooling.
[Off]	Disables the power management function.

- 4) **Press the <ENTER> button.**
 - A check mark is displayed on the left of the item selected in Step 3).
 - Proceed to Step 5) when [Ready] or [Shut down] is selected.
- 5) **Press ▲▼ to select [Timer].**
- 6) **Press the <ENTER> button.**
- 7) **Press ▲▼ to switch the setting time of [Timer].**
 - The setting time will switch each time you press the button.
 - The time until the power management function works can be set to any value from 1 minute to 30 minutes in increments of 1 minute.
 - Proceed to Step 8) when [Ready] is selected in Step 3).
- 8) **Press the <MENU> button.**
- 9) **Press ▲▼ to select [Ready Countdown].**
- 10) **Press the <ENTER> button.**
- 11) **Press ▲▼ to switch the setting time of [Ready Countdown].**
 - The items will switch each time you press the button.
 - The waiting time before the projector switches from the ready state to the standby state can be set from 1 minute to 30 minutes in increments of 1 minute.
 - When set to [0 Min], the projector will stay at the ready state instead of entering standby state.

[Filter counter]

Check the usage time of the air filter and set the cleaning cycle of the air filter. Also, the usage time of the air filter can be reset.

- 1) **Press ▲▼ to select [Filter counter].**
- 2) **Press the <ENTER> button.**
 - The [Filter counter] screen is displayed.
- 3) **Press ▲▼ to switch the item.**
 - The items will switch each time you press the button.

[Filter counter]	Displays the usage time of the filter.
[Timer]	Sets the cleaning cycle of the filter.
[Filter counter reset]	Resets the usage time of the filter.

Setting [Timer]

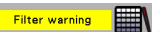
If you want to clean the air filter periodically, set the cycle time. Once the usage time of the filter reaches the set time, the filter warning icon [] is displayed on the projected screen.

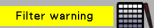
- 1) **Press ▲▼ to select [Filter counter].**
- 2) **Press the <ENTER> button.**
 - The [Filter counter] screen is displayed.
- 3) **Press ▲▼ to select [Timer].**
- 4) **Press the <ENTER> button.**
- 5) **Press ▲▼ to switch the setting of the time.**
 - The items will switch each time you press the button.
[Off] → [100 H] → [200 H] → [300 H]
 - The filter warning icon [] will not be displayed if [Timer] is set to [Off].

[Filter counter reset]

- 1) **Press ▲▼ to select [Filter counter].**
- 2) **Press the <ENTER> button.**
 - The [Filter counter] screen is displayed.

- 3) Press ▲▼ to select [Filter counter reset].
- 4) Press the <ENTER> button.
 - The [Filter counter Reset?] screen is displayed.
- 5) Press ▲▼ to select [Yes] and then press the <ENTER> button.
 - The [OK?] screen is displayed.
- 6) Press ▲▼ to select [Yes] and then press the <ENTER> button.

[Test pattern]

Displays the Test pattern built-in to the projector.

Settings of position, size, and other factors will not be reflected in test patterns. Make sure to display the input signal before performing various adjustments.

- 1) Press ▲▼ to select [Test pattern].
- 2) Press the <ENTER> button.
 - The [Test pattern] screen is displayed.
- 3) Press ▲▼ to switch the item.

[Off]	Test pattern is not displayed.
[Gray scale 1]	Select a test pattern so that it is easy to make various adjustments.
[Gray scale 2]	
[Gray scale 3]	
[Gray scale 4]	
[Color bar]	
[Red]	
[Green]	
[Blue]	
[Cross hatch]	
[White]	
[Black]	
[Raster gray]	

- 4) Press the <ENTER> button.
 - The selected test pattern is displayed and the menu screen is disappeared.

Note

- Press the <MENU> button to display the menu screen and select [Off] in [Test pattern] when you want to cancel displaying of the test pattern.

[Network]

(Only for PT-LW375, PT-LW335, PT-LB425, PT-LB385 and PT-LB355)

Perform network setting before using the network function.

[Network setting]

Perform the connection setting to use wired LAN. For wireless LAN setting, please refer to “When connecting via wireless LAN”(➡ page 87).

- 1) Press ▲▼ to select [Network].
- 2) Press the <ENTER> button.
 - The [Network] screen is displayed.
- 3) Press the <ENTER> button.
 - The [Network setting] screen is displayed.

4) Press ▲▼ to select an item, and change the setting according to the instructions.

[DHCP]	<p>[On]: If a DHCP server exists in the network to which the projector is connected, the IP address will automatically be acquired.</p> <p>[Off]: If a DHCP server does not exist in the network to which the projector is connected, additionally set [IP address], [Subnet] and [Gateway].</p>
[IP address]	Enter the IP address if DHCP server is not used.
[Subnet]	Enter the subnet mask if DHCP server is not used.
[Gateway]	Enter the gateway address if DHCP server is not used.
[DNS]	Enter the DNS server address if DHCP server is not used.

5) Press ▲▼ to select [Set], and press the <ENTER> button.

- The following settings are set before the projector leaves the factory.

[DHCP]	Off
[IP address]	192.168.1.100
[Subnet]	255.255.255.0
[Gateway]	192.168.1.1
[DNS]	192.168.1.1

Note

- Before using the DHCP server, make sure the DHCP server is already functioning.
- Consult your network administrator regarding the IP address, Subnet and Gateway.

[Network information]

1) Press ▲▼ to select [Network].

2) Press the <ENTER> button.

- The [Network] screen is displayed and then confirm the following items.

[MAC address]	Displays the MAC address of this projector.
[IP address]	Displays the current IP address of this projector.
[SSID] *1	Displays the SSID character string of the projector while the Wireless LAN is connected.
[Wireless IP] *1	Displays the IP address of the wireless module which is inserted into the projector while the wireless LAN is connected.

*1 It will be displayed when the wireless module (Model No.: ET-WML100) of the optional accessories is inserted.

[Remote control]

This switching function prevents remote control interference when operating several projectors or video equipment at the same time.

1) Press ▲▼ to select [Remote control].

2) Press the <ENTER> button.

- The [Remote control] screen is displayed.

3) Press ▲▼ to select one item.

- This projector provides seven different remote control codes: [ALL], [Code 1]~[Code 6].

[ALL]	Select when controlling projectors without specifying an ID number.
[Code 1] - [Code 6]	Select when specifying an ID number to control individual projector.

4) Press the <ENTER> button.

- [Remote control] is set.

Note

- To specify an ID number for individual control, the ID number of a remote control must match the ID number of the projector.
- When the ID number is set to [ALL], the projector will operate regardless of the ID number specified by remote control. If multiple projectors are set up side by side with ID set to [ALL], they cannot be controlled separately from the projectors with other ID numbers.
- Refer to "Setting the remote control ID numbers" (➡ page 49) for how to set the ID number on the remote control.

[Factory default]

Return various setting values to their factory default settings.

- 1) Press ▲▼ to select [Factory default].
- 2) Press the <ENTER> button.
 - The [Return to Factory default?] screen is displayed.
- 3) Press ▲▼ to select [Yes] and then press the <ENTER> button.
 - The [OK?] screen is displayed.
- 4) Press ▲▼ to select [Yes] and then press the <ENTER> button.
 - The [Please wait] message will appear, and resetting operation will start, and after completing the operation, the [Please wait] message will disappear.

Attention

- After executing the [Factory default], be sure to turn off the projector (➔ page 41), disconnect the power plug from the wall outlet, and then turn on the projector in order to reflect the initial setting values.

Note

- The PIN code, logo PIN code, [Logo select] setting, user logo, lamp usage time and filter usage time will not return to the factory default settings even if [Factory default] is executed.

[Memory Viewer] menu

On the menu screen, select [Memory Viewer] from the main menu, and select an item from the sub-menu. Refer to “Navigating through the menu” (➔ page 51) for the operation of the menu screen.

Note

- Memory Viewer function is only for PT-LW375, PT-LW335, PT-LB425, PT-LB385 and PT-LB355.
- The [Memory Viewer] menu is available only when the Memory Viewer input is selected.
- The menu except for [Set slide] which settings have been changed is not yet effective before the [Apply] is not executed.

[Set slide]

Start the slide show.

- 1) Press ▲▼ to select [Set slide].
- 2) Press the <ENTER> button.
 - Slide show will start.

[Slide transition effect]

Set the slide transition effect when the slide show image is switching.

- 1) Press ▲▼ to select [Slide transition effect].
- 2) Press the <ENTER> button.
- 3) Press ▲▼ to switch the item.
 - The items will switch each time you press the button.

[Slide down]	Switches the image from the top to the bottom.
[Slide right]	Switches the image from the left to the right.

[Sort order]

Sets the order of images to be played in the slideshow.

- 1) Press ▲▼ to select [Sort order].
- 2) Press the <ENTER> button.
- 3) Press ▲▼ to switch the item.
 - The items will switch each time you press the button.

[Extend order]	Plays the files in ascending order of their extensions.
[Size order]	Plays the files or folders in ascending order of their data size.
[Time order]	Plays the files or folders in ascending order of their creation time.
[Name order]	Plays the files or folders in ascending order of their names.

[Rotate]

Set the rotate direction of image.

- 1) Press ▲▼ to select [Rotate].
- 2) Press the <ENTER> button.
- 3) Press ▲▼ to switch the item.
 - The items will switch each time you press the button.

[No rotate]	Rotate is disabled.
[270 Degrees]	Rotates 270 degrees in clockwise direction.
[180 Degrees]	Rotates 180 degrees.
[90 Degrees]	Rotates 90 degrees in clockwise direction.

[Best fit]

Set whether or not to fit the image with the projected screen.

- 1) Press ▲▼ to select [Best fit].
- 2) Press the <ENTER> button.

3) Press ▲▼ to switch the item.

- The items will switch each time you press the button.

[On]	Displays the image in full screen in the horizontal and/or vertical direction while maintaining the image aspect ratio.
[Off]	Displays in the normal pixels of the image.

[Repeat]

Set whether or not to play the slide show repeatedly.

1) Press ▲▼ to select [Repeat].

2) Press the <ENTER> button.

3) Press ▲▼ to switch the item.

- The items will switch each time you press the button.

[On]	After playing the last file, return to the first file and repeat playback.
[Off]	After playing the last file, return to the thumbnail display.

[Apply]

Enable the setting in slide show.

1) Press ▲▼ to select [Apply].

2) Press the <ENTER> button.

- The setting of the items except for [Set slide] will be effective.

[Info.] menu

On the menu screen, select [Info.] from the main menu.

Refer to “Navigating through the menu” (➔ page 51) for the operation of the menu screen.

[Info.]

Display the status of the projector.

1) Press ▲▼ to select [Info.].

- The [Info.] screen is displayed.
- You can also press the <INFO.> button on the remote control. (➔ page 46)

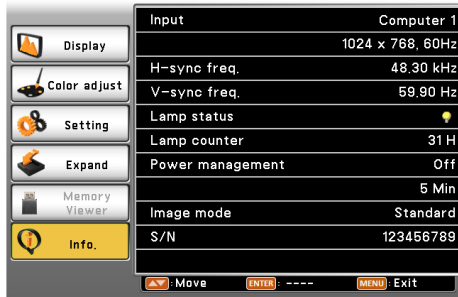

[Input]	The selected input source and the system are displayed.
[H-sync freq.]	The horizontal frequency of the input signal is displayed in kHz. [- - - -] is displayed when no signal is detected.
[V-sync freq.]	The vertical frequency of the input signal is displayed in Hz. [- - - -] is displayed when no signal is detected.
[Lamp status]	The setting of [Lamp control] is displayed.
[Lamp counter]	The usage time of the lamp is displayed. (Displays the converted runtime when [💡 (Eco)] is using.)
[Power management]	The setting of [Power management] is displayed.
[Image mode]	The setting of [Image mode] is displayed.
[S/N]	The serial number of the projector is displayed. The serial number is used to service the projector.

Chapter 5 **Operation of Function**

This chapter describes the operation methods of some functions.

About Memory Viewer function

(Only for PT-LW375, PT-LW335, PT-LB425, PT-LB385 and PT-LB355)

The Memory Viewer function makes it possible to display the still images stored in the USB memory as projected images.

What you can project with the Memory Viewer function

Memory Viewer function supports the following image files.

	Extension	Format	Description
Picture	jpg/jpeg	Baseline coding 24 bits Progressive RGB 24 bits	Resolution : 8 x 8 ~ 10 000 x 10 000 Resolution : 8 x 8 ~ 1 280 x 800
	bmp	Palette-based 1, 4, 8 bits, RGB 24, 32 bits	The maximum resolution : 1 280 x 800
	png	True color 24 bits/48 bits	The maximum resolution : 1 280 x 800
	gif	Palette-based 1, 4, 8 bits,	Palette - 24 bits color spaces; The maximum resolution : 1 280 x 800
	tif / tiff	—	The maximum resolution : 1 280 x 800

Note

- File size that can be played back is 2 GB at the maximum.
- The total number of folders/files that can be recognized on the projector is 500 at the maximum.
- Files protected by DRM (Digital Rights Management) cannot be played back.
- It may be impossible to play even if the file is recorded in the supported format.

Cautions on using USB Memory

Please observe the following.

- Do not put USB memory or its cap within close reach of children. Swallowing them may cause suffocation.
- If the smoke or questionable odor rise, remove the USB memory from the projector, and then contact your dealer.
- Do not put water, chemical or oil to the USB memory. It may cause short out or fire.
- Do not put foreign objects or put metal objects to the USB terminal. It may cause data loss or data corruption.
- Do not remove the USB memory from the projector while data is being read from the USB memory. It may cause data loss or data corruption.
- Do not leave the USB memory in a place with high humidity or dust.
- Do not leave the USB memory in a place where static electricity or electromagnetic radiation is generated.

Note

- It is compatible with the USB memory sold in the market.
- It cannot be used the other format other than the formatted with FAT16 and FAT32.

Attaching the USB memory

- 1) Attach the USB memory firmly into the <USB A (VIEWER/WIRELESS)> terminal.

Attention

- Pay attention to the terminal direction to avoid damaging the terminal when attaching the USB memory.
- Attach the USB memory directly into the <USB A (VIEWER/WIRELESS)> terminal of the projector. Do not use a USB extension cable or USB hub.

Removing the USB memory

- 1) Make sure that the indicator on the USB memory is not flashing, and remove it.

Attention

- Please note following points when removing the USB memory.
 - When the indicator of the USB memory attached to the projector is blinking, it indicates that the projector is reading the USB memory. Do not remove the USB memory from the projector while the indicator is blinking.
 - When using a USB memory that does not have a monitor function such as an indicator, you cannot check the access status to the USB memory. In this case, remove it from the projector after closing the memory viewer function or turning off the projector.
 - Do not attach and detach the USB memory in a short time. Wait at least 5 seconds after attaching and then remove the USB memory. If you want to reattach it, wait at least 5 seconds after removal. It takes about 5 seconds for the projector to recognize the USB memory.

Displaying the Memory Viewer screen

- 1) Press the <MEMORY VIEWER/USB DISPLAY/NETWORK> button on the remote control to switch the input source to Memory Viewer.
 - You can also press the <INPUT/ENTER> button on the control panel and select the input source in the Input menu.
- 2) Attach the USB memory directly into the <USB A (VIEWER/WIRELESS)> terminal.
 - The standby screen “please press RC ENTER” is displayed while the USB memory icon is displayed at the lower left of the screen.
- 3) Press the <ENTER> button on the remote control.
 - The root directory of the USB memory will be displayed in thumbnail on the screen.

Playing the pictures

- 1) Press ▲▼◀▶ on the remote control to select a file you want to play on the memory viewer screen.
- 2) Press the <ENTER> button on the remote control.
 - The picture will display on the full screen.
- 3) Press ▶ to switch to the next picture, press ◀ to return to the previous picture.
- 4) Press the <ENTER> button on the remote control.
 - Return to the thumbnail screen.

Note

- When the recorded number of pixels is smaller than the maximum number of display dot^{*1}, it will be displayed enlarged maintaining the aspect ratio.
- When the recorded number of pixels is larger than the maximum number of display dot^{*1}, it will be displayed reduced maintaining the aspect ratio.
- When the recorded number of pixels is the same as the maximum number of display dot^{*1}, it will neither be enlarged nor reduced, so degradation of image quality can be reduced.

*1 The maximum number of display dot for each product is as follows.

PT-LW375 and PT-LW335: 1 280 x 800

PT-LB425, PT-LB385 and PT-LB355: 1 024 x 768

Executing the slide

All pictures in the same folder will play automatically according to the settings of [Sort order], [Slide transition effect] and so on of the [Memory Viewer] menu.

- 1) Press ▲▼◀▶ on the remote control to select a file.
- 2) Press the <MENU> button to select the [Memory Viewer] → [Set slide].
- 3) Press the <ENTER> button on the remote control.
 - The slideshow will start.
 - Press the <ENTER> button to return to the thumbnail screen.

Note

- If you press the <MENU> button during playback in the slideshow, the playback will stop and the a menu displays. The playing will continue when the menu disappears.
- When the slide show is playing the files in the second or subsequent thumbnail pages, if the settings of the [Memory viewer] menu are changed, the slide show will resume from the first file in the first thumbnail page.

Termination of the Memory Viewer

- 1) Press ▲▼◀▶ to select the thumbnail  which is displayed on the upper left corner.
- 2) Press the <ENTER> button on the remote control.
 - Return to the standby screen “please press RC ENTER”.
 - Depending on file path length, you may need to repeat Step 1) and Step 2) before returning to the standby screen.

Note

- You can also exit the Memory Viewer by switching to the input other than Memory Viewer.

USB Display function

(Only for PT-LW375, PT-LW335, PT-LB425, PT-LB385 and PT-LB355)

The USB Display function makes it possible to project the image and audio from the computer through a USB converting cable.

When using the USB display function on Mac, the audio output is disabled.

When using on a Windows computer

■ Operating environment

OS	Windows 7 32/64 bit, Windows 8.1 32/64 bit, Windows 10 32/64 bit
CPU	Intel Core 2 Duo 2.0 GHz or faster, the compatible processor
Hard-disk free space	20 MB or more
Display	Resolution 640 x 480 or more, 1 600 x 1 200 or less

- There is no guarantee for all the computers that meet the above conditions will operate properly.

Projecting the USB display

Note

- The USB Display function and the Presenter Light software cannot be used at the same time. Before using the USB Display function, terminate the Presenter Light software.

- 1) **Connect the <USB B (DISPLAY)> terminal of the projector to a computer with a USB cable.**
- 2) **Press the <MEMORY VIEWER/USB DISPLAY/NETWORK> button on the remote control to switch the input source to USB Display.**
 - You can also press the <INPUT/ENTER> button on the control panel and select the input source in the Input menu.
 - The startup screen will be displayed automatically due to the driver which is built-in the projector, and executing the installation according to the instructions of the screen. The displaying of the auto installation screen is depending on the settings of computer. At this time, please select "Run autorun.exe". Please double-click "autorun.exe" in the folder of the "USB Display" when the automatic startup is disabled.
 - The computer screen is projected.
- 3) **Click the driver icon  in the task tray (bottom right of the computer) and select one item in Pop-up menu.**
 - Pop-up menu is only displayed in English.
 - The item which is displayed in gray is unavailable.

[Active audio] / [Disable audio]	Set whether to output the audio from the computer.
[Play video] / [Pause video]	Switch between playing and pausing the image.
[Start] / [Stop]	Set whether to display the image from the computer.
[Exit]	Displayed in gray and cannot be selected.

Note

- It will take a while when you want to project the computer screen.
- Connect a USB cable directly to the USB connector of a computer. It will not work when connect through a USB hub.
- At the time that the computer screen is projected, the resolution of the computer may be forcibly changed depending on the combination of computer and projector.
- When executing an invalid operation during USB Display input, the icon  that indicates the key operation is invalid will be displayed.

Termination of the USB display

- 1) **When terminating the USB display, remove the USB cable directly.**
 - There is no need to follow "Remove hardware safely" when a USB cable is disconnected.

When using on Mac

■ Operating environment

OS	OS X 10.11, macOS Sierra / High Sierra
CPU	Intel Core 2 Duo 2.0 GHz or faster
Hard-disk free space	20 MB or more
Display	Resolution 640 x 480 or more, 1 600 x 1 200 or less

- There is no guarantee for all the computers that meet the above conditions will operate properly.

Projecting the USB display

- 1) Connect the <USB B (DISPLAY)> terminal of the projector to a computer with a USB cable.
- 2) Press the <MEMORY VIEWER/USB DISPLAY/NETWORK> button on the remote control to switch the input source to USB Display.
 - You can also press the <INPUT/ENTER> button on the control panel and select the input source in the Input menu.
 - The virtual disk which is named "USB Display" will be mounted on desktop.
- 3) Double-click "Monitor.app" in the virtual disk that has been mounted.
 - The computer screen is projected.
- 4) Right-click the driver icon  in the dock of computer and select one item in Pop-up menu.
 - The item which is displayed in gray is unavailable.

[Active audio] / [Disable audio]	The audio output is disabled.
[Play video] / [Pause video]	Switch between playing and pausing the image.
[Start] / [Stop]	Set whether to display the image from the computer.
[Options]	Set the items of "Keep in Dock", "Open at Login" or "Show in Finder".
[Show All Windows]	Display the background of computer on the full screen temporarily.
[Hide] / [Show]	Set whether to display the USB driver icon.
[Quit]	Terminate the USB Display.

Note

- It will take a while when you want to project the computer screen.
- Connect a USB cable directly to the USB connector of a computer. It will not work when connect through a USB hub.
- At the time that the computer screen is projected, the resolution of the computer may be forcibly changed depending on the combination of computer and projector.
- When executing an invalid operation during USB Display input, the icon  that indicates the key operation is invalid will be displayed.
- The virtual disk may not be mounted on the desktop depending on your computer. In this case, please open [Finder] and then refer to the "USB Display" in [DEVICES].

Network connection

(Only for PT-LW375, PT-LW335, PT-LB425, PT-LB385 and PT-LB355)

This projector has network function that allows the following by connecting a computer.

The wireless module (Model No.: ET-WML100) of the optional accessories is required if you want to use the network function through the wireless LAN.

- **WEB control**

By accessing to the projector from a computer, you can perform setting, adjustment, status display, etc. of the projector. Refer to “Web control function” (➔ page 90) for details.

- **Multi Monitoring & Control software**

“Multi Monitoring & Control Software”, a software application to monitor and control multiple display devices (projector or flat panel display) connected to intranet, can be used.

Plug-in software “Early Warning Software”, which monitors the status of the display devices and their peripherals within an intranet, and notifies of abnormality of such equipment and detects the signs of possible abnormality, can also be used.

For details, visit the Panasonic website (<https://panasonic.net/cns/projector/>).

- **Image transfer application software**

Using the Panasonic image transfer application software, the image sent from a device can be displayed as a projected image.

For details on how to use the image transfer application software “Presenter Light” compatible with Windows computers, please refer to the Operating Instructions of the “Presenter Light” software. The “Presenter Light” software can be downloaded by accessing the projector via a web browser. For details, please refer to “About Presenter Light” (➔ page 89). The application software and its operating instructions can be downloaded from our website (<https://panasonic.net/cns/projector/>).

For details of the image transfer application software “Wireless Projector” compatible with the iPad/iPhone/iPod touch or Android device, refer to the Panasonic website (<https://panasonic.net/cns/projector/>).

- **PJLink**

By using PJLink protocol, you can send inquiries about the operations or status of the projector from a computer. Refer to “Using the PJLink protocol” (➔ page 106) for details.

When connecting via wired LAN

Connection example

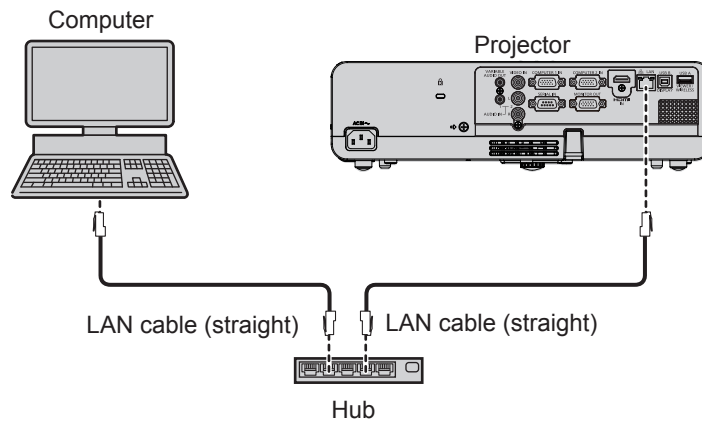

■ Name and function of <LAN> terminal

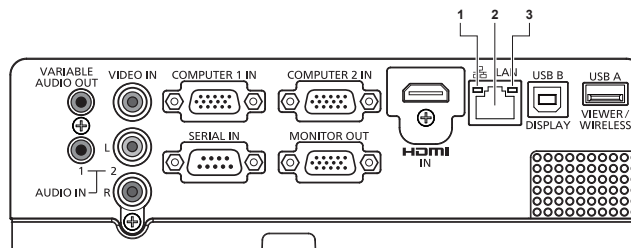

1 LAN LINK/ACT lamp (yellow)

Lights on when connected.
Blinks when transmitting/receiving data.

2 <LAN> terminal (10BASE-T/100BASE-TX)

Used to connect LAN cable here.

3 LAN 10/100 lamp (green)

Lights on when connected to the 100BASE-TX.

Attention

- When a LAN cable is directly connected to the projector, the network connection must be made indoors.
- When connecting cables to both the <HDMI IN> terminal and the <USB B (DISPLAY)> terminal, it may be difficult to remove the LAN cable which is connected to the <LAN> terminal. When removing the LAN cable from the <LAN> terminal, remove a cable connected to the <HDMI IN> terminal or the <USB B (DISPLAY)> terminal beforehand.

Note

- A LAN cable is required to use the wired LAN function.
- Use shielded LAN cable (STP cable) that is compatible with category 5 or above.
- Use a LAN cable with length of 100 m or shorter.

Projector settings

- 1) Use the LAN cable (Straight) to connect the projector with computer.
- 2) Turn on the projector.
- 3) Set the [Expand] menu → [Network] → [Network setting].
 - For details, refer to the [Expand] menu → [Network] (➔ page 75).

Note

- Please confirm with your network administrator before you connect to an existing network.
- The wired LAN and wireless LAN cannot be used in the same segment.
- The following is preset as the factory default setting.

[DHCP]	Off
[IP address]	192.168.1.100
[Subnet]	255.255.255.0
[Gateway]	192.168.1.1
[DNS]	192.168.1.1

Computer setting

- 1) Turn on the computer.
- 2) Make the network setting according to your system administrator.
 - If the projector settings are the default settings, the computer can be used with the following network settings.

[IP address]	192.168.1.101
[Subnet]	255.255.255.0
[Gateway]	192.168.1.1

When connecting via wireless LAN

The wireless module (Model No.: ET-WML100) of the optional accessories is required if you want to use the network function through the wireless LAN.

- Only one projector can be connected with the wireless LAN.

Connection example

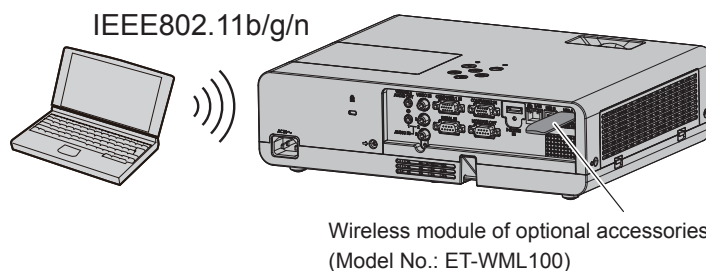

Preparation and confirmation of the projector

- 1) Turn on the projector.
- 2) Attach the wireless module (Model No.: ET-WML100) of optional accessories firmly into the <USB A (VIEWER/WIRELESS)> terminal.

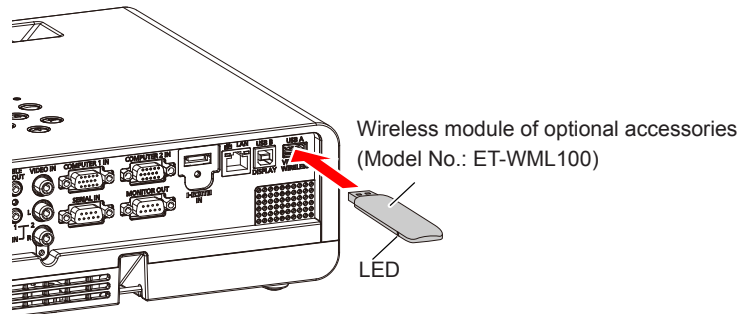

3) Press the <MEMORY VIEWER/USB DISPLAY/NETWORK> button on the remote control to switch to Network input.

- The network input idle screen is displayed. The login password (a four-digit number that is automatically generated), projector name: PROJECTOR (fixed), IP address (Wireless LAN) and IP address (Wired LAN) will be displayed in the idle screen.
- You can also press the <INPUT/ENTER> button on the control panel and the input source screen is displayed, then press ▲▼ to select [Network].

Network input idle screen

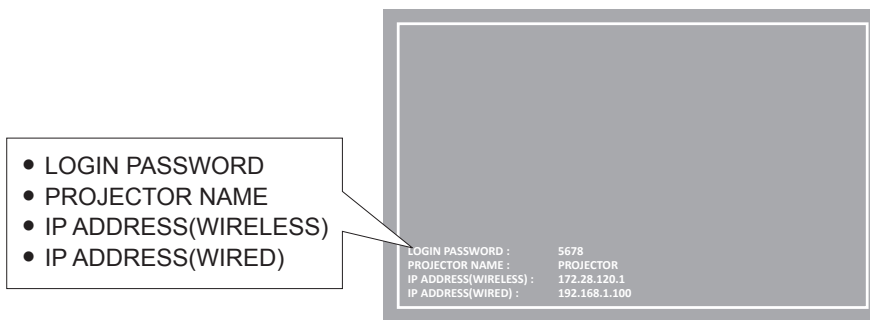

Attention

- Please do not move or transport the projector while the wireless module is attached. Doing so may cause the wireless module to be damaged.
- The blue LED of the wireless module will be off when the projector is in standby mode, it will light when the power is turned on and it will blink during wireless communicating. Please do not remove the wireless module while the LED is blinking.
- When executing an invalid operation during network input, the icon that indicates the key operation is invalid will be displayed. In this case, press the <MENU> button and execute each function from the menu operation.

Note

- The projector name is fixed as “PROJECTOR” and cannot be changed.
- Wireless LAN and wired LAN cannot be used in the same segment.
- The settings of the wireless module are as follows:

[SSID]	NetworkDisplay
[Channel]	1
[IP address]	172.28.120.1
[Subnet]	255.255.255.0
[Gateway]	0.0.0.0
[Access point Encryption]	None

Computer setting

- 1) Turn on the computer.**
- 2) Make the network setting according to your system administrator.**
 - Please make the network settings for the computer and the projector according to your system administrator.
- 3) Connect to the network that has been set in the projector.**
 - If you use a computer, click on the task tray (bottom right of the computer), then select the same name as the [SSID] that has been set in the projector.
 - Please confirm [SSID] in the [Expand] menu → [Network] → [Network information] of this projector.

Note

- If you use any wireless LAN connection utility that meets the OS standard, follow the operation instruction of the utility to connect it.

About Presenter Light

(Only for PT-LW375, PT-LW335, PT-LB425, PT-LB385 and PT-LB355)

(The wireless module (Model No.: ET-WML100) of the optional accessories is required if you want to use the network function through the wireless LAN.)

By using image transfer application software "Presenter Light" that supports Windows computers, you can transfer images and audio to the projector via the wired LAN/wireless LAN^{*1}.

*1 Sound interruption or noise may occur during image / sound transfer. In such a case, please select mute in the audio setting of the application software.

Download the "Presenter Light" to your computer

- 1) **Activate the Web browser in the personal computer.**
- 2) **Enter the IP address set by the projector into the URL input field of the web browser.**
 - The [Network Display System] screen is displayed.
- 3) **Click [Download].**
 - The download screen of "Presenter Light" is displayed.

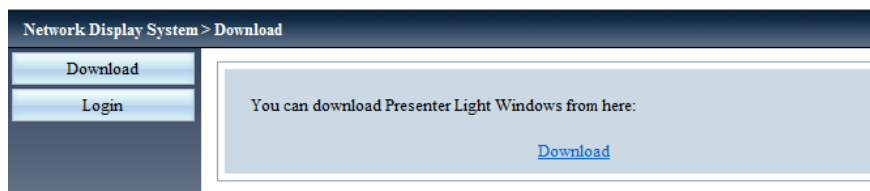

- 4) **Click [Download].**
 - The download confirmation screen of the compressed file "Presenter Light.zip" is displayed.
- 5) **Save and decompress "Presenter Light.zip".**
 - After decompressing, a "Presenter Light" folder, which contains an executable file "Presenter Light.exe" and a "License" folder with the open source licenses used for the "Presenter Light" software, is generated.
 - Execute "Presenter Light.exe" directly when using the Presenter Light software. Please save this software or make a shortcut for convenient use. Installing the software on the computer is unnecessary.

Note

- To learn more about how to use the "Presenter Light" software, or download the latest versions of the "Presenter Light" software, please visit the Panasonic website (<https://panasonic.net/cns/projector/>)

Web control function

(Only for PT-LW375, PT-LW335, PT-LB425, PT-LB385 and PT-LB355)

(The wireless module (Model No.: ET-WML100) of the optional accessories is required if you want to use the network function through the wireless LAN.)

Using Web control functions, you can perform the following operations from a computer.

- Setting and adjustment of the projector
- Displaying projector status
- Setting of E-mail message sending

Note

- Communication with an E-mail server is required to use the E-mail function. Confirm that the E-mail can be used beforehand.

Computer that can be used for setting

A web browser is required to use the web control function. Confirm that your web browser can be used beforehand.

OS	Compatible web browser
Windows	Internet Explorer 11.0 Microsoft Edge
Mac OS	Safari 8.0/9.0/10.0/11.0

Accessing from the web browser

- 1) **Activate the Web browser in the personal computer.**
- 2) **Enter the IP address set by the projector into the URL input field of the web browser.**
 - The [Network Display System] screen (web control screen) is displayed.
- 3) **Click [Login] and enter the password in the [Password] column.**
 - The factory default setting of the user name is "admin" (fixed) and the password is "admin".

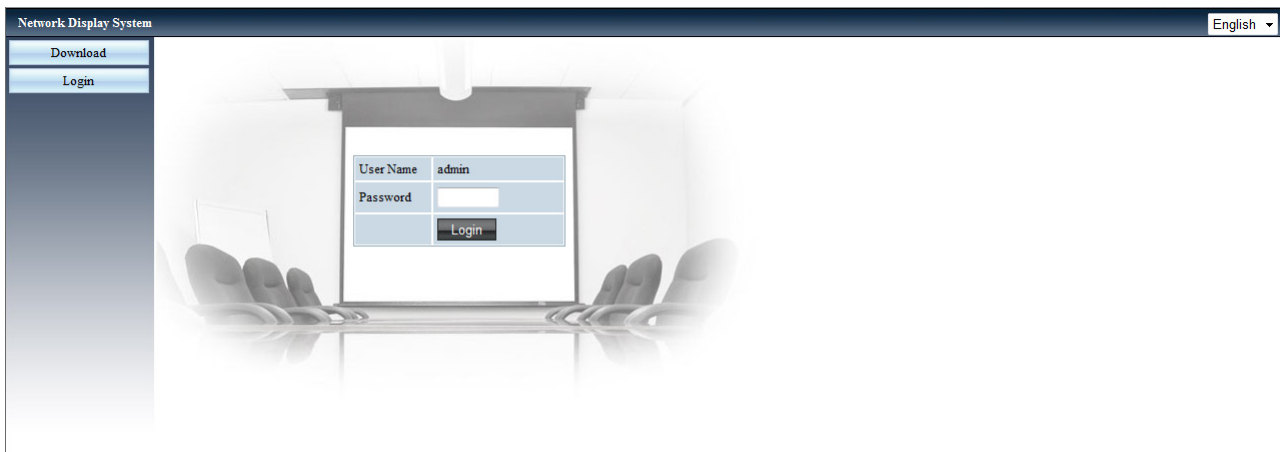

- 4) **Click [Login].**
 - The [System Status] page is displayed.

Note

- You can click the upper right corner of the web browser screen to select the display language (Only for English, Japanese, Traditional Chinese and Simplified Chinese).
- Do not perform setting or control simultaneously by starting up multiple web browsers. Do not set or control the projector from multiple computers.
- Change the password first. (eight characters in single byte) (► page 92)
- If the screen for the web control is not displayed, consult your network administrator.

Description of each item

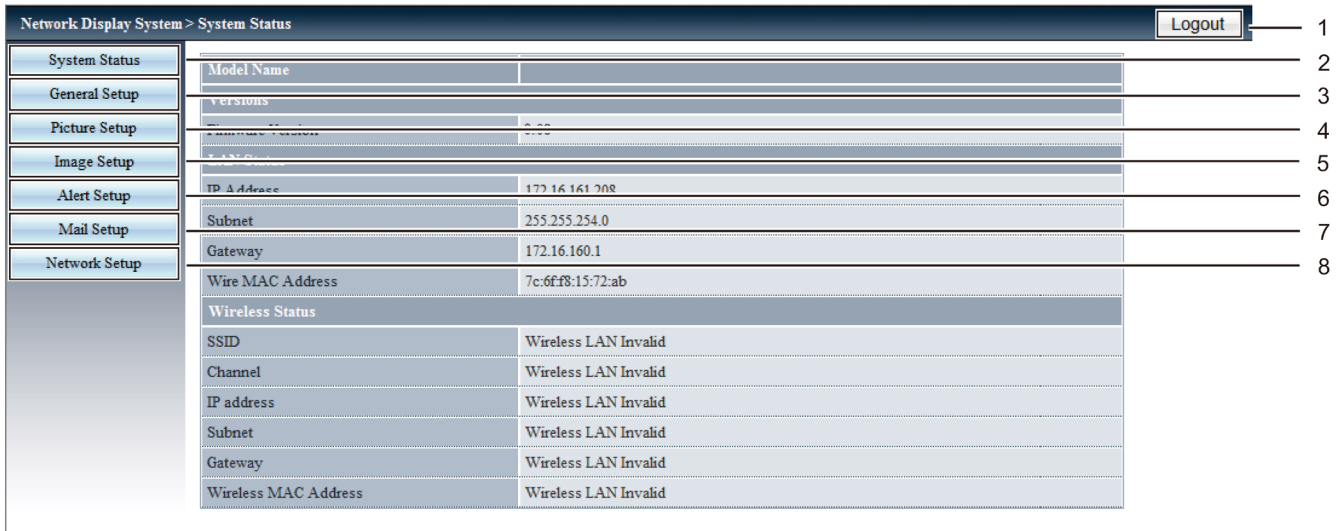

- 1 **[Logout]**
Click it to end the web control.
- 2 **[System Status]**
The [System Status] page is displayed by clicking this item.
- 3 **[General Setup]**
The [General Setup] page is displayed by clicking this item.
- 4 **[Picture Setup]**
The [Picture Setup] page is displayed by clicking this item.
- 5 **[Image Setup]**
The [Image Setup] page is displayed by clicking this item.
- 6 **[Alert Setup]**
The [Alert Setup] page is displayed by clicking this item.
- 7 **[Mail Setup]**
The [Mail Setup] page is displayed by clicking this item.
- 8 **[Network Setup]**
The [Network Setup] page is displayed by clicking this item.

[System status] page

Display the status of the projector for the following items.

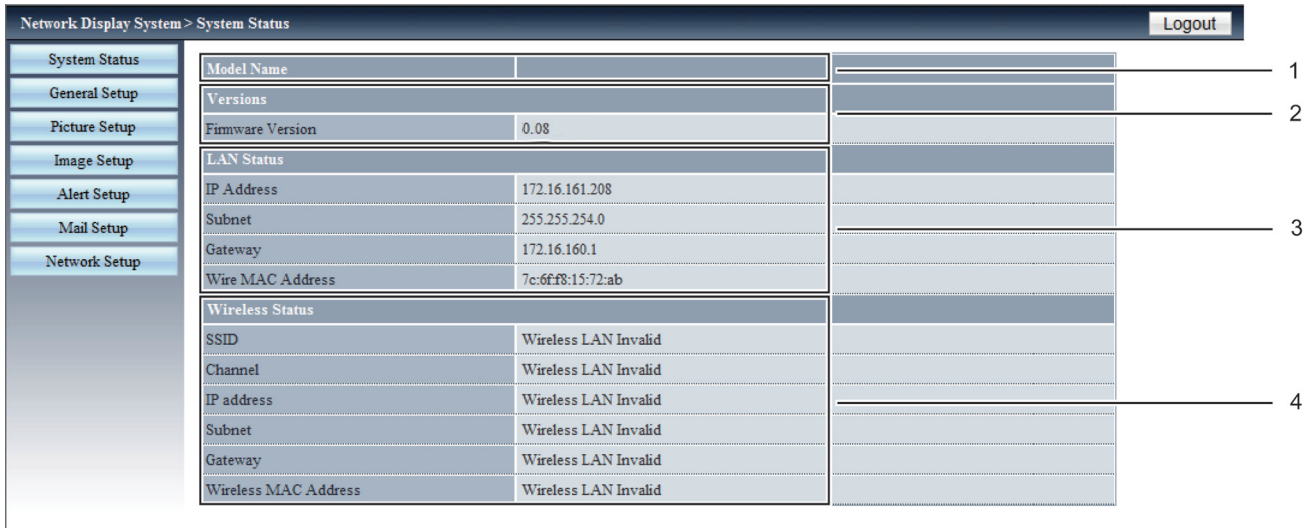

- 1 **[Model Name]**
Displays the model No. of the projector.
- 2 **[Versions]**
Displays the version of the firmware of the projector.
- 3 **[LAN Status]**
Displays the connection status of the LAN.
- 4 **[Wireless Status]**
Displays the connection status of the wireless LAN.

[General Setup] page

Change the password of web control function, turn on or off the power, or switch the input.

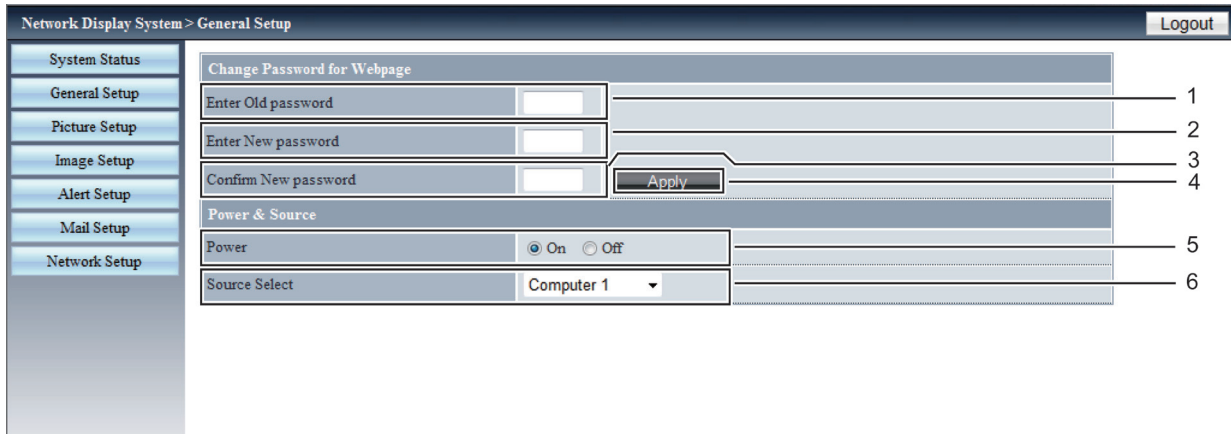

- | | |
|---|---|
| <p>1 [Enter Old password]
Enters the configured password.</p> <p>2 [Enter New password]
Enters the new password.</p> <p>3 [Confirm New password]
Enters the desired new password again for confirmation.</p> | <p>4 [Apply]
Updates the settings.</p> <p>5 [Power]
Turns on/off the power.</p> <p>6 [Source Select]
Switches the input source of the projector.</p> |
|---|---|

[Picture Setup] page

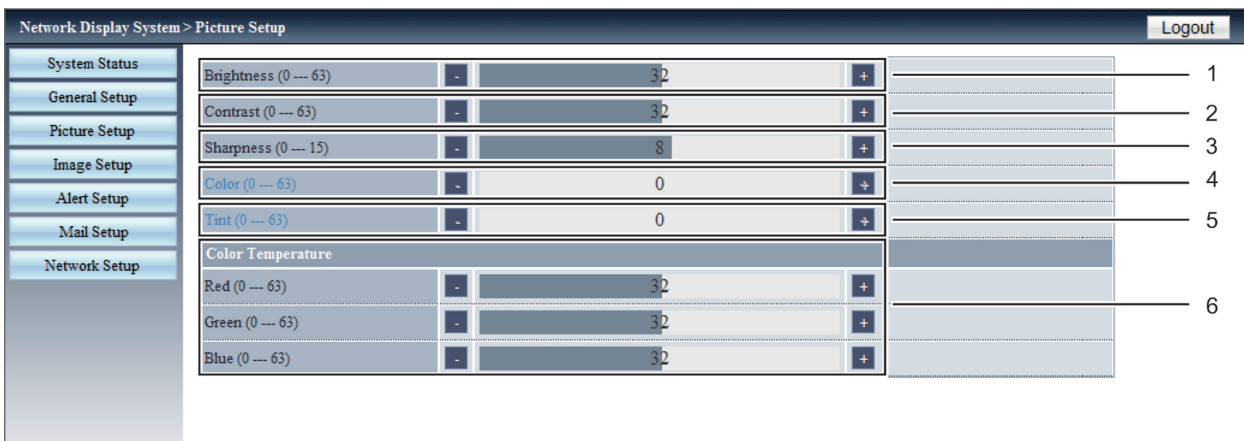

- | | |
|---|---|
| <p>1 [Brightness]
Adjusts the brightness of the projected image.</p> <p>2 [Contrast]
Adjusts the contrast of the projected image.</p> <p>3 [Sharpness]
Adjusts the sharpness of the projected image.</p> | <p>4 [Color]
Adjusts the color saturation of the projected image.</p> <p>5 [Tint]
Adjusts the skin tone of the projected image.</p> <p>6 [Color temperature]
Adjusts the color temperature of the projected image.</p> |
|---|---|

[Image Setup] page

Network Display System > Image Setup		Logout
System Status	Aspect <input type="text" value="Normal"/>	1
General Setup	Fine sync (0 --- 31) <input type="text" value="30"/>	2
Picture Setup	H Position (-5 --- 5) <input type="text" value="0"/>	3
Image Setup	V Position (-5 --- 5) <input type="text" value="0"/>	4
Alert Setup	H.Size (-15 --- 15) <input type="text" value="0"/>	5
Mail Setup	Freeze <input type="radio"/> On <input checked="" type="radio"/> Off	6
Network Setup	<input type="button" value="Auto PC adj."/>	7
	V Keystone (-60 --- 60) <input type="text" value="0"/>	8
	H Keystone (-30 --- 30) <input type="text" value="0"/>	9
	Curved correction XGain (-40 --- 40) <input type="text" value="0"/>	
	Curved correction YGain (-40 --- 40) <input type="text" value="0"/>	
	Curved correction XOffset_x (0 --- 1279) <input type="text" value="640"/>	
	Curved correction XOffset_y (0 --- 799) <input type="text" value="400"/>	10
	Curved correction YOffset_x (0 --- 1279) <input type="text" value="640"/>	
	Curved correction YOffset_y (0 --- 799) <input type="text" value="400"/>	
	Comer correction TopLeft_x (0 --- 1279) <input type="text" value="0"/>	
	Comer correction TopLeft_y (0 --- 799) <input type="text" value="0"/>	
	Comer correction TopRight_x (0 --- 1279) <input type="text" value="1279"/>	
	Comer correction TopRight_y (0 --- 799) <input type="text" value="0"/>	11
	Comer correction BottomLeft_x (0 --- 1279) <input type="text" value="0"/>	
	Comer correction BottomLeft_y (0 --- 799) <input type="text" value="799"/>	
	Comer correction BottomRight_x (0 --- 1279) <input type="text" value="1279"/>	
	Comer correction BottomRight_y (0 --- 799) <input type="text" value="799"/>	

- | | |
|--|--|
| <p>1 [Aspect]
Switches the aspect of the projected image.</p> <p>2 [Fine sync]
Adjusts the fine sync of the projected image.</p> <p>3 [H Position]
Adjusts the horizontal position of the projected image.</p> <p>4 [V Position]
Adjusts the vertical position of the projected image.</p> <p>5 [H.Size]
Adjusts the total number of dots of the projected image.</p> <p>6 [Freeze]
Switches the freeze function between on and off.</p> | <p>7 [Auto PC adj.]
Executes the Auto PC adj. function.</p> <p>8 [V Keystone]
Corrects the keystone in vertical direction.</p> <p>9 [H Keystone]
Corrects the keystone in horizontal direction.</p> <p>10 [Curved correction]
Corrects the pincushion or barrel of the projected image.</p> <p>11 [Corner correction]
Corrects the four corners of the projected image.</p> |
|--|--|

[Alert Setup] page

Set the contents of the E-mail to inform the abnormality of the projector.

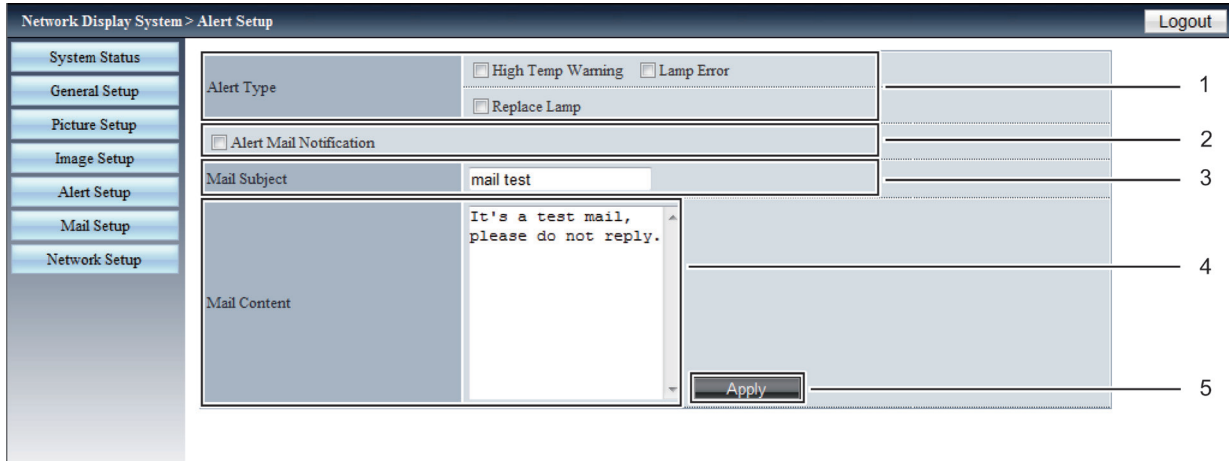

- | | |
|--|---|
| <p>1 [Alert Type]
Selects the alert type.</p> <p>2 [Alert Mail Notification]
Checks the alert E-mail when transmitting.</p> <p>3 [Mail Subject]
Enters the subject of the E-mail. (Up to 100 characters in single byte)</p> | <p>4 [Mail Content]
Enters the content of E-mail which is associated with the selected [Alert Type] and then clicks [Apply]. (Up to 255 characters in single byte)</p> <p>5 [Apply]
Clicks [Apply] to save the contents which are entered in [Mail Subject] and [Mail Content].</p> |
|--|---|

Note

- [Mail Subject] /[Mail Content] is not supported with the double-byte characters (e.g. Korean, Chinese and Japanese).

[Mail Setup] page

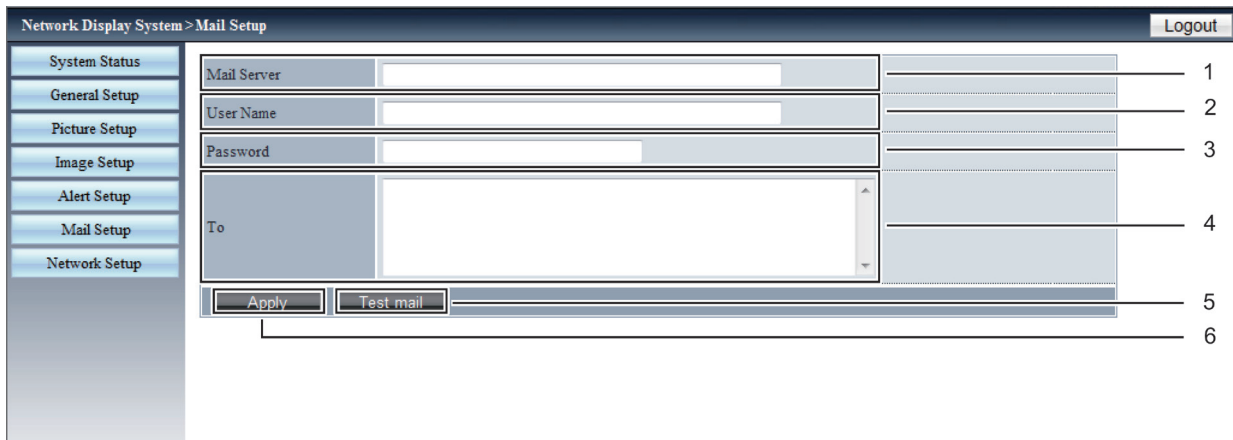

- | | |
|--|--|
| <p>1 [Mail Server]
Enters the IP address of SMTP server. (Up to 39 characters in single byte)</p> <p>2 [User Name]
Enters the user name. (Up to 19 characters in single byte)</p> <p>3 [Password]
Enters the password. (Up to 19 characters in single byte)</p> | <p>4 [To]
Enters the recipients of the E-mail. If you want to send E-mail to some recipients, please separate them by using semicolon (;). (Up to 299 characters in single byte)</p> <p>5 [Test Mail]
Clicks [Test Mail] to send the test E-mail.</p> <p>6 [Apply]
Clicks [Apply] to save the content after entering each item.</p> |
|--|--|

Note

- If the server is not compatible with the login authentication of the advanced SMTP, the e-mail function is disabled.
- If the server is not compatible with the advanced SMTP, [User Name] is required, but [Password] is not required.
- If the test E-mail is not sent, make sure that each item is set correctly.

[Network Setup] page

1 [LAN Setup]

Sets the items of the wired LAN.

[Obtain an IP address automatically] / [Use the following IP address]

Selects [Obtain an IP address automatically] if you want to enable the DHCP client.

[IP Address]

Enters the IP address when not using a DHCP server.

[Subnet]

Enters the subnet mask when not using a DHCP server.

[Gateway]

Enters the default gateway address when not using a DHCP server.

[DNS]

Enters the DNS server when not using a DHCP server.

Allowed characters: Numbers (0 - 9), period (.)
(Example: 192.168.0.253)

2 [Wireless Setup]

Sets the items of the wireless LAN.

[Wireless LAN]

Selects [Enable] when you want to enable the wireless LAN function.

[SSID]

The character string will be able to change when the projector is connected.

[Channel]

Selects the channel from [1] ~ [11] for use.

[Access Point Encryption]

Selects [Disable] when encryption is disabled.
Selects [WPA2PSK_AES] when encryption is enabled.

[Access Point key]

Enters the encryption key. (8 to 63 alphanumeric)
Checks [Show key] to make the characters visible.

3 [Apply]

Updates the settings.

Note

- Changing LAN settings while connected to the LAN may cause the connection to cut out.
- When [Factory default] is executed, the setting values of [Wireless Setup] will be returned to the factory default settings.
- The encryption of the wireless LAN is disabled before the projector leaves the factory. If you want to use the wireless LAN to communicate, it is recommended that the encryption of the [Wireless Setup] is set to [WPA2PSK-AES] for security.

Chapter 6 Maintenance

This chapter describes methods of inspection when there are problems, maintenance, and replacement of the units.

Power/Warning Indicators

If a problem should occur inside the projector, the power indicator <ON(G)/STANDBY(R)> and the warning indicator <WARNING> will inform you by lighting or blinking. Check the status of the indicators and remedy the indicated problems as follows.

Attention

- Before you take a remedial measure, follow the procedure of switching the power off indicated in “Powering Off the Projector” (➔ page 41).

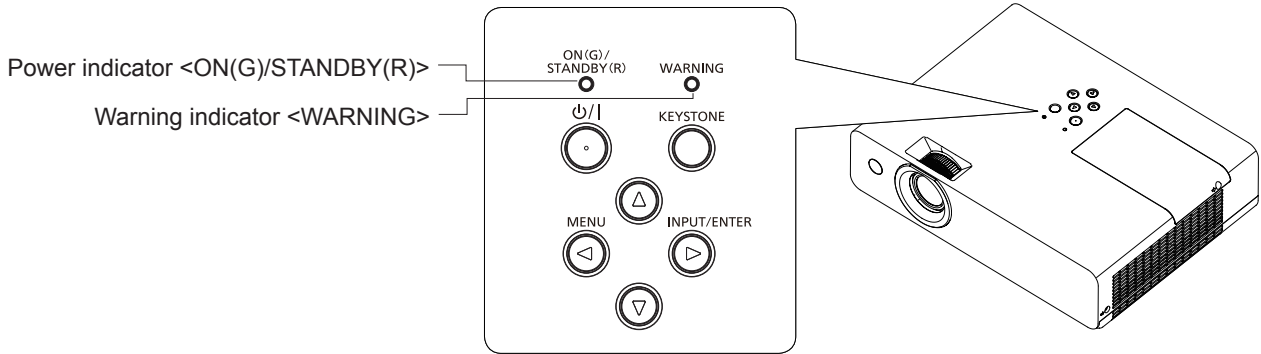

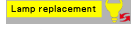
Power indicator <ON(G)/STANDBY(R)>	Warning indicator <WARNING>	Status	Cause	Solution	
Off	Off	The power plug is not connected to the outlet.	--	Connect the power plug to an outlet.	
Red	Blinking	Lighting in red	It has reached the replacement time of the lamp unit.	<ul style="list-style-type: none"> • The indicator lights up when the usage time of the lamp unit reaches 20 000 hours (when [Lamp control] is set to [💡 (Eco)]). 	<ul style="list-style-type: none"> • Replace the lamp unit.
	Blinking	Blinking in red	It has exceeded the replacement time of the lamp unit and the projector is turned off automatically.	<ul style="list-style-type: none"> • The indicator blinks when the usage time of the lamp unit reaches 22 000 hours (when [Lamp control] is set to [💡 (Eco)]). 	
Green	Lighting	Lighting in red	The replacement time of the lamp unit is displayed. (Projecting)	<ul style="list-style-type: none"> • Is the lamp replacement warning icon  displayed when turn on or turn off the projector? • The indicator lights up when the usage time of the lamp unit reaches 20 000 hours (when [Lamp control] is set to [💡 (Eco)]). 	<ul style="list-style-type: none"> • Replace the lamp unit.
	Lighting	Blinking in red	It has exceeded the replacement time of the lamp unit and the projector is turned off automatically.	<ul style="list-style-type: none"> • The indicator blinks when the usage time of the lamp unit reaches 22 000 hours (when [Lamp control] is set to [💡 (Eco)]). 	
	Blinking	Off	The power cord is plugged and the lamp is turned off. (Ready state)	<ul style="list-style-type: none"> • [Power management] is set to [Ready]. If a video signal is input in Ready mode, or when you press any button other than the power <⏻/> button, the luminous lamp turns on and the projector enters the projection state. Pressing the power <⏻/> button during the Ready state will enter the standby state. (➔ page 73) 	

Chapter 6 Maintenance - Power/Warning Indicators

Power indicator <ON(G)/STANDBY(R)>		Warning indicator <WARNING>	Status	Cause	Solution
Orange	Lighting	Off	The projector detects an abnormal condition and cannot be turned on. (Warning)	--	<ul style="list-style-type: none"> • If the projector is turned off, unplug the AC power cord and contact the dealer.
	Lighting	Lighting	There is a problem in the contrast shutter circuit for iris. (Warning)	--	<ul style="list-style-type: none"> • Turn off the projector, unplug the AC power cord and contact the dealer.
	Blinking	Blinking	The lamp or the power supply for the lamp detects an abnormal condition, the projector cannot be turned on. (Warning)	<ul style="list-style-type: none"> • Have you turned on the power again immediately after turning it off? • There is a problem in the lamp circuit. Have the source voltage been changed? (Drop) 	<ul style="list-style-type: none"> • Wait a while until the luminous lamp cools off, and then turn on the power. • Turn off the projector, and unplug the AC power cord, and consult your dealer.
	Blinking	Off	<p>Internal temperature is high. (Warning)</p> <p>When the internal temperature rises further and the air filter warning icon  is displayed on the screen, after a while the projector can be turned off automatically.</p>	<ul style="list-style-type: none"> • Is the air intake/exhaust port blocked? • Is the room temperature high? • Is the air filter unit clogged? 	<ul style="list-style-type: none"> • Remove any objects that are blocking the air intake/ exhaust port. • Install the projector in a location with an ambient temperature of 5 °C (41 °F) to 40 °C (104 °F). • Do not use the projector at high altitudes of 2 700 m (8 858') or higher above sea level. • Clean the air filter unit or replace it.

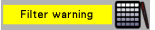
*1 Regardless of the time which is set in [Expand] → [Filter counter], the air filter warning icon  is displayed due to the internal temperature rising, and it will be displayed 10 seconds every five minutes if the temperature does not go down.

Note

- If the warning indicator <WARNING> persists to light or blink after taking these measurements such as turn off the projector, unplug the power cord, please contact your dealer for repair services.
- If the power indicator <ON(G)/STANDBY(R)> persists to light or blink in orange after taking these measurements such as turn off the projector, unplug the power cord, please contact your dealer for repair services.

Maintenance/replacement

Before performing maintenance/replacement

- When you perform maintenance or replacement of the parts, make sure to turn off the power and disconnect the power plug from the wall outlet. (➔ page 41)
- Be sure to observe the procedure “Powering Off the Projector” (➔ page 41) when performing power supply operation.

Maintenance

Outer Case

Wipe off dirt and dust using a soft dry cloth.

- If the dirt is persistent, soak the cloth with water and wring it thoroughly before wiping. Dry off the projector with a dry cloth.
- Do not use benzene, thinner, or rubbing alcohol, other solvents, household cleaners. Using them may cause deterioration of the outer case.
- When using chemical treated dusters, follow its instruction.

Front glass surface of the lens

Wipe off the dirt and dust off the front surface of the lens with soft clean cloth.

- Do not use a cloth that has an abrasive surface or a cloth that is moist, oily, or covered with dust.
- Do not use excessive force when wiping the lens as it is fragile.
- Do not use benzene, thinner or rubbing alcohol, other solvents or household cleaners. Using them may cause deterioration of the lens.

Attention

- The lens may be damaged if you hit with a hard object or wipe with excessive force. Please handle with care.

Air filter unit

Perform maintenance of the air filter in the following cases.

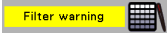
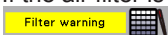
- If the time which is set in [Expand] menu → [Filter counter] is elapsed, the filter warning icon  will be displayed.
- If the air filter is clogged with dust, the power indicator <ON(G)/STANDBY(R)> blinks in orange, or the filter warning icon  will be displayed and after a while the projector is turned off automatically.

Attention

- Make sure to turn off the power before performing maintenance on the air filter unit.
- Make sure that the projector is stable, and perform the maintenance in a safe place where the unit will not be damaged even if you drop the air filter unit.

Removing the air filter unit

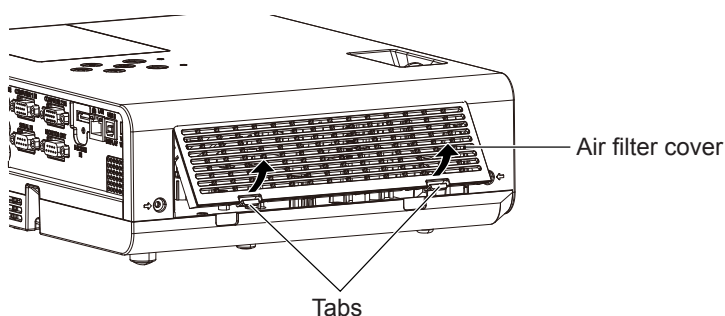

Fig.1

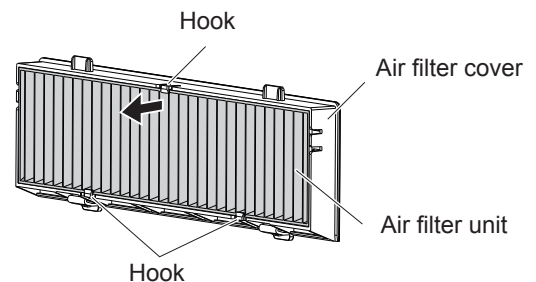

Fig.2

1) Remove the air filter cover. (Fig.1)

- Pull out the air filter cover from the hook of the projector while slightly pushing upward the tabs of the air filter cover and open it in the direction of the arrow in figure.

2) Remove the air filter unit.

- The air filter unit is fixed by the three hooks. Grasp the fibre of the air filter unit near to the cover side with one hook and then pull the air filter unit out from the air filter cover as arrow direction shown. (Fig.2)
- After removing the air filter unit, remove foreign objects and dust from the air filter compartment and the projector's air intake port if there are any.

Cleaning the air filter unit

Remove the air filter unit beforehand according to the previously described procedure in "Removing the air filter unit".

1) Clean the air filter unit.

- Vacuum dirt and dust from the air filter unit.
- Do not wash the air filter unit.

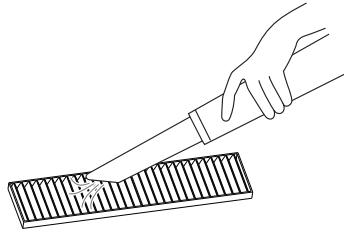

Attaching the air filter unit

1) Attach the new air filter unit to the air filter cover.

- There is a distinction between the inside and outside of the air filter unit. Align the red mark on the air filter unit with the red mark on the air filter cover.

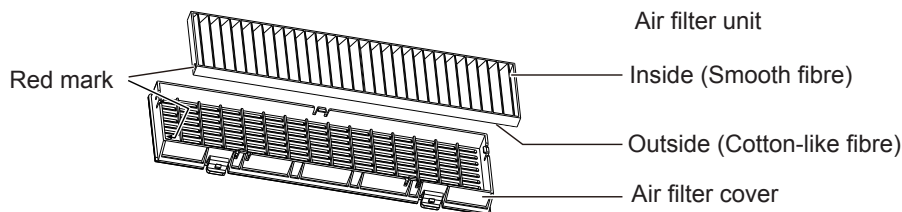

- Insert the air filter unit to the side with the two hooks and then press the other side of the air filter unit into the cover side with one hook.

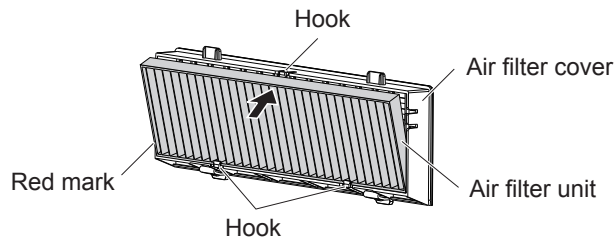

2) Attach the air filter cover to the projector.

- Perform Step 1) in "Removing the air filter unit" (➔ page 99) in the reverse order.
- Make sure that the air filter cover is closed tightly.

Resetting the filter counter

Be sure to reset the filter counter after cleaning the air filter unit.

- 1) **Connect the power plug, press the power < ⏻ / | > button.**
- 2) **Press the <MENU> button to display the main menu, then press ▲▼ to select [Expand].**
- 3) **Press the <INPUT/ENTER> button on the control panel or the <ENTER> button on the remote control, then press ▲▼ to select [Filter counter].**
- 4) **Press the <INPUT/ENTER> button on the control panel or the <ENTER> button on the remote control, then press ▲▼ to select [Filter counter reset].**
- 5) **Press the <INPUT/ENTER> button on the control panel or the <ENTER> button on the remote control.**
 - The [Filter counter reset ?] confirmation message is displayed.
- 6) **Press ▲▼ to select [Yes], then press the <INPUT/ENTER> button on the control panel or the <ENTER> button on the remote control.**
 - The [OK?] screen is displayed.
- 7) **Press ▲▼ to select [Yes], then press the <INPUT/ENTER> button on the control panel or the <ENTER> button on the remote control.**
 - The filter counter is reset and the filter usage time becomes 0 hour.

Attention

- Do not disassemble the air filter unit.
- When attaching the air filter unit, make sure that the projector is stable, and work in an environment that is safe, even in the event of the air filter unit dropping.
- Make sure that the air filter unit is properly attached before using the projector. If it is not attached, the projector will suck in dirt and dust causing a malfunction.

Note

- After cleaning the air filter, reset the filter counter. Otherwise, the actual filter usage time cannot be confirmed.
- Replace the air filter unit with the new optional Replacement Filter Unit (Model No.: ET-RFL300) if it is damaged or if the dirt does not come off even after cleaning.

Replacing the unit

Lamp unit

The lamp unit is a consumable component. Refer to “When to replace the lamp unit” for details about the replacement cycle. When purchasing the optional Replacement Lamp Unit (Model No.: ET-LAL510), consult your dealer.

Warning

Do not replace the lamp unit when it is hot. (Wait at least one hour after use.)
The inside of the cover can become very hot, take care to avoid burn injuries.

Notes on the replacement of the lamp unit

- A Phillips screwdriver is necessary when replacing the lamp unit.
- Since the luminous lamp is made of glass, it may burst if dropped or hit with a hard object. Handle with care.
- Do not disassemble or modify the lamp unit.
- When replacing the lamp unit, be sure to hold it by the handle because its surface is pointed and its shape is protruded.
- The lamp may rupture. Replace the lamp unit carefully so the glass fragments of the lamp do not scatter. While attaching the projector to the ceiling, do not work right under the lamp unit or do not conduct work while your face is near the lamp unit.
- The lamp contains mercury. When disposing of used lamp units, contact your local authorities or dealer for correct methods of disposal.

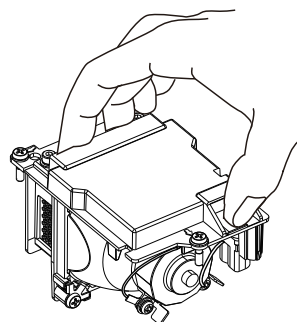

Attention

- Panasonic takes no responsibility for any damage or malfunction of the product resulting from use of lamp units which are not manufactured by Panasonic. Use only specified lamp units.

Note

- The model numbers of accessories and optional accessories are subject to change without prior notice.

When to replace the lamp unit

The lamp unit is a consumable component. Since its brightness gradually decreases over time, it is necessary to replace the lamp unit regularly.

Please refer to the displayed time in [Lamp counter] of [Info.] about the usage time of lamp (➔ page 80).

The estimated duration before replacement is 20 000 hours which is displayed in [Lamp counter], but the lamp may go off before the time above mentioned has elapsed depending on individual lamp characteristics, usage conditions, and the installation environment. It is recommended that the Replacement lamp unit be prepared earlier.

The time which is displayed in [Lamp counter] is a total time when the real usage time in [☀ (Normal)], [🌿 (Eco)] or [🌑 (Quiet)] is converted to the runtime in [🌿 (Eco)]. Please note that they are not displayed individually.

The displayed time in [Lamp counter] = “Lamp runtime of [☀ (Normal)]” × 2 + “Lamp runtime of [🌿 (Eco)]”
+ “Lamp runtime of [🌑 (Quiet)]” × 2







The real usage time when the displayed time in [Lamp counter] is 20 000 hours means,

When [Lamp control] is constantly set to [☀ (Normal)] without switching to other modes = 10 000 hours

When [Lamp control] is constantly set to [🌿 (Eco)] without switching to other modes = 20 000 hours

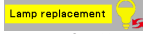
When [Lamp control] is constantly set to [🌑 (Quiet)] without switching to other modes = 10 000 hours

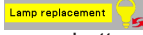
If you continue to use the lamp unit after the displayed time in [Lamp counter] 22 000 hours has elapsed, the lamp turns off automatically at approximately 10 minutes after turning on the power, as it will cause malfunction of the projector.

The displayed time in [Lamp counter]	On-screen display	<WARNING> indicator
Over 19 700 hours less than 20 000 hours	<ul style="list-style-type: none"> The lamp replacement icon  is displayed for 10 seconds. If you press any button within 10 seconds, the icon disappears. The lamp replacement icon  will display for 4 seconds on the screen after switching the input source or turning on the projector. 	--
Over 20 000 hours less than 22 000 hours	<ul style="list-style-type: none"> The lamp replacement warning icon  is displayed for 10 seconds. If you press any button within 10 seconds, the icon disappears. The lamp replacement warning icon  will display for 4 seconds on the screen after switching the input source or turning on the projector. 	Lighting in red. (The indicator will not light in the standby mode)
Over 22 000 hours	<ul style="list-style-type: none"> The lamp replacement warning icon  is displayed for 10 seconds. If you press any button within 10 seconds, the icon disappears. The lamp replacement warning icon  will display for 4 seconds on the screen after switching the input source or turning on the projector. The lamp automatically turns off at approximately 10 minutes after turning on the power. 	Blinking in red. (The indicator will not light in the standby mode)

Note

- The lamp replacement icon or lamp replacement warning icon will not be displayed when during "Freeze" or "AV mute".
- The usage period of 20 000 hours which is displayed in [Lamp counter] is a rough estimate and is not guaranteed.

Replacing the Lamp unit

Attention

- When the projector is mounted on a ceiling, do not work with your face close to the projector.
- Do not remove or loosen the screws other than specified ones when replacing the lamp unit.
- Make sure to attach the lamp unit and the lamp cover securely.

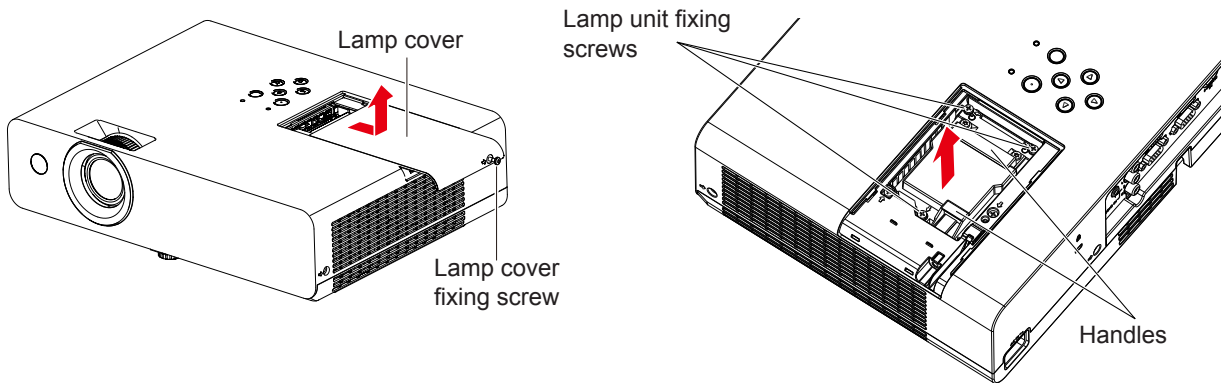

- 1) Turn off the power by following the procedure in "Powering Off the Projector" (⇒ page 41). Remove the AC power plug from the wall outlet.
 - Wait at least one hour and make sure the lamp unit and surroundings are cool.
- 2) Use a Phillips screwdriver to loosen the lamp cover fixing screw (×1) until it turns freely and remove the lamp cover.
 - Remove the lamp cover by pulling it slowly toward the direction of the arrow as the above figure shown.
- 3) Use a Phillips screwdriver to loosen the three lamp unit fixing screws (×3) until they turn freely.
- 4) Hold the used lamp unit by its handles, and pull it gently from the projector.
- 5) Insert the new lamp unit in correct direction. Tighten the three lamp unit fixing screws (×3) securely with a Phillips screwdriver.
 - When you experience difficulty in installing the lamp unit, remove it and try again. If you use force to install the lamp unit, the connector may be damaged.

6) **Attach the lamp cover. Tighten the lamp cover fixing screw (×1) securely with a Phillips screwdriver.**

- Perform step 2) in reverse direction to attach the lamp cover.

Resetting the lamp counter

Be sure to reset the lamp counter after replacing the lamp unit.

- 1) **Connect the power plug, press the power <⏻/▶> button.**
- 2) **While pressing the ▲ button on the control panel, press and hold the <INPUT/ENTER> button on the control panel for eight seconds or more.**
 - The lamp counter is reset and the usage time of the luminous lamp becomes 0 hour. (At this time, there is displaying nothing.)
- 3) **Press the <INFO.> button on the remote control.**
 - The [Info.] screen is displayed.
 - Make sure that the display of the [Lamp counter] is [0 H].
 - Please try step 2) again if the lamp counter has not been reset.

Note

- After replacing the lamp unit, reset the lamp counter. Otherwise, the actual lamp usage time cannot be confirmed.

Air filter unit

When the dust remains after cleaning, the filter replacement timing has come.

The Replacement Filter Unit (Model No.: ET-RFL300) is an optional accessory. To purchase the product, consult your dealer.

Replacing the air filter unit

Attention

- Make sure to turn off the power before replacing the air filter unit.
 - Make sure that the projector is stable, and perform the replacement in a safe place where the unit will not be damaged even if you drop the air filter unit.
- 1) **Remove the air filter cover.**
 - Refer to “Removing the air filter unit” (➡ page 99).
 - 2) **Remove the air filter unit.**
 - Refer to “Removing the air filter unit” (➡ page 99).
 - 3) **Attach the optional Replacement Filter Unit (Model No.: ET-RFL300) to the air filter cover.**
 - Refer to “Attaching the air filter unit” (➡ page 100).
 - 4) **Attach the air filter cover to the projector.**
 - Refer to “Attaching the air filter unit” (➡ page 100).
 - 5) **Reset the filter counter.**
 - Refer to “Resetting the filter counter” (➡ page 100).

Attention

- When using the projector, be sure to attach the air filter unit. If it is not attached, the projector will suck in dirt and dust causing a malfunction.
- The air filter unit to be replaced should be an unused product.

Note

- The time until the air filter is clogged varies greatly depending on the usage environment.
- When the projector is used without resetting the filter counter, the actual filter usage time will not be able to be confirmed.

Troubleshooting

Please check following points. For details, see the corresponding pages.

Problem	Cause	Reference page
Power does not turn on.	<ul style="list-style-type: none"> The power cord may not be connected. No electric supply is at the wall outlet. The circuit breakers have tripped. Is the power indicator <ON(G)/STANDBY(R)> or the warning indicator <WARNING > indicator lit or blinking? The lamp cover has not been securely installed. 	— — — 97 103
No picture appears.	<ul style="list-style-type: none"> The video signal input source may not be connected to a terminal properly. The input selection setting may not be correct. The [Brightness] adjustment setting may be at the minimum setting. The input source which is connected to the projector may have a problem. The AV mute function may be in use. 	34 42 58 — 47
The picture is fuzzy.	<ul style="list-style-type: none"> The lens focus may not have been set correctly. The projector may not be at the correct distance from the screen. The lens may be dirty. Is the relative position between the projector and the screen set properly? 	43 31 20 —
The color is pale or grayish.	<ul style="list-style-type: none"> [Color] or [Tint] adjustment may be incorrect. The input source which is connected to the projector may not be adjusted correctly. The RGB signal cable is damaged. 	59 — —
No sound from the internal speaker.	<ul style="list-style-type: none"> The external device may not be connected correctly to the audio input terminal. The volume may have been set to the minimum level. The AV mute function may have been turned on. The Mute function may have been enabled. When the VARIABLE AUDIO OUT is plugged-in, the projector's built-in speaker is not available. 	34 48, 63 47 48, 63 35
The remote control does not operate.	<ul style="list-style-type: none"> The batteries may be weak. The batteries may not have been inserted correctly. The remote control signal receptor on the projector may be obstructed. The remote control unit may be out of the operation range. Strong light such as fluorescent shine onto the signal receptor. Is the operation of the remote control set to disabled in [Key lock] of the [Setting] menu? When different codes are set on the projector and on the remote control. 	— 28 24 24 24 62 49
The control buttons of the projector do not operate.	<ul style="list-style-type: none"> Is the operation of the control panel set to disabled in [Key lock] of the [Setting] menu? 	62
The picture does not display correctly.	<ul style="list-style-type: none"> There may be a problem with the VCR or other signal source. A signal which is not compatible with the projector is being input. Is the setting of the computer output correct? 	— 110 —
Picture from a computer does not appear.	<ul style="list-style-type: none"> The cable may be longer than the optional cable. The external video output from a laptop computer may not be correct. 	— —
Picture from a HDMI device does not appear or picture is not stable.	<ul style="list-style-type: none"> Is the HDMI cable securely connected? Turn off the power of the projector and the connected devices. Then turn the power of the projector and the connected devices back on. Isn't unsupported signal cable connected? 	34 — 110
No sound is output from a HDMI device.	<ul style="list-style-type: none"> Set the sound channel of the attached device to Linear PCM. Connect the computer to the <HDMI IN> terminal through the HDMI-DVI conversion cable, set [Sound] of [HDMI Setup] to [Computer], and then input the analog audio signal to the <AUDIO IN 1> terminal. 	— 36, 64
The  mark appears on the screen.	<ul style="list-style-type: none"> To inform that the projector cannot execute the operation. Check the connections and the input signals, then operate correctly. 	—

Attention

- If the problem persists, after confirming the contents of the table, please consult your dealer.

Chapter 7 Appendix

This chapter describes specifications and after-sales service for the projector.

Technical Information

Using the PJLink protocol

(Only for PT-LW375, PT-LW335, PT-LB425, PT-LB385 and PT-LB355)

The network function of the projector supports PJLink class 1, and the PJLink protocol can be used to perform projector setting and projector status query operations from a computer.

Control commands

The following table lists the PJLink protocol commands that can be used to control the projector.

• x characters in tables are non-specific characters.

Command	Control details	Parameter / return string	Remark		
POWR	Power supply control	0 1	Standby Power on		
POWR ?	Power supply status query	0 1 2 3	Standby Power on Cool-down in progress Warm-up in progress		
INPT	Input selection	11 12 21 22	Computer 1 Computer 2 Video S-video		
INPT ?	Input selection query	23 31 41 51 52	Component HDMI Memory Viewer USB Display Network		
AVMT	AV mute/Mute control	10 11 20	Video mute off Video mute on Audio mute off		
AVMT ?	AV mute/Mute status query	21 30 31	Audio mute on AV mute off AV mute on		
ERST ?	Error status query	xxxxxx	1st byte	Fixed at 0	<ul style="list-style-type: none"> • 0 = No error known • 1 = Warning • 2 = Error
			2nd byte	Indicates lamp errors, range 0 – 2	
			3rd byte	Indicates temperature errors, range 0 – 2	
			4th byte	Fixed at 0	
			5th byte	Fixed at 0	
			6th byte	Fixed at 0	
LAMP ?	Lamp status query	xxxxx x	1st digits (1 – 5 digits) : Lamp cumulative operating time 2nd digit : 0 = Lamp off, 1 = Lamp on		
INST ?	Input selection list query	11 12 21 22 23 31 41 51 52			
NAME ?	Projector name query	PROJECTOR			
INF1 ?	Manufacturer name query	Panasonic	Returns manufacturer name.		
INF2 ?	Model name query	PT-LW375, PT-LW335, PT-LB425, PT-LB385, PT-LB355	Returns model name.		
INF0 ?	Other information query	xxxxxx	Returns information such as version number.		
CLSS ?	Class information query	1	Returns class for PJLink.		

PJLink security authentication

The password used for PJLink is the same as that of the password set for web control.

When using the projector without security authentication, do not set a password for web control function.

• For specifications related to PJLink, refer to the website of Japan Business Machine and Information System Industries Association.

URL <http://pjlink.jbmia.or.jp/english/>

<SERIAL IN> terminal

The <SERIAL IN> terminal of the projector conforms with RS-232C so that the projector can be connected to and controlled from a computer.

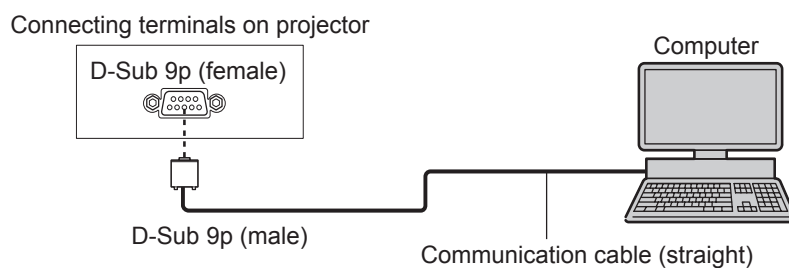
Connection**Pin assignments and signal names**

D-Sub 9-pin (female) Outside view	Pin No.	Signal name	Contents
	①	—	NC
	②	TXD	Transmitted data
	③	RXD	Received data
	④	—	NC
	⑤	GND	Earth
	⑥	—	NC
	⑦	CTS	Connected internally
	⑧	RTS	
	⑨	—	NC

Communication conditions

Signal level	RS-232C-compliant
Sync. method	Asynchronous
Baud rate	19 200 bps
Parity	None
Character length	8 bits
Stop bit	1 bit
X parameter	None
S parameter	None

Basic format

Transmission from the computer starts with STX, then the command, parameter, and ETX are sent in this order. Add parameters according to the details of control.

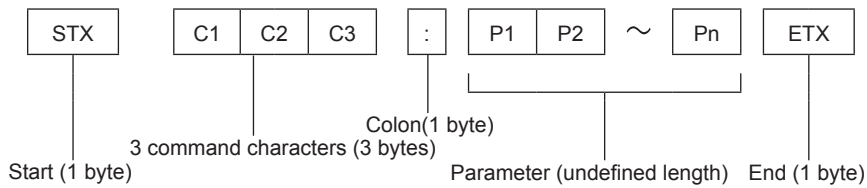

Basic format (with sub command)

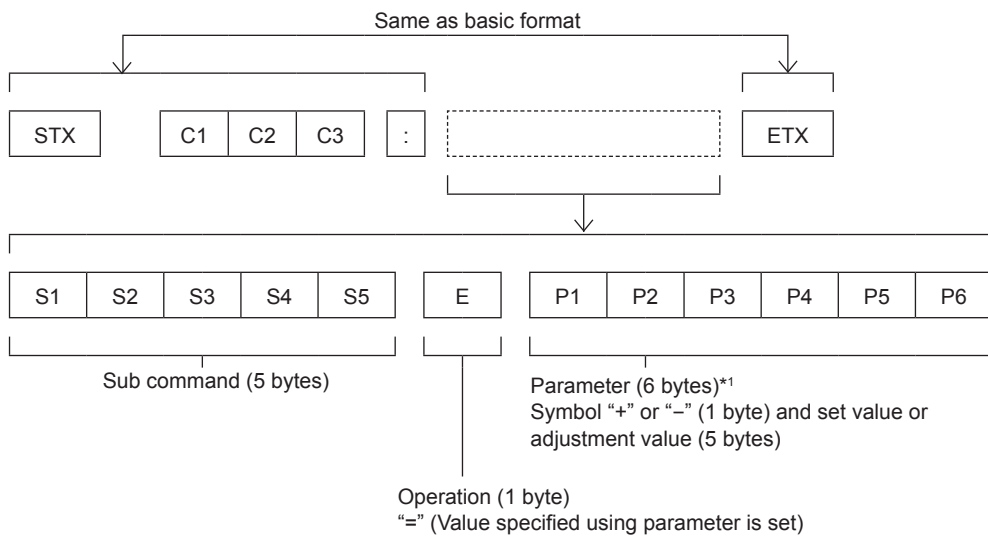

*1 When transmitting a command which does not need a parameter, the operation (E) and parameter are not necessary.

Attention

- If a command is transmitted after the lamp starts illuminating, there may be a delay in response or the command may not be executed. Try sending or receiving any command after 60 seconds.
- When transmitting multiple commands, be sure to wait until 0.5 seconds has elapsed after receiving the response from the projector before sending the next command. When transmitting a command which does not need a parameter, a colon (:) is not necessary.

Note

- If a command cannot be executed, the "ER401" response is sent from the projector to the computer.
- If an invalid parameter is sent, the "ER402" response is sent from the projector to the computer.
- STX and ETX are character codes. STX shown in hexadecimal is 02, and ETX shown in hexadecimal is 03.

Cable specifications

[When connected to a computer]

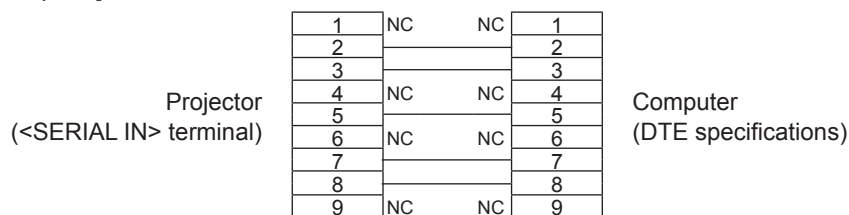

Control commands

When controlling the projector from a computer, the following commands are available.

■ Projector control command

Command	Control contents	Parameter/return string	Remark (parameter)
PON	Power on	—	To check if the power is on, use the “Power query” command.
POF	Power standby		
IIS	Switching the input signal	VID SVD RG1 RG2 HD1 CP1 MV1 UD1 NWP	Video S-video Computer 1 Computer 2 HDMI Component Memory Viewer USB Display Network
AUU	Volume up	—	—
AUD	Volume down		
OSH	AV mute function	—	Sending the command switches on/off. Do not switch on/off in a short period of time.
AMT	Mute function	0	Off
		1	On
QPW	Power query	000	Standby
		001	Power on
Q\$\$	Lamp condition query	0	Stand-by
		1	Lamp ON control active
		2	Lamp ON
		3	Lamp OFF control active

List of compatible signals

The following table specifies the type of signals compatible with the projectors.

- Symbols that indicate formats are as follows.

- V: VIDEO, Y/C
- R: RGB (analog)
- Y: YC_BC_R/YP_BP_R (analog)
- H: HDMI

Mode	Display resolution (dots)	Scanning frequency		Dot clock frequency (MHz)	Format*1	PnP *2	
		H (kHz)	V (Hz)			Computer 1/ Computer 2	HDMI
NTSC/NTSC4.43/ PAL-M/PAL60	720 x 480i	15.7	59.9	--	V	--	--
PAL/PAL-N/ SECAM	720 x 576i	15.6	50.0	--	V	--	--
480/60i	720 x 480i	15.7	59.9	13.5	R/Y	--	--
576/50i	720 x 576i	15.6	50.0	13.5	R/Y	--	--
480/60i	720 (1 440) x 480i*3	15.7	59.9	27.0	H	--	✓
576/50i	720 (1 440) x 576i*3	15.6	50.0	27.0	H	--	✓
480/60p	720 x 483	31.5	59.9	27.0	R/Y/H	--	✓
576/50p	720 x 576	31.3	50.0	27.0	R/Y/H	--	✓
720/60p	1 280 x 720	45.0	60.0	74.3	R/Y/H	--	✓
720/50p	1 280 x 720	37.5	50.0	74.3	R/Y/H	--	✓
1080/60i	1 920 x 1 080i	33.8	60.0	74.3	R/Y/H	--	✓
1080/50i	1 920 x 1 080i	28.1	50.0	74.3	R/Y/H	--	✓
1080/24p	1 920 x 1 080	27.0	24.0	74.3	R/Y/H	--	✓
1080/24sF	1 920 x 1 080i	27.0	48.0	74.3	R/Y/H	--	--
1080/25p	1 920 x 1 080	28.1	25.0	74.3	R/Y/H	--	--
1080/30p	1 920 x 1 080	33.8	30.0	74.3	R/Y/H	--	--
1080/60p	1 920 x 1 080	67.5	60.0	148.5	R/Y/H	--	✓
1080/50p	1 920 x 1 080	56.3	50.0	148.5	R/Y/H	--	✓
640 x 480/60	640 x 480	31.5	59.9	25.2	R/H	✓	✓
640 x 480/67	640 x 480	35.0	66.7	30.2	R/H	--	--
640 x 480/73	640 x 480	37.9	72.8	31.5	R/H	✓	✓
640 x 480/75	640 x 480	37.5	75.0	31.5	R/H	✓	✓
640 x 480/85	640 x 480	43.3	85.0	36.0	R/H	--	--
800 x 600/56	800 x 600	35.2	56.3	36.0	R/H	✓	✓
800 x 600/60	800 x 600	37.9	60.3	40.0	R/H	✓	✓
800 x 600/72	800 x 600	48.1	72.2	50.0	R/H	✓	✓
800 x 600/75	800 x 600	46.9	75.0	49.5	R/H	✓	✓
800 x 600/85	800 x 600	53.7	85.1	56.3	R/H	--	--
832 x 624/75	832 x 624	49.7	74.6	57.3	R/H	✓	✓
1024 x 768/60	1 024 x 768	48.4	60.0	65.0	R/H	✓	✓
1024 x 768/70	1 024 x 768	56.5	70.1	75.0	R/H	✓	✓
1024 x 768/75	1 024 x 768	60.0	75.0	78.8	R/H	✓	✓
1024 x 768/85	1 024 x 768	68.7	85.0	94.5	R/H	--	--
1152 x 864/75	1 152 x 864	67.5	75.0	108.0	R/H	--	--
1152 x 870/75	1 152 x 870	68.7	75.1	100.0	R/H	✓	✓
1280 x 720/50	1 280 x 720	37.1	49.8	60.5	R/H	--	--
1280 x 720/60	1 280 x 720	44.8	59.9	74.5	R/H	--	--
1280 x 768/60	1 280 x 768	47.8	59.9	79.5	R/H	--	--
1280 x 768/75	1 280 x 768	60.3	74.9	102.3	R/H	--	--
1280 x 768/85	1 280 x 768	68.6	84.8	117.5	R/H	--	--
1280 x 800/50	1 280 x 800	41.3	50.0	68.0	R/H	--	--

Chapter 7 Appendix - Technical Information

Mode	Display resolution (dots)	Scanning frequency		Dot clock frequency (MHz)	Format*1	PnP *2	
		H (kHz)	V (Hz)			Computer 1/ Computer 2	HDMI
1280 x 800/60	1 280 x 800	49.7	59.8	83.5	R/H	✓	✓
1280 x 800/75	1 280 x 800	62.8	74.9	106.5	R/H	--	--
1280 x 800/85	1 280 x 800	71.6	84.9	122.5	R/H	--	--
1280 x 960/60	1 280 x 960	60.0	60.0	108.0	R/H	✓	✓
1280 x 1024/60	1 280 x 1 024	64.0	60.0	108.0	R/H	✓	✓
1280 x 1024/75	1 280 x 1 024	80.0	75.0	135.0	R/H	✓	✓
1280 x 1024/85	1 280 x 1 024	91.1	85.0	157.5	R/H	--	--
1366 x 768/50	1 366 x 768	39.6	49.9	69.0	R/H	--	--
1366 x 768/60	1 366 x 768	47.7	59.8	85.5	R/H	--	--
1400 x 1050/60	1 400 x 1 050	65.3	60.0	121.8	R/H	--	--
1400 x 1050/75	1 400 x 1 050	82.3	74.9	156.0	R/H	--	--
1440 x 900/60	1 440 x 900	55.9	59.9	106.5	R/H	--	--
1600 x 900/60	1 600 x 900	55.9	60.0	119.0	R/H	--	--
	1 600 x 900*4	60.0	60.0	108.0	R/H	✓	✓
1600 x 1200/60	1 600 x 1 200	75.0	60.0	162.0	R/H	✓	✓
1680 x 1050/60	1 680 x 1 050	65.3	60.0	146.3	R/H	--	--
1920 x 1080/60	1 920 x 1 080*4	66.6	59.9	138.5	R/H	--	--
1920 x 1200/60	1 920 x 1 200*4	74.0	60.0	154.0	R/H	--	--

*1 <COMPUTER 2 IN> terminal is only for RGB signals input.

*2 Where marked "✓" signals indicates in Plug and Play is compatible with EDID of projector. Unmarked signals in Plug and Play may also be compliant if input terminals are written in the format list. Where Plug and Play is unmarked and nothing is written in the format list, difficulties in projecting image may occur even when computer and projector appear to have same resolution.

*3 Pixel-Repetition signal (dot clock frequency 27.0 MHz) only.

*4 VESA CVT-RB (Reduced Blanking)-compliant.

Note





- The number of display dots is 1 280 x 800 for the PT-LW375 and PT-LW335 and 1 024 x 768 for the PT-LB425, PT-LB385 , PT-LB355 and PT-LB305.

A signal with a different resolution will be projected after converting the resolution to match the projector display.

- "i" added to the resolution value indicates an interlaced signal.
- When interlaced signals are connected, flicker may occur on the projected image.
- The image may not be displayed in full screen according to the computer output setting.

Specifications

The specifications of the projector are as follows.

Power supply		100 V - 240 V \sim (100 V - 240 V alternating current), 50 Hz/60 Hz	
Power consumption		3.5 A - 1.5 A, 300 W In standby mode (when [Standby mode] is set to [Eco]): 0.5 W In standby mode (when [Standby mode] is set to [Normal]): 6 W	
LCD panel	Panel size	PT-LW375, PT-LW335	1.5 cm (0.59") (aspect ratio 16 : 10)
		PT-LB425, PT-LB385, PT-LB355, PT-LB305	1.6 cm (0.63") (aspect ratio 4 : 3)
	Display method	Translucent screen LCD panel 3 panels, 3 primary color system	
	Drive method	Active matrix method	
	Pixels	PT-LW375, PT-LW335	1 024 000 pixels (1 280 x 800 dots) x 3 panels
		PT-LB425, PT-LB385, PT-LB355, PT-LB305	786 432 pixels (1 024 x 768 dots) x 3 panels
Lens	Manual zoom	1.2 x	
	Manual focus	PT-LW375, PT-LB425, PT-LB385, PT-LB355	F = 1.6 ~ 1.76, f = 19.16 mm ~ 23.02 mm
		PT-LW335, PT-LB305	F = 2.1 ~ 2.25, f = 19.11 mm ~ 22.94 mm
Luminous lamp		230 W UHM lamp	
Light output *1	PT-LW375	3 600 lm	
	PT-LW335, PT-LB305	3 100 lm	
	PT-LB425	4 100 lm	
	PT-LB385	3 800 lm	
	PT-LB355	3 300 lm	
Contrast ratio *1		16 000 : 1 (When [Lamp control] is set to [ (Normal)], [Image mode] is set to [Dynamic] and [Iris] is set to [On].)	
Color system		7 (NTSC, NTSC4.43, PAL, PAL-N, PAL-M, SECAM, PAL60)	
Projection size		0.76 m - 7.62 m (30" - 300")	
Screen aspect ratio	PT-LW375, PT-LW335	16 : 10	
	PT-LB425, PT-LB385, PT-LB355, PT-LB305	4 : 3	
Projection scheme		[Front], [Rear], [Ceiling/Front], [Ceiling/Rear] (Menu setting system)	
Built-in speaker	PT-LW375, PT-LW335, PT-LB425, PT-LB385, PT-LB355	10 W (monaural) x 1	
	PT-LB305	2 W (monaural) x 1	
Power cable length		1.8 m (70-7/8")	
Cabinet		Molded plastic	
Dimensions		Width: 335 mm (13-3/16") Height: 96 mm (3-25/32") (when adjustable foot shortened) Depth: 252 mm (9-29/32")	
Weight	PT-LW375, PT-LW335, PT-LB425, PT-LB385, PT-LB355	Approx. 2.9 kg (6.39 lbs.) *2	
	PT-LB305	Approx. 2.8 kg (6.17 lbs.) *2	
Noise level *1		When set to [ (Normal)] in [Lamp control] : 39 dB When set to [ (Eco)] in [Lamp control] : 35 dB When set to [ (Quiet)] in [Lamp control] : 30 dB	
Operating environment	Operating environment temperature *3	5 °C (41 °F) to 40 °C (104 °F) (Elevation: below 1 400 m (4 593')) 5 °C (41 °F) to 35 °C (95 °F) (Elevation: 1 400 m (4 593') ~ 2 700 m (8 858'))	
	Operating environment humidity	20 % to 80 % (no condensation)	

Chapter 7 Appendix - Specifications

Remote control	Power supply	DC 3 V (AAA/R03/LR03 battery x 2)
	Operating range	Approx. 5 m (16'4-13/16") (when operated directly in front of receptor)
	Weight	63 g (2.22 ozs.) (including batteries)
	Dimensions	Width : 44 mm (1-23/32"), Length : 105 mm (4-1/8"), Height : 20.5 mm (13/16")

*1 Measurement, measuring conditions and method of notation all comply with ISO/IEC 21118:2012 international standards.

*2 This is an average value. It may differ depending on individual product.

*3 When the projector is operated at an elevation of 1 400 m (4 593') or less, if the ambient temperature exceeds 35 °C, [Lamp control] will be switched to [🌱 (Eco)] automatically to protect the projector; When the projector is operated at an elevation between 1 400 m (4 593') and 2 700 m (8 858'), if the ambient temperature exceeds 30 °C, [Lamp control] will be switched to [🌱 (Eco)] automatically to protect the projector.

Note

- The part numbers of accessories and separately sold components are subject to change without notice.

■ Connecting terminal

<COMPUTER 1 IN> terminal	1 (High-density D-sub 15 pin female) RGB signal 0.7 V [p-p] 75 Ω HD/SYNC TTL high impedance, automatic positive/negative polarity compatible VD TTL high impedance, automatic positive/negative polarity compatible (HD/SYNC and VD do not support 3 value SYNC.) Y_PP_R signal Y: 1.0 V [p-p] including synchronization signal, P _B P _R : 0.7 V [p-p] 75 Ω Y/C signal Y: 1.0 V [p-p] C: 0.286 V [p-p] 75 Ω S1 signal compatible	
<COMPUTER 2 IN>*1 terminal	1 (High-density D-sub 15 pin female) RGB signal 0.7 V [p-p] 75 Ω HD/SYNC TTL high impedance, automatic positive/negative polarity compatible VD TTL high impedance, automatic positive/negative polarity compatible (HD/SYNC and VD do not support 3 value SYNC.)	
<MONITOR OUT> terminal	1 (High-density D-sub 15 pin female) RGB signal 0.7 V [p-p] 75 Ω HD/SYNC TTL high impedance, positive/negative polarity compatible VD TTL high impedance, positive/negative polarity compatible	
<VIDEO IN> terminal	1 (Pin jack 1.0 V [p-p] 75 Ω)	
<HDMI IN> terminal	1 (HDMI 19 pin, HDCP and Deep color compatible) Audio signals: Linear PCM (Sampling frequency: 48 kHz/44.1 kHz/32 kHz)	
<AUDIO IN> terminal	1 (M3 stereo mini jack, 0.5 V [rms], input impedance 22 kΩ and more) 1 (Pin jack x 2 (L-R), 0.5 V [rms], input impedance 22 kΩ and more)	
<VARIABLE AUDIO OUT> terminal	1 (M3 stereo mini jack, stereo monitor output compatible, 0 V [rms] to 2.0 V [rms] variable, output impedance 2.2 kΩ and less)	
<USB A (VIEWER/WIRELESS)>*1 terminal	USB connector (type A x 1, output DC 5 V, 500 mA maximum) Memory Viewer / Wireless module (Model No.: ET-WML100) compatible	
<USB B (DISPLAY)> terminal	PT-LW375, PT-LW335, PT-LB425, PT-LB385, PT-LB355	USB connector (type B x 1), only for USB Display
<USB B > terminal	PT-LB305	USB connector (type B x 1)
<SERIAL IN> terminal	1 (D-sub 9 pin, RS-232C compliant, for computer control use)	
<LAN>*1 terminal	1 (for RJ-45 network connection, PLink compatible, 10Base-T/100Base-TX)	

*1 Only for PT-LW375, PT-LW335, PT-LB425, PT-LB385 and PT-LB355

■ **Wireless LAN**

(Only for PT-LW375, PT-LW335, PT-LB425, PT-LB385 and PT-LB355)

To use the wireless LAN function with the projector, it is necessary to attach the optional Wireless Module (Model No.: ET-WML100).

Compliance standards	IEEE802.11b/g/n	
Transmission method	DSSS, OFDM	
Frequency range (Channel)	2 412 MHz to 2 462 MHz (1 to 11 ch)	
Transmission speed (Standard value)	IEEE802.11b	Maximum 11 Mbps
	IEEE802.11g	Maximum 54 Mbps
	IEEE802.11n	Maximum 150 Mbps
Encryption method	WPA2-PSK(AES)	

■ **Compatible signals**

Refer to “List of compatible signals” (➡ page 110) for the types of video signals that can be used with the projector.

For Video signal	Horizontal : 15.73 kHz, Vertical : 59.94 Hz Horizontal : 15.63 kHz, Vertical : 50.00 Hz
For Y/C signal	Horizontal : 15.73 kHz, Vertical : 59.94 Hz Horizontal : 15.63 kHz, Vertical : 50.00 Hz
For RGB signal	Horizontal 15 kHz - 91 kHz, Vertical 24 Hz - 85 Hz Dot clock frequency: 162 MHz or less
For YC_BC_R/YP_BP_R signal	Displayable resolution: 480i/576i to 1 920 x 1 080 Dot clock frequency: 148.5 MHz or less
For HDMI signal	Displayable resolution for movie-based signals: 480i/576i ^{*1} to 1 920 x 1 080 Displayable resolution for still image signals: 640 x 480 to 1 920 x 1 200 (non-interlaced) Dot clock frequency: 25 MHz to 162 MHz

*1 Pixel-Repetition signal (dot clock frequency 27.0 MHz) only

Dimensions

Unit : mm (inch)

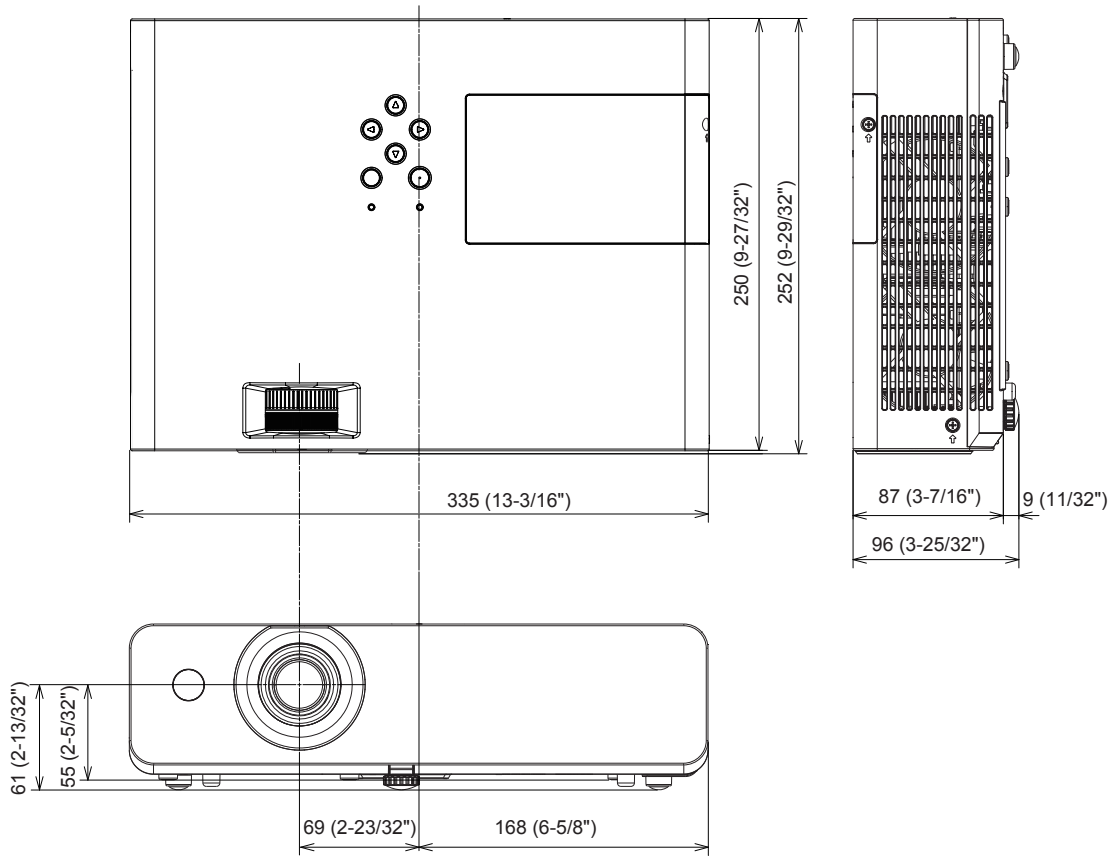

* Actual dimension may differ by product.

Ceiling mount bracket safeguards

- When installing the projector to a ceiling, be sure to use the specified optional Ceiling Mount Bracket for Projectors. **Model No.: ET-PKL100H (for high ceilings), ET-PKL100S (for low ceilings), ET-PKL420B (Projector Mount Bracket)**
- When installing the projector, attach the drop-prevention kit included with the Ceiling Mount Bracket for Projectors.
- Ask a qualified technician to do the installation work such as mounting the projector on the ceiling.
- Panasonic takes no responsibility for any damage to the projector resulting from use of a ceiling mount bracket not manufactured by Panasonic or the inappropriate choice of location for installation, even if the warranty period of the projector has not expired.
- Unused products must be removed promptly by a qualified technician.
- Use a torque screwdriver or Allen torque wrench to tighten bolts to their specified tightening torques. Do not use electric screwdrivers or impact screwdrivers.
- Read the Installation Instructions for the Ceiling Mount Bracket for Projectors for details.
- The model numbers of accessories and optional accessories are subject to change without prior notice.

■ Specification for the screw holes to fix the projector (projector bottom view)

Unit: mm (inch)

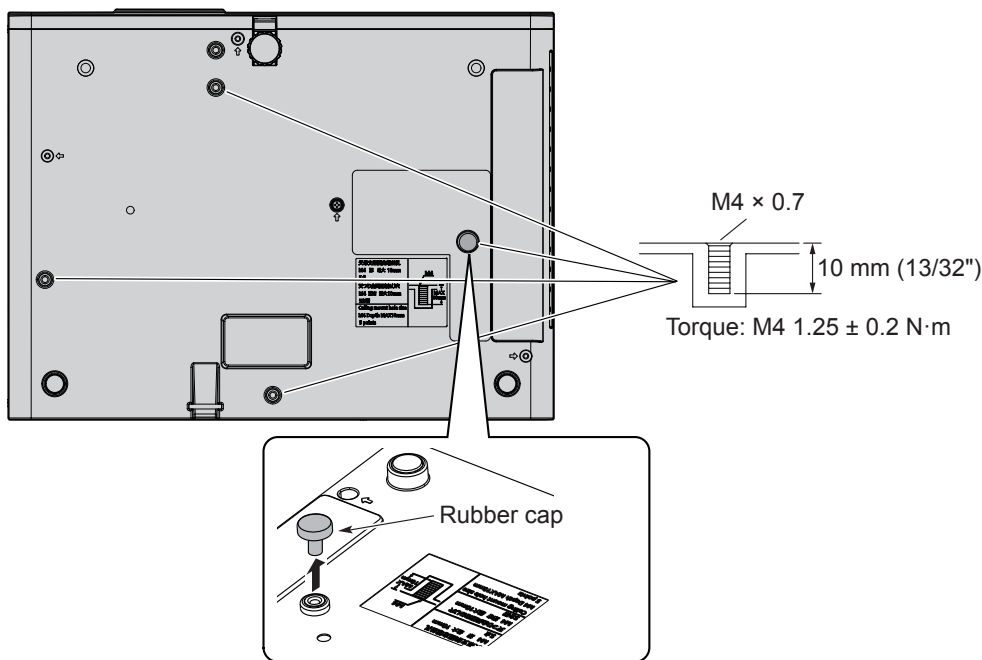

Attention

- The above figure shows the attaching of the rubber cap to the fixing screw hole of the ceiling mount bracket. Before installing the ceiling mount bracket, remove the rubber cap first and then attach the projector mount bracket.
- If the projector will be used for the desktop instead of for the ceiling, the rubber cap will be necessary to prevent burning. Save it for future use.
- When ceiling mounting is not needed, please do not touch or remove the rubber cap in order to prevent burning.

■ Dimensions for the screw holes to fix the projector (projector bottom view)

Unit: mm (inch)

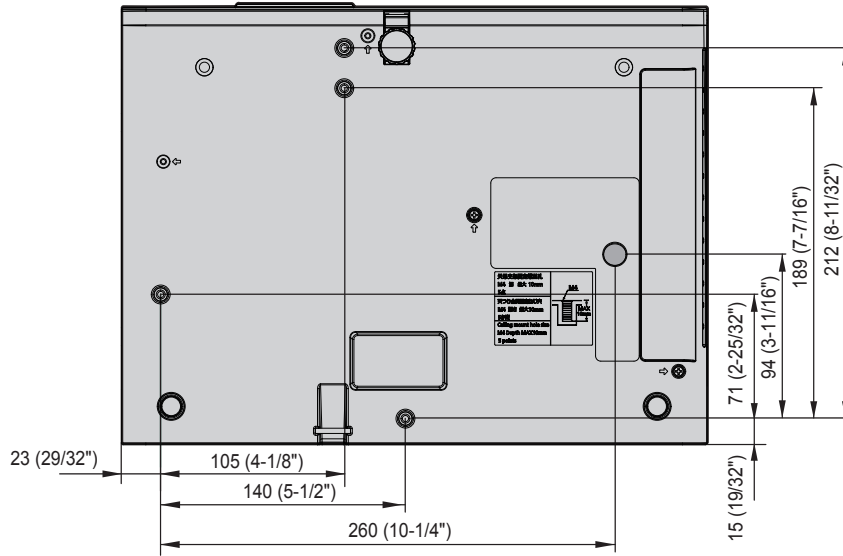

Index

- A**
- About Memory Viewer function.....82
 - About Presenter Light.....89
 - Accessories21
 - <AC IN> terminal25
 - Air filter unit.....99
 - [Apply].....79
 - [Aspect].....56
 - <ASPECT> button
 - Remote control.....23, 45
 - [Auto PC adj.]55
 - [Auto setup]65
 - <AUTO SETUP> button
 - Remote control.....23, 45
 - <AV MUTE> button
 - Remote control.....23, 47
- B**
- [Background display]57
 - Basic operations by using the remote control.....45
 - [Best fit].....78
 - [Brightness].....58
- C**
- Cautions when installing.....16
 - Cautions when transporting.....16
 - Ceiling mount bracket safeguards116
 - [Closed caption].....62
 - [Color].....59
 - [Color adjust] menu58
 - [Color temp.].....59
 - <COMPUTER 1> button
 - Remote control.....23
 - Connecting34
 - Connecting the power cord.....39
 - [Contrast].....58
 - Controlling the volume of the speaker.....48
 - [Cooling fast].....62
- D**
- [Daylight View].....60
 - <DAYLIGHT VIEW> button
 - Remote control.....23, 49
 - Dimensions.....115
 - [Display] menu.....55
 - Disposal.....19
 - <D.ZOOM +/-> buttons
 - Remote control.....23, 48
- E**
- <ENTER> button
 - Remote control.....23
 - [Expand] menu65
- F**
- [Factory default].....77
 - Features of the Projector14
 - [Filter counter].....74
 - [Fine sync]55
 - <FREEZE> button
 - Remote control.....23, 47
- H**
- [HDMI setup].....63
 - [High land]61
 - How to adjust the state of the image .43
 - [H Position]55
 - [H.Size].....56
- I**
- <IMAGE> button
 - Remote control.....23, 48
 - [Image mode].....58
 - [Info.].....80
 - <INFO.> button
 - Remote control.....23, 46
 - <INPUT/ENTER> button
 - Control panel.....25
 - Inserting and Removing batteries.....28
 - Installation mode30
 - [Iris].....63
- K**
- [Key lock].....62
 - [Keystone].....66
 - <KEYSTONE> button
 - Control panel.....25
 - Remote control.....23, 46
- L**
- <LAMP> button
 - Remote control.....23, 47
 - [Lamp control].....61
 - Lamp unit.....101
 - [Language].....65
 - List of compatible signals110
 - [Logo].....70
- M**
- Main menu.....52
 - Maintenance/replacement.....99
 - Making adjustments and selections...40
 - [Memory Viewer] menu.....78
 - <MENU> button
 - Control panel.....25
 - Remote control.....23, 51
 - [Menu position]57
 - <MUTE> button
 - Remote control.....23, 48
- N**
- Navigating through the menu51
 - [Network]75
 - Network connection86
- O**
- [On start].....61
 - Optional accessories22
- P**
- Power button
 - Control panel.....25
 - Remote control.....23
 - Power indicator25, 39, 97
 - Powering Off the Projector41
 - Powering On the Projector40
 - [Power management]73
 - Precautions for use.....16
 - Projecting.....42
 - Projector body24
 - [Project way]56
 - <P-TIMER> button
 - Remote control.....23, 47
- R**
- Read this first!.....4
 - [Red]/[Green]/[Blue].....59
 - [Remote control]76
 - Remote control23
 - [Repeat]79
 - Replacing the unit.....101
 - [Rotate].....78
- S**
- Screen size and throw distance.....31
 - [Security].....72
 - Selecting the input signal.....42
 - <SERIAL IN> terminal107
 - [Set slide].....78
 - [Setting] menu61
 - Setting the remote control ID
 - numbers.....49
 - Setting up30
 - [Sharpness]60
 - [Slide transition effect]78
 - [Sort order].....78
 - [Sound]63
 - Specifications112
 - [Standby mode]61
 - Sub menu53
 - [System].....57
- T**
- [Test pattern].....75
 - [Tint].....59
 - Troubleshooting104
- U**
- USB Display function.....84
 - Using the PJLink protocol.....106
- V**
- <VOLUME +/-> buttons
 - Remote control.....23, 48
 - [V Position]56
- W**
- Warning indicator.....25, 97

Disposal of Old Equipment and Batteries Only for European Union and countries with recycling systems



These symbols on the products, packaging, and/or accompanying documents mean that used electrical and electronic products and batteries must not be mixed with general household waste. For proper treatment, recovery and recycling of old products and used batteries, please take them to applicable collection points in accordance with your national legislation. By disposing of them correctly, you will help to save valuable resources and prevent any potential negative effects on human health and the environment.

For more information about collection and recycling, please contact your local authority. Penalties may be applicable for incorrect disposal of this waste, in accordance with national legislation.



Note for the battery symbol (bottom symbol)

This symbol might be used in combination with a chemical symbol. In this case it complies with the requirement set by the Directive for the chemical involved.

Information on Disposal in other Countries outside the European Union

These symbols are only valid in the European Union.

If you wish to discard these items, please contact your local authorities or dealer and ask for the correct method of disposal.

Product information (for Turkey only)

AEEE Yönetmeliğine Uygundur.

Eski Ekipman ve Bataryaların İşlenmesi.

Sadece geri dönüşüm sistemleri olan Avrupa Birliği ve ülkeleri için geçerlidir.



Ürünler, ambalaj ve/veya ekli belgeler üzerindeki bu semboller kullanılmış elektrik ve elektronik ürünlerin ve pillerin genel ev atığı ile karıştırılmaması gerektiğini ifade eder.

Eski ürünlerin ve pillerin toplanması ve geri kazanılması için bu atıkları lütfen yasayla belirlenmiş olan uygun toplama merkezlerine teslim ediniz.

Bu atıkların doğru işlenmesiyle, değerli kaynakların korunmasına ve insan sağlığı ve çevreye olası negatif etkilerinin engellenmesine yardımcı olabilirsiniz.

Atıkların toplanması ve geri dönüşümü için detaylı bilgi için lütfen bağlı olduğunuz yerel yönetimlerle iletişime geçiniz.

Atıkların atılmasıyla ilgili yanlış uygulamalar yasayla belirlenmiş olan cezalara sebebiyet verebilir.

Panasonic Corporation

Web Site : <https://panasonic.net/cns/projector/>

© Panasonic Corporation 2018

Panasonic System Solutions Company of North America

Two Riverfront Plaza, Newark, NJ 07102

TEL: (877) 803 - 8492

Panasonic Canada Inc.

5770 Ambler Drive, Mississauga, Ontario L4W 2T3

TEL: (905) 624 - 5010

W1118NL0 -PT